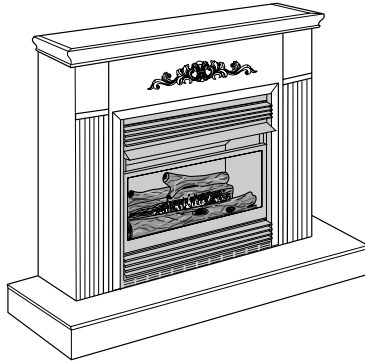


# DESA™

## HEATING PRODUCTS

### UNVENTED (VENT-FREE) GAS COMPACT CLASSIC HEARTH® FIREPLACE OWNER'S OPERATION AND INSTALLATION MANUAL



Shown with optional cabinet mantel/hearth base accessory.

REMOTE-READY MODELS:  
VMH26PRB, VMH26NRB, EFS26NRA, EFS26PRA

**WARNING:** If the information in this manual is not followed exactly, a fire or explosion may result causing property damage, personal injury, or loss of life.

- Do not store or use gasoline or other flammable vapors and liquids in the vicinity of this or any other appliance.
- **WHAT TO DO IF YOU SMELL GAS**
  - Do not try to light any appliance.
  - Do not touch any electrical switch; do not use any phone in your building.
  - Immediately call your gas supplier from a neighbor's phone. Follow the gas supplier's instructions.
  - If you cannot reach your gas supplier, call the fire department.
- Installation and service must be performed by a qualified installer, service agency, or the gas supplier.

**WARNING: Improper installation, adjustment, alteration, service, or maintenance can cause injury or property damage. Refer to this manual for correct installation and operational procedures. For assistance or additional information consult a qualified installer, service agency, or the gas supplier.**

**WARNING: This is an unvented gas-fired heater. It uses air (oxygen) from the room in which it is installed. Provisions for adequate combustion and ventilation air must be provided. Refer to Air for Combustion and Ventilation section on page 6 of this manual.**

**This appliance may be installed in an aftermarket,\* permanently located, manufactured (mobile) home, where not prohibited by local codes.**

**This appliance is only for use with the type of gas indicated on the rating plate. This appliance is not convertible for use with other gases.**

\* Aftermarket: Completion of sale, not for purpose of resale, from the manufacturer

## TABLE OF CONTENTS

Safety Information .....	3	Cleaning and Maintenance .....	26
Product Identification .....	4	Wiring Diagram .....	27
Optional Remote Control Accessories .....	5	Troubleshooting .....	28
Local Codes .....	5	Specifications .....	32
Product Features .....	5	Replacement Parts .....	33
Unpacking .....	5	Service Hints .....	33
Assembly .....	5	Technical Service .....	33
Air For Combustion and Ventilation .....	6	Illustrated Parts Breakdown and Parts List .....	34
Installation .....	9	Accessories .....	36
Operating Fireplace .....	22	Warranty Information .....	Back Cover
Inspecting Burners .....	25		

## SAFETY INFORMATION

**⚠ WARNING:** This product contains and/or generates chemicals known to the State of California to cause cancer or birth defects, or other reproductive harm.

**IMPORTANT:** Read this owner's manual carefully and completely before trying to assemble, operate, or service this fireplace. Improper use of this fireplace can cause serious injury or death from burns, fire, explosion, electrical shock, and carbon monoxide poisoning.

**⚠ DANGER:** Carbon monoxide poisoning may lead to death!

**Carbon Monoxide Poisoning:** Early signs of carbon monoxide poisoning resemble the flu, with headaches, dizziness, or nausea. If you have these signs, the fireplace may not be working properly. **Get fresh air at once!** Have fireplace serviced. Some people are more affected by carbon monoxide than others. These include pregnant women, people with heart or lung disease or anemia, those under the influence of alcohol, and those at high altitudes.

**Natural and Propane/LP Gas:** Natural and propane/LP gases are odorless. An odor-making agent is added to the gas. The odor helps you detect a gas leak. However, the odor added to the gas can fade. Gas may be present even though no odor exists.

Make certain you read and understand all warnings. Keep this manual for reference. It is your guide to safe and proper operation of this fireplace.

**⚠ WARNING:** Any change to this fireplace or its controls can be dangerous.

**⚠ WARNING:** Do not use a blower insert, heat exchanger insert, or other accessory not approved for use with this fireplace.

**⚠ WARNING:** Do not allow fans to blow directly into the fireplace. Avoid any drafts that alter burner flame patterns. Ceiling fans can create drafts that alter burner flame patterns. Altered burner patterns can cause sooting.

Due to high temperatures, the appliance should be located out of traffic and away from furniture and draperies.

Do not place clothing or other flammable material on or near the appliance. Never place any objects on the heater.

Fireplace front and screen become very hot when running heater. Keep children and adults away from hot surfaces to avoid burns or clothing ignition. Fireplace will remain hot for a time after shutdown. Allow surfaces to cool before touching.

Carefully supervise young children when they are in the room with fireplace. When using the hand-held remote accessory keep selector switch in the OFF position to prevent children from turning on burners with remote.

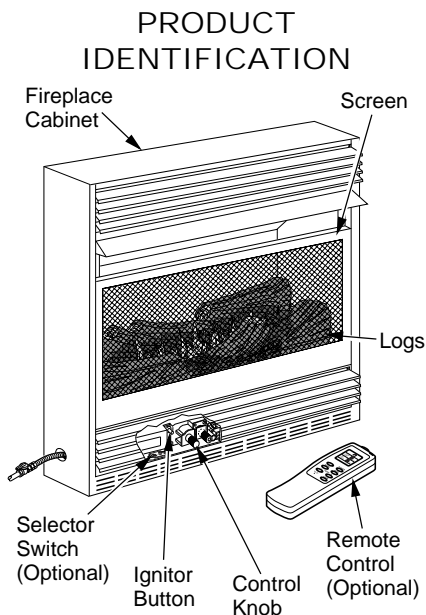
You must operate this fireplace with the fireplace screen in place. Make sure fireplace screen is closed before running fireplace.

Keep the appliance area clear and free from combustible materials, gasoline, and other flammable vapors and liquids.

# SAFETY INFORMATION

## Continued

1. This appliance is only for use with the type of gas indicated on the rating plate. This appliance is not convertible for use with other gases.
2. Do not place propane/LP supply tank(s) inside any structure. Locate propane/LP supply tank(s) outdoors.
3. If you smell gas
  - shut off gas supply
  - do not try to light any appliance
  - do not touch any electrical switch; do not use any phone in your building
  - immediately call your gas supplier from a neighbor's phone. Follow the gas supplier's instructions
  - if you cannot reach your gas supplier, call the fire department
4. This fireplace shall not be installed in a bathroom or bedroom.
5. Do not use this fireplace as a wood-burning fireplace. Use only the logs provided with the fireplace.
6. Do not add extra logs or ornaments such as pine cones, vermiculite, or rock wool. Using these added items can cause sooting. Do not add lava rock around base. Rock and debris could fall into the control area of fireplace.
7. This fireplace is designed to be smokeless. If logs ever appear to smoke, turn off fireplace and call a qualified service person. *Note:* During initial operation, slight smoking could occur due to log curing and fireplace burning manufacturing residues.
8. To prevent the creation of soot, follow the instructions in *Cleaning and Maintenance*, page 26.
9. Before using furniture polish, wax, carpet cleaner, or similar products, turn fireplace off. If heated, the vapors from these products may create a white powder residue within burner box or on adjacent walls or furniture.
10. This fireplace needs fresh air ventilation to run properly. This fireplace has an Oxygen Depletion Sensing (ODS) safety shutoff system. The ODS shuts down the fireplace if not enough fresh air is available. See *Air for Combustion and Ventilation*, pages 6 through 8. If fireplace keeps shutting off, see *Troubleshooting*, pages 28 through 31.
11. Do not run fireplace
  - where flammable liquids or vapors are used or stored.
  - under dusty conditions.
12. Do not use this fireplace to cook food or burn paper or other objects.
13. Never place any objects in the fireplace or on logs.
14. Do not use fireplace if any part has been under water. Immediately call a qualified service technician to inspect the room fireplace and to replace any part of the control system and any gas control which has been under water.
15. Turn off and unplug fireplace and let cool before servicing. Only a qualified service person should service and repair fireplace.
16. Operating fireplace above elevations of 4,500 feet could cause pilot outage.
17. Do not operate fireplace if any log is broken. Do not operate fireplace if a log is chipped (dime-sized or larger).
18. To prevent performance problems, do not use propane/LP fuel tank of less than 100 lbs. capacity.
19. Provide adequate clearances around air openings.



**Figure 1 - Vent-Free Compact Classic Hearth® Fireplace**

## OPTIONAL REMOTE CONTROL ACCESSORIES

There are four optional remote controls that can be purchased separately:

- wall switch
- hand-held ON/OFF remote
- wall thermostat
- hand-held thermostat remote

See *Accessories*, pages 36 and 37.

## LOCAL CODES

Install and use fireplace with care. Follow all local codes. In the absence of local codes, use the latest edition of *The National Fuel Gas Code ANSI Z223.1/NFPA 54\**.

\*Available from:

American National Standards Institute, Inc.  
1430 Broadway  
New York, NY 10018

National Fire Protection Association, Inc.  
Batterymarch Park  
Quincy, MA 02269

## PRODUCT FEATURES

### SAFETY PILOT

This fireplace has a pilot with an Oxygen Depletion Sensing (ODS) safety shutoff system. The ODS/pilot is a required feature for vent-free room fireplaces. The ODS/pilot shuts off the fireplace if there is not enough fresh air.

### PIEZO IGNITION SYSTEM

This fireplace has a piezo ignitor. This system requires no matches, batteries, or other sources to light fireplace.

## UNPACKING

1. Remove fireplace and hood from carton. Log is wrapped and inside fireplace. Do not remove at this time.
2. Remove all protective packaging applied to fireplace for shipment.
3. Make sure your fireplace includes one hardware packet.
4. Check fireplace for any shipping damage. If fireplace is damaged, promptly inform dealer where you bought fireplace.

## ASSEMBLY

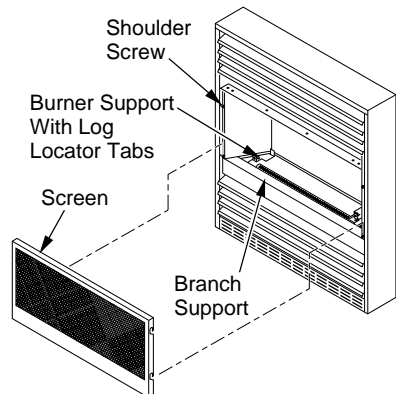
**⚠ WARNING: Always have branch support and screen in place before operating fireplace. This prevents excessive temperatures on fireplace surfaces.**

**⚠ WARNING: Failure to position the parts in accordance with these diagrams or failure to use only parts specifically approved with this fireplace may result in property damage or personal injury.**

### ASSEMBLING FIREPLACE

Tools Required:

- Phillips screwdriver
  - 5/16" hex wrench
  - slotted screwdriver
  - scissors
1. Remove two screws that hold fireplace screen in place for shipping. These screws are located near top of screen. Discard screws. Lift fireplace screen up and pull out to remove. Set screen aside until installation has been completed.
  2. Cut two plastic straps to remove the log from the firebox cavity.
  3. An optional blower is available. See *Accessories*, pages 36 and 37. Install optional blower now. Follow installation instructions provided with blower or (see page 14).



**Figure 2 - Removing Screen**

## ASSEMBLY

### Continued

4. Locate four black phillips sheet metal screws from the hardware packet.
5. Rotate hood as shown in Figure 3. Make sure hood tabs point toward fireplace.
6. Insert hood tabs between baffle and louvers (see Figure 3).
7. Gently rotate hood to upright position. Make sure hood tabs are behind louvers and hood is resting on firebox top (see Figure 3).
8. Align screw holes on hood with screw holes on firebox top.
9. Insert screws as shown in Figure 3. Tighten screws firmly.

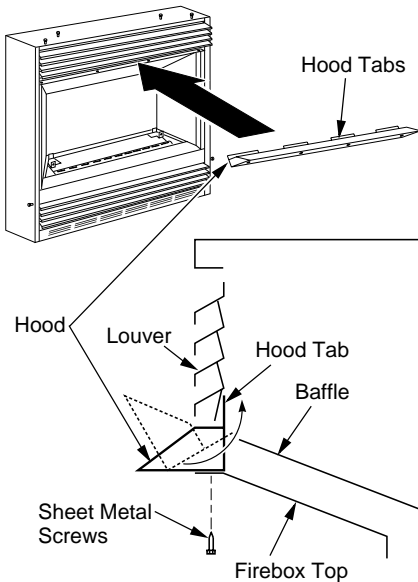


Figure 3 - Assembling Hood

## AIR FOR COMBUSTION AND VENTILATION

**⚠ WARNING:** This fireplace shall not be installed in a confined space or unusually tight construction unless provisions are provided for adequate combustion and ventilation air. Read the following instructions to insure proper fresh air for this and other fuel-burning appliances in your home.

Today's homes are built more energy efficient than ever. New materials, increased insulation, and new construction methods help reduce heat loss in homes. Home owners weather strip and caulk around windows and doors to keep the cold air out and the warm air in. During heating months, home owners want their homes as airtight as possible.

While it is good to make your home energy efficient, your home needs to breathe. Fresh air must enter your home. All fuel-burning appliances need fresh air for proper combustion and ventilation.

Exhaust fans, fireplaces, clothes dryers, and fuel burning appliances draw air from the house to operate. You must provide adequate fresh air for these appliances. This will insure proper venting of vented fuel-burning appliances.

### PROVIDING ADEQUATE VENTILATION

The following are excerpts from *National Fuel Gas Code, ANSI Z223.1/NFPA 54, Section 5.3, Air for Combustion and Ventilation*.

All spaces in homes fall into one of the three following ventilation classifications:

1. Unusually Tight Construction
2. Unconfined Space
3. Confined Space

The information on pages 6 through 8 will help you classify your space and provide adequate ventilation.

#### Unusually Tight Construction

The air that leaks around doors and windows may provide enough fresh air for combustion and ventilation. However, in buildings of unusually tight construction, you must provide additional fresh air.

# AIR FOR COMBUSTION AND VENTILATION

## Continued

Unusually tight construction is defined as construction where:

- walls and ceilings exposed to the outside atmosphere have a continuous water vapor retarder with a rating of one perm ( $6 \times 10^{-11}$  kg per pa-sec-m<sup>2</sup>) or less with openings gasketed or sealed *and*
- weather stripping has been added on openable windows and doors *and*
- caulking or sealants are applied to areas such as joints around window and door frames, between sole plates and floors, between wall-ceiling joints, between wall panels, at penetrations for plumbing, electrical, and gas lines, and at other openings.

If your home meets all of these three criteria, you must provide additional fresh air. See *Ventilation Air From Outdoors*, page 8. If your home does not meet all of the three criteria above, proceed to *Determining Fresh-Air Flow For Fireplace Location*, below.

### Confined and Unconfined Space

The *National Fuel Gas Code, ANSI Z223.1/NFPA 54* defines a confined space as a space whose volume is less than 50 cubic feet per 1,000 Btu per hour (4.8 m<sup>3</sup> per kw) of the aggregate input rating of all appliances installed in that space and an unconfined space as a space whose volume is not less than 50 cubic feet per 1,000 Btu per hour (4.8 m<sup>3</sup> per kw) of the aggregate input rating of all appliances installed in that space. Rooms communicating directly with the space in which the appliances are installed\*, through openings not furnished with doors, are considered a part of the unconfined space.

\* Adjoining rooms are communicating only if there are doorless passageways or ventilation grills between them.

# DETERMINING FRESH-AIR FLOW FOR FIREPLACE LOCATION

## Determining if You Have a Confined or Unconfined Space

Use this work sheet to determine if you have a confined or unconfined space.

**Space:** Includes the room in which you will install fireplace plus any adjoining rooms with doorless passageways or ventilation grills between the rooms.

- Determine the volume of the space (length x width x height).

Length x Width x Height = \_\_\_\_\_ cu. ft.  
(volume of space)

*Example:* Space size 16 ft. (length) x 14 ft. (width) x 8 ft. (ceiling height) = 1792 cu. ft. (volume of space)

If additional ventilation to adjoining room is supplied with grills or openings, add the volume of these rooms to the total volume of the space.

- Multiply the space volume by 20 to determine the maximum Btu/Hr the space can support.

\_\_\_\_\_ (volume of space) x 20 = (Maximum Btu/Hr the space can support)

*Example:* 1792 cu. ft. (volume of space) x 20 = 35,840 (maximum Btu/Hr the space can support)

- Add the Btu/Hr of all fuel burning appliances in the space.

Vent-free fireplace	_____	Btu/Hr
Gas water heater*	_____	Btu/Hr
Gas furnace	_____	Btu/Hr
Vented gas heater	_____	Btu/Hr
Gas fireplace logs	_____	Btu/Hr
Other gas appliances*	+ _____	Btu/Hr
Total	= _____	Btu/Hr

\* Do not include direct-vent gas appliances. Direct-vent draws combustion air from the outdoors and vents to the outdoors.

*Example:*

Gas water heater	30,000	Btu/Hr
Vent-free fireplace	10,000	Btu/Hr
Total	40,000	Btu/Hr

- Compare the maximum Btu/Hr the space can support with the actual amount of Btu/Hr used.

\_\_\_\_\_ Btu/Hr (maximum the space can support)  
\_\_\_\_\_ Btu/Hr (actual amount of Btu/Hr used)

*Example:* 35,840 Btu/Hr (maximum the space can support)

40,000 Btu/Hr (actual amount of Btu/Hr used)

# AIR FOR COMBUSTION AND VENTILATION

## Continued

The space in the above example is a confined space because the actual Btu/Hr used is more than the maximum Btu/Hr the space can support. You must provide additional fresh air. Your options are as follows:

- A. Rework worksheet, adding the space of an adjoining room. If the extra space provides an unconfined space, remove door to adjoining room or add ventilation grills between rooms. See *Ventilation Air From Inside Building*.
- B. Vent room directly to the outdoors. See *Ventilation Air From Outdoors*.
- C. Install a lower Btu/Hr fireplace, if lower Btu/Hr size makes room unconfined.

If the actual Btu/Hr used is less than the maximum Btu/Hr the space can support, the space is an unconfined space. You will need no additional fresh air ventilation.

**⚠ WARNING:** If the area in which the fireplace may be operated is smaller than that defined as an unconfined space or if the building is of unusually tight construction, provide adequate combustion and ventilation air by one of the methods described in the *National Fuel Gas Code, ANSI Z223.1/NFPA 54 Section 5.3* or applicable local codes.

## VENTILATION AIR

### Ventilation Air From Inside Building

This fresh air would come from an adjoining unconfined space. When ventilating to an adjoining unconfined space, you must provide two permanent openings: one within 12" of the ceiling and one within 12" of the floor on the wall connecting the two spaces (see options 1 and 2, Figure 4). You can also remove door into adjoining room (see option 3, Figure 4). Follow the *National Fuel Gas Code, ANSI Z223.1/NFPA 54, Section 5.3, Air for Combustion and Ventilation* for required size of ventilation grills or ducts.

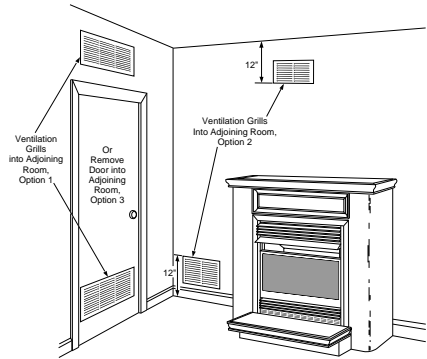


Figure 4 - Ventilation Air from Inside Building

### Ventilation Air From Outdoors

Provide extra fresh air by using ventilation grills or ducts. You must provide two permanent openings: one within 12" of the ceiling and one within 12" of the floor. Connect these items directly to the outdoors or spaces open to the outdoors. These spaces include attics and crawl spaces. Follow the *National Fuel Gas Code, ANSI Z223.1/NFPA 54, Section 5.3, Air for Combustion and Ventilation* for required size of ventilation grills or ducts.

**IMPORTANT:** Do not provide openings for inlet or outlet air into attic if attic has a thermostat-controlled power vent. Heated air entering the attic will activate the power vent.

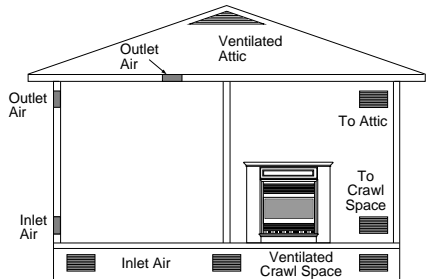


Figure 5 - Ventilation Air from Outdoors



## INSTALLATION

**NOTICE:** This heater is intended for use as supplemental heat. Use this heater along with your primary heating system. Do not install this heater as your primary heat source. If you have a central heating system, you may run system's circulating blower while using heater. This will help circulate the heat throughout the house. In the event of a power outage, you can use this heater as your primary heat source.

**⚠ WARNING:** A qualified service person must install fireplace. Follow all local codes.

**⚠ WARNING:** Never install the fireplace

- in a bathroom or bedroom
- in a recreational vehicle
- where curtains, furniture, clothing, or other flammable objects are less than 36 inches from the front, top, or sides of the fireplace
- as a fireplace insert
- in high traffic areas
- in windy or drafty areas

**⚠ CAUTION:** This fireplace creates warm air currents. These currents move heat to wall surfaces next to fireplace. Installing fireplace next to vinyl or cloth wall coverings or operating fireplace where impurities (such as, but not limited to, tobacco smoke, aromatic candles, cleaning fluids, oil or kerosene lamps, etc.) in the air exist, may discolor walls or cause odors.

**IMPORTANT:** Vent-free fireplaces add moisture to the air. Although this is beneficial, installing fireplace in rooms without enough ventilation air may cause mildew to form from too much moisture. See *Air for Combustion and Ventilation*, pages 6 through 8.

**Note:** Your fireplace is designed to be used in zero clearance installations. Wall or framing material can be placed directly against any exterior surface on the rear, sides, or top of your fireplace, except where standoff spacers are integrally attached. If standoff spacers are attached to your fireplace, these spacers can be placed directly against wall or framing materials.

**Note:** When installing fireplace directly on carpeting, tile or other combustible material, other than wood flooring, the fireplace shall be installed on a metal or wood panel extending the full width and depth of the fireplace.

Use the dimensions shown for rough openings to create the easiest installation (see *Built-In Fireplace Installation*, page 10).

### CHECK GAS TYPE

Use the correct gas type (natural or propane/LP) for your unit. If your gas supply is not correct, do not install fireplace. Call dealer where you bought fireplace for proper type fireplace.

**⚠ WARNING:** This appliance is equipped for (natural or propane/LP) gas. Field conversion is not permitted.

### INSTALLATION ITEMS

Before installing fireplace, make sure you have the items listed below.

- external regulator (supplied by installer, for propane/LP units only)
- piping (check local codes)
- sealant (resistant to propane/LP gas)
- equipment shutoff valve \*
- test gauge connection\*
- ground joint union
- sediment trap
- tee joint
- pipe wrench

\* A CSA design-certified equipment shutoff valve with 1/8" NPT tap is an acceptable alternative to test gauge connection. Purchase the optional CSA design-certified equipment shutoff valve from your dealer. See *Accessories*, pages 36 and 37.

**Note:** If desired, purchase a four-sided trim kit for built-in installations. See *Accessories*, pages 36 and 37.

# INSTALLATION

*Continued*

## FIREPLACE CLEARANCES

**⚠ WARNING: Maintain the minimum clearances shown in Figure 6. If you can, provide greater clearances from floor, ceiling, and joining wall.**

If your fireplace is to be used with an optional mantel, the installation instructions included with your mantel shows an CSA approved method of attaching the fireplace/mantel system to a wall. **IMPORTANT:** Only use optional cabinet or corner mantels specified in this manual. Purchase the optional mantel from your dealer (see *Accessories*, pages 36 and 37).

If your fireplace is to be recessed into the wall, see *Built-In Fireplace Installation* to secure your fireplace into the wall.

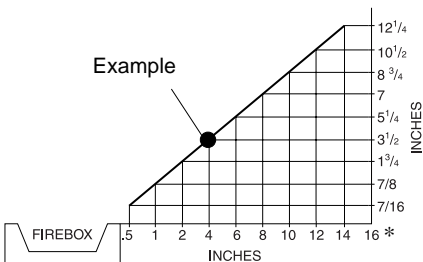
**⚠ CAUTION: If you install the fireplace in a home garage**

- fireplace pilot and burner must be at least 18 inches above floor.
- locate fireplace where moving vehicle will not hit it.

For convenience and efficiency, install fireplace

- where there is easy access for operation, inspection, and service
- in coldest part of room

An optional blower kit is available from your dealer. See *Accessories*, pages 36 and 37. If planning to use blower, follow instructions provided with blower for power source.



\*Minimum 16 inches from Side Wall

**Figure 6 - Minimum Clearance for Combustible to Wall**

## Minimum Clearances For Side Combustible Material, Side Wall, and Ceiling

A. Clearances from the side of the fireplace cabinet to any combustible material and wall should follow diagram in Figure 6.

**Example:** The face of a mantel, bookshelf, etc. is made of combustible material and protrudes 3 1/2" from the wall. This combustible material must be 4" from the side of the fireplace opening (see Figure 6).

B. Clearances from the top of the fireplace opening to the ceiling should not be less than 36 inches.

C. For mantel clearances, see Figure 10 on page 12.

MINIMUM CLEARANCE TO COMBUSTIBLE MATERIALS		
Top	Left and Right Sides	Bottom and Rear
36"	6"	0"

## BUILT-IN FIREPLACE INSTALLATION

Built-in installation of this fireplace involves installing fireplace into a framed-in enclosure. This makes the front of fireplace flush with wall. An optional trim kit accessory is available (see *Accessories*, pages 36 and 37). Trim will extend past sides of fireplace approximately 1/2 inch. This will cover the rough edges of the wall opening. If installing a built-in mantel above the fireplace, you must follow the clearances shown in Figure 10, page 12. Follow the instructions below to install the fireplace in this manner.

	Actual	Framing
Height	26"	26 7/8"
Front Width	26 3/4"	26 7/8"
Depth	9 1/2"	10 1/2"
Bottom	3/4"	3/4"

1. Frame in rough opening. Use dimensions shown in Figure 7, page 11 for the rough opening. If installing in a corner, use dimensions shown in Figure 8 for the rough opening. The height is 26 7/8" which is the same as the wall opening above.

# INSTALLATION

## Continued

2. If installing GA3450T blower accessory, do so at this time. Follow instructions included with blower accessory.

**Note:** If not installing blower accessory, you may wish to run electrical wiring to your fireplace for future blower installation (see *Accessories*, pages 36 and 37). Use only approved three-wire electrical wiring.

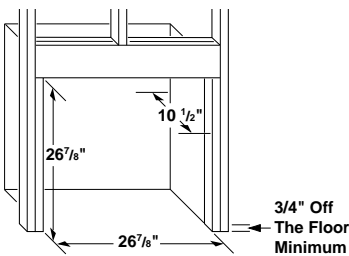
**Note:** A qualified installer should make all electrical connections.

**⚠ WARNING: If pre-wiring, do not connect wiring to any electrical source at this time.**

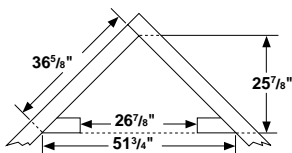
**Install fireplace electrical outlet and connect wiring to outlet before connecting to electrical source. The fireplace electrical outlet is included with the GA3450T blower accessory.**

**Only use the fireplace electrical outlet supplied with the GA3450T blower accessory.**

3. Install gas piping to fireplace location. This installation includes an approved flexible gas line (if allowed by local codes) after the equipment shutoff valve. The flexible gas line must be the last item installed on the gas piping.



**Figure 7 - Rough Opening for Installing in Wall**



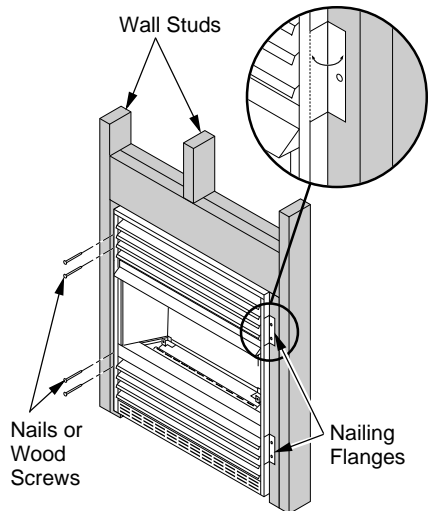
**Figure 8 - Rough Opening for Installing in Corner**

4. If you have not assembled firebox, follow instructions beginning on page 5.
5. Carefully set fireplace in front of rough opening with back of fireplace inside wall opening.
6. Attach flexible gas line to fireplace gas regulator. See *Connecting Fireplace to Gas Supply*, pages 17 and 18.
7. Bend four nailing flanges on outer casing with pliers (see Figure 9).
8. Attach fireplace to wall studs using nails or wood screws through holes in nailing flange.
9. Check all gas connections for leaks. See *Checking Gas Connections*, page 18.
10. If using optional trim kit, install the trim after final finishing and/or painting of wall. See instructions included with trim accessory for attaching trim.

**IMPORTANT:** When finishing your firebox, combustible materials such as wall board, gypsum board, sheet rock, drywall, plywood, etc. may be butted up next to the sides and top edge of the firebox. Combustible materials should never overlap the firebox front facing.

**⚠ WARNING: Do not allow any combustible materials to overlap the firebox front facing.**

**IMPORTANT:** Noncombustible materials such as brick, tile, etc. may overlap the front facing, but should never cover any necessary openings like louvered slots.



**Figure 9 - Attaching Fireplace to Wall Studs**

## INSTALLATION

### Continued

**WARNING:** Do not allow non-combustible materials to cover any necessary openings like louvered slots.

**WARNING:** Never modify or cover the louvered slots on the front of the firebox.

**WARNING:** Use only noncombustible mortar or adhesives when overlapping the front facing with noncombustible facing material.

### Mantel Clearances for Built-In Installation

If placing mantel above built-in fireplace, you must meet minimum clearance between mantel shelf and top of fireplace opening.

**NOTICE:** Surface temperatures of adjacent walls and mantels become hot during operation. Walls and mantels above the firebox may become hot to the touch. If installed properly, these temperatures meet the requirement of the national product standard. Follow all minimum clearances shown in this manual.

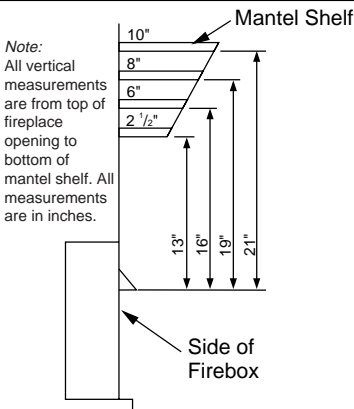


Figure 10 - Minimum Mantel Clearances for Built-In Installation

**NOTICE:** If your installation does not meet the minimum clearances shown, you must do one of the following:

- raise the mantel to an acceptable height
- remove the mantel

### OPTIONAL MANTEL INSTALLATION

Note: Refer to instructions provided with the mantel for assembly instructions. Refer to the following instructions for system installation. Refer to instructions on page 5 for fireplace assembly. Blower accessory should be installed if it is being used (see *Installing Optional Blower Accessory GA3450T*, pages 13 through 15).

1. Unscrew four screws that attach top louver to fireplace. Remove louver from fireplace and set aside (see Figure 11).
2. Place base assembly next to wall at installation location.
3. Place fireplace on wood base (see Figure 12, page 13).
4. Place mantel around fireplace on base (see Figure 12, page 13).
5. Assemble perimeter trim kit. See *Assembling Perimeter Trim*, page 13.
6. Firmly snap perimeter trim kit on shoulder screws. Shoulder screws are located on fireplace cabinet (see Figure 12, page 13).
7. Align perimeter trim kit for flush fit around opening.
8. Center mantel left to right on base making sure mantel is flush against wall.
9. Use two 3" wood screws provided and attach base of fireplace to wooden mantel base (see Figure 12, page 13).
10. Remove perimeter trim kit and mantel. Be careful not to damage wall or mantel.

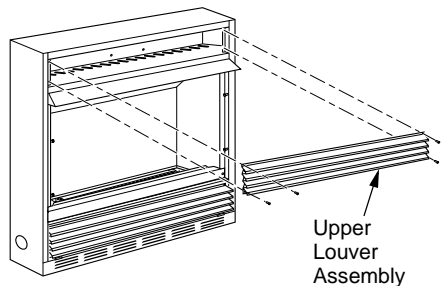
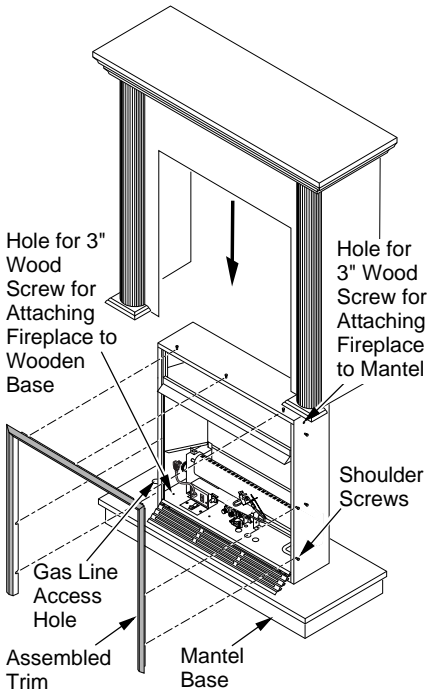


Figure 11 - Removing Top Louver

# INSTALLATION

## Continued

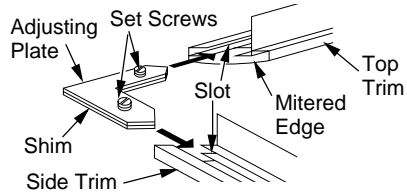
11. Cut an access hole in base to run flexible gas line to fireplace (see Figure 12). Make sure to locate access hole so mantel will cover it when installed. **Note:** You can secure base to floor using wood screws. Countersink screw heads and putty over.
12. Install gas line. See *Connecting To Gas Supply*, pages 16 and 17.
13. Check for leaks. See *Checking Gas Connections*, pages 17 and 18.
14. Place mantel around fireplace. Be careful not to damage wall or mantel.
15. Place perimeter trim kit on the shoulder screws located on the side and top of the fireplace. Firmly snap trim over shoulder screws on fireplace (see Figure 12).
16. Adjust assembly to remove any gaps. Attach remaining two 3" wood screws from hardware pack through openings inside of fireplace sides into the mantel. The openings are located at top behind the area for top louver (see Figure 12).
17. Reinstall top louver.



**Figure 12 - Attaching Perimeter Trim, Mantel and Base**

## Assembling Trim (Trim shipped with mantel)

1. Remove packaging from three remaining pieces of trim.
2. Locate two adjusting plates with set screws, and two shims in the hardware packet.
3. Align shim under adjusting plate as shown in Figure 13.
4. Slide one end of adjusting plate/shim in slot on mitered edge of top trim (see Figure 13).
5. Slide other end of adjusting plate/shim in slot on mitered edge of side trim (see Figure 13).
6. While firmly holding edges of trim together, tighten both set screws on the adjusting plate with slotted screwdriver.
7. Repeat steps 1 through 6 for other corner.
8. Set assembly aside for later installation.



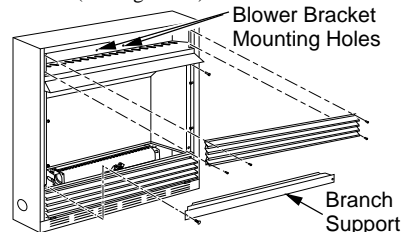
**Figure 13 - Assembling Trim**

## INSTALLING OPTIONAL BLOWER ACCESSORY GA3450T

### Removing Upper Louver Assembly and Branch Support

To install the blower accessory, you must first remove the upper louver assembly.

1. Lift screen off fireplace and remove log set if installed.
2. Remove 2 screws from each side of branch support and pull branch support out (see Figure 14).
3. Remove 4 screws from upper louver assembly (see Figure 14). Save these screws.
4. Pull upper louver assembly straight out from the cabinet. Be careful not to scratch the paint. Set louver assembly and screws aside.
5. Open lower louver door by swinging door down (see Figure 12).



**Figure 14 - Removing Top Louver and Branch Support**

# INSTALLATION

## Continued

### Installing Blower Accessory

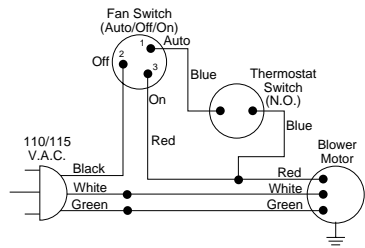
**CAUTION:** Label all wires prior to disconnection when servicing controls. Wiring errors can cause improper and dangerous operation.

**CAUTION:** Verify proper operation after servicing.

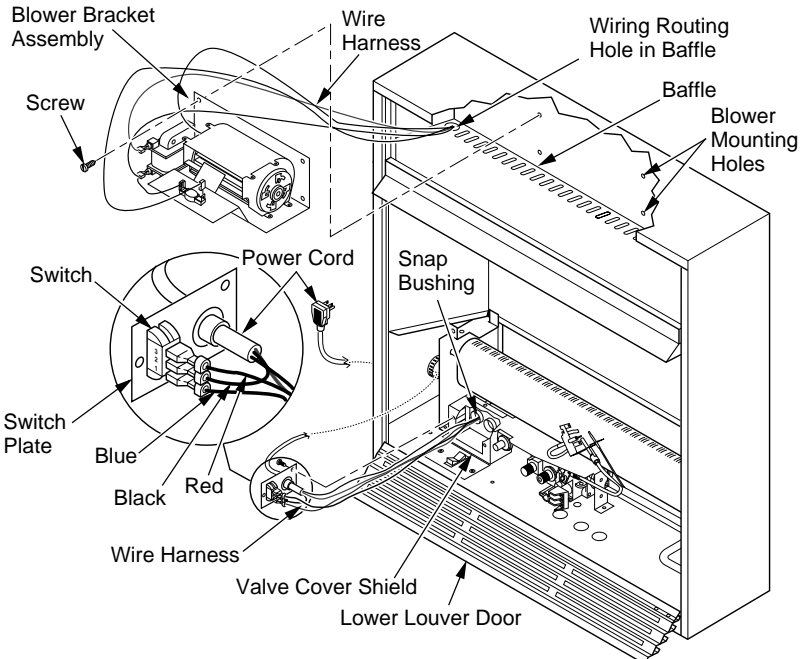
*Note:* If you are using a mantel with your fireplace, use the following instructions. If your fireplace is built-in, see *For Built-In Installation*, page 15.

1. Install snap bushings found in hardware kit into both holes in rear of valve cover shield.
2. Make sure the wire harness is firmly connected to the terminals on the blower bracket assembly.
3. Note the wire locations on back of AUTO/OFF/ON switch. The terminals on back of switch are numbered 1, 2, and 3. Carefully remove red wire from terminal 3 and blue wire from terminal 1. Black wire can remain on middle terminal 2 (see Figure 15).

4. Carefully disconnect green and white wires at their insulated connectors (see Figure 16).
5. In top of the fireplace cabinet, locate the four mounting holes on the outer casing. Align these four holes with those on the blower bracket assembly. Attach blower bracket assembly to the outer casing with 4 #10 screws provided (see Figure 15).
6. Route the wire harness through the hole in left side of baffle. Pull wire harness through lower opening on the side of the valve cover shield. (see Figure 15).
7. Insert the 4 wire harnesses into one of the round holes in the rear of the valve cover shield and through the rectangular hole in the front of shield (see Figure 15).



**Figure 16 - Wiring Diagram For Blower Accessory Standard Installation**

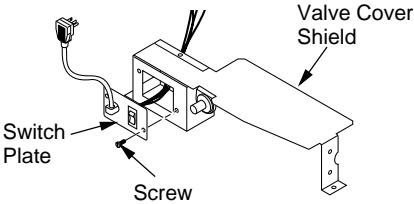


**Figure 15 - Installing Blower Bracket Assembly**

# INSTALLATION

## Continued

- Reconnect red wire to switch position 3. Reconnect blue wire to switch position 1. Reconnect green and white wires.
- Install the switch plate on the valve cover shield with 2 #10 screws provided (see Figure 17). Route power cord out of the cabinet by inserting it through the bushing on the outer casing (see Figure 15, page 14). Plug fan kit into 120-Volt grounded power supply and test operation.  
**Note:** When switch is in the AUTO position, the fan will start after the fireplace has run for a few moments. The fan will continue to run for several moments after the fireplace has been turned off. When switch is in the ON position, the fan will run until turned off. Reinstall upper louver assembly (see Figure 14, page 13) and branch support. Close lower louver door.



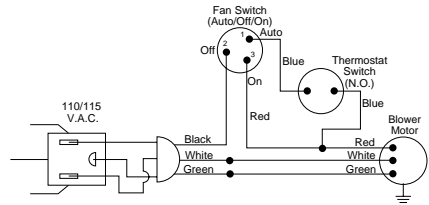
**Figure 17 - Installing Switch Plate to Valve Cover Shield**

### For Built-In Installation

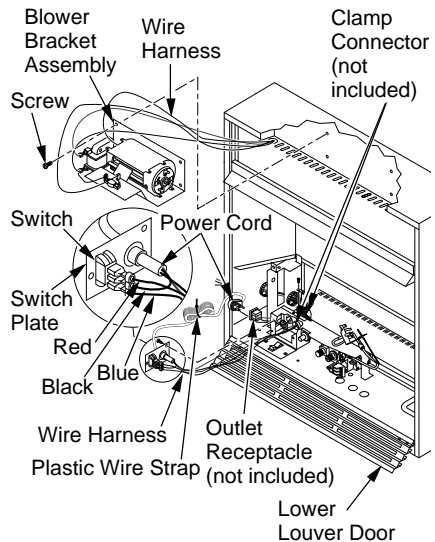
**WARNING:** A licensed electrician must connect the wiring harness to electrical supply following all local codes. Electrician must provide a clamp on the box cover to secure the wiring. Wiring should be routed through the bushing in the hole on the outer casing of fireplace.

- Install a snap bushing found in hardware kit into one of the holes on rear of valve cover shield. The other hole is for a strain relief clamp (not supplied) to secure incoming electrical supply.
- Follow steps 2 through 6 in *Installing Blower Accessory*, page 14.
- A licensed electrician must follow the wiring diagram to connect incoming electrical supply to fan kit wiring harness (see Figure 18).

- Plug power cord to the outlet receptacle (not provided) as shown in Figure 19. Wind the extra power cord and tie with plastic wire strap (see Figure 19). Set the power cord bundle between the burner bracket and outer casing, away from the burner.
- Test to make sure the blower is working properly.
- Reinstall upper louver assembly (see Figure 14, page 13) and close lower louver.



**Figure 18 - Wiring Diagram For Blower Accessory Built-In Installation**



**Figure 19 - Installing Blower Bracket Assembly**

### Extension Cord

Use extension cord if needed. The cord must have a three-prong, grounding plug and a three-hole receptacle. Make sure cord is in good shape. It must be heavy enough to carry the current needed. An undersized cord will cause a drop in line voltage. This will result in loss of power and overheating. Use a No. 16 AWG cord for lengths less than 50 feet.

## INSTALLATION

*Continued*

### CONNECTING TO GAS SUPPLY

**⚠ WARNING:** This appliance requires a 45° male flare fitting 5/8"-18 UNF (Unified National Fine Thread) inlet connection and the flexible gas line provided.

**⚠ WARNING:** A qualified service person must connect fireplace to gas supply. Follow all local codes.

**⚠ WARNING:** Never connect natural gas fireplace to private (non-utility) gas wells. This gas is commonly known as well-head gas.

**IMPORTANT:** For natural gas, check gas line pressure before connecting fireplace to gas line. Gas line pressure must be no greater than 14 inches of water. If gas line pressure is higher, heater regulator damage could occur.

**⚠ CAUTION:** Never connect propane/LP fireplace directly to the propane/LP supply. This fireplace requires an external regulator (not supplied). Install the external regulator between the fireplace and propane/LP supply.

For propane/LP units, the installer must supply an external regulator. The external regulator will reduce incoming gas pressure. You must reduce incoming gas pressure to between 11 and 14 inches of water. If you do not reduce incoming gas pressure, fireplace regulator damage could occur. Install external regulator with the vent pointing down as shown in Figure 20. Pointing the vent down protects it from freezing rain or sleet.

**⚠ CAUTION:** Use only new, black iron or steel pipe. Internally-tinned copper tubing may be used in certain areas. Check your local codes. Use pipe of 1/2" or greater diameter to allow proper gas volume to fireplace. If pipe is too small, undue loss of volume will occur.

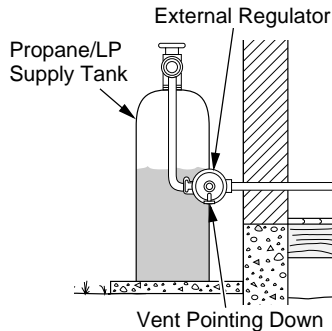
Installation must include an equipment shutoff valve, union, and plugged 1/8" NPT tap. Locate NPT tap within reach for test gauge hook up. NPT tap must be upstream from heater (see Figure 21, page 17).

**IMPORTANT:** Install equipment shutoff valve in an accessible location. The equipment shutoff valve is for turning on or shutting off the gas to the appliance.

Check your building codes for any special requirements for locating equipment shutoff valve to fireplaces.

Apply pipe joint sealant lightly to male NPT threads. This will prevent excess sealant from going into pipe. Excess sealant in pipe could result in clogged fireplace valves.

**⚠ WARNING:** Use pipe joint sealant that is resistant to liquid petroleum (LP) gas.



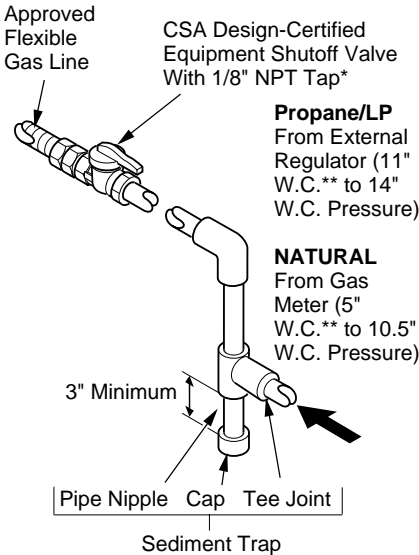
**Figure 20 - External Regulator With Vent Pointing Down**



## INSTALLATION

### *Continued*

We recommend that you install a sediment trap in supply line as shown in Figure 21. Locate sediment trap where it is within reach for cleaning. Install in piping system between fuel supply and heater. Locate sediment trap where trapped matter is not likely to freeze. A sediment trap traps moisture and contaminants. This keeps them from going into fireplace controls. If sediment trap is not installed or is installed wrong, fireplace may not run properly.



**Figure 21 - Gas Connection**

\* Purchase the optional CSA design-certified equipment shutoff valve from your dealer. See *Accessories*, pages 36 and 37.

## CONNECTING FIREPLACE TO GAS SUPPLY

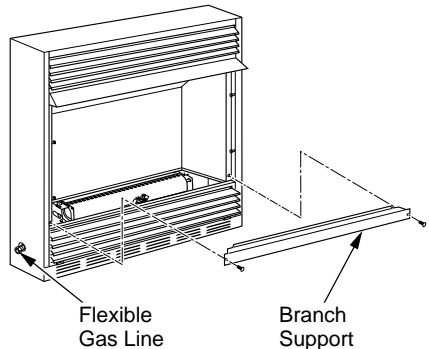
### Installation Items Needed

- Phillips screwdriver
  - sealant (resistant to propane/LP gas, not provided)
1. Remove screws that attach branch support to fireplace (see Figure 22). Carefully lift up branch support and remove from fireplace (see Figure 22).

**NOTICE: Most building codes do not permit concealed gas connections. A flexible gas line is provided to allow accessibility from the fireplace (see Figure 22). The flexible gas supply line connection to the equipment shutoff valve should be accessible.**

2. Route flexible gas line, included, from fireplace control to equipment shutoff valve through side or rear access holes in outer casing.
3. Apply pipe joint sealant lightly to male threads of gas connector attached to flexible gas line/equipment shutoff valve (see Figure 23, page 18).

**CAUTION: Avoid damage to gas control. Hold gas control with wrench when connecting it to gas piping and/or fittings.**

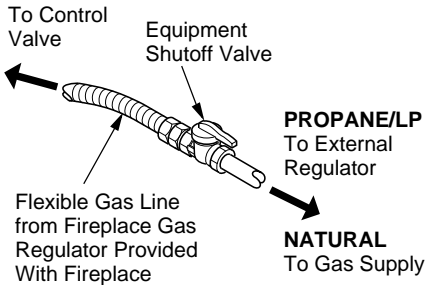


**Figure 22 - Removing Branch Support From Fireplace**

# INSTALLATION

## Continued

4. Check all gas connections for leaks. See *Checking Gas Connections*.
5. Replace branch support back into fireplace. Feed flexible gas line into fireplace base area while replacing branch support. Make sure the entire flexible gas line is in fireplace base area. Reattach branch support to fireplace with screws removed in step 1, page 17.



**Figure 23 - Attaching Flexible Gas Line to Equipment Shutoff Valve**

## CHECKING GAS CONNECTIONS

**WARNING:** Test all gas piping and connections, internal and external to unit, for leaks after installing or servicing. Correct all leaks at once.

**WARNING:** Never use an open flame to check for a leak. Apply a noncorrosive leak detection fluid to all joints. Bubbles forming show a leak. Correct all leaks at once.

**CAUTION:** Make sure external regulator has been installed between propane/LP supply and fireplace. See guidelines under *Connecting to Gas Supply*, pages 16 and 17.

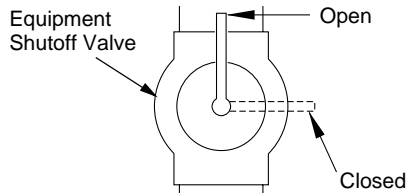
## Pressure Testing gas Supply Piping System

### Test Pressures In Excess Of 1/2 PSIG (3.5 kPa)

1. Disconnect appliance with its appliance main gas valve (control valve) and equipment shutoff valve from gas supply piping system. Pressures in excess of 1/2 psig will damage heater regulator.
2. Cap off open end of gas pipe where equipment shutoff valve was connected.
3. Pressurize supply piping system by either opening propane/LP supply tank valve for propane/LP gas or opening main gas valve located on or near gas meter for natural gas, or using compressed air.
4. Check all joints of gas supply piping system. Apply noncorrosive leak detection fluid to all joints. Bubbles forming show a leak.
5. Correct all leaks at once.
6. Reconnect fireplace and equipment shutoff valve to gas supply. Check reconnected fittings for leaks.

### Test Pressures Equal To or Less Than 1/2 PSIG (3.5 kPa)

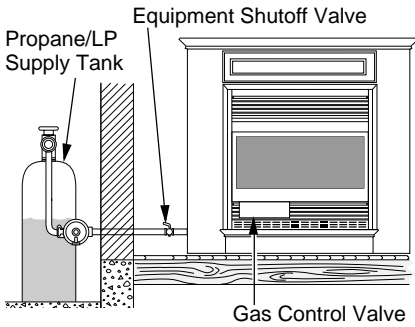
1. Close equipment shutoff valve (see Figure 24).
2. Pressurize supply piping system by either opening propane/LP supply tank valve for propane/LP gas or opening main gas valve located on or near gas meter for natural gas, or using compressed air.
3. Check all joints from gas meter to equipment shutoff valve for natural gas or propane/LP supply to equipment shutoff valve for propane/LP (see Figures 25 or 26, page 19). Apply noncorrosive leak detection fluid to all joints. Bubbles forming show a leak.
4. Correct all leaks at once.



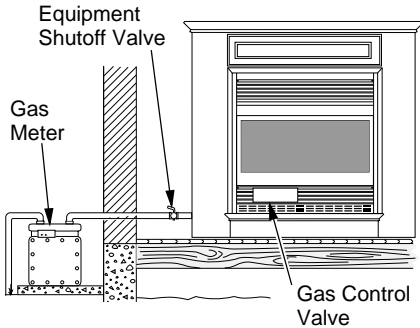
**Figure 24 - Equipment Shutoff Valve**

## INSTALLATION

### Continued



**Figure 25 - Checking Gas Joints  
(Propane/LP Only)**



**Figure 26 - Checking Gas Joints  
(Natural Gas Only)**

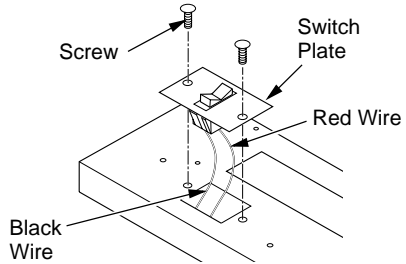
### Pressure Testing Fireplace Gas Connections

1. Open equipment shutoff valve (see Figure 24, page 18).
2. Open main gas valve located on or near gas meter for natural gas or open propane/LP supply tank valve.
3. Make sure control knob of fireplace is in the OFF position.
4. Check all joints from equipment shutoff valve to gas control valve (see Figures 25 or 26). Apply noncorrosive leak detection fluid to all joints. Bubbles forming show a leak.
5. Correct all leaks at once.
6. Light fireplace (see *Operating Fireplace*, pages 22 through 25). Check all other internal joints for leaks.
7. Turn off fireplace (see *To Turn Off Gas to Appliance*, page 23).

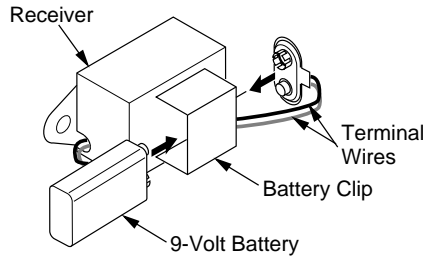
### OPTIONAL WIRELESS HAND-HELD REMOTE CONTROL ACCESSORIES (GHRCB Series & GHRCTB Series)

#### Installing Receiver

1. Remove screws.
2. Disconnect switch wires from the control valve.
3. Remove switch plate (see Figure 27). Discard switch plate after removing. Save the screws.
4. Locate the battery clip mounted on the back of the receiver (see Figure 28).
5. Slide 9-volt battery (not included) through the clip.
6. Attach the terminal wires to the battery (see Figure 28).
7. Connect wires as shown in Figure 30, page 20.
8. Install remote receiver unit onto fireplace base using the two screws removed in step one (see Figure 29, page 20).



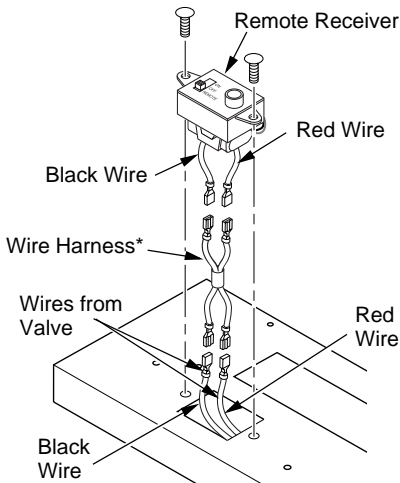
**Figure 27 - Switch Plate and Wiring Harness**



**Figure 28 - Attaching Battery to Receiver**

## INSTALLATION

*Continued*

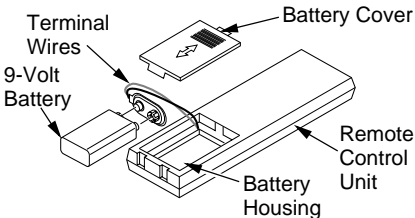


**Figure 29 - Installing Remote Receiver**

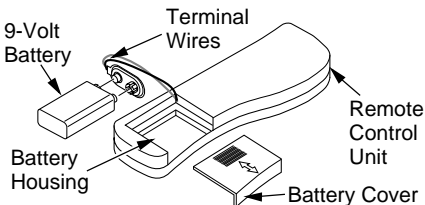
\* Wire harness provided in the fireplace hardware pack.

### Installing 9-Volt Battery in Hand-Held Remote Control Unit

1. Remove battery cover on back of remote control unit.
2. Attach terminal wires to the battery (not included). Place battery into the battery housing.
3. Replace battery cover onto remote control unit.



**Figure 30 - Installing Battery in Hand-Held Remote Control Unit (GHRCB Series)**



**Figure 321 - Installing Battery in Hand-Held Remote Control Unit (GHRCTB Series)**

## OPTIONAL WALL MOUNTED THERMOSTAT - GWMT1

**⚠ WARNING: Read and follow installation instructions. Installation should be done by a qualified installer familiar with low-voltage wiring procedures.**

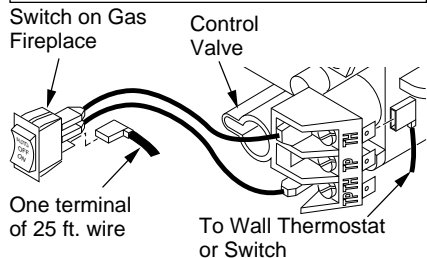
**⚠ WARNING: Do not connect this thermostat to any electrical source! Electrical shock and/or fire hazard will occur.**

1. Connect one terminal of 25 ft. wire to bottom contact of switch (see Figure 32).
2. Connect remaining wire terminal to the "TH" terminal on the control valve. Make sure that wire terminals are in the positions on your unit as pictured in Figure 32. If wires are not "crossed" the thermostat will not work.
3. Route the 25 ft. wire to a convenient location to mount your thermostat (no outside wall). **IMPORTANT:** The wire may be shortened but must not be lengthened.

The thermostat should be mounted 54" above the floor in a location where there is good air circulation. Avoid heat sources such as lamps, direct sunlight, fireplace, or heat and air conditioning ducts.

4. Gently remove the cover of the thermostat from the base. Grasp the sides of the cover firmly and pull to separate from the base.
5. Feed the electrical wires through the rectangular slots on each side of the base (see Figure 33, page 22).

**⚠ WARNING: Do not connect the thermostat to a power source. Electrical shock and/or a fire hazard will occur.**



**Figure 32 - Connecting Wire Terminals**

## INSTALLATION

### Continued

6. Connect one bare wire end to each terminal (“W” and “R”) of the thermostat base (see Figure 34).
7. Install the base onto the wall with the provided screws.
8. Move the temperature adjustment back and forth to insure the bimetal is free from restrictions.
9. Replace the cover onto the base. (Upon installation, the thermostat must be allowed to stabilize at room temperature for a minimum of 30 minutes for proper operation).
10. Set switch on fireplace to Auto position.
11. Set the temperature adjustment to the desired setting. This thermostat has been electronically calibrated at the factory. No adjustment or leveling is necessary.

Feed wires through rectangular slots

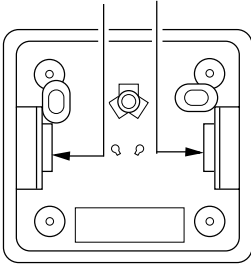


Figure 33 - Back View of Thermostat Base

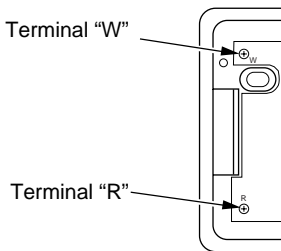


Figure 34 - Thermostat Base Terminals “W” and “R”

### OPTIONAL WALL SWITCH - GWMS2

**⚠ WARNING: Read and follow installation instructions. Installation should be done by a qualified installer familiar with low-voltage wiring procedures.**

**⚠ WARNING: Do not connect this switch to any electrical source! Electrical shock and/or fire hazard will occur.**

1. Connect one terminal of 25 ft. wire to bottom contact of switch (see Figure 32, page 20).
2. Connect remaining wire terminal to the “TH” terminal on the control valve. Make sure that wire terminals are in the positions on your unit as pictured in Figure 32, page 20. If wires are not “crossed” the thermostat will not work.
3. Route the 25 ft. wire to a convenient location to mount your wall switch (no outside walls).

**⚠ WARNING: Do not connect the switch to a power source. Electrical shock and/or fire hazard will occur.**

**IMPORTANT:** The wire may be shortened but must not be lengthened.

4. Connect one bare wire end to each of the terminals of the provided wall switch.
5. Install the wall switch and cover in the wall.

### INSTALLING LOG SET AND SCREEN

1. Remove log packaging material and discard packaging. Gently place log on burner support (see Figure 35). The log should fit flat against top of burner support and log locator tabs fit into the slots under the log. Do not allow log to contact flame. If flame contacts log, soot will be created.
2. Reattach screen by placing the notches in the screen frame over the shoulder screws and pushing down.

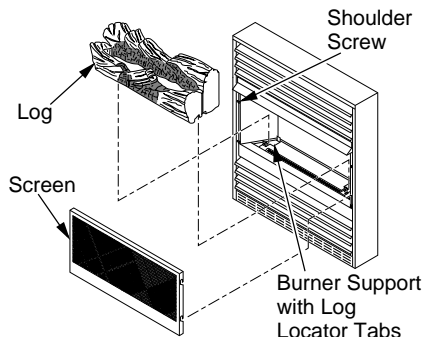


Figure 35 - Installing Log and Screen

## OPERATING FIREPLACE

### FOR YOUR SAFETY READ BEFORE LIGHTING

**WARNING:** If you do not follow these instructions exactly, a fire or explosion may result causing property damage, personal injury or loss of life.

- A. This appliance has a pilot which must be lighted by hand. When lighting the pilot, follow these instructions exactly.
- B. **BEFORE LIGHTING** smell all around the appliance area for gas. Be sure to smell next to the floor because some gas is heavier than air and will settle on the floor.

#### WHAT TO DO IF YOU SMELL GAS

- Do not try to light any appliance.
  - Do not touch any electric switch; do not use any phone in your building.
  - Immediately call your gas supplier from a neighbor's phone. Follow the gas supplier's instructions.
  - If you cannot reach your gas supplier, call the fire department.
- C. Use only your hand to push in or turn the gas control knob. Never use tools. If the knob will not push in or turn by hand, don't try to repair it, call a qualified service technician or gas supplier. Force or attempted repair may result in a fire or explosion.
  - D. Do not use this appliance if any part has been under water. Immediately call a qualified service technician to inspect the appliance and to replace any part of the control system and any gas control which has been under water.



### LIGHTING INSTRUCTIONS

**WARNING:** You must operate this fireplace with the fireplace screen in place. Make sure fireplace screen is installed before running fireplace.

**NOTICE:** During initial operation of new fireplace, burning logs will give off a paper-burning smell. Open window to vent smell. This will only last a few hours.

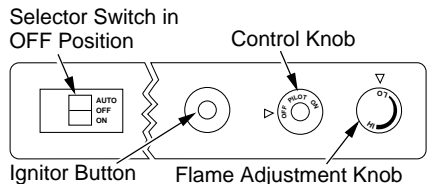
1. **STOP!** Read the safety information in column 1.
2. Make sure equipment shutoff valve is fully open.
3. Set switch in the OFF position.

**WARNING:** Burner will come on automatically within one minute when the selector switch is in the ON position after the pilot is lit.

4. Press in and turn control knob clockwise  to the OFF position (see Figure 37).
5. Wait five (5) minutes to clear out any gas. Then smell for gas, including near the floor. If you smell gas, **STOP!** Follow "B" in the safety information, column 1. If you don't smell gas, go to the next step.
6. Press in and turn control knob counter-clockwise  to the PILOT position. Press in control knob for five (5) seconds (see Figure 36).

**Note:** You may be running this fireplace for the first time after hooking up to gas supply. If so, the control knob may need to be pressed in for 30 seconds or less. This will allow air to bleed from the gas system.

7. With control knob pressed in, press and release ignitor button. This will light pilot. The pilot is attached to the front burner. If needed, keep pressing ignitor button until pilot lights.
- Note:** If pilot does not stay lit, contact a qualified service person or gas supplier for repairs. Until repairs are made, light pilot with match. To light pilot with match, see *Manual Lighting Procedure*, page 23.





**Figure 36 - Control Knob and Ignitor Button Location (Shown as Supplied - No Control Options)**


## OPERATING FIREPLACE

### Continued

- Keep control knob pressed in for 30 seconds after lighting pilot. After 30 seconds, release control knob.
  - If control knob does not pop out when released, contact a qualified service person or gas supplier for repairs.

**Note:** If pilot goes out, repeat steps 4 through 8.
- Slightly push in and turn control knob counterclockwise  to the ON position.
- Wait one minute and switch selector switch to the ON position to light burner.
- Set flame adjustment knob to any level between HI and LO.

 **CAUTION:** Do not try to adjust heating levels by using the equipment shutoff valve.

 **WARNING:** Make sure the selector switch is in the OFF position when you are away from home for long periods of time. Fireplace will come on automatically with selector switch in the ON position.

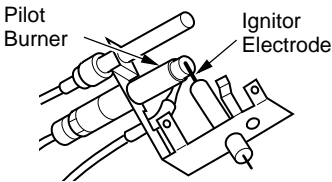


Figure 37 - Propane/LP Gas Pilot

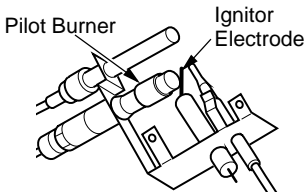




Figure 38 - Natural Gas Pilot

## TO TURN OFF GAS TO APPLIANCE

### Shutting Off Fireplace

- Turn control knob clockwise  to the OFF position.
- Set selector switch in the OFF position.
- If Using Optional Hand-Held Remote: Set selector switch in the OFF position to prevent draining battery.

**Shutting Off Burners Only (pilot stays lit)**  
You may shut off the burners and keep the pilot lit by doing one of the following:

- Turn control knob clockwise  to the PILOT position.
- Use remote control manual OFF button.
- Set selector switch in the OFF position.

## MANUAL LIGHTING PROCEDURE

- Follow steps 1 through 6 under *Lighting Instructions*, page 22.
- Depress control knob and light pilot with match.
- Keep control knob pressed in for 30 seconds after lighting pilot. After 30 seconds, release control knob. Now follow steps 9 through 11, *Lighting Instructions*, column 1.

## OPTIONAL HAND-HELD REMOTE OPERATION

**Note:** All remote control accessories must be purchased separately (see *Accessories*, pages 36 and 37). Follow instructions included with the remote control.

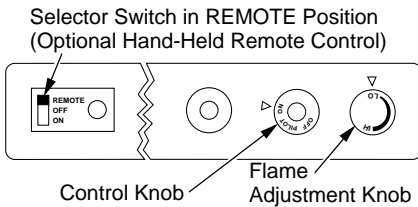
**NOTICE:** You must light the pilot before using the hand-held remote control unit. See *Lighting Instructions* on page 22.

After lighting, let pilot flame burn for about one minute. Turn control knob to ON position. Adjust flame adjustment knob anywhere between HI and LO. Slide the selector switch to the REMOTE position (see Figure 39, page 24). **Note:** The burner may light if hand-held remote was on when selector switch was last turned off. You can now turn the burner on and off with the hand-held remote control unit.

**IMPORTANT:** Do not leave the selector switch in the REMOTE or ON position when the pilot is not lit. This will drain the battery.

## OPERATING FIREPLACE

### Continued



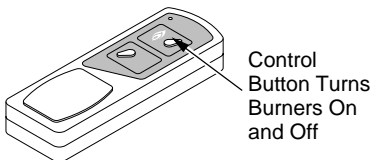
**Figure 39 - Setting the Selector Switch, Control Knob, and Flame Adjustment Knob for Hand-Held Remote Operation**

### ON/OFF SERIES (MODEL GHRCB)

Hold the control button on the hand-held remote until burner turns on. Hold the control button again until burner turns off (see Figure 40).

**TO LOCK** press both buttons on hand-held remote control until light stops flashing. Hand-held remote control is now locked. If the fire is on it will be turned off automatically. In the locked state, the light will not light up when any button is pressed.

**TO UNLOCK** press both buttons together on hand-held remote control until the light stops flashing. The hand-held remote is now unlocked.



**Figure 40 - On/Off Hand-Held Remote Control Unit (GHRCB)**

### THERMOSTAT SERIES (MODEL GHRCTB)

The hand-held remote can be operated using either the manual mode (MANU) or thermostatic mode (AUTO) (see Figure 41). To select Fahrenheit/Centigrade mode display, carefully press the °C/°F mode button with the end of a paper clip or similar blunt object.

#### Manual Mode

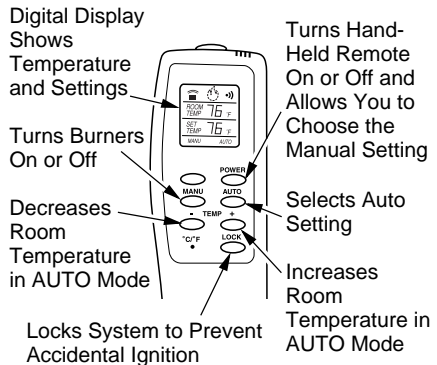
1. Press the **POWER** and **LOCK** buttons together to turn on the hand-held remote control.
2. Press the **MANU** button to turn on the fireplace.
3. Press the **POWER** and **LOCK** buttons together to turn off the fireplace.

#### Auto (Thermostatic) Mode

1. Press the **POWER** and **LOCK** buttons together to turn on the hand-held remote control.
2. Press **AUTO** button to select this mode.
3. Set the desired room temperature by pressing the **TEMP +** or **-** buttons.
4. Press the **POWER** and **LOCK** buttons together to turn off the fireplace

**Note:** Do not leave the hand-held remote in the AUTO mode close to the fireplace. The radiant heat from the fireplace will turn off the fireplace. Ideally, place the hand-held remote in the center of the room facing towards the fireplace.

**Note:** Do not hold the hand-held remote for a long time. Body temperature will affect its operation in the AUTO mode.



**Figure 41 - Thermostat Hand-Held Remote Control Unit (GHRCTB)**

#### Safety Features

When away from home for an extended period of time or as a child safety feature to prevent accidental ignition of the fireplace, the receiver ON/OFF/REMOTE switch should be in the OFF position.

#### Auto Shutoff Feature

1. If the average room temperature exceeds 82 degrees Fahrenheit (28 degrees Centigrade), the hand-held remote control will perform a safety override and shut the fireplace off. This feature is not available in the MANU mode.
2. The receiver continuously receives signals from the hand-held remote to control the room temperature. If the hand-held remote is misplaced, obstructed, or for any reason cannot transmit to the receiver, the receiver will shut off the fireplace after 8 minutes.



## OPERATING FIREPLACE

### Continued

#### Key Pad Lock Feature

This feature allows the user to lock/unlock the keypad on the hand-held remote in the MANU or AUTO mode to prevent inadvertent operation (i.e. children operating the hand-held remote control, etc.). The keypad is locked in either on or off. Press the POWER and LOCK buttons together to turn the unit on or off.

#### GWMT1 WALL MOUNTED THERMOSTAT (OPTIONAL)

Make sure the heater switch is on AUTO and set the temperature adjustment on wall thermostat to the desired setting. The thermostat has been electronically calibrated at the factory and requires no adjustment or leveling.

Upon installation, the thermostat must be allowed to stabilize at room temperature for a minimum of 30 minutes for proper operation. See installation instructions on pages 20 and 21 of this manual.

#### GWMS2 WALL MOUNTED SWITCH (OPTIONAL)

Make sure the heater switch is on AUTO. This wall switch works just like the conventional light switch. Flip the switch up for on and down for off.

**Note:** Make sure that this switch is not in a position to be mistaken for a light switch. This may result in the fireplace being inadvertently turned on without the proper precautions being taken. See installation instructions on page 21 of this manual.

#### OPERATING BLOWER (OPTIONAL)

This blower has three settings: ON, OFF, and AUTO. In the ON position, the blower will operate constantly. In the OFF position, the blower will not operate. In the AUTO position, the blower will start when the thermostat senses a sufficient increase in firebox temperature.

**Note:** Your fireplace and thermostat blower will not turn on and off at the same time. The fireplace may run for several minutes before the blower turns on. After the heater modulates to the pilot position, the blower will continue to run. The blower will shut off after the firebox temperature decreases.

**Note:** It is safe to operate fireplace with blower turned off. However, the blower helps distribute heated air from the fireplace.

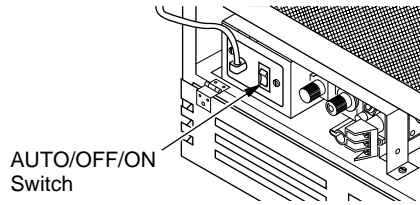


Figure 42 - AUTO/OFF/ON Blower Switch

## INSPECTING BURNERS

Check pilot flame pattern and burner flame patterns often.

### PILOT FLAME PATTERN

Figure 43 shows a correct pilot flame pattern. Figure 44 shows an incorrect pilot flame pattern. The incorrect pilot flame is not touching the thermocouple. This will cause the thermocouple to cool. When the thermocouple cools, the fireplace will shut down.

If pilot flame pattern is incorrect, as shown in Figure 44

- turn fireplace off (see *To Turn Off Gas to Appliance*, page 23)
- see *Troubleshooting*, pages 28 through 31

**Note:** The pilot flame on natural gas units will have a slight curve, but flame should be blue and have no yellow or orange color.

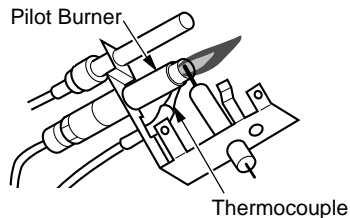


Figure 43 - Correct Pilot Flame Pattern (Propane/LP Shown)

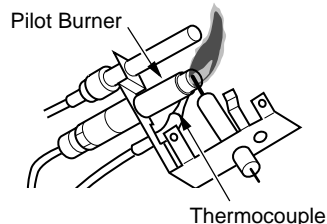


Figure 44 - Incorrect Pilot Flame Pattern (Propane/LP Shown)

## INSPECTING BURNERS

*Continued*

### BURNER FLAME PATTERN

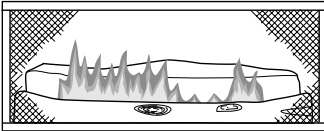
Figure 45 shows a correct burner flame pattern. Figure 46 shows an incorrect burner flame pattern. The incorrect burner flame pattern shows sporadic, irregular flame tipping. The flame should not be dark or have an orange/reddish tinge.

*Note:* When using the fireplace the first time, the flame will be orange for approximately one hour until the log cures.

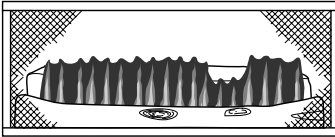
If burner flame pattern is incorrect, as shown in Figure 46

- turn fireplace off (see *To Turn Off Gas to Appliance*, page 23)
- see *Troubleshooting*, pages 28 through 31

#### 26,000 Btu/Hr Units

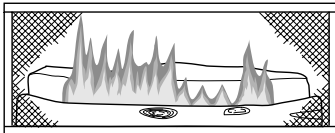


#### 10,000 Btu/Hr Units

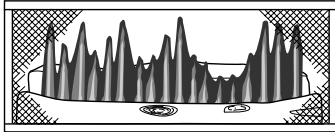


**Figure 45 - Correct Burner Flame Pattern**

#### 26,000 Btu/Hr Units



#### 10,000 Btu/Hr Units



**Figure 46 - Incorrect Burner Flame Pattern**

## CLEANING AND MAINTENANCE

**⚠ WARNING:** Turn off fireplace and let cool before cleaning.

**⚠ CAUTION:** You must keep control areas, burner, and circulating air passageways of fireplace clean. Inspect these areas of fireplace before each use. Have fireplace inspected yearly by a qualified service person. Fireplace may need more frequent cleaning due to excessive lint from carpeting, pet hair, bedding material, etc.

**⚠ WARNING:** Failure to keep the primary air opening(s) of the burner(s) clean may result in sooting and property damage.

### BURNER INJECTOR HOLDER AND PILOT AIR INLET HOLE

The primary air inlet holes allow the proper amount of air to mix with the gas. This provides a clean burning flame. Keep these holes clear of dust, dirt, lint, and pet hair. Clean these air inlet holes prior to each heating season. Blocked air holes will create soot. We recommend that you clean the unit every three months during operation and have fireplace inspected yearly by a qualified service person.

We also recommend that you keep the burner tube and pilot assembly clean and free of dust and dirt. To clean these parts we recommend using compressed air no greater than 30 PSI. Your local computer store, hardware store, or home center may carry compressed air in a can. You can use a vacuum cleaner in the blow position. If using compressed air in a can, please follow the directions on the can. If you don't follow directions on the can, you could damage the pilot assembly.

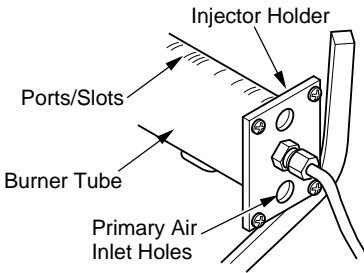
1. Shut off the unit, including the pilot. Allow the unit to cool for at least thirty minutes.
2. Inspect burner, pilot, and primary air inlet holes on injector holder for dust and dirt (see Figure 47, page 27).

# CLEANING AND MAINTENANCE

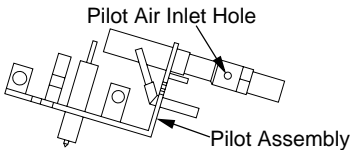
## Continued

3. Blow air through the ports/slots and holes in the burner.
4. Check the injector holder located at the end of the burner tube again. Remove any large particles of dust, dirt, lint, or pet hair with a soft cloth or vacuum cleaner nozzle.
5. Blow air into the primary air holes on the injector holder.
6. In case any large clumps of dust have now been pushed into the burner repeat steps 3 and 4.

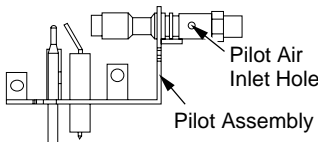
Clean the pilot assembly also. A yellow tip on the pilot flame indicates dust and dirt in the pilot assembly. There is a small pilot air inlet hole about two inches from where the pilot flame comes out of the pilot assembly (see Figures 48 or 49 depending on model). With the unit off, lightly blow air through a drinking straw if compressed air is not available.



**Figure 47 - Injector Holder On Outlet Burner Tube**



**Figure 48 - Pilot Inlet Air Hole (Propane/LP Gas)**



**Figure 49 - Pilot Inlet Air Hole (Natural Gas)**

## LOG SET

- If you remove one-piece log set for cleaning, refer to *Installing Log Set and Screen*, page 21, for placement instructions.
- Replace log set if broken or chipped (dime-sized or larger).

## CABINET

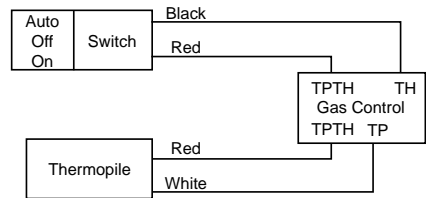
### Air Passageways

- Use a vacuum cleaner or pressurized air to clean.

### Exterior

- Use a soft cloth dampened with a mild soap and water mixture. Wipe the cabinet to remove dust.

## WIRING DIAGRAM



## TROUBLESHOOTING

**⚠ WARNING:** Turn off and unplug fireplace and let cool before servicing. Only a qualified service person should service and repair fireplace.

**⚠ CAUTION:** Never use a wire, needle, or similar object to clean ODS/pilot. This can damage ODS/pilot unit.

*Note:* All troubleshooting items are listed in order of operation.

OBSERVED PROBLEM	POSSIBLE CAUSE	REMEDY
When ignitor button is pressed, there is no spark at ODS/pilot	1. Ignitor electrode not connected to ignitor cable	1. Reconnect ignitor cable
	2. Ignitor cable pinched or wet	2. Free ignitor cable if pinched by any metal or tubing. Keep ignitor cable dry
	3. Broken ignitor cable	3. Replace ignitor cable
	4. Bad piezo ignitor	4. Replace piezo ignitor
	5. Ignitor electrode positioned wrong	5. Replace pilot assembly
	6. Ignitor electrode broken	6. Replace pilot assembly
When ignitor button is pressed, there is spark at ODS/pilot but no ignition	1. Gas supply turned off or equipment shutoff valve closed	1. Turn on gas supply or open equipment shutoff valve
	2. Control knob not in PILOT position	2. Turn control knob to PILOT position
	3. Control knob not pressed in while in PILOT position	3. Press in control knob while in PILOT position
	4. Air in gas lines when installed	4. Continue holding down control knob. Repeat igniting operation until air is removed
	5. Depleted gas supply (propane/LP only)	5. Contact local propane/LP gas company
	6. ODS/pilot is clogged	6. Clean ODS/pilot (see <i>Cleaning and Maintenance</i> , pages 26 and 27) or replace ODS/pilot assembly
	7. Gas regulator setting is not correct	7. Replace gas regulator

---

## TROUBLESHOOTING

### *Continued*

<b>OBSERVED PROBLEM</b>	<b>POSSIBLE CAUSE</b>	<b>REMEDY</b>
ODS/pilot lights but flame goes out when control knob is released	1. Control knob not fully pressed in	1. Press in control knob fully
	2. Control knob not pressed in long enough	2. After ODS/pilot lights, keep control knob pressed in 30 seconds
	3. Safety interlock system has been triggered	3. Wait one minute for safety interlock system to reset. Repeat ignition operation
	4. Equipment shutoff valve not fully open	4. Fully open equipment shutoff valve
	5. Pilot flame not touching thermocouple, which allows thermocouple to cool, causing pilot flame to go out. This problem could be caused by one or both of the following: A) Low gas pressure B) Dirty or partially clogged ODS/pilot	5. A) Contact local natural or propane/LP gas company  B) Clean ODS/pilot (see <i>Cleaning and Maintenance</i> , pages 26 and 27) or replace ODS/pilot assembly
	6. Thermocouple connection loose at control valve	6. Hand tighten until snug, then tighten 1/4 turn more
	7. Thermocouple damaged	7. Replace pilot assembly
	8. Control valve damaged	8. Replace control valve
Burner does not light after ODS/pilot is lit	1. Inlet gas pressure is too low	1. Contact local natural or propane/LP gas company
	2. Burner orifice is clogged	2. Clean burner (see <i>Cleaning and Maintenance</i> , pages 26 and 27) or replace burner orifice
	3. Thermopile leads disconnected or improperly connected	3. Reconnect leads (see <i>Wiring Diagram</i> , page 27)
	4. Burners will not come on in remote position	4. Replace battery in hand-held remote and receiver
Delayed ignition of burner	1. Manifold pressure is too low	1. Contact local natural or propane/LP gas company
	2. Burner orifice is clogged	2. Clean burner (see <i>Cleaning and Maintenance</i> , pages 26 and 27) or replace burner orifice
Burner backfiring during combustion	1. Burner orifice is clogged or damaged	1. Clean burner (see <i>Cleaning and Maintenance</i> , pages 26 and 27) or replace burner orifice
	2. Damaged burner	2. Replace damaged burner
	3. Gas regulator defective	3. Replace gas regulator
	4. Inlet gas pressure is too low	4. Contact local natural or propane/LP gas company

---

## TROUBLESHOOTING

### *Continued*

<b>OBSERVED PROBLEM</b>	<b>POSSIBLE CAUSE</b>	<b>REMEDY</b>
Slight smoke or odor during initial operation	<ol style="list-style-type: none"><li>1. Residues from manufacturing processes and log curing</li><li>2. Not enough air</li><li>3. Gas regulator defective</li></ol>	<ol style="list-style-type: none"><li>1. Problem will stop after a few hours of operation</li><li>2. Check burner for dirt and debris. If found, clean burner (see <i>Cleaning and Maintenance</i>, pages 26 and 27)</li><li>3. Replace gas regulator</li></ol>
Fireplace produces a whistling noise when burner is lit	<ol style="list-style-type: none"><li>1. Turning control knob to HI position when burner is cold</li><li>2. Air in gas line</li><li>3. Air passageways on fireplace blocked</li><li>4. Dirty or partially clogged burner orifice</li></ol>	<ol style="list-style-type: none"><li>1. Turn control knob to LO position and let warm up for a minute</li><li>2. Operate burner until air is removed from line. Have gas line checked by local natural gas company</li><li>3. Observe minimum installation clearances (see pages 10 through 12)</li><li>4. Clean burner (see <i>Cleaning and Maintenance</i>, pages 26 and 27) or replace burner orifice</li></ol>
White powder residue forming within burner box or on adjacent walls or furniture	<ol style="list-style-type: none"><li>1. When heated, vapors from furniture polish, wax, carpet cleaners, etc. may turn into white powder residue</li></ol>	<ol style="list-style-type: none"><li>1. Turn fireplace off when using furniture polish, wax, carpet cleaners, or similar products</li></ol>
Moisture/condensation noticed on windows	<ol style="list-style-type: none"><li>1. Not enough combustion/ventilation air</li></ol>	<ol style="list-style-type: none"><li>1. Refer to Air for Combustion and Ventilation requirements (page 6)</li></ol>

## TROUBLESHOOTING

*Continued*



**WARNING: If you smell gas**

- **Shut off gas supply.**
- **Do not try to light any appliance.**
- **Do not touch any electrical switch; do not use any phone in your building.**
- **Immediately call your gas supplier from a neighbor's phone. Follow the gas supplier's instructions.**
- **If you cannot reach your gas supplier, call the fire department.**

*IMPORTANT:* Operating fireplace where impurities in air exist may create odors. Cleaning supplies, paint, paint remover, cigarette smoke, cements and glues, new carpet or textiles, etc., create fumes. These fumes may mix with combustion air and create odors. These odors will disappear over time.

<b>OBSERVED PROBLEM</b>	<b>POSSIBLE CAUSE</b>	<b>REMEDY</b>
Remote does not function	1. Battery is not install. Battery power is low	1. Replace 9-volt batteries in receiver and remote control
Fireplace produces a clicking/ticking noise just after burners are lit or shut off	1. Metal expanding while heating or contracting while cooling	1. This is common with most fireplaces. If noise is excessive, contact qualified service person
Fireplace produces unwanted odors	1. Fireplace burning vapors from paint, hair spray, glues, cleaners, chemicals, new carpet, etc. (See <i>IMPORTANT</i> statement above) 2. Low fuel supply (propane/LP only) 3. Gas leak. <b>See Warning statement at top of page</b>	1. Open window to ventilate room. Stop using odor causing products while fireplace is running 2. Refill supply tank (propane/LP only) 3. Locate and correct all leaks (see <i>Checking Gas Connections</i> , pages 18 and 19)
Fireplace shuts off in use (ODS operates)	1. Not enough fresh air is available 2. Low line pressure 3. ODS/pilot is partially clogged	1. Open window and/or door for ventilation 2. Contact local natural or propane/LP gas company 3. Clean ODS/pilot (see <i>Cleaning and Maintenance</i> , pages 26 and 27)
Gas odor even when control knob is in OFF position	1. Gas leak. <b>See Warning statement at top of page</b> 2. Control valve defective	1. Locate and correct all leaks (see <i>Checking Gas Connections</i> , pages 18 and 19) 2. Replace control valve
Gas odor during combustion	1. Foreign matter between control valve and burner 2. Gas leak. <b>See Warning statement at top of page</b>	1. Take apart gas tubing and remove foreign matter 2. Locate and correct all leaks (see <i>Checking Gas Connections</i> , pages 18 and 19)

---

## SPECIFICATIONS

	<b>Remote-Ready Models VMH26PRB, EFS26PRA</b>	<b>Remote-Ready Models VMH26NRB, EFS26NRA</b>
Btu/Hr	14,000/26,000	14,000/26,000
Type Gas	Propane/LP Gas Only	Natural Gas Only
Ignition	Piezo	Piezo
Manifold Pressure	8" W.C.	3.5" W.C.
Inlet Gas Pressure (in. of water)		
Maximum	14"	10.5"
Minimum*	11"	5"
Dimensions, inches (HxWxD)		
Fireplace (including hood and screws)	25 <sup>7</sup> / <sub>8</sub> x 26 <sup>13</sup> / <sub>16</sub> x 9 <sup>3</sup> / <sub>8</sub>	25 <sup>7</sup> / <sub>8</sub> x 26 <sup>13</sup> / <sub>16</sub> x 9 <sup>3</sup> / <sub>8</sub>
Carton	32 <sup>5</sup> / <sub>8</sub> x 27 <sup>13</sup> / <sub>16</sub> x 11 <sup>5</sup> / <sub>8</sub>	32 <sup>5</sup> / <sub>8</sub> x 27 <sup>13</sup> / <sub>16</sub> x 11 <sup>5</sup> / <sub>8</sub>
Weight, pounds		
Fireplace	44 <sup>1</sup> / <sub>2</sub> lbs.	44 <sup>1</sup> / <sub>2</sub> lbs.
Shipping	48 lbs.	48 lbs.

\* For purpose of input adjustment



---

## REPLACEMENT PARTS

*Note:* Use only original replacement parts. This will protect your warranty coverage for parts replaced under warranty.

### PARTS UNDER WARRANTY

Contact authorized dealers of this product. If they can't supply original replacement part(s), call DESA Heating Products' Technical Service Department at 1-866-672-6040.

When calling DESA Heating Products, have ready

- your name
- your address
- model and serial numbers of your fireplace
- how fireplace was malfunctioning
- type of gas used (propane/LP or natural gas)
- purchase date

Usually, we will ask you to return the part to the factory.

### PARTS NOT UNDER WARRANTY

Contact authorized dealers of this product. If they can't supply original replacement part(s), call DESA Heating Products at 1-866-672-6040 for referral information.

When calling DESA Heating Products, have ready

- model number of your fireplace
- the replacement part number

## SERVICE HINTS

### When Gas Pressure Is Too Low

- pilot will not stay lit
- burners will have delayed ignition
- fireplace will not produce specified heat
- for propane/LP units, propane/LP gas supply may be low

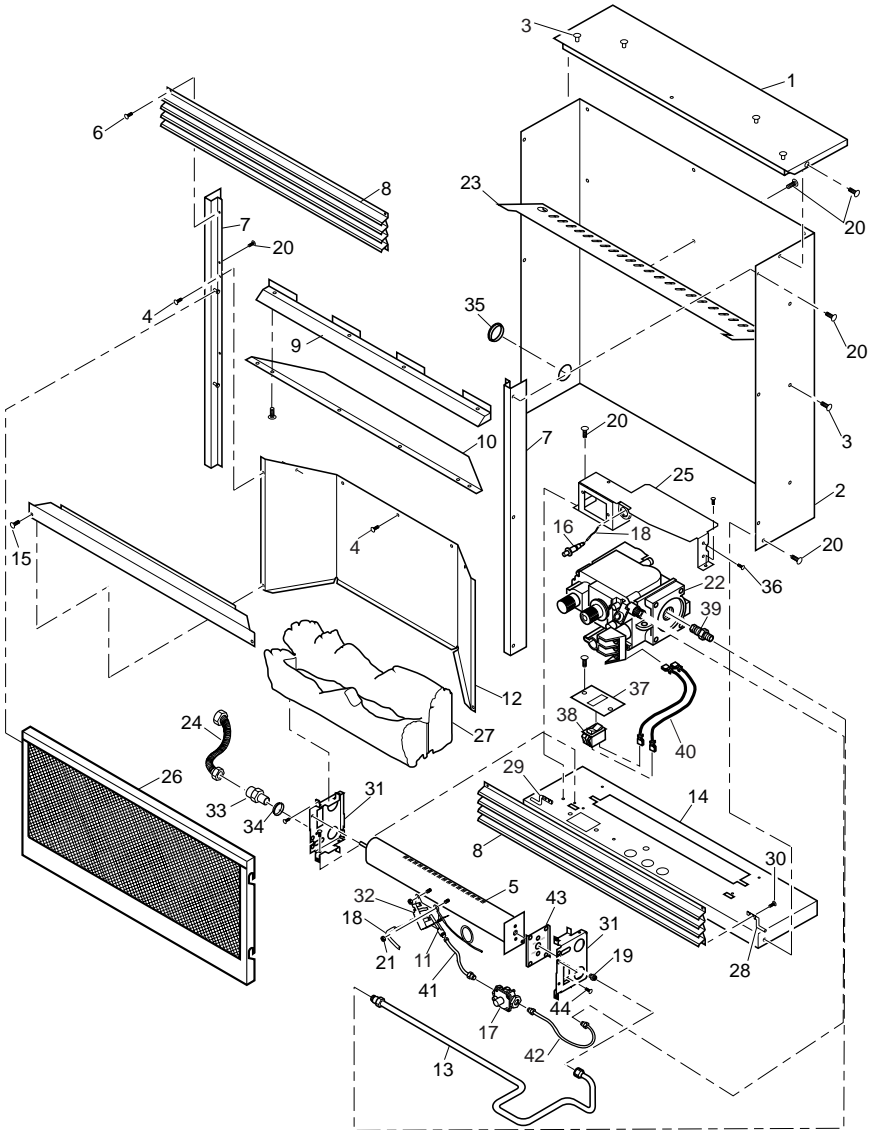
You may feel your gas pressure is too low. If so, contact your local natural or propane/LP gas supplier.

## TECHNICAL SERVICE

You may have further questions about installation, operation, or troubleshooting. If so, contact DESA Heating Products' Technical Service Department at 1-866-672-6040. When calling, please have your model and serial numbers of your heater ready.

You can also visit DESA Heating Products' technical services web site at [www.desatech.com](http://www.desatech.com).

**ILLUSTRATED PARTS BREAKDOWN**  
**REMOTE-READY MODELS**  
**VMH26PRB, VMH26NRB (Shown), EFS26PRA, EFS26NRA**



## PARTS LIST

### REMOTE-READY MODELS

This list contains replaceable parts used in your fireplace. When ordering parts, follow the instructions listed under *Replacement Parts* on page 33 of this manual.

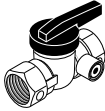
KEY NO.	PART NUMBERS		DESCRIPTION	QTY.
	VMH26PRB EFS26PRA	VMH26NRB EFS26NRA		
1	102633-02	102633-02	Outer Casing Top	1
2	102624-02	102624-02	Outer Casing	1
3	099230-02	099230-02	Shoulder Screw	14
4	098304-01	098304-01	Screw, #10 x 3/8"	13
5	109824-05	109824-05	Burner	1
6	098304-02	098304-06	Screw, PPH AB 6-20 x .38	4
7	102635-02	102635-02	Left and Right Side Front	2
8	103209-05	103209-05	Louver	2
9	104281-02CK	104281-02CK	Firebox Hood	1
10	102638-01	102638-01	Firebox Top	1
11	103778-01	103779-01	ODS/Pilot Assembly	1
12	**	**	Firebox Wrapper	1
13	104322-01	104322-01	Burner Tube	1
14	104335-01CK	104335-01CK	Outer Shell Base	1
15	102649-02	102649-02	Branch Support	1
16	102445-01	102445-01	Piezo Ignitor	1
17	—	099918-02	Regulator, Pilot	1
18	098271-10	098271-10	Ignitor Cable	1
19	107186-01	107186-02	Injector	1
20	M11084-26	M11084-26	Screw, Hex Head, #10 x 3/8"	25
21	098249-01	098249-01	Nut, M5	6
22	103781-02	103781-01	Gas Valve	1
23	102639-01	102639-01	Baffle	1
24	101628-01	101628-01	Flexible Connector	1
25	104305-01	104305-01	Control Shield	1
26	103295-03CK	103295-03CK	Screen Assembly	1
27	107153-01	107153-01	Log Set Assembly Kit	1
28	104313-01	104313-01	Right Hinge	1
29	104313-02	104313-02	Left Hinge	1
30	M10908-2	M10908-2	Hinge Screws	4
31	103734-01	103734-01	Burner Support	2
32	101006-02	101006-02	Pilot Bracket	1
33	097809-02	097809-02	Connector, Male	1
34	101629-01	101629-01	Bushing	1
35	101629-02	101629-02	Bushing	1
36	M12461-26	M12461-26	Gas Valve Screws	4
37	103587-02	103587-02	Plate, Switch	1
38	099998-01	099998-01	Switch, Fan	1
39	098264-02	098264-02	Connector, Male	1
40	103284-03	103284-03	Wire Harness	1
41	—	099387-14	Pilot Tube to Regulator	1
42	099387-13	099387-15	Pilot Tube to Control Valve	1
43	—	107634-02	NG Conversion Plate	1
44	M10908-75	M10908-75	Hex Wsr Head Tapping Screw	1
<b>PARTS AVAILABLE — NOT SHOWN</b>				
	103877-01	103877-01	Lighting Instructions Plate	1
	100563-01	100563-01	Warning Plate	1
	103470-02	103470-02	Hardware Package	1

\*\* Part not available for field replacement.

## ACCESSORIES

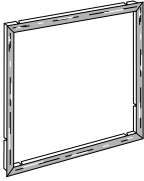
**NOTICE: All accessories may not be available for all fireplace models.**

Purchase these fireplace accessories from your local dealer. If they can not supply these accessories, call DESA Heating Products at 1-866-672-6040 for referral information. You can also write to the address listed on the back page of this manual.



### EQUIPMENT SHUTOFF VALVE GA5010

**For all models.** Equipment shutoff valve with 1/8" NPT tap. Fits 1/2" NPT pipe.



### PERIMETER TRIM KIT - GA6095

**For all models.** Optional four-sided perimeter trim kit for recessed built-in installations (when unit is raised off of the floor). Provides a finished appearance by covering rough edges of wall opening.

### PERIMETER TRIM KIT (Not Shown)

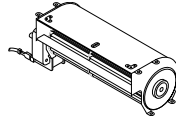
**GA6094 - Polished Brass**  
**GAB6094 - Black**  
**GAP6094 - Platinum**

**For all models.** Optional three-sided perimeter trim kit for custom and recessed installations (when unit is on the floor). Provides a finished appearance by covering rough edges of wall opening. Black trim included with all mantels.

### EXTRUDED LOUVER KIT (Not Shown)

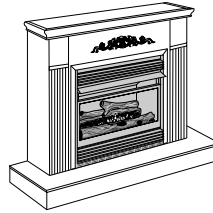
**GA9092 - Polished Brass**  
**GAP9092 - Platinum**

**For all models.** Optional extruded louver. Kit contains 2 louvers.



### THERMOSTAT-CONTROLLED BLOWER KIT - GA3450T

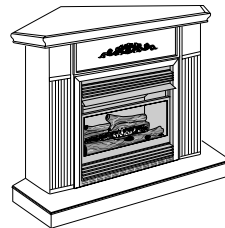
**For all models.** Provides better heat distribution. Makes fireplace more efficient. Automatically turns off and on as needed.



### CABINET MANTEL WITH BUILT-IN HEARTH BASE AND ROUNDED LEG STYLING

**GMC61U Series - Unfinished**  
**GMC60F Series - Oak Finished**  
**GMC65W Series - White Lacquer Finished**  
**(Appearance May Differ by Model)**

**For all models.** A mantel and hearth base offers compact styling and completes the fireplace look. Available in an oak stained or an unfinished birch, ready to stain or paint. Complete assembly instructions included. Three-sided perimeter trim kit included.



### CORNER MANTEL WITH FULL HEARTH BASE

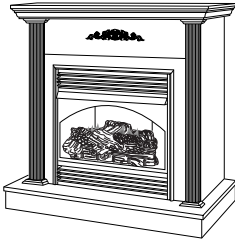
**GMC63U Series - Unfinished**  
**GMC64F Series - Finished**  
**GMC83F Series - Finished (Column Style)**

**For all models.** Space-saving mantel and hearth base corner design features clean, classic lines. Available in a stained oak, white lacquer or an unfinished hardwood, ready to stain or paint. Complete assembly instructions included. Three-sided perimeter trim kit included.

---

## ACCESSORIES

*Continued*



### **CABINET MANTEL AND FULL HEARTH BASE**

**GMC80F Series - Oak Finished**  
**GMC81U Series - Unfinished Birch**  
**GMC82F Series - Cherry Finished Birch**

**For all models.** Mantel features columns, moldings, fluting and medallion. Three-sided perimeter trim kit included.

Dimensions (WxHxD): 56" x 50" x 24"

### **CLEANING KIT - GCK (Not Shown)**

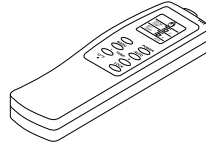
**For all models.** Your vent-free gas appliance requires regular cleaning and maintenance to prevent performance problems. This kit gives you the tools and instructions to make it easy to clean all critical areas of your appliance.

### **WALL-MOUNT THERMOSTAT SWITCH - GWMT1 (Not Shown)**

**For all models.** The desired comfort setting can be selected on the wall thermostat and the fireplace will automatically cycle from pilot to the heat setting selected.

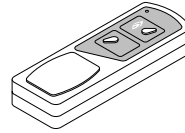
### **WALL-MOUNT ON/OFF SWITCH GWMS2 (Not Shown)**

**For all models.** Allows the fireplace to be turned on and off with a wall switch.



### **RECEIVER AND HAND-HELD THERMOSTAT REMOTE CONTROL KIT - GHRCTB**

**For all models.** Allows the fireplace to be operated in a manually or thermostatically controlled mode. You can turn the fireplace on and off without ever leaving the comfort of your easy chair.



### **RECEIVER AND HAND-HELD REMOTE CONTROL KIT - GHRCB**

**For all models.** Allows the fireplace to be turned on and off by using a hand-held remote control.

### **INFORMATION VIDEO - 108917-01**

**For all models.** A care and maintenance video is available by calling 1-866-672-6040. You may also email your request to [productsupport@desaint.com](mailto:productsupport@desaint.com).

### **FIRE CRACKLE - CF6A (Not Shown)**

**For all models.** Creates the sound of a real burning fire.





# WARRANTY INFORMATION

## KEEP THIS WARRANTY

Model \_\_\_\_\_  
Serial No. \_\_\_\_\_  
Date Purchased \_\_\_\_\_

Always specify model and serial numbers when communicating with the factory.

We reserve the right to amend these specifications at any time without notice. The only warranty applicable is our standard written warranty. We make no other warranty, expressed or implied.

### LIMITED WARRANTY VENT-FREE COMPACT CLASSIC HEARTH® FIREPLACE

DESA Heating Products warrants this product to be free from defects in materials and components for four (4) years and five (5) years on stainless steel burners from the date of first purchase, provided that the product has been properly installed, operated and maintained in accordance with all applicable instructions. To make a claim under this warranty the Bill of Sale or cancelled check must be presented.

This warranty is extended only to the original retail purchaser. This warranty covers the cost of part(s) required to restore this fireplace to proper operating condition and an allowance for labor when provided by a DESA Heating Products Authorized Service Center. Warranty part(s) MUST be obtained through authorized dealers of this product and/or DESA Heating Products who will provide original factory replacement parts. Failure to use original factory replacement parts voids this warranty. The fireplace MUST be installed by a qualified installer in accordance with all local codes and instructions furnished with the unit.

This warranty does not apply to parts that are not in original condition because of normal wear and tear, or parts that fail or become damaged as a result of misuse, accidents, lack of proper maintenance or defects caused by improper installation. Travel, diagnostic cost, labor, transportation and any and all such other costs related to repairing a defective fireplace will be the responsibility of the owner.

TO THE FULL EXTENT ALLOWED BY THE LAW OF THE JURISDICTION THAT GOVERNS THE SALE OF THE PRODUCT; THIS EXPRESS WARRANTY EXCLUDES ANY AND ALL OTHER EXPRESSED WARRANTIES AND LIMITS THE DURATION OF ANY AND ALL IMPLIED WARRANTIES, INCLUDING WARRANTIES OF MERCHANTABILITY AND FITNESS FOR A PARTICULAR PURPOSE TO FOUR (4) YEARS ON ALL COMPONENTS AND FIVE (5) YEARS ON STAINLESS STEEL BURNERS FROM THE DATE OF FIRST PURCHASE; AND DESA HEATING PRODUCTS' LIABILITY IS HEREBY LIMITED TO THE PURCHASE PRICE OF THE PRODUCT AND DESA HEATING PRODUCTS SHALL NOT BE LIABLE FOR ANY OTHER DAMAGES WHATSOEVER INCLUDING INDIRECT, INCIDENTAL OR CONSEQUENTIAL DAMAGES.

Some states do not allow a limitation on how long an implied warranty lasts or an exclusion or limitation of incidental or consequential damages, so the above limitation on implied warranties, or exclusion or limitation on damages may not apply to you.

This warranty gives you specific legal rights, and you may also have other rights that vary from state to state.

For information about this warranty write:

**DESA**  
HEATING PRODUCTS  
2701 Industrial Drive  
P.O. Box 90004  
Bowling Green, KY 42102-9004  
[www.desatech.com](http://www.desatech.com)



113110 01

NOT A UPC

113110-01  
Rev. A  
03/04