

# Giada N10U

## User's Manual

Version 001

# Contents

Gratitude .....	2
Copyright and Trademark .....	3
I. Introduction to the Manual .....	4
1. Precautions .....	4
2. Accessories .....	5
II. About the product .....	6
1. Appearance .....	7
2. Features .....	8
III. Using the product .....	9
1. Connecting the keyboard and mouse .....	9
2. Connecting the monitor .....	10
3. Connecting to the adapter .....	11
4. Startup .....	11
5. Installing the operating system .....	12
IV. Equipment expansion .....	13
1. Card Reader .....	13
2. USB device .....	13
3. Audio device .....	14
4. Network device .....	14
V. Applications .....	16
1. Home Digital HD Theater .....	16
2. Office work/entertainment .....	17
3. Household server/downloader .....	18
4. Mobile operation .....	18
VI. Power supply and maintenance .....	19
1. Adapter .....	19
2. Maintenance .....	20
VII. Troubleshooting .....	21

# Gratitude

Dear Users,

Thank you for purchasing Giada N10U.

In such a new era of PC development, we launched Giada N10U which is characterized by the mini shape, vogue and ultra-thin structure, environment friendly and lower power consumption. Giada N10U is provided with multiple functions, including serving as equipment for the digital HD Theater, exclusive downloader, small server, internet access for office work and higher mobility when compared with traditional PCs. Giada N10U will allow you to undergo new experience in the field.

This User's Manual would allow you better understand the device. Therefore, please carefully read the whole manual before you operate the device.

In case you have any questions concerning after-sales services in using the product, please contact us according to the contact information below:

Website: [www.giadatech.com](http://www.giadatech.com)

Add: 2/F, Building A, Qinghua Hi-Tech Park, North Area Shenzhen HI-Tech & Industrial Estate, Nanshan, Shenzhen, China.

## Copyright and Trademark

Shenzhen JEHE Technology development Co., Ltd will try our best to ensure the accuracy and intactness of this manual. However, as our products are being upgraded all the time, we can't guarantee that this Manual is flawless and shall bear no responsibility if it is misunderstood by the user. The User's Manual is subject to change without prior notice.

Giada and the related mark are trademarks owned by Shenzhen JEHE Technology development Co., Ltd.

Windows, MS, MS-DOS, Windows Vista and Windows 7 are trademarks of USA Microsoft Corporation, which were registered in the US, other countries or other regions in the world.

NVIDIA ION, Geforce, Geforce CUDA, PureVideo HD and PhysX are trademarks of USA's NVIDIA, which were registered in the US, other countries or other regions in the world.

INTEL and ATOM are trademarks of USA's INTEL, which were registered in the US, other countries or other regions in the world.

Shenzhen JEHE Technology development Co., Ltd reserves the right for final interpretation of this Manual. Copying and reproduction of the contents in this document, or storage and transfer in any form without the prior written permission of Shenzhen JEHE Technology development Co., Ltd is prohibited.

# I. Introduction to the Manual

## 1. Precautions

In order to prevent the PC from being damaged, extend its service time, and ensure your normal use and personal safety, please carefully read the whole User's Manual and the related safety information and strictly follow the requirements in it. You should also keep the Manual well.

- Please first read the documents attached to the product. The page exclusively inserted should be read firstly.
- Please observe all alarm information and marks on safety.
- Please use the original power adapter, or use special power supply mentioned in the Manual.
- Place the product correctly on your table and make sure the anti-sliding base is installed.
- In lightning time, do not plug or unplug the phone cable, network cable, power cord or other conductors connecting outside.
- Unplug the power cord before you clean the device. Never use liquid, sprayed cleaning agent or wet cloth to clean the product.
- In order to protect the operating system, motherboard and hard disk, please do not keep pressing the power switch or the reset key. Avoid interrupt power failure during system's running, which might also physically damage the operating system.
- Do not remove the shell or repair the product without permission. such work should be done by professionals.
- Keep the PC away from heat source

Never block the heat vents. Keep your PC away from direct sunshine.

- Keep the product away from moisture

Never spill water or other liquid onto it. You should call the professional service personnel under following circumstances:

- a. The power cord or plug was damaged.
- b. Conductive liquid went into the product.
- c. The product was dropped onto the ground or its shell was damaged.
- d. When unidentified errors occurred or the product's performance is obviously deteriorated, please cut off power immediately and contact professional technicians.

## **2. Accessories**

Your Giada N10 consists of the accessories in the table below. If any of them is missing, please contact your local distributor or the customer service center timely.

- Host 1 unit
- Adapter (with power cord)1 piece
- User's Manual1 copy
- Disk1 piece
- Certificate of Conformity1 copy
- Warranty Card1 copy
- Mini keypad and mouse(optional)

## II. About the product





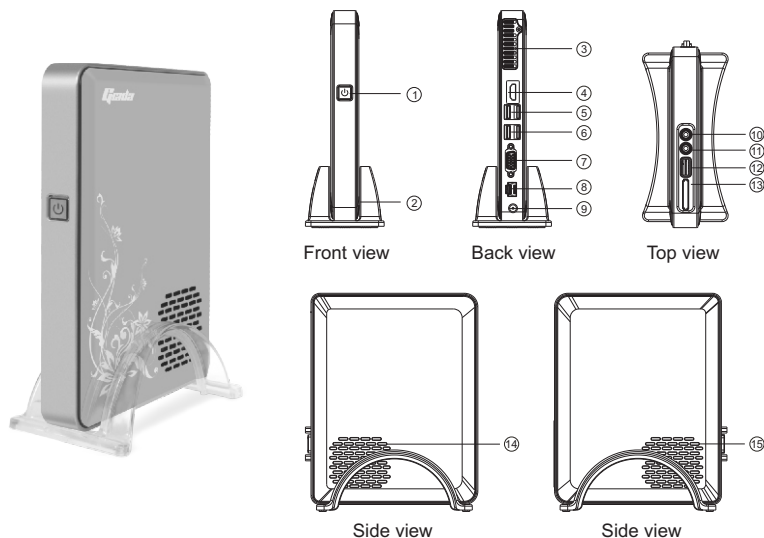

### 1. Appearance

Picture of the shell

Giada N10U with multiple interfaces can be connected to various types of monitors, storage devices and so on. There are some brief for all kinds of pictures in following table. The table will make you better understand the structure of the product.



- |                     |                   |                       |
|---------------------|-------------------|-----------------------|
| ① Power switch      | ⑥ USB interface   | ⑪ Output for earphone |
| ② Anti-sliding base | ⑦ VGA interface   | ⑫ USB port            |
| ③ Port of heat sink | ⑧ Lan interface   | ⑬ Card reader         |
| ④ HDMI interface    | ⑨ Power interface | ⑭ Left air inlet      |
| ⑤ USB interface     | ⑩ Input for mic   | ⑮ Right air inlet     |

Icon	Description	Use	Position
	Power switch	To start the PC	①
	Anti-sliding base	To fix the PC for safety purposes	②
	Port of heat sink	To allow the heat to be vented out	③
HDMI	HDMI interface	To connect HDMI cable	④
	USB interface	To connect USB devices	⑤ ⑥ ⑫ (Share)
	E-Sata interface	To connect to E-Sata devices	⑫ (Share)
VGA	VGA interface	To connect VGA analog monitor	⑦
	Lan interface	To connect internet cable	⑧
	Power interface	To connect power adapter	⑨
	Input for mic	To connect speaker	⑩
	Output for earphone	To connect earphone	⑪
	Card reader	to connect SD/SDHC/MMC data storage card	⑬
	Left air inlet	To allow cool air to get into	⑭
	Right air inlet	To allow cool air to get into	⑮

## 2. Features

Giada N10U adopted Graphics processing technology of NVIDIA and low power consumption INTEL CPU, so it is provided with many function:

### A. High-definition theater

Giada N10U, based on Graphics processing technology of NVIDIA, equipped 16-core CUDA technologies, which allows users to experience 1080P HD films and mainstream games.

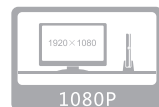



### B. Office-work/entertaining PC

Adopted four-line INTEL ATOM double-core CPU, the product can satisfy office work completely.

The stylish appearance and book-size structure can save your study space.



### C. Household downloader/server

The product also features its environmental-friendly design, lower power consumption (which is only 1/3 of traditional PC, less than that of ordinary power saving lamps), improved laptop radiating technology and low noise. Low power consumption and quiet running make it particularly suitable for downloading in sleeping time.



### D. High mobility

The size of Giada N10U is very small (only one-thirtieth of the desktop PC) and the weight is very light (just less than 1KG), so it can be put into your dressing bag.



## III. Using the product

### 1. Connecting the keyboard and mouse

Please make sure you have connected the cabled or wireless keyboard and mouse before you use the product. This product connects with keyboard and mouse by USB interfaces only. If your keyboard or mouse doesn't have USB interfaces, you may buy USB converter.

#### A. wired keyboard/mouse

Properly connect the keyboard and mouse to the USB interfaces at the back of the PC.

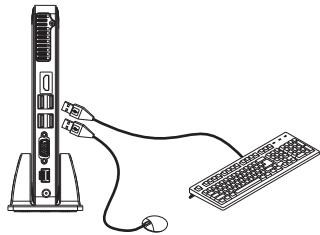

#### B. Wireless keyboard/mouse

Before connection, make sure your keyboard/mouse is loaded with battery that can supply sufficient power.

Step 1: First install the signal emitter of keyboard/mouse to the USB interface of the host. It is recommended to be installed on the top of the host.

Step 2: Turn on the switch at the back of the keyboard/mouse after the host is started.

Step 3: If the keyboard/mouse is not used for an extended period of time, turn off the switch to save power.

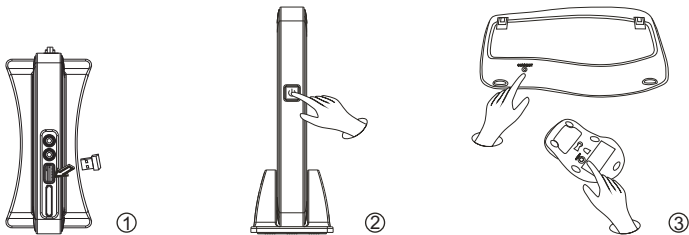

## 2. Connecting the monitor

This product can work together with different types of monitors through original HDMI digital interfaces and VGA analog interfaces. If your monitor adopts DVI interface, you should buy the interface converter.

### A. Monitor with HDMI interface

This product supports HD video and 7.1 channel audio signals by original HDMI digital interfaces. You can connect the monitor and other devices compatible with HDMI interfaces to the related ports at the back of the host.

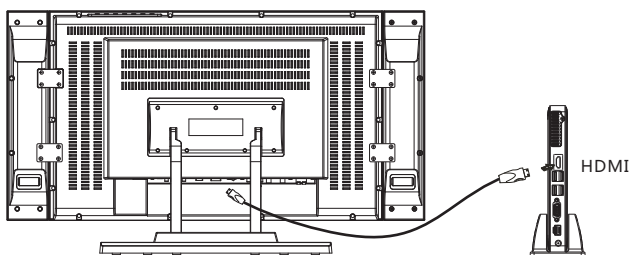

### B. Monitor with VGA interface

You can connect the monitor, projector or other devices by VGA interface at the back of the host.

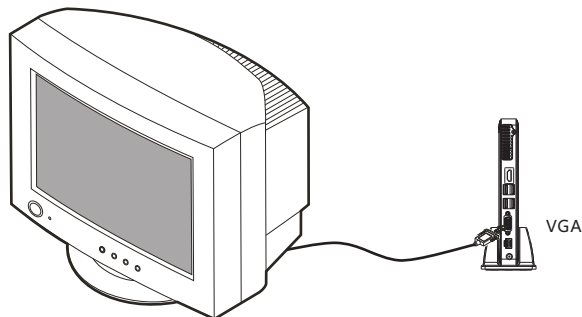

### 3. Connecting to the adapter

The power adapter of this product meets the related international standards, with input voltage 100V~240V. Please install it by following the steps:

- Step 1: Take out the adapter and its power cord from the package and connect them together properly.
- Step 2: Connect the DC output terminal of the adapter to power input port on the host.
- Step 3: Insert the AC plug of the adapter into the power receptacle.

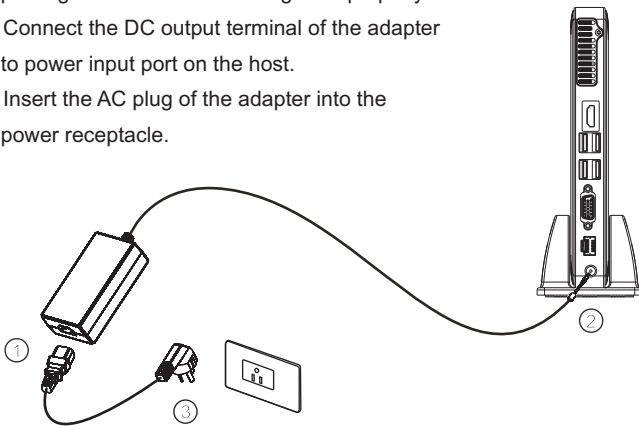

### 4. Startup

The start-up button of your PC is mounted at the upper-middle part of the front side of the host. In the host's running state, the indicator at the start-up button will illuminate in blue background light.

As this product is light and small, you may fix the host with your forefinger or middle finger, and then use your thumb to press the start-up button.

Once the PC is powered on, the system will automatically detect the hardware and its configurations (POST). If any error is found in that process, related indications will appear on the monitor. Based on the nature of the error, you can get into the BIOS interface for corrections, or you can view the troubleshooting information for that purpose.

**Note:** As BIOS was optimized before delivery, you don't have to change the settings which can provide you the optimal performance of the system. It is not recommended non-advanced users modify the default setups. If abnormality occurs due to the change of setup, please restore the ex-factory defaults.

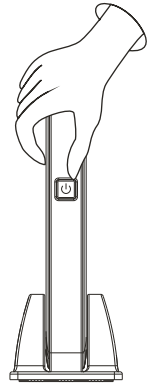

After the host is successfully started, it will load the operating system you installed.

## 5. Installing the operating system

This product supports Windows XP, Windows Vista, Windows 7 and other normal operating systems. If you want to install a new or change your current operating system, you can consult your local distributor, or you can connect the PC to an external CD-ROM and use the disk for installation.

## IV. Equipment expansion

### 1. Card Reader

The card reader of this product can support SD, MS, MS PRO, MMC and other mobile memory cards. It also supports PNP and hot swapping.

Insert the mobile memory card into PC through the top port on it and pay attention to the card's sides. Never use excessive force when inserting the card. Otherwise the memory card or the slot may be damaged.

Note: SD/MMC: with the omitted angle facing the right;

MS/MS PRO: with the omitted angle facing the left.

Exit of memory card:

- (1) Stop operation on the card
- (2) "Safely remove" the card through the operating system
- (3) Take out the card gently.

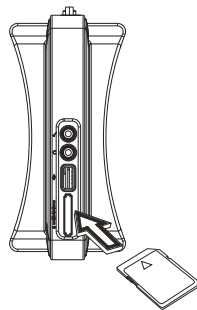

### 2. USB device

The five USB interfaces can support various types of USB devices, including USB CD-ROM, USB mobile device, USB mouse and USB TV card.

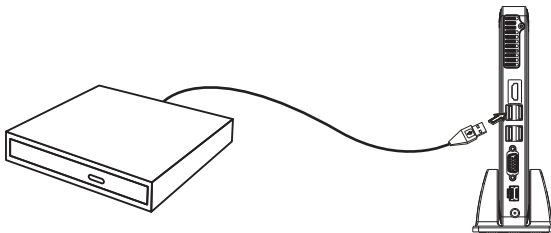

### 3. Audio device

You can connect the external microphone (or other audio input equipment) to audio input, and connect the earphone or speaker to the output port.

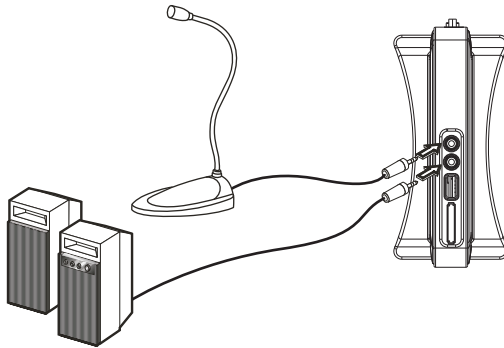

### 4. Network device

The WIFI device embedded in the product can help you set up a network, either cabled or wireless. Make sure you have installed the hub or switch before you set up the network. To construct a LAN or other network, please refer to following photo Note: Before setting up the network, please make sure you have properly installed the drive for the graphics card and wireless WIFI hardware.

#### A. Cabled network

- Insert the terminal of network cable, which comes from the hub or server, into the RJ-45 port, and make sure the connection is correct and firm.
- Please refer to the related instructions of operating systems and properly install the driver and related applications for the network.

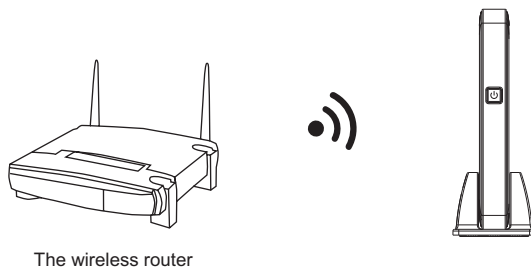
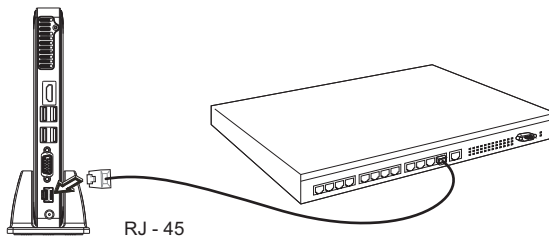

The wireless router

## B. Wireless network

With the embedded wireless network device, you can connect your PC to the Internet through the access point.

Note: To form a small-scale LAN for home use or office work, you need both the wireless network device embedded in the product and a wireless router.

- Start your wireless router, and make proper configurations for it in accordance with the operating instructions or instructions from the carrier.
- Start the WIFI wireless device through the operating system of the host.
- Based on the instructions of operating system on network construction, select the wireless network and make correct configurations for the software.



## V. Applications

### 1. Home Digital HD Theater

With good performance graphics chipset and integrated sound card, this product can support 1080 HD decoding. The HDMI port can be connected to power amplifier, speaker, LCD TV and other home entertainment equipment. You can create a home digital theater to experience your HD digital life.

This product can serve as the center for creating a home theater, with which you can select speaker, power amplifier (audio decoding), LCD display device (projector) and remote-control equipment on the basis of your own needs.

- With HDMI cable, you can connect the host to power amplifier. If the power amplifier is not available, you can connect it to audio decoder or directly connect it to LCD TV (projector), and then connect the audio output on the top of the host to the hi-fi equipment.
- Connect it to your LCD TV or projector.
- Connect it to the speakers.
- Connect and set up the wireless remote-control equipment.

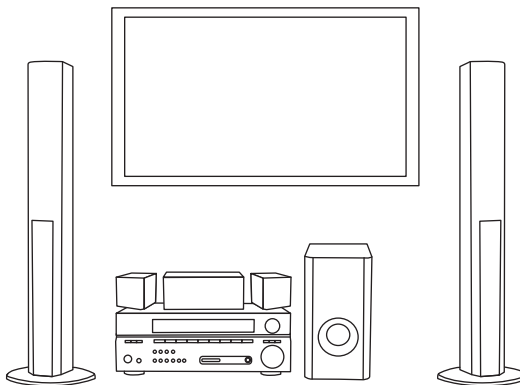

## 2. Office work/entertainment

Giada Mini PC is characterized by its book-like shape with ultra-thin structure, low power consumption, high performances, double-core CPU and high-performance display chip (subject to model). Because of its compact structure, it can be integrated into the books to create a mini office and an entertainment center in your study.

- To use the PC for office work in your study, you can select or buy from other sources the printer, scanner, digital camera, digital vidicon, USB game manipulator and so on. This product only supports USB interfaces.
- Printer: Connect the printer to the USB interface of the host.
- Scanner: Connect the scanner to the USB interface of the host.
- Digital device: Connect the digital device to the USB interface of the host through the cable.
- Game manipulator: Connect the game manipulator or other entertainment equipment to the USB interfaces of the host.

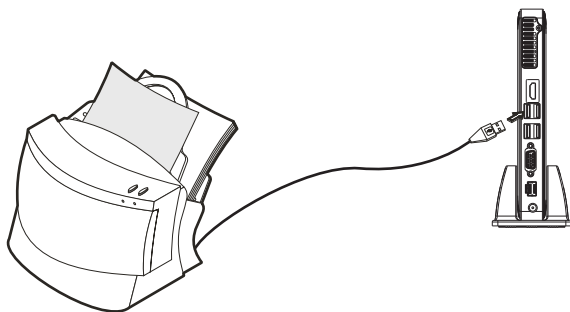

### 3. Household server/downloader

Because of the lower power consumption, improved radiation system and lower noise, this product can serve as a downloader or household server in the study or the living, thus creating a smart PC platform with ease.

- Configure your network in your house properly so that the host can access to LAN or Internet.
- When the downloading starts and the monitor may not be used for long, you can shut off the power to the monitor to save energy consumption.
- You can expand your system and enlarge its memory capacity by adding external equipment. Note: Pay attention to the warranty clauses and do not open the host to change the hard disk.

### 4. Mobile operation

Because of the light weight, you can carry Giada Mini PC with you and share it with your friend or family. You can also use it as a device for mobile office work after it is connected to the monitor.

- Before you move this product, make sure you have shut off the operating system and its power supply.
- Remove other external devices and cut off cabled network connection.
- If you need to go out with the PC, make sure you have carry the anti-sliding base and attached adapter (or other models with the same specification) with you.

## VI. Power supply and maintenance

### 1. Adapter

In order to avoid personal injury and ensure the normal operation of the product, please make sure the AC power you provide conforms to the specifications described on the sign at the back of the adapter. Use three-core receptacle and reliable grounding. In addition, you should also make sure the voltage from your local power matches the respective rated value of the monitor and other external equipment.

- It is recommended the attached adapter be used. If the attached adapter can't be used under some special circumstances, you must use a adapter with the same specification.
- Input Characteristics

Range of input voltage: 90Vac-264Vac, single phase

	Min.	Normal	Max.
Input Voltage	90Vac	100Vac~240Vac	264Vac
Input Frequency	47Hz	60Hz/50Hz	63Hz

- Output Characteristics

Static Output Characteristics <Vo & R+N>

Output Rail	Rated Load		Peak Load	Output Range	R+N
	Min.Load	Max.Load			
+12V	0.0A	5.0A	/	11.4V-12.6V	350mVp-p

## 2. Maintenance

As a high-tech product with sophisticated structure, Giada Mini PCs needs to be maintained with properly. Misuse or rough handling may result in damage or system failure.

- **Body**

Please do not randomly remove the protective film on the body of the host, and prevent sharp objects from scratching on it. Make sure the power supply to the host is cut off before cleaning the body. Never use wet cloth for cleaning. Otherwise, water drops or other conductive liquid may go into the host.

To clean the base of the host, you should first remove the host. At the time, you should put the host in a safe place where it won't slide down or fall onto the ground.

- **Handling**

**This product is an ultra-light PC**

Never place the product at the edge of the table. Otherwise, it may fall on the ground and be damaged.

Always check the peripheral equipment and the connection cables to see whether they are properly arranged, so that people might not be stumbled by the wire or equipment and equipment not damaged.

- **Radiation**

Radiation is of great significance for PCs. Please place the product in a proper position. Never block the air inlet and air outlet that are used for ventilation.

Do not place the product onto the bed, sofa or other soft objects for use. Otherwise, the vents might be blocked and machine dies because of the excessive heat.

- **Interfaces**

Never use other objects to jam the interfaces on the host, nor use sharp objects to scratch the pins. Otherwise, the pins might be damaged. If there is any poor contact, you can use a soft brush to dust the place.

## VII. Troubleshooting

Giada Mini PC was designed with the latest technologies and strictly tested before delivery. It can provide long service time during which few failures might occur. You may encounter some simple problems on setup, operation or system compatibility at times you use the product. In this part, we will present the information on how to identify the cause of a failure and how to solve the problems.

Identification: When your PC has a problem, please check it by referring the information provided below:

1. PC has no reaction after the host is powered on. Make sure the power is supplied to the host and the monitor, and check the power supply is normal running state. If the hardware has been upgraded, make sure the new hardware was properly and reliably installed. Check whether all signal cables are properly connected, including cables between the keyboard and host, and mouse and host.
2. Host is automatically shut off. Please check whether the power supply is cut off, or the power adapter is firmly inserted.
3. After the host is started, the start-up information appears. However, the operating system can't be loaded. The start-up order of setup tools is not compatible with the configuration of the PC, or a password is set for your operating system. In the latter case, you should enter the password to load the operating system.
4. Speaker sounds when the system is being electrified. Check whether there is any part inside the host, especially whether the hard disk and memory are properly installed. Note: The shell of the host should be opened only with the assistance of professionals from Giada.

5. When the system is started, it seems the set parameters of the host have been changed. It is possible the BIOS setup made at the time the system exited last time was not saved.
6. PC stops responding Press <Ctrl+Alt+Del> to terminate the program whose response is stopped. If the system can't be restored after a long time, you should press the power switch on the host to turn off the PC, and start it. Then check whether the newly installed hardware is compatible with your system.
7. PC runs slowly and dies frequently. Use virus-killing software to check whether the system is infected by computer virus. Check whether excessive programs are added when the computer is being started. They may temporarily occupy too many resources. If many programs are installed in your system and the system has not been optimized for a long time, it will also run slowly. In this case, you should run the optimization software programs for the disk, or run the third-party optimization software. If the problem still exists after above measures are taken, it is recommended that the operating system be re-installed.
8. Abnormal display and sound. If some software or game programs can't run normally, you should check whether the software failure is caused by wrong operation (including wrong installation of operating system and drive). Check whether the version of your DirectX is conforming.
9. Sound disappeared abruptly. Check whether the connection between power amplifier and speaker are reliable, and double click the volume icon to see whether the audio part is set as "mute".
10. Can't access to Internet. Check whether the network system is properly connected, or the wireless router runs normally. Check whether the drive for

the network equipment is properly installed and the related parameters are correctly set. Finally, make sure the ISP service is still valid.

11. System can't access the information on hard disk. Check whether the hard disk is infected by virus. Note whether the hard disk is detected during the self-detection process.
12. Blue screen and dead machine. Check whether the system is infected by virus. If the problem still exists, it is recommended that the operating system be re-installed.
13. PC can't recognize USB devices or USB devices can't run normally. Check whether these devices are properly installed (or the power is turned on), or the latest version of the drive for the device is installed.

If the problem can't be solved even after the above measures are taken, you may contact our customer service center or log in the official forum of Giada.

Please prepare the materials listed below before you contact so as to receive prompt service from us.

- True product name and model;
- Product code and its serial number;
- Date of purchase;
- Brief introduction of the problem on your PC;
- Information concerning the software and other external hardware.



[www.giadatach.com](http://www.giadatach.com)