

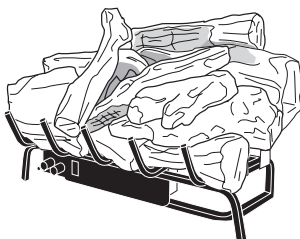

## VENTED DECORATIVE GAS LOG HEATER OWNER'S OPERATION AND INSTALLATION MANUAL



### MVO24VNA, MVO24VPA, MVO18VNA AND MVO18VPA

**WARNING:** If the information in this manual is not followed exactly, a fire or explosion may result causing property damage, personal injury or loss of life.

- Do not store or use gasoline or other flammable vapors and liquids in the vicinity of this or any other appliance.
- **WHAT TO DO IF YOU SMELL GAS**
  - Do not try to light any appliance.
  - Do not touch any electrical switch; do not use any phone in your building.
  - Immediately call your gas supplier from a neighbor's phone. Follow the gas supplier's instructions.
  - If you cannot reach your gas supplier, call the fire department.
- Installation and service must be performed by a qualified installer, service agency or the gas supplier.

**WARNING:** Improper installation, adjustment, alteration, service or maintenance can cause injury or property damage. Refer to this manual for correct installation and operational procedures. For assistance or additional information consult a qualified installer, service agency or the gas supplier.

**WARNING:** This appliance is for installation only in a solid-fuel burning masonry or UL127 factory-built fireplace, constructed of noncombustible material and connected to a working flue. (See page 6 for minimum flue opening.

**WARNING:** This is a gas-fired heater. It uses air (oxygen) from the room in which it is installed. Provisions for adequate combustion and ventilation air must be provided. Refer to the *National Fuel Gas Codes, ANSI Z233.1/NFPA 54, Section 5.3, Air for Combustion and Ventilation.*

This appliance may be installed in an aftermarket,\* permanently located, manufactured (mobile) home, where not prohibited by local codes.

This appliance is only for use with the type of gas indicated on the rating plate. This appliance is not convertible for use with other gases.

\* Aftermarket: Completion of sale, not for purpose of resale, from the manufacturer

**State of Massachusetts: The installation must be made by a licensed plumber or gas fitter in the Commonwealth of Massachusetts.**

## TABLE OF CONTENTS

Safety Information .....	3	Cleaning and Maintenance.....	12
Local Codes .....	4	Troubleshooting .....	13
Product Identification .....	5	Service Hints .....	17
Unpacking .....	5	Technical Service .....	17
Product Features .....	5	Replacement Parts .....	17
Installation .....	5	Accessories .....	17
Operating Appliance .....	10	Illustrated Parts Breakdown and Parts List .....	18
Wiring Diagram .....	11	Warranty Information .....	Back Cover
Inspecting Burners .....	12		

## SAFETY INFORMATION

**⚠ WARNING:** This product contains and/or generates chemicals known to the State of California to cause cancer or birth defects or other reproductive harm.

**⚠ WARNING:** Keep flue open when operating unit.

**IMPORTANT:** Read this owner's manual carefully and completely before trying to assemble, operate or service this log set. Improper use of this log set can cause serious injury or death from burns, fire, explosion, electrical shock and carbon monoxide poisoning.

**⚠ DANGER:** Carbon monoxide poisoning may lead to death!

**Carbon Monoxide Poisoning:** Early signs of carbon monoxide poisoning resemble the flu, with headaches, dizziness or nausea. If you have these signs, the log set may not be working properly. **Get fresh air at once!** Have log set serviced. Some people are more affected by carbon monoxide than others. These include pregnant women, people with heart or lung disease or anemia, those under the influence of alcohol and those at high altitudes.

**Natural & LP Gas:** Natural & LP gas are odorless. An odor-making agent is added to the gas. The odor helps you detect a gas leak. However, the odor added to the gas can fade. Gas may be present even though no odor exists.

Make certain you read and understand all warnings. Keep this manual for reference. It is your guide to safe and proper operation of this log set.

**⚠ WARNING:** Do not place log scraps or lava rocks on burner.

**⚠ WARNING:** Do not use a blower insert, heat exchanger insert or other accessory not approved for use with this appliance.

**⚠ WARNING:** Any change to this log set or its controls can be dangerous.

**⚠ WARNING:** This appliance is equipped for (natural or propane/LP) gas. Field conversion is not permitted.

**⚠ WARNING:** Do not allow fans to blow directly into the fireplace. Avoid any drafts that alter burner flame patterns.

**⚠ WARNING:** Installed decorative glass door enclosures must be fully opened when operating this gas appliance.

Due to high temperatures, the appliance should be located out of traffic and away from furniture and draperies.

**Do not place clothing or other flammable material on or near the appliance. Never place any objects on the appliance.**

**Appliance assembly becomes very hot when running. Keep children and adults away from hot surface to avoid burns or clothing ignition. Appliance will remain hot for a time after shutdown. Allow surface to cool before touching.**

**Carefully supervise young children when they are in the room with appliance. When using handheld remote accessory, keep selector switch in the OFF position to prevent children from turning on burners with remote.**

## SAFETY INFORMATION

### Continued

**You must operate this appliance with a fireplace screen in place. Make sure fireplace screen is closed before running appliance.**

**Keep the appliance area clear and free from combustible materials, gasoline and other flammable vapors and liquids.**

**Children and adults should be alerted to the hazard of high temperature and should stay away to avoid burns or clothing ignition.**

1. This appliance, as supplied, is only for use with the type of gas indicated on the rating plate. This appliance is not convertible for use with other gases.
2. Do not place propane/LP supply tank(s) inside the structure. Locate propane/LP supply tank(s) outdoors (propane/LP units only).
3. If you smell gas
  - shut off gas supply
  - do not try to light any appliance
  - do not touch any electrical switch; do not use any phone in your building
  - immediately call your gas supplier from a neighbor's phone. Follow the gas supplier's instructions
  - if you cannot reach your gas supplier, call the fire department
4. Never install the log set
  - in a recreational vehicle
  - where curtains, furniture, clothing or other flammable objects are less than 42 inches from the front, top or sides of the log set.
  - in high traffic areas
  - in windy or drafty areas
5. Before installing in a solid fuel burning fireplace, the chimney flue and firebox must be cleaned of soot, creosote, ashes and loose paint by a qualified chimney cleaner. Creosote will ignite if highly heated. Inspect chimney flue for damage. If damaged, repair flue before operating appliance.
6. This logset is designed to be smokeless. If logs ever appear to smoke, turn off appliance and call a qualified service person. **Note:** During initial operation, slight smoking could occur due to log curing and the burning of manufacturing residues. You may wish to add more ventilation by opening a window.
7. You must operate this log set with fireplace screen in place and fully closed. Unless provided by other means, screens shall have openings for introduction of combustion air.
8. If fireplace has glass doors, never operate with glass doors closed. If you operate heater with doors closed, heat buildup inside fireplace will cause glass to burst. Also if fireplace opening has vents at the bottom, you must open the vents before operating heater.
9. To reduce the creation of soot, follow the instructions in *Cleaning and Maintenance*, page 12.
10. Do not use a blower insert, heat exchanger insert or other accessory not approved for use with this log set.
11. The installation and provisions for combustion and ventilation air must conform with the *National Fuel Gas Codes, ANSI Z223.1/NFPA 54, Section 5.3, Air for combustion and Ventilation*.
12. Do not run heater
  - where flammable liquids or vapors are used or stored
  - under dusty conditions
13. Do not burn solid fuel in the fireplace after installing the log set. Do not use this log set to cook food or burn paper or other objects.
14. Log set becomes very hot when in use. Keep children and adults away from hot surface to avoid burns or clothing ignition. Log set will remain hot for a time after shutdown. Allow surface to cool before touching.
15. Carefully supervise young children when they are in the room with the log set.
16. Do not use heater if any part has been exposed to or under water. Immediately call a qualified service technician to inspect the room heater and to replace any part of the control system and any gas control which has been under water.
17. Turn log set off and let cool before servicing, installing or repairing. Only a qualified service person should install, service or repair log set.
18. Provide adequate clearances around air openings.

## LOCAL CODES

Install and use log set with care. Follow all local codes. In the absence of local codes, use the latest edition of the *National Fuel Gas Code ANSI Z223.1/NFPA 54\**  
\*Available from:

American National Standards Institute, Inc.  
1430 Broadway  
New York, NY 10018  
National Fire Protection Association, Inc.  
Battery march park  
Quincy, MA 02269

## PRODUCT IDENTIFICATION

**WARNING:** Failure to position the parts in accordance with these diagrams or failure to use only parts specifically approved with this appliance may result in property damage or personal injury.

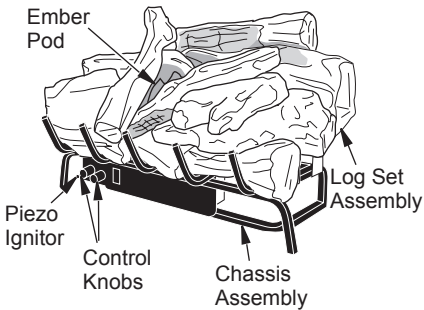

Figure 1 - Product Identification

## UNPACKING

**CAUTION:** Do not remove the data plates from the grate assembly. The data plates contain important warranty and safety information.

1. Remove log set assembly from carton. **IMPORTANT:** Do not pick up assembly by logs. This could damage the unit. Always handle assembly by grate.
2. Remove all protective packaging applied to log set for shipment.
3. Check all items for any shipping damage. If damaged, promptly inform dealer where you bought appliance.

## PRODUCT FEATURES

This unitized gas log set is tested and approved to ANSIZ21.60-2003 and CSA 2.2-2003 as a vented decorative appliance.

This unit has a piezo ignitor. This system requires no matches, batteries or other sources to light appliance.

An ON/OFF remote is available for use with this vented log set (see *Accessories*, page 17). A wall thermostat or hand-held thermostat remote is not to be used with vented decorative appliances.

## INSTALLATION

**WARNING:** A qualified service person must install heater. Follow all local codes.

**WARNING:** Before installing in a solid fuel burning fireplace, the chimney flue and firebox must be cleaned of soot, creosote, ashes and loose paint by a qualified chimney cleaner. Creosote will ignite if highly heated. A dirty chimney flue may create and distribute soot within the house. Inspect chimney flue for damage. If damaged, repair flue damper before operating appliance.

**CAUTION:** This heater creates warm air currents. These currents move heat to wall surfaces next to heater. Installing heater next to vinyl or cloth wall coverings or operating heater where impurities (such as, but not limited to, tobacco smoke, aromatic candles, cleaning fluids, oil or kerosene lamps, etc.) in the air exist, may discolor walls or cause odors.

**NOTICE:** Installation, service and repair of this appliance must be performed by a qualified installer, service agency, company or gas supplier experienced with this type of gas appliance. Only factory authorized components listed in these instructions may be used in accordance with the manufacturer's instructions and all codes and requirements of the authority having jurisdiction. Any modifications to or use of unauthorized components or accessory items will void the manufacturer's warranty and may result in a hazardous condition.

# INSTALLATION

*Continued*

## CHECK GAS TYPE

Use the correct gas type (natural or propane/LP) for your unit. If your gas supply is not correct, do not install in fireplace. Call dealer where you bought the appliance for proper type of appliance.

**⚠ WARNING: This appliance is equipped for (natural or propane/LP) gas. Field conversion is not permitted.**

## INSTALLATION AND CLEARANCES

Figure 2 shows technical information regarding the installation of your gas log set. Please make sure all specifications shown are applicable before installation is attempted.

SPECIFICATIONS (W.C.)				
FUEL INLET PRESSURE			MANIFOLD PRESSURE	
	Min.	Max.		
NG	7"	10.5"	3.5"	
LP	11"	14"	10"	

Figure 2 - Technical Information Chart

## FLUE OPENING SPECIFICATIONS

Note: This vented appliance must be installed only in a solid-fuel burning or UL127 factory-built fireplace constructed of noncombustible material and connected to a working flue. The fireplace chimney must have a permanent vent opening to outside with minimum openings shown in Figure 3.

LOG SIZING REQUIREMENTS					
LOG SIZE	MINIMUM FIREBOX SIZE				
	HEIGHT	DEPTH	FRONT WIDTH	REAR* WIDTH	MIN. FLUE SIZE
18"	20"	14"	25"	20.5"	6.5"
24"	20"	14"	29"	24.5"	6.5"

\*Measured at 14" depth

Figure 3 - Sizes and Clearances

## VENTING SPECIFICATIONS FOR INSTALLATION

The fireplace chimney flue and vent must be drafting properly. To check the vent for proper drafting: Light a tightly rolled newspaper on one end and place it at the inside front edge of the fireplace.

Observe the smoke and be sure the vent is properly drawing it up the chimney. If the smoke spills out into the room, extinguish the flame and remove any obstruction until proper venting is achieved.

The chimney flue damper must be fixed open to provide a minimum of 32 square inch of free air opening at all times during operation of the log set. A damper clamp is included to secure the damper.

The minimum flue sizes shown in Figure 3 are based on a 6' chimney height using round pipe. Your minimum flue size will vary based on input rate and chimney height. Refer to the *National Fuel Gas Code ANSI Z223.1/NFPA 54, Section 6.6* for details.

## INSTALLING DAMPER CLAMP

Secure the damper stop clam to the edge of the damper as shown in Figure 4. If for any reason this clamp doesn't work on your fireplace, another suitable clamp or permanent stop must be installed, or the damper blade must be cut or removed.

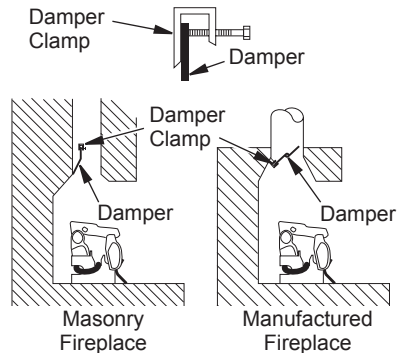

Figure 4 - Attaching Damper Clamp

## INSTALLING REMOTE CONTROL ACCESSORY BRACKET

If installing optional remote control accessory you will need to install the remote accessory bracket for the receiver.

Use screws provided to attach bracket to valve bracket as shown in Figure 5.

Follow installation instructions included with remote accessory.

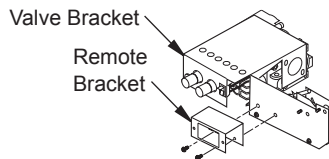

Figure 5 - Attaching Remote Bracket to Valve Bracket

# INSTALLATION

Continued

## INSTALLING APPLIANCE

**⚠ WARNING:** Special care is required if you are installing the unit into a sunken fireplace. You must raise the fireplace floor to allow access to gas log controls. This will insure adequate air flow and guard against sooting. Raise the fireplace floor using noncombustible material.

**⚠ CAUTION:** Do not pick up appliance assembly by logs. This could damage unit. Only handle assembly by grate.

**IMPORTANT:** Make sure appliance is level. If unit is not level it will not work properly.

Center the appliance in the fireplace. Make certain the grate front feet sit inside the front edge of the fireplace and that there is adequate clearance around the appliance for access and operation.

**Note:** The installation of appliances designed for manufactured home (U.S. only) or mobile home installation must conform with the standard *CAN/CSA Z240, Mobile Housing*, in Canada, or with the *Manufactured Home Construction and Safety Standard, Title 24 CFR, Part 3280*, in the United States, or when such a standard is not applicable, *ANSI/NCSBCSA225.1/NFPA501A, Manufactured Home Installations Standard*.

## CONNECTING TO GAS SUPPLY

**⚠ WARNING:** A qualified service person must connect heater to gas supply. Follow all local codes.

**⚠ WARNING:** This appliance requires a 3/8" NPT (National Pipe Thread) inlet connection to the control valve.

**⚠ CAUTION:** Never connect propane/LP unit directly to the propane/LP supply. This unit requires an external regulator (not supplied). Install the external regulator between the unit and the propane/LP supply.

**⚠ WARNING:** Never connect natural gas fireplace to private (non-utility) gas wells. This gas is commonly known as wellhead gas.

### Installation Items Needed

Before installing heater, make sure you have the items listed below.

- approved flexible gas hose and fittings (supplied with appliance -if allowed by local codes)
- external regulator (propane/LP models only)
- piping (check local codes)
- sealant (resistant to propane/LP gas)
- equipment shutoff valve\*
- test gauge connection\*
- sediment trap
- tee joint
- pipe wrench

\* A CSA design-certified equipment shutoff valve with 1/8" NPT tap is an acceptable alternative to test gauge connection. Purchase the optional CSA design-certified equipment shutoff valve from your dealer. See *Accessories*, page 17.

For propane/LP units, the installer must supply an external regulator. The external regulator will reduce incoming gas pressure. You must reduce incoming gas pressure to between 11 and 14 inches of water. If you do not reduce incoming gas pressure, control valve damage could occur. Install external regulator with the vent pointing down as shown in Figure 6. Pointing the vent down protects it from freezing rain or sleet.

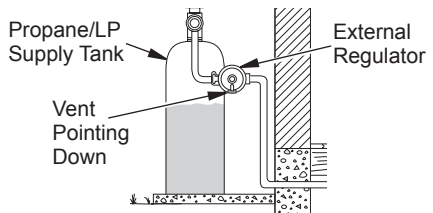

Figure 6 - External Regulator with Vent Pointing Down

## INSTALLATION

*Continued*

**CAUTION:** Use only new, black iron or steel pipe. Internally-tinned copper tubing may be used in certain areas. Check your local codes. Use pipe of 1/2" diameter or greater to allow proper gas volume to heater. If pipe is too small, undue loss of volume will occur.

Installation must include an equipment shutoff valve, union and plugged 1/8" NPT tap. Locate NPT tap within reach for test gauge hook up. NPT tap must be upstream from log set (see Figure 7).

**IMPORTANT:** Install equipment shutoff valve in an accessible location. The equipment shutoff valve is for turning on or shutting off the gas to the appliance.

Apply pipe joint sealant lightly to male NPT threads. This will prevent excess sealant from going into pipe. Excess sealant in pipe could result in clogged heater valves.

**WARNING:** Use pipe joint sealant that is resistant to liquid petroleum (LP) gas.

We recommend that you install a sediment trap in supply line as shown in Figure 7. Locate sediment trap where it is within reach for cleaning. Install in piping system between fuel supply and appliance. Locate sediment trap where trapped matter is not likely to freeze. A sediment trap traps moisture and contaminants. This keeps them from going into heater controls. If sediment trap is not installed or is installed wrong, heater may not run properly.

**CAUTION:** Avoid damage to gas control. Hold gas control with wrench when connecting it to gas piping and/or fittings.

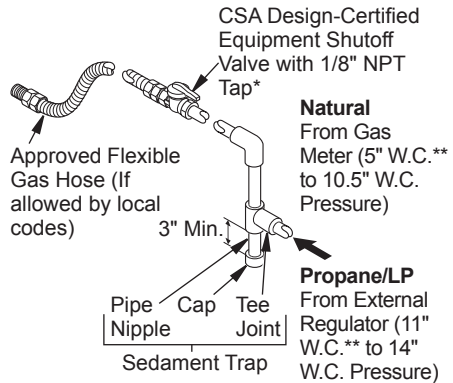

**Figure 7 - Gas Connection**

\* Purchase the optional CSA design-certified shutoff valve from your dealer. See *Accessories*, page 17.

\*\* Minimum inlet pressure for purpose of input adjustment.

### CHECKING GAS CONNECTIONS

**WARNING:** Test all gas piping and connections for leaks after installing or servicing. Correct all leaks at once.

**WARNING:** Never use an open flame to check for a leak. Apply a noncorrosive leak detection fluid to all joints. Bubbles forming show a leak. Correct all leaks at once.

**CAUTION:** Make sure external regulator has been installed between propane/LP supply and appliance. See guidelines under *Connecting to Gas Supply*, page 7.

### PRESSURE TESTING GAS SUPPLY PIPING SYSTEM

**Test Pressures In Excess Of 1/2 PSIG (3.5 kPa)**

1. Disconnect appliance with its appliance main gas valve (control valve) and equipment shutoff valve from gas supply piping system. Pressures in excess of 1/2 psig will damage control valve.
2. Cap off open end of gas pipe where equipment shutoff valve was connected.



# INSTALLATION

## Continued

3. Pressurize supply piping system by either opening propane/LP supply tank valve for propane/LP gas or opening main gas valve located on or near gas meter for natural gas or using compressed air.
4. Check all joints of gas supply piping system. Apply noncorrosive leak detection fluid to all joints. Bubbles forming show a leak.
5. Correct all leaks at once.
6. Reconnect heater and equipment shutoff valve to gas supply. Check reconnected fittings for leaks.

### Test Pressures Equal To or Less Than 1/2 PSIG (3.5 kPa)

1. Close equipment shutoff valve (see Figure 8).
2. Pressurize supply piping system by either opening propane/LP supply tank valve for propane/LP gas or opening main gas valve located on or near gas meter for natural gas or using compressed air.
3. Check all joints from gas meter to equipment shutoff valve for natural gas or propane/LP supply to equipment shutoff valve for propane/LP (see Figure 9 or 10). Apply noncorrosive leak detection fluid to all joints. Bubbles forming show a leak.
4. Correct all leaks at once.

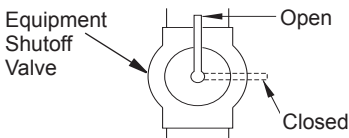

Figure 8 - Equipment Shutoff Valve

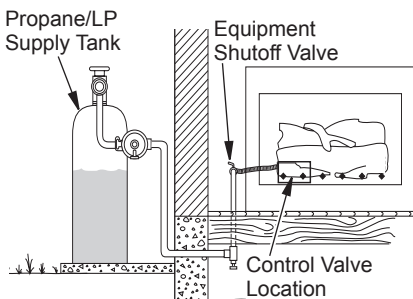

Figure 9 - Checking Gas Joints (Propane/LP Gas Only)

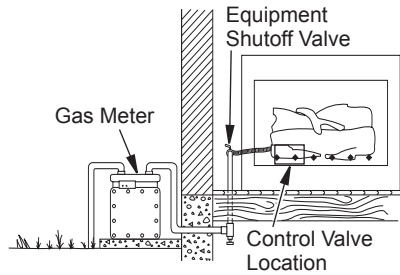

Figure 10 - Checking Gas Joints (Natural Gas Only)

### Pressure Testing Appliance Gas Connections

1. Open equipment shutoff valve (see Figure 8.)
2. Open main gas valve located on or near gas meter for natural gas or open propane/LP supply tank valve.
3. Make sure control knob of appliance is in the OFF position.
4. Check all joints from equipment shutoff valve to gas control (see Figure 9 or 10). Apply noncorrosive leak detection fluid to all joints. Bubbles forming show a leak.
5. Correct all leaks at once.
6. Light appliance (see *Operating Appliance*, page 10) Check all other internal joints for leaks.
7. Turn off appliance.

### PLACEMENT OF LOOSE EMBERS

**CAUTION:** Do not place any loose embers around pilot assembly.

Two bags of loose embers are provided with this unit. For this installation use the embers that are approximately 1" square in size. If needed, larger embers can be broken to size. These embers aid in concealing the burner pan, directing flames through the ember bed, quiet operation of the unit and gives a natural random flame pattern (see Figure 11, page 10).

Place embers as follows:

1. Place embers around the center ember bed or ember pod.
2. Place individual embers on their edge (not flat) along the top of the burner pan. This aids in directing flames from the burner through the ember bed.

**Note:** Too many embers or embers placed flat along burner pan can suppress the flames.

# INSTALLATION

## Continued

- When unit is lit, check flames for random appearance and ember bed glowing red-orange in color (see *Burner Flame Pattern*, page 12). If this is not happening, either add, remove or reposition loose embers. **IMPORTANT:** Turn unit off and let cool before repositioning loose embers.



Figure 11 - Placement of Embers

## OPERATING APPLIANCE

**FOR YOUR SAFETY  
READ BEFORE LIGHTING**

**⚠ WARNING: Keep flue open when operating unit.**

**⚠ WARNING: If you do not follow these instructions exactly, a fire or explosion may result causing property damage, personal injury or loss of life.**

- This appliance has a pilot which must be lighted with a piezo ignitor. When lighting the pilot, follow these instructions exactly.
- BEFORE LIGHTING** smell all around the appliance area for gas. Be sure to smell next to the floor because some gas is heavier than air and will settle on the floor.

### WHAT TO DO IF YOU SMELL GAS

- Do not try to light any appliance.
- Do not touch any electric switch; do not use any phone in your building.
- Immediately call your gas supplier from a neighbor's phone. Follow the gas supplier's instructions.
- If you cannot reach your gas supplier, call the fire department.

- Use only your hand to push in or turn gas control knob. Never use tools. If the knob will not push in or turn by hand, do not try to repair it, call a qualified technician. Force or attempted repair may result in a fire.

- Do not use this appliance if any part has been under water. Immediately call a qualified service technician to inspect the appliance and to replace any part of the control system and any gas control which has been under water.

## LIGHTING INSTRUCTIONS

- STOP!** Read the safety information, column 1.
- Make sure switch is in OFF position.
- Be sure gas line shut-off valve is OPEN.
- Press in and turn control knob clockwise to the OFF position (see Figure 12).  
**Note:** Knob cannot be turned from PILOT to OFF unless knob is pushed in slightly. **DO NOT FORCE.**
- Wait five (5) minutes to clear out any gas. If you then smell gas, STOP! Follow "B" in the safety information in column 1. If you don't smell gas, go on the next step.
- Press in and turn control knob counterclockwise to the PILOT position. Press in control knob for five (5) seconds (see Figure 12).
- With control knob pressed in, press and release ignitor button. This will light pilot. If needed, keep pressing ignitor button until pilot lights.  
**Note:** If pilot does not stay lit, contact a qualified service person or gas supplier for repairs.
- Keep control knob pressed in for 30 seconds after lighting pilot. After 30 seconds, release control knob.
  - If control knob does not pop out when released, contact a qualified service person or gas supplier for repairs.**Note:** If pilot goes out, repeat steps 4 through 8.
- Slightly push in and turn control knob counterclockwise to the ON position.

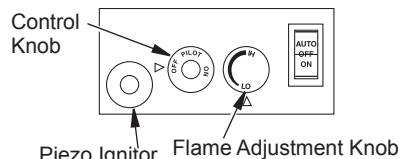

Figure 12 - Setting Control Knobs

# OPERATING APPLIANCE

*Continued*

10. Wait one minute and move switch to the ON position to light burner. **Note:** AUTO is only functional when using optional remote control accessory.
11. Set flame adjustment knob to any level between HI and LO.

## TO TURN OFF GAS TO APPLIANCE

1. Push switch into OFF position. The pilot will remain lit for normal service.
2. Access control knobs.
3. Depress gas control knob slightly and turn clockwise to OFF. Do not force.

## OPTIONAL HAND-HELD REMOTE OPERATION

**Note:** Remote control accessory must be purchased separately (see *Accessories*, page 17). Follow instructions included with the remote control.

**NOTICE:** You must light the pilot before using the hand-held remote control unit. See *Lighting Instructions* on page 10.

After lighting, let pilot flame burn for about one minute. Turn control knob to ON position. Adjust flame adjustment knob anywhere between HI and LO. Flip AUTO/OFF/ON switch to AUTO. Slide the selector switch to the REMOTE position (see Figure 13). **Note:** The burner may light if hand-held remote was on when selector switch was last turned off. You can now turn the burner on and off with the hand-held remote control unit.

Control Knob

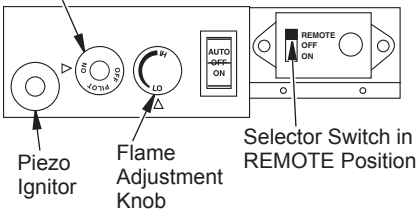

**Figure 13 - Setting the Selector Switch, Control Knob and Flame Adjustment Knob for Remote Operation**

**IMPORTANT:** Do not leave the selector switch in the REMOTE or ON position when the pilot is not lit. This will drain the battery.

## ON/OFF SERIES (MODEL GHRCB)

Hold the control button on the hand-held remote until burner turns on. Hold the control button again until burner turns off (see Figure 14).

To Lock press both buttons on hand-held remote control until light stops flashing. Hand-held remote control is now locked. If the fire is on it will be turned off automatically. In the locked state, the light will not light up when any button is pressed.

To Unlock press both buttons together on hand-held remote control until the light stops flashing. The hand-held remote is now unlocked.

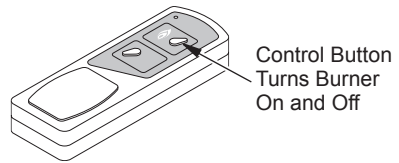

**Figure 14 - On/Off Hand-Held Remote Control Unit (GHRCB)**

## WIRING DIAGRAM

When Using Remote

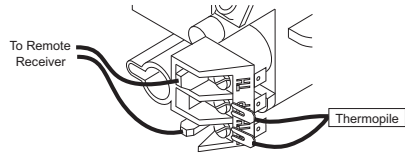

## INSPECTING BURNERS

Check pilot flame pattern and burner flame patterns often.

### PILOT FLAME PATTERN

You can view the pilot light through the pilot viewing hole on the pilot bracket. This is located under the front grate bar on the right side of the log set.

Figure 15 shows a correct pilot flame pattern. Figure 16 shows an incorrect pilot flame pattern. The incorrect pilot flame is not touching the thermocouple. This will cause the thermocouple to cool. When the thermocouple cools, the appliance will shut down.

If pilot flame pattern is incorrect, as shown in Figure 16

- turn appliance off (see *To Turn Off Gas to Appliance*, page 11)
- see *Troubleshooting*, page 13

**Note:** The pilot flame on natural gas units will have a slight curve but flames should be blue and have no yellow or orange color.



**Figure 15 - Correct Pilot Flame Pattern**  
(Your pilot may vary from pilots shown)

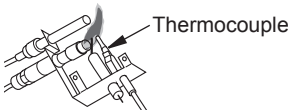
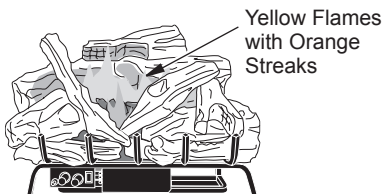

**Figure 16 - Incorrect Pilot Flame Pattern**  
(Your pilot may vary from pilots shown)

### BURNER FLAME PATTERN

Figure 17 shows correct burner flame pattern.

**NOTICE: Do not mistake orange flames with yellow tipping. Dirt or other fine particles are burned by appliance, causing brief patches of orange flame.**



**Figure 17 - Correct Burner Flame Pattern**

If burner flame pattern is incorrect, as shown in Figure 18.

- turn appliance off (see *To Turn Off Gas to Appliance*, page 10)
- see *Troubleshooting*, page 13

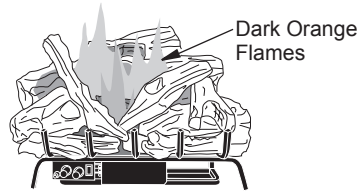

**Figure 18 - Incorrect Burner Flame Pattern**

## CLEANING AND MAINTENANCE

**WARNING:** Turn off the appliance and allow to cool before cleaning.

**CAUTION:** You must keep control areas, burners and circulating air passageways of fireplace clean. Inspect these areas of fireplace before each use. Have fireplace and chimney (if applicable) inspected yearly by a qualified service person. Fireplace may need more frequent cleaning due to excessive lint from carpeting, bedding material, etc.

Only limited cleaning will be required under normal use of this appliance. Dust the front grate and top of receiver/valve. Do not use cleaning fluids to clean logs or any other part of the appliance.

If, after a period of use, the flames start to exhibit unusual shapes and behavior or the burner fails to ignite smoothly, then the burner holes may require some cleaning. If this happens, we recommend that you contact your nearest authorized service technician to get the appliance serviced.

- Keep area around log set clean and clear of debris.
- Periodically inspect the air mixer and burner tube for foreign matter blocking the air inlet and flame holes.
- Once every year a qualified agency or certified chimney sweep should examine and clean the venting system of the fireplace.

## TROUBLESHOOTING

**⚠ WARNING:** Turn off appliance and let cool before servicing. Only a qualified service person should service and repair heater.

**⚠ CAUTION:** Never use a wire, needle or similar object to clean ODS/pilot. This can damage ODS pilot unit.

*Note:* All troubleshooting items are listed in order of operation.

OBSERVED PROBLEM	POSSIBLE CAUSE	REMEDY
When ignitor button is pressed, there is no spark at ODS/pilot	<ol style="list-style-type: none"> <li>1. Ignitor electrode not connected to ignitor cable</li> <li>2. Ignitor cable pinched or wet</li> <li>3. Broken ignitor cable</li> <li>4. Bad piezo ignitor</li> <li>5. Ignitor electrode positioned wrong or broken</li> </ol>	<ol style="list-style-type: none"> <li>1. Reconnect ignitor cable</li> <li>2. Free ignitor cable if pinched by any metal or tubing. Keep ignitor dry</li> <li>3. Replace ignitor cable</li> <li>4. Replace piezo ignitor</li> <li>5. Replace pilot assembly for remote-ready units; replace ignitor electrode for variable manually controlled units</li> </ol>
When ignitor button is pressed in there is spark at ODS/pilot but no ignition	<ol style="list-style-type: none"> <li>1. Gas supply turned off or equipment shutoff valve closed</li> <li>2. Control knob not in PILOT position</li> <li>3. Control knob not pressed in while in PILOT position</li> <li>4. Air in gas lines when installed</li> <li>5. Depleted gas supply (propane/LP only)</li> <li>6. ODS/pilot is clogged</li> <li>7. Gas regulator setting is incorrect</li> </ol>	<ol style="list-style-type: none"> <li>1. Turn on gas supply or open equipment shutoff valve</li> <li>2. Turn control knob to PILOT position</li> <li>3. Press in control knob while in PILOT position</li> <li>4. Continue holding down control knob. Repeat igniting operation until air is removed</li> <li>5. Contact local propane/LP gas company</li> <li>6. Clean ODS/pilot (see <i>Cleaning and Maintenance</i>, page 12) or replace ODS/pilot assembly</li> <li>7. Replace gas regulator</li> </ol>

# TROUBLESHOOTING

*Continued*

OBSERVED PROBLEM	POSSIBLE CAUSE	REMEDY
ODS/pilot lights but flame goes out when control knob is released	<ol style="list-style-type: none"> <li>1. Control knob not fully pressed in</li> <li>2. Control knob not pressed in long enough</li> <li>3. Safety interlock system has been triggered</li> <li>4. Equipment shutoff valve not fully open</li> <li>5. Pilot flame not touching thermocouple, which allows thermocouple to cool, causing pilot flame to go out. This problem could be caused by one or both of the following:               <ol style="list-style-type: none"> <li>A) Low gas pressure</li> <li>B) Dirty or partially clogged ODS/Pilot</li> </ol> </li> <li>6. Thermocouple connection loose at control valve</li> <li>7. Thermocouple damaged</li> <li>8. Control valve damaged</li> </ol>	<ol style="list-style-type: none"> <li>1. Press in control knob fully</li> <li>2. After ODS/pilot lights, keep control knob pressed in for 30 seconds</li> <li>3. Wait one minute for safety interlock system to reset. Repeat ignition operation</li> <li>4. Fully open equipment shutoff valve</li> <li>5. A) Contact local natural or propane/LP gas company  B) Clean ODS/pilot (see <i>Cleaning and Maintenance</i>, page 12) or replace ODS/pilot assembly</li> <li>6. Hand tighten until snug, then tighten 1/4 turn more</li> <li>7. Replace pilot assembly</li> <li>8. Replace control valve</li> </ol>
Burner does not light after ODS/pilot is lit	<ol style="list-style-type: none"> <li>1. Inlet gas pressure is too low</li> <li>2. Burner orifice(s) clogged</li> <li>3. Burner orifice(s) diameter too small</li> <li>4. Remote selector in OFF position (Remote use only)</li> <li>5. Wire disconnected from gas control (Remote use only)</li> </ol>	<ol style="list-style-type: none"> <li>1. Contact local natural or propane/LP gas company</li> <li>2. Clean burner(s) (see <i>Cleaning and Maintenance</i>, page 12) or replace burner orifice(s)</li> <li>3. Replace burner orifice(s)</li> <li>4. Put remote selector in ON position</li> <li>5. See <i>Wiring Diagram</i>, page 11)</li> </ol>
Delayed ignition of burner	<ol style="list-style-type: none"> <li>1. Manifold pressure is too low</li> <li>2. Burner orifice(s) clogged</li> </ol>	<ol style="list-style-type: none"> <li>1. Contact local natural or propane/LP gas company</li> <li>2. Clean burner(s) (see <i>Cleaning and Maintenance</i>, page 12)</li> </ol>
Burner backfiring during combustion	<ol style="list-style-type: none"> <li>1. Burner orifice is clogged or damaged</li> <li>2. Damaged burner</li> <li>3. Gas regulator defective</li> </ol>	<ol style="list-style-type: none"> <li>1. Clean burner (see <i>Cleaning and Maintenance</i>, page 12) or replace burner orifice</li> <li>2. Replace damaged burner</li> <li>3. Replace gas regulator</li> </ol>

---

## TROUBLESHOOTING

*Continued*

<b>OBSERVED PROBLEM</b>	<b>POSSIBLE CAUSE</b>	<b>REMEDY</b>
Dark orange flame in burner during burner combustion	<ol style="list-style-type: none"><li>1. Not enough air</li><li>2. Gas regulator defective</li></ol>	<ol style="list-style-type: none"><li>1. Check burner(s) for dirt and debris. If found, clean burner(s) (see <i>Cleaning and Maintenance</i>, page 12)</li><li>2. Replace gas regulator</li></ol>
Slight smoke or odor during initial operation	<ol style="list-style-type: none"><li>1. Residues from manufacturing processes and log curing</li></ol>	<ol style="list-style-type: none"><li>1. Problem will stop after a few hours of operation</li></ol>
Produces a whistling noise when burners are lit	<ol style="list-style-type: none"><li>1. Turning control knob to HI position when burners are cold</li><li>2. Air is gas line</li><li>3. Air passageways on heater blocked</li><li>4. Dirty or partially clogged burner orifice(s)</li></ol>	<ol style="list-style-type: none"><li>1. Turn control knob to LO position and let warm up for a minute</li><li>2. Operate burners until air is removed from line. Have gas line checked by local natural or propane/LP gas company.</li><li>3. Observe minimum installation clearances (see page 6)</li><li>4. Clean burners (see <i>Cleaning and Maintenance</i>, page 12) or replace burner orifice(s)</li></ol>
White powder residue forming within burner box or on adjacent walls or furniture	<ol style="list-style-type: none"><li>1. When heated, vapors from furniture polish, wax, carpet cleaners, etc, turn into white powder residue</li></ol>	<ol style="list-style-type: none"><li>1. Heat turned off when using furniture polish, wax, carpet cleaners or similar products</li></ol>

# TROUBLESHOOTING

Continued



**WARNING: If you smell gas**

- Shut off gas supply.
- Do not try to light any appliance.
- Do not touch any electrical switch; do not use any phone in your building.
- Immediately call your gas supplier from a neighbor's phone. Follow the gas supplier's instructions.
- If you cannot reach your gas supplier, call the fire department.

*IMPORTANT:* Operating appliance where impurities in air exist may create odors. Cleaning supplies, paint, paint remover, cigarette smoke, cements and glues, new carpet or textiles, etc., create fumes. These fumes may mix with combustion air and create odors. These odors will disappear over time.

OBSERVED PROBLEM	POSSIBLE CAUSE	REMEDY
Appliance produces a clicking/ticking noise just after burners are lit or shut off	1. Metal expanding while heating or contracting while cooling	1. This is common with most appliances. If noise is excessive, contact qualified service person
Appliance produces unwanted odors	1. Appliance burning vapors from paint, hair spray, glues, cleaners, chemicals, new carpet, etc. (See <i>IMPORTANT</i> statement above) 2. Low fuel supply (propane/LP only) 3. Gas leak. <b>See Warning statement at top of page</b>	1. Open window to ventilate room. Stop using odor causing products while appliance is running 2. Refill supply tank (propane/LP only) 3. Locate and correct all leaks (see <i>Checking Gas Connections</i> , page 8)
Appliance shuts off in use	1. Not enough fresh air is available 2. Low line pressure 3. Pilot is partially clogged	1. Open window and/or door for ventilation 2. Contact local natural or propane/LP gas company 3. Clean ODS/pilot (see <i>Cleaning and Maintenance</i> , page 12)
Gas odor even when control knob is in OFF position	1. Gas leak. <b>See Warning statement at top of page</b> 2. Control valve or gas control defective	1. Locate and correct all leaks (see <i>Checking Gas Connections</i> , page 8) 2. Replace control valve or gas control
Gas odor during combustion	1. Foreign matter between control valve and burner 2. Gas leak. <b>See Warning statement at top of page</b>	1. Take apart gas tubing and remove foreign matter 2. Locate and correct all leaks (see <i>Checking Gas Connections</i> , page 8)



## SERVICE HINTS

### When Gas Pressure is Too Low

- pilot will not stay lit
- burners will have delayed ignition
- propane/LP gas supply may be low

You may feel your gas pressure is too low. If so, contact your local propane/LP or natural gas supplier.

## TECHNICAL SERVICE

You may have further questions about installation, operation or troubleshooting. If so, contact DESA's Technical Service Department at 1-866-672-6040. When calling please have your model and serial numbers of your heater ready.

You can also visit DESA's technical services web site at [www.desatech.com](http://www.desatech.com).

## REPLACEMENT PARTS

*Note:* Use only original replacement parts. This will protect your warranty coverage for parts replaced under warranty.

### PARTS UNDER WARRANTY

Contact authorized dealers of this product. If they can't supply original replacement part(s), call DESA's Technical Service Department at 1-866-672-6040. When calling DESA, have ready

- your name and address
- model and serial numbers of your log set
- how log set was malfunctioning
- type of gas used (propane/LP or natural gas)
- purchase date

Usually, we will ask you to return the part to the factory.

### PARTS NOT UNDER WARRANTY

Contact authorized dealers of this product. If they can't supply original replacement part(s), call DESA at 1-866-672-6040 for referral information. When calling DESA, have ready

- model number of your log set
- the replacement part number

## ACCESSORIES

Purchase these appliances from your local dealer. If they can not supply these accessories, call DESA at 1-866-672-6040 for referral information. You can also write to the address listed on the back page of this manual.

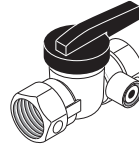

### EQUIPMENT SHUTOFF VALVE GA5010

Equipment shutoff valve with 1/8" NPT tap. Fits 1/2" pipe.

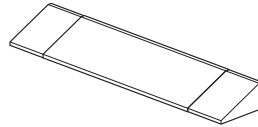

### FIREPLACE HOOD

**Black - GA6050**  
**Brass - GA6052**  
**Antique Brass - GA6053**

Helps deflect heat away from mantel or wall above fireplace. Fits opening 28" to 48" wide.

### DAMPER CLAMP - GA6080 (Not Shown)

Permanently opens chimney flue damper for vented operation.

### LAVA ROCK - GA6060 (Not Shown)

Order when additional rock is desired (1.8 lb. bag)

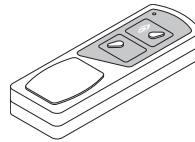

### RECEIVER AND HAND-HELD REMOTE CONTROL KIT - GHRCB

Allows the gas log heater to be turned on and off using a hand-held remote control.

### CLEANING KIT - GCK (Not Shown)

Your vented gas appliance requires regular cleaning and maintenance to prevent performance problems. This kit gives you the tools and instructions to make it easy to clean all critical areas of your appliance.

# ILLUSTRATED PARTS BREAKDOWN

MVO24VNA, MVO24VPA  
MVO18VNA, MVO18VPA

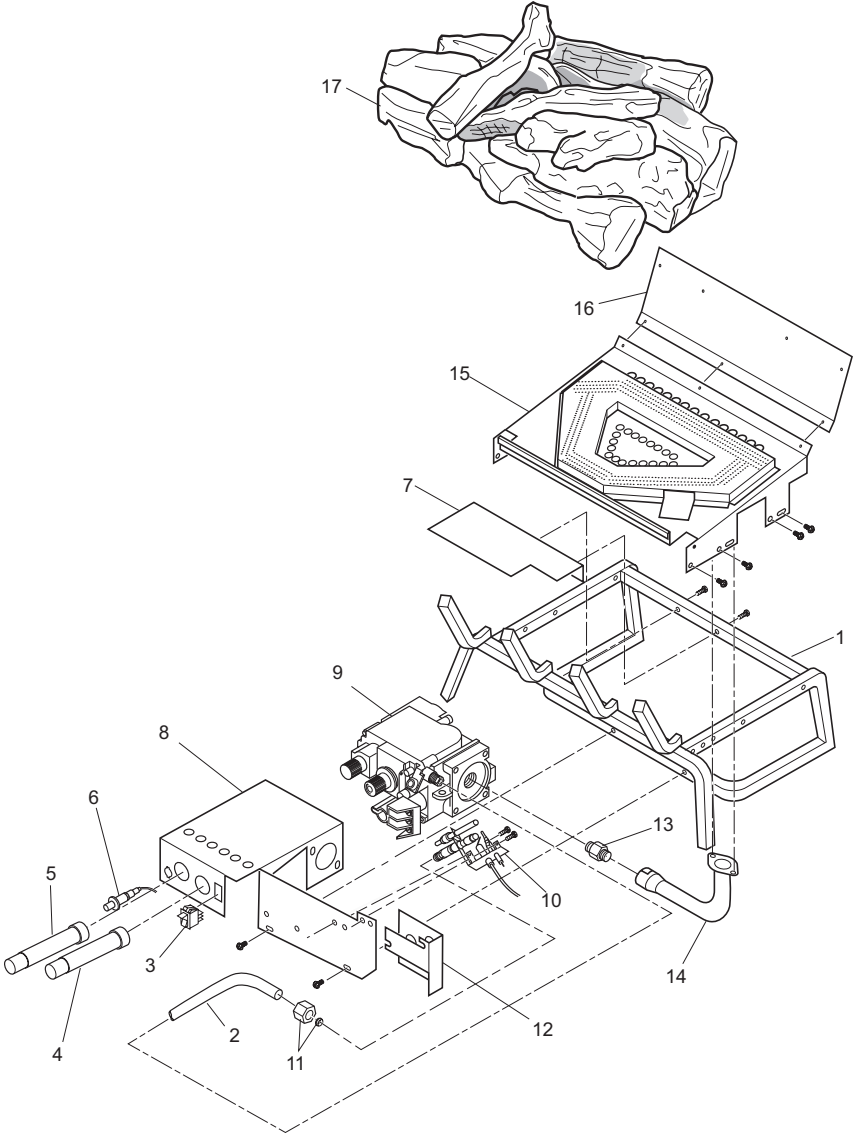

## PARTS LIST

This list contains replaceable parts used in your heater. When ordering parts, follow the instructions listed under *Replacement Parts* on page 17 of this manual.

KEY NO.	PART NUMBER				DESCRIPTION	QTY.
	MVO24VNA	MVO24VPA	MVO18VNA	MVO18VPA		
1	111793-01	111793-01	111808-02	111808-02	Grate	1
2	111817-02	111817-02	111817-02	111817-02	Flexible Tube	1
3	099998-01	099998-01	099998-01	099998-01	Fan Switch	1
4	103784-02	103784-02	103784-02	103784-02	Knob Extension (HI/LOW)	1
5	103784-01	103784-01	103784-01	103784-01	Knob Extension (ON/OFF)	1
6	097159-04	097159-04	097159-04	097159-04	Piezo Ignitor	1
7	114942-01	114942-01	114942-01	114942-01	Heat Shield	1
8	111796-01	111796-01	111796-01	111796-01	Valve Bracket	1
9	111807-01	111807-02	111807-01	111807-02	Valve	1
10	112376-01	103778-01	112376-01	103778-01	Pilot Assembly	1
11	111828-01	111818-01	111828-01	111828-01	Brass Fitting	2
12	114930-02	114930-02	114930-01	114930-01	Pilot Bracket	1
13	26205	23109	26205	23109	Gas Orifice	1
14	114936-01	114936-01	114936-02	114936-02	Ventury	1
15	**	**	**	**	Burner	1
16	114933-02	114933-02	114933-01	114933-01	Plate Burner	1
17	**	**	**	**	Log Set	1
PARTS AVAILABLE NOT SHOWN						
	100563-01	100563-01	100563-01	100563-01	Warning Plate	1
	103877-01	103877-01	103877-01	103877-01	Lighting Instruction	1
	100639-01	100639-01	100639-01	100639-01	Caution Decal	1
	111228-02	111228-02	111228-02	111228-02	1/8" Flex Gas Line	1
	114928-11	114928-12	114928-09	114928-10	Rating Plate	1
	GA6060	GA6060	GA6060	GA6060	Lava Rock	1
	115597-01	115597-01	115597-01	115597-01	Log Repair Kit	1
	112799-01	112799-01	112779-01	112799-01	Ember Flakes Kit	1
	901242-01	901242-01	901242-01	901-242-01	Damper Clamp	1

\*\* Not a field replaceable part.

# WARRANTY INFORMATION

## KEEP THIS WARRANTY

Model _____
Serial No. _____
Date Purchased _____

Always specify model and serial numbers when communicating with the factory.

We reserve the right to amend these specifications at any time without notice. The only warranty applicable is our standard written warranty. We make no other warranty, expressed or implied.

### LIMITED WARRANTY VENTED GAS LOG APPLIANCES

DESA warrants this product to be free from defects in materials and components for four (4) years from the date of first purchase, provided that the product has been properly installed, operated and maintained in accordance with all applicable instructions. To make a claim under this warranty the Bill of Sale or cancelled check must be presented.

This warranty is extended only to the original retail purchaser. This warranty covers the cost of part(s) required to restore this heater to proper operating condition and an allowance for labor when provided by a DESA Authorized Service Center. Warranty part(s) MUST be obtained through authorized dealers of this product and/or DESA who will provide original factory replacement parts. Failure to use original factory replacement parts voids this warranty. The heater MUST be installed by a qualified installer in accordance with all local codes and instructions furnished with the unit.

This warranty does not apply to parts that are not in original condition because of normal wear and tear or parts that fail or become damaged as a result of misuse, accidents, lack of proper maintenance or defects caused by improper installation. Travel, diagnostic cost, labor, transportation and any and all such other costs related to repairing a defective heater will be the responsibility of the owner.

TO THE FULL EXTENT ALLOWED BY THE LAW OF THE JURISDICTION THAT GOVERNS THE SALE OF THE PRODUCT; THIS EXPRESS WARRANTY EXCLUDES ANY AND ALL OTHER EXPRESSED WARRANTIES AND LIMITS THE DURATION OF ANY AND ALL IMPLIED WARRANTIES, INCLUDING WARRANTIES OF MERCHANTABILITY AND FITNESS FOR A PARTICULAR PURPOSE TO FOUR (4) YEARS ON ALL COMPONENTS FROM THE DATE OF FIRST PURCHASE; AND DESA'S LIABILITY IS HEREBY LIMITED TO THE PURCHASE PRICE OF THE PRODUCT AND DESA SHALL NOT BE LIABLE FOR ANY OTHER DAMAGES WHATSOEVER INCLUDING INDIRECT, INCIDENTAL OR CONSEQUENTIAL DAMAGES.

Some states do not allow a limitation on how long an implied warranty lasts or an exclusion or limitation of incidental or consequential damages, so the above limitation on implied warranties or exclusion or limitation on damages may not apply to you.

This warranty gives you specific legal rights and you may also have other rights that vary from state to state.

For information about this warranty write:



2701 Industrial Drive  
P.O. Box 90004  
Bowling Green, KY 42102-9004  
[www.desatech.com](http://www.desatech.com)



114924 01  
NOT A UPC

114924-01  
Rev. B  
01/05