

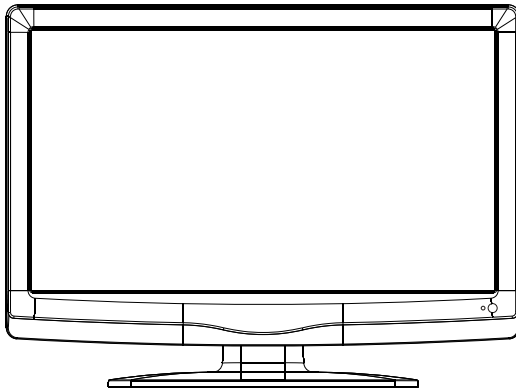

MSDV1911-O3-D0
19" 47cm LCD Television with
Built in DVD Player



USER MANUAL

Thank you for purchasing this LCD TV. Before connection and operation of this product please read the manual carefully and completely.

Please keep this manual for future reference.



Version 1.0

Should you encounter any problems, please contact the help line before you return this product back to the place of purchase.

Contact our Toll Free Warranty Support Help Line

1300 366 144

Email: warrantyhelp@awa.com.au

Visit our web site for FAQ's or request for service
www.awa.com.au

Contents

INTRODUCTION.....	1
SAFETY AND WARNINGS.....	2-4
WALL MOUNTING INSTALLATION GUIDELINES.....	5
INSTALLATION.....	6 -11
REMOTE CONTROL.....	12-13
OPERATION.....	14-18
DVD OPERATION.....	19-22
DVD TROUBLE SHOOTING.....	23
TROUBLE SHOOTING.....	24
TECHNICAL SPECIFICATIONS.....	25

IMPORTANT SAFETY INSTRUCTIONS

- 1) Read these instructions.
- 2) Keep these instructions.
- 3) Heed all warnings.
- 4) Follow all instructions.
- 5) Do not use this apparatus near water.
- 6) Clean only with dry cloth.
- 7) Do not block any ventilation openings, install in accordance with the instructions.
- 8) Do not install near any heat sources such as radiators, heat registers, stoves, or other apparatus (including amplifiers) that produce heat.
- 9) Protect the power cord from being walked on or pinched particularly at plugs, convenience receptacles, and the point where they exit from the apparatus.
- 10) Only use attachments/accessories specified by the manufacturer.
- 11) Unplug this apparatus during lightning storms or when unused for long periods of time.
- 12) Refer all servicing to qualified service personnel. Servicing is required when the apparatus has been damaged in any way, such as power-supply cord or plug is damaged, liquid has been spilled or objects have fallen into the apparatus, the apparatus has been exposed to rain or moisture, does not operate normally, or has been dropped.
- 13) Mains plug is used as the disconnect device, the disconnect device shall remain readily operable.
- 14) The ventilation should not be impeded by covering the ventilation openings with items, such as newspapers, table-cloth, curtains, etc.
- 15) No naked flame sources, such as lighted candles, should be placed on the apparatus.
- 16) This device is not warranted for use in unreasonably hot, cold, or humid environments.
- 17) The apparatus shall not be exposed to dripping or splashing and no objects filled with liquids, such as vases, shall be placed on the apparatus.

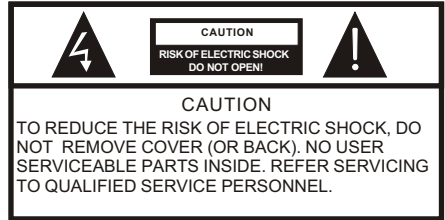

The symbol indicates that dangerous voltages constituting a risk of electric shock are present within this unit.



The symbol indicates that there are important operating and maintenance instructions in the literature accompanying this unit.

WARNING:

To reduce the risk of fire or electric shock, do not expose this apparatus to rain or moisture.

WARNING:

The batteries shall not be exposed to excessive heat such as sunshine, fire or the like.



This symbol indicates that this product incorporates double insulation between hazardous mains voltage and user accessible parts. When servicing use only identical replacement parts.

SAFETY AND WARNINGS

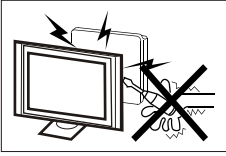

High voltages are used in the operation of this television receiver. Do not remove the cabinet back from your set. Refer servicing to qualified service personnel.

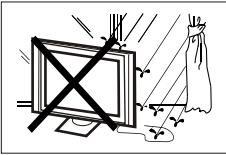

To prevent fire or electrical shock hazard, do not expose the television receiver to rain or moisture.



Do not drop or push objects into the television cabinet slots or openings. Never spill any kind of liquid on the television receiver.



Do not block the ventilation holes in the back cover. Adequate ventilation is essential to prevent failure of electrical components.

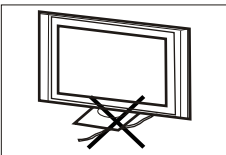

Do not trap the power supply cord under the television receiver.

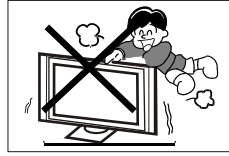

Never stand on, lean on, or suddenly push the television or its stand. You should pay special attention to children. Serious injury may result if it falls.

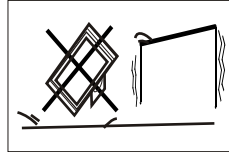

Do not place your television on an unstable cart, stand, shelf or table. Serious injury to an individual, and damage to the television, may result if it falls.

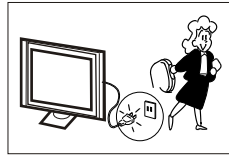

When the television receiver is not used for an extended period of time, it is advisable to disconnect the AC power cord from the AC outlet.

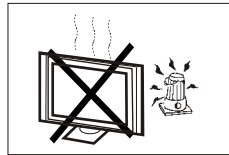

Avoid exposing the television receiver to direct sunlight and other sources of heat. Do not stand the television receiver directly on other products which give off heat, e.g. video cassette players and audio amplifiers. Do not place naked flame sources, such as lighted candles on the television.

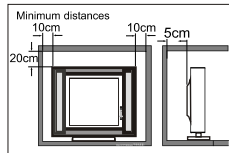

If the television is to be built into a compartment or similar enclosure, the minimum distances must be maintained. Heat build-up can reduce the service life of your television, and can also be dangerous.

CAUTION

Never tamper with any components inside the TV, or any other adjustment controls not mentioned in this manual.

All LCD-TVs are high voltage instruments. When you clean up dust or water drops on the LCD PANEL or CABINET, the power cord should be pulled out from the receptacle, then wipe the TV with a dry soft cloth. During thunder and lightning, unplug the power cord and antenna cord to prevent damage to your TV. All repairs to this TV should only be performed by qualified TV service personnel.

Warning: Change or modifications to this unit not expressly by the part responsible for compliance could void the user's authority to operate the Equipment.

- a. Do not expose to dripping or splashing.
- b. No objects filled with liquids, such as vases, shall be placed on the apparatus.
- c. The mains plug of this device is used as the disconnect device and shall remain readily accessible and operable.
- d. No naked flame sources, such as lighted candles, should be placed on the apparatus.
- e. Allow suitable distances around the apparatus for sufficient ventilation. Ventilation should not be impeded by covering ventilation openings with items such as newspapers, table cloths, curtains and such like.

The display panel is a very sensitive and high technology product, giving you finely detailed pictures. Occasionally, a few non-active pixels may appear on the screen as a fixed point of black, blue, green or red. Please note that this does not affect the performance of your product.

About After- Image

The extended use of fixed image programme material can cause a permanent after - image on the screen.

This background image is viewable on normal programs in the form of a stationary fixed image.

This type of irreversible screen deterioration can be limited by:

- A. Reduce the brightness/contrast setting to a minimum viewing level.
- B. Do not display the fixed image for extended periods of time.
- C. Turn the power off when not in actual use.

Important Information Regarding Use of Video Games, Computers, Captions or Other Fixed Image Displays.

Do not allow a still picture to be displayed for an extended period, as this can cause a permanent after-image to remain on the screen.

Examples of still pictures include logos, video games, computer images, teletext and images displayed in 4:3 mode.

CAUTIONS:

The permanent after-image on the screen resulting from fixed image use is not an operating defect and as such is not covered by the warranty.

This product is not designed to display fixed images for extended periods of time.

For wall mounting with the optional bracket, please read the following instruction and the bracket instruction. Make sure qualified service personnel perform the operation. AWA bears no responsibility for improper mounting that results in accident or injury.

Wall Mounting Holes Spacing and Location

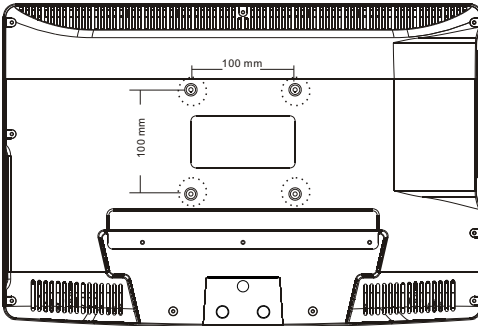

4 Wall mount M4 Screws

Base Stand Disassemble Illustration

How to remove the stand from the TV

(The LCD Display is very fragile, and must be protected at all times when removing the base stand. Be sure that no hard or sharp object, or anything that could scratch or damage the LCD display, comes into contact with it. **DO NOT** exert pressure on the front of the unit at any time because the screen could crack.)

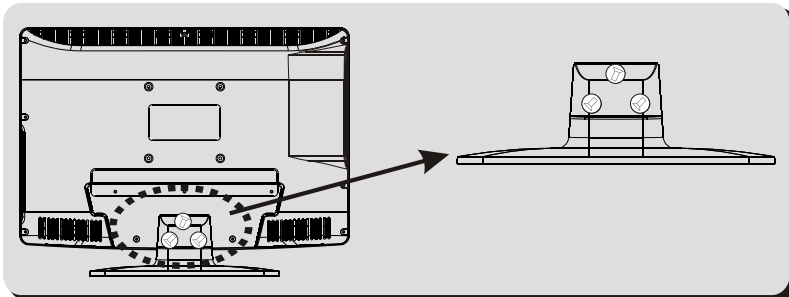

1. Use the screwdriver to remove 3 screws from the screw location.

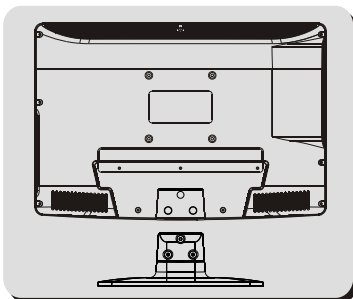

2. Remove the base stand from the Main body.

ACCESSORIES

AC Power Cord.....	1	Stand mounting screws.....	3
Infrared Remote Control.....	1	Wall mounting M4 screws.....	4
User's Manual	1		
Battery (AAA).....	2		

FRONT PANEL

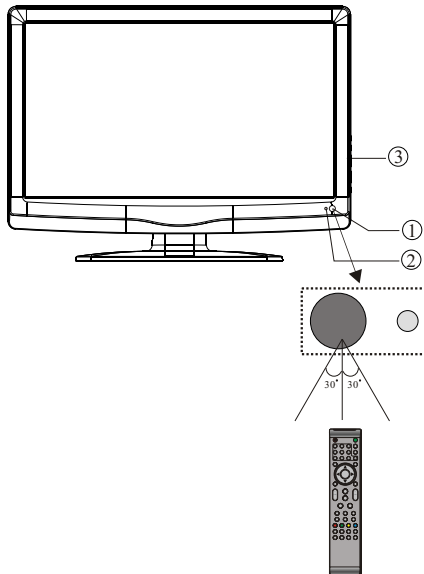

- 1: Remote control sensor.
- 2: Indicator LED: GREEN ● POWER ON.
RED ● STANDBY.
- 3: Key board (on side of TV)

KEY BOARD

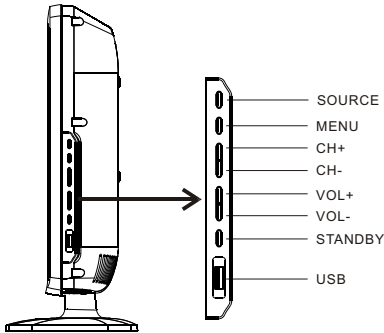

1. **SOURCE:**
Display the input source menu.
2. **MENU:**
Display main MENU.
3. **CH+/CH-**
In TV mode, press “CH+” or “CH-” to change the channel up and down.
In MENU mode, press “CH+” or “CH-” to select items.
4. **VOL+/VOL-**
Adjust sound level. In MENU mode, press “VOL+” or “VOL-” to adjust the item that you selected.
5. **STANDBY**
Press this button to turn the unit ON from STANDBY mode.
Press it again to turn the set back to STANDBY.
6. **USB**
The USB memory stick should be plugged into the unit directly. USB extension cables should not be used to avoid failing of data transferring and interference caused.

To access or play the files on your USB memory stick using this USB socket on your TV, please refer to use of the Applications Menu on page 17 of this manual.

REAR PANEL



All the terminals are (from left to right):
AC Power input, Antenna socket, VGA input, AV output (composite video and audio), PC Audio input, Audio input, YPbPr (component video) input, AV composite video input, HDMI input.

- Note:
1. AV and YPbPr inputs share the Rear Audio input channel.
 2. When the HDMI port receives a DVI signal, the matching audio signal is received by the PC Audio input.

ANTENNA CONNECTION

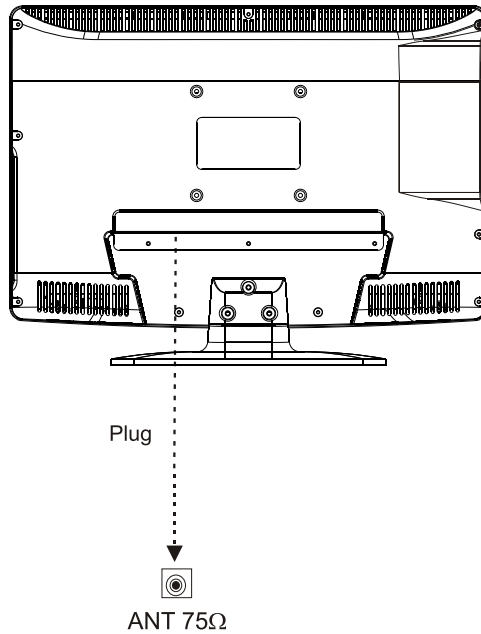

Note:
Aerial connections: IEC(female).
Input impedance: 75Ω unbalanced.

CONNECTING TO PC**STEPS:**

Be sure both the TV and computer are set to Power off.

1. Connect VGA and audio cable.
2. Connect the power cord.
3. Power on the TV, switch the input source to VGA mode.
4. Power on the PC.

This sequence is very important.

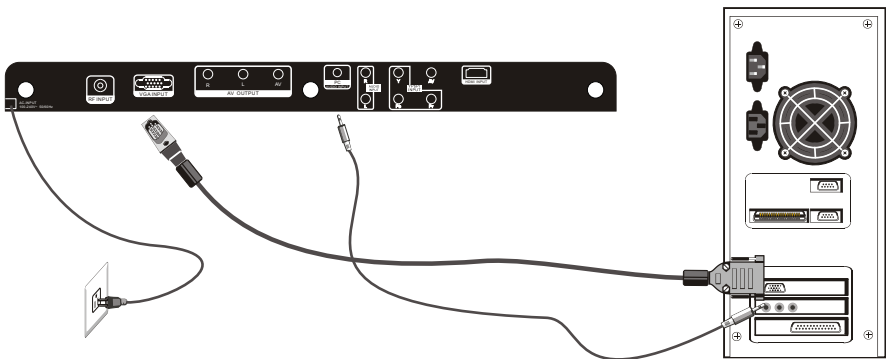

PC PRESET**PRESET MODE**

	RESOLUTION	V.Freq.(Hz)	H.Freq.(KHz)
1	720*400	70	31.47
2	640*480	60	31.47
3	800*600	56	35.156
4	800*600	60	37.88
5	800*600	72	48.08
6	1024*768	60	48.36
7	1024*768	70	56.48

CONNECTING TO AV EQUIPMENT

This TV provides one group of AV, one group of YPbPr (component video) inputs for convenient connection to VCR, DVD or other video equipment. Please refer to the owner's manual of the equipment to be connected as well.

You can use the input terminals on TV set rear as follows.

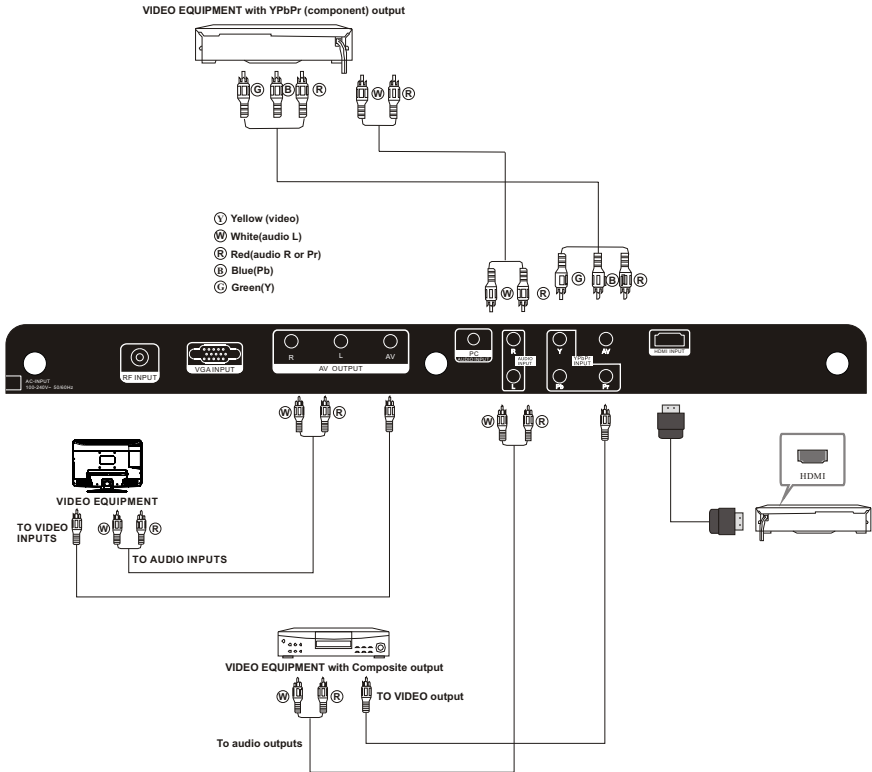

It can be connected to the following appliances: VCR, multi disc player, DVD, camcorder, video game or stereo system, etc.....

YPbPr (component video) can support these video formats: 480i,576i,480p,576p,720p,1080i.

Remote Control - TV section

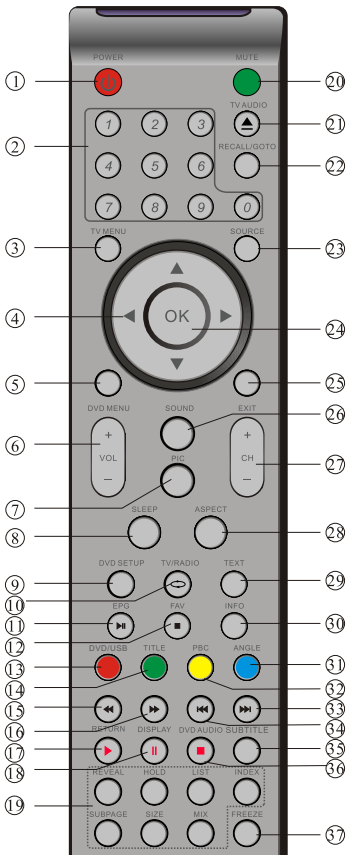

- 1: **POWER**: Press to turn the unit on or off.
- 2: **NUMERIC KEY**: Press for direct access to channels.
- 3: **TV MENU**: Press to display TV Main Menu.
- 4: **CURSOR**: Press to scroll through the Menu.
- 6: **VOL +/-**: Press to adjust the sound level.
- 7: **PIC**: Press to switch between picture modes.
- 8: **SLEEP**: Press to set Sleep Timer.
- 10: **TV/RADIO**: Press to switch between TV and Radio modes.
- 11: **EPG**: Press to display the 7 Day Electronic Program Guide For information on the show you are watching.
- 12: **FAV**: Press to access your favourite channels list in TV or DTV mode
- 15: **REWIND**: Press to rewind play in USB Mode .
- 16: **FAST FORWARD**: Press to Fast Forward play in USB mode .
- 17: **PLAY**: Press the Play Button in USB Mode to begin or continue Playback.
- 18: **PAUSE**: Press the Pause Button to pause play in USB Mode .
- 19: **TELETEXT KEYS**: Refer to page 13.
- 20: **MUTE**: Press to disable or enable the sound output.
- 21: **TV/AUDIO**: To select the available audio language of TV programs .
- 22: **RECALL/GOTO**: Press to return to the previously viewed channel.
- 23: **SOURCE**: Press to display the Input Source List.
- 24: **OK**: Press to confirm Menu selections.
- 25: **EXIT**: To exit the main menu, press the Exit Button or to cancel setting selections.
- 26: **SOUND**: Press to switch between the sound modes.
- 27: **CH+/CH-**: Press to scroll through your Channel List.
- 28: **ASPECT**: Press to change the picture aspect ratio.
- 29: **TEXT**: Press to enter or exit TELETEXT mode.
- 30: **INFO**: To display the program information of the show you are watching, press the Info Button.
- 33: **SKIP FORWARD**: Press to skip the next file or track in USB Mode.
- 34: **SKIP BACKWARD**: Press to skip the previous file or Track in USB Mode
- 35: **SUBTITLE**: To turn on Subtitles press the Subtitle Button in DTV mode.
- 36: **■**: Press to stop playing in USB mode.
- 37: **FREEZE**: Press to freeze the picture you are watching.

Insert Batteries Into the Remote Control

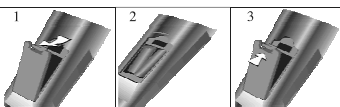

1. Remove the battery cover.
2. Insert the 2 AAA 1.5V batteries making sure the polarity (+ or -) of the batteries matches the polarity marks inside the unit.
3. Mount the battery cover. Replace with new batteries when the TV set begins to show the following symptoms: Operation is unsteady or erratic. Sometimes the TV set does not function with Remote Control Unit.



Remark:

- 1) Alkaline batteries are recommended.
- 2) Remove batteries when they are exhausted or if the remote control is not to be used for a long time.

NOTE: For the function of DVD related buttons, please refer to the DVD section at the back of this instruction book. (page 19-22)

TELETEXT

Teletext is an information system broadcast by certain channels which can be consulted like a newspaper. It also offers access to subtitles for viewers with hearing problems or who are not familiar with the transmission language (cable networks, satellite channels, etc.)

Press:	You will obtain:
<p>TEXT</p>	<p>This is used to call or exit teletext modes. The summary appears with a list of items that can be accessed. Each item has a corresponding 3 digit page number. If the channel selected does not broadcast teletext, the indication 100 will be displayed and the screen will remain blank (in this case, exit teletext and select another channel).</p>
<p>SELECTING A PAGE</p> 	<p>Enter the number of the page required using the 0 to 9 up/down. Example: page 120, enter 120. The number is displayed top left, the counter turns and then the page is displayed. Repeat this operation to view another page. If the counter continues to search, this means that the page is not transmitted. Select another number.</p>
<p>DIRECT ACCESS TO THE ITEMS</p> 	<p>Coloured buttons correspond to the colours at the bottom of the screen. The 4 coloured keys are used to access the items or corresponding pages. The coloured areas flash when the item or the page is not yet available.</p>
<p>INDEX</p>	<p>This returns to the contents page (usually page 100).</p>
<p>SUB PAGE</p>	<p>Certain pages contain sub-pages which are automatically displayed successively. This key is used to stop or resume sub-page acquisition. The indication appears top left.</p>
<p>HOLD</p>	<p>To freeze the page.</p>
<p>REVEAL</p>	<p>To display or hide the concealed information (games solutions).</p>
<p>LIST</p>	<p>The user can set four favourite pages to be directly linked to the four color keys. While list mode is activated, it is not possible to use TOP or FLOF navigation with the colour keys. The favourite page numbers should be stored and restored to/from nonvolatile memory for each channel by the system software.</p>

Installation Guide



This screen only appears when the TV is turned on for the first time, or reset to factory settings. You can choose language, country and auto tuning programs. After tuning, the screen will skip to the first DTV program.

1. CHANNEL MENU

The first item of the MENU is channel menu (for TV or DTV source only).

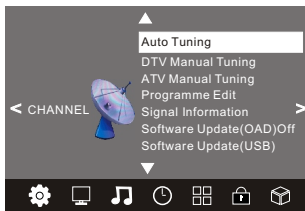

You can search channels and edit programs here.

1).Auto tuning:

Search all the channels automatically (you can select ATV and DTV)



Press ◀▶▼▲ to select country at first, then press the OK button to start auto tuning.

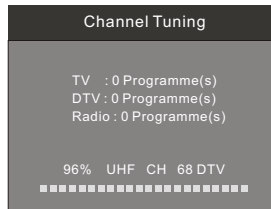

NOTE:

All the channels including ATV, DTV and Radio can be tuned at once, if the Tune Type is DTV+ATV. Any previously stored channels will be deleted after auto tuning is carried out.

After auto tuning, the receiver will skip to the first DTV channel.

2).DTV Manual tuning:

You can select a DTV channel then find the program in this channel. Press ◀▶ to select the channel, then press OK to search the programs .

NOTE:

The Bad Normal Good bar graph on this screen shows signal intensity.

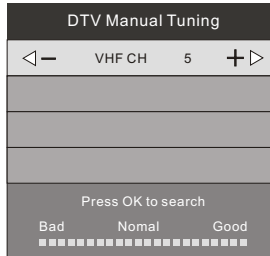

3). ATV Manual tuning :

You can change the sound system, search the analog TV channels and fine tune them, then store the channels you selected.



NOTE:

Press teletext red button to store the channels after manual tuning.

4). Program edit:

You can Delete, Rename, Move, Skip, or FAV any programs.

● Delete

Press teletext red button, the program in the cursor will delete.

● Rename:

You can only rename ATV programs.

Move the cursor to the program, press teletext green button to rename the program.

Press ▼▲ to choose the character. Press ◀▶ to move the cursor .

Press MENU button to exit edit, Press EXIT to exit the menu.

Note: ATV programs name only can be only 5 characters long, DTV programs name can be 25 characters.

● Skip

Press ▼▲ to choose the program, press teletext blue button to skip this program, the Ⓢ symbol will show on the right side of the program .

Choose the skipped program, press blue button again, you can cancel the skip, the Ⓢ symbol will disappear.

Favourite

Press ▼▲ to choose the program, press FAV button, it will show ♥ on the right side of the program. Choose the FAV program, press FAV button again, you can cancel the FAV, ♥ will disappear .

Once your favorite group is created, you can press the FAV key to quickly access your favourite channel.

2. PICTURE MENU

The second item of the MENU is PICTURE MENU. You can adjust picture effects here, such as contrast, brightness, etc.

Press ▼▲ to move, press OK to adjust.

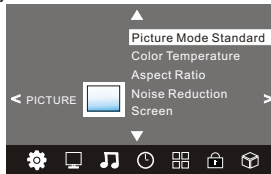

Picture Mode	Standard
Contrast	82
Brightness	50
Color	50
Sharpness	50
Tint	50
MENU	

Color Temperature	Medium
Red	40
Green	31
Blue	50
MENU	

NOTE:

- 1). Tint is available in NTSC system only.
- 2). There are four color temperature modes that can be selected: medium, warm, cool, user.
- 3). Screen is available in PC mode only, which can adjust Horizontal position, vertical position, size and phase.

3. SOUND MENU

The third item of the MENU is the SOUND MENU.

You can adjust the sound effect here such as treble, bass, balance etc.

Press ▼▲ to move, press OK to adjust.

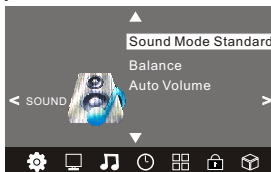

Note:

Auto volume: only available when the input signal volume is too large or there is distortion.

4. TIME MENU

The fourth item of the menu is the TIME MENU. You can adjust the clock, power on/off time, sleep time etc.

Press ▼▲ to move, press OK to adjust.

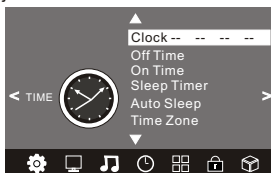

NOTE:

If within 15 minutes there is no signal, the TV will auto sleep, if Auto Sleep is set ON. The clock time can be set from the DTV system.

5.OPTION MENU

To enter the Option Menu, press MENU button and the press ◀ or ▶ buttons to select the Option Menu. Once in Option Menu, press ▼ or ▲ buttons to select the settings you wish to adjust. Press MENU button to return to the Main Menu.

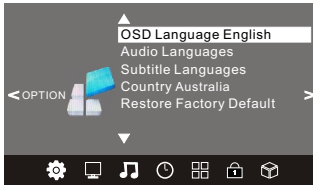

NOTE:

Restore factory default will clear all the programs and password.

6.LOCK MENU

To enter the LOCK Menu, press MENU button and then press ◀ or ▶ buttons to select the LOCK Menu. The default password is 6666.

Please set a new password so it is easy to remember. Follow the onscreen steps to set.

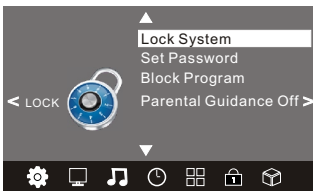

7. APPLICATIONS MENU

To enter the Applications Menu, press MENU button and then press ◀ or ▶ buttons to select the Applications Menu. This is where you will be able to view and play your USB files.

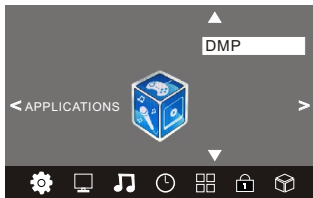

Press the OK button to enter the DMP Menu.

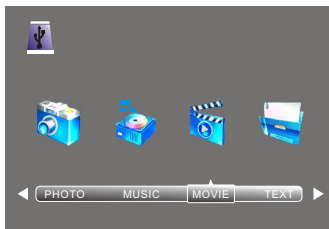

The supported formats are as below:

Photo: JPEG, BMP, PNG

Music: MP3

Movie: AVI, MKV

Text: TXT

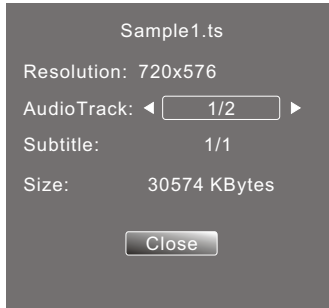

8. EPG Menu (Electronic Program Guide).

The EPG Menu is used to look at what is being broadcast in DTV or Radio modes. Press the EPG Button to access the EPG Menu. You will receive detailed program information of the channel you are currently watching as well as the 7 Day Program guide.

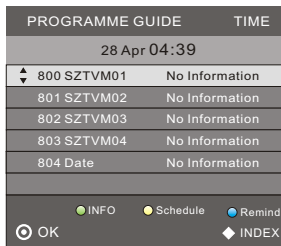

1. **INFO**

Use **INFO** to select a program and then press the Green Button or INFO key on the Remote to display the highlighted program's information.

2. **Schedule**

Press the teletext yellow key, It can list all the reminder schedule, press **▲▼** to choose the list, press red key **DELETE** to delete the schedule list, Press EPG to return to EPG menu.

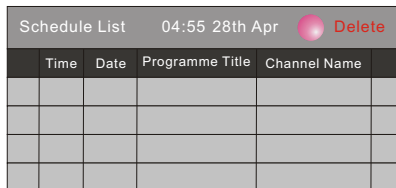

3. **Remind**

Press the Blue Button to book a program for future viewing and add to the schedule list.

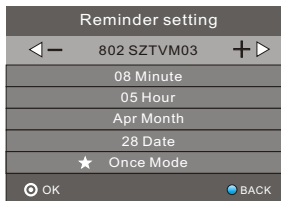

DVD SIDE PANEL

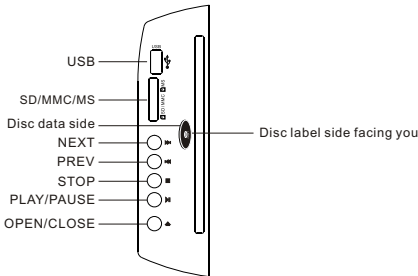

USB

In DVD mode when no disc is playing, insert a USB drive (or an MP3 player with USB interface) into the USB socket. Press the DVD/USB button on the Remote Control unit, and use the \blacktriangledown / \blacktriangle keys to select USB mode for playing MP3 or JPEG files.

3 in 1 Card Reader

In DVD mode when no disc is playing, insert three kinds of card (SD, MMC, MS). Press DVD/USB button on the Remote control and use the \blacktriangle / \blacktriangledown key to select SD/MS/MMC mode for playing MP3 or JPEG files. All the functions are the same as playing a disc.

When the disc is playing, please stop playing first and insert a USB/CARD, enjoying USB/CARD by press DVD/USB key on the remote controller, and then press \blacktriangle / \blacktriangledown key to select DISC/USB/CARD, and press ENTER/OK to confirm.

Caution:

When using USB/3 in 1 Card Reader function, please do not insert in the wrong direction, or else it will damage the unit.



Caution

This DVD Player has a Class 1 laser which may be harmful to your eyes. Do not attempt to disassemble the cabinet or make any adjustments.

Refer all servicing to a qualified professional.

Features

Disc formats supported by this player:



Dolby Digital



Multi-angle



KODAK picture CD



Subtitle choices



MP3 files on CD-R/CD-RW



Audio choices



DVD video

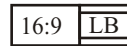

TV Aspect Ratio modes

This product incorporates copyright protection technology that is protected by U.S. patents and other intellectual property rights. Use of this copyright protection technology must be authorized by Rovi Corporation, and is intended for home and other limited viewing uses only unless otherwise authorized by Rovi Corporation. Reverse engineering or disassembly is prohibited.

The product complies with the KODAK Picture CD format and will display KODAK Picture CDs. The "KODAK Picture CD Compatible" logo is a trademark of Eastman Kodak Company and is used with permission.

Manufactured under license from Dolby Laboratories. "Dolby" and the double-D symbol are trademarks of Dolby Laboratories. Confidential Unpublished Works. 1992-1997 Dolby Laboratories, Inc. All rights reserved.

MENU OPERATION

Press the DVDSETUP button on the remote control, the SETUPMENU will be displayed. After accessing the setup menu, press the direction buttons for up and down movement to select an item desired, and press RIGHT direction button to select the SUBMENU item. Then press the ENTER/OK button to confirm. Press LEFT direction button to return to the upper level menu. To exit the setup, press the SETUP button again. In the SETUPMENU, you may choose any of the following options as you like.

LANGUAGE SETUP

Select Language in the setup menu, and display the Language submenu:

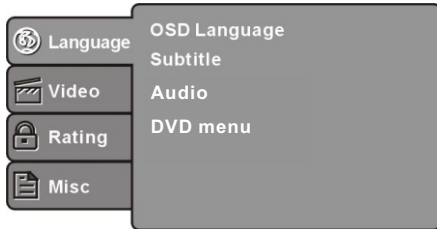

OSD Language

Use this item to select the language of the setup menu and screen display.

Subtitle

This option provides the preset subtitle language.

Audio

Select the built-in disc dubbing language options.

DVD Menu

This option provides the film's menu language options.

VIDEO SETUP

Select Video in the setup menu, and display the Video submenu:

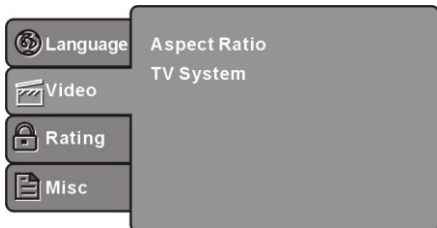

SYSTEM SETUP

Aspect Ratio

Select the aspect ratio.

Notes:

The image display ratio is related to the recorded disc format. Some discs can not display images in the aspect ratio you choose. If you play a disc recorded in 4:3 format on a wide screen TV, black bars will appear on the left and right side of the screen. You must adjust the screen setting depending on the type of the television you have.

TV System

Select the different TV system.

Note: The DVD player setting should be matched to your TV set. For more information of output format, refer to the instructions of your TV set.

MISC SETUP

Select MISC in the setup menu, and display the submenu:

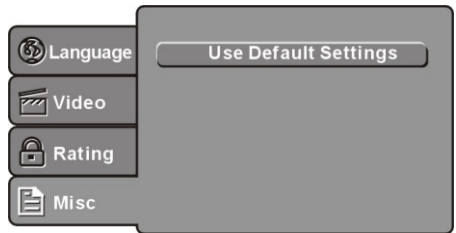

Use Default Settings

Reset setup data to factory default value.

MP3/WMA/JPEG PLAYBACK



A MP3/WMA disc will show a directory structure as shown in the picture above. Press **Direction key** to choose the root directory and then press ENTER/OK button to enter into the sub directory. Press **Direction key** to choose the desired track and then press ENTER/OK or **PLAY** to enjoy the music or movie. If you want to return to the upper menu, press **Direction key** to choose the icon and press ENTER/OK button.

- Filter: Allows selecting the categories of files displayed in the browser list.
- Repeat: To switch different repeat playing modes
- Mode: Select different playing mode as follows:
 Normal: Shuffle mode is cancelled.
 Shuffle: Shuffle mode enabled. When playback reaches the end of the current chapter/track, playback jumps to a random chapter/track. As the end of each chapter/track is reached, another random chapter/track will be played until all tracks/chapters have been played or the Shuffle mode is cancelled by toggling to a different **Mode** Option.
- Edit Mode:** To enable programmed playback mode. When you select the mode, press **LEFT** **Direction key** to directory and press **ENTER/OK** to choose the desired track and press **Add to program** and press **Program view** and press the **Edit mode** to cancel the edit mode. At last press **Left key** to display program track and press **ENTER/OK** to start program playback.
- Program view:** Display program track.
- Browser view:** Display track directory.
- Add to program:** Choose the track, press **Add to program** to add the track to the program play directory.
- Clear program:** In the complete stop state (press the **STOP** button twice), then press Edit mode to enable the edit mode. Press Left key to program track and press ENTER/OK to cancel the desired track. Press **Clear program** to delete the track from the program play directory.

PICTURE CD PLAYBACK

A PICTURE CD disc will show a similar directory structure as shown in the following picture.

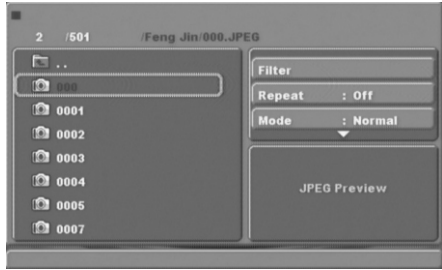

Press **Direction key** to choose the root directory and then press ENTER/OK button to enter into the sub directory. Press **Direction key** to choose the desired picture and then press ENTER/OK or **PLAY** to enjoy the picture. If you want to return to the upper menu, press **Direction key** to choose the icon and press ENTER/OK button.

Image rotation
 In picture play state, press **Direction key** to rotate the picture.

CARD READER ,USB

3 In 1 Card Reader

If the player has a 3 in 1 card jack and it's NOT in "disc playing" status, you can insert three kinds of card (MMC, SD , MS) to play MP3 music and JPEG files. All the functions are the same as playing a disc.

USB

If the player has a USB slot and it's NOT in "disc playing" status, you can insert a USB device or an MP3 Player with USB Interface to play the MP3 music and or JPEG files. All the functions are the same as playing a disc.

When the disc is playing, please stop playing first and then insert a USB/CARD, enjoying USB/CARD by pressing the **DVD/USB** key on the remote controller and then press **▼ /▲** key to select DISC/USB/CARD, then press ENTER/OK to confirm.
 Not all USB/CARD devices are supported by this system.

Note: When using USB/3 in 1 Card Reader function, please do not insert in the wrong direction, or else it will damage the unit.

Function Buttons**OPEN/CLOSE**

To open the disc tray, press OPEN/CLOSE; To close the disc tray, press OPEN/CLOSE again.

SUBTITLE

Press the button to choose different captions (requires support from disc)

GOTO

For DVD discs, press the button to choose the desired title and chapter and search the desired title time and chapter time. For Super VCD, VCD, CD discs, press this button to search the desired disc time and track time and choose the desired track.

Note: During VCD playback, the PBC mode must be set to OFF.

0-9 keys

These keys are used to input the time, as well as title, chapter and track numbers. When a numeric item is displayed on the screen, press the 0-9 keys to select the desired entry, and press ENTER/OK to confirm. When a VCD is playing (with PBC off), press the 0-9 keys to select a track directly.

MENU

During DVD playback, press MENU to display the disc menu of the current title.

PBC

During VCD/SVCD playback, press PBC to control PBC ON/OFF.

SETUP

Press the button to enter the system setting menu. Press the button again to exit the menu.

RETURN

When DVD/SVCD/VCD displaying, press RETURN button to the menu (PBC ON only).

DISPLAY

Press this button to show the information of the current playing disc.

ENTER/OK

Press this button to confirm your choice on screen.

REV:

During DVD, CD MP3 or VCD playback, press REV to scan in reverse.

The player will review the disc at different times speed. Press PLAY/PAUSE to resume normal playback.

FWD

During DVD, CD, MP3, or VCD playback, press FWD to scan forward. The player will review the disc at different speed. Press PLAY/PAUSE to resume normal playback.

PREV

During DVD, CD, MP3, or VCD playback, press PREV to play the previous chapter, title or track.

NEXT

During DVD, CD, MP3, or VCD playback, press NEXT to play the next chapter, title or track.

STOP

Press the button once and the player will be in memory stop state. Continuously press this button twice and the player will be in complete stop state.

Play/Pause

In pause state or stop state, press this button and the player will be in playing state. In play state, press this button again and the player will be in pause state.

ANGLE

Press the button to view scenes shot from ANGLE DIFFERENCE ANGLES. (Disc support is required)

DVD Trouble shooting

If you have any questions, please consult the troubleshooting guide below:

NO PICTURE OR SOUND

- Ensure the power button is on.
- Ensure the power outlet is operational.
- Ensure the power cord is not damaged.
- Ensure the power plug is connected firmly to the outlet.

PICTURE BUT NO SOUND

- Ensure the audio is not set to mute.
- Ensure you have set the player's AUDIO settings correctly.

POOR PICTURE OR SOUND

- Ensure you have set the player's AUDIO settings correctly
- Ensure the disc is not scratched or stained.

“BAD DISC” DISPLAYED

- Ensure the disc is not warped, damaged or deformed.
- Ensure the disc is not badly stained or damaged.
- Ensure the disc format is compatible with the player.
- Please check whether you have tried to play a software CD. If so, please restart the player.

REMOTE NOT WORKING



















- Make sure the Main unit's POWER button is on
- Ensure the remote batteries are working.
- Point the remote control directly at the player's IR sensor.
- Remove any obstacles between the remote and the IR sensor.

UNIT NOT WORKING

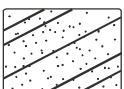
- Turn off the power, and then turn it on again.

“NO DISC” DISPLAYED

- Ensure you have put the disc on the tray.
- Ensure the disc is not upside down.
- Ensure the disc is not distorted, stained or scratched.

Trouble phenomenon Symptom		Inspection Check
Picture	Audio	
 <p>Snow</p>	 <p>Noise</p>	antenna position, direction or connection
 <p>Ghost</p>	 <p>Normal audio</p>	antenna position, direction or connection
 <p>Interference</p>	 <p>Noise</p>	electronic equipment, car/motorcycle, fluorescent light
 <p>Normal Picture</p>	 <p>Mute</p>	Volume (check if mute is activated or if the audio system connections are not correct)
 <p>No picture</p>	 <p>Mute</p>	Power cord is not inserted Power switch is not opened Contrast and brightness/volume setup Press standby key on the remote control for inspecting
 <p>No colour</p>	 <p>Normal audio</p>	Colour control
 <p>Picture breaking up</p>	 <p>Normal audio or weak</p>	retune channel
 <p>No colour</p>	 <p>Noise</p>	TV system
 <p>Mosaic</p>	 <p>Unnormal</p>	Antenna Loose

LCD :

Viewing Picture Size(diagonal)	18.5"(47cm)
Resolution	1366x768
Aspect Ratio	16:9
Display colours	16.7M
Brightness	250 cd/m ²
Contrast ratio	1000:1
Response time	5 ms
Viewing angle	170° (H)/160° (V)

TV:

TV system	Digital TV: DVB-T Analog TV: PAL/SECAM
DVB-T decode	Audio: MPEG2 Audio Layer I&II Video: MPEG2 Transport MP@HL
DVB-T de-modulation	Demodulator : COFDM OFDM Mod.: 2K, 8K FFT, SFN and MFN Packed Carriers: 2K/8K Guard Interval: 1/4, 1/8, 1/16, 1/32

Terminals:

Analog RGB(VGA) Input	1
HDMI Input	1
Composite Video Input	1
Audio Input	2
Y PbPr (Component video) Input	1
Composite Video Output	1
Analog Audio Output	1

Others:

Input Voltage	100V-240V~ 50/60Hz
Power consumption	30W
Audio Output Power(THD≤7%)	2x1.5W



TV/DVD Product Warranty

Subject to the warranty repair conditions below, in addition to any applicable statutory warranties this product is warranted for (3 years - TV component) and (1 year - DVD component) from the original date of purchase covering both parts and labour.

The benefits conferred by this warranty are in addition to and not in derogation of all rights and remedies in respect of this product which the consumer has under the Trade Practices Act and other State and Territory laws.

Warranty Repair Conditions

A. This Product Warranty only applies provided the product:-

- Has been purchased in Australia and sold by Authorised Distributors or Dealers and only where the products are used and serviced within Australia.
- Is taken for service when required to an Authorised Service Agent, together with written instructions indicating specific problem or function requiring investigation.
- Has valid proof of purchase and presented when warranty service is requested.
- Has only been used in a domestic application.
- Has been installed and operated in accordance as noted in the operating instructions under normal use and reasonable care (in the opinion of the Service Centre).
- Has not been damaged by the use of accessories which in the opinion of the Service Centre are defective or incompatible with the product.
- Has not been tampered with or repaired (including unauthorised alterations) by anyone other than the AWA Service Centre or an Authorised Service Centre.

B. This Product Warranty does not cover:-

- Damage, malfunction or failure resulting from use of incorrect voltages, incorrect installation, accidental damage, misuse, neglect, build-up of dirt or dust abuse, wear and tear, maladjustment of customer controls, mains supply problems, thunderstorm activity or Acts of God, pixel error, infestation by insects or vermin, exposure to abnormally corrosive conditions or any foreign object or matter having entered the product.
- Mileage or travelling time in respect of service outside the authorised AWA Service Centre nor pick up and delivery cost incurred.
- Service calls arising from failure to correctly operate the product or to observe noted instructions, or repair which reveals the product is in normal working order.
- Cabinet parts, user replacement batteries or leads unless the defective items are reported at the time of purchase.

C. Service calls only apply to Television display devices (CRT, LCD, Plasma) with screen sizes greater than 59cm in the major metropolitan areas of Australia or the normal operating areas of the nearest Authorised Service Centres.

D. Requested service visits to the customer premises will be made during normal working hours of the customary working week upon request by the customer. Where such a visit is made on a day arranged by the customer and the service technician is unable to obtain access to the product, the Service Centre will be entitled to make a separate charge for service call fee, time and distance travelled.

E. The AWA Service Centre and its Authorised Service Centres may charge for work done where the product is found to be in good working order. Example, charges may be made where the problem is found to be due to incorrect setting of customer controls, use of poor associated equipment (e.g. poor antenna systems) or the inability of the product to operate with faulty or incompatible equipment.

F. If the product is sent to an Authorised Service Centre, the owner is responsible for the cost of transport to and from the Service Centre. In addition, the product is at the owner's risk while in transit to and from the authorised Service Centre.

G. No person is authorised to make or give any assertions, statements or undertakings, whether expressed or implied about the product other than or additional to the terms of this warranty.

Please read instruction manual carefully

Should you encounter any problems?

**Please contact Telefix for Warranty Support
1300 366 144**

Email: warrantyhelp@awa.com.au

The original proof of purchase must be kept and produced for service requirements under this Product Warranty.