

# PRO WELD

INTERNATIONAL

---

---

## ***ARC 1850***



## ***OPERATION/MAINTENANCE MANUAL***



## TABLE OF CONTENTS

		PAGE
1.0	INTRODUCTION.....	1
2.0	WARRANTY.....	1
3.0	UNPACKING YOUR UNIT.....	1
4.0	SUGGESTED SAFETY PRECAUTIONS.....	1
4.1	PERSONAL SAFETY PRECAUTIONS.....	1
4.2	POWER SUPPLY SAFETY PRECAUTIONS.....	2
5.0	GENERAL DESCRIPTION.....	2
6.0	ELECTRICAL INPUT REQUIREMENT.....	2
7.0	CONTROL PANEL DESCRIPTION.....	4
8.0	WELD GUN SETUP.....	5
8.1	PLUNGE LENGTH.....	5
8.2	CHECKING GUN LIFT.....	6
9.0	PARTS LIST.....	7thru13
10.0	TROUBLE SHOOTING.....	15

### LIST OF FIGURES

1	JUMPER LINK ARRANGEMENT.....	3
2	CONTROL PANEL FRONT.....	4
3	STANDARD GUN SET-UP.....	5
4	FUSE BLOCK.....	6
5	CONTROL UNIT - FRONT.....	7
6	CONTROL UNIT - REAR.....	8
7	CONTROL UNIT -SIDE VIEW.....	9
8	RECTIFIER, WELD BRIDGE ASSY.....	10
9	PRINTED CIRCUIT BOARD ENCLOSURE.....	11
10	GUN TIMER CONTROL PCB.....	12
11	MONITOR PCB.....	13
12	CURRENT CONTROL PCB.....	14

## SECTION 1 – SAFETY PRECAUTIONS - READ BEFORE USING

### 1-1. Symbol Usage



Means Warning! Watch Out! There are possible hazards with this procedure! The possible hazards are shown in the adjoining symbols.

▲ Marks a special safety message.

☞ Means "Note"; not safety related.



This group of symbols means Warning! Watch Out! possible ELECTRIC SHOCK, MOVING PARTS, and HOT PARTS hazards. Consult symbols and related instructions below for necessary actions to avoid the hazards.

### 1-2. Arc Welding Hazards

▲ The symbols shown below are used throughout this manual to call attention to and identify possible hazards. When you see the symbol, watch out, and follow the related instructions to avoid the hazard. The safety information given below is only a summary of the more complete safety information found in the Safety Standards listed in Section NO TAG. Read and follow all Safety Standards.

▲ Only qualified persons should install, operate, maintain, and repair this unit.

▲ During operation, keep everybody, especially children, away.



#### ELECTRIC SHOCK can kill.

Touching live electrical parts can cause fatal shocks or severe burns. The electrode and work circuit is electrically live whenever the output is on. The input power circuit and machine internal circuits are also live when power is on. In semiautomatic or automatic wire welding, the wire, wire reel, drive roll housing, and all metal parts touching the welding wire are electrically live. Incorrectly installed or improperly grounded equipment is a hazard.

- Do not touch live electrical parts.
- Wear dry, hole-free insulating gloves and body protection.
- Insulate yourself from work and ground using dry insulating mats or covers big enough to prevent any physical contact with the work or ground.
- Do not use AC output in damp areas, if movement is confined, or if there is a danger of falling.
- Use AC output ONLY if required for the welding process.
- If AC output is required, use remote output control if present on unit.
- Disconnect input power or stop engine before installing or servicing this equipment. Lockout/tagout input power according to OSHA 29 CFR 1910.147 (see Safety Standards).
- Properly install and ground this equipment according to its Owner's Manual and national, state, and local codes.
- Always verify the supply ground – check and be sure that input power cord ground wire is properly connected to ground terminal in disconnect box or that cord plug is connected to a properly grounded receptacle outlet.
- When making input connections, attach proper grounding conductor first – double-check connections.
- Frequently inspect input power cord for damage or bare wiring – replace cord immediately if damaged – bare wiring can kill.
- Turn off all equipment when not in use.
- Do not use worn, damaged, undersized, or poorly spliced cables.
- Do not drape cables over your body.

- If earth grounding of the workpiece is required, ground it directly with a separate cable – do not use work clamp or work cable.
- Do not touch electrode if you are in contact with the work, ground, or another electrode from a different machine.
- Use only well-maintained equipment. Repair or replace damaged parts at once. Maintain unit according to manual.
- Wear a safety harness if working above floor level.
- Keep all panels and covers securely in place.
- Clamp work cable with good metal-to-metal contact to workpiece or worktable as near the weld as practical.
- Insulate work clamp when not connected to workpiece to prevent contact with any metal object.
- Do not connect more than one electrode or work cable to any single weld output terminal.

#### SIGNIFICANT DC VOLTAGE exists after removal of input power on inverters.

- Turn Off inverter, disconnect input power, and discharge input capacitors according to instructions in Maintenance Section before touching any parts.



#### FUMES AND GASES can be hazardous.

Welding produces fumes and gases. Breathing these fumes and gases can be hazardous to your health.

- Keep your head out of the fumes. Do not breathe the fumes.
- If inside, ventilate the area and/or use exhaust at the arc to remove welding fumes and gases.
- If ventilation is poor, use an approved air-supplied respirator.
- Read the Material Safety Data Sheets (MSDSs) and the manufacturer's instructions for metals, consumables, coatings, cleaners, and degreasers.
- Work in a confined space only if it is well ventilated, or while wearing an air-supplied respirator. Always have a trained watchperson nearby. Welding fumes and gases can displace air and lower the oxygen level causing injury or death. Be sure the breathing air is safe.
- Do not weld in locations near degreasing, cleaning, or spraying operations. The heat and rays of the arc can react with vapors to form highly toxic and irritating gases.
- Do not weld on coated metals, such as galvanized, lead, or cadmium plated steel, unless the coating is removed from the weld area, the area is well ventilated, and if necessary, while wearing an air-supplied respirator. The coatings and any metals containing these elements can give off toxic fumes if welded.



### ARC RAYS can burn eyes and skin.

Arc rays from the welding process produce intense visible and invisible (ultraviolet and infrared) rays that can burn eyes and skin. Sparks fly off from the weld.

- Wear a welding helmet fitted with a proper shade of filter to protect your face and eyes when welding or watching (see ANSI Z49.1 and Z87.1 listed in Safety Standards).
- Wear approved safety glasses with side shields under your helmet.
- Use protective screens or barriers to protect others from flash and glare; warn others not to watch the arc.
- Wear protective clothing made from durable, flame-resistant material (leather and wool) and foot protection.



### WELDING can cause fire or explosion.

Welding on closed containers, such as tanks, drums, or pipes, can cause them to blow up. Sparks can fly off from the welding arc. The flying sparks, hot workpiece, and hot equipment can cause fires and burns. Accidental contact of electrode to metal objects can cause sparks, explosion, overheating, or fire. Check and be sure the area is safe before doing any welding.

- Protect yourself and others from flying sparks and hot metal.
- Do not weld where flying sparks can strike flammable material.
- Remove all flammables within 35 ft (10.7 m) of the welding arc. If this is not possible, tightly cover them with approved covers.
- Be alert that welding sparks and hot materials from welding can easily go through small cracks and openings to adjacent areas.
- Watch for fire, and keep a fire extinguisher nearby.
- Be aware that welding on a ceiling, floor, bulkhead, or partition can cause fire on the hidden side.
- Do not weld on closed containers such as tanks, drums, or pipes, unless they are properly prepared according to AWS F4.1 (see Safety Standards).
- Connect work cable to the work as close to the welding area as practical to prevent welding current from traveling long, possibly unknown paths and causing electric shock and fire hazards.
- Do not use welder to thaw frozen pipes.
- Remove stick electrode from holder or cut off welding wire at contact tip when not in use.
- Wear oil-free protective garments such as leather gloves, heavy shirt, cuffless trousers, high shoes, and a cap.
- Remove any combustibles, such as a butane lighter or matches, from your person before doing any welding.



### FLYING METAL can injure eyes.

- Welding, chipping, wire brushing, and grinding cause sparks and flying metal. As welds cool, they can throw off slag.
- Wear approved safety glasses with side shields even under your welding helmet.



### BUILDUP OF GAS can injure or kill.

- Shut off shielding gas supply when not in use.
- Always ventilate confined spaces or use approved air-supplied respirator.



### HOT PARTS can cause severe burns.

- Do not touch hot parts bare handed.
- Allow cooling period before working on gun or torch.



### MAGNETIC FIELDS can affect pacemakers.

- Pacemaker wearers keep away.
- Wearers should consult their doctor before going near arc welding, gouging, or spot welding operations.



### NOISE can damage hearing.

Noise from some processes or equipment can damage hearing.

- Wear approved ear protection if noise level is high.



### CYLINDERS can explode if damaged.

Shielding gas cylinders contain gas under high pressure. If damaged, a cylinder can explode. Since gas cylinders are normally part of the welding process, be sure to treat them carefully.

- Protect compressed gas cylinders from excessive heat, mechanical shocks, slag, open flames, sparks, and arcs.
- Install cylinders in an upright position by securing to a stationary support or cylinder rack to prevent falling or tipping.
- Keep cylinders away from any welding or other electrical circuits.
- Never drape a welding torch over a gas cylinder.
- Never allow a welding electrode to touch any cylinder.
- Never weld on a pressurized cylinder – explosion will result.
- Use only correct shielding gas cylinders, regulators, hoses, and fittings designed for the specific application; maintain them and associated parts in good condition.
- Turn face away from valve outlet when opening cylinder valve.
- Keep protective cap in place over valve except when cylinder is in use or connected for use.
- Read and follow instructions on compressed gas cylinders, associated equipment, and CGA publication P-1 listed in Safety Standards.

### 1-3. Additional Symbols for Installation, Operation, and Maintenance



#### FIRE OR EXPLOSION hazard.

- Do not install or place unit on, over, or near combustible surfaces.
- Do not install unit near flammables.
- Do not overload building wiring – be sure power supply system is properly sized, rated, and protected to handle this unit.



#### MOVING PARTS can cause injury.

- Keep away from moving parts such as fans.
- Keep all doors, panels, covers, and guards closed and securely in place.



#### FALLING UNIT can cause injury.

- Use lifting eye to lift unit only, NOT running gear, gas cylinders, or any other accessories.
- Use equipment of adequate capacity to lift and support unit.
- If using lift forks to move unit, be sure forks are long enough to extend beyond opposite side of unit.



#### H.F. RADIATION can cause interference.

- High-frequency (H.F.) can interfere with radio navigation, safety services, computers, and communications equipment.
- Have only qualified persons familiar with electronic equipment perform this installation.
- The user is responsible for having a qualified electrician promptly correct any interference problem resulting from the installation.
- If notified by the FCC about interference, stop using the equipment at once.
- Have the installation regularly checked and maintained.
- Keep high-frequency source doors and panels tightly shut, keep spark gaps at correct setting, and use grounding and shielding to minimize the possibility of interference.



#### OVERUSE can cause OVERHEATING

- Allow cooling period; follow rated duty cycle.
- Reduce current or reduce duty cycle before starting to weld again.
- Do not block or filter airflow to unit.



#### STATIC (ESD) can damage PC boards.

- Put on grounded wrist strap BEFORE handling boards or parts.
- Use proper static-proof bags and boxes to store, move, or ship PC boards.



#### MOVING PARTS can cause injury.

- Keep away from moving parts.
- Keep away from pinch points such as drive rolls.



#### WELDING WIRE can cause injury.

- Do not press gun trigger until instructed to do so.
- Do not point gun toward any part of the body, other people, or any metal when threading welding wire.



#### ARC WELDING can cause interference.

- Electromagnetic energy can interfere with sensitive electronic equipment such as computers and computer-driven equipment such as robots.
- Be sure all equipment in the welding area is electromagnetically compatible.
- To reduce possible interference, keep weld cables as short as possible, close together, and down low, such as on the floor.
- Locate welding operation 100 meters from any sensitive electronic equipment.
- Be sure this welding machine is installed and grounded according to this manual.
- If interference still occurs, the user must take extra measures such as moving the welding machine, using shielded cables, using line filters, or shielding the work area.

### 1-4. Principal Safety Standards

*Safety in Welding and Cutting*, ANSI Standard Z49.1, from American Welding Society, 550 N.W. LeJeune Rd, Miami FL 33126

*Safety and Health Standards*, OSHA 29 CFR 1910, from Superintendent of Documents, U.S. Government Printing Office, Washington, D.C. 20402.

*Recommended Safe Practices for the Preparation for Welding and Cutting of Containers That Have Held Hazardous Substances*, American Welding Society Standard AWS F4.1, from American Welding Society, 550 N.W. LeJeune Rd, Miami, FL 33126

*National Electrical Code*, NFPA Standard 70, from National Fire Protection Association, Batterymarch Park, Quincy, MA 02269.

*Safe Handling of Compressed Gases in Cylinders*, CGA Pamphlet P-1, from Compressed Gas Association, 1235 Jefferson Davis Highway, Suite 501, Arlington, VA 22202.

*Code for Safety in Welding and Cutting*, CSA Standard W117.2, from Canadian Standards Association, Standards Sales, 178 Rexdale Boulevard, Rexdale, Ontario, Canada M9W 1R3.

*Safe Practices For Occupation And Educational Eye And Face Protection*, ANSI Standard Z87.1, from American National Standards Institute, 1430 Broadway, New York, NY 10018.

*Cutting And Welding Processes*, NFPA Standard 51B, from National Fire Protection Association, Batterymarch Park, Quincy, MA 02269.

## 1-5. EMF Information

### Considerations About Welding And The Effects Of Low Frequency Electric And Magnetic Fields

Welding current, as it flows through welding cables, will cause electromagnetic fields. There has been and still is some concern about such fields. However, after examining more than 500 studies spanning 17 years of research, a special blue ribbon committee of the National Research Council concluded that: "The body of evidence, in the committee's judgment, has not demonstrated that exposure to power-frequency electric and magnetic fields is a human-health hazard." However, studies are still going forth and evidence continues to be examined. Until the final conclusions of the research are reached, you may wish to minimize your exposure to electromagnetic fields when welding or cutting.

To reduce magnetic fields in the workplace, use the following procedures:

1. Keep cables close together by twisting or taping them.
2. Arrange cables to one side and away from the operator.
3. Do not coil or drape cables around your body.
4. Keep welding power source and cables as far away from operator as practical.
5. Connect work clamp to workpiece as close to the weld as possible.

#### **About Pacemakers:**

Pacemaker wearers consult your doctor first. If cleared by your doctor, then following the above procedures is recommended.

## 1.0 INTRODUCTION

Your new stud welding equipment has been carefully constructed using the finest components and material available. Used properly, this equipment will give you many years of profitable, efficient service.

The system incorporates the latest in engineering advances for complete, reliable end welding of mild steel, stainless steel and aluminum fasteners.

A careful study of this manual will enable you to understand how the welder operates to insure proper performance under all conditions.

## 2.0 WARRANTY

The electrical and mechanical components of the stud welder are thoroughly performance inspected prior to assembly in the welder. The assembled welder is also completely performance tested.

All parts used in the assembly of the welder and its accessories are fully warranted for a period ninety (90) days for date of delivery.

Under the warranty, the manufacturer reserves the right to repair or replace, at their option, any defective part or parts which fail during the warranty period. Notice of any claim for warranty repair or replacement must be furnished to the manufacturer by the purchaser within ten (10) days after the defect is first discovered.

The manufacturer does not assume any liability for paying shipping costs or for any labor or material furnished where such costs are not expressly authorized in writing.

The manufacturer does not warrant any parts or accessories against failures resulting from misuse, abuse, improper installation, maladjustment or use not in accordance with the operating instructions furnished by the manufacturer. The warranty is valid only when studs are purchased from sources approved by the manufacturer or are of identical specifications to the manufacturers.

## 3.0 UNPACKING YOUR UNIT

Upon receipt of your unit, place it as close as possible to the point of installation before unpacking it. Once the unit is unpacked, it is recommended that you inspect it for any physical damage that may have occurred in shipping.

Your unit has been completely assembled and inspected at the factory. Upon receipt, the unit must be hooked up to the recommended incoming power before welding.

Place the unit in a large enough area to provide adequate ventilation. Do not restrict the air flow around the front louvers or from the fan at the rear of the unit. Do not allow water to enter the unit in any way.

## 4.0 SUGGESTED SAFETY PRECAUTIONS

In any welding operation, it is the responsibility of the welder to observe all safety rules to insure his or her personal safety and to protect those working in the area.

Reference is directed without endorsement or recommendation to ANSI Z49.1, Safety in Welding and Cutting, and to AWG Publication A6,1-66, Recommended Safe Practices for Gas-Shielded Arc Welding.

### 4.1 Personal Safety Precautions

1. Always treat electricity with respect. Under open circuit conditions, the welding machines output voltage may be dangerous.
2. Don't work on live circuits or conductors. Disconnect the main power before checking the machine or performing any maintenance or repair operations.
3. Be sure the welding machine cabinet is properly grounded to a good electrical ground. Consult local electrical codes.
4. Never operate a welder in the rain, or operate a welder while standing in water. Avoid wearing wet or sweaty clothes when welding.
5. Don't operate with worn or poorly connected cables, and don't operate the weld gun with loose cable connections. Inspect all cables frequently for insulation failures, exposed wires, loose connections and repair as needed.
6. Don't overload welding cables or continue to operate with over heated cables.
7. Don't weld near flammable materials or liquids in or near the area, or on ducts or pipes carrying explosive gases.
8. Don't weld on containers which have held combustible or flammable materials, or on materials which give off flammable or toxic vapors when heated.



9. Be sure to provide proper ventilation when welding in a confined area.
10. Never look at the electric arc without wearing protective eye shields.
11. Always use the proper protective clothing, gloves, etc.
12. Never strike an arc when near a bystander who is unaware of the dangers of ultraviolet light to their eyes.

## 4.2 Power Supply Safety Precautions

1. Always connect the frame to the power supply to ground in accordance with the National Electric Code and the manufacturer's recommendation.
2. Installation, servicing or trouble shooting should be done by qualified personnel trained to work on this type of equipment.
3. Before servicing this piece of equipment, turn off the disconnect switch at the fuse box.
4. When in operation, all the covers must be on the equipment.

## 5.0 GENERAL DESCRIPTION

### THE PROCESS

Stud welding is a time saving tool which semi-automatically arc welds the FULL CROSS-SECTION of a weld stud to the base material in a fraction of a second and develops superior strength over normal arc welding procedures.

Since the ARC-1850 stud welding system provides the proper arc length and allows you to select the proper arc time and welding current, the variables that affect weld quality are minimized.

### THE UNIT

The ARC-1850 is a fully regulated stud welding power supply that is available in a single or dual gun version. Both versions have the constant output feature that allows the unit to be used as a power source that can operate external stud welding control units. An added feature in the ARC-1850 is the ability to dial in the desired weld time and weld current before even making a weld. By selecting the setup mode, the weld time and current can be adjusted and displayed on the front panel's digital meters.

A specially designed electronic gun control circuit has been incorporated in this system. If a fault condition occurs due to a shorted gun solenoid or a faulty control cable, the circuit will prevent gun triggering and eliminate damage to printed circuit boards. The ARC-1850 system is capable of welding studs from 12ga. to 3/4" diameter with precision and repeatability.

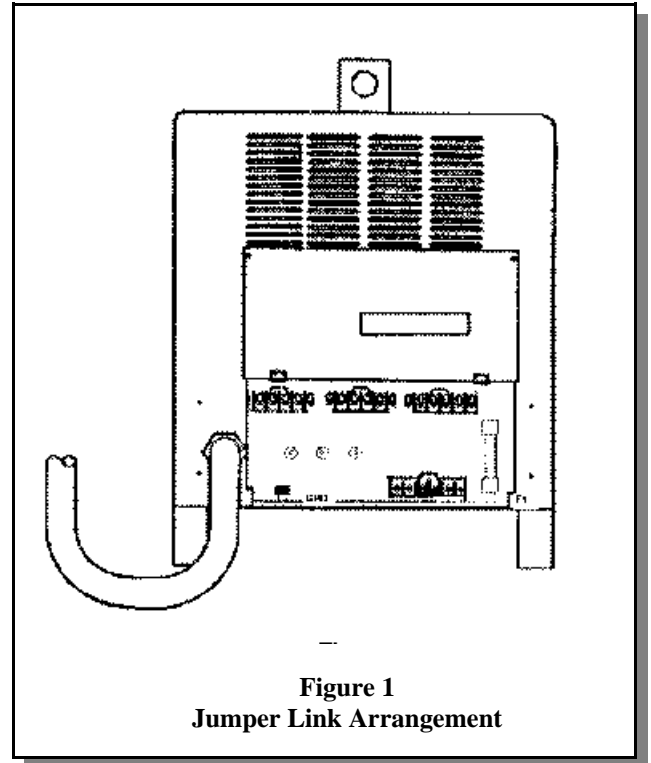
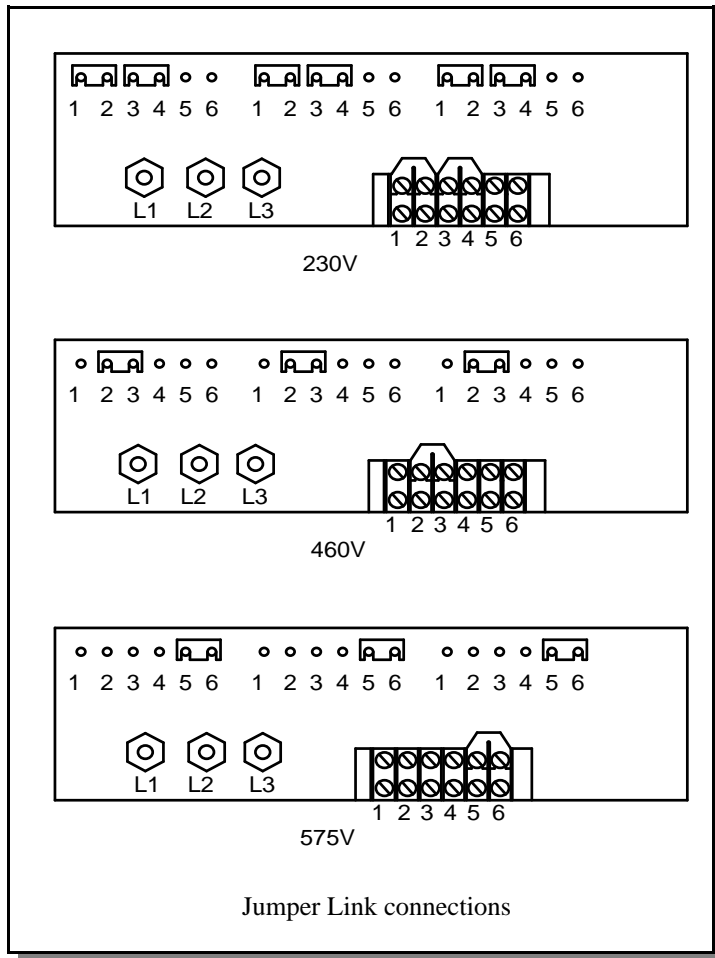
## 6.0 ELECTRICAL INPUT REQUIREMENT

This welding power source is designed to be operated from three-phase, 60 Hertz, AC power supply which has a line voltage rating that corresponds with one of the electrical input voltage shown on the nameplate or input data label. Consult the local electric utility if there is any question about the type of electrical system available at the installation site or how proper connections to the welding power source are to be made.

The **ARC-1850** should be operated from a separate fused or circuit breaker protected circuit. Install three primary leads plus one ground wire (see tables for proper wire and fuse sizes) through the inlet hole in the rear of the unit, using proper strain relief. The primary cables connect to the terminals L or line. The fourth lead (ground connection) should be fastened to the welder from the ground bolt. The other end of the ground lead or cable should be attached to a suitable ground such as a water pipe, ground rod, etc.

This unit is equipped with input voltage jumper links either installed or in a bag on the jumper link board to allow operation from different line voltages. If installed, the jumper links are positioned for the highest voltage stated on the nameplate or on the input data label. In either case the jumper links should always be checked to see if they are properly positioned for the voltage being used.

Open the access door located on the lower portion of the rear panel to expose the jumper link board. If necessary, reposition the jumper links to match the line voltage being used. (see Figure 6.1)



PRIMARY WIRE		DELAY TYPE FUSE	
SIZE-	AWG	GND	SIZE IN AMPS
230V	NO.1(2)	NO.2	200
460V	NO.4(6)	NO.6	100
575V	NO.4(6)	NO.6	90

**CAUTION**

The stud labeled GND is connected to the unit chassis and is for grounding purposes only. Do not connect a wire from the terminal labeled GND to one of the three-phase line terminals as this may result in "hot" power unit chas-

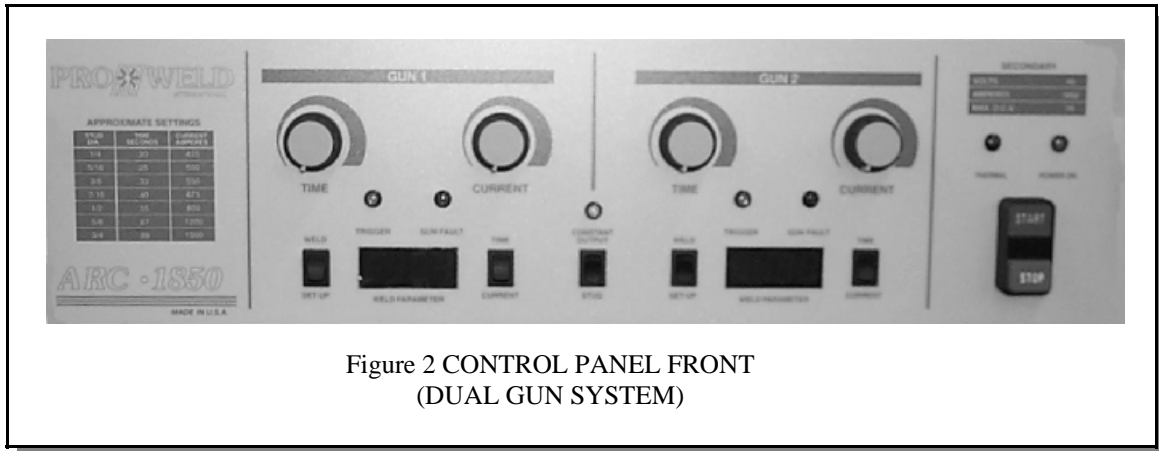


Figure 2 CONTROL PANEL FRONT  
(DUAL GUN SYSTEM)

## 7.0 CONTROL PANEL DESCRIPTION

### START/STOP PUSH BUTTON

Momentarily depressing the START button will energize the main contactor inside the unit allowing all circuits to be activated and the the cooling fan to run. Momentarily depressing the STOP button will deactivate the entire machine.

### STUD/CONSTANT OUTPUT SWITCH

When this switch is in the stud position, the unit is a dedicated stud welding power supply with built in time and current controls. When in the constant output position the unit becomes a welding power supply that can operate an external control box.

### WELD/SETUP SWITCH

This switch directs the digital panel meter to display either the setup parameters or the actual weld parameters. This switch must be in the weld position for the unit to weld.

### TIME/CURRENT SWITCH

This switch selects either the weld time or weld current that is to be displayed on the digital meter.

### WELD TIME ADJUSTMENT

Select: SETUP, TIME and adjust the time control knob until the digital meter displays the desired time. Return setup switch to WELD before attempting to weld. The weld time is adjustable from .1 to 1.6 seconds.

### WELD/CURRENT ADJUSTMENT

Select: SETUP, CURRENT and adjust the current control knob until the digital meter displays the desired current. Return setup switch to WELD, before attempting to weld. Weld current is adjustable from 100 to 1900 amps.

### DIGITAL PANEL METERS

Displays weld time or weld current. After a stud weld, the digital meter will automatically display the actual weld parameters. The meter will automatically reset and display the time or current for each weld.

### TRIGGER LED INDICATOR

The trigger LED “on” indicates a complete circuit to the unit through the gun control cables and gun switch. This LED will turn “on” when the gun trigger is pressed.

### GUN FAULT LED INDICATOR

The gun fault LED “on” indicates a shorted gun solenoid or a shorted control cable. The LED will stay “on” and lock out the gun from triggering.

### THERMAL LED INDICATOR

The thermal LED “on” indicates the internal temperature has reached the maximum rated temperature in either the weld bridge or the main transformer. LED “on” will prevent the gun from being triggered.

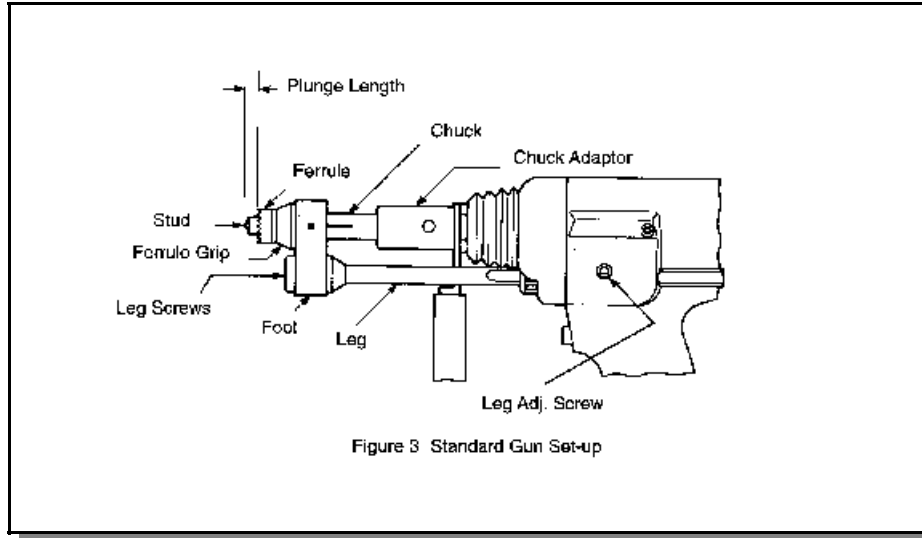


Figure 3 Standard Gun Set-up

## 8.0 WELD GUN SET-UP

### 8.1 Plunge Length

1. A different and correctly sized chuck and ferrule grip are needed for each different stud diameter and style that will be welded (see PRO WELD Accessories catalog for help in this area). The appropriate chuck, or stud holder, is inserted into the tapered chuck adaptor and tapped lightly to insure a tight fit. The ferrule grip is inserted in the hole in the foot and secured with the locking screws to hold it in place.
2. Studs must NOT bind or hang up on the foot, ferrule grip, or ferrule during the entire stud welding process. To assure this, the foot/ferrule arrangement must be centered in relation to the stud to be welded. To assure centering, loosen the leg screws that hold the foot to the legs. Place a stud in the chuck and a ferrule in the ferrule grip. With the leg screws loosened, the foot will move freely in all directions. Adjust the foot so that the stud is centered in the ferrule and no contact occurs between the stud and the ferrule during retraction or forward plunge of the stud.
3. The “plunge length” is the amount of the stud exposed beyond the ferrule during initial set-up. Set the plunge by loosening the leg adjusting screws and moving the foot until the stud extends 1/8” to 3/16” past the end of the ferrule. Tighten the leg adjusting screws after setting the plunge and recheck centering to be sure the stud is aligned properly in the ferrule.
4. The lift height, which determines the arc length, has been preset at the factory and will automatically lift and plunge the stud during the welding process. “Lift”, is the distance the gun will raise the stud above the welding surface during the weld. This distance governs the voltage and the arc. Improper lift will cause unsatisfactory welds. Refer to paragraph 8-1 if it becomes necessary to ad-

5. Make sure that the cables are connected to the power source (standard set-up is straight polarity - Negative to controller (or gun) and Positive (ground cable) to the work surface).

6. Turn on the power supply and adjust the current and time for the weld base diameter of the fastener to be welded.

7. Place the gun, loaded with the stud and ferrule, squarely against the grounded work surface. The main spring in the gun will take up the “plunge length” and the ferrule will seat against the base plate.

### **DO NOT MOVE THE GUN DURING THE WELD CYCLE**

8. Pull the trigger holding the gun completely still as above. The gun will lift the stud from the base plate and draw an arc. The end of the stud and the adjacent material of the base plate, will be melted by the weld arc. The gun will then plunge the stud into the molten pool, extinguishing the arc, to end the controlled portion of the weld cycle.

9. After the controlled weld cycle, allow the molten metal to solidify briefly with the work surface to assure completion of the cycle (about an extra second holding “still” after the weld is usually sufficient).

10. Remove the gun from the work by lifting straight away from the welded stud (this will assure better life to the gun's expendable accessories). The ferrule may now be removed by breaking it away from the welded stud to allow inspection of the weld results. After inspection of sample welds the gun can be adjusted, as per the step in this procedure, for optimum results.

## 8.2 Checking Gun Lift

To measure lift, turn the stud welding unit on and set the timer to maximum time. (On certain units there may be a Lift Check switch available, and in these cases this switch can be used to check lift.) Trigger the gun in the air, or on a non-grounded or insulated surface, to observe the lift cycle. Measuring the distance the stud or gun mechanism moves equals lift - usually this can be easily done by visual observation or simple measurement against a static reference point (i.e. the ferrule properly seated in the ferrule grip).

### Recommended Lift Settings.

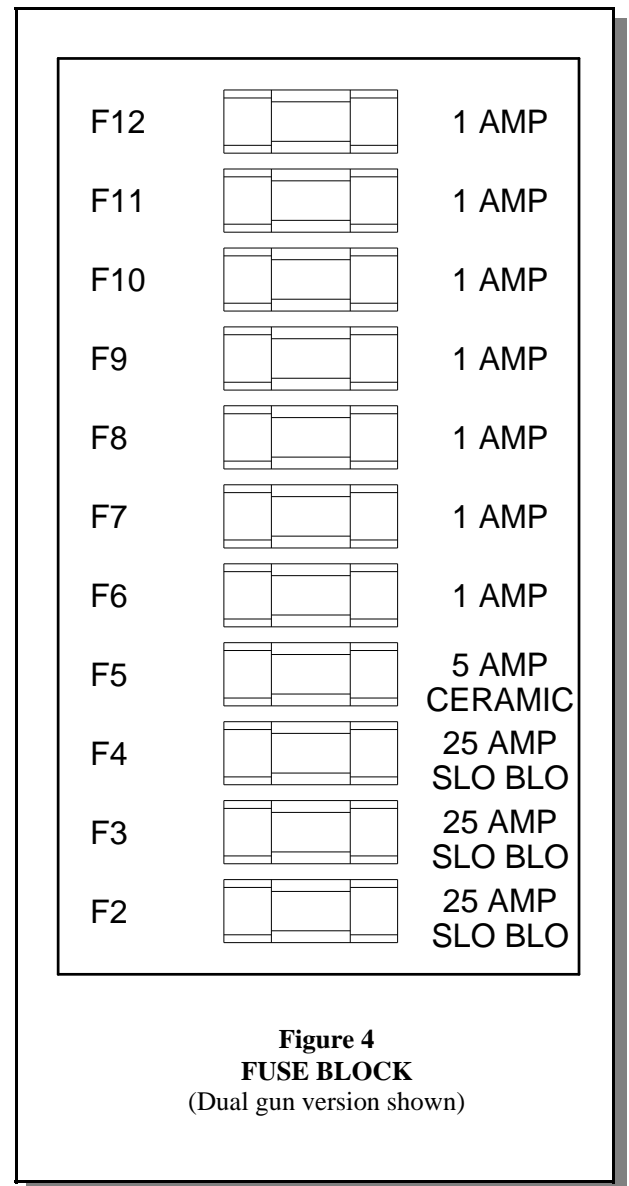
Stud Base Dia.	Lift Setting
Less than 1/2"	1/16"
1/2" through 3/4"	3/32"
Greater than 3/4"	7/64"

When it does become necessary to adjust lift, you do so by removing the rear cap from the gun. This will expose the rear coil yoke assembly, the set screw and the lift adjusting screw (Loosen the set screw to avoid damaging the threads of the lift adjusting screw).

To increase lift: turn the lift adjusting screw out (counter clockwise).

To decrease lift: turn the lift adjusting screw in (clockwise).

Once the lift has been set, tighten the set screw and replace the rear cap.



**Figure 4**  
**FUSE BLOCK**  
(Dual gun version shown)

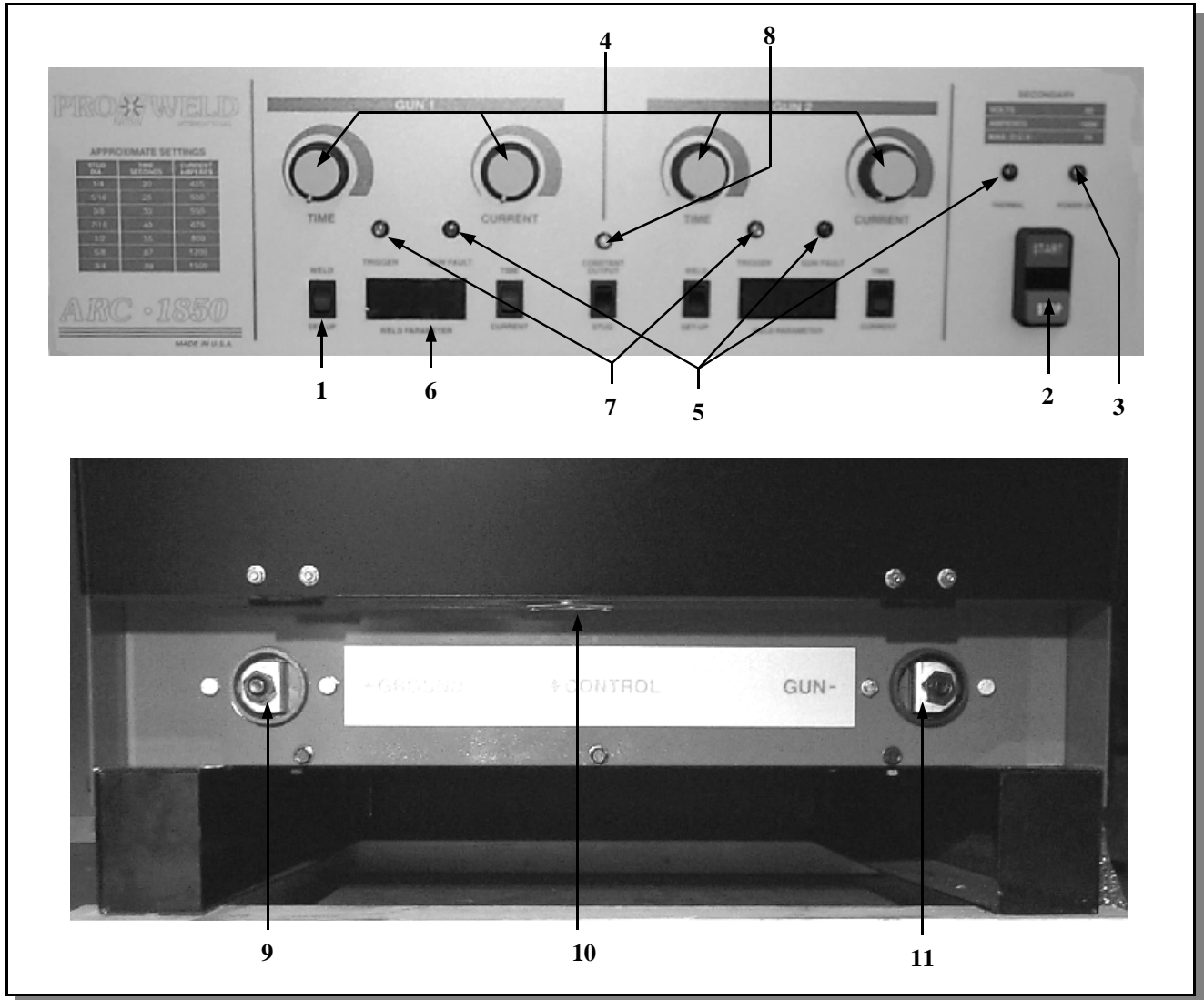
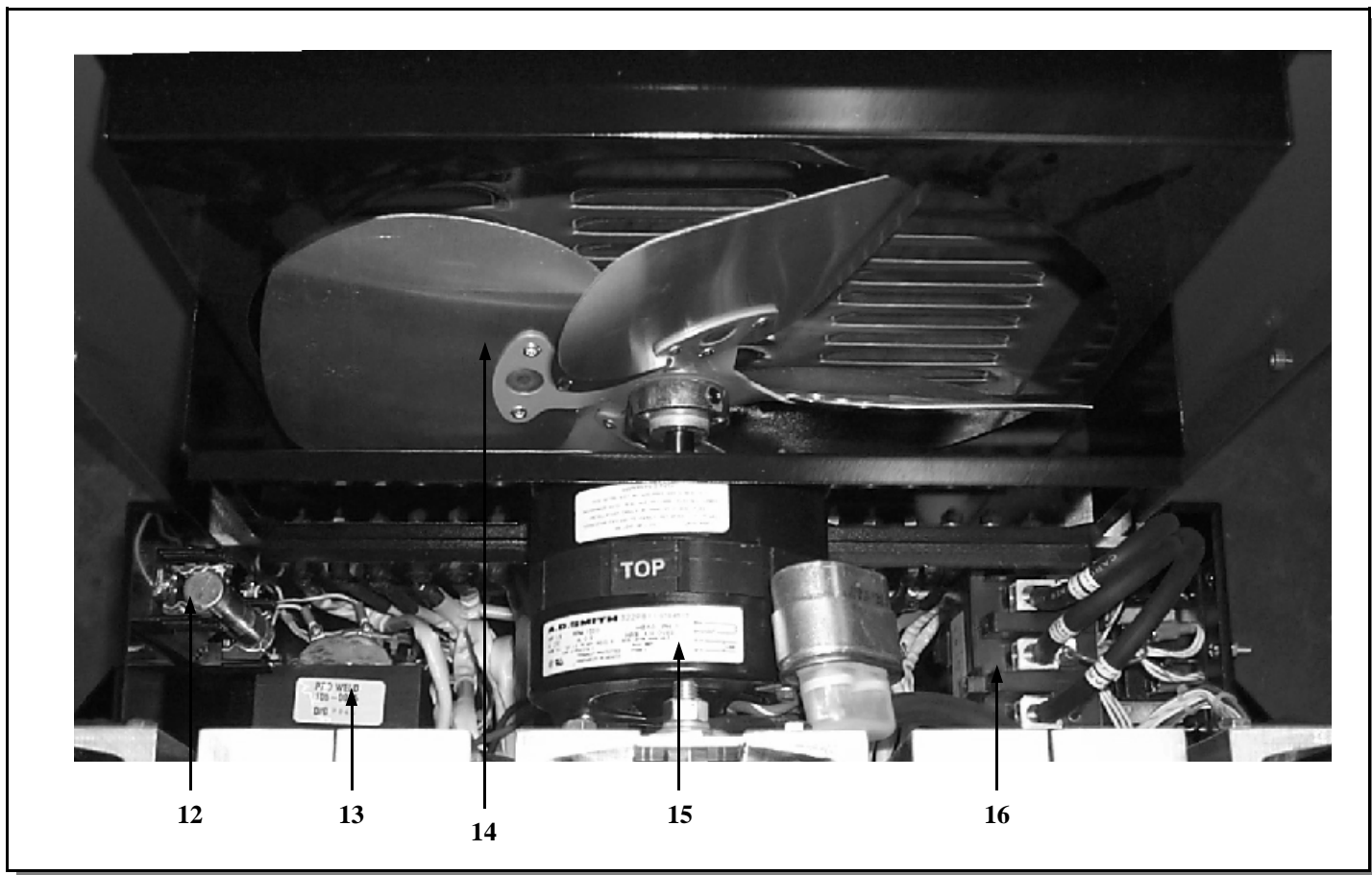


Figure 5 Control Unit (Front View)

9.0 PARTS LIST

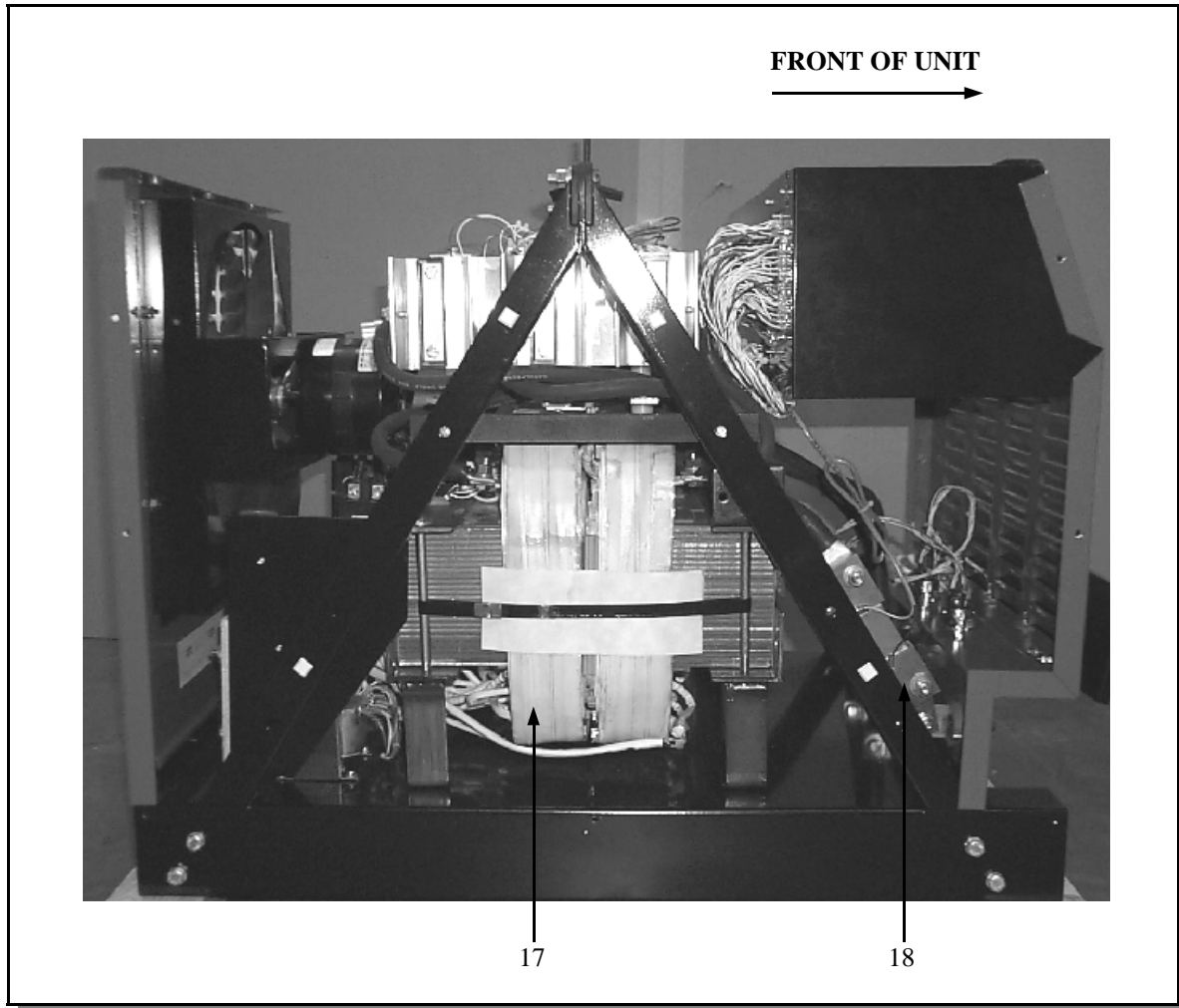
ITEM	DESCRIPTION	PART NUMBER
1	Switch	104-0014
2	On/Off Operator	104-0016
2	N.O. Contact	104-0017
2	N.C. Contact	104-0018
3	Power Light (Green Neon)	102-0087
4	Knob	102-0060
4	20k Potentiometer	111-0012
5	Red LED	108-0028
6	Panel Meter	103-0004
7	Green LED	108-0029
8	Amber LED	108-0030
9	Positive Output Terminal	102-0058
10	4 Pole Panel Mounted Connector	107-0001



**Figure 6 Control Unit  
Rear**

**9.0 PARTS LIST**

ITEM	DESCRIPTION	PART NUMBER
12	Fuse 6 amp 600 volt	102-0007
13	Control Transformer	105-0015
14	Fan Blade 14"	102-0083
15	Fan Motor	102-0085
16	Start Contactor	113-0017

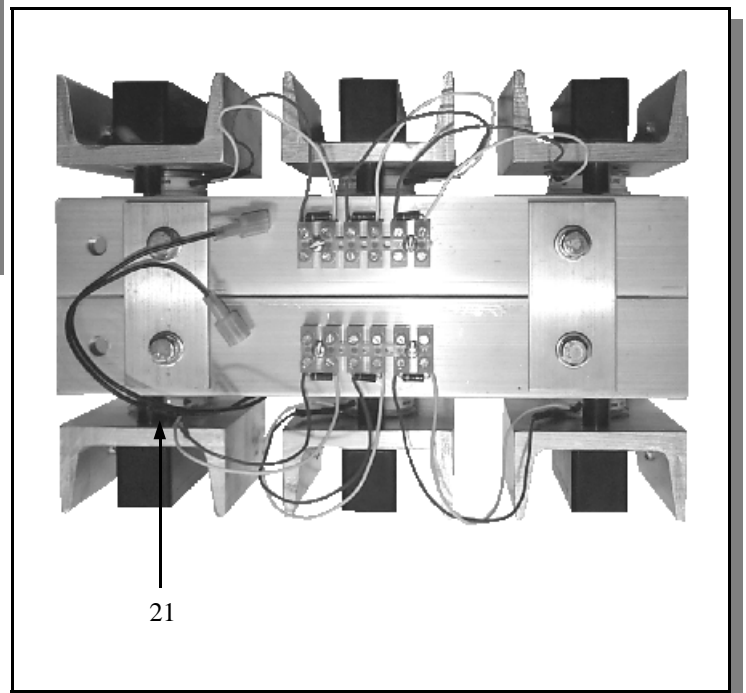
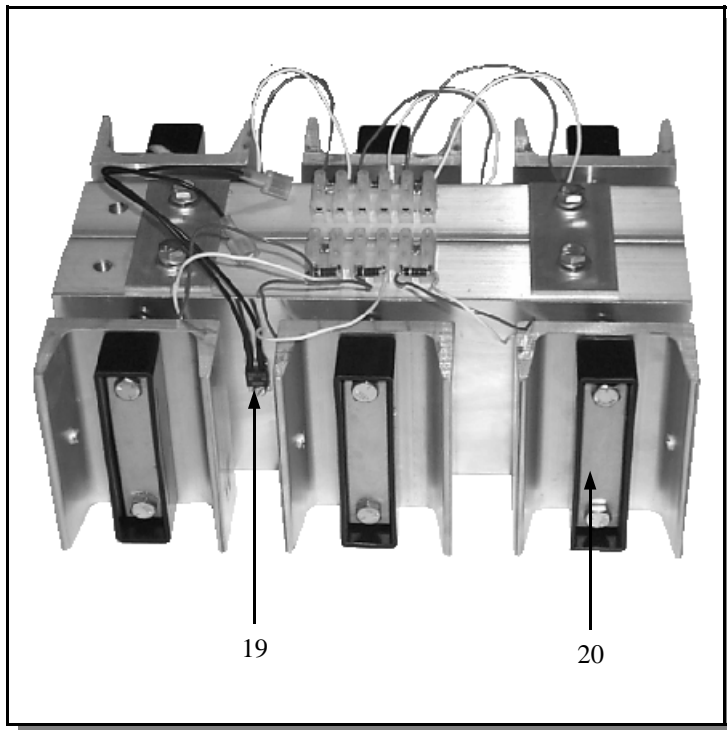


**Figure 7 Control Unit  
Side View**

**9.0 PARTS LIST**

<b>ITEM</b>	<b>DESCRIPTION</b>	<b>PART NUMBER</b>
17	Main Transformer	105-0023
18	Shunt	102-0107

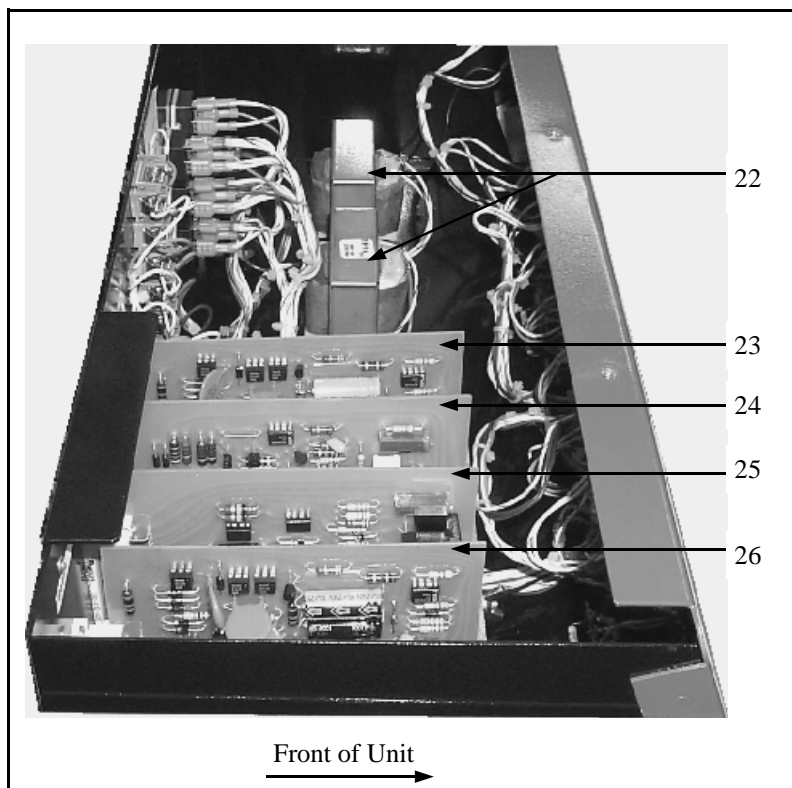




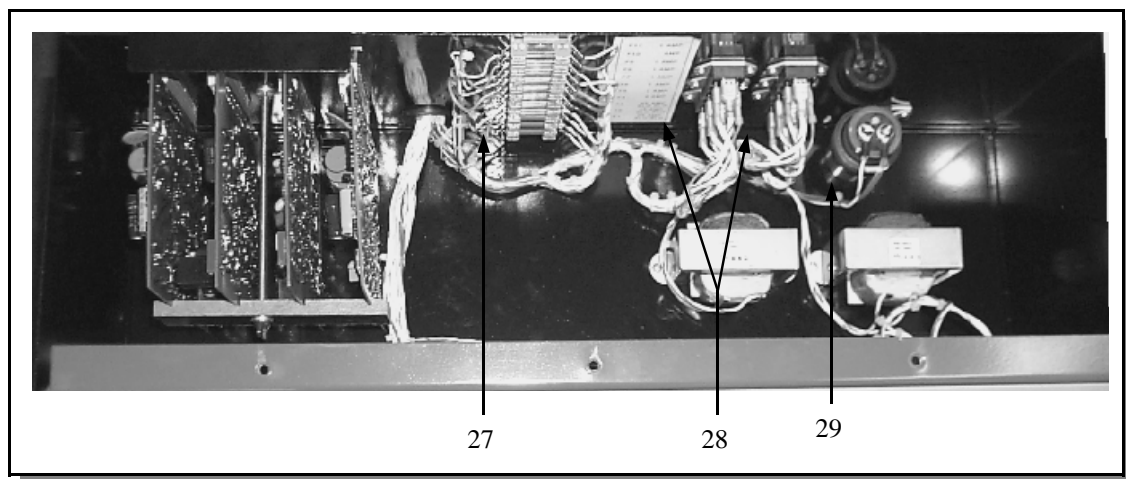
**Figure 8**  
**RECTIFIER, SCR ASSEMBLY**  
**SIDE AND TOP VIEW**

**9.0 PARTS LIST**

ITEM	DESCRIPTION	PART NUMBER
19	Weld SCR Thermostat	102-0032
20	Weld SCR Clamp	102-0109
21	Weld SCR	108-0058

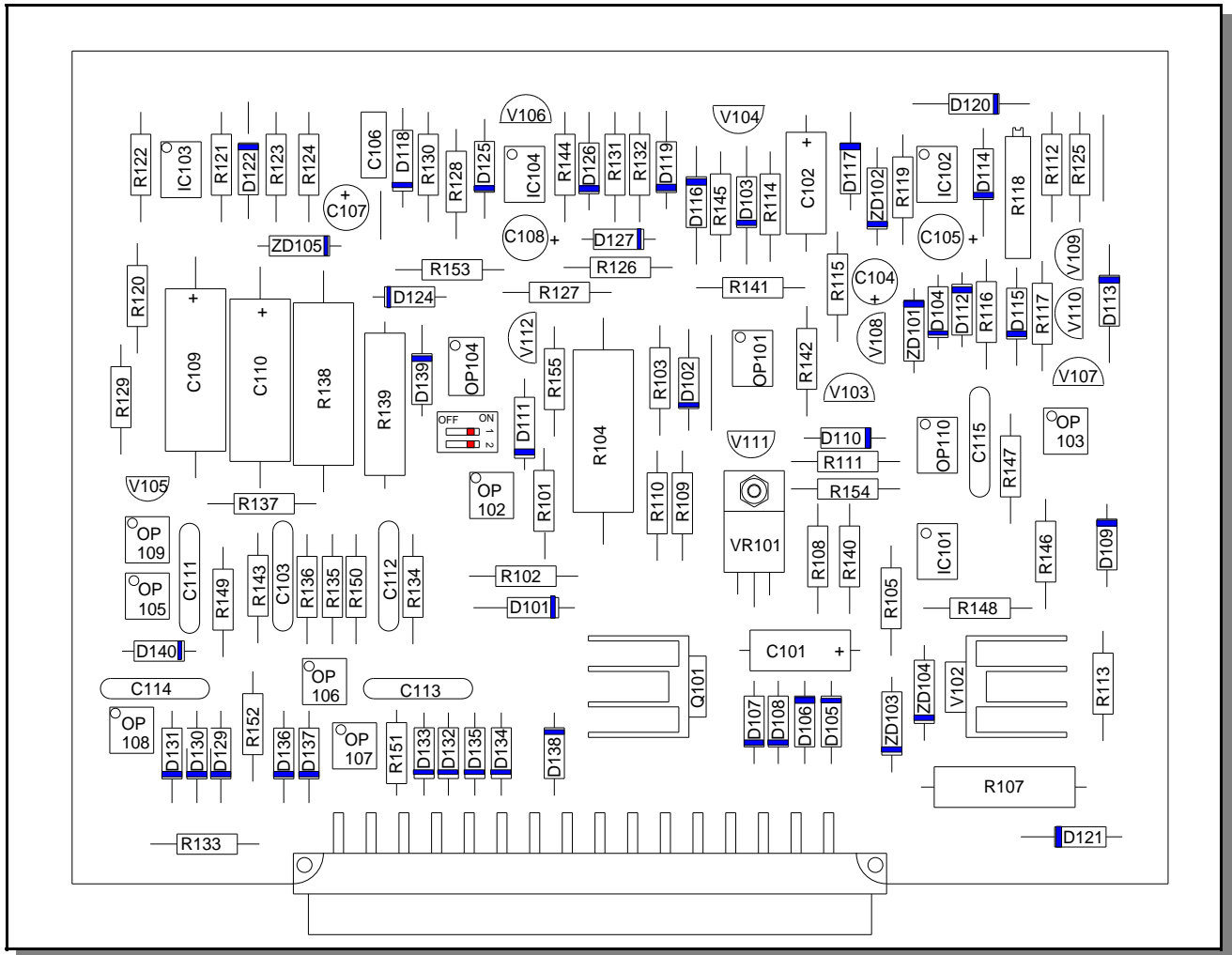


**Figure 9**  
**Printed Circuit Board Enclosure**  
**Top and Side View**

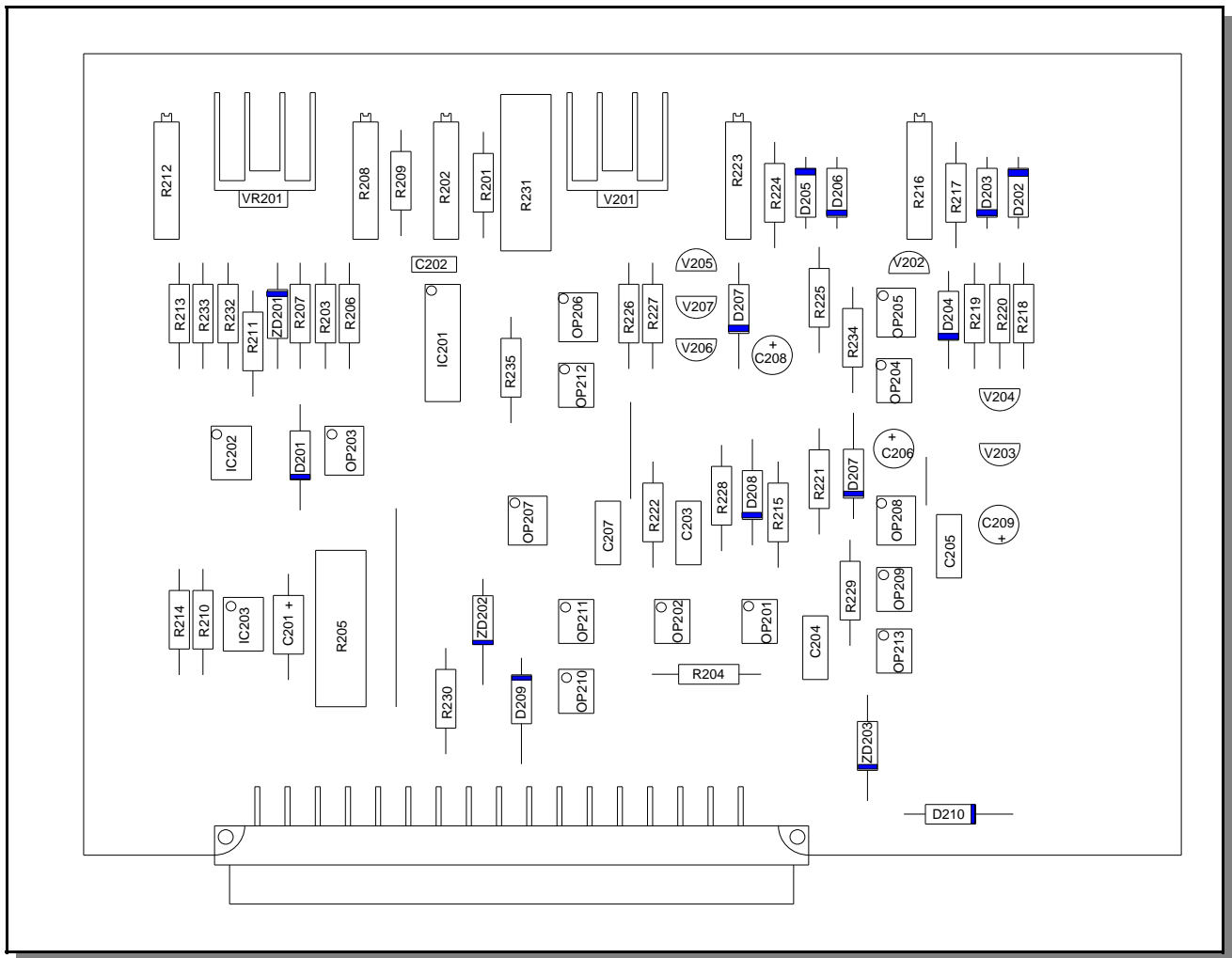


## 9.0 PARTS LIST

ITEM	DESCRIPTION	PART NUMBER
22	Choke Coil	105-0004
23	Time Control P.C.Board	600-0010
24	Current Control P.C.Board	600-0012
25	Monitor Control P.C.Board	600-0011
26	Time Control P.C.Board	600-0010
27	Fuse Block	104-0015
28	Sustaining arc SCR	108-0042
29	Gun Discharge Capacitor	106-0024



**Figure 10**  
**GUN TIME CONTROL P.C. BOARD**  
**P/N 600-0010**



**Figure 11**  
**MONITOR P.C. BOARD**  
**P/N 600-0011**

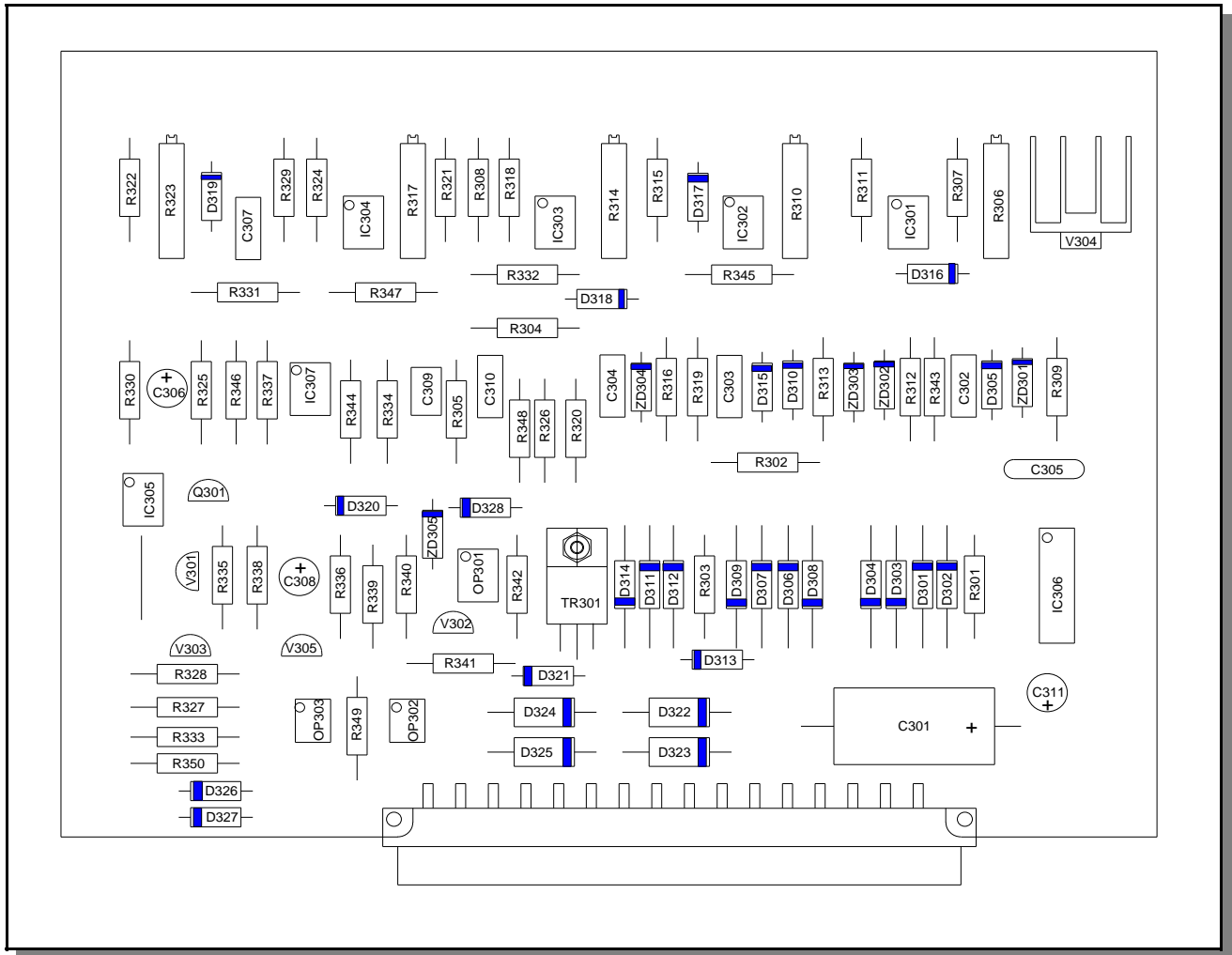


Figure 12  
CURRENT CONTROL P.C. BOARD  
P/N 600-0012

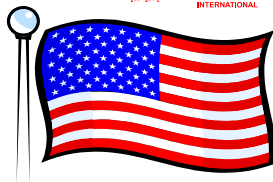
## 10.0 TROUBLE SHOOTING

Whenever possible, have a qualified electrician do the maintenance and trouble shooting work. Turn the input power off using the disconnect switch at the fuse box before working inside the machine.

Trouble	Possible Cause	What To Do
Unit trips off without welding.	<ol style="list-style-type: none"> <li>1. Defective main SCR.</li> <li>2. Defective sustaining arc SCR.</li> <li>3. Defective 600-0012 P.C. board.</li> <li>4. Defective 600-0010 P.C. board.</li> <li>5. Shorted control cables.</li> </ol>	<ol style="list-style-type: none"> <li>1. Check for defective SCR and replace.</li> <li>2. check and replace.</li> <li>3. Replace.</li> <li>4. Replace.</li> <li>5. Repair.</li> </ol>
Low output.	<ol style="list-style-type: none"> <li>1. Input fuse blown. Unit is single phase.</li> <li>2. Incorrect jumper link connection on primary board.</li> <li>3. Defective 600-0012 P.C. board.</li> <li>4. Defective 600-0010 P.C. board.</li> <li>5. Defective current potentiometer.</li> </ol>	<ol style="list-style-type: none"> <li>1. Replace fuse, repair input line. Check for reason for fault.2.</li> <li>2. Check jumper links on primary board for proper voltage.</li> <li>3. Replace.</li> <li>4. Replace.</li> <li>5. Replace.</li> </ol>
Maximum output but no control.	<ol style="list-style-type: none"> <li>1. Defective 600-0012 P.C. board.</li> <li>2. Open lead going to shunt (shielded cable).</li> <li>3. Defective current potentiometer.</li> </ol>	<ol style="list-style-type: none"> <li>1. Replace.</li> <li>2. Repair broken leads on connection.</li> <li>3. Replace.</li> </ol>
Gun does not lift.	<ol style="list-style-type: none"> <li>1. Blown 4 amp fuse.</li> <li>2. Defective 600-0010 P.C. board.</li> <li>3. Defective control cable or gun coil.</li> <li>4. Defective 600-0012 P.C. board.</li> <li>5. Defective 600-0011 P.C. board.</li> <li>6. Unit Overheated.</li> <li>7. Defective thermal switch.</li> </ol>	<ol style="list-style-type: none"> <li>1. Check and replace fuse.</li> <li>2. Replace.</li> <li>3. Repair short in cable, replace gun coil.</li> <li>4. Replace.</li> <li>5. Replace.</li> <li>6. Allow unit to cool/ then reduce weld rate to prevent reoccurrence.</li> <li>7. Check and replace.</li> </ol>
Gun lifts but does not weld.	<ol style="list-style-type: none"> <li>1. Blown 25 amp sustaining arc fuse.</li> <li>2. Defective sustaining arc SCR(s).</li> <li>3. Defective 600-0010 P.C. board.</li> <li>4. Defective 600-0012 P.C. board</li> <li>5. Defective choke coil.</li> <li>6. Open weld cable or bad weld ground connection.</li> </ol>	<ol style="list-style-type: none"> <li>1. Check and replace fuse.</li> <li>2. Replace bad part(s).</li> <li>3. Replace.</li> <li>4. Replace.</li> <li>5. Check and Replace.</li> <li>6. Check and Repair.</li> </ol>
Gun lifts but does not plunge	<ol style="list-style-type: none"> <li>1. Defective 600-0010 P.C. board.</li> <li>2. Defective time potentiometer.</li> </ol>	<ol style="list-style-type: none"> <li>1. Replace.</li> <li>2. Replace.</li> </ol>
Display inoperative	<ol style="list-style-type: none"> <li>1. Defective 600-0011 P.C. board.</li> <li>2. Defective display.</li> </ol>	<ol style="list-style-type: none"> <li>1. Replace.</li> <li>2. Replace..</li> </ol>



MANUFACTURED BY  
**PRO WELD**  
INTERNATIONAL



MADE IN THE U.S.A.