

*e-sphyg*TM 2

9002

Automatic Sphygmomanometer



User's Manual

A Special Thank You...

Thank you for choosing an ADC® blood pressure instrument. We're proud of the care and quality that goes into the manufacture of each and every item that bears our name. Only the finest materials are used to assure you of a timeless instrument designed for optimum performance.

You'll quickly appreciate the results, for you now own one of the finest sphygmomanometers that money can buy.

With proper care and maintenance, your ADC® blood pressure instrument is sure to provide you with many years of dependable service. Please read the following instructions and general information which will prove helpful in allowing you to enjoy your ADC® product.

Advantages of Digital

Your new ADC® *e-sphyg*™ 2 sphygmomanometer is intended to provide you with all of the functionality of a traditional sphygmomanometer, with none of the problems associated with these devices. Using state-of-the-art technology, your *e-sphyg*™ 2 sphygmomanometer will provide you with performance, versatility, and reliability exceeding the most popular aneroid and mercurial instruments.

Its dual mode design will permit the instrument to fully measure a patient's blood pressure and pulse automatically. In manual mode, it allows you to use the time proven auscultatory method to obtain blood pressure readings.

Thank you for your patronage. It is indeed our pleasure to serve you.

Sincerely,
American Diagnostic Corp.

ADC® 9002 *e-sphyg*™ 2

Table of Contents

Introduction and Intended Use	4
Warnings and Precautions	5
Product Features	6
Name and Function of Each Part	7-8
Preparation for Use	9-10
How to Assemble Wall Model	11
How to Assemble Mobile Model	12
Cuff Connections	13
Taking Blood Pressure	13-16
Memory Function	17
Error Displays and Troubleshooting	18-20
Care and Maintenance	21
Wall Unit Parts and Tools	22
Mobile Unit Parts and Tools	23
Mobile Base Assembly Parts	24
Specifications	25
Limited Warranty	26
Replacement Parts	27

This manual is intended to assist the user in the safe and efficient operation of the Automatic Sphygmomanometer 9002. The product must be used in accordance with the procedures contained in this manual and must not be used for purposes other than those described herein. It is essential to read and understand the entire manual.

Introduction and Intended Use

The 9002 digital ADC® *e-sphyg*™ 2 sphygmomanometer is a digital sphygmomanometer intended for measurement of systolic and diastolic blood pressure and pulse rate in adult patients, i.e., age 12 and above. This product is not designed for neonatal use. Inaccurate readings may result if it is used on a child's arm.

Accuracy was evaluated during clinical studies in which results with the 9002 digital ADC® *e-sphyg*™ 2 sphygmomanometer were compared with simultaneous auscultatory measurements obtained with a standard sphygmomanometer. In these studies, the onset of the fourth (or fifth) Korotkoff sound was taken as the diastolic pressure for the purpose of determining overall efficacy. A copy of this study is available from ADC® on request. To ensure that accuracy is maintained, compare readings obtained with the 9002 digital ADC® *e-sphyg*™ 2 sphygmomanometer with values measured by a trained observer using a manual sphygmomanometer at least every 6 months.

Blood pressure measurements determined with this device are equivalent to those obtained by a trained observer using the cuff stethoscope auscultatory method, within the limits prescribed by the American National Standard, Manual, electronic, or automated sphygmomanometers.

The 9002 digital ADC® *e-sphyg*™ 2 sphygmomanometer has the ability to function according to its specifications in the presence of common arrhythmia such as atrial or ventricular premature beats or atrial fibrillation.

Warnings and Precautions

Warning - A warning statement in this manual identifies a condition or practice which, if not corrected or discontinued immediately could lead to patient injury, illness, or death.

Warning - If luer lock connectors are used in the construction of tubing, there is a possibility that they might be inadvertently connected to intravascular fluid systems, allowing air to be pumped into a blood vessel. Immediately consult a physician if this occurs.

Warning - Do not allow a blood pressure cuff to remain on patient for more than 10 minutes when inflated above 10mmHg. This may cause patient distress, disturb blood circulation, and contribute to injury of peripheral nerves.

Warning - Safety and effectiveness with neonate cuff sizes 1 through 5 is not established.

Warning - For all blood pressure systems that can be wall mounted, ensure that the unit is securely mounted prior to use to avoid damage to the instrument and potential patient injury.

Warning - Do not use the 9002 in an explosive environment such as where flammable anesthetics exist or inside an oxygen chamber with strong electrostatic and electromagnetic fields e.g., mobile phones.

Warning - Use of this instrument on patients under dialysis therapy or on anticoagulant, antiplatelets, or steroids could cause internal bleeding.

Warning - Do not use cuffs, AC adapters or batteries other than those included with this product or replacement parts supplied by the manufacturer.

Warning - This system may fail to yield specified measurement accuracy if operated or stored in temperature or humidity conditions outside the limits stated in the specifications section of this manual.

Warning - When using with an infant or child cuff, extra care must be taken to prevent over-inflation. To prevent discomfort or injury to the patient, ensure preset pressure is not set above the desired level.

Warning - This product may contain a chemical known to the state of California to cause cancer, birth defects, or other reproductive harm.

Caution - Federal law restricts this device to sale by or on the order of a physician or licensed healthcare practitioner.

Caution - To avoid any possibility of accidental strangulation, keep this unit away from children and do not drape tubing around your neck.

Note - To obtain the greatest accuracy from your blood pressure instrument, it is recommended that the instrument be used within a temperature range of 50°F (10°C) to 104°F (40°C), with a relative humidity range of 15-90% (non-condensing).

Note - All connectors and inflation system should remain connected to the device during storage to avoid dust entering through the connector port.

Product Features

DUAL DISPLAY -

COLUMN LCD and SEGMENT LCD (Simulated Mercury Column)

The pressure can be read in the column LCD height and as digital value in the segment LCD.

DUAL MEASUREMENT MODE -

"AUTO" and "MANUAL" Modes of Measurement

Determination of blood pressure can be made either automatically by the oscillometric method or manually by the auscultatory method using a stethoscope.

MODE	DEFLATION RATE	MEMORY
AUTO	Maintained at 4.0 to 4.9mmHg/sec	Last measured result auto saved
MANUAL	Maintained at preset rates of: 2.5, 4.5 or 6.5mmHg/sec	N/A

Cuff Sizes (Auto Mode)

The Small Adult size cuff will accommodate arms of approximately 7.4 to 10.6 inches (19.0 to 27.0 centimeters). A Small Adult cuff should be used on patients 12 or older only (in auto mode).

The Adult size cuff will accommodate an upper arm circumference range of approximately 9.0 to 15.7 inches (23.0 to 40.0 centimeters).

The Large Adult size cuff will accommodate that of approximately 13.3 to 19.6 inches (34.0 to 50.0 centimeters).

Cuff Sizes (Manual Mode)

In manual mode, any of ADC's® 5 cuff sizes (child, small adult, adult, large adult or thigh) may be used, on any patient.

Operation with AC Adapter or Rechargeable Battery

The digital ADC® *e-sphyg*™ 2 sphygmomanometer is powered by either an AC Adapter or rechargeable nickel metal hybrid (NiMH) battery (both included).

Name and function of each part

MAIN UNIT

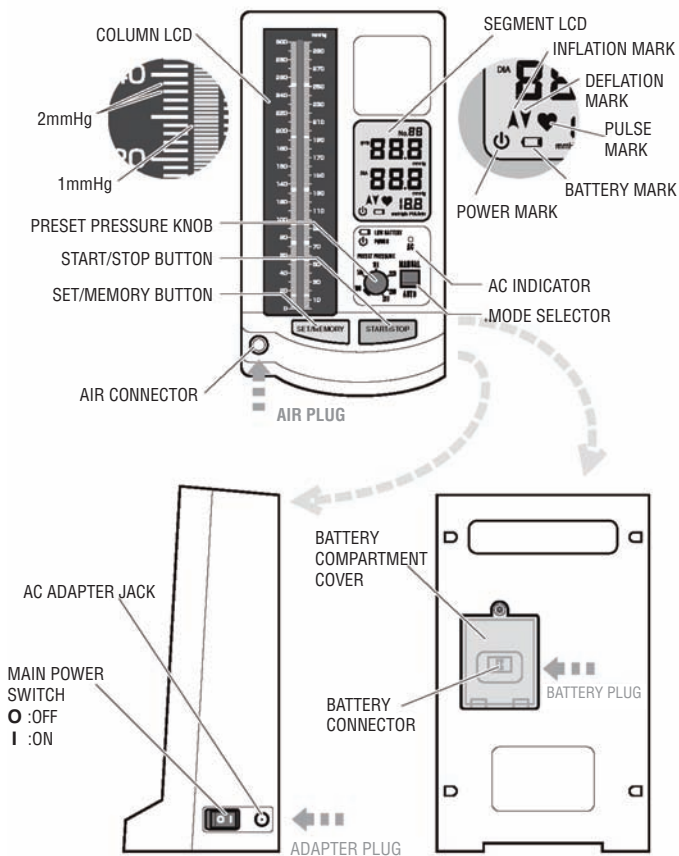

Name and function of each part

Cuff Sizes		
SMALL ADULT Arm circumferences of 7.4"-10.6" (19.0-27.0cm)	ADULT Arm circumferences of 9.0"-15.7" (23.0-40.0cm)	LARGE ADULT Arm circumferences of 13.3"-19.6" (34.0-50.0cm)

BLADDER TUBE
(Female Luer Connection)

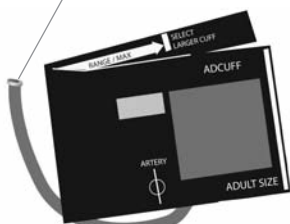

ADCUFF™

LUER CONNECTOR
(Male Luer to Female Bladder Tube)

COILED TUBING

AIR CONNECTOR
(to main unit)



AC ADAPTER



ADAPTER PLUG

RECHARGEABLE NICKEL METAL HYBRID (NiMH) BATTERY



BATTERY PLUG

INSTRUCTION MANUAL



Other parts included depending upon model selected.

Preparation for Use

Connecting and Using the AC Adapter (All models)

Connect AC ADAPTER PLUG to AC ADAPTER JACK

Plug AC ADAPTER in the power socket.

AC INDICATOR is lit when AC ADAPTER is connected correctly.

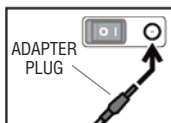

Installing the RECHARGEABLE NiMH Battery (All models)

NOTE: The battery enclosed in the product package is not charged, and needs to be charged for about 4 hours before use.

NOTE: Turn off the power and unplug AC ADAPTER before inserting the battery. Make sure "O" side of MAIN POWER SWITCH is pressed down.

Remove BATTERY COMPARTMENT COVER by loosening and removing the screw. (Fig. 1)

Connect BATTERY PLUG to BATTERY CONNECTOR inside the battery compartment and insert the battery. (Fig. 2)

Put back BATTERY COMPARTMENT COVER and close it by inserting and tightening the screw.

Connect AC ADAPTER PLUG and plug AC ADAPTER in the power socket to charge the battery. The battery is charged regardless of whether the e-sphyg™ 2 is powered on or off.

Orange light of AC INDICATOR indicates that the battery is being charged. (Fig. 3)

The battery is fully charged after approximately 4 hours.

Unplug AC ADAPTER after the light turns green as it indicates the battery is charged.

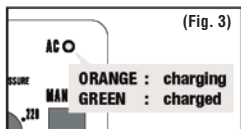
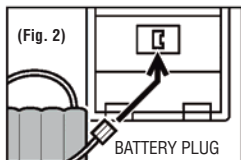
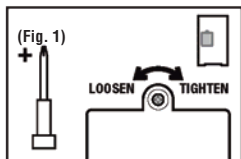

The color of the AC INDICATOR may switch to green and return to orange if the 9002 is operated while charging battery, however it does not indicate a problem.



BATTERY MARK flashes in the segment LCD when the battery charge is low. Only a few more measurements remain before the battery runs down.



The battery needs to be recharged when **BATTERY MARK** is displayed. Measurement cannot be made.

NOTE: The rechargeable batteries may not be completely full after their initial charge or when they have not been used for an extended period of time. This should be solved once the unit has been used a few times and the batteries have been charged and discharged.

Battery life

Life of the rechargeable NiMH battery is approximately 2 years. However it may vary depending on operating conditions. Replace the battery when **BATTERY MARK** is displayed often or when frequent charging of the battery becomes necessary.



Tips on prolonging the battery life

The device is powered by the AC ADAPTER when it is connected; the installed battery is not used if the AC ADAPTER is connected.



- Remove the battery when operating the device with the AC ADAPTER for an extended period of time or when the battery does not need to be charged.
- Avoid charging the battery if it is not completely exhausted.

Do not forcefully remove the battery or pull out the plugs holding cords and cables.



Use indicated AC Adapter and the battery only.
Contact your dealer if they are damaged.

POWER MARK

The device goes to energy saver mode when it is left turned on and not operated for approximately 3 minutes. The mark will be displayed for an hour and then disappear. Make sure to turn off the device by pressing "O" side of MAIN POWER SWITCH down after each use especially when the device is powered by the battery.

The device activates from energy saver mode when either START/STOP button or SET/MEMORY button is pressed. It is recommended to activate the device by pressing SET/MEMORY button since the device could start inflation if START/STOP button is pressed. Press START/STOP button again and stop inflation if the cuff is not wrapped around arm.

How to Assemble Wall Model

1. Securely attach wall bracket to flat surface using enclosed mollys and screws at desired height. *(It is advised to use a level to ensure proper mounting).* (Figure 1)
2. Attach manometer to wall bracket by lowering atop wall bracket, sliding male tab into female seat of the bracket. Secure the two together using the (6mm) allen bolt and washer from below. Tighten securely with large (6mm) allen wrench (Figure 2).
3. Securely attach cuff basket to flat surface to left of manometer using enclosed mollys and screws at desired height. *(It is advised to use a level to ensure even mounting)* (Figures 3 - 4).
4. Attach 8 foot length coiled tubing to air inlet on face of *e-sphyg 2™* (Figure 5). Insert "male" luer connector (891M) on free end of coiled tubing to "female" luer connector (891F) on bladder tubing (Figure 6). Fold cuff and store in basket.

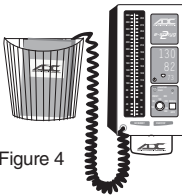
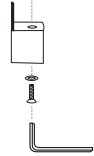
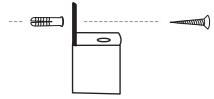

Figure 4

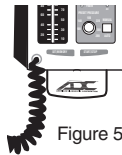

Figure 5

Figure 3



Figure 6

How to Assemble Mobile Model

1. With base on its side connect upright outer pole to base using large (6mm) allen bolt. Tighten with large (6mm) allen key provided. Tighten hardware as securely as possible. (Note: To prevent loosening, hardware must be tightened securely and periodically checked) (Figure 1).
2. Slide spring and stainless steel inner pole inside outer pole with open end up (Figure 2).
3. Loosen (3mm) allen bolt on collar of cuff storage basket with small (3mm) allen key provided. Place cuff storage basket on top of stainless steel inner pole making sure the pole goes completely inside collar and tighten allen bolt with key (Figure 3).
4. Attach manometer to basket using (6mm) allen bolt and washer as shown. Tighten securely with large (6mm) allen key (Figure 4).
5. **Connect tubing as noted in Wall configuration #4.**
6. Adjust height of manometer by loosening adjusting knob and raising or lowering inner pole until gauge is at desired height. Tighten adjusting knob by hand (Figure 5).

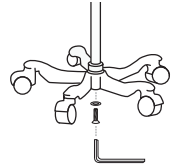

Figure 1

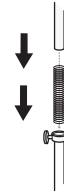

Figure 2



Figure 3

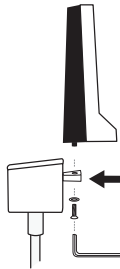

Figure 4

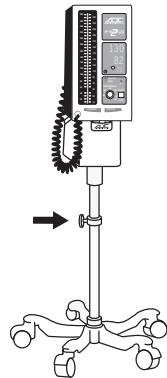
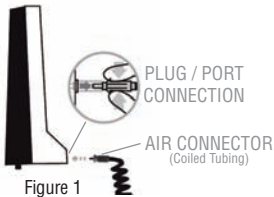
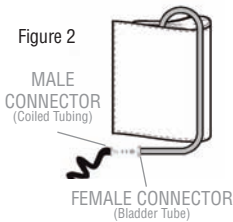

Figure 5

Cuff Connections



1. Squeeze the middle of the plastic air connector on the end of coiled tubing between thumb and forefinger, and insert into the air connection port on the face of the e-sphyg 2™. Make sure connector firmly “lock” snaps into the port (Figure 1).



2. Firmly insert male connector of coiled tubing into female connector at end of the Adcuff® bladder tubing. Be sure the connectors are tight (Figure 2).

Taking Blood Pressure (Auto Mode)

Turn on the device by pressing "I" side of MAIN POWER SWITCH.

Move MODE SELECTOR downward and set the device to "AUTO".
See page 15 for "MANUAL" measurement.

Set the initial inflation value with PRESET PRESSURE KNOB.

Select the pressure approximately 30 to 40 mmHg above expected systolic pressure.
Pressure can be set between 100 mmHg and 280 mmHg.
Set the pressure at 180 mmHg if patient's systolic pressure is difficult to predict.
The cuff is re-pressurized to a higher value if the preset pressure is too low for blood pressure to be taken during cuff deflation.



MANUAL



AUTO



Apply the cuff to patient's arm.
Choose the right size of cuff for your patient. **NOTE: Only these 3 cuffs may be used in auto mode.**

ARM CIRCUMFERENCE	CUFF SIZE
9.0 to 15.7 inches (23.0 to 40.0 cm)	ADULT
13.3 to 19.6 inches (34.0 to 50.0 cm)	LARGE ADULT
7.4 to 10.6 inches (19.0 to 27.0 cm)	SMALL ADULT

The lower edge of the cuff should be about 1" (2 to 3 cm) above the inner elbow and **BLADDER TUBE** should be over the inner part of the arm, positioning the **ARTERY MARK** of the cuff over the brachial artery.



Press the surface of the cuff to make sure that the hook and loop adhesive fastens securely.

The cuff should be wrapped loosely enough so that two fingers can be placed between the cuff and patient's arm. If the cuff is wrapped tighter or looser than this, inaccurate blood pressure readings may result.

If your patient is wearing a shirt that might restrict circulation in his/her upper arm or he/she rolls his/her sleeve up over the upper arm, the blood flow will be restricted, preventing accurate measurement.

Press START/STOP button.

The cuff is inflated automatically after zero settings.

Pressurization stops when pressure reaches the preset pressure value and pressure starts to descend.

Heart mark flashes in the segment LCD synchronizing detected pulse.

Deflation rate is displayed at the lower right corner of the segment LCD.



deflation rate

mmHg/s

Press START/STOP button whenever the measurement should be interrupted.

The device will stop during any course of measurement procedure and rapidly exhaust air from the cuff.

Air is rapidly exhausted from the cuff as measurement completes.

Blood pressure and pulse rate are displayed.

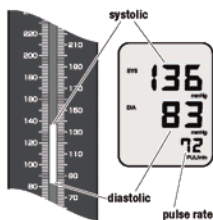

Turn off the device by pressing "O" side of MAIN POWER SWITCH.

The device will go to the energy saver mode after approximately 3 minutes if it is not turned off. See page 10.



Make sure your patient is relaxed, has taken at least 5 minutes of rest before measurement and refrains from talking or moving during measurement.

Confirm that the cuff is kept at the height of patient's heart during measurement.

Do not execute repeated measurements for congestion of blood could result in false measurement. Allow the patient's arm to rest for at least 5 minutes.

Taking Blood Pressure (Manual Mode)

When you want to take your patient's blood pressure using the auscultatory method with a stethoscope, set the device to "MANUAL" mode.

Turn on the device by pressing "I" side of MAIN POWER SWITCH.

Move MODE SELECTOR upward and set the device to "MANUAL".
See page 13 for "AUTO" measurement.

Set the initial inflation value with PRESET PRESSURE KNOB.
Details on preset pressure ... page 13.

Press SET/MEMORY button to confirm and/or select the appropriate deflation rate.

The deflation rate is displayed at the lower right corner of the segment display.

The deflation rate can be selected from 2.5, 4.5 and 6.5 mmHg's.
The set deflation rate returns to the default value (2.5) when the device is turned off.



MANUAL



PRESET PRESSURE



deflation rate

mmHg/s

Apply the cuff and stethoscope to the patient's arm in the same manner as the usual auscultatory method.

Press START/STOP button.

The cuff is inflated automatically after zero settings.

Pressurization stops when pressure reaches the preset pressure value and pressure starts to descend.

Deflation rate is displayed at the lower right corner of the segment LCD.

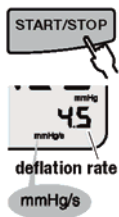

NOTE: Press START/STOP button whenever the measurement should be interrupted. The device will rapidly exhaust air from the cuff.

If cuff inflation was not sufficient, press and hold down START/STOP button once deflation has started and the cuff is pressurized again. Pressurization will continue while the button is pressed. Pressure does not exceed 290 mmHg.

Press START/STOP button when blood pressure is taken and air is rapidly exhausted from the cuff.

Air is also rapidly exhausted from the cuff when pressure descends to 30 mmHg.



Turn off the device by pressing "O" side of MAIN POWER SWITCH.



The device will be in the energy saver mode approximately after 3 minutes if it is not turned off. See page 10.



Make sure your patient is relaxed, has taken at least 5 minutes of rest before measurement, and refrains from talking or moving during measurement.

Confirm that the cuff is kept at the height of patient's heart during measurement.

Do not execute repeated measurements for congestion of blood could result in false measurement. Allow the patient's arm to rest for at least 5 minutes.

Memory Function

Measured result obtained in "AUTO" mode is automatically saved in the memory and can be recalled until next measurement is taken. The result is not saved when the measurement is performed in "MANUAL" mode.

To recall the result, turn on the device by pressing "I" side of MAIN POWER SWITCH and set the device to "AUTO" with MODE SELECTOR.

Press SET/MEMORY button and the last result from "AUTO" measurement is displayed.



MANUAL



AUTO



SET/MEMORY

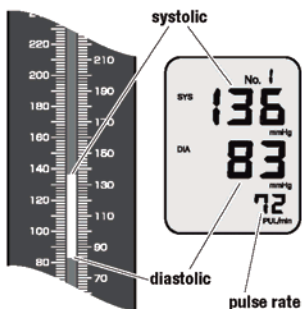







Turn off the device by pressing "O" side of MAIN POWER SWITCH.





The device will be in the energy saver mode approximately after 3 minutes if it is not turned off. See page 10.



Error Displays and Troubleshooting

ERROR/SYMBOL/SYMPTOM	CAUSE	REMEDY
	<p>OVER-PRESSURIZATION: The cuff was inflated to the maximum pressure because of movement of body, etc.</p>	<p>Make sure that the patient stays still during measurement.</p>
	<p>MEASUREMENT ERROR: Measurement could not be made because of moving or talking during measurement.</p>	<p>Make sure the patient remains still and quiet during measurement.</p>
	<p>INFLATION ERROR: AIR PLUG is not correctly inserted.</p> <p>Noise was detected.</p>	<p>Reinsert AIR PLUG and make sure that it is securely inserted.</p> <p>Make sure that the patient stays still and quiet during measurement.</p>
	<p>DEFLATION ERROR: Movement or talking was detected during measurement.</p> <p>Extreme changes in pressure occurred during measurement.</p>	<p>Make sure the patient remains still and quiet during measurement.</p> <p>Do not let patient move during measurement.</p>
	<p>CHECKING MODE: See page 21.</p>	<p>Turn off the device once and then turn it on again to take measurement.</p>
 <p>Nothing is being displayed when MAIN POWER SWITCH is pressed down in the ON position.</p>	<p>NO POWER: AC ADAPTER is not correctly connected.</p> <p>Battery is exhausted.</p> <p>9002 was left turned on but has not been operated for over an hour.</p>	<p>Reinsert AC ADAPTER and make sure that it is securely inserted.</p> <p>Charge the battery or use AC ADAPTER.</p> <p>Turn off the device or press START/STOP button or SET/MEMORY button to activate the device from energy saver mode.</p>

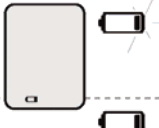
Error Displays and Troubleshooting

ERROR SYMBOL/SYMP TOM	CAUSE	REMEDY
	<p>LOW BATTERY: Battery is weak.</p> <p>BATTERY ERROR: Battery is exhausted.</p> <p>The indication appearing during LCD segment test, which is performed when the unit is turned on, does not indicate low battery or battery error.</p>	<p>Change the battery. Only a few measurements can be made before the battery runs down.</p> <p>Charge the battery. Measurement cannot be conducted.</p> 
	<p>ENERGY SAVER MODE: The device was left turned on and has not been operated for over approximately 3 minutes.</p>	<p>Turn off the device or press START/STOP button or SET/MEMORY button to activate the device from energy saving mode. Make sure to turn off the device by pressing "O" side of MAIN POWER SWITCH after use.</p>
<p>Measurement is interrupted once and the cuff is inflated again.</p>	<p>When the preset pressure value was not high enough to make measurement or when noise was detected, the cuff is pressurized again to a higher level.</p> <p>Patient moved during measurement.</p>	<p>This does not indicate a problem.</p> <p>Make sure that the patient stays still and quiet during measurement.</p>
<p>Blood pressure is different each time. The reading is extremely low (or high).</p>	<p>Patient is not being measured with correct posture. Blood pressure readings constantly vary with time of measurement and physical and mental condition.</p>	<p>Make sure that the patient is being measured with correct posture.</p>
<p>Pulse rate is too low (or too high).</p>	<p>Patient moved during measurement. There was not enough rest taken before measurement.</p>	<p>Make sure that the patient stays still during measurement. Allow your patient to rest for at least 5 minutes.</p>

Error Displays and Troubleshooting

ERROR SYMBOL/SYMPTOM	CAUSE	REMEDY
Measurement result cannot be recalled or is not stored.	Blood pressure was taken in "MANUAL" mode.	Measurement result is saved only when it is taken in "AUTO" mode.
Cuff inflation does not start.	Battery is exhausted.	Measurement cannot be made when BATTERY MARK is displayed. Recharge the battery.
AC INDICATOR is lit even when 9002 is turned off.	The battery is inserted.	AC INDICATOR also indicates whether the battery is being charged or it is not being charged.
The column LCD is dim or brightness is not steady.	9002 is operated with the battery.	Difference in voltages between AC ADAPTER and the battery lead to differences in LCD brightness. This does not indicate a functional problem.

If you cannot get correct measurement with the methods above, do not tamper with the internal mechanism. Contact your dealer. If the unit malfunctions, return it to the dealer or an authorized service representative for servicing according to the warranty. The manufacturer provides service data to qualified dealers.

Care and Maintenance

Because the device includes precision parts, care should be taken to avoid extreme temperature variations, humidity, shock, dust, and direct sunlight. Do not drop or strike the device. Make sure not to expose the unit to moisture. This unit is not water resistant.

Use only a soft, dry cloth to clean the device. Do not use gasoline, paint thinner, chemicals such as strong bases, strong acids, oxidizing agents, and reducing agents, or other strong solvents on the unit. Since the cuffs may absorb perspiration and other fluids, inspect them for stains and discoloration after each use. Sponge with a damp cloth. If necessary the cuff can be washed in cool water with mild soap or detergent-disinfectant. Remember to remove the bladder prior to washing. After washing, the cuff should be rinsed and allowed to air dry. **NEVER** iron.

When storing the device, do not place heavy objects on it and do not coil BLADDER TUBE too tightly. When the unit has been stored at a temperature below the freezing point, keep it for at least 1 hour in a warm place before using. Remove the battery if the device is to be stored for an extended period of time. Keep the batteries out of the reach of children.

Caution: Do not inflate the cuff when it is not wrapped around an arm.

Caution: Do not disassemble or modify the device.

We suggest that the device be checked every 2 years. This operation may only be performed by the manufacturer or by firms authorized by the manufacturer.

Checking pressure accuracy

Connect a cuff wrapped around a firm cylinder to the 9002 *e-sphyg*TM 2 and a standard manometer. Turn on the 9002 *e-sphyg*TM 2 while pressing and holding the START/STOP button down. Release the button after the initial display (all segment display) disappears. Two "0"s are displayed and the 9002 *e-sphyg*TM 2 is in CHECKING MODE. Inflate the cuff with an inflation bulb and compare the readings. Pressure accuracy is to be ± 3 mmHg. Contact dealer if accuracy of your 9002 *e-sphyg*TM 2 is invalid.

(A test kit may be purchased from an authorized dealer)

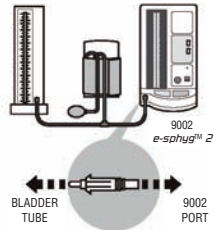

9002W - Wall Unit Parts & Tools

ADC Item	Item no.
1. <i>e-sphyg</i> TM 2	9002
2. 6mm Allen Wrench	752M-116
3. Wall Bracket	952-103
4. Wall Basket with (3) screws / (3) mollys	952-025
5. Coiled tubing	885N
6. Mounting Bolt/Washer (1)	972-101
7. Connector	9002-2
8. Connector, Male	891M
9. Connector, Female	891F
10. Adcuff TM & Bladder, Adult	845-11ABK-IF
11. (2) Screws (for wall bracket)	952-104
12. (2) Mollys (for wall bracket)	952-105

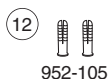
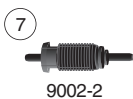
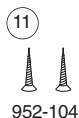
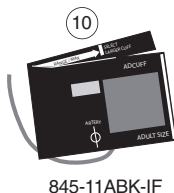
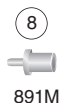
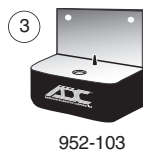
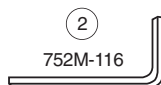
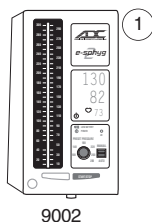

9002M - Mobile Unit Parts & Tools

ADC Item	Item no.
1. <i>e-sphyg™ 2</i>	9002
2. 6mm Allen Wrench	752M-116
3. 3mm Allen Wrench	752M-117
4. Mounting Bolt/Washer (2)	972-101
5. Mobile Stand	752M-02
6. Coiled tubing	885N
7. Connector	9002-2
8. Connector, Male	891M
9. Connector, Female	891F
10. Adcuff™ & Bladder, Adult	845-11ABK-IF

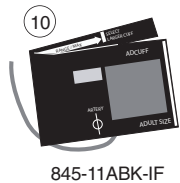
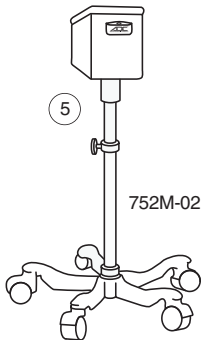
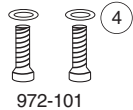
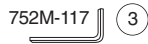
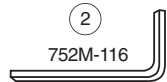
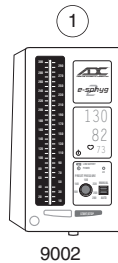

Mobile Base Assembly Parts

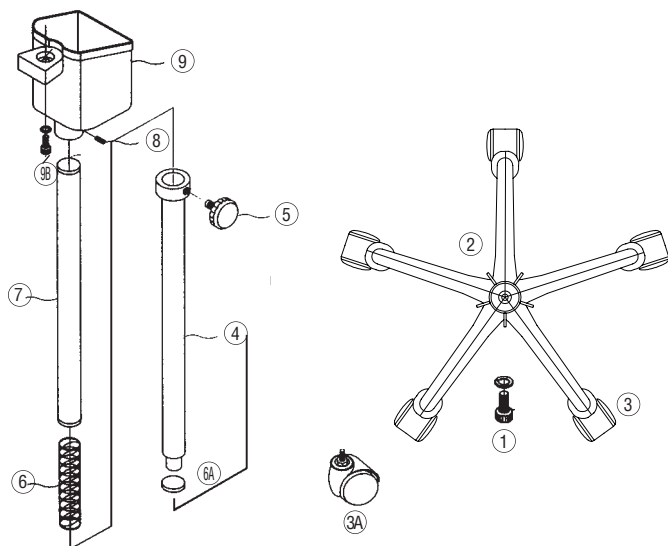

	ADC Item	Item no.
1	Center Pole Screw (1) Washer (1)	972-101
2	Base	972-080
3	Casters (5)	972-106
3A	Single Caster	972-106-1
4	Outer Pole	972-107
5	Knob	972-108

	ADC Item	Item no.
6	Spring	972-109
6A	Gasket, Rubber	972-107A
7	Inner Pole	972-110
8	Basket Tightening Key	972-111
9	Basket	972-112
9B	Manometer Mounting Hardware	752-114

Specifications

Operating Principle:	Oscillometric method*
Indicator:	300 digits column LCD and 10 digits segment LCD
Pressure Indicating Range:	0 to 300 mmHg (cuff pressure)
Measuring Range:	50 to 250 mmHg (systolic) 40 to 180 mmHg (diastolic) 40 to 160 bpm (pulse rate)
Accuracy:	±3 mmHg (cuff pressure) ±5% of reading (pulse rate)
Inflation :	Automatic inflation
Deflation:	Electric control valve
Exhaust:	Automatic exhaust valve
Power Supply:	7.0 VDC AC adapter (MODEL 9605+02225-1UOC) or 4.8 VDC rechargeable NiMH battery
Power Consumption :	14W (max.)
Memory:	single measurement result*
Operating Environment:	+50°F to+104°F, 15 to 90% relative humidity
Storage Environment:	-4°F to+122°F, 15 to 95% relative humidity









Coverage Arm Circumference

Adult Size Cuff:	9.0 to 15.7 inches (23.0 to 40.0 cm)
Large Adult Size Cuff:	13.3 to 19.6 inches (34.0 to 50.0 cm)
Small Adult Size Cuff:	7.4 to 10.6 inches (19.0 to 27.0 cm)

Main Unit

Weight:	Approx. 2.2 lb. [1000 g], without AC adapter or battery
Size:	5.4 x 10.6 x 3.8 in [136 x 266 x 96 mm] (W x D x H)

Specifications are subject to change without notice due to improvements in performance.
* marks only apply to "AUTO" measurement.

Symbol	Definition	Symbol	Definition
	Important Warning/Caution		Authorized European Representative's Information
	Latex-Free		Manufacturer's Information
	Circumference Size		Temperature Limit
	Conforms to EU Standards		Humidity Limitation

Limited Warranty

American Diagnostic Corporation (ADC®) warrants its products against defects in materials and workmanship under normal use and service as follows:

1. Warranty service extends to the original retail purchaser only and commences with the date of delivery.
2. The entire sphygmomanometer is warranted for two years.
3. Cuff, bladder and coiled tubing are warranted for three years.
4. The manometer is warranted to remain accurate to $\pm 3\text{mmHg}$ over its full range when compared to a reference standard for life.

What is Covered: Repair, or replacement of parts, and labor.

What is not covered: Transportation charges to and from ADC®. Damages caused by abuse, misuse, accident, or negligence. Incidental, special, or consequential damages. Some states do not allow the exclusion or limitation of incidental, special, or consequential damages, so this limitation may not apply to you.

To Obtain Warranty Service: Send item(s) postage paid to ADC®, Attn: Service Dept., 55 Commerce Dr., Hauppauge, NY 11788. Please include your name and address, daytime phone no., proof of purchase, a brief note explaining the problem, and \$2.00 to cover the cost of return shipping and handling.

Implied Warranty: Any implied warranty shall be limited in duration to the terms of this warranty and in no case beyond the original selling price (except where prohibited by law). This warranty gives you specific legal rights and you may have other rights which vary from state to state.

**To Register Your Product, visit us at
www.adctoday.com/register**

Replacement Parts

Component	Part No. Latex-free	Model Use
Coiled Tubing 4'	886N	Desk
Coiled Tubing 8'	885N	All Models
Cuff & Bladder - Sm. Adult	845-10SABK-IF	All Models
Cuff & Bladder - Adult	845-11ABK-IF	All Models
Cuff & Bladder - Lg. Adult	845-12XBK-IF	All Models
Female Luer Connecetor	891F	All Models
Male Luer Connecetor	891M	All Models
Plastic Connector	9002-2	All Models
AC Adapter	9002-3	All Models
Rechargeable Battery Pack	9002-5	All Models

**FOR QUESTIONS, COMMENTS,
OR SUGGESTIONS
CALL TOLL FREE: 1-800-ADC-2670
OR VISIT
WWW.ADCTODAY.COM/FEEDBACK**

Many ADC instruction manuals are available on our website in other languages at
www.adctoday.com/care

©2013 ADC®. All rights reserved. No one is permitted to reproduce or duplicate in any form, this manual or any part thereof without the expressed written permission of ADC®. ADC® assumes no responsibility for any injury to anyone, or for any illegal or improper use of the product that may result from failure to use the product in accordance with the instructions, cautions, warnings, or statement of intended use published in this manual. The 9002 e-sphyg 2™ and Adcuff™ are trademarks of ADC®.



ADC
55 Commerce Drive
Hauppauge, NY 11788
U.S.A.



ADC (UK) Ltd.
Unit 6, PO14 1TH
United Kingdom

Inspected in the U.S.A.
Made in China
tel: 631-273-9600, 1-800-232-2670
fax: 631-273-9659

www.adctoday.com
email: info@adctoday.com