

Haier

**HD Ready Digital LCD TV and
HD Ready Digital LCD TV/DVD Combi**

USER'S MANUAL

Please read this manual carefully before using your television and keep this manual for future reference.

CONTENT

Safety Notice	1
Front Panel Control.....	2
Connection	3
Remote Control(for TV/DVD Combi).....	4
Remote Control (for TV/DTV only).....	5
Installing Batteries.....	6
Connection Instructions.....	7
Grounding.....	7
External equipment connections.....	7
Antenna Connection.....	7
VGA Input.....	8
YPbPr Input.....	8
S-VIDEO Input.....	9
SCART Input.....	10
CI Card Input.....	10
HDMI Input.....	10
Basic Operating Instructions.....	11
Turn on the LCD-TV.....	11
Inputs selection.....	11
V+/V-.....	11
Mute.....	11
Sound Mode.....	12
Select the TV Channel	12
Picture Mode.....	12
Program Swap.....	12
Sleep/Scan/Zoom.....	12
Menu Operations.....	13
Picture Menu Options.....	14
Sound Menu Options.....	15
Function Menu Options.....	16
Lock Menu Options.....	17
Lock Menu Options Continued.....	18
Tuning Menu Options.....	20
Tuning Menu Options Continued.....	21
Time Menu Options.....	23
Time Menu Options Continued.....	24
TELE TEXT.....	25
Basic Playback.....	27
Advanced Playback.....	28
Special Function Playback.....	29
JPEG DISC PLAYBACK.....	29
SCREEN SAVER FUNCTION.....	29
DVD System Setup.....	30
General Setup Process.....	30
General Setup Page.....	31
Preferencel Page.....	32
Playable Discs.....	34
Disc Protection and DVD Characteristics.....	35
Troubleshooting Guide.....	36
Specifications.....	37

Note: DVD is only available for certain models, please refer to actual products

Safety Notice

To prevent fire or electric shocks please read the instruction before installing, using and cleaning the television.

Please read all the instructions before operation;
Please keep the manual for future reference ;
Do not use any accessories that are not recommended by the manufacturer:
Before operation, make sure the operating voltage of this unit corresponds with your house electrical supply;
Do not place the unit on unstable or in dusty and humid places;
Never put the unit in direct sunlight or near heat sources;
Allow enough space for proper ventilation;
Please keep water away from the LCD-TV . If water comes in to contact with the LCD-TV, disconnect the power cord from the power source, then wipe the set with a dry soft cloth;
Do not remove the back cover. If servicing is required , please refer to customer helpline.

Connection

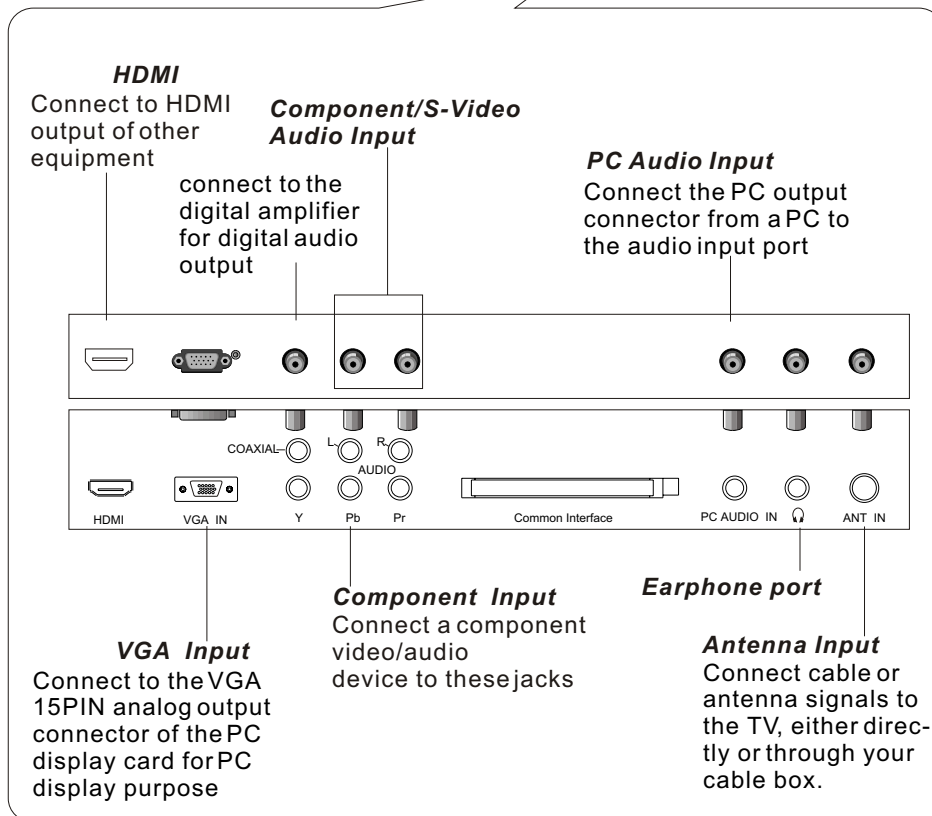
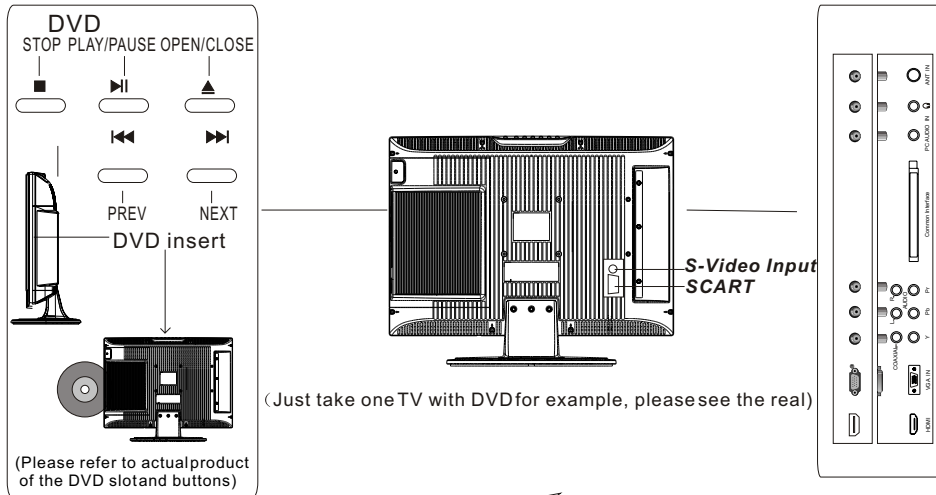

Remote Control (for TV/DVD Combi)

When using the remote control, aim it towards the remote sensor on the TV

Buttons on the remote control

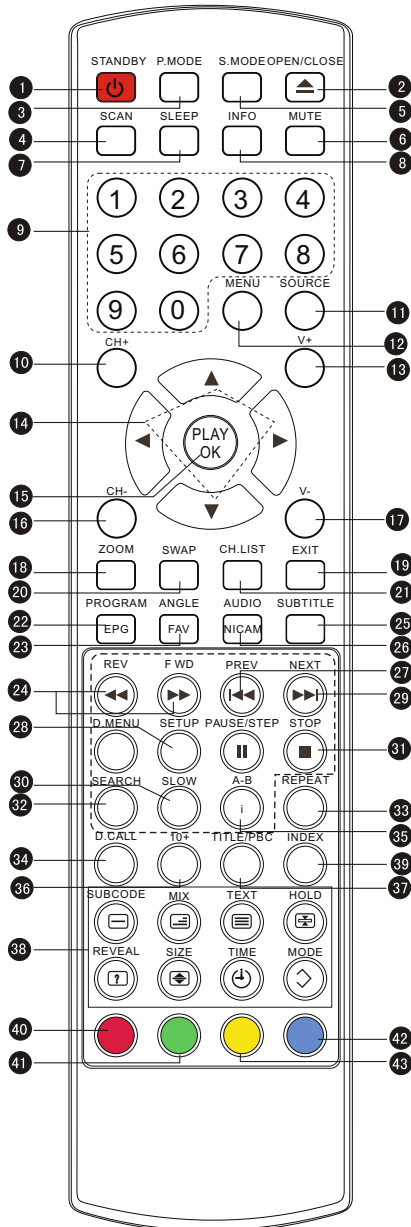

(For TV with DVD Models)

- 1 Stand By
- 2 DVD Open/close
- 3 Picture Mode
- 4 Scan
- 5 Sound Mode
- 6 Mute
- 7 Sleep button
- 8 Call Screen Display
- 9 Program Number
- 10 Channel selection
- 11 Source Exchange
- 12 Call menu
- 13 Volume selection
- 14 Cursor Move button
- 15 DVD play/Confirm button in menu
- 16 Channel selection
- 17 Volume selection
- 18 Zoom
- 19 Exit Screen Display
- 20 Swap
- 21 Channel list button
- 22 DVD PROGRAM/ DVB-T EPG button
- 23 DVD ANGLE/ DVB-T favourite
- 24 DVD FAST REVERSE/FORWARD
- 25 DVD /DVB-T SUBTITLE
- 26 DVD/DTV Audio /NICAM
- 27 DVD PREVIOUS
- 28 DVD SETUP
- 29 DVD NEXT
- 30 DVD SLOW
- 31 DVD STOP
- 32 DVD SEARCH
- 33 DVD REPEAT
- 34 DVD CALL
- 35 DVD A-B REPEAT
- 36 DVD 10+
- 37 DVD TITLE/PBC
- 38 Teletext buttons
- 39 Teletext index
- 40 RED button
- 41 Green button
- 42 Blue button
- 43 Yellow button

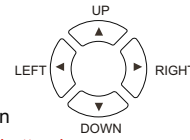

Remote Control (for TV/DTV only)

When using the remote control, aim it towards the remote sensor on the TV

Buttons on the remote control

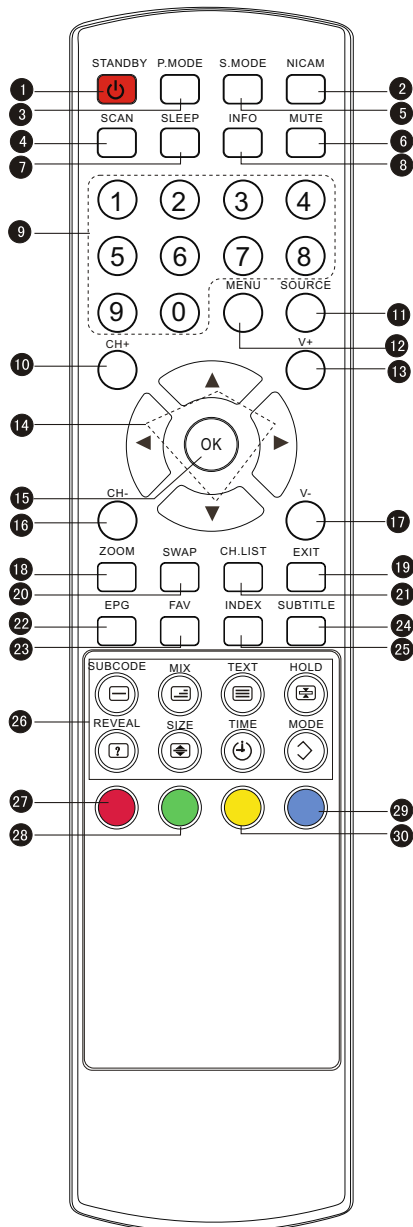

- 1 Stand By
- 2 NICAM
- 3 Picture Mode
- 4 Scan
- 5 Sound Mode
- 6 Mute
- 7 Sleep button
- 8 Call Screen Display
- 9 Program Number
- 10 Channel selection
- 11 Source Exchange
- 12 Call menu
- 13 Volume selection
- 14 Cursor Move button
- 15 Confirm button in menu
- 16 Channel selection
- 17 Volume selection
- 18 Zoom
- 19 Exit Screen Display
- 20 Swap
- 21 Channel list button
- 22 DVB-T EPG button
- 23 DVB-T favourite
- 24 DVB-T SUBTITLE
- 25 Teletext index
- 26 Teletext buttons
- 27 RED button
- 28 Green button
- 29 Blue button
- 30 Yellow button

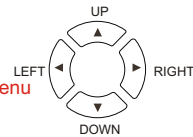

Note: the instruction on this manual is taking TV/DVD combi remote control as an example.

(For TV without DVD Models)

Installing Batteries

Installing Batteries

1. Open the cover of the battery compartment at the back of the remote control.
2. Insert two AA alkaline batteries in the compartment. (plus and minus poles to respective mark)
3. Replace the cover of the battery compartment.

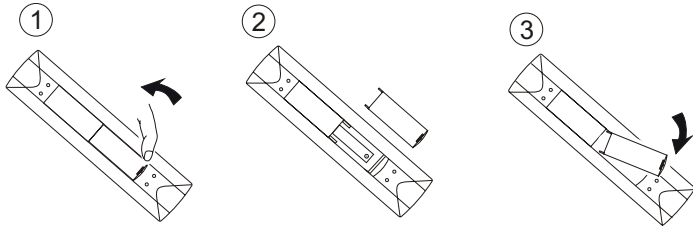

Precautions

Make sure that there is no obstacle between the remote controller and television set.

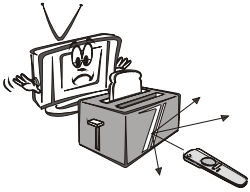

Keep the remote controller away from heat source or humid area to ensure effective performance of the remote controller.



As strong light may interfere the signals, change your position to operate the remote controller if the television cannot be turned on or off as you expect.



Make sure that two AA 1.5V alkaline batteries are loaded. The batteries must be of the same type. The batteries must be located properly. The batteries are not rechargeable. If your TV is to be stored for a period of time, remove the batteries from the remote control.

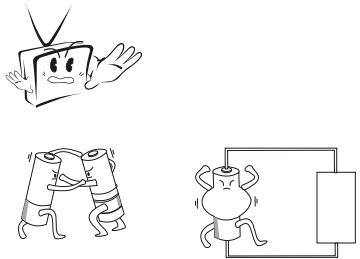

Connection Instructions

Grounding

Ensure that you connect the grounding / earth wire to prevent possible electric shock. If grounding methods are not possible, have a qualified electrician install a separate circuit breaker. Do not try to ground the unit by connecting it to telephone wires, lightening rods, or gas pipes.

External Equipment Connections

Antenna Connection

- Antenna or Cable Service with a Cable Box Connections
- For optimum picture quality, adjust antenna direction if needed.

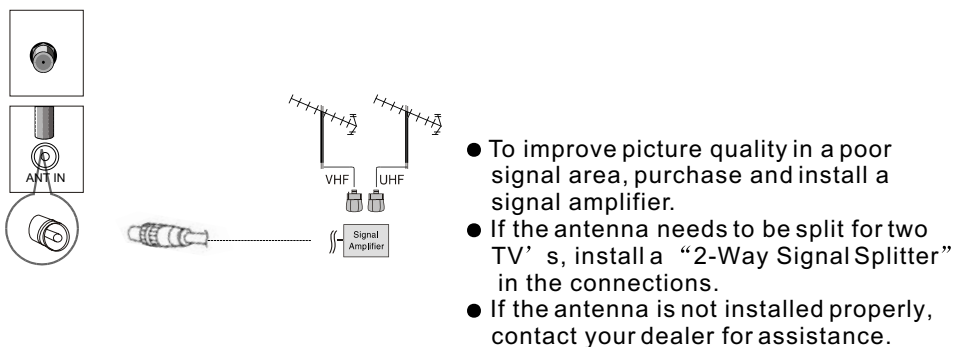
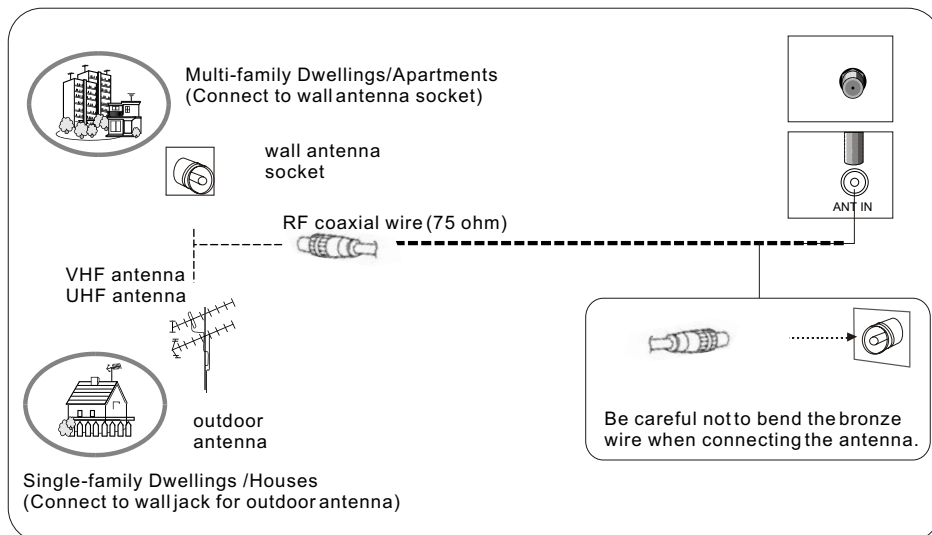

NOTE: All cables shown are just for example.

Connection Instructions

VGA Input

You can use your LCD-TV as a monitor for your personal computer using a VGA cable (not supplied).

Connection and use steps:

1. Read the user guide supplied with your computer and ensure that it has a VGA connector;
2. Make sure that the power of the LCD-TV and the PC are off;
3. Connect a D type 15-pin VGA interface cable (not supplied) to the VGA video interface connector on the PC. Then connect the other end to the PC video interface connector on the back of the LCD-TV. Tighten the screws on the VGA connectors once they are firmly connected, connect the audio cable (not supplied) to the audio input on the back of your LCD-TV;
4. Turn on the power of the LCD-TV first, and then turn on the power of the PC;
5. Set the video input mode of the LCD-TV to PC;
6. Check the image on your TV. There may be noise associated with the resolution, vertical pattern, contrast or brightness in PC mode. If noise is present, change the PC mode to another resolution, change the refresh rate to another rate or adjust the brightness and contrast on the menu until the picture is clear. If the refresh rate of the PC graphic card cannot be changed, change the PC graphic card or consult the manufacturer of the PC graphic card.

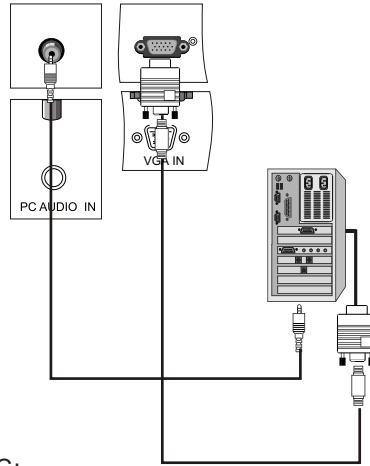

Mode	Resolution	Line frequency (Khz)	Frame frequency (Hz)
VGA	640*480	31.5KHz	60Hz
SVGA	800*600	37.9KHz	60Hz
XGA	1024*768	48.4KHz	60Hz

Note: All above listed are subject to VESA Criteria.

YPbPr Input

How to connect

Connect the DVD video outputs (Y, PB, PR) to the Component (Y, Pb, Pr) in socket on the TV and connect the DVD audio outputs to the AUDIO jacks on the TV, as shown in the figure.

NOTE: If your DVD player does not have component video output, use S-Video.

How to use

1. Turn on the DVD player, insert a DVD.
2. Set the mode of the LCD-TV to Component.

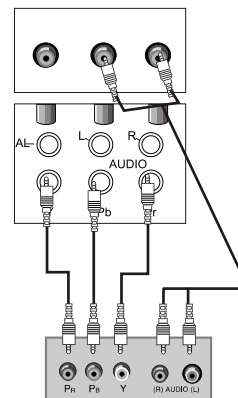

Connection Instructions

(If connected to S-Video, select the S-Video external input source.)
 3. Refer the DVD player's manual for operating instructions.

Component Input ports

To get better picture quality, connect a DVD player to the component input ports as shown below.

Component ports on the TV	Y	P _B	P _R
---------------------------	---	----------------	----------------

Video output ports on DVD player	Y	P _b	P _r
	Y	B-Y	R-Y
	Y	C _b	C _r
	Y	P _B	P _R

S-VIDEO Input

- To avoid picture noise (interference), leave an adequate distance between the VCR and TV

Connection and use steps:

1. Read the user guide supplied with your AV devices and ensure that it has S-Video connectors;
2. Make sure that the power of the LCD-TV and the AV device are switched off;

Connection Option 1

Set VCR output switch to 3 or 4 and then tune TV to the same channel number.

Connection Option 2

1. Connect the audio and S-Video cables from the VCR's output jacks to the TV input jacks, as shown in the figure.
2. Insert a video tape into the VCR and press PLAY on the VCR. (Refer to the VCR owner's manual.)
3. Turn on the power of the LCD-TV first; and then turn on the power of the AV device;
4. Set the video input mode of the LCD-TV to S-Video mode.

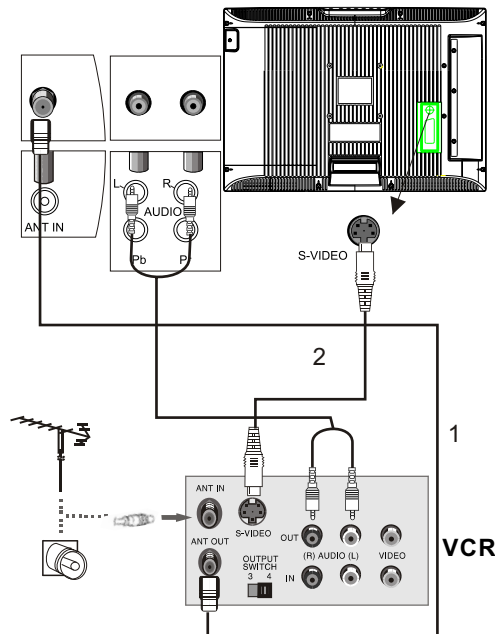

Connection Instructions

SCART Input

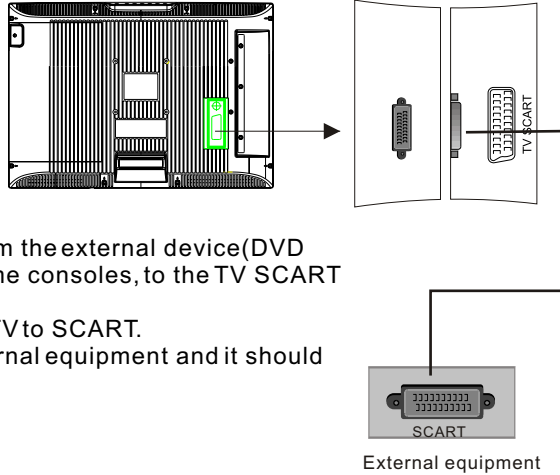

1. Connect the scart lead from the external device(DVD players, settop boxes or game consoles, to the TV SCART socket.
2. Set the mode of the LCD-TV to SCART.
3. Press Play button on external equipment and it should appear on the screen.

CI Card Input

The common interface (CI) slot is designed to accept the Conditional Access (CA) Module and Smart card in order to view the pay TV programmes and additional services. Contact your Common Interface service provider to get more information about the modules and subscription. Please note that CA modules and smart cards are neither supplied nor optional accessories from us. **Warning:** switch off your TV before any module is inserted in the Common Interface slot. Insert the CAM correctly, then Smart Card to the CI slot that is located at the side of the TV.

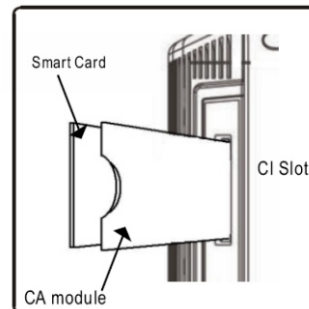

HDMI Input

HDMI Devices

Connect the cable from the HDMI devices to the TV HDMI, as shown in the figure.

How to use

1. Set the mode of the LCD-TV to HDMI.
2. Operate the corresponding external equipment. Refer to external equipment operating guide.

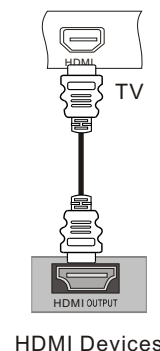

Basic Operating Instructions

Turn on the LCD-TV

When the **POWER(STANDBY)** button on the remote control is pressed and the LCD-TV is turned on, the indicator light on the front of the LCD-TV changes from red to green. When the LCD-TV is turned off using the **POWER(STANDBY)** button, the LCD-TV will go into standby mode and the indicator light turns red.

You can also turn on the TV from standby mode by pressing the digits(1-9) or **CH+/CH-**.

The display will appear on the screen when the TV is turned on for the first time:

Press **◀/▶** to select the language you want, then press **▲/▼** to select the Auto Search and **OK** to enter the submenu: press **◀/▶** to select the country you are in, then press **▲/▼** to move to the following item and **◀/▶** to select Start, then press **OK** to confirm. All channels will be stored after the searching.

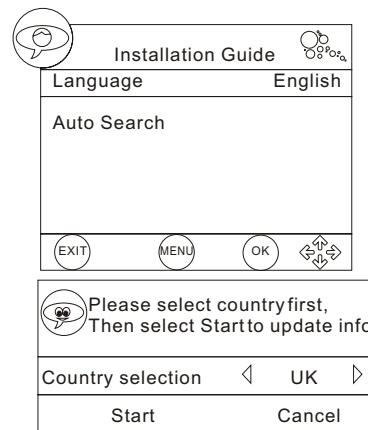

Inputs selection

Press **SOURCE** button to display the Source menu. Press **▲/▼** button to select the inputs you need and the TV will turn to the source automatically in 3 seconds or press **OK** to confirm.

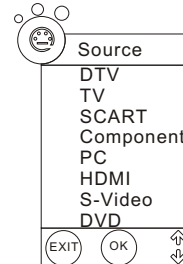

V+/V-

Press the **V+/V-** button to increase/decrease the volume and there will be display on the bottom of the screen.

Mute

1. Press the **MUTE** button to mute the sound temporarily. A mute icon appears on the screen.
2. Press the **MUTE** button again or **V+** to restore the sound. The mute icon disappears.

Basic Operating Instructions

Sound Mode

Press **S.MODE** button on the remote control for menu display . For desired mode as follows:

Standard→Music→Theatre→Voice→Personal

Select the TV Channel

You can use the number keys on the remote control to directly select TV channels.

The LCD-TV can store up to 100 channels , and you can press the **CH+/CH-** keys on the remote control or on the TV set to make a selection.

Picture Mode

Press **P.MODE** button on the remote control for menu display . For desired mode as follows:

Standard→ Mild→ Personal→Fresh

Program Swap

1 Suppose the TV set is in channel 8 just now and in channel 18 now .

2 If you want to return to the last watched program in channel 8, you can simply press the **SWAP** button.

3 If you want to return to channel 18, press the button again. Through this function, you can easily change between the channel you are watching and the channel you watched just now.

Sleep

Press **SLEEP** button to set the sleep timer among Off/10min/20min/30min/60min/90min/120min/180min/240min.

If 1 minute left, the 59Sec. TO POWER OFF will appear on the screen. The TV turns off automatically when the 1Sec. TO POWER OFF is on.

Scan

Press **SCAN** button to skim the channels . You can press SCAN again stop scanning.

Zoom

Press to zoom the picture .

Menu Operations

1. Press **MENU** button to display the main menu, and **◀/▶** to select the main menu .
2. Press **▲/▼** to scroll through the options
3. Press **◀/▶** buttons to make changes to the parameters
4. Press **MENU** to exit the menu step by step
5. Press the **EXIT** button to exit the menu

PICTURE MENU

PICTURE

Video Mode	Personal
Contrast	○○○○○○○○○○ 50
Brightness	○○○○○○○○○○ 50
Colour	○○○○○○○○○○ 50
Sharpness	○○○○○○○○○○ 50
Tint	○○○○○○○○○○ 0

▼

EXIT MENU OK ◀▶▲▼

SOUND MENU

SOUND

Audio Language	English
Audio Mode	Personal
Treble	○○○○○○○○○○ 50
Bass	○○○○○○○○○○ 50
Balance	○○○○○○○○○○ 0
AVL	Off

▼

EXIT MENU OK ◀▶▲▼

FUNCTION MENU

FUNCTION

Language	English
Subtitle Language	English
Display Mode	Auto
Blue Screen	Off
Reset	

▼

EXIT MENU OK ◀▶▲▼

LOCK MENU

LOCK

Change Password	Off
Menu Lock	Off
Program Set	Off
Program No .	1
Source Lock	Off
Child Lock	Off

▼

EXIT MENU OK ◀▶▲▼

TUNING MENU

TUNING

Auto Search	
DTV Manual Search	
ATV Manual Search	
Guide	
CI Information	

▼

EXIT MENU OK ◀▶▲▼

TIME MENU

TIME

Clock	-----
Off Time	Off
On Time	Off
Sleep	Off
Time Zone	Lisbon GMT

▼

EXIT MENU OK ◀▶▲▼

Menu Operations

NOTE: Using your remote control to navigate in the on-screen menus. The on-screen menus shown in this manual may be different from those on your TV. These are example to illustrate your TVs operation.

Picture Menu Options

Picture quality can be adjusted for any input separately .

The picture quality on the screen can be adjusted as follows:

1. Press **MENU** button and ◀/▶ until the picture menu appears on the screen.
2. Press ▲/▼ button to enter the picture menu and go up and down to select the desired option .
3. Press ◀/▶ button to increase and decrease the level to match your preference .
4. Repeat step 2 and step 3 until desired picture quality has been achieved .

Functions:

Video Mode: Press ◀/▶ to set the picture mode .

Contrast : Used to set the contrast balance of the picture.

Brightness : Used to set the brightness level of the picture.

Colour : Press ◀/▶ to adjust the colour saturation of the picture..

Sharpness : By increasing the level, it will show cleaner and clearer images and by decreasing the level, it will make picture smoother.

Tint(Only available in NTSC): Set the colour tone of the picture.

Colour Temperature : Press to select the colour temperature from Normal/Cool/Warm .

Noise Reduction: Adjust the quality of the picture by selecting Off,Low, Middle,High.

PC Adjust (can be adjust only in PC mode and there is PC signal): Press **OK** button to enter the submenu. Press ◀/▶ to adjust the value.

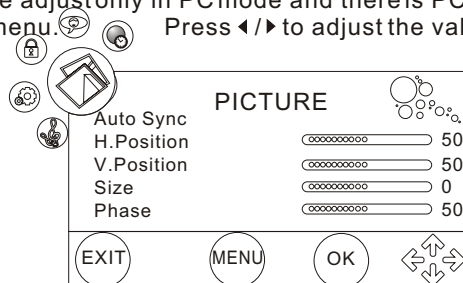

Menu Operations

Auto Sync: Adjust the picture location frequency and phase parameters automatically in PC.

H.Position: Picture horizontal adjust.

V.Position: Picture vertical position adjust.

Size: Adjust the size of the LCD to match the PC input source.

Phase: Removes any horizontal distortion and clears or sharpness the displayed characters.

Sound Menu Options

Sound can be adjusted as follows:

1. Press **MENU** and ◀/▶ button until the following menu appears on the screen

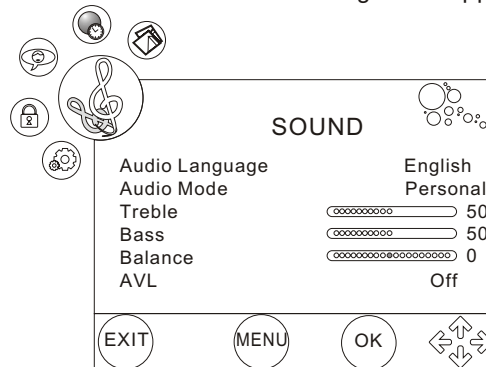

2. Press ▲/▼ button to enter the sound menu and up and down to ◀/▶ select the desired option .
3. Press ◀/▶ button to increase and decrease the level to match your preference .
4. Repeat step 2 and step 3 until desired sound quality has been achieved .

Functions :

Audio Language(only available in DTV mode) : Press OK to enter the submenu. Then press ▲/▼ to select the Primary and the Secondary item and press to select the language you need.

Audio Mode : Press ◀/▶ to select among Music/Theatre/Voice/Personal/Standard.

Treble : Increases or decreases the level of the treble sounds.

Bass : Increases or decreases the level of the bass sounds.

Menu Operations

Note: Bass and Treble can be adjusted in any audio mode, and if the numerical value is changed, the audio mode will be changed to personal automatically.

Balance : Adjust the audio output between left and right speakers.

AVL: Automatic Volume Limit Control . Reduces the differences in volume level between different broadcasters.

Function Menu Options

1. Press **MENU** button and ◀/▶ until the following menu appears on the screen.

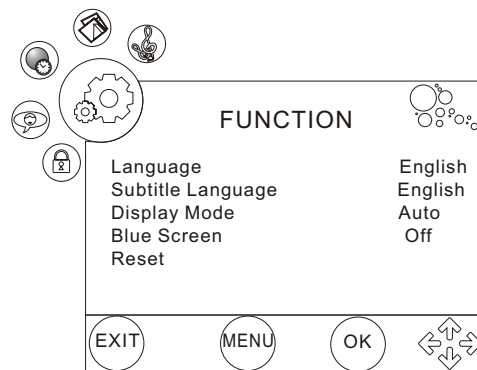

2. Press ▲/▼ button to enter the function menu and go up and down to select the desired option .
3. Press ◀/▶ button to increase and decrease the level to match your preference .
4. Repeat step 2 and step 3 until desired function quality has been achieved .

Functions:

1. Language: Used to set the language of the on-screen display.
2. Subtitle Language (in DTV mode only): To switch the subtitle languages .
3. **Display Mode: Used to set the aspect ratio of the display. Choices include Auto /Full Screen/Zoom1/Zoom2/4:3/16:9(Display mode may differ from different inputs.)**
4. Blue Screen: Used to turn the blue screen option On or Off. With the option on, your TV screen turns blue after 3 seconds without an input signal.
5. Reset : Press **OK** button to enter the dialogue Are you sure? And press ◀/▶ to select Yes, then press **OK** button to reset the TV setting to factory default.

Menu Operations

Lock Menu Options

1. Press **MENU** button and ◀/▶ until the following menu appears on the screen.

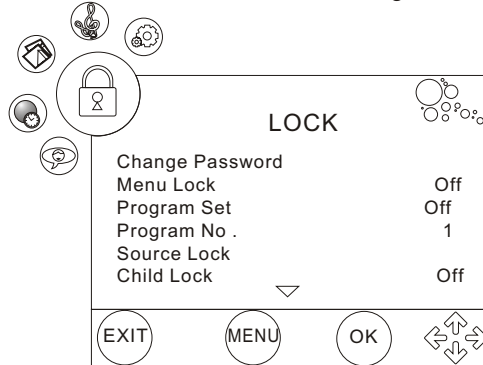

2. Press **OK** button to display the following menu .
Press the number buttons (0~9) to enter the password. (The initial password is 0000. If you forget your password, you can enter **9443** at any time to access the lock menu), the lock menu opens.

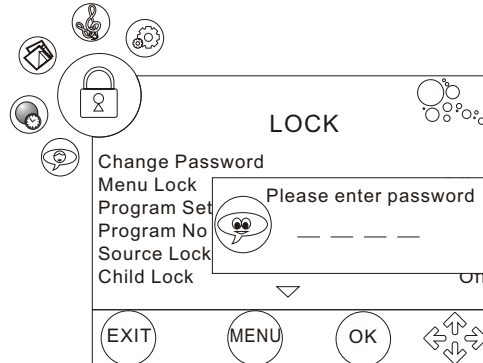

3. Press ▲/▼ button to go up and down to select the desired option .
4. Press ◀/▶ button to increase and decrease the level to match your preference .
5. Repeat step 3 and step 4 until desired quality has been achieved .

Functions:

1. Change Password: The password can be changed. Press **OK** to enter the menu as follows. Enter the password , if the same password is entered correctly twice, the old password will be changed.

Menu Operations

Lock Menu Options Continued

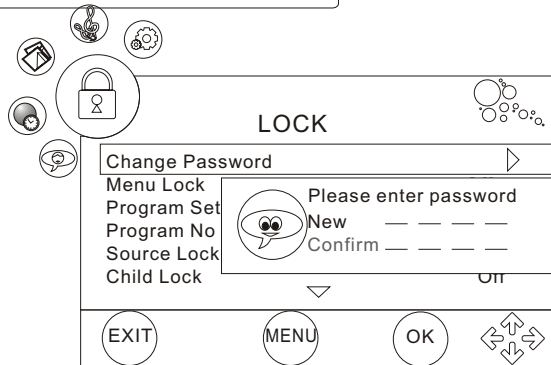

Menu Lock: Press ◀/▶ to select **Off/Tuning/Main Menu**. To set **Tuning**, the search function will be locked, to set **Main Menu**, you will need input the password if you want to operation any menu. And you can resume it by setting **Off** or operate **Clear Lock**.

Program Set: Used to set up start condition. Press ◀/▶ to select among the inputs signals. The setted mode will be entered if the TV is switched off and on again. To set **Off**, the TV will memory the off-mode.

Program No.(it can only be selected when the Program Set is DTV or TV): Press ◀/▶ to select the channel number you want to watch when the TV on again.

Source Lock: Opted to hinder external input modes, such as PC. Press **OK** to display menu as follows. Press ▲/▼ to select the option, and press ◀/▶ to set on or off. If you want to cancel some source mode, enter lock menu and set it off or active clear lock.

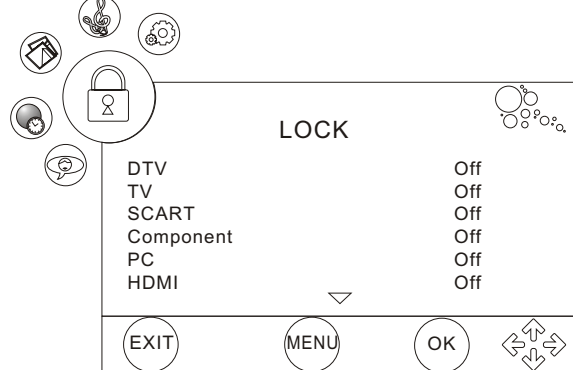

Child Lock: Press ◀/▶ button to set on or off mode. If lock on mode is set, child lock is inactivated automatically. In such case, buttons on the television is useless and only buttons on remote control can be used, if child lock button (button on the television) is pressed, the screen will display **Child Lock**. The child lock mode can be resumed by entering Lock set menu, set child lock off or active Clear Lock.

Menu Operations

Lock Menu Options Continued

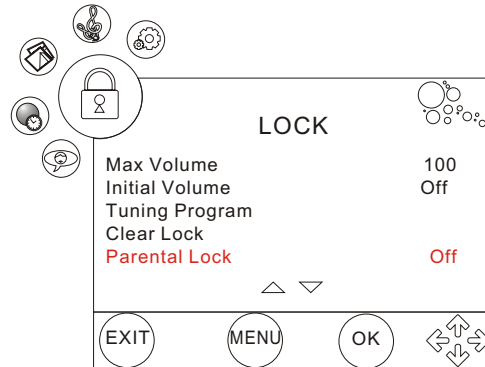

Max Volume: Press ◀/▶ to adjust. If a certain value is set, when volume is being adjusted, the sound value can not exceed that maximum volume value.

Initial Volume: Used to memory the volume you have set when you turn on our TV after turn off it.

Tuning Program: Press **OK** button to enter the submenu. Press ▲/▼ to select the program you want to edit. The colour of the circle is corresponding with the buttons on the bottom of the remote control.

NAME (only available in ATV): to rename the analog channel by pressing the **red** button press ▲/▼ to input the characters and press ◀/▶ to select the position.

LOCK: to lock the program by pressing the **green** button and press again to unlock.

FAV: to set the favourite program by pressing **yellow** button and press again to cancel.

SKIP: to skip the channel when press **CH+/CH-** button by pressing the **blue** button and press again to cancel.

Clear Lock: Press ◀/▶ to unlock all set modes, setting all lock options to off, and the maximum volume returns to 100.

Parental Lock: Press ◀/▶ to change the setting. To enable setting specific program blocks according to different ages.

Menu Operations

Tuning Menu Options

1. Press **MENU** and **◀/▶** button until the following menu appears on the screen

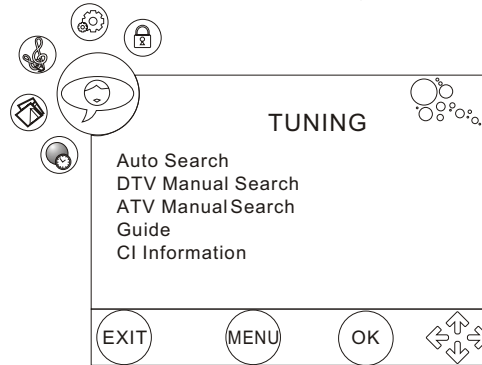

Note: This menu only appears in TV and DTV mode .

2. Press **▲/▼** button to enter the tuning menu and go up and down to select the desired option .
3. Press **◀/▶** button to increase and decrease the level to adjust the selected option to your preference .
4. Repeat step 2 and step 3 until desired quality has been achieved .

Functions:

1. Auto Search: Auto search the TV signal source for available channels, then put them in memory. Press **▲/▼** to select the item. Then press **OK** to confirm. The on-screen menu appears :

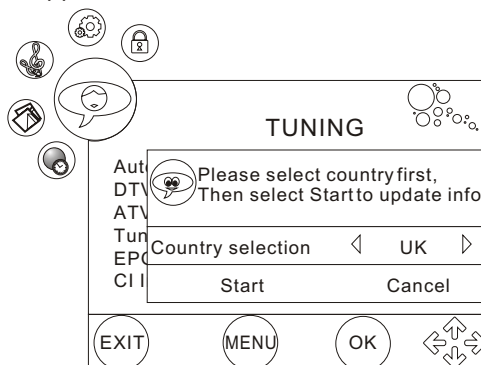

Press **◀/▶** to select the country and press **▲/▼** to select Start and then press **OK** to confirm, the following will appear on the screen:

Menu Operations

Tuning Menu Options Continued

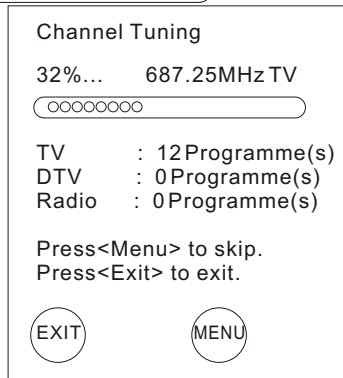

You can press **EXIT** button to enter the submenu and then select Yes to exit the tuning absolutely.

The first time you press **MENU** button the menu will display on the screen, and you can select Yes, the ATV tuning will be skipped.

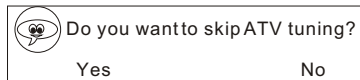

The second time you press **MENU** button the menu will display on the screen, and you can select Yes, the DTV tuning will be skipped.

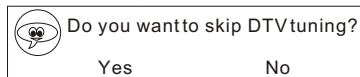

DTV Manual Search: Press **OK** button to display the submenu. After selecting DTV channel number, press **OK** again to start to search digital channel and you can press **EXIT** to exit the search.

ATV Manual Search: Press **OK** button to display the submenu. Press **▲/▼** to select the item and **◀/▶** to adjust.

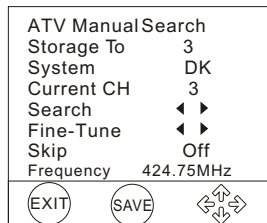

Select System among DK/L/BG/I and set the Current channel. Then select Search and press **◀/▶** to start it. Select Fine-Tune and adjust it to improve the picture. After these operation you could select Storage To to set the channel number you want to save. Then press the red button to save the adjustment or press **EXIT** to exit it.

Guide (in DTV mode only): Press **OK** button to enter the submenu.

Menu Operations

Tuning Menu Options Continued

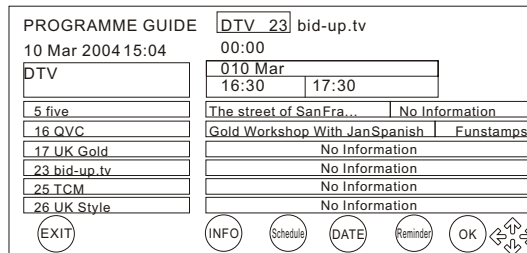

The colour of the circle is corresponding with the buttons on the bottom of the remote control.

EXIT : Press **EXIT** button to exit the screen.

INFO: Press **▲/▼** to select the program and then press **INFO** button to display the program information.

Schedule: Press the **green** button to display the schedule you have set .

DATE: Press **yellow** button to enter the submenu, then press **◀/▶** button to set the date. You can press **yellow** button again to back to the menu.

Reminder: Press **blue** button to enter the submenu.

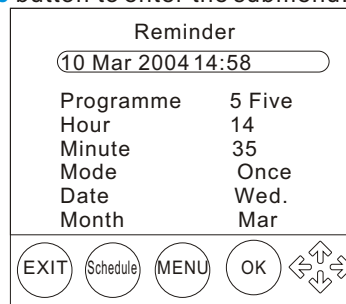

Program: Press **◀/▶** to select the program you want to watch.

Hour/Minute/Date/Month: Press **◀/▶** to set the time.

Mode: Press **◀/▶** to select Once/Everyday/Weekly .
If Everyday selected, the Date and Month will not be available.

After the operation above, press **OK** to reminder or press **green** button to display the schedule you have set.

CI Information: insert a card first and CI Module Inserted will be on the screen. After selecting CI Information, press **OK** to access the card menu. Refer to the module instruction manual for setting details.

When module is removed, the CI Module Removed will be on the screen.

Menu Operations

Time Menu Options

1. Press **MENU** and **◀/▶** button until the following menu appears on the screen

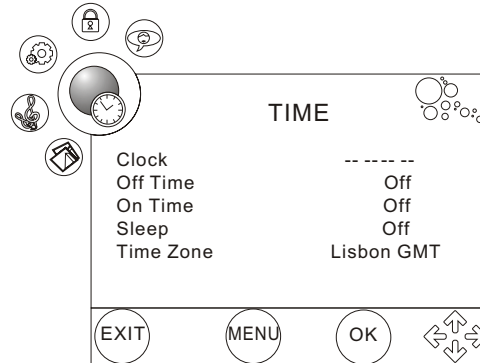

2. Press **▲/▼** button to enter the time menu and go up and down to select the desired option .
3. Press **◀/▶** button to increase and decrease the level to adjust the selected option to your preference .
4. Repeat step 2 and step 3 until desired quality has been achieved ..

Functions:

1. Clock(can not be adjusted in DTV mode): Press **OK** button to enter the submenu.

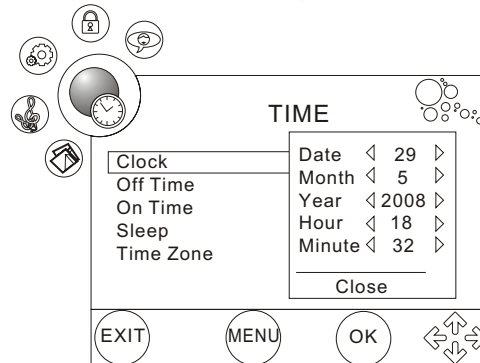

Press **▲/▼** to select the item and **◀/▶** to adjust, if you have finish the adjustment, select Close and then press **OK** to exit.

Off Time: Used to set the time that the TV goes off automatically.
Press **OK** button to enter the submenu as follows:

Menu Operations

Time Menu Options Continued

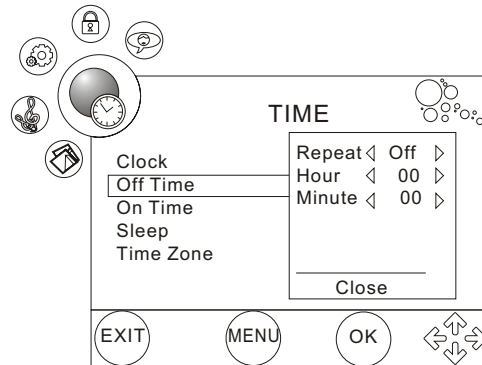

Press ▲/▼ to select Repeat and ◀/▶ to select the frequency, then set the hour and minute. (The Hour and Minute can not be available when Repeat is off). If you have finish the adjustment, select Close and then press **OK** to exit.

On Time: Used to set the time that the TV comes on automatically. And the operation is the same with the Off Time above.

Sleep: Press ◀/▶ to set the optional sleep timer.

Time Zone: Press ◀/▶ to set the optional time zone.

TELETEXT

- Teletext is an information system, broadcast by certain channels, which can be read like a newspaper . It also provides subtitles for people with hearing difficulties or those who are unfamiliar with the language in which a particular program is being broadcast (cable networks, satellite channels, etc.).

Note: The teletext buttons could be working even if there is no teletext signal, but there is no teletext display.

Teletext

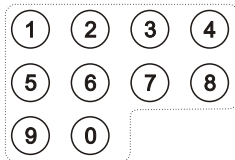
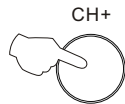
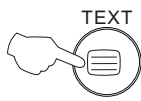

Teletext functions

To select "teletext" press the **TEXT** button on the handset. To switch off teletext, press the button again. "Note all menu functions are not available in teletext mode". Only a few direct button control functions are available in teletext mode, they are:

- Volume adjustment
- Mute function

Page up/down

Use the **CH+/CH-** buttons to browse next or previous page.

Page number entering

To select a Teletext page, enter the page number using the numeric key pad on the remote control, or use the **CH+** or **CH-** buttons, or the coloured Fast text buttons.

Mix mode

To view the TV picture while in Text mode press the  button, this will superimpose the Teletext data on top of the TV picture. Press this button again to return to Full text.

INDEX

Press the **INDEX** button to go to the index page of teletext.

TELETEXT

Teletext

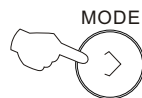

Language change

Pressing the > button will change the Teletext characters between Eastern and Western.



Hold

Pressing the button will stop the teletext page automatically updating. This feature is very useful where there are several teletext pages or data on the same page number.



Size

Pressing the button changes between full screen top half bottom half full screen. This feature is very useful as it magnifies the image making the characters easier to read.



Reveal

Pressing the button will reveal hidden text. This feature is used to reveal information such as answers to Teletext on-line interactive puzzles.

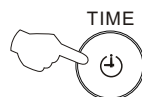

Time

While in normal TV mode only, pressing the button will display the teletext time in the top right hand corner for a few seconds.



Fast text coloured buttons

Fast text automatically displays the four most commonly used pages that the broadcaster thinks that you may want to choose next. Press the same coloured button on the remote control as the coloured link at the bottom of the teletext page to go directly to that page.



Subcode

Pressing the button by entering its 4-digit number to enter a secondary page

Basic Playback

Basic Playback

Preparations

- Operate the remote to set the TV to DVD status.

Note: The unit do not allow enter DVD mode again (or place a DVD in the disc slot)after it have just left to avoid any damage of the DVD. Wait for 10 seconds to enter again.

Basic playback

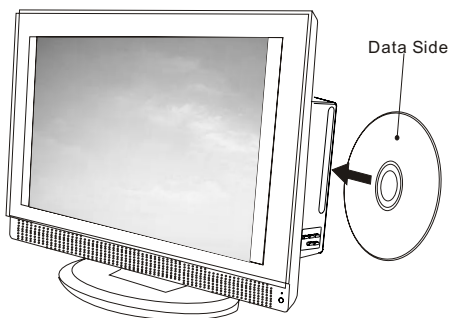

- Place the DVD in the disc slot as figure above. The disc will be loaded automatically after one to two seconds, then the DVD player reads the DVD and displays the opening menu. (If there is no disc placed on the disc slot in DVD mode, OPEN will display on the screen all the times)

- There is only one disc size can be loaded in the disc slot .
 - Do not place a disc which is unplayable in this DVD player.
 - Some disc may not playback automatically, you can press **PLAY** button to start playback.
- Some disc may start playback with a menu, use the cursor button on the remote control to select menu options and press **PLAY** to start, or press digits to select a menu options directly.

Pause playback

- Press **PAUSE/STEP** to pause playback (still mode). The sound will be muted during still mode.
- Press **PLAY/ENTER** to resume normal playback.

D.CALL

When pressing the **D.CALL** button repeatedly different OSD indicator will be displayed for different types of disc DVD, CD etc

Stop playback

- Press **STOP** button to go to stop mode, the TV screen will show the start-up logo. For some disc the player can recall the location where stopped, such as DVDs and audio CDs.
- Press **PLAY** to resume playback from the location where playback is stopped.
- Press **STOP** twice to stop completely.

Previous and Next

During playback, press **PREV** key can go back to the beginning of this chapter, then each press of this key will skip a chapter till the start of the disc. (note: Disc function may vary depending on disc format)

Each press of **NEXT** key during playback will skip the current chapter and play the next one.

Fast forward and Fast reverse

- Press **FWD** to fast forward through the disc. Each time the **FWD** button is pressed, the fast forward motion speed changes. It would cycle through 2X, 4X, 8X, 16X, 32X and normal.
- Press **PLAY** to resume normal playback.
- Press **REV** to fast reverse through the disc. Each time the **REV** button is pressed, the fast reverse motion speed changes. It would cycle through 2X, 4X, 8X, 16X, 32X and normal.
- Press **PLAY** to resume normal playback.

Single step playback

- Press the **PAUSE/STEP** button to pause the playback.
- To view the next frame, press the **PAUSE/STEP** button. Each press of the **PAUSE/STEP** button advances the film by one frame.

ZOOM

Press this button can zoom enlarge or lessen the picture. Each time pressed the picture times will be change. In zoom mode press navigation buttons to move the picture displayed on the screen

Advanced Playback

Advanced Playback

IMPORTANT NOTE:

ALL DESCRIBING FUNCTION IS FOR DVD DISCS. IF YOU PLAY OTHER FORMAT DISC, THE OPERATION AND DISPLAY ON SCREEN MAY DIFFERENT.

SUBTITLE

Press "**SUBTITLE**", the screen will display "SUBTITLE 01/XX XXXXX", "01" indicates the ordinal number of this language; "XX" indicates total number of language; "XXXXX" indicates the language of country. (the number of language depends on disc). This function can select up to 32 languages displayed on screen.

REPEAT

Press **REPEAT** button multiple times to reach desired play mode:

DVD

Chapter repeat, Title repeat, All repeat

CD

Single-play current track, Repeat One-repeat current track, Repeat Folder-repeat current folder, Folder-play current folder.

REPEAT A-B

Press **A-B** to mark the start-point, press again to set an end point to complete setting. The selected section A-B will be repeated immediately. Press the Repeat A-B again to cancel this function.

ANGLE

When enjoying sports, concert or theatre, press this key to watch same actions in different angles. (Valid for discs possessing this function. Using a disc recorded in multi-angle you can view the scene from different angles, for example, front, side, whole view and exterior scene.)

D.MENU

Press this key to display root menu, select item according to your preference. (This function will work with a DVD having a multi-layer menu.)

PROGRAM

When playing discs, press "**PROGRAM**" to enter program mode. Press the digit buttons to select the program number that you want. When finished, move the cursor to select "START". This will start the program playback. If you want to cancel this function, press "**STOP**", then press "**PLAY**".

SEARCH

Press "**SEARCH**" once to display the search menu. Use the up/down navigation buttons to select the item you require. Press **PLAY** to confirm (CD press the search button several times to select the item). And then press the numeric buttons or navigation buttons to input the item you require. Press **PLAY** to confirm.

SLOW PLAY

Press **SLOW** to play a disc in slow forward. Each time the **SLOW** button is pressed, the slow motion speed changes.

Press **PLAY** to resume normal playback.

Note: This function is invalid for CD.

AUDIO

Press this key can change the audio mode.

such as: Audio 1/2: AC 3 2 CH English

Audio 2/2: AC 3 5.1 CH English

If you play CD disc, press this button can cycle among Mono Left, Mono Right, Mix-Mono and Stereo.

Note: When press this button continuously, you must above 3 seconds interval.

TITLE/PBC

With some DVD discs pressing this key will display the title menu. You can then use the digit buttons to select the item you prefer.

Special Function Playback

JPEG DISC PLAYBACK

Insert a picture CD or JPEG picture CD into the tray and the disc will be loaded automatically. If the disc type can be identified, the player will start showing the pictures one by one (slide show mode). If a navigation menu will be displayed use the navigation buttons to select a file, then press the **PLAY** button.

Each picture in the CD will be displayed consecutively in a slide-show fashion and will be scaled to fit in the whole TV screen. Some slide show transition modes are provided, use "**PROGRAM**" key to select. Customer can set transition effects for each picture.

To display an image indefinitely, press the "**PAUSE/STEP**" key. To view the next or previous picture, press "**NEXT**" or "**PREV**" key. To resume the slide show, press the "**PLAY**" key.

Press the **STOP** button to preview the photos in a folder. Press navigation buttons to rotate a picture.

SCREEN SAVER FUNCTION

If this unit is idle for 3 minutes, it will go to sleep mode with screen saver on. In this mode, you can press any key on remote control or on front panel to activate the unit.

You can set Screen Saver function to Off in General Setup Page of dvd system setup.

DVD System Setup

DVD System Setup

General Setup Process

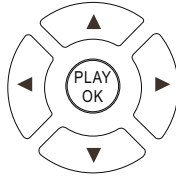
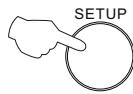

1. Press the **SETUP** button, the General Setup Page, Preference Page will be displayed in turn.

2. Press **▲** or **▼** to select, the item, then press **▶** to enter the submenu.

3. Press **▲** or **▼** to select then press **OK** to confirm.

4. Press **SETUP** repeatedly to exit the set-up menus.

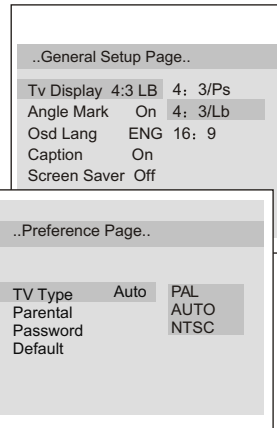

General Setup Page

ASPECT RATIO DESCRIPTION

When using the DVD with the internal TV, select 4: 3/LB.

The following information applies only when the DVD output is connected to an external TV.

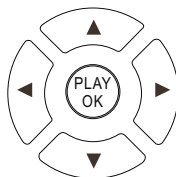

- **4: 3/PS** (PS = Pan and Scan)

You may select this if you have a normal aspect ratio (4:3) TV, although the NORMAL /LB (letter box) is a more common choice. In

PS mode, widescreen material will fill the screen, but at the expense of chopping off extreme left and right edges of the original film picture. For this feature to work, the disc must be specially coded. Such discs are uncommon.

- **4: 3/LB** (LB = Letter Box)

You may select this if you have a normal aspect ratio (4:3) TV. Widescreen material will be shown in pure unaltered form, allowing the entire picture area of the original film to be viewed without any side cropping. Black bars will appear above and below the picture.

- **16: 9**

You may select this if you have a widescreen (16:9) TV. Black bars may still appear above and below the picture even if using a widescreen TV. This is because some film directors prefer to use ultra widescreen aspect ratios e.g. 2.35:1. This will normally be indicated on the DVD packaging.

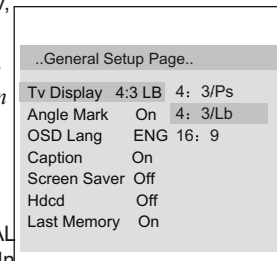

DVD System Setup(Continued)

DVD System Setup

General Setup Page

Angle Mark: Users can select a particular camera angle when playing a DVD which offers multiple angles.

This item allows you to set Angle Mark On or Off.

On Screen Display (OSD) Language: Users can select on-screen display language.

(The languages you can select may differ from different countries or models)

Caption: This function allows you to display or hide the caption.

Screen Saver: If the screen saver is on, then there will be an animated picture of DVD on the screen whenever the DVD player is idle for more than 3 minutes.

Hdcd: When default setting is off, it will display CD by reading HDCD, for HDCD playback, please choose 1X or 2X.

Last Memory: Memorize the chapter you have just watched. When last memory is on, if you turn on the DVD again after off it will display from the chapter you watched when you turn off the DVD.

..General Setup Page..		
Tv Display	4:3 LB	
Angle Mark	On	On
Osd Lang	ENG	Off
Caption	On	
Screen Saver	Off	
Hdcd	Off	
Last Memory	On	

..General Setup Page..		
Tv Display	4:3 LB	
Angle Mark	On	
OsdLang	ENG	English
Caption	On	French
Screen Saver	Off	German
Hdcd	Off	Spanish
Last Memory	On	Italian

..General Setup Page..		
Tv Display	4:3 LB	
Angle Mark	On	
Osd Lang	ENG	
Caption	On	
Screen Saver	Off	
Hdcd	Off	
Last Memory	On	

..General Setup Page..		
Tv Display	4:3 LB	
Angle Mark	On	
Osd Lang	ENG	
Caption	On	
Screen Saver	Off	On
Hdcd	Off	Off
Last Memory	On	

..General Setup Page..		
Tv Display	4:3 LB	
Angle Mark	On	
Osd Lang	ENG	
Caption	On	
Screen Saver	Off	
Hdcd	Off	Off
Last Memory	On	1X
		2X

..General Setup Page..		
Tv Display	4:3 LB	
Angle Mark	On	
Osd Lang	ENG	
Caption	On	
Screen Saver	Off	
Hdcd	Off	
Last Memory	On	On
		Off

DVD System Setup(Continued)

DVD System Setup

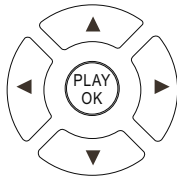
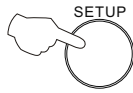

Preference Page

The Preference Page is only available when there is no disc in the player. These settings are applied consistently to all discs which are inserted and played.

TV Type: This player supports different TV output, including AUTO, NTSC, and PAL systems. Usually please set to MULTI.

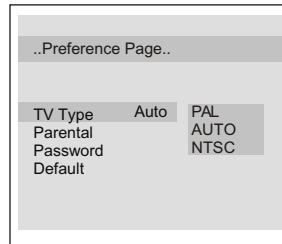

Parental: The parental control function works in conjunction with the different censorship classes assigned to DVDs. These classes help to control the types of DVDs that the family watches, There are up to 8 censorship classes for DVDs.

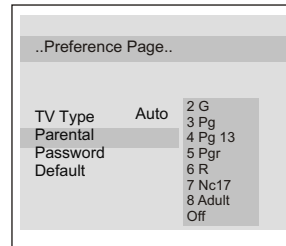

Note:

- 1 To change this setting you must enter your password. (Initial password is 0000)
- 2 When set to Off, all discs may be viewed.

Password change:

You can change your password by entering 4 digits. You must confirm the 4 digits before the new password can be accepted.

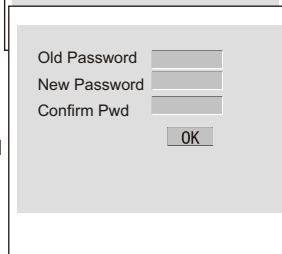
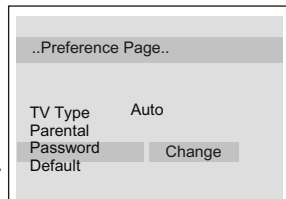

NOTE: If you forget your password or a password is accidentally set enter 1369 as the password. This will enable you to regain control.

DVD System Setup(Continued)

DVD System Setup

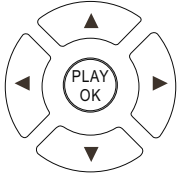
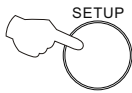

Default: Resets all settings (except password and parental lock status) for this DVD player back to the manufacturers original settings. Press OK to perform the reset.

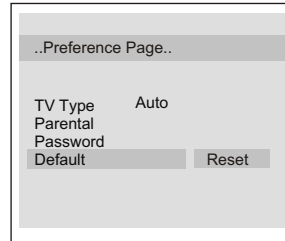





Note:

Some functions may not be available depending on the type of disc.

Playable Discs

The following discs can be played:

DISCS	LABEL	CONTENTS	DIMENSION
DVD VIDEO		Audio +Video (moving picture)	12cm
AUDIO CD		Audio	12cm
JPEG		Video(picture)	12cm
KODAK CD		Video(picture)	12cm
CD-R	CD•R	Audio or Video (moving picture)	12cm
CD-RW	CD-RW	Audio or Video (moving picture)	12cm
CD+G	CD+G	Audio(picture)	12cm

Support discs: DVD, CD-R, CD-RW, HDCD, JPEG, CD+G, Kodak CD , W MA.

- You cannot play discs other than those listed above.
- You cannot play non-standardized discs, even if they may be labeled as above.
- The performance of CD-R or CD-RW disc is depend on the way of disc-burning. In a few cases, their performance may not be very well or even not playable.

Dics Protection and DVD Characteristics

ON HANDLING DISCS

- Do not touch the playback side of the disc.
- Do not attach paper or tape to disc.

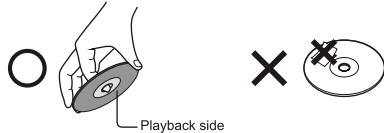

ON CLEANING DISCS

- Fingerprints and dust on the disc cause picture and sound deterioration. Wipe the disc from the centre outwards with a soft cloth. Always keep the disc clean.



- If you can not wipe off the dust with a soft cloth, wipe the disc lightly with a slightly moistened soft cloth and finish with a dry cloth.
- Do not use any type of solvent such as thinner, benzene, commercially available cleaners or anti-static spray for vinyl Lps. It may damage the disc.

ON STORING DISCS

- Do not store discs in a place subject to direct sunlight or near heat source.
- Do not store discs in place subject to moisture and dust such as a bathroom or near a humidifier.
- Store discs vertically in a case. Stacking or placing object on discs outside of their case may cause warping.

STRUCTURE OF DISC CONTENTS

Normally, DVD discs are divided into titles, and the titles are sub-divided into chapters. Audio CD are divided into tracks.

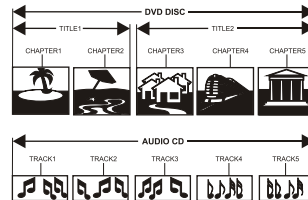

Each title, chapter, or track is assigned a number, which is called title number, chapter number or track number respectively.

There may be discs that do not have these number.

Compare DVD disc with other discs:

	DVD				LD
Encode method	Digital/MPEG II				Analog
Capacity	Single-side single-layer 4.7G	Double-side single-layer 8.5G	Single-side double-layer 9.4G	Double-side double-layer 17G	
Playing Time	133 minutes	242 minutes	266 minutes	484 minutes	Single-side 60 minutes double-side 120 minutes
Disc diameter	12cm				30cm/20cm
Horizontal resolution	More than 500 line				No more than 430 line
Picture proportion	Multiple kinds				One kind
Subtitle	32 kinds				16 kinds at most
Sound quality	48KHz, 96KHz/ 6, 20, 24bit				44.1KHz/ 16bit

Troubleshooting Guide

- To assist in location possible faults use help guide below.

Troubleshooting

No picture, no sound	Verify if the television is properly plugged in. Verify if the television has a proper supplied power source. Verify if electricity is available.
Blank screen	Verify if correct signals are input. Operate the remote to change signal input to correct input. Restart the television if power supply is interrupted.
No sound	Press MUTE button and verify if Mute mode is set. Switch to other channel and verify if the same problem happens. Press VOL+ button to see if the problem can be solved.
Poor sound	Verify if sound system is correct. Refer to user's manual for adjustment.
No picture in some channel	Verify if correct channel is selected. Adjust the antenna.
No color for some channel program (black and white)	Verify if the same problem exists in other channels. Check out of picture and sound systems. Refer to relative instructions in the Manual for color adjustment.
Spots with some or all pictures	Verify if the antenna is correctly connected. Verify if the antenna is in good condition. Make fine adjustment of channel.
Television out of control	Disconnect the television from power supply and 10 seconds later, connect the television to the power supply. If the problem still exists, contact authorized after-sales service for technical assistance.

Note:

- 1.If the fault can not be repaired using the above guide consult with your local authorized service center.
- 2.The TV set must only be repaired by a qualified registered service person. Never attempt to remove the back cover as the TV set has dangerous voltages in side that may cause a fatality or fire.

Specifications

Specifications of the television that you have just purchased may vary from the information in this table due to technical innovations.

Model	15" 15.4"	19"	22"
Picture, sound system	PAL/SECAM-B/G,I,D/K,L,L'		
Audio output	≥1.5W+1.5W		
External input port	COMPONENT input PC input S-VIDEO input Audio input SCART Antenna input HDMI input		
Power requirements	~150-240V 50/60Hz		
Power consumption	≤50W	≤60W	≤70W
Temperature	Working:5°C~35°C Storage:-15°C~45°C		
Humidity	Working:20%~80% Storage:5%~90%		
Accessories	Remote control Batteries Owner's manual		

● Note:
All specifications are subject to change without notice.
All quality are approximate value.

Haier

V0.1
0090502138