



# OWNER'S MANUAL

Great *Little* campers...  
For the great *Big* outdoors.

**Camp-Inn™** Travel Trailers  
Petenwell Industries LLC  
555 Kucirek Street, Necedah, Wisconsin  
[www.TinyCamper.com](http://www.TinyCamper.com)

©2012 Petenwell Ind. LLC

**Revised 8/21/2012**

## **IMPORTANT SAFETY INSTRUCTIONS**

### **FOR USING YOUR CAMP-INN™ TRAVEL TRAILER**

**ALWAYS** make sure that your ball hitch is properly tightened and that the ball hitch is the correct size.

**NEVER** unlock or rotate the hitch jack if the hitch is not on the ball hitch.

**ALWAYS** block the trailer wheels **BEFORE** unhitching to prevent rolling.

**NEVER** leave the stove unattended when the burners are lit.

**ALWAYS** keep a fire extinguisher nearby when using a stove.

**NEVER** slide a lighted stove into the storage area in the kitchen cabinets.

**ALWAYS** turn off the propane tank when the stove or furnace is not in use.

**ALWAYS** turn off the propane tank when you are traveling.

If you smell propane, **NEVER** use a flame to detect a propane leak. Check for leaks using a soap solution on connections.

**NEVER** use candles, fuel type lanterns, fuel type heaters, or any other oxygen depleting device inside the sleeping compartment.

**ALWAYS** open a side window, at least ½ inch for ventilation when the sleeping area is occupied.

**ALWAYS** pull the trailer entirely off of the roadway before changing a flat tire.

**NEVER** use the leveling jacks to lift **both** wheels off the ground at the same time, while the trailer is in use.

**If you are new to trailer towing, refer to “Towing Basics” section before hitching, unhitching or towing your Camp-Inn™ trailer.**

**This list does not include all possible hazards.**

**If you have any questions about using your trailer safely, contact Petenwell Ind. LLC**

# Table of Contents

Safety Instructions	2	Alcan Cover	22
Table of Contents	3	Sunroof	23
VIN tag & Serial #	4	Receiver Hitch	24
Packing Your Camp-Inn™	4	Roof Rack	24
Setting Up	5	Furnace	25
Locks	6	Air Conditioner	26
Kitchen	7-16	Door Screens	26
Hatch	7	Roof Fan	27
Table	8	Raindrop™	
Stove	9	Couch / Bunk Beds	28-29
Propane Tank	10	Maintenance	30
Counter Lids	11	Cleaning	31-32
Sink/Water		Wheel Bearings	33
Tank Meter	11	Brakes	33-34
Freshwater Tank	11	Jacks	35
Graywater Tank	13	Storage	36
Winterize	14	Towing Basics	37
LP Gas Outlet	15	Tongue Weight	38
Windscreens	16	Hitching	38
TV/DVD Player	16	Unhitching	39
Front Storage Box	17	Using Trailer Brakes	40
Electrical		Downgrades	41
7-Prong Connector	17	Overdrive	42
Bulb Replacement	18	Backing	42
Fuses	19	Tires	43
AC Power	20	Specifications	44
Battery Charge	20	Troubleshooting	44-45
Solar Charging	20	Maintenance Schedule	45
DC Disconnect	21	Teardropping Tips	46-47
Battery Meter	21	Electrical Schematic	48-49
Battery Replacement	22	Index	50-52

## **VIN Vehicle Identification Number and Serial Number**

The trailer's VIN tag is located near the tongue jack on the trailer frame.

The Serial Number tag shows the build number of your trailer. **Camp-Inn**<sup>TM</sup> trailers are numbered sequentially as they are built. The tag is mounted to the hatch hinge on the left side of the kitchen.

## **Packing your Camp-Inn**<sup>TM</sup>

The first rule for happy camping in your **Camp-Inn**<sup>TM</sup> is:

**"Take only what you need! "**

It is very easy to over pack and take along too much STUFF. After a few trips you should be able to weed out the extras. The large cabin area allows you to take along items such as beach toys, lawn chairs, canopy, screen tent, etc... but, think about each item and determine if it is necessary. You will have to unload these items to use the bed.

One trick for packing your teardrop is to put a piece of masking tape on every item you pack. When you use each item, remove the piece of tape. After 2-3 trips, if the item still has tape on it, consider leaving it home. Exceptions will be emergency items such as spare tire, first aid kit, fire extinguisher, or raincoats.

Pack heavy items as close to the axle as possible. Heavy items packed directly above the axle will not affect the trailer tongue weight. See the section on *Teardrop Tips* for more information on weight distribution.

Trailers often ride rougher than your car or tow vehicle. Items may bounce or shift during travel. Objects rubbing together may cause wear spots or scratches. Placing pieces of cloth between dishes or pans will reduce wear. Also, it helps to pack items tightly. If objects can't move, they can't wear. Pack the heavier items to the bottom. Avoid using glass containers. **Camp-Inns** have a "frying pan slot" in the under-counter storage compartment. This "frying pan slot" gives you a place to store heavy fry pans, keeping them from beating against other dishes.

Items packed in the duffel shelf may not stay put if you hit bumps or brake hard. It is best to place your duffels on the bed during travel.

During travel, clothes, on coat hangers, can be hung from the coat hooks inside the cabin. When you stop for the night, these clothes can be laid on the car seat to get them out of the way.

Make sure all doors and hatch are latched and locked during travel.

## Setting Up Your Camp-Inn™

When you arrive at your campsite, select a suitable spot for setting up your trailer. You should pick an area that is fairly level. Care should be taken to ensure that there is adequate clearance for opening of side doors and the rear hatch. Keep in mind that the area behind the trailer will be your kitchen/dining area.

**Wheel Chock Blocks** - Before unhitching your trailer, even on level ground, place chock blocks ahead and behind both trailer wheels to prevent the trailer from rolling.

**If you have the parking brake option, it is recommended that you still use the chock blocks, in case the brake lever is accidentally released.**

If the camping area is extremely sloped, it is recommended to leave the trailer hitched to the tow vehicle for stability. An extremely sloped area would be any area that slopes more than 8 inches in the length of the trailer or slopes more than 6 inches from side to side.

**Leveling** - If the ground in the campsite is not level, the trailer should be leveled, side-to-side. Adjust the leveling jack on the “Low” side first. When the trailer is level side-to-side, lower the leveling jack on the “High” side until it touches the ground.

*(TIP) (no pun intended) A food can laid on it’s side, on the countertop, will indicate level side to side. The can will roll toward the low side. Also, small adhesive backed levels are available at many hardware stores and may be attached to the trailer cabinets or body for reference.*

**NEVER use the leveling jacks to lift BOTH wheels off the ground at the same time, while the trailer is in use.**

Unhitch the trailer from the tow vehicle and use the hitch jack to raise or lower the tongue, leveling the trailer, front to back.

*(TIP) You can use the doors as level indicators. Open the doors so they are perpendicular to the trailer. If the tongue is low, the doors will swing further open. If the tongue is high, the doors will swing closed. Adjust the tongue jack up or down until the doors do not swing.*

You may leave the trailer hitched to the tow vehicle and still use the tongue jack to raise the head of the bed slightly for stability and to reduce movement. *Remember to fold jack before driving.*

## Locks

When locking the doors and hatch, you may need to move the handle slightly up and down to allow the locking mechanism to properly engage. Do not force the lock, as this may damage the locking mechanism or break off the key. If the lock does not turn freely even when wiggling the handle, it may need to be lubricated.

To prevent sticking, door locks and hatch locks should be lubricated regularly with a silicone spray lubricant. Silicone lubricants work better than graphite, since the silicone helps repel water. After severe weather, you should lubricate the locks to displace any water that may have entered them.

### **Main Door Locks:**

The main doors may be locked from both the inside and the outside. The inside and outside locks are independent from each other.

### **If the inside door latch is locked, you will not be able to unlock it from the outside.**

For this reason, do not leave small children alone inside the trailer as they may accidentally lock the doors and be unable to understand how to unlock them. (*this has happened*)

Also, when packing, make sure there are no boxes or other items that may accidentally bump the latching lever and lock it. (*this has happened*) If this happens and a window is unlocked, open the window and push in the screen. You can get a tool to reinstall the window screen at a hardware store.

*If both inside latches and both windows are locked, the only way to open the door is to remove the hinge. NOTE: You must re-seal the screws with urethane caulk. Apply a small dab in the hole before replacing screw.*

### **If the outside door lock is locked, you will not be able to unlock it from the inside.**

When you open the door, do not lock the outside lock. If you are inside the trailer and the wind blows the door shut with sufficient force, it may engage the latch. (*this has happened*) If this happens open the window and push out the screen. Hopefully you have the key to unlock the door.

### **Rules to Lock By:**

**If you are outside: Make sure BOTH inside latches are un-locked.**

**If you are inside: Make sure BOTH outside locks are un-locked.**

**Lock the hatch and doors during travel.**

# Kitchen

## ***To open the rear hatch***

Unlock the handle and rotate it vertically. Slowly raise the hatch. If the hatch gives any resistance, look under it to make sure the prop rod is sliding smoothly. On new trailers, you may need to assist the prop rod, with one hand, sliding it along the groove on the bottom end. Make sure that the prop rod slide is fully moved to the bottom end of the groove before releasing the hatch.

## ***To close the rear hatch***

When closing the hatch, rotate the handle *vertically* to pull back the locking bars.

Slowly raise the hatch with one hand lifting in the center of the hatch. Using your other hand, slide the bottom end of the prop rod upward, along the groove. As you guide the bottom end of the

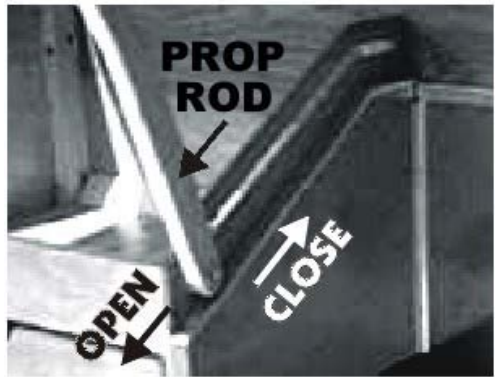

prop rod toward the top of the groove, slowly lower the hatch. The hatch should close smoothly without binding. If you feel resistance, do not force the hatch closed. Check for items that are too tall and may be hitting the hatch, ribs or prop rod. Check that the prop rod is sliding along the groove properly.

**When new, the hinge may slide from side to side. If the hatch binds when almost closed, open hatch at least half way and then tap it sideways to center the hatch.**

Close the hatch fully and rotate the handle *horizontally*, extending the locking bars, latching the hatch.

Without rotating the handle, tug on the handle to ensure that both sides of the hatch are properly latched. Hatch should be locked during travel.

## Table

The kitchen table is easily set up at the campsite or roadside stop. Fully read through this step-by-step procedure before attempting to set the table up for the first time.

1. **Before** removing the table from the stowed position, **Pull leg** and while pulling, pivot to the vertical position.
2. In the vertical position, make sure leg snaps down into the stops.
3. Remove the folded table from the countertop and rotate it so the leg is pointing down and the hinge end is lined up with the trailer hinge.
4. Pull the latch lever back and slide the hinge halves together.
5. Rotate the brace on the bottom of the table so it is at right angle to the table.
6. Open the tabletop.
7. Level the table by pushing the button on the leg and moving lower leg section up or down.

**To Stow the Table:** Reverse the order of above steps.

- **Pull leg** before pivoting it to the horizontal position.
- When stowing, slide the guide pins into the holes in the cabinets.

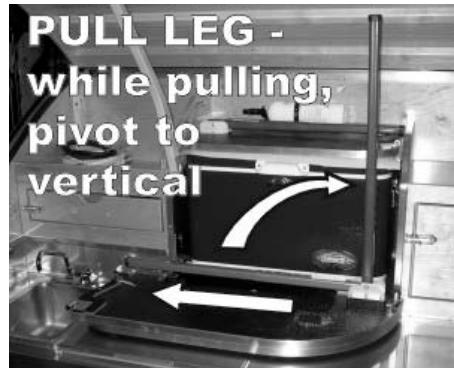

**Side Table** - The Side Table/Cooler stand sets up in a similar manner and stows on top of the cooler with the fire extinguisher away from you.



**Stove** - The **Camp-Inn™** stove gives you a two-burner stove with a propane tank mounted on the trailer tongue. The stove slides under the left cabinet during travel or when not needed. When needed, the stove slides into the cooler storage area.

### *Using the kitchen stove*

To use the stove, it must first be slid out of its storage area.

1. Grasp the elbow, on the front right corner of the stove, and slide the stove fully to the right. The entire stove should be out from under the cabinet. *It will not be centered in the alcove.*
2. Make sure that both burner valves are in the OFF position.
3. Turn ON the propane tank at the front of the trailer.
4. Light a match or lighter and hold it near the burner.
5. Slowly open the burner valve until the burner lights.
6. **Do not** leave the stove unattended when lit.
7. If the flame burns yellow, or soots the bottom of pans, adjust the air mixture screws on the sides of the valves to make the flame burn blue with slight yellow or red tips.

### *Stowing the kitchen stove*

To safely stow the kitchen stove, follow these steps:

1. **Never** slide the stove under the cabinet when burners are lit.
2. Turn off burners and allow to stove to cool.
3. Clean the stove with mild soap and water.
4. Turn **off** the propane tank at the front of the trailer.
5. Grasp the elbow at the right of the stove and slide the stove fully to the left under the cabinet.
6. If the stove does not stay fully under the cabinet, pull the stove out and reach under the cabinet. Pull a little of the hose out where it goes into the cabinet base. Try sliding the stove under the cabinet again.
7. If you do not have a cooler, fill the cooler storage area with other gear to prevent the stove sliding out.

During the first use, the paint will burn off some of the burner and grate. You may repaint it with a high temperature paint, like barbecue grill paint, or leave it unpainted.

**Because the stove has high output burners, it may be necessary to use a “flame tamer” or “simmer ring” to be able to simmer or limit heat.** *Flame tamers and simmer rings are available at sporting goods stores, cooking stores, or online.*

## Refilling LP (Liquefied Propane) Tank

The propane tank should be removed from the trailer for refilling. Make sure the tank valve is shut off before unhooking. When reconnecting the tank, check for leaks with a soap and water solution on the joints. The tank is equipped with an OPD (Overfill Prevention Device).

### Where to find propane refilling stations while on the road:

- Truck stops
- RV Dealerships
- Private Campgrounds
- Hardware Stores
- Farmer Co-Ops
- U-Haul™ stores

The tank mount bracket is sized to also fit a 20 lb. propane tank (*size on most BBQ grills*). In some situations you may want to use a 20 lb. tank.

- For cold weather, when running the furnace for extended periods.
- Extended trips to remote areas.
- 20 lb. tanks can be exchanged rather than refilling.

*Keep in mind that exchanging is usually more expensive than refilling.*

## Checking Propane Tank Level:

### To check the propane tank level with the LP Gas Meter:

1. Run the stove or furnace for at least 5 minutes.
2. While running stove or furnace, Check Gas Meter.
3. Read the scale based on the ambient temperature.  
Green – Plenty of fuel  
Yellow – Fuel level low  
Red – Empty or almost empty

### To check the level of the tank without a LP Gas Meter:

1. Unhook the propane tank.
2. On the collar, look for the Tare Weight. (*example TW 13.4*) *This is the weight of the empty tank.*
3. Weigh the tank of propane on a scale. (*example 18 lbs.*)
4. Subtract the measured weight from the Tare Weight. Result is the weight of propane in the tank. ( $18 - 13.4 = 4.6$  lbs of propane)
5. The small **Camp-Inn™** tank, when full, will hold about 9-10 lbs of propane. (*example tank above is about 1/2 full*)
6. A 20 lb. tank will only hold about 16-17 lbs. of propane.\*

\*Propane tanks are filled only 80-85% of their rated capacity. This allows a head space for generation of the gaseous form of propane.

## Under Counter Storage Lids

The under counter storage lids can be removed for cleaning. Open the lid fully. Operate the release at the bottom of the hinge at "A" and pull outward on the bottom of the hinge.

To reinstall, hook the hinge first at "B" then push the bottom of the hinge "A" inward until it locks.

The lids are not interchangeable.

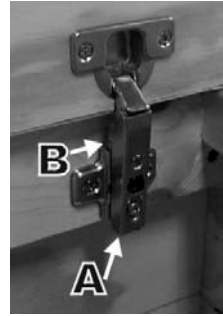

## Sink / Water System

If your **Camp-Inn™** has a water system, you can operate the sink either from the onboard water tank or connected to city water. Your trailer comes with an eight-gallon fresh water tank, an electric, on demand, water pump and an eight gallon “gray” (drain) water tank.

**Drain – Flush – and Fill** the freshwater tank before each use.

**Water Tank Meter** – If your trailer has a water tank meter, you can easily monitor the level of the fresh water and gray water tank.

Pushing the “FRESH” button will display the current level of the fresh water tank.

**F (full), 2/3, 1/3, or E (empty)** This level is only approximate.

Pushing the “WASTE” button will display the current level of the gray water tank.

Pushing the “BATTERY” button will display the approximate level of the battery:

**C (charging), G (good), F (fair), or L (low).**



**Filling the fresh water tank** - Unlock and open the water access door on the side of the trailer. Flip up the blue tab on the water fill cap. Unscrew the cap. The tank has a vent line that comes out on the underside of the trailer. When water flows as a continuous stream out of the vent line, the tank is full. If you attempt to fill too quickly, the water may overflow, from the water fill, before the tank is full.

*You can not fill the freshwater tank directly from the city water quick connect.*

**Switching ON the Water System-** The pump on the freshwater system is activated by a switch . The switch is located near the AC and DC outlets in the kitchen. The switch is lighted in the ON position.

If you will not be using the water for a while, turn OFF the pump switch. A slightly dripping faucet may drain the freshwater tank in only a couple hours. Turning OFF the switch will prevent any dripping as well as prevent unnecessary pump cycling.

When the fresh water tank is empty, the pump will continue to run, even if the faucet is turned OFF. Turn OFF the **pump switch** when the tank is empty. Running the pump for a few minutes without water will not hurt the pump. Extended running without water may overheat pump motor.

Do not store items in front of the switch during travel. Items may accidentally activate the switch if items shift or bounce.

### ***Troubleshooting Water System***

If the water does not flow when you turn on the valve, here is a checklist to help you troubleshoot:

- Is the pump switch ON (illuminated)?
- Is there water in the tank?
- Is the battery charged?
- Check Fuse.

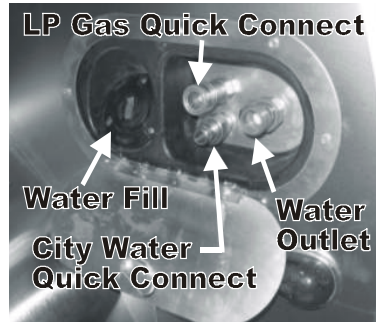

**Cleaning the sink trap-** The sink trap and drain are best kept clean through regular preventative maintenance. If you use a liberal amount of soap when washing dishes, that will help keep grease from clogging the trap and gray water tank.

If the sink seems to be draining slower, try the following:

1. Check that the gray water tank is not full.
2. Pour a large kettle of boiling water down the sink drain.
3. Put 2 tablespoons of RV tank enzymes in the drain and add about one cup of water. Let stand for 24 hrs. Then repeat #2.
4. If all else fails, the trap may be removed for cleaning. You must remove the left side access panel under the sink and the false floor below the sink. Remove the screw holding the sink drain. Cut the zip tie on the bottom of the trap to disconnect. The zip tie will need to be replaced when re-assembling.

### **Water System Hookup Kit-**

- A** - City water quick connect and pressure regulator.
- B** - Four feet long water hose.
- C** - LP accessory gas line.

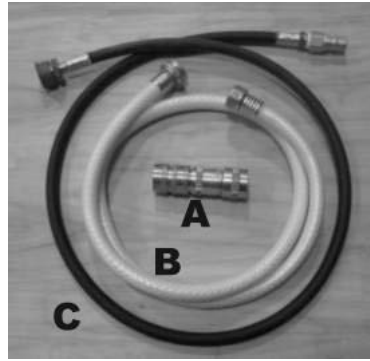

### **Using the City Water Hookup –**

Install the city water quick connect and pressure regulator (**A**) on the male end of a regular garden hose. Attach the

female end of the garden hose to the spigot at the campsite. To attach the quick connect to the trailer, pull back on the outer sleeve, push the quick connect onto the male connector on the trailer, then release the outer sleeve. Tug on the connection to make sure it is secure before turning on the water spigot.

**Using the Water Outlet –** The water outlet will operate either from the onboard water tank, or from city water, when it is hooked up. To operate the water outlet from the onboard water tank, turn on the water pump switch (*see Switching on the Water System*).

When you are connected to city water, the pump is bypassed and the water outlet will use city water only.

The four foot long hose (**B**) has been supplied for connection to the water outlet. Use this hose to fill buckets, add a sprayer, fill the freshwater tank, or connect to other water accessories.

*If you want to fill the onboard freshwater tank when you are connected to city water, connect your four feet long hose to the water outlet and use the hose to fill the tank.*

**Draining the fresh water tank-** Simply remove the cap, on the drain spout, at the bottom rear of the tank. To more fully drain the tank, raise the tongue of the trailer. Remember to reinstall the cap before you fill the fresh water tank. The tank should be filled with water during storage in non-freezing weather.

**The gray water tank-** The sink drains into a "gray water" holding tank. The gray water tank is the same size as the fresh water tank. About the time that your fresh water tank is empty, your gray water tank will be full. If the gray water tank is over filled, wastewater will flow out of the tank's vent, under the trailer.

To drain the gray water tank, remove the cap from the gray water tank drain valve, then open the drain valve. The valve handle is on the underside of the valve. To more fully drain the tank, raise the tongue of the trailer.

You may want to attach a short hose to the drain valve to help direct the flow away from the camper or down a sewer drain.

**NEVER use a gray water hose for filling the fresh water tank.**

**NEVER use the fresh water hose for draining the gray water tank.**

In a campsite with sewer hook-up, you may leave the gray water drain hose installed at all times.

Remember to close the valve and reinstall the cap when you are finished draining the gray water tank,

During warmer weather, you may want to add a small amount of RV holding tank enzymes or chemicals to control the odor. Add the enzymes or chemicals by pouring them in the sink drain and flushing them down with some water. These chemicals are available at all RV dealerships.

If the drain valve clogs due to particles in the wastewater, you may unscrew the drain valve to clean it. This will also drain the tank more quickly and completely.

**Winterizing the water system-** Before freezing weather, fully drain both the fresh water and gray water tanks. Reinstall the drain caps. Add at least two quarts of **RV (non-toxic) antifreeze** to the freshwater tank. Turn on the electric pump until antifreeze comes out of the faucet. Run at least two cups of anti-freeze into the sink drain to protect the trap and gray water tank. Spray the sprayer and burp the side water outlet.

**DE-Winterizing the water system-** Before using a water system that has been winterized, fully drain the fresh water tank. Fill the tank with water and drain it. Fill tank again and run the faucet for about 1 gallon of water. If the water still has a slight RV anti-freeze odor or taste, Drain the tank again, refill, and run the faucet.

**Sanitizing the fresh water tank-** If your water has a strange odor, color or taste: •Drain the fresh water tank fully. •Sanitize the tank by adding one (1) cup (8 oz.) of plain (unscented) chlorine bleach then filling the tank with fresh water. •While filling, run at least one quart of water out of the faucet. •Fill tank until water runs out of the vent tube. •Let stand for 1/2 hour. •Drain the tank by running the faucet and allowing the bleach water to go down the sink drain. This will help clean out the gray water tank as well. •Refill the freshwater tank with fresh water, then

drain the tank again by removing the drain cap. •Refill with fresh water. •Run at least one gallon of water out of the faucet. •After this treatment, the water may have a slight chlorine taste and odor, but that will go away with time and is not harmful. •Remember to drain the gray water tank.

**Calcium/Lime Treatment-** If the water you use has a high calcium or lime content it may foul the tank sensors and add scale to the faucet. At the end of the season, add about two gallons of white vinegar to the fresh water tank, fill the rest of the tank with water and let sit overnight. Run the water through the faucet and into the gray water tank. And let that sit over night. Drain the gray water tank and flush both tanks with fresh water before storing for the season. Repeat more often for harder water.

**Using the LP Gas Outlet** – The LP Gas Quick Connect allows you to use LP accessories such as barbecue grills, lanterns, or water heaters. A four feet long LP gas hose is provided for easy connection to your accessories. One end of the LP gas hose has a male quick connect for attaching to the trailer. The opposite end of the LP gas hose has a fitting like those on the disposable 1 lb. propane tanks. This hose can be attached to any LP accessory that normally uses the 1 lb. disposable tanks.

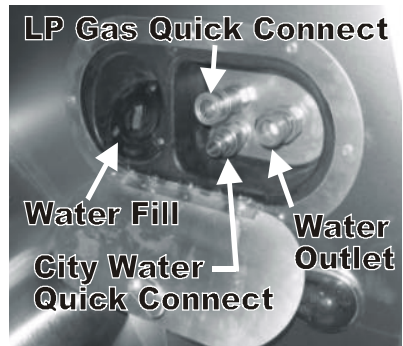

**ALWAYS** - turn off the main trailer LP tank before connecting or disconnecting the LP gas quick connect.

Connect the LP gas hose to your LP accessory **BEFORE** connecting to the trailer's LP gas quick connect.

Turn off your LP accessory and disconnect the trailer's LP gas quick connect **BEFORE** disconnecting the LP gas hose from your LP accessory.

You can use both the trailer's stove and the LP accessory at the same time. This picture shows all three hoses attached at the same time.



## Windscreens Option

The windscreens in the kitchen snap into place. They may be rolled up or fully removed when not needed.

Roll the windscreens inward so they do not interfere with closing the hatch. When using the Velcro tie-backs, bias them toward the inside of the trailer. If they are biased to the outside, they may interfere with the hatch seal.

## TV/DVD Player

If your **Camp-Inn™** has the TV/DVD option, you can view TV, DVD movies and play music CD's. With the exception of the following instructions, refer to the TV/DVD owner's manual for operating the TV/DVD player.

Your TV/DVD player will draw power even if it is *OFF*. A Power Shutoff Switch is provided to disconnect power to the TV/DVD player.

This switch will prevent discharging the battery when the TV/DVD player is not in use.

The switch has an indicator light or is lighted to make it obvious when it is ON.

The switch is on the left side of the cabinet near the wall.



**Ejecting the DVD:** If you press the Eject button on the remote when the TV is in the Up position, the DVD will eject and hit the inside of the cabinet. **DO NOT OPEN** the TV! Wait about 10 seconds and the TV will retract the DVD. Then carefully open the TV making sure that the DVD is back inside the TV.

Opening or closing the TV while the DVD is ejecting may break the DVD and may damage the TV/DVD player.



**Antenna Jack** - There is an external antenna jack provided on the driver's side of the camper. This jack allows for the connection to an external antenna, cable television or even a satellite dish.



# Front Storage Box

The lower section of the front storage box is intended for storage of items that may be dirty like wheel chock blocks, welcome mats, extension cords, hoses, etc. It has drain holes that allow for you to wash it out if needed.

# Electrical

## 7-Prong Connector

The trailer connects to the tow vehicle with a 7 prong connector.

The connector has a raised rib along one side to orient the connector when mated. The cover or door on the tow vehicle side of the connector has a locking detent that engages with the raised rib to lock the connector when it is fully engaged.

Before mating, inspect both connectors for corrosion on the contacts. If light corrosion is present, plug and unplug the connector several times. Usually this is sufficient to self-clean the contacts. If the corrosion is more severe, you can scrape it with a tool or clean with a small piece of sandpaper. In the most severe cases, the connector will need to be replaced.

To minimize corrosion and dirt fouling, the connector should be stored so it is not in contact with or near the ground.

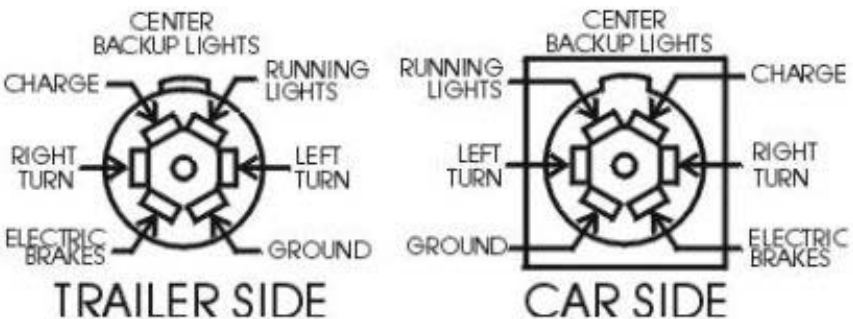

## Operating Xenon Lights

The xenon lights (chrome, Ultra) have a dimmer and a switch to toggle between white and red light. The red light will help keep your night vision by leaving your pupils dilated.

The xenon light can be turned off TWO ways:

1. Rotating the dimmer switch all the way down until it clicks.
2. Putting the red/white toggle switch in the middle position.

If the light fails to work, try both switches.

## Replacing Light Bulbs

**Standard Lights** - Remove the plastic lens on the light by squeezing it slightly. Remove the lights by pushing in and rotating. Replace with a bulb of the same number.

**Xenon Lights** - Remove the three screws holding the lens. Remove the lens carefully. Pull the light bulb out. Replace the bulb with the same size and type. Use a clean cloth or paper towel to hold the new bulb when replacing. **Do not touch the new bulb with your fingers.** Oils on your hands will reduce the bulb life.

**Tail Lights** - Using a small screwdriver, gently pry the light module out of the black rubber trim ring. Unplug the connector from the back of the light module. Replace with a new light module. Carefully push the light module back into the rubber trim ring. The bulb inside the module can not be replaced.

**Side Marker Lights** - Remove the screw holding the colored lens. Push in and twist the bulb to remove. Install a new bulb with the same number. Replace lens.

LOCATION	BULB	SPECIFICATION
Xenon Lights	JC10XE/12	Xenon 10W G4-base 12V
Classic RV Lights	1141	Trade Number 1141
Tail Light Standard or LED	6" Oval Module Stop/Turn/Tail	6-1/2" L x 2-1/4" W; Sealed, 3-prong plug connection
Ultra Side Marker	57	Trade Number 57
Classic Side Marker	67	Trade Number 67
License Plate	67	Trade Number 67

**DC Fuses-** The fuse block is located behind an access cover on the right side, in the under counter storage box. Loosen the two screws on the corners of the access cover. Rotate the cover to remove it. There is a fuse diagram on the back of the cover. To prevent damage to wiring, trailer, or accessories, replace fuses with the same size and type.

***The Fan has two fuses. One on the fan itself and one in the fuse block under the kitchen counter.***

***There are inline fuses for the battery isolator and solar controller located above the battery. Remove battery access cover for access.***

***There is an inline fuse for the charger located under the trailer, near the charger.***

Circuit	Fuse	Location
Cabin DC Outlet	15A Blue ATC	Fuse Block -Position 1 (top)
Kitchen DC Outlet	15A Blue ATC	Fuse Block -Position 2
Cabin/Kitchen Lights	10A Red ATC	Fuse Block -Position 3
TV	10A Red ATC	Fuse Block -Position 4
Water Pump	10A Red ATC	Fuse Block -Position 5
Roof Fan / Furnace/ Front Storage Outlet	10A Red ATC	Fuse Block -Position 6 (bottom)
Roof Fan	4A 3AG Slow-Blow Glass	On Roof Fan Housing
Battery Isolator	3A Purple ATC	Inline Fuse Holder, above battery
Solar Controller	10A Red ATC	Inline Fuse Holder, above battery
Charger	7.5A Brown ATC	Inline Fuse Holder, under trailer between water tanks.

## **AC Power- 110VAC**

**Shore Power-** Below the right taillight, there is an AC input receptacle. Plug in an extension cord connected to any 110/120V AC source (at home or a campsite with hookup). While you are plugged in, you will have 110V AC power to the three prong receptacles in the kitchen and cabin and the one for the air conditioner. If you do not have 110V AC power at these receptacles, try pressing the "Reset" button on the GFI kitchen receptacle. If you still do not have AC power, check the source outlet for power. Try a different AC source outlet or a different circuit. If the source outlet is improperly wired, it may cause GFI tripping.

**AC Fuse/Breaker-** The AC Circuit Breaker is located next to the GFI outlet in the kitchen. The button in the center will pop out when tripped. Wait about 2 minutes then push the button to reset the breaker.

## **Battery Charging**

If your **Camp-Inn™** is a Special, Classic or Ultra Model, it has it's own on-board battery and charger and your trailer has been wired for charging by the tow vehicle.

The length of time you can go between charging depends on how many of the lights you use and how long they are on. The roof fan, TV and other DC appliances will use your on-board battery power.

If you only run one light at a time, you should be able to run for 60+ hours or more of "lights-on" time. If you are conservative, using the roof fan only when you are sleeping and watching the TV sparingly, you can go several days on a charge. Heavier use will require more frequent recharging.

## **Solar Charging**

The optional solar input is located on the curb side near the rear of the trailer. Attach the provided connector to your solar panel for easy connection. Position the panel in full sun for best results. Move panel periodically to follow the sun as it moves across the sky.

The solar charge controller will handle up to 10 amps or 120 watts from your solar panels. A 15 watt panel will trickle charge your battery. A 60-80 watt panel will work for medium duty like lights and roof fan. A 90-120 watt panel is recommended to run a CPAP machine or DC Refrigerator.

## DC Power Disconnect Switch

Located on the right side of the right, under-counter storage compartment is the DC Power Disconnect Switch. This switch disconnects all loads from the battery. If you are storing your trailer or just want to make sure everything is OFF, turn the DC Power Disconnect Switch to the OFF position.

In the OFF position, the battery is still connected to the on-board charger and the tow vehicle charging circuit.

**Battery Meter** – If your trailer has a battery meter, you can quickly check battery level. Pushing the “BATTERY” button will display the approximate level of the battery:

**C (charging), G (good), F (fair), or L (low).**

(The **F, 2/3, 1/3, E** scale is for water tanks)

**Charging from tow vehicle-** If your tow vehicle is properly wired for it, you can recharge your trailer's battery any time the trailer's 7-prong electrical connector is connected to the tow vehicle and the tow vehicle's engine is running.

## On-Board Charger-

Below the right taillight, there is an AC power 110V input receptacle (shore power). Plug in an extension cord connected to any 110/120V AC source (at home or a campsite with hookup). Your battery will start recharging immediately and should fully recharge within 8-10 hours.

Plug in your voltage meter into the DC outlet in the kitchen. After plugging in to 110/120V AC, the voltage on the meter should slowly increase. The voltage on the meter should never exceed 15.0V. If it exceeds 15.0 V, disconnect the AC supply and contact **Camp-Inn™**.

If the voltage on the meter does not increase, you may need to press the "Reset" button on the ground fault receptacle in the kitchen for the charger to operate.

The automatic charger allows you to leave your **Camp-Inn™** plugged in continuously without worrying about over charging.

If you are concerned that your battery is not charging properly, go to the Charger Troubleshooting Flow Chart on page 45.



**Battery Isolator-** If the trailer's 7-prong electrical connector is connected to the tow vehicle and the tow vehicle's engine is NOT running, the trailer's cabin lights and accessories may drain the tow vehicle's battery. To prevent discharging the tow vehicle's battery you must either disconnect the trailer's electrical connector or have a battery isolator.

A battery isolator electrically disconnects trailer and tow vehicle any time the tow vehicle's engine is shut off. If you did not get the Battery Isolator Option, you should consider installing a battery isolator in your tow vehicle. Check with a local mechanic or RV dealer to have one installed.

### **Battery Replacement**

If the battery does not hold a charge, it may need to be replaced. The battery is located behind an access cover on the right side, in the under counter storage box. Remove the four screws on the sides of the access panel. The battery should only be replaced with a battery of the same size and type.

***Be sure to mark the polarity of the wires before you remove them and install the wires to the correct polarity on the new battery.***

### **Alcan Cover**

The Alcan cover (front padded bra) is good for preventing stone damage to the front of the trailer or may be added later to cover damage. Once installed, it is usually left in place. The cover will trap moisture and cause the aluminum beneath it to tarnish. The tarnish will actually slow the rate of corrosion.

If you travel in areas with road salt or ocean spray, you will want to wash under the Alcan cover as soon as possible to minimize corrosion.

#### **To clean under the Alcan cover:**

- Unhook the elastic under the trailer.
- Lift up the flaps to wash underneath.
- Dry or allow to air dry fully before re-hooking elastics.
- The Alcan cover may be removed by sliding the top sideways out of the rail at the top. *(it does not need to be removed for normal cleaning)*

## Sun Roof

If your **Raindrop™** is equipped with a sunroof, you may open your sunroof for added ventilation during fair weather. Sunroof may be left open during travel.

**To Open:** Pull forward on the handle at the rear of the sunroof. Rotate the handle upward until it toggles into the locked position.

**To Close:** Make sure there the seal is clean and clear of debris (like pine needles). Pull the center of the handle to un-toggle it. Rotate the handle downward until it locks the sunroof closed.

### To Remove Glass:

1. Remove the sunroof screen.
2. Squeeze the spring pin actuator inward to disengage the handle from the frame.
3. With one hand, lift the glass 3" or 4". With the other hand, unlatch both cam locks on the front hinges by pulling down the gray levers. (*See "Unlatched" Diagram*)
4. Lift the glass out by pulling back gently. Store safely to avoid chipping the edge or scratching the surface.

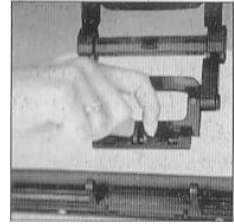

**Step 2**

### To Replace Glass:

1. Align the front hinges of the glass with the pins located on the frame. Push the gray levers on both cam locks "forward" to lock them in place (*See Diagrams to right*)
2. **IMPORTANT:** Lift the glass about 3 inches and pull rearward gently to ensure proper engagement. Close the glass and make sure there is no wrinkling or binding on the weather seal.
3. Reattach the main latch. Squeeze the spring pin actuator inward, align with the holes in the brackets, then release and push the actuator outward to fully engage. (*See Diagram 1*)
4. **IMPORTANT:** Operate the opening lever, and check that the glass is securely in place – both front and rear!

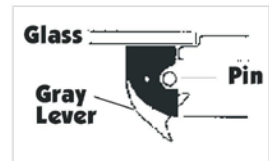

**Unlatched**

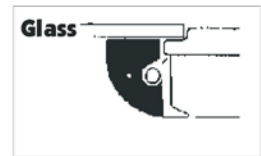

**Latched**

To prevent leakage and/or loss of glass, please make sure that the front latches are secure under the pins, and that levers are locked flat before traveling.

## Receiver Hitch Option

If your **Camp-Inn™** is equipped with a receiver hitch, you can use it to haul bicycles. The receiver hitch has a **150 lb. load limit** (bikes and bike carrier weight combined). It is designed and intended only for a two bike carrier. It has not been designed or tested for towing a second trailer or using any other receiver type cargo carrier. Exceeding the load limit of the receiver hitch will reduce tongue weight, and may create a hazardous towing situation.

## Roof Rack Option

The Yakima™ brand roof rack system mounted on **Camp-Inn™** trailers has a **200 lb. load limit**. Various Yakima™ accessories, such as bike racks, cargo haulers, kayak racks, etc. are available at sporting goods stores nationwide. For hauling long items such as canoes, you must tie a rope from the front of the canoe to the tongue of the trailer, and a rope from the rear of the canoe to the rear of the trailer. If you do not have a rear bumper or receiver hitch option, you must provide your own attach point for the rear rope. Contact **Camp-Inn™** about best location for this attach point. (DO NOT tie to the hatch handle or license plate holder or light)

### Removing Cross Bars-

The cross bars of your roof rack may be removed by prying outward on the tower's cover. Unlock both sides then lift off the crossbars and towers together.

**Locks-** Yakima™ offers key locks for the towers to make them tamper-resistant.

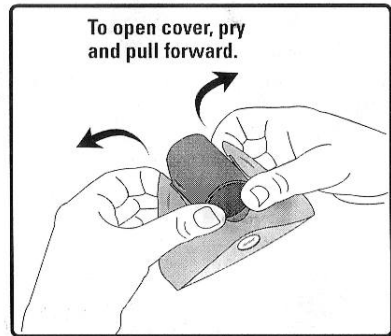

### • Remove rack.

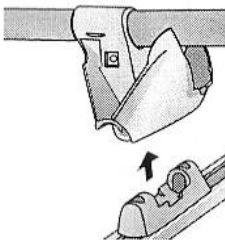

Use the Landing Pad cover when the Control Tower is not in use.

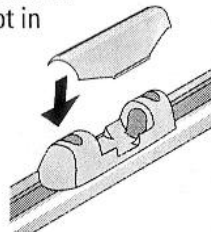



## Furnace

### WHAT TO DO IF YOU SMELL GAS

- Evacuate all persons from the vehicle.
- Shut off the gas supply at the propane tank.
- Do not touch any electrical switch, or use any phone or radio in the vehicle.
- Open the main doors to ventilate the cabin area.
- Contact the nearest gas supplier or qualified service technician for repairs.
- Do not turn on the gas supply until the leak(s) has been repaired.

**WARNING!** Do not install screens over the exhaust vent for any reason. Screens will become restricted and cause unsafe furnace operation. Accessories are being marketed for RV products which we do not recommend. For your safety, only factory authorized parts are to be used on your furnace.

**WARNING:** The air returns are inside the top of the front storage box. Do not fill front storage box so full that air returns are blocked.

### To operate the furnace:

1. **STOP!** Read the safety information on the label in the front storage box of your trailer.
2. The appliance is equipped with an ignition device which automatically lights the burner. Do **not** try to light the burner by hand.
3. Turn propane tank shut-off valve to “ON” or “Open”.
4. Set thermostat to desired setting. The fan should start.
5. If the fan does not start, try a higher thermostat setting, verify that the electrical power is ON, and check the furnace fuse.
6. The furnace will try to ignite 3 times. If it does not ignite, the furnace will “lock-out”.
7. If the furnace should “lock-out,” the blower will go off in 5 minutes and remain off.
8. To reset the unit, turn the thermostat off, wait until the fan turns off. Verify that there is propane in the propane tank and that the tank valve is on.\*\* Then, reset thermostat to desired setting.
9. If the appliance will not operate, after three “reset” attempts call **Camp-Inn™**.
10. To turn off the furnace, set the thermostat to the OFF position.

\*\* If the kitchen stove operates normally, with both burners lit, for more than one minute, the propane tank valve is ON and there is sufficient propane to light the furnace.

## Air Conditioner

Because of the small volume of the **Camp-Inn™** cabin, it is recommended that you run the air conditioner on the lower settings. Running your air conditioner on higher settings will cause more rapid cycling and will not be as effective at removing the humidity from the cabin air.

If the air conditioner cycles excessively, even on the lower setting, try opening the side windows a little bit.

As the outside temperature increases, an air conditioner will decrease in efficiency. Direct sunlight will also increase the load on the air conditioner and decrease efficiency. At higher temperatures, and in full sunlight the air conditioner efficiency may decrease to the point that the air conditioner stops cooling. If this happens, move the trailer into shade or add a canopy over the trailer until the temperature drops or the sun goes down.

The air conditioner has a drain pan for condensation and rainwater. The drain comes out the bottom of the trailer. Once a year, you should flush out the drain by running water into the roof vent and watching for it to drain out the bottom. Inside the cabinet below the air conditioner, there is a section of clear tube where you can inspect for water flow and possible clogs.

## Door Screens

The door screen option adds a full door size screen that zips open and closed. To reduce the risk of damaging the screen, it should be un-zipped fully when you are entering or exiting the cabin or sitting in the doorway.

When left open, the screens should be rolled up and tied back. The best method for rolling up the screens is as follows:

1. Unzip the screen fully.
2. Fold the upper 6 inches (*approximately*) downward and to the inside.
3. Starting at the free end, roll the screen inward\* and toward the hinge.
4. When rolled up tightly, use the Velcro™ ties to hold in place.

*\*Rolling inward helps keep the screen from interfering with the door.*

## Roof Fan

To open the roof vent, turn the X shaped knob. This will raise the vent top. The vent must be open for the fan to operate.

The Fantastic Vent™ fan has three controls: Direction, Speed, and Thermostat.

**Direction:** Select whether you want the fan to blow outward or inward. *If you want to reverse direction, turn the fan off, and let it come to a complete stop before reversing switch and restarting.*

**Speed Control:** Turn on to the desired speed.

**Thermostat:** The thermostat may be adjusted to automatically turn the fan OFF if the temperature drops or to turn the fan ON if the temperature increases.

The fan will turn OFF automatically when you lower the vent lid.

If the fan does not turn ON, you must make sure:

1. The vent is open far enough to release the switch
2. The Direction switch is selected IN or OUT
3. The Speed knob is turned to 1, 2, or 3
4. AND - That the Thermostat is set high enough.

The vent should be closed during travel. Always close the vent fully during inclement weather.

**Rain Sensor Fantastic Vent™** This option has an automatic closing feature when the fan detects rain.

For Rain Sensor to operate, the Speed Control must be set on 1,2 or 3.

***If you set the Speed Control to “0”, the Rain Sensor WILL NOT FUNCTION!***

NOTE: If you want the Rain Sensor to function with the **vent open** and the **fan off**, set the Speed Control on 1,2 or 3 and the In/Out switch to the middle (Off) position.

To open the vent, push the Vent Open Switch (near the X shaped knob).

**To stop the vent cover part-way open:** As the vent is **opening**, grab the X shaped knob and hold it until the vent cover stops. **DO NOT grab the X shaped knob when the vent cover is CLOSING.**

In case of power failure, pull down on the X shaped knob and close manually by rotating knob. Make sure the knob is pushed up and re-engaged to restore automatic function.

# Raindrop™ Couch / Bunk Bed

The **Raindrop™** Models have a bench that converts into a couch and a set of bunk beds. Following are instructions on how to convert from one into another:

**Bench Mode:** The frame is folded and placed on the floor as far forward as possible. This creates a raised platform in the front of the cabin. Both cushions may be placed on the frame to make a seating area.

If only one cushion is used, it will lay flush with the mattress and will extend the length of the bed for taller people.



## Converting Bench to Couch:

For more comfortable semi-reclined seating....

1. Move all the cushions out of the way.
2. Lifting the frame, pull the frame toward you until it can be dropped onto the notched blocks, near the doors.
3. Lift the backrest against the front wall.
4. Put the solid cushion on the seat.
5. Put the cushion with “wings” against the backrest.
6. To convert back to a bench, simply reverse the steps.

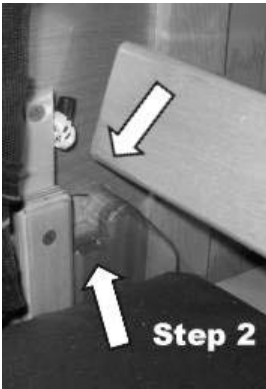

## Converting Bench to Bunk Beds:

To make a set of bunk beds for smaller children.

The beds are about 54" long.

1. Move all the cushions out of the way.
2. Make sure the back rest is folded down onto the frame seat.
3. Kneeling on the bed, grab the frame by the two hand holes.
4. Lift the frame up and place the far edge of the frame onto the front window sill.
5. Lift the side of the frame closest to you, up, higher than the window sills.
6. Extend the two bolt latches outward and make sure they lock.
7. Lower the frame until the bolt latches rest on the window sills.
8. Raise the headboard, that is attached to the floor.
9. Swing the two wings on the ends of the headboard outward until they contact the walls.

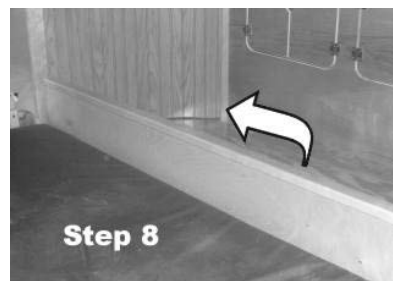
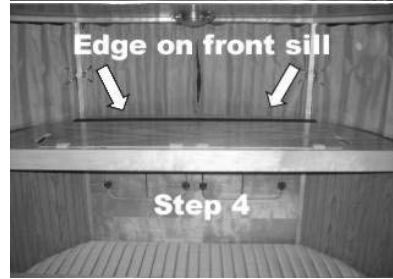
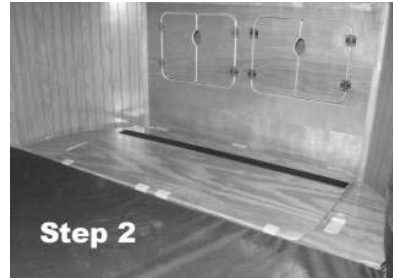

10. Put one cushion on the upper bed and one on the lower bed.
11. The upper bunk railing is added by dropping the tabs on the railing into the slots in the front of the frame.
12. To convert back to a bench, simply reverse the steps.

# Maintenance

With proper maintenance, your **Camp-Inn™** trailer will give you years of trouble-free service.

## Inspection

Your **Camp-Inn™** trailer should be inspected before every use. Here is a checklist of items to inspect:

- **Tires** - Check for proper inflation pressure and adequate tread.
- **Lights** - Make sure all brake, turn signal, running, and marker lights are working.
- **Hardware** - Check for loose or missing screws and bolts. Tighten or replace as necessary.
- **Lubricate** - Oil hinges, locks and latches for smooth operation.
- **Battery** - **Camp-Inn™** uses a maintenance-free type battery. All it should need is regular recharging. Typical battery life is 3-5 years. Battery capacity will decrease with age.
- **Sink** – Drain, Flush, and Fill fresh water tank and check pump operation. Check sink drain for clogs. Drain gray water tank.

## Hatch

When new, the hatch hinge may slide from side to side. If the hatch binds when almost closed, open hatch about half way and then tap it sideways to center it.

Make sure the area between the side gaskets and the body is kept free of dirt, leaf litter and debris. This may cause water to back up and leak past the gasket. Closely inspect the area near the hinge.

## Air Conditioner

The air conditioner has a drain pan for condensation and rainwater. The drain comes out the bottom of the trailer. Once a year, you should flush out the drain by running water into the roof vent and watching for it to drain out the bottom. Inside the cabinet below the air conditioner, there is a section of clear tube where you can inspect for water flow and possible clogs.

As the outside temperature increases, an air conditioner will decrease in efficiency. Direct sunlight will also increase the load on the air conditioner. At higher temperatures, and in full sunlight the air

conditioner may stop cooling. If this happens, move the trailer into shade or add a canopy over the trailer until the temperature drops or the sun goes down.

## Cleaning

**Always wash your trailer as soon as possible after traveling near a saltwater beach, or on winter roads where salt has been used.** The salt will cause corrosion of the aluminum resulting in white spots and pitting on the aluminum surfaces.

**Always test cleaning methods or chemicals on a hidden area and allow to dry fully, before using on the rest of the trailer.**

**Interior-** Clean the interior of the trailer with mild soap and water using a soft sponge or rag.

**Exterior-** Clean the exterior of the trailer with a mild soap and water and a sponge. Using plain water, rinse off as much of the dirt as possible before using the soap and sponge. Use liberal amounts of water. Start at the roof and work your way down. Rinse off the soap suds before they have a chance to dry.

To preserve the original brushed finish, only rub in the grain direction of the original brushed finish.

We recommend cleaning the aluminum regularly with Walbernize™ brand cleaner.

For heavy oxidization or stains, use Bon Ami™ cleaner on a damp rag. Rub very gently in the direction of the original brushed finish. Use only the pressure of the weight of your hand. Any more pressure when rubbing will cause scratching. Randomize the rubbing stroke length so the edges of the cleaned area are “feathered out.” Practice in a less visible area before doing a visible area. **Keep in mind, Spot cleaning makes clean spots.** You may need to clean entire areas or the whole trailer to have a uniform appearance.

**Fenders-** Use purple Scotch Brite™ pads for cleaning brushed stainless steel parts like the fenders, water door and LP tank bracket. Use pad dry and in the direction of existing brushed finish. **DO NOT** touch or use pads on the aluminum surfaces. Scotch Brite™ pads can be purchased at most auto parts and hardware stores.

*Cleaning continued...*

**Wheels and Bumper-** Use fine 000 steel wool for cleaning the chrome wheels and hubcaps and polished stainless bumper. Use an automotive wax to protect the wheels and hubcaps after cleaning.

**Stainless Countertops and Kitchen Surfaces-** For regular cleaning of the stainless steel in the kitchen, use soap and water. Periodically for deeper cleaning, use an aerosol type stainless steel appliance cleaner. Hint: use very little. *Do not use the stainless appliance cleaner on the aluminum.* For heavy or burned-on stains try Bon Ami™ cleaner on a damp rag.

**Windows-** The front windows are made of acrylic. Clean with mild soap and water and a soft cloth. Glass cleaners may be used but you must make sure that the cleaner is acrylic safe. Side windows are tempered glass so any glass cleaner may be used. **DO NOT** get the glass cleaners on the aluminum as it may cause discoloration.

**Curtains-** Curtains should be dry-cleaned only. Curtains are removed by unscrewing the end caps from the curtain tracks and sliding the curtain clips off the end. When re-installing the curtain end clips, **do not fully tighten** them. The curtain end clips are supposed to be free to move.

## **Interior Moisture and Condensation**

Under normal use, it is common for condensation to accumulate in the cabin overnight. The condensation is more apparent during colder weather as it forms on the insides of windows and on aluminum trim. Leaving the side windows or roof vent open slightly will help reduce the condensation. In the morning, you can wipe off any condensation with a towel. In fair weather, leaving the windows and sunroof open during the day or when traveling will help keep the inside dry and aired out.

Your **Camp-Inn™** has been designed and built to keep out rainwater. Under normal circumstances very little if any water should leak into the cabin or kitchen areas. Due to damaged, worn or aged gaskets and seals, or severe weather, leaks may occur. After any rainstorm or after driving in the rain, you should inspect all areas of your trailer to look for signs of leaking. Any water found should be dried up immediately. You should inspect, to determine if the source of the leak can be found. It is your responsibility to caulk cracks, or repair or replace gaskets to prevent further leaking.



## Wheel bearings

Wheel bearings should be checked every 2000 miles to check for proper adjustment. To check wheel bearing adjustment:

- Jack the trailer up so one wheel is off the ground.
- From the side, grab the wheel front and rear.
- Push and pull the wheel side to side.
- You should get only slight movement (Less than 1/16")
- If you get more movement, have it checked and adjusted by a qualified mechanic or technician.
- It is recommended that you have the wheel bearings inspected by a qualified mechanic or technician before any major trip.

Wheel bearings should be repacked every 50,000 miles or when the tires are replaced or trailer brakes are inspected. If you are towing in severe temperatures or loading your trailer to near its weight capacity, you should repack the wheel bearings more often.

## Brake Maintenance

Brakes should be adjusted after the first trip or after at least 200 miles of operation, when the brake shoes and drums have "seated." After that, brakes should be adjusted at 4000 mile intervals, or as performance and use requires. The brakes should be adjusted in the following manner:

1. Park on a flat level surface and chock the wheels. Make sure the parking brake lever is released. (*if installed*)
2. Jack up one side of the trailer until the tire is off the ground. Check that the wheel and drum rotate freely.\* *You do not need to remove the wheel.*
3. Remove the adjusting hole cover from the adjusting slot on the bottom of the brake backing plate.
4. With a screw driver or brake adjusting tool, rotate the starwheel of the adjuster assembly to expand the brake shoes.
5. Spin the wheel and adjust the brake shoes out until the brake shoes drag against the drum for about one quarter of the revolution.\*\*
6. Replace the adjusting hole cover.
7. Lower trailer and repeat on opposite side.
8. Adjust parking brake. (*if installed*)

\* If the brakes drag or make a grinding noise before being adjusted, the brake mechanism should be inspected.

\*\* If the brakes grab erratically or make a grinding noise after being adjusted, the brake mechanism and drums should be inspected.

## Brake Inspection

Your trailer brakes should be inspected and serviced at 2-year intervals or more often as use and performance requires. Magnets and shoes must be changed when they become worn or scored thereby preventing adequate vehicle braking.

Clean the backing plate, magnet arm, magnet, and brake shoes. Make certain that all the parts removed are replaced in the same brake and drum assembly. Inspect the magnet arm for any loose or worn parts. Check shoe return springs, hold down springs, and adjuster springs for stretch or deformation and replace if required.

It is recommended that you repack the wheel bearings any time the brakes are inspected.

It is more cost effective to replace the entire backing plate assembly than to replace the brake shoes alone. A new backing plate assembly will give you a new magnet as well and all new springs, etc. Also, they are easier to install ... simply remove the four bolts holding it on and disconnect two wires.

## Parking Brake Adjustment

Periodically check the parking brake.

- On a level surface, lock the parking brake handle then push on the trailer to test the parking brake.
- If the brake does not grip sufficiently, release the parking brake handle and twist the handle several turns.
- Re-apply the parking brake and test again.
- Adjust the brake handle until the brakes hold.

If you accidentally drive with the parking brake applied, and you smell hot brakes, you may have damaged the brakes. Release the parking brake and allow the brakes to cool before proceeding. You should have the brakes inspected as soon as practical to make sure they are still working safely.

If you drive **more** than ½ mile with the parking brake accidentally applied, and they do not smell hot, you should adjust the brakes.

If you drive **less** than ½ mile with the parking brake accidentally applied, the brakes should not be damaged and probably don't need to be adjusted. Check the parking brakes, before using, to make sure that they still grip sufficiently.

## **Lubricating the Leveling Jacks**

Lower the jack until it touches the ground. Using a Popsicle stick or small brush, wipe a small amount of general purpose grease into the threads of the jack screw. It is only necessary to add it to one side of the screw. The grease will be distributed when the screw is turned. Raise and lower jack. Wipe off any globs of grease. The leveling jacks should be lubricated annually.

## **Lubricating the Tongue Jack**

Hitch the trailer to the tow vehicle. Rotate the jack to about 45 degrees. Crank the jack handle to lower the wheel, exposing about 10 inches of the jack tube. With a brush, wipe a light coating of general purpose grease onto the jack tube. Give special attention to areas showing wear.

Crank the jack handle to raise the wheel all the way. Un-hitch the trailer. Wipe off grease on areas exposed when the trailer is sitting level. (*this will minimize the dirt and grit getting into the grease*) The tongue jack should be lubricated annually.

## Storage

As with any travel trailers, the **Camp-Inn™** travel trailer should be stored in a cool dry place when not in use. Proper storage methods will preserve the good looks and condition of your **Camp-Inn™** for many years.

When storing your **Camp-Inn™** for the winter or for extended periods of more than a week, follow these procedures:

- Turn OFF the DC Power Disconnect Switch. (p.21)
- Recharge battery fully before storing for the winter or any extended period. Recharge battery, at a minimum, once every 3 months during storage.
- Drain the freshwater and gray water tanks (see section on **Kitchen Sink**) If you are storing it in an area where freezing temperatures are a possibility, add RV non-toxic anti-freeze to the water system. See Section on **Winterizing** the water system. (p.14)
- It is recommended that, your **Camp-Inn™** should be stored in a building. Leaving the windows and hatch open for a while will help dry out the cabin and kitchen areas.
- A temporary shelter like those made by Shelter Logic™ are a good second choice. *www.shelterlogic.com*
- If you cannot store it in a building, or a temporary shelter, you should use a **Camp-Inn™** storage cover. This storage cover is weather resistant and water repellant but like any cloth cover it may develop small leaks with age. After any major rainstorm or multiple days of rain, your trailer should be inspected, inside kitchen and cabin, for water that may have leaked in.
- You should NEVER store your **Camp-Inn™** travel trailer under a plastic tarp or other non-breathable covering. Doing so may cause condensation to form on the outside and inside of the trailer and may cause mold, mildew or rot. This may also cause corrosion of the aluminum skin creating blemishes on the surface.
- There should be space around your trailer for airflow.
- Storing your trailer in a manner not consistent with the above procedures, or storing outdoors for extended periods without covering, will void the warranty.

## Towing Basics

Safe trailering is essential in making your **Camp-Inn™** experience pleasurable for years to come. If you do not have experience pulling trailers, please read through this section to familiarize yourself with the basics of safe trailering.

### Vehicle and Hitch Rating

Before trailering your **Camp-Inn™** travel trailer, it is necessary to make sure that it does not exceed the towing capacity of your tow vehicle. There are two important factors to check; towing weight and tongue weight. Exceeding either of these may void the tow vehicle's warranty. To determine these ratings for your vehicle, contact your automobile dealer, or check with a company that installs hitches.

### Hitch Height

To make your **Camp-Inn™** trailer look right when it is being towed, the ball on your hitch should be set at the proper height for your trailer model.

**Street Model:** 14"-16" measured from ground to top of ball.

**SUV Model:** 17"-19" measured from ground to top of ball.

To measure this height without the trailer hitched, apply a downward force of about 200 lbs to the hitch or rear bumper of the tow vehicle. (sit on the bumper while measuring.)

Being outside these ranges by up to 3" either way will not damage the trailer, but the trailer will not look level. Being outside these ranges by more than 3" may affect tire wear and will increase or decrease tongue weight, potentially causing unsafe handling.

### Total Weight

Check with your automobile dealer to determine the maximum recommended towing weight of your tow vehicle. This will be the total of the trailer's weight and all gear and supplies that will be hauled in the trailer. Determining the actual weight of the trailer with all your gear can be difficult. The easiest method is to load the trailer and then take it to a truck stop and weigh it on their scale. Make sure you disconnect the trailer from your tow vehicle to get an accurate reading.

## Tongue Weight

Tongue weight, is the downward force of the trailer tongue on the tow vehicle's hitch. Proper balancing of the trailer is important to ensure smooth trailering. Too little tongue weight will cause the trailer to sway or wander. Too much tongue weight will push down on the rear of the tow vehicle and may overload the hitch or tow vehicle's rear axle.

Tongue weight should be between 140 lbs. and 220 lbs. The acceptable range for your tow vehicle may be different.

Tongue weight is easily adjusted by shifting the loading of gear and supplies within the trailer. Loading gear in front of the trailer's axle will increase tongue weight. The further forward you load it, the more it increases the tongue weight. Loading gear behind the axle will reduce the tongue weight. Loading weight directly above the axle will have no effect on the tongue weight.

Tongue weight can be easily be determined by placing the tongue of the trailer on a scale and loading the trailer, adjusting the load to give the desired result. *Make sure the trailer is level for accurate measurement.*

## Hitching

Your **Camp-Inn**<sup>TM</sup> trailer has a 2" ball type hitch. First, make sure that the hitch ball size on your towing vehicle matches the hitch size on your **Camp-Inn**<sup>TM</sup> trailer. Then proceed as follows:

1. Remove the safety-locking pin or lock from the locking lever.
2. Make sure the locking lever on the trailer tongue is in the unlocked or upright position (straight up and down).
3. By cranking the jack handle, raise the tongue so it clears the ball on the tow vehicle.
4. Move the vehicle or trailer to align the tongue with the ball.
5. By cranking the jack handle, use the jack to lower the trailer hitch onto the ball.
6. Make sure the tongue lowers **fully** onto the ball hitch. When fully lowered, there should be about a 1" space between the tongue and the hitch.
7. Lower the locking lever **fully** (it will be horizontal) and install safety-locking pin or lock. (*Note: there is a nut on the underside of the tongue that adjusts the fit of the ball-locking mechanism.*)
8. Crank jack handle until wheel clears the ground by 2-3 inches.

9. Pulling jack lock pin, rotate jack to horizontal position for traveling. (**Caution: Do Not rotate the jack until you locked the trailer tongue onto the ball hitch.**)
10. Hook up safety chains. Chains should be crossed. The chain on the left side of the trailer tongue should be hooked to the loop on the right side of the hitch and the chain on the right side of the trailer tongue should be hooked to the loop on left side of the hitch. (*this prevents the chains from binding when going around corners and will catch the hitch if it comes off the ball*) The safety chains should not be too loose or too tight. The correct amount will be determined by the tow vehicle's hitch design. Turning as tight a corner as possible, make sure that the chains do not bind. Also, make sure that the chains will not drag on the ground when the trailer and tow vehicle are fully loaded.
11. Connect 7-prong connector trailer lights to vehicle lights.
12. Turn on headlights and turn signals to check for proper operation of all trailer lights prior to towing, even during daylight hours.
13. Trailer lights should be checked periodically during your travels. As a minimum, they should be thoroughly checked daily, or every time you hitch up your trailer.

## Unhitching

1. Before unhitching your trailer, place chock blocks ahead and behind the trailer wheels to prevent the trailer from rolling.
2. Unhook trailer light connection.
3. Rotate jack to vertical position and make sure the jack locking pin is fully seated before cranking jack. Shake jack roughly to ensure it is locked.
4. Remove safety locking pin or lock from the hitch lock lever and raise the lever to the unlocked position (straight up and down).
5. By cranking the jack handle, jack up the trailer until it is clear of the ball hitch.
6. Lower the hitch lock lever to horizontal position.
7. Replace the safety locking pin or lock.
8. Unhook safety chains.
9. Move tow vehicle away from the trailer.
10. Jack trailer tongue either up or down to level the trailer.

## Using Trailer Brakes

In order for the trailer brakes to function, the tow vehicle will need a brake controller installed. When the brakes are applied in the tow vehicle, the brake controller applies a voltage to the electric trailer brakes to activate them. The trailer brakes are applied proportional to the tow vehicle brakes.

The brake controller should have an adjustment for the braking strength and a slide lever for manually applying the trailer brakes.

When the brakes are new, they need to be “broke in.” Start by setting your brake controller on the highest possible setting. As the trailer brakes “break in” you will feel them assisting more with the braking. If the brakes start to skid or lock-up, turn down the strength adjustment. If your trailer is loaded, and you are on dry pavement, you may be able to leave the brakes on the highest setting all of the time.

On gravel, wet pavement, ice or snow it is recommended that you turn down the brake strength. **Any time you need to reduce the braking strength, it is advised that you slow down your traveling speed.**

To properly set the brakes:

1. Find a straight section of road, clear of other traffic.
2. Slow down to a safe speed, (less than 20 mph. Slower on ice).
3. Adjust the brakes to a low setting (2-3).
4. Apply the brakes hard.
5. If the trailer brakes do not lock-up or skid, turn up the brakes.
6. When the brakes DO lock-up or skid, turn the brakes down.
7. The best brake setting is just below where they start to skid.
8. You will have to readjust the brakes as road conditions change.

Check the functioning of the trailer brakes periodically, especially if it has been stored for an extended period.

To check the brake function:

1. Turn the braking strength up to the highest setting.
2. Drive at about 20 mph. Put the car in neutral and coast.
3. Apply the trailer brakes using the manual override on the brake controller. You should feel the brakes slow you down.
4. If you don't feel the brakes pull, they may need cleaning. To clean the brakes, drive at 20 mph and pulse the trailer brakes ON for 20 seconds, OFF for 5 seconds until you feel them starting to pull. (usually less than ¼ mile)
5. Repeat Steps 2&3. If they still aren't pulling, inspect the brakes.



## Speed, Acceleration and Braking

**For safety, when towing a trailer, we recommend that you drive 5-10 MPH slower.**

**Fuel Economy** -The optimal speed for fuel economy varies from one tow vehicle to another. Typically, at 55-65mph, fuel economy will be affected about one gallon of fuel per hundred miles of travel. Higher speeds will typically decrease mileage more dramatically.

**Acceleration** - When towing a trailer, you must always keep in mind that you are adding load to your tow vehicle. Allow for slower acceleration when pulling out into traffic.

**Braking** - Braking distances are greater when towing; so leave a longer distance between you and the car ahead of you. If you regularly travel in heavy traffic, have a smaller tow vehicle, or drive in mountains, you should consider having electric trailer brakes installed. Trailer brakes are required in some states.





**Downgrades** - If signs warn you there is a long, steep downgrade ahead, slow down and shift into a lower gear. The engine will do the majority of the braking for you. If you are in a low enough gear, you will only need to

intermittently use your brakes. The steeper the downgrade, the lower the gear and the slower you should go.

On long downgrades, stop periodically to allow your brakes to cool before continuing. If you experience hard brakes or brake fade, stop immediately and allow brakes to cool fully before continuing.

**Upgrades** – When traveling uphill, your tow vehicle’s transmission may downshift and then upshift again. If the transmission repeatedly shifts, try manually downshifting into the lower gear and staying in that gear for the duration of the climb.

**Upgrades and Downgrades** - Watch the tachometer to make sure you do not over-rev the engine. When towing, to ease the load on the engine and transmission, it is recommended that you do not exceed 2/3’s of the red-line speed for extended periods. (*example: if your engine red-lines at 6,000rpm, keep the engine speed at or below 4,000rpm*) Following this guideline will also give you reserve power for maneuvering in emergency situations.

**Overdrive**  or  . Overdrive is usually marked on the shifter by a "D" with an "O" or square around it. Overdrive is intended to increase gas mileage but, on many cars, it is not durable enough for the added load of towing a trailer. SUVs and small trucks may be able to tow in overdrive. Check with your car dealer or look in your car's *owner's manual* to see what gear the manufacturer recommends for trailer towing.

Driving in drive (plain "D") or 3<sup>rd</sup> gear will not hurt the engine or transmission. It will, however, decrease gas mileage slightly, and cause the engine to rev higher at highway speeds.

**Backing** - To fully enjoy your **Camp-Inn**<sup>TM</sup> trailer, you must master backing your trailer. Backing a trailer takes a lot of practice and patience. You may want to practice backing in a large open area, like a parking lot. Practice backing into a parking spot, away from other vehicles.

One trick is to put one hand at the bottom of the steering wheel. Push that hand in the direction you want the trailer to go. When the trailer starts turning, turn the tow vehicle so it follows the trailer. If the trailer begins to jackknife (turns too sharply), pull forward and try backing again.

When backing, it is helpful to have a second person watch behind the trailer to make sure that you will not hit any obstacles. It is important that the second person remain in view of the driver at all times. Develop a system of hand signals to aid in directing.

For the person directing, keep in mind: If you can't see the driver's eyes, (*in the mirror*) they probably can't see you. At night, make sure you are illuminated so the driver can see you. If necessary, hold a flashlight so it shines on you or at least illuminate your signal hand.

Until you become experienced at backing, choose parking areas that you can pull-through.

If the ground is smooth and level, you can unhitch the trailer and roll it backward by hand. ***Never attempt this on a sloped surface, you may lose control of the trailer causing bodily injury or causing damage to property.***

## Tires

- Check the tire inflation to make sure it is within the recommended range.
- Check the tow vehicle owner's manual for the tow vehicle's correct tire inflation for trailering.
- If you are hauling heavy loads, check the load rating of the tires to make sure you do not exceed the load limits.
- Inspect the tires for any signs of damage, weathering or tread wear beyond the allowable limits.
- Lug nut Torque 95-105 ft-lb
- Lug bolt pattern – 5 x 4.5" (small Ford)
- Check your VIN tag for recommended tire size.
- Inflation Pressure 28-32 psi.
- If you have a spare tire, make sure it is properly inflated and in good condition. Spare tire inflation pressure 65-80psi.

## Spare Tire,

The **Camp-Inn**<sup>TM</sup> spare tire is rated for a loaded trailer at highway speeds. Being smaller diameter, it will cause that side of the trailer to ride lower. You may use it to drive for extended distances, but it is recommended that you repair or replace the original tire as soon as practical so you will have a spare tire available.

The **Camp-Inn**<sup>TM</sup> provided spare tire meets the following specifications:

5.30 –12

High Speed

Load Range C

4 ply

1045 lb load @ 60psi

If you replace the spare or buy your own, it is recommended that you purchase an equivalent tire.

The spare tire stows in the curb side of the in-floor storage. It should be checked periodically to ensure that it remains at the correct inflation pressure.

ALWAYS pull the trailer entirely off of the roadway before changing a flat tire

<b>Specifications</b>	500/550 Models	500/550 SUV	560 Models	560 SUV
Body Length	8'	8'	10'	10'
Total Length	11' 11"	11' 11"	13' 11"	13' 11"
Body Width	5'	5'	5'	5'
Width Fenders	6' 6"	6' 6"	6' 6"	6' 6"
Height	61"	64"	61"	64"
Interior Cabin Height	3' 8"	3' 8"	3' 8"	3' 8"
Bed Size	58" x 78"	58" x 78"	58" x 78"	58" x 78"
Weight Approx.*	850-1100 lb	900-1150 lb.	1000-1300 lb	1050-1350 lb.
Ride Height**	11"	14"	11"	14"
Tire Pressure	28-32psi	28-32psi	28-32psi	28-32psi
* Weight varies depending on options.				
** Measured from ground to body side. Ground clearance is about 4" less.				

<b>Electrical Troubleshooting:</b>	
<b>Problem:</b>	<b>Solution:</b>
Interior lights are dim.	Adjust dimmer Recharge battery.
All lights won't light.	Turn on DC Power Disconnect Switch Recharge battery. Check fuses.
One light won't light.	<i>"Ultra" xenon lights-</i> Check BOTH dimmer switch AND red/white toggle switch. Check bulb... Replace. Faulty switch/fixture... Replace.
Water pump doesn't work	See <b>sink</b> section
No power at 110V AC outlets.	Is trailer plugged in to power? Press reset on GFI outlet. Reset AC Breaker. (near GFI outlet)
No power at DC outlets.	Turn on DC Power Disconnect Switch Recharge battery. Check fuses.
TV/DVD Player will not turn on	Turn on TV Power Switch Check batteries in remote or use button on TV Check Fuses
Furnace won't heat.	Turn thermostat Off then On. Is propane tank filled? Valve On? Recharge battery. Check fuse.
Battery won't charge.	See <b>Charging Troubleshooting</b> flow chart.

## CHARGER TROUBLESHOOTING FLOW CHART

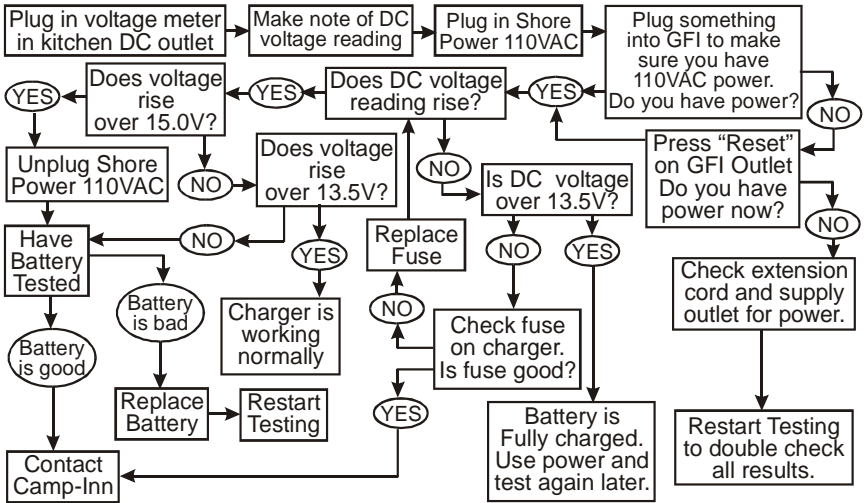

MAINTENANCE SCHEDULE <i>(long trip – over 4,000 miles)</i>	<b>Before Each Trip</b>	<b>Start of Season</b>	<b>Before Long Trip</b>	<b>Mileage</b>
Check trailer lights	X	X	X	
Check cabin & kitchen lights	X	X	X	
Drain – Flush – Fill freshwater tank	X	X	X	
Test water pump	X	X	X	
Check tire pressure	X	X	X	
Check charging voltage	X	X	X	
Lubricate locks & hinges		X	X	
Lubricate hitch jack and leveling jacks		X		
Test / Adjust brakes		X	X	4,000
Adjust parking brake handle		X	X	1,000
Inspect brakes <i>(remove drum)</i> <i>(repack wheel bearings at same time)</i>				2 years 12,000
Check wheel bearings		X	X	2,000
Repack wheel bearings <i>(w/o brakes)</i>				50,000
Check tire tread wear		X	X	
Sterilize freshwater tank		X	X	
Load test battery <i>(at auto parts store)</i>			X	2 years
Clean air conditioner filter and drain		X		

## Teardropping Tips

We are sure you will enjoy using your **Camp-Inn™** teardrop and will find ways of making your travel experiences more enjoyable. Here are a few tricks that we have found to get you started.

1. To determine what is necessary to take with you, put a piece of masking tape on every item. When you use each item, remove the tape. After a few trips consider leaving home any item that still has the tape on it.
2. Bedding:
  - ✓ A twin size comforter and/or blanket will fit well. Anything larger tends to be too bulky to tuck in.
  - ✓ Using a queen size fitted sheet and a full size flat sheet works well. The full size flat sheet allows about a 10" overhang on both sides of the bed, which can easily be tucked in. If you choose to use a queen size flat sheet instead, there will be about a 15" overhang on both sides of the bed.
  - ✓ **On all models**, an easy way to make the bed and keep the sheets in place is to sew the bottom of the flat sheet to the bottom of the fitted one. This is done just like waterbed sheets. Line up the centers of the bottom ends of the fitted and flat sheets. Then pin them together and machine stitch the two sheets together, sewing **only between** the two elastic corners of the fitted sheet. If you sew onto the elastic corners of the fitted sheet, you will tear both the stitches and sheets when you try to put them on the mattress.
3. Trick for making the bed: Lay the fitted sheet on top of the mattress in the correct orientation. With one person on each side of the trailer, fold the top three feet of mattress. Then slide the mattress toward the front of the trailer. Now you can reach the foot end of the mattress to install the fitted sheet. Slide the mattress back into place and continue making the bed.
4. For your cooler, try wrapping a towel from the top, around the back and underneath when you put it into the storage area on the countertop. You can pull on the bottom of the towel, to assist sliding the cooler out. It will also add insulation and reduce scuffing of the stainless countertop.
5. The in-floor storage is a good place for items that you need, but not very often, like rain gear, cold weather gear, road flares, reserve bottled drinking water, spare 11b. propane tank, etc... It is nice to have these items, "just in case."

6. Placing pieces of cloth between pots and pans will reduce scuffing and scratching of your cookware.
7. Make a clothesline that stretches between the coat hooks in the cabin. Open the side windows slightly, and you can dry towels etc... as you drive. Use a small rope with a loop tied on each end.
8. In cooler weather, you will get condensation on the windows. Roll up a small towel and place it between the curtains and the windows. This will absorb excess condensation that might otherwise drip onto you at night. Opening side windows, sunroof or roof vents slightly will help reduce condensation.
9. Weight Distribution:

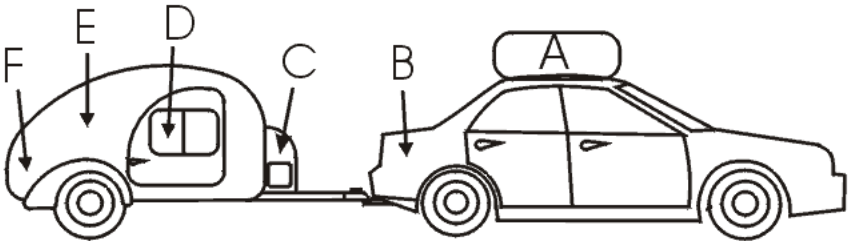

Using the picture above, imagine you were hauling a **50 lb. load**. The following table shows approximately how much effect that 50 lb. load would have on different points on the car and trailer.

**Weight Added or (-xx)Removed**

	<b>Load Location</b>	<b>Trailer Axle</b>	<b>Hitch / Tongue</b>	<b>Car Rear Axle</b>	<b>Car Front Axle</b>
<b>A</b>	Roof top carrier	0 lbs.	0 lbs.	30 lbs.	20 lbs.
<b>B</b>	Car trunk	0 lbs.	0 lbs.	50 lbs.	0 lbs.
<b>C</b>	Front storage	17 lbs.	33 lbs.	44 lbs.	(-11) lbs.
<b>D</b>	Cabin area	33 lbs.	17 lbs.	22 lbs.	(-5) lbs.
<b>E</b>	Cooler area or Footwell (above axle)	50 lbs.	0 lbs.	0 lbs.	0 lbs.
<b>F</b>	Under counter storage	62 lbs.	(-12) lbs.	(-16) lbs.	4 lbs.

As you can see, where you add the weight can affect the ride of the car and trailer. Since a **Camp-Inn™** trailer is rated for 500-1000 lbs. of cargo carrying, you should use it to haul all your heavy gear. The best place to haul heavy items is to slide them into the footwell area of the bed (inside the cabin). As you can see from the table above, it will not affect the tongue weight or load the rear axle of the car. Putting heavy items in the under countertop storage area will actually take off tongue weight.

# CAMP-INN ELECTRICAL SCHEMATIC WITH BATTERY ISOLATOR (NOT ALL ITEMS ARE ON ALL TRAILERS)

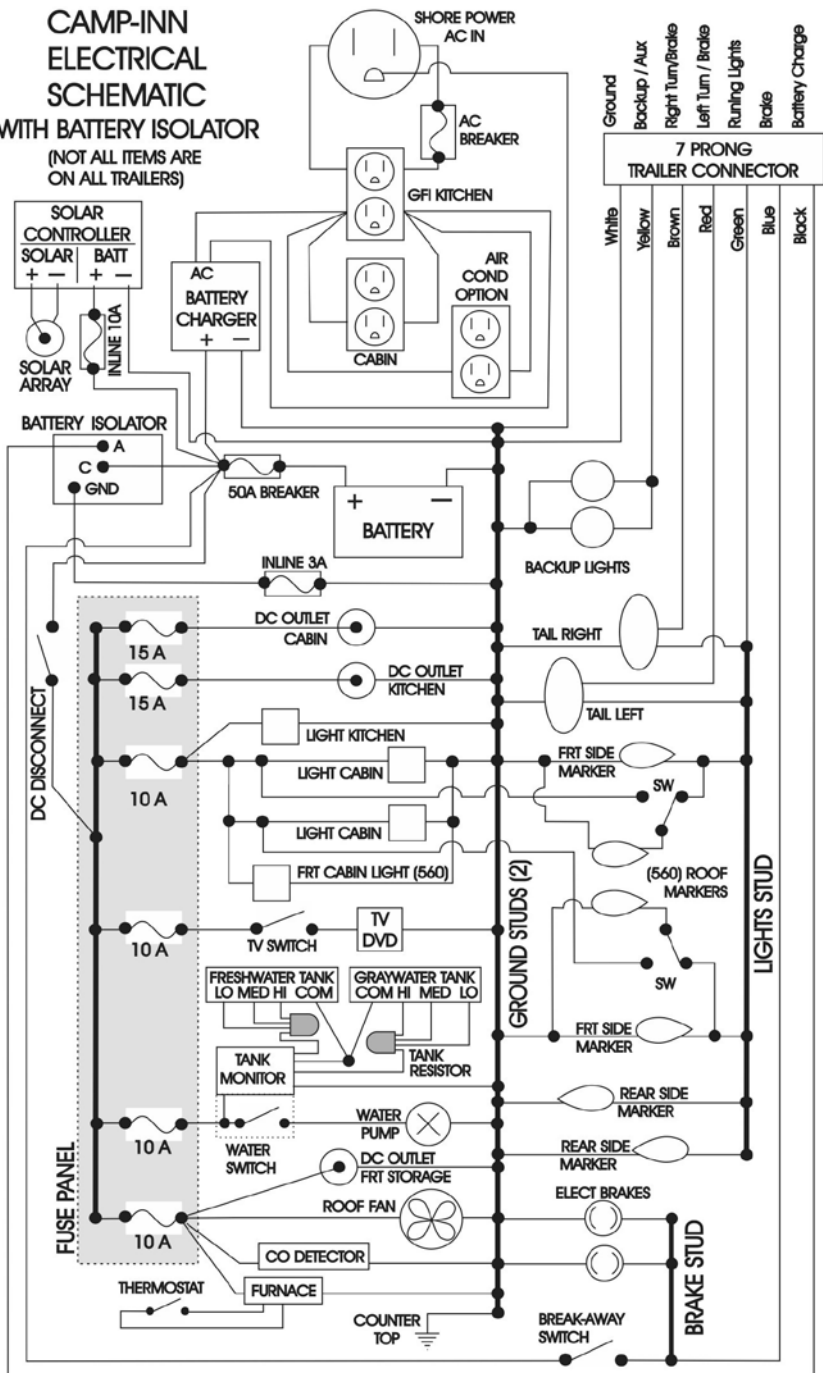



# CAMP-INN ELECTRICAL SCHEMATIC

WITHOUT BATTERY ISOLATOR  
(NOT ALL ITEMS ARE ON ALL TRAILERS)

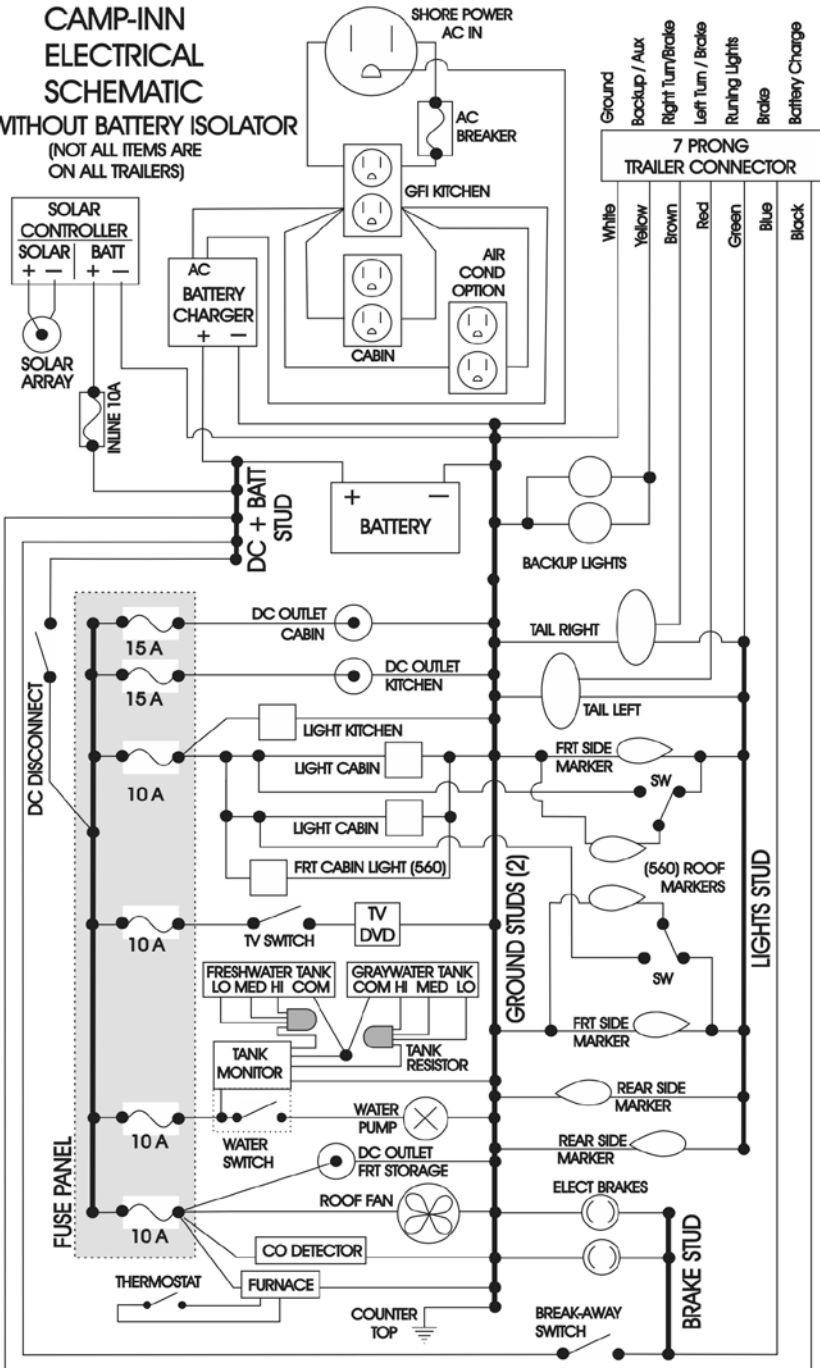

# INDEX

- 110/120V AC .....*See* power AC 110V
- 7-prong ..... *See* connector
- AC fuse/breaker .....20, 44
- AC power 110V .....20, 21, 44
- air conditioner .....20, 26, 30
- Alcan cover .....22
- aluminum, cleaning .....31
- antenna ..... *See* TV/DVD
- antifreeze ..... *See* winterize
- backing, trailer .....42
- ball hitch .....2, 37, 38
- battery .....30
  - charger .....21
  - charging .....20, 21, 36
  - disconnect switch .....21, 36
  - isolator .....22
  - meter .....11, 21
  - replacement .....22
- battery isolator .....19
- beach use .....*See* cleaning
- bearings ..... *See* wheel bearings
- bedding .....46
- bike rack ..... *See* receiver
- brake fade .....41
- brakes
  - adjustment, electric .....33
  - adjustment, parking .....34
  - controller .....40
  - inspection .....34
  - maintenance .....33
  - parking .....5, 34
  - using, trailer .....40, 41
- breaker, 110VAC .....20
- bulbs, replace .....18
- bunk bed .....28
- charger ..... *See* battery, charger
- charger, fuse .....19
- chock blocks .....5, 17
- city water hookup .....13
- cleaning .....31
  - aluminum .....31
  - countertops/backsplash .....32
  - curtains .....32
  - exterior .....31
  - fenders .....31
  - interior .....31
  - wheels and bumper .....32
  - windows .....32
  - winter use .....31
- condensation .....32
- connector, 7-prong .... 17, 21, 22, 39
- cooler stand .....8
- couch .....28
- counter lids .....11
- curtain end clips .....32
- de-winterize ..... *See* water, de-winterize
- disconnect, switch .....21, 36
- door screens .....26
- downgrades .....41
- electrical schematic .....48
- fan ..... *See* roof fan
- fenders, cleaning .....31
- fire extinguisher .....2, 4, 8
- flat tire ..... *See* tire, flat
- freezing ..... *See* winterize
- front storage box .....17
- furnace .....25
- fuse, charger .....19
- fuses .....19
- gear, overdrive .....41
- gear, shifting .....41
- gray water tank .....13
- halogen ..... *See* lights

hatch.....	7, 30	stove .....	9
prop rod.....	7	tank .....	2, 10, 15, 25
hitch height.....	37	rain sensor.....	27
hitch rating .....	37	Raindrop .....	28
hitching .....	38	receiver hitch .....	24
inspection .....	30	roof fan.....	27
isolator..... <i>See</i> battery, isolator		roof rack.....	24
jack		roof vent.....	27
hitch .....	2, 5, 39	safety.....	2
leveling .....	5	safety chains.....	39
kitchen.....	7	schedule, maintenance .....	45
leaks .....	32	schematic, electrical.....	48
leveling..... <i>See</i> jack, leveling		screens, door .....	26
lights.....	18	serial number .....	4
connector .....	<i>See</i> connector	setting up.....	5
replace bulbs .....	18	seven-prong connector .....	<i>See</i>
side marker .....	18	connector	
tail .....	18	sewer.....	14
locks .....	6, 24	shift .....	41
LP..... <i>See</i> propane		shore power.....	20, 21
lubricate		sink.....	11, 30
leveling jack.....	45	sink trap .....	12
leveling jacks .....	35	solar controller .....	19, 20
locks.....	6, 45	specifications .....	44
tongue jack.....	35, 45	storage box, front.....	17, 22
wheel bearings .....	33, 45	storage of trailer.....	36
maintenance .....	30, 45	stove.....	2, 9, 15
marker lights .....	18	sun roof .....	23
packing.....	4	switch	
parking brake .... <i>See</i> brakes, park		DC disconnect .....	
power, AC 110V .....	20	TV/DVD player.....	16
power, disconnect switch.....	21, 36	water pump .....	12
power, shore.... <i>See</i> shore power		switching ON water .....	12
prop rod..... <i>See</i> hatch, prop rod		table.....	8
propane		tail lights .....	18
accessory outlet.....	15	thermostat	
check fill level .....	10	roof fan .....	27
furnace .....	25	thermostat, furnace .....	25
leak .....	2, 25	tips, teardropping .....	4, 5, 46
quick connect.....	15		
refilling .....	10		

tire	
flat.....	2, 43
inspection.....	30, 43
pressure.....	43
spare.....	43
tongue weight.....	37, 38
torque, lug nut.....	43
towing basics.....	37
towing capacity.....	37
trap.....	<i>See</i> sink trap
troubleshooting	
charging.....	45
electrical.....	44
water system.....	12
TV/DVD	
antenna jack.....	16
ejecting disc.....	16
power switch.....	16
TV/DVD player.....	16
unhitching.....	39
vent.....	<i>See</i> roof fan
ventilation.....	2
VIN tag.....	4
volt meter.....	21
washing.....	<i>See</i> cleaning
water	
city hookup.....	13
de-winterize.....	14
hard.....	15
outlet valve.....	13
tank meter.....	11
troubleshooting.....	12
winterize.....	14
water pump.....	11, 12
water pump switch.....	12
water tank, fresh.....	11
draining.....	13, 36
filling.....	11
sanitizing.....	14
water tank, gray.....	13
cleaning.....	14
draining.....	14, 36
weight distribution.....	47
weight, total.....	37
wheel bearings.....	33
windcreens.....	16
winterizing.....	14, 36
wiring, 7-prong.....	17
xenon.....	<i>See</i> lights