

Series 2600A System SourceMeter®

User's Manual

2600AS-900-01 Rev. B / September 2008

WARRANTY

Keithley Instruments, Inc. warrants this product to be free from defects in material and workmanship for a period of one (1) year from date of shipment.

Keithley Instruments, Inc. warrants the following items for 90 days from the date of shipment: probes, cables, software, rechargeable batteries, diskettes, and documentation.

During the warranty period, Keithley Instruments will, at its option, either repair or replace any product that proves to be defective.

To exercise this warranty, write or call your local Keithley Instruments representative, or contact Keithley Instruments headquarters in Cleveland, Ohio. You will be given prompt assistance and return instructions. Send the product, transportation prepaid, to the indicated service facility. Repairs will be made and the product returned, transportation prepaid. Repaired or replaced products are warranted for the balance of the original warranty period, or at least 90 days.

LIMITATION OF WARRANTY

This warranty does not apply to defects resulting from product modification without Keithley Instruments' express written consent, or misuse of any product or part. This warranty also does not apply to fuses, software, non-rechargeable batteries, damage from battery leakage, or problems arising from normal wear or failure to follow instructions.

THIS WARRANTY IS IN LIEU OF ALL OTHER WARRANTIES, EXPRESSED OR IMPLIED, INCLUDING ANY IMPLIED WARRANTY OF MERCHANTABILITY OR FITNESS FOR A PARTICULAR USE. THE REMEDIES PROVIDED HEREIN ARE BUYER'S SOLE AND EXCLUSIVE REMEDIES.

NEITHER KEITHLEY INSTRUMENTS, INC. NOR ANY OF ITS EMPLOYEES SHALL BE LIABLE FOR ANY DIRECT, INDIRECT, SPECIAL, INCIDENTAL, OR CONSEQUENTIAL DAMAGES ARISING OUT OF THE USE OF ITS INSTRUMENTS AND SOFTWARE, EVEN IF KEITHLEY INSTRUMENTS, INC. HAS BEEN ADVISED IN ADVANCE OF THE POSSIBILITY OF SUCH DAMAGES. SUCH EXCLUDED DAMAGES SHALL INCLUDE, BUT ARE NOT LIMITED TO: COST OF REMOVAL AND INSTALLATION, LOSSES SUSTAINED AS THE RESULT OF INJURY TO ANY PERSON, OR DAMAGE TO PROPERTY.

KEITHLEY

A G R E A T E R M E A S U R E O F C O N F I D E N C E

Keithley Instruments, Inc.

Corporate Headquarters • 28775 Aurora Road • Cleveland, Ohio 44139
440-248-0400 • Fax: 440-248-6168 • 1-888-KEITHLEY (1-888-534-8453) • www.keithley.com

Series 2600A
System SourceMeter[®] Instruments
User's Manual

©2008, Keithley Instruments, Inc.

All rights reserved.

Any unauthorized reproduction, photocopy, or use the information herein, in whole or in part without the prior written approval of Keithley Instruments, Inc. is strictly prohibited.

TSP, TSP-Link, and TSP-Net are trademarks of Keithley Instruments, Inc.

All Keithley Instruments product names are trademarks or registered trademarks of Keithley Instruments, Inc.

Other brand names are trademarks or registered trademarks of their respective holders

Cleveland, Ohio, U.S.A.

Document Number:

2600AS-900-01 Rev. B / September 2008

The following safety precautions should be observed before using this product and any associated instrumentation. Although some instruments and accessories would normally be used with non-hazardous voltages, there are situations where hazardous conditions may be present.

This product is intended for use by qualified personnel who recognize shock hazards and are familiar with the safety precautions required to avoid possible injury. Read and follow all installation, operation, and maintenance information carefully before using the product. Refer to the user documentation for complete product specifications.

If the product is used in a manner not specified, the protection provided by the product warranty may be impaired.

The types of product users are:

Responsible body is the individual or group responsible for the use and maintenance of equipment, for ensuring that the equipment is operated within its specifications and operating limits, and for ensuring that operators are adequately trained.

Operators use the product for its intended function. They must be trained in electrical safety procedures and proper use of the instrument. They must be protected from electric shock and contact with hazardous live circuits.

Maintenance personnel perform routine procedures on the product to keep it operating properly, for example, setting the line voltage or replacing consumable materials. Maintenance procedures are described in the user documentation. The procedures explicitly state if the operator may perform them. Otherwise, they should be performed only by service personnel.

Service personnel are trained to work on live circuits, perform safe installations, and repair products. Only properly trained service personnel may perform installation and service procedures.

Keithley Instruments products are designed for use with electrical signals that are rated Measurement Category I and Measurement Category II, as described in the International Electrotechnical Commission (IEC) Standard IEC 60664. Most measurement, control, and data I/O signals are Measurement Category I and must not be directly connected to mains voltage or to voltage sources with high transient over-voltages. Measurement Category II connections require protection for high transient over-voltages often associated with local AC mains connections. Assume all measurement, control, and data I/O connections are for connection to Category I sources unless otherwise marked or described in the user documentation.

Exercise extreme caution when a shock hazard is present. Lethal voltage may be present on cable connector jacks or test fixtures. The American National Standards Institute (ANSI) states that a shock hazard exists when voltage levels greater than 30V RMS, 42.4V peak, or 60V DC are present. A good safety practice is to expect that hazardous voltage is present in any unknown circuit before measuring.

Operators of this product must be protected from electric shock at all times. The responsible body must ensure that operators are prevented access and/or insulated from every connection point. In some cases, connections must be exposed to potential human contact. Product operators in these circumstances must be trained to protect themselves from the risk of electric shock. If the circuit is capable of operating at or above 1000V, no conductive part of the circuit may be exposed.

Do not connect switching cards directly to unlimited power circuits. They are intended to be used with impedance-limited sources. NEVER connect switching cards directly to AC mains. When connecting sources to switching cards, install protective devices to limit fault current and voltage to the card.

Before operating an instrument, ensure that the line cord is connected to a properly-grounded power receptacle. Inspect the connecting cables, test leads, and jumpers for possible wear, cracks, or breaks before each use.

When installing equipment where access to the main power cord is restricted, such as rack mounting, a separate main input power disconnect device must be provided in close proximity to the equipment and within easy reach of the operator.

For maximum safety, do not touch the product, test cables, or any other instruments while power is applied to the circuit under test. ALWAYS remove power from the entire test system and discharge any capacitors before: connecting or disconnecting cables or jumpers, installing or removing switching cards, or making internal changes, such as installing or removing jumpers.

Do not touch any object that could provide a current path to the common side of the circuit under test or power line (earth) ground. Always make measurements with dry hands while standing on a dry, insulated surface capable of withstanding the voltage being measured.

The instrument and accessories must be used in accordance with its specifications and operating instructions, or the safety of the equipment may be impaired.

Do not exceed the maximum signal levels of the instruments and accessories, as defined in the specifications and operating information, and as shown on the instrument or test fixture panels, or switching card.

When fuses are used in a product, replace with the same type and rating for continued protection against fire hazard.

Chassis connections must only be used as shield connections for measuring circuits, NOT as safety earth ground connections.

If you are using a test fixture, keep the lid closed while power is applied to the device under test. Safe operation requires the use of a lid interlock.

If a  screw is present, connect it to safety earth ground using the wire recommended in the user documentation.

The  symbol on an instrument indicates that the user should refer to the operating instructions located in the user documentation.

The  symbol on an instrument shows that it can source or measure 1000V or more, including the combined effect of normal and common mode voltages. Use standard safety precautions to avoid personal contact with these voltages.

The  symbol on an instrument shows that the surface may be hot. Avoid personal contact to prevent burns.

The  symbol indicates a connection terminal to the equipment frame.

If this  symbol is on a product, it indicates that mercury is present in the display lamp. Please note that the lamp must be properly disposed of according to federal, state, and local laws.

The **WARNING** heading in the user documentation explains dangers that might result in personal injury or death. Always read the associated information very carefully before performing the indicated procedure.

The **CAUTION** heading in the user documentation explains hazards that could damage the instrument. Such damage may invalidate the warranty.

Instrumentation and accessories shall not be connected to humans.

Before performing any maintenance, disconnect the line cord and all test cables.

To maintain protection from electric shock and fire, replacement components in mains circuits - including the power transformer, test leads, and input jacks - must be purchased from Keithley Instruments. Standard fuses with applicable national safety approvals may be used if the rating and type are the same. Other components that are not safety-related may be purchased from other suppliers as long as they are equivalent to the original component (note that selected parts should be purchased only through Keithley Instruments to maintain accuracy and functionality of the product). If you are unsure about the applicability of a replacement component, call a Keithley Instruments office for information.

To clean an instrument, use a damp cloth or mild, water-based cleaner. Clean the exterior of the instrument only. Do not apply cleaner directly to the instrument or allow liquids to enter or spill on the instrument. Products that consist of a circuit board with no case or chassis (for example, a data acquisition board for installation into a computer) should never require cleaning if handled according to instructions. If the board becomes contaminated and operation is affected, the board should be returned to the factory for proper cleaning/servicing.

Table of Contents

Section	Topic	Page
1	Front and Rear Panel Operation	1-1
	Front and rear panel familiarization	1-2
	Front panel summaries.....	1-2
	Rear panel summaries	1-2
	Model 2601A/2602A and Model 2611A/2612A rear panels	1-5
	Model 2635A/2636A rear panels.....	1-7
	What are the source-measure capabilities?	1-9
	Model 2601A and Model 2602A.....	1-9
	Model 2611A and Model 2612A	1-9
	Model 2635A and Model 2636A.....	1-9
	How do I power-up the instrument?.....	1-10
	How do I make measurements?	1-11
	How do I use the reading buffer?.....	1-15
2	Remote Operation	2-1
	How do I use the remote interface?.....	2-2
	Connect to the interface	2-2
	Configure the interface.....	2-2
	Working with the web interface.....	2-8
	How to use the Virtual Front Panel.....	2-9
	TSP Express.....	2-9
	TSB embedded.....	2-9
	Issuing ICL commands.....	2-10
	How do I use Test Script Builder?.....	2-11
	How do I use TSB to make measurements?	2-14
	How do I use other programs?	2-17
	Using LabVIEW.....	2-17
	Using Visual Basic.....	2-19
3	Test Script Processor Interaction	3-1
	What is a script?	3-2
	Factory scripts.....	3-2
	User scripts	3-2
	How do I run a script from the front panel?.....	3-2
	How do I save scripts to the USB flash drive?.....	3-3
	How do I interact with scripts using Test Script Builder?	3-4
	Running a factory script	3-4
	Modifying a factory script	3-6
	Running the user script	3-11
	Deleting a user script and user tests	3-12
	How do I use other programs?	3-12
	Using LabVIEW.....	3-12
	Using Visual Basic.....	3-14
4	Controlling Multiple Series 2600As (TSP-Link)	4-1
	How do I set up the TSP-Link system?.....	4-2
	How do I use the expanded system?.....	4-3
	Accessing resources of TSP-Link nodes	4-3
	Running scripts in a TSP-Link system.....	4-4

Appendix	Topic	Page
A	Frequently Asked Questions	A-1
	How do I optimize performance?	A-2
	Setting speed.....	A-2
	Disabling auto zero to increase speed	A-2
	How do I upgrade the firmware?	A-2
	How do I use the Digital I/O port?	A-3
	Digital I/O port terminals	A-3
	Controlling the digital I/O port	A-3
	How do I trigger other instruments?	A-3
	Triggering a scanner	A-3
	Programming triggering	A-4
	How do I generate a service request?	A-4
	Setting up a service request	A-4
	Service request programming example	A-4
	Polling for SRQs	A-5
	How do I store measurements in nonvolatile memory?	A-5
	Front panel operation.....	A-5
	Remote programming	A-5
	How do I stack channels to output higher voltage?.....	A-6
	How do I parallel channels to output higher current?	A-7
	How do I make contact check measurements?	A-8
Contact check connections.....	A-8	
How do I make low-current measurements?.....	A-9	
Low-current connections	A-9	
Low-current measurement programming example	A-10	
	Index	Index-1

List of Figures

Section	Figure	Title	Page
1	Figure 1-1	Models 2601A, 2611A, 2602A, 2612A, 2635A, and 2636A front panels.....	1-2
1	Figure 1-2	Model 2601A/2602A/2611A/2612A rear panels.....	1-5
1	Figure 1-3	Model 2635A and 2636A rear panels	1-7
1	Figure 1-4	Model 2602A/2612A low-noise chassis ground banana jack and chassis screw	1-13
1	Figure 1-4	Model 2636A.....	1-13
1	Figure 1-5	Interlock circuit.....	1-14
1	Figure 1-6	Display modes	1-14
1	Figure 1-7	Buffer display format.....	1-17
2	Figure 2-1	GPIB cable.....	2-2
2	Figure 2-2	RS-232 cable	2-2
2	Figure 2-3	Computer configuration using the command prompt.....	2-4
2	Figure 2-4	Internet protocol (TCP/IP) properties dialog box	2-6
2	Figure 2-5	LAN connection	2-8
2	Figure 2-6	Web interface.....	2-9
2	Figure 2-7	Test Script Builder initial startup screen.....	2-12
2	Figure 2-8	Instrument console control icons	2-13
2	Figure 2-9	Select Instrument Resource dialog box	2-14
2	Figure 2-10	Source-measure command sequence in console window (2601A/2602A version shown).....	2-15
2	Figure 2-11	LabVIEW source-measure example block diagram.....	2-18
2	Figure 2-12	Visual Basic example user interface.....	2-19
2	Figure 2-13	Example program test results	2-21
3	Figure 3-1	Pulse-measure cycle for the <code>PulseVMeasureI</code> function	3-4
3	Figure 3-2	Importing a factory script project from the Series 2600A.....	3-7
3	Figure 3-3	KIGeneral project imported into the Test Script Builder	3-8
3	Figure 3-4	Run configuration example - Main tab shown.....	3-10
3	Figure 3-5	Run configuration example - Script Attributes tab shown	3-11
3	Figure 3-6	LabVIEW source step example	3-13
3	Figure 3-7	GUI after loading the non-function script (GPIB)	3-16
3	Figure 3-8	GUI after running the non-function script (GPIB).....	3-17
3	Figure 3-9	GUI after loading and running the function script (GPIB)	3-18
3	Figure 3-10	GUI after calling the function (GPIB)	3-19
4	Figure 4-1	TSP-Link connections.....	4-2
Appendix			
Appendix	Figure	Title	Page
A	Figure A-1	Digital I/O port terminals	A-3
A	Figure A-2	Triggering a scanner	A-4
A	Figure A-3	Stacking channels for higher voltage	A-7
A	Figure A-4	Connecting channels in parallel for higher current	A-8
A	Figure A-5	Model 2601A/2602A/2611A/2612A contact check connections ...	A-8
A	Figure A-6	Model 2635A/2636A contact check connections	A-9
A	Figure A-7	Model 2635A/2636A low-current connections	A-10

This page left blank intentionally.

List of Tables

Section	Table	Title	Page
1	Table 1-1	Connectors and triax cable conductors	1-7
1	Table 1-2	Triax connector on ground module	1-8
1	Table 1-3	Model 2601A and 2602A source-measure capabilities	1-9
1	Table 1-4	Model 2611A and 2612A source-measure capabilities.....	1-9
1	Table 1-5	Model 2635A and 2636A source-measure capabilities	1-9
Appendix	Table	Title	Page
A	Table A-1	Commands for basic I/O port.....	A-3

This page left blank intentionally.

Front and Rear Panel Operation

In this section:

Topic	Page
Front and rear panel familiarization	1-2
Front panel summaries	1-2
Rear panel summaries	1-2
Model 2601A/2602A and Model 2611A/2612A rear panels	1-5
Model 2635A/2636A rear panels	1-7
What are the source-measure capabilities?	1-9
What are the source-measure capabilities?	1-9
Model 2601A and Model 2602A	1-9
Model 2611A and Model 2612A	1-9
Model 2635A and Model 2636A	1-9
How do I power-up the instrument?	1-10
Connect to line power	1-10
Turn on power	1-10
Set line frequency	1-10
How do I make measurements?	1-11
Connect the DUT	1-11
Select source and set source level	1-11
Set compliance limit	1-11
Select measurement function and range	1-12
Turn output on	1-12
Make measurements	1-12
Turn output off	1-12
How do I use the reading buffer?	1-15
Connecting the device under test (DUT)	1-15
Set up source and measure functions	1-15
Configuring the reading buffer	1-15
Turn on the output	1-16
Storing reading buffers	1-16
Turn off the output	1-16
Recalling readings	1-16

Front and rear panel familiarization

Front panel summaries

The front panels of the Keithley Instruments Series 2600A System SourceMeter® instrument are shown in Figure 1-1. The descriptions of the front panel controls follow Figure 1-1.

Rear panel summaries

The rear panels of the Models 2601A/2602A and 2611A/2612A are shown in Figure 1-2. The rear panels of the Models 2635A and 2636A are shown in Figure 1-3. The descriptions of the rear panel components follow Figure 1-2 and Figure 1-3.

Figure 1-1
Models 2601A, 2611A, 2602A, 2612A, 2635A, and 2636A front panels

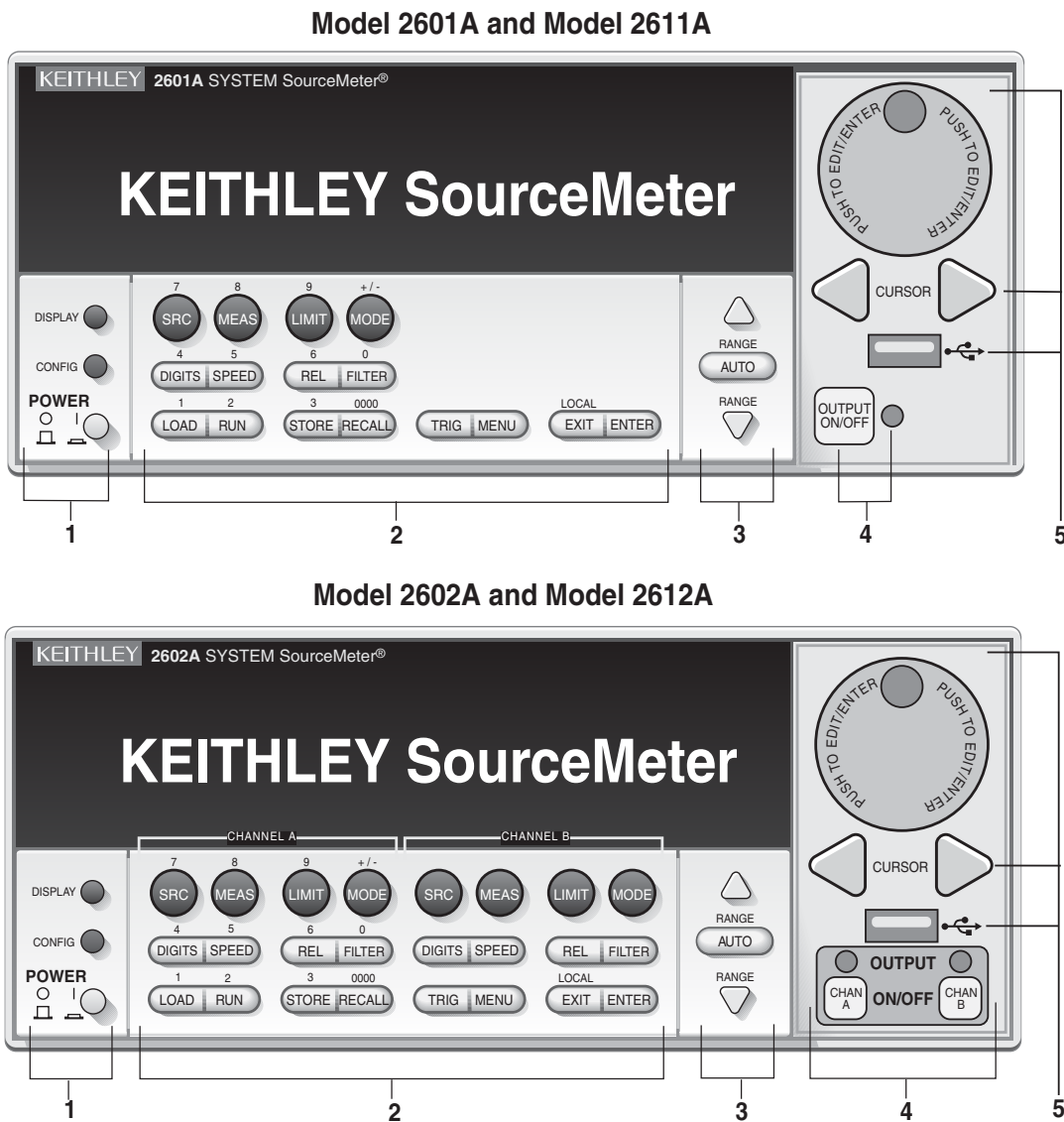

NOTE The Models 2601A, 2611A, and 2635A have one SourceMeter channel (Channel A) and the Models 2602A, 2612A, and 2636A have two SourceMeter channels (Channel A and Channel B).

1. Special keys and power switch:

DISPLAY	Toggles between the various source-measure is displayed and the user message mode. Selects Models 2602A/2612A/2636A single or dual-channel display.
CONFIG	Used to configure a function or operation.
POWER	Power switch: "In" position (I) turns SourceMeter on, "out" position (O) turns SourceMeter off (O).
Number keys	The number keys (0-9, +/-, 0000) allow direct numeric entry in the EDIT mode.

2. Source-measure setup, performance control, and special operation:

Top Row: Source-measure setup

Model 2601A/2611A/2635A and Model 2602A/2612A/2636A:

SRC	Channel A: Selects the source function (V or A) and places cursor in the source field for editing.
MEAS	Channel A: Cycles through measure functions (V, A, Ω or W).
LIMIT	Channel A: Places the cursor in the compliance limit field for editing.
MODE	Channel A: Directly chooses the measurement function (V, A, Ω or W).

Model 2602A/2612A/2636A only:

SRC	Channel B: Selects the source function (V or A) and places cursor in the source field.
MEAS	Channel B: Cycles through measure functions (V, A, Ω or W).
LIMIT	Channel B: Places the cursor in the compliance limit field for editing.
MODE	Channel B: Directly chooses the measurement function (V, A, Ω or W).

Middle Row: Source-measure setup

Model 2601A/2611A/2635A and Model 2602A/2612A/2636A:

DIGITS	Channel A: Changes display resolution to 4-1/2, 5-1/2, or 6-1/2 digits.
SPEED	Channel A: Sets the measurement speed by controlling the A/D converter measurement aperture.
REL	Channel A: Controls relative, which allows a baseline value to be subtracted from a reading.
FILTER	Channel A: Controls the digital filter, which can be used to reduce reading noise.

Model 2602A/2612A/2636A only:

DIGITS	Channel B: Changes display resolution to 4-1/2, 5-1/2, or 6-1/2 digits.
SPEED	Channel B: Sets the measurement speed by controlling the A/D converter measurement aperture.
REL	Channel B: Controls relative, which allows a baseline value to be subtracted from a reading.
FILTER	Channel B: Controls the digital filter, which can be used to reduce reading noise.

Bottom Row: Source-measure setup

LOAD	Loads factory or user-defined scripts for execution.
RUN	Runs last selected factory or user-defined scripts.
STORE	Stores readings, source values, and timestamp values in one of two internal buffers per channel for later recall.
RECALL	Recalls stored readings, source values, and timestamp values from either of the two buffers.
TRIG	Triggers readings.
MENU	Accesses the Main Menu for saving and recalling setups, selecting remote interface, line frequency, self-tests, serial number and beeper control.
EXIT	Cancels selection, and backs out of menu structure. Used as a LOCAL key to take the unit out of remote.
ENTER	Accepts selection, moves to next choice or exits menu.

3. Range keys:

Δ and ∇	Selects the next higher or lower source or measure range.
AUTO	Enables or disables source or measure auto range.

4. Output control and LED status indicator:

OUTPUT ON/OFF	Turns source output on or off.
LED indicator	Illuminated when output is on.

5. Navigation wheel, USB port, and CURSOR keys:

When in source edit, use the **CURSOR** keys for cursor control and then turn the **navigation wheel** to change a source or compliance value. The can also be used to enable or disable the source edit mode.

When in a menu, use the **CURSOR** keys or **navigation wheel** for menu item cursor control. When displaying a menu value, use the **CURSOR** keys for cursor control and turn the **navigation wheel** to change the value. Pressing the **navigation wheel** opens a menu item or selects a menu option or value.

Use the USB port to connect a USB flash drive. The USB flash drive stores reading buffer data, scripts, and user setup options.

6. Display indicators (not shown):

EDIT	Unit is in the source editing mode.
ERR	Questionable reading or invalid calibration step.
REM	Unit in remote mode.
TALK	Unit addressed to talk.
LSTN	Unit addressed to listen.
SRQ	Service request.
REL	Relative mode enabled.
FILT	Digital filter is enabled.
AUTO	Auto source or measure range selected.
ARM	Unit armed and ready to run.
*	(asterisk)Readings are being stored in buffer.

Figure 1-2
Model 2601A/2602A/2611A/2612A rear panels

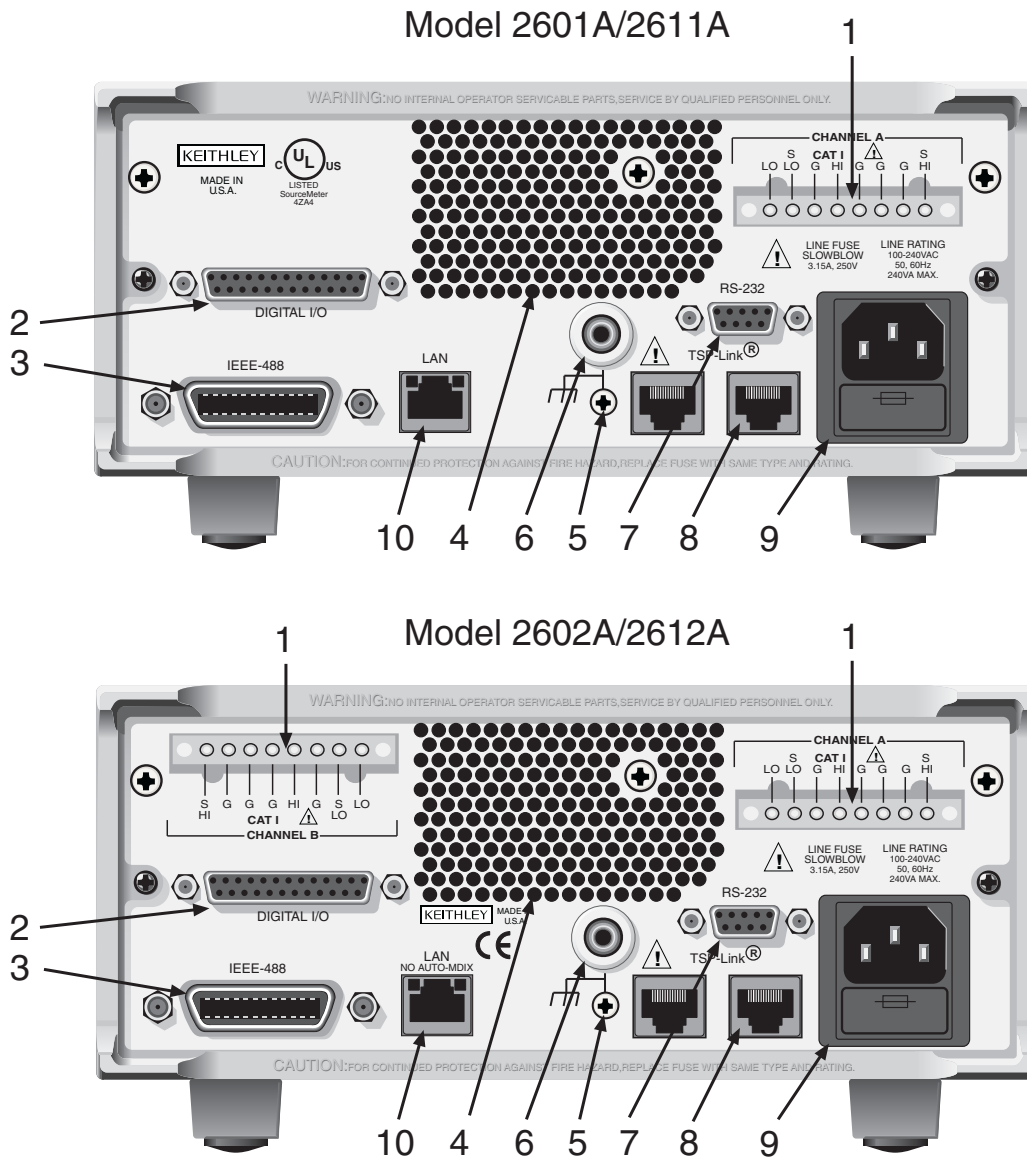

Model 2601A/2602A and Model 2611A/2612A rear panels

1. CHANNEL A and CHANNEL B (Channel B on Model 2602A/2612A only)

Input/output connections for source, sense, and guard.

2. DIGITAL I/O

Female DB-25 connector. Fourteen pins for digital input or output, one pin for output enable (2601A/2602A) or safety interlock (2611A/2612A); +5V and GND pins are also provided.

Use a cable equipped with a male DB-25 connector (Keithley Instruments part number CA-126-1CA).

3. IEEE-488

Connector for IEEE-488 (GPIB) operation. Use a shielded cable, such as the Keithley Instruments Model 7007-1 or Model 7007-2.

4. Cooling exhaust vent

Exhaust vent for internal cooling fan. Keep vent free of obstructions to prevent overheating.

5. Chassis ground

Ground screw for connections to chassis ground.

6. Low noise chassis ground

Ground jack for connecting Output HI or LO to chassis.

7. RS-232

Female DB-9 connector. For RS-232 operation, use a straight-through (not null modem) DB-9 shielded cable (Keithley Instruments Model 7009-5) for connection to a PC.

8. TSP-Link

Expansion interface that allows a Series 2600A and other TSP-enabled instruments to trigger and communicate with each other. Use a category 5e or higher LAN crossover cable (Keithley Instruments part number CA-180-3A).

9. Power module

Contains the AC line receptacle and power line fuse. The instrument can operate on line voltages of 100V to 240V AC at line frequencies of 50 Hz or 60 Hz. See the Series 2600A Reference Manual for line fuse replacement instructions.

10. LAN

Use this RJ-45 connector to connect the instrument to the local area network. The RJ-45 connector connects a network card, a network switch, a router or a hub. When connecting directly to a PC, a crossover cable (included) must be used. When connecting to a network switch, router, or hub, a normal CAT-5 cable (not provided) should be used unless your equipment has Auto-MDIX capabilities. If it does have Auto-MDIX, the crossover cables may be used.

Figure 1-3
Model 2635A and 2636A rear panels

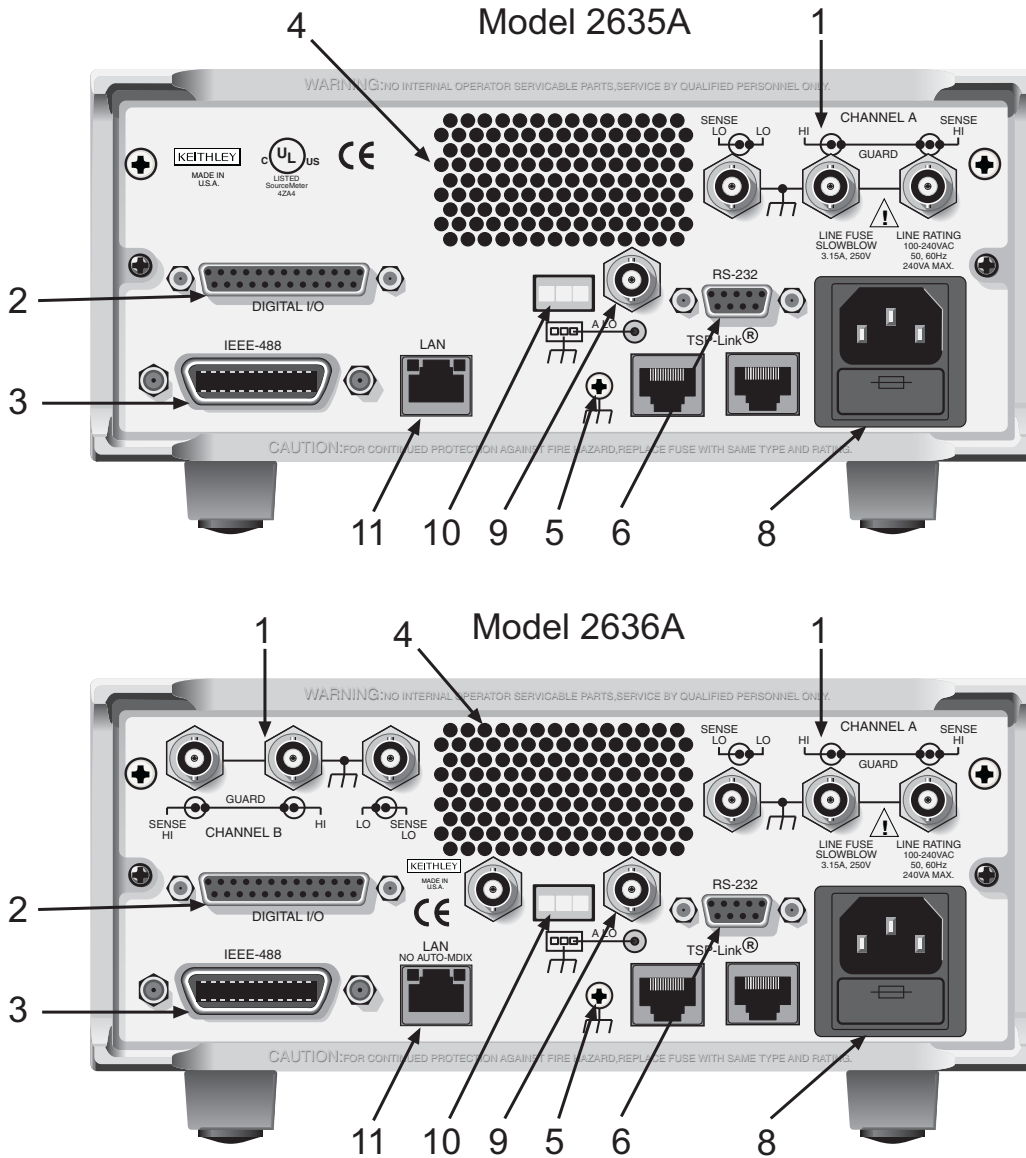

Model 2635A/2636A rear panels

1. CHANNEL A and CHANNEL B (Channel B on Model 2636A only)

Triax connectors for Input/output, guard, and sense connections. Use only low-noise triax cables such as the Keithley Model 7078-TRX (available in several lengths). Connector terminals and associated triax cable conductors are as follows:

Table 1-1
Connectors and triax cable conductors

Connector	Center conductor	Inner ring	Outer ring
LO	Sense LO	Input/Output LO	Chassis ground
HI	Input/Output HI	Guard	Chassis ground
SENSE HI	Sense HI	Guard	Chassis ground
Triax cable	Center conductor	Inner shield	Outer shield

2. DIGITAL I/O

Female DB-25 connector. Fourteen pins for digital input or output, one pin for safety interlock. Use a cable equipped with a male DB-25 connector (Keithley Instruments part number CA-126-1CA).

3. IEEE-488

Connector for IEEE-488 (GPIB) operation. Use a shielded cable, such as the Model 7007-1 or Model 7007-2.

4. Cooling exhaust vent

Exhaust vent for internal cooling fan. Keep vent free of obstructions to prevent overheating.

5. Chassis ground

Ground screw for connections to chassis ground.

6. RS-232

Female DB-9 connector. For RS-232 operation, use a straight-through (not null modem) DB-9 shielded cable (Keithley Instruments Model 7009-5) for connection to the PC.

7. TSP-Link

Expansion interface that allows a Series 2600A and other TSP-enabled instruments to trigger and communicate with each other. Use a category 5e or higher LAN crossover cable (Keithley Instruments part number CA-180-3A).

8. Power module

Contains the AC line receptacle and power line fuse. The instrument can operate on line voltages of 100V to 240VAC at line frequencies of 50Hz or 60Hz. See the Series 2600A Reference Manual for line fuse replacement instructions.

9. Ground / LO (Triax connector)

Channel A and Channel B low noise chassis ground triax connectors. Use only low-noise triax cables such as the Keithley Model 7078-TRX. Connector terminals and associated triax cable connectors are as follows:

Table 1-2

Triax connector on ground module

Connector	Center conductor	Inner ring	Outer ring
LO	Output Lo	Floating	Chassis ground
Triax cable	Center conductor	Inner shield	Outer shield

10. Ground / LO (Phoenix connector)

Channel A and Channel B low-noise chassis ground Phoenix connector.

11. LAN

Use this RJ-45 connector to connect the instrument to the local area network. The RJ-45 connector connects a network card, a network switch, a router or a hub. When connecting directly to a PC, a crossover cable (included) must be used. When connecting to a network switch, router, or hub, a normal CAT-5 cable (not provided) should be used unless your equipment has Auto-MDIX capabilities. If it does have Auto-MDIX, the crossover cables may be used.

What are the source-measure capabilities?

Model 2601A and Model 2602A

Basic DC source-measure capabilities for the Models 2601A and 2602A are listed in [Table 1-3](#).

Table 1-3

Model 2601A and 2602A source-measure capabilities

Function	Capabilities
Source \pm DC voltage	1 μ V to 40.4V
Source \pm DC current	1pA to 3.03A ¹
Measure \pm DC voltage	1 μ V to 40.8V
Measure \pm DC current	1pA to 3.06A ¹

1. 10A maximum available in pulse mode only.

Model 2611A and Model 2612A

Basic DC source-measure capabilities for the Models 2611A and 2612A are listed in [Table 1-4](#).

Table 1-4

Model 2611A and 2612A source-measure capabilities

Function	Capabilities
Source \pm DC voltage	1 μ V to 202V
Source \pm DC current	1pA to 1.515A ¹
Measure \pm DC voltage	1 μ V to 204V
Measure \pm DC current	1pA to 1.53A ¹

1. 10A maximum available in pulse mode only.

Model 2635A and Model 2636A

Basic DC source-measure capabilities for the Models 2635A and 2636A are listed in [Table 1-5](#).

Table 1-5

Model 2635A and 2636A source-measure capabilities

Function	Capabilities
Source \pm DC voltage	1 μ V to 202V
Source \pm DC current	20fA to 1.515A
Measure \pm DC voltage	1 μ V to 204V
Measure \pm DC current	1fA to 1.53A

How do I power-up the instrument?

Step 1: Connect to line power

CAUTION Operating the instrument on an incorrect line voltage may cause damage to the instrument, possibly voiding the warranty.

1. Before you plug the power cord into the Series 2600A, make sure that the front panel power switch is in the off (O) position.
2. Connect the female end of the supplied power cord to the AC receptacle on the rear panel. Connect the other end of the power cord to a grounded AC outlet.

WARNING *Failure to use a grounded outlet may result in personal injury or death due to electric shock.*

Step 2: Turn on power

Turn on the instrument by pressing the front panel power switch to the on (I) position. Assuming no errors occur, the Series 2600A will power-up as follows:

1. The OUTPUT indicators and display pixels flash briefly.
2. The following items are shown in sequence:
 - The firmware revision number.
 - The line frequency.
 - The TSP-Link node.
 - The enabled command interface(s) and address (GPIB/LAN/RS-232).

Step 3: Set line frequency

The Series 2600A will operate at line frequencies of either 50Hz or 60Hz. For best measurement noise performance, the unit should be configured to match the actual line frequency used by selecting **MENU > LINE-FREQ > 50Hz, 60Hz, or AUTO** (when set to **AUTO**, the SourceMeter will automatically detect the power line frequency at power-up).

How do I make measurements?

See the Series 2600A Reference Manual for more information on the following:

- Basic source-measure procedure.
- Ohms measurements.
- Power measurements.

The measurement procedure below demonstrates how to set up the Series 2600A to source 10V and measure current through a 10k Ω resistor.

WARNING *Hazardous voltages may be present on the output and guard terminals. To prevent electrical shock that could cause injury or death, NEVER make or break connections to the Series 2600A while the output is on. Power off the equipment from the front panel or disconnect the main power cord from the rear of the SourceMeter before handling cables connected to the outputs. Putting the equipment into standby does not guarantee the outputs are not powered if a hardware or software fault occurs.*

Step 1: Connect the DUT

Connect a 10k Ω resistor to the SourceMeter Channel A HI and LO terminals as shown in [Figure 1-4](#). See the Series 2600A Reference Manual for complete connection information.

Step 2: Select source and set source level

Perform the following steps to select the voltage source and set the source value to 10V:

1. Press **Channel A SRC** to select the V-Source as indicated by the "V" units in the source field on the display. The flashing cursor indicates which value is presently selected for editing.
2. Press the up **RANGE** key, and select the 20V source range (Model 2611A/2612A/2635A/2636A) or 40V source range (Model 2601A/2602A). Use the lowest possible source range for best accuracy.
3. Use the **CURSOR** keys to move the cursor to the 10s digit, then press the **navigation wheel** to enter the EDIT mode (EDIT indicator is displayed).
4. Using the **navigation wheel**, set the source value to 10.0000V, then press the **ENTER** key or the **navigation wheel**.

Step 3: Set compliance limit

Perform the following steps to set the current compliance limit value to 10mA:

1. Put the Model 2602A/2612A/2636A in the single-channel display mode with the **DISPLAY** key.
2. Press the **LIMIT** key, then press the **ENTER** key or the **navigation wheel**.
3. Move the cursor to the 10s digit, then press the **navigation wheel** to enter the **EDIT** mode.
4. Using the **navigation wheel**, set the limit value to 10.000mA, then press the **ENTER** key or the **navigation wheel**.

Step 4: Select measurement function and range

1. Put the Model 2602A/2612A/2636A in the single-channel display mode with the **DISPLAY** key, then select the current measurement function by pressing **MEAS** or **MODE**.
2. Select the measurement range with the **RANGE** keys. For the purposes of this example, press **AUTO RANGE**, and note that the AUTO indicator is displayed. The instrument will automatically select the best range based on the measured value. You can also use manual ranging by pressing the up or down **RANGE** key, but be sure to use the lowest possible range for best accuracy.

Step 5: Turn output on

Turn the output on by pressing the appropriate **OUTPUT ON/OFF** key. The ON/OFF indicator LED will turn on when the channel output is on.

NOTE The Models 2611A, 2612A, 2635A, and 2636A are equipped with a safety interlock circuit that prevents operation on the 200V range if the circuit is not energized. This circuit is illustrated in [Figure 1-5](#). See to the Series 2600A Reference Manual for more information.

Step 6: Make measurements

1. Observe the readings on the display (press **TRIG** if necessary to trigger the unit to begin taking readings). For the single-channel display mode, the readings will appear on the top line, while source and limit values are on the bottom line. For the 10k Ω resistor under test, typical display values are:
1.00000mA
SrcA: +10.0000 V LimA:010.0000mA
2. Use the **DISPLAY** key to cycle through the various display modes shown in [Figure 1-6](#) (the User State display messages are defined with specific display commands; see the Series 2600A Reference Manual for more information).
3. Press the **MEAS** key several times to display measured voltage, resistance, and power. Typical values for the 10k Ω resistor are: 10.0000V, 10.0000k Ω , and 10.0000mW.

Step 7: Turn output off

When finished making measurements, turn the output off by pressing the **OUTPUT ON/OFF** key. The OUTPUT indicator light will turn off.

Figure 1-4

Model 2602A/2612A low-noise chassis ground banana jack and chassis screw

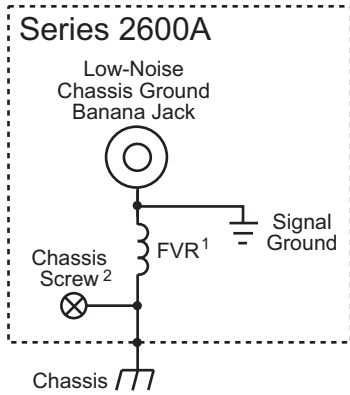

- 1) Frequency Variable Resistor (FVR) – Isolates the SMUs from high frequencies on the chassis. For DC to 60Hz, the FVR is a virtual short (zero ohms).
- 2) **DO NOT** use the Chassis Screw terminal to make signal connections to external circuitry. High frequency (>1MHz) on the chassis may result in higher noise at the output.

Signal Ground Signal Ground is a local signal ground and defined as the Low-Noise Chassis Ground Banana Jack.

Chassis Chassis is defined as the metal chassis of the Series 2600.

Chassis Screw terminal is connected to the metal chassis of the Series 2600.

Model 2636A

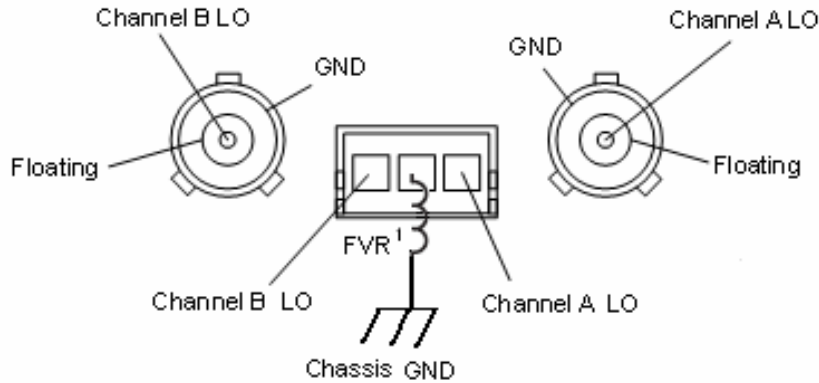

Figure 1-5
Interlock circuit

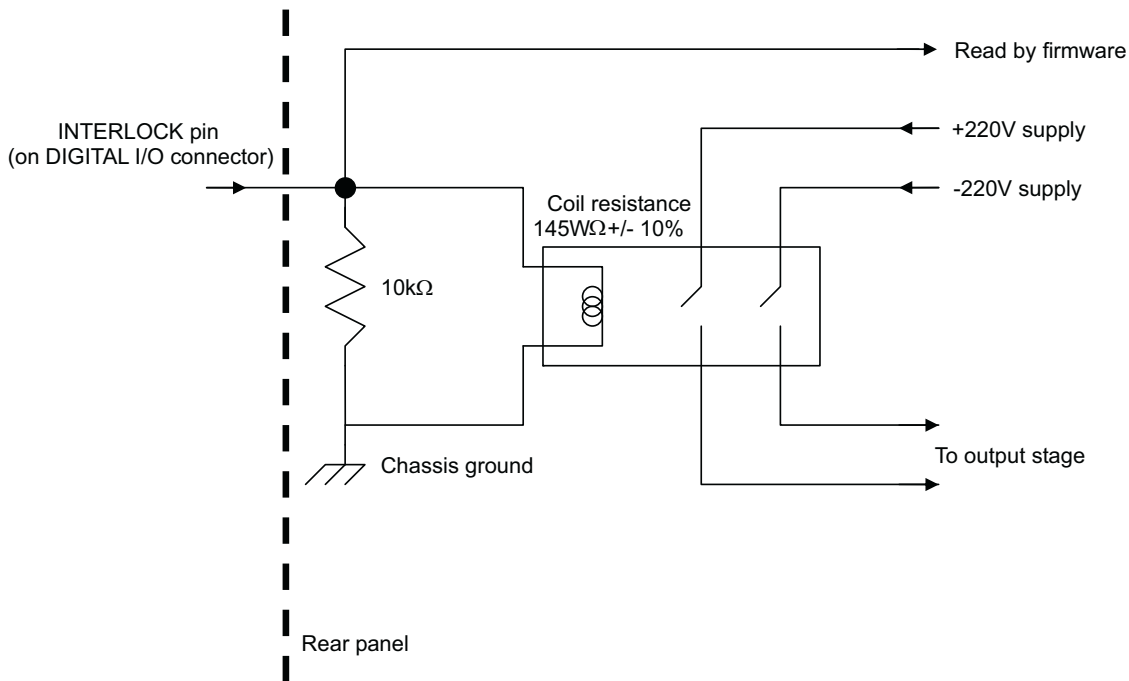
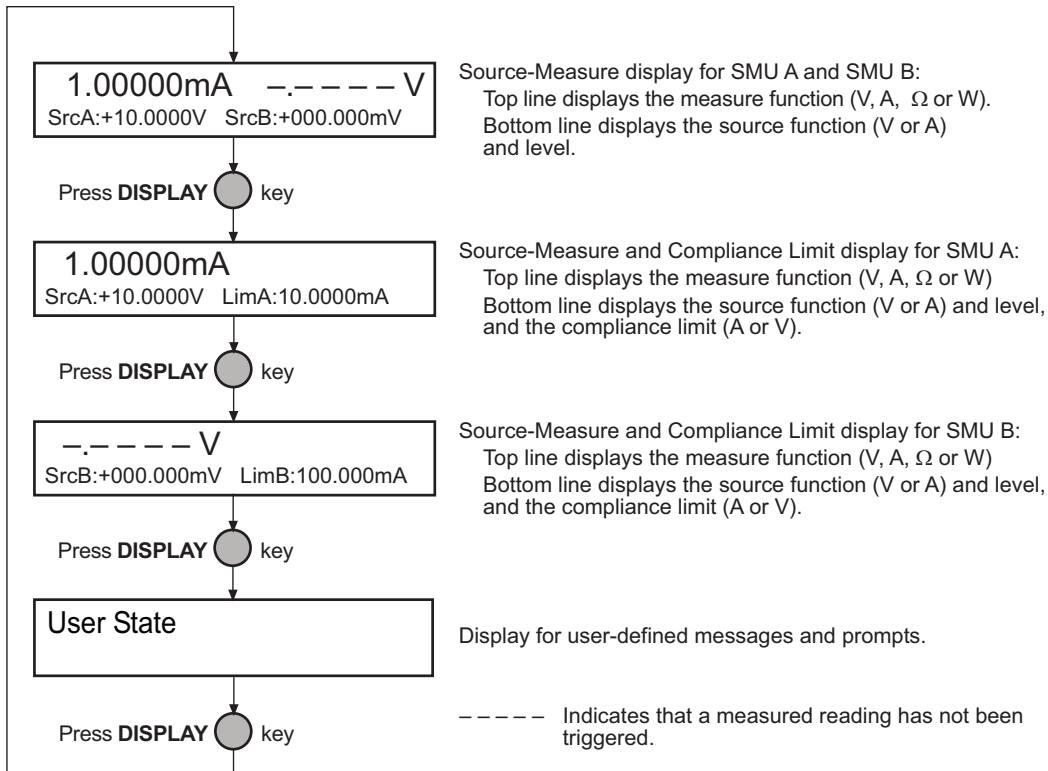

Figure 1-6
Display modes



How do I use the reading buffer?

The instrument has two dedicated reading buffers per channel that can store over 60,000 readings with the time stamps and source values options enabled. Disable the time stamps and source values options to store over 140,000 readings.

The following example shows how to store 100 readings, source values, and timestamps in Channel A, Buffer 1 and recall them from the front panel.

Step 1: Connecting the device under test (DUT)

Connect a 10k Ω resistor to the Channel A HI and LO terminals (see [Figure 1-4](#)).

Step 2: Set up source and measure functions

Using the procedure described in [How do I make measurements?](#), set up source and measure functions:

- Source function: Volts.
- Source range: 20 V (2611A/2612A/2635A/2636A) or 40V (2601A/2602A).
- Source value: 10 V.
- Measure function: Current.
- Measure range: Auto.

Step 3: Configuring the reading buffer

Complete the following steps to configure reading buffers from the front panel:

1. Press **CONFIG > STORE** and then choose one of the following:
 - **CHANA-BUFF**
 - **CHANB-BUFF**
2. Select the **DEST** option and then choose one of the following:
 - **CHANX-BUFF1**
 - **CHANX-BUFF2**
 - **NONE**
3. Select **BUFFER1** or **BUFFER2**.
4. (Optional) To clear the buffer, turn the **navigation wheel** to select **CLEAR > YES**.
5. Turn the **navigation wheel** to select **ELEMENTS**.

NOTE You must clear the reading buffer before you enable or disable the source value or the time stamp options.

6. (Optional) Push the **navigation wheel** to select **TSTAMP**, then select **OFF** or **ON**.
7. (Optional) Turn the **navigation wheel** to select **SRC-VAL**, then select **OFF** or **ON**.
8. Press the **EXIT** key to return to the main menu.

NOTE Model 2601A/2611A/2635A buffer configuration menu items are the same as covered above except for channel selection.

Step 4: Turn on the output

Press the **CHAN A** (Model 2602A/2612A/2636A) **OUTPUT ON/OFF** key to turn on the source output.

Step 5: Storing reading buffers

1. From the front panel, press **STORE** and then choose **SAVE**.
2. Select **INTERNAL** to save to internal nonvolatile memory.
3. Select one of the following:
 - **SMUA_BUFFER1**
 - **SMUA_BUFFER2**
 - **SMUB_BUFFER1**
 - **SMUB_BUFFER2**
4. The front panel displays Saving... This may take awhile.
5. Press the **EXIT** key to return to the main menu.

Step 6: Turn off the output

- Press the **OUTPUT ON/OFF** key to turn off the output after storage is completed.

Step 7: Recalling readings

1. Press the **RECALL** key to access buffer readings (repeatedly pressing **RECALL** will cycle through Buffer 1 then Buffer 2 for Channel A and then Channel B). A message will be displayed if a buffer is empty.
2. Note the buffer display data (see [Figure 1-7](#)):
 - The buffer location number is on the right. For example, location #000001 indicates that the displayed reading is stored at the first memory location.
 - The source value is positioned at the lower left side of the display.
 - The timestamp is positioned at the lower right side. The first source-measure reading stored in the buffer (#000001) is time stamped at 00000.000000 seconds. Subsequent readings are time stamped relative to when the time storage was started. The interval between readings will depend on the reading rate.
3. To display the other readings stored in the buffer, choose the desired memory location number:
 - Use the **navigation wheel** to increment and decrement the selected digit of the location number.
 - Set the cursor position with the **navigation wheel** or **CURSOR** keys.
4. To exit from the data store recall mode, press **EXIT**.

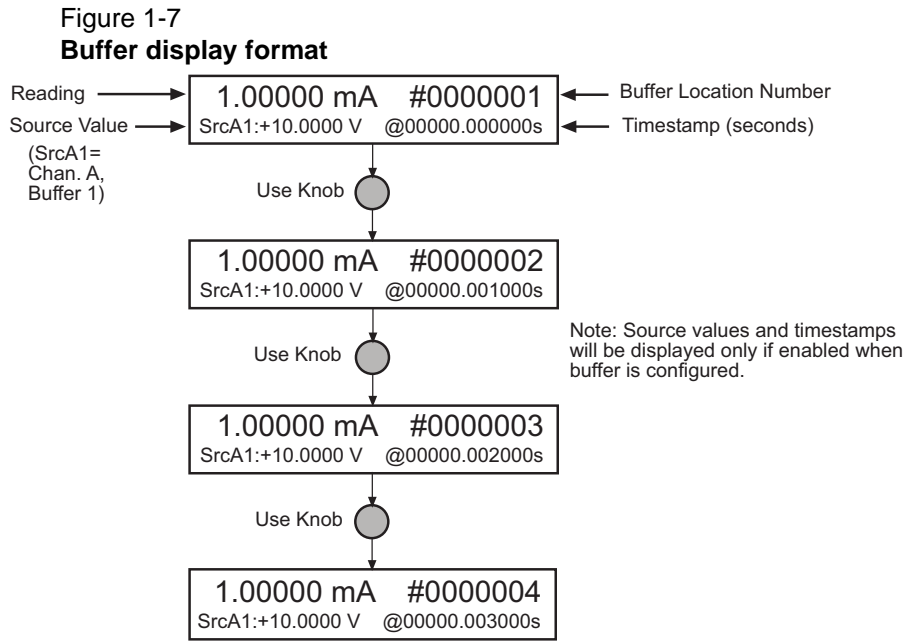

Saving the reading buffer to the USB flash drive

Complete the following steps to save the reading buffer data to a USB flash drive:

1. Insert the USB flash drive into the USB port.
2. Press **STORE** and use the **navigation wheel** to select **SAVE > USB1**.
3. Select one of the following file formats:
 - **CSV**
 - **XML**
4. Use the **navigation wheel** to select the desired reading buffer.
5. Use the **navigation wheel** to change the file name.
6. Push the **navigation wheel** or the **ENTER** key to save the file.
7. Push **EXIT** to return to the main menu.

This page left blank intentionally.

Remote Operation

In this section:

Topic	Page
How do I use the remote interface?	2-2
Connect to the interface	2-2
Configure the interface	2-2
Working with the web interface	2-8
How to use the Virtual Front Panel	2-9
TSB embedded	2-9
Issuing ICL commands	2-10
How do I use Test Script Builder?	2-11
Run Test Script Builder	2-11
Open and close an instrument resource	2-13
Save and clear console window	2-14
Select command and language reference views	2-14
How do I use TSB to make measurements?	2-14
Reset instrument.....	2-15
Select source function and set output value	2-15
Set compliance value and measure range	2-16
Turn on output.....	2-16
Make a measurement	2-16
Print the result.....	2-16
Turn off output.....	2-16
How do I use other programs?	2-17
Using LabVIEW	2-17
Using Visual Basic	2-19

How do I use the remote interface?

Connect to the interface

See [Figure 1-2](#) for the locations of the GPIB (IEEE-488), RS-232, and LAN connectors, and make connections as follows:

- GPIB: Use a shielded IEEE-488 cable such as the Keithley Instruments Model 7007 to connect the Series 2600A IEEE-488 connector to the GPIB connector on the host PC (see [Figure 2-1](#)).
- RS-232: Use a shielded 9-pin RS-232 cable like the Keithley Instruments Model 7009-5 to connect the Series 2600A RS-232 connector to the serial port of the host PC (see [Figure 2-2](#)).
- LAN: Use the crossover cable supplied with the Series 2600A to connect directly to the host PC's network card.

Figure 2-1

GPIB cable

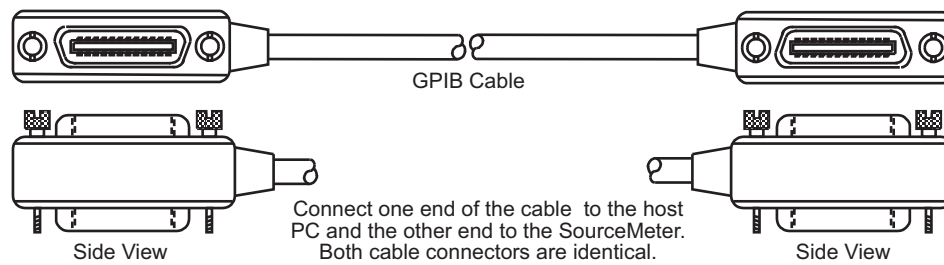
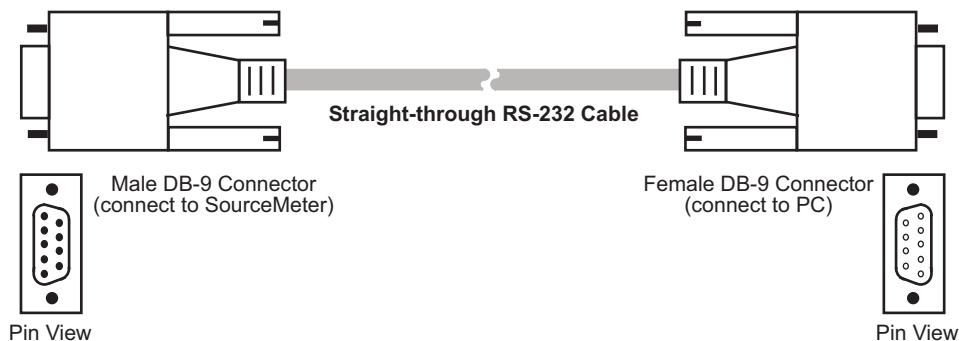

Figure 2-2

RS-232 cable



Configure the interface

GPIB interface configuration

Set the primary address using the following procedure. The Series 2600A primary address must be the same as that specified in your program, or the two devices will not be able to communicate.

1. Press **MENU** > **GPIB** and then press the **ENTER** key.
2. Select **ADDRESS** and then press the **ENTER** key. The Address screen is displayed.
3. Turn the **navigation wheel** to the right or to the left to select the desired number.

4. Push the **navigation wheel** and then turn the **navigation wheel** to choose an address.

NOTE The GPIB address can range from 1-30.

5. Press the **navigation wheel** to set each digit.
6. Press the **navigation wheel** or the **ENTER** key to set the address.
7. Press **EXIT** to back out of the menu structure.

RS-232 interface configuration

Set RS-232 parameters as covered below. Before you can use the RS-232 interface to communicate with the instrument, the serial port parameters for the host PC must match the serial parameters set on the instrument.

1. Press **MENU** to view the main menu.
2. Choose **RS232**, then press the **ENTER** key.
3. Choose the following options:
 - Select **BAUD** and then choose the desired option.
 - Choose **BITS** and then select the appropriate option.
 - Select **PARITY** and then choose the desired option.
 - Choose **FLOW-CTRL** and then select the appropriate option.
 - a. Use the **navigation wheel** to select **ENABLE**.
 - b. Select one of the following:
 - ON
 - OFF
6. Press **EXIT** to back out of the menu structure.

LAN interface configuration

Use the instructions below to configure the instrument's IP address based on the present IP address of the host PC. Whenever there is an existing IP address configured for the network interface card's network settings, the IP address for the instruments on the Ethernet should also be configured.

Step 1: Identify and record the PC's existing IP configuration Information

1. Open the command prompt to see the existing IP configuration information:
 - In Windows 2000/XP:
 - a. Click the **Start** button and select **Run**.
 - b. Type `cmd` in the **Open** field and click **OK**.
 - In Windows Vista:
 - a. Click the **Start** button.
 - b. Select **All Programs**.
 - c. Select **Accessories**.
 - d. Select **Command Prompt**.
2. At the command prompt, type `ipconfig/all` and click **Enter** (see [Figure 2-3](#)).
 - a. If the information for the Ethernet adapter displays `Media Disconnected`, then close the command prompt and skip to [Step 2: Disable DHCP to use the computer's existing IP address](#).
 - b. When the information is displayed, record the DHCP mode, IP address, subnet mask, default gateway, and DNS servers.

CAUTION The `ipconfig/all` command displays the configuration of all network connections. Be sure to record the information for the proper network card.

Figure 2-3
Computer configuration using the command prompt

```

C:\WINDOWS>ipconfig/all

Windows IP Configuration

Host Name . . . . . : mycomputer
Primary Dns Suffix . . . . . :
Node Type . . . . . : Hybrid
IP Routing Enabled. . . . . : No
WINS Proxy Enabled. . . . . : No
DNS Suffix Search List. . . . . : mycompany.com

Ethernet adapter Wireless Network Connection:

Connection-specific DNS Suffix . . :
Description . . . . . : Intel(R) Wireless WiFi Link 4965AG
Physical Address. . . . . : 00-01-02-03-04-05
Dhcp Enabled. . . . . : Yes
IP Address. . . . . : 1.2.3.87
Subnet Mask . . . . . : 255.255.255.0
Default Gateway . . . . . : 1.2.3.1
DNS Servers . . . . . : 1.2.3.2

Ethernet adapter Local Area Connection:

Connection-specific DNS Suffix . . :
Description . . . . . : Intel(R) 82566MM Gigabit Network Connection
Physical Address. . . . . : 00-02-03-04-05-06
Dhcp Enabled. . . . . : No
IP Address. . . . . : 192.168.1.100
Subnet Mask . . . . . : 255.255.255.0
Default Gateway . . . . . : 192.168.1.1
DNS Servers . . . . . :

C:\WINDOWS>
  
```

3. Verify DHCP or Static IP status.
 - To determine the next step, check the DHCP Enabled setting in the IP configuration screen or in the settings recorded earlier.
 - a. If DHCP Enabled = **Yes**, proceed to [Step 2: Disable DHCP to use the computer's existing IP address](#).
 - b. If DHCP Enabled = **No**, proceed to [Step 3: Configure the Instrument's LAN settings](#).

NOTE When DHCP Enabled = Yes, the settings are assigned automatically upon power up. However, if DHCP Enabled = No, the network will not recognize the PC if the original settings are changed. If at any time you are unsure how to proceed, contact your system administrator.

4. To exit the IP configuration screen, type `exit` at the command prompt and press **ENTER**.

Step 2: Disable DHCP to use the computer's existing IP address

NOTE Do not change the IP address at any time without talking to your system administrator first. Entering an incorrect IP address can prevent your PC from connecting to your corporate network.

1. Open the Internet Protocol Properties dialog box
 - In Windows 2000:
 - a. Click the **Start** button, select **Settings**, and then open the **Control Panel**.
 - b. Open **Network and Dial-up Connections**.
 - c. Right-click **Local Area Connection** and select **Properties**. The Local Area Connection Properties dialog box is displayed.
 - d. Double-click **Internet Protocol (TCP/IP)** in the items list. The Internet Protocol (TCP/IP) Properties dialog box is displayed (see [Figure 2-4](#)).
 - In Windows XP:
 - a. Click the **Start** button and open the **Control Panel**.
 - b. Open **Network Connections**.
 - c. Right-click **Local Area Connection** and select **Properties**. The Local Area Connection Properties dialog box is displayed.
 - d. Double-click **Internet Protocol (TCP/IP)** in the items list. The Internet Protocol (TCP/IP) Properties dialog box is displayed (see [Figure 2-4](#)).
 - In Windows Vista:
 - a. Click the **Start** button and open the **Control Panel**.
 - b. Open **Network & Sharing Center**.
 - c. In the list, click **View Status** next to Connection. The Wireless Network Connection Status dialog box is displayed.
 - d. Click **Properties**. Windows displays a permissions message.
 - e. If you are logged in as administrator, click **Continue**. If you are not logged in as administrator, enter the administrator's password to continue.
 - f. The Network Connection Properties dialog box is displayed.
 - g. Double-click **Internet Protocol Version 6 (TCP/IPv6)** in the items list. The Internet Protocol Version 6 (TCP/IPv6) Properties dialog box is displayed (see [Figure 2-4](#)).
2. Select **Use the following IP address**. The option for **Use the following DNS server** addresses is automatically selected.
3. Set the IP Address
 - a. Are the IP address and subnet mask fields populated?
 - Yes: If populated, record the address, subnet mask, default gateway, and DNS servers to use in [Step 3: Configure the Instrument's LAN settings](#).
 - No: If blank, enter the IP address 192.168.0.3 in the IP address field and 255.255.255.0 in the subnet mask field. These will be used to configure the instrument's LAN settings.
 - b. After recording or entering the IP address, click **OK** to close the Internet Protocol (TCP/IP) Properties dialog box.
4. Close the Network Connections window.

Figure 2-4
Internet protocol (TCP/IP) properties dialog box

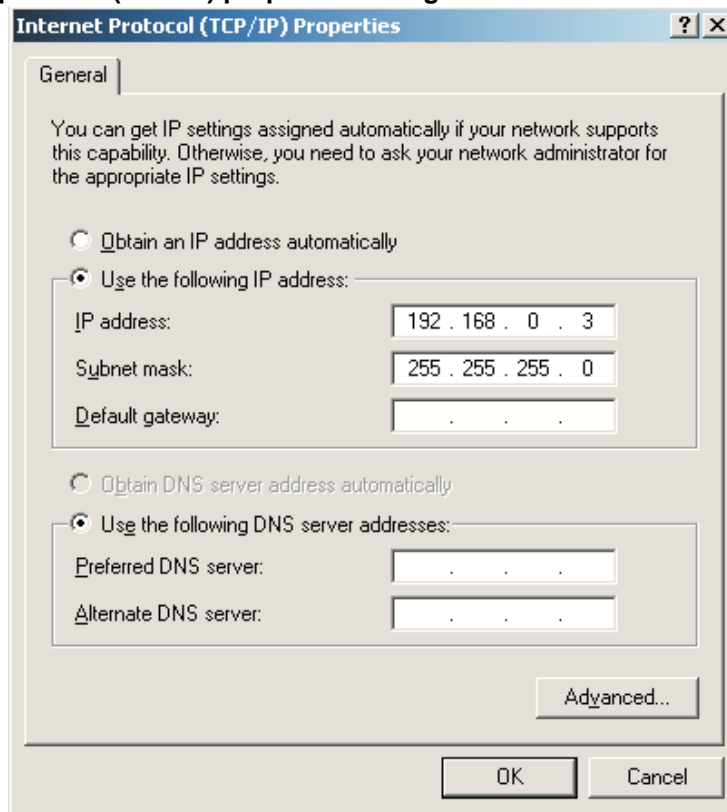

Step 3: Configure the Instrument's LAN settings

To configure the Series 2600A using the front panel:

1. Press the **MENU** key to display the MAIN MENU. Use the **navigation wheel** to select **LAN** to display the LAN MENU.
2. Change the IP address assignment method:
 - a. Select **CONFIG > METHOD > MANUAL**, then press the **ENTER** key.
 - b. Press the **EXIT** key once to return to the LAN MENU.
 - c. Select **APPLY_SETTINGS > YES**, then press the **ENTER** key.
3. Enter the IP address using the LAN MENU:
 - a. Select **CONFIG > IP-ADDRESS**.
 - b. Refer to the recorded computer's IP address. A portion of the computer's IP address will be used as a base for the instrument's unique ID. Only the last three numbers (after the last decimal point) will be different between the PC and instrument. The last three digits may be anything from 1-255 for a subnet mask of 255.255.255.0.

For example, the Internet Protocol (TCP/IP) Properties dialog box in [Figure 2-3](#) shows that the computer's IP address is 192.168.1.1. A unique address for the instrument is 192.168.001.101.

NOTE The instrument's IP address can have leading zeros, but the computer's cannot.

- c. Use the **navigation wheel** to select and enter an appropriate IP address for the instrument. Be sure to record the instrument's IP address to use in [Step 5: Access the instrument's internal web page](#).
 - d. Push the **ENTER** key or **navigation wheel** to confirm the changes.
 - e. Press the **EXIT** key to return to the LAN MENU.
 - f. From the LAN MENU, select **APPLY_SETTINGS > YES**, then press the **ENTER** key.
4. Change the subnet mask from within the LAN MENU:
- a. Select **CONFIG > SUBNETMASK**, then press the **ENTER** key. The SUBNETMASK menu item is to the right of **GATEWAY**. Use the **navigation wheel** to scroll through the options.
 - b. Modify the SUBNETMASK to match the PC settings recorded earlier or 255.255.255.000 if DHCP Enabled = YES.
 - c. Push the **ENTER** key or the **navigation wheel** when finished changing all the characters.
 - d. Press the **EXIT** key to return to the LAN MENU.
 - e. From the LAN MENU, select **APPLY_SETTINGS > YES**, then press the **ENTER** key.

NOTE **APPLY_SETTINGS** must be used before changes to the IP address or subnet mask are applied.

Step 4: Connect the crossover cable from the instrument to the PC network interface card

Connect the supplied crossover cable between the computer's NIC card and the Ethernet connector on the instrument's rear panel. There are multiple connectors on the Series 2600A rear panel. Be sure to connect to the LAN connection port (see [Figure 2-5](#)).

NOTE Connect the crossover cable into the same PC Ethernet port that was used during the configuration of the instrument. This will ensure that the system is using the correct network card.

Figure 2-5
LAN connection

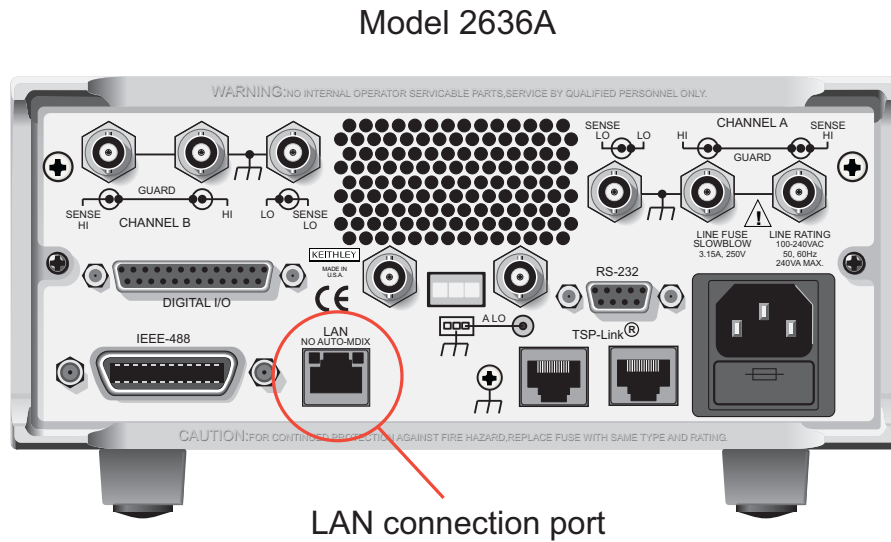

Step 5: Access the instrument's internal web page

1. Open a web browser on the host PC.
2. Enter the instrument's IP address in the browser's address box. For example, if the instrument's IP address is 192.168.0.3, enter 192.168.0.3 in the browser's address box.
3. Press **ENTER** on the PC keyboard to open the instrument's web page.

Working with the web interface

The Series 2600A has a web interface (see [Figure 2-6](#)) that you can use to remotely access the following:

- Connection string
- LXI class
- Firmware version number
- MAC address
- Instrument model
- Connection string
- Virtual front panel
- TSB embedded
- TSP Express

Figure 2-6
Web interface

LXI Web Interface - Welcome Page

Instrument Model:	2635A System SourceMeter®
Manufacturer:	Keithley Instruments
Firmware Revision:	X.X.X
Serial Number:	1175561
Description:	Keithley Instruments SMU 2636A - 1175561
LXI Class:	C
LXI Version:	1.2
MAC Address:	00:60:1A:99:15:E2
TCP/IP Address:	192.168.0.11
Gateway:	0.0.0.0
Subnetmask:	255.255.255.0
Lan Connection:	100Mbps, Full Duplex
Host Name (FQDN):	192.168.0.11
DNS Servers:	0.0.0.0 0.0.0.0 0.0.0.0
Ports:	DST: 5030 Raw Socket: 5025 Telnet: 23 VXI-11 Core: 1024
Instrument Address String:	TCPIP[board]::192.168.0.11::5025::SOCKET GPIB[board]::26::INSTR ASRL[board]::INSTR TCPIP[board]::192.168.0.11::inst0::INSTR
Smu A Calibration Date:	Sat Jan 01 13:00:48 2005
Smu A Calibration Due:	Sat Jan 01 13:00:48 2005

How to use the Virtual Front Panel

You can use the virtual front panel to access the features available from the front panel of the Series 2600A. The same front panel features and functions are available from the Virtual Front Panel with the exception of the POWER button.

TSP Express

TSP Express is a built-in utility that easily creates scripts for Series 2600A instruments (SMU). It provides a menu of choices for building new test scripts as well as options for opening existing projects and scripts. It also allows the user to view or change instrument configurations. TSP Express may be launched using a web link from any Series 2600A instrument or by using a shortcut on the host PC.

TSB embedded

TSB embedded is an alternative to a full version of Test Script Builder (TSB) Suite. The capabilities of TSB embedded are very similar to TSB. TSB embedded includes a command line interface that you can use to issue ICL commands, create, modify, and save test scripts to the instrument.

Issuing ICL commands

Use the console to send ICL commands to the instrument. The response from the instrument appears in the Instrument output window.

Complete the following steps to send an ICL command:

1. Type the command in the console and then click **Enter**.
2. (Optional) Click **Clear** to clear the instrument output window.

How do I create a script with TSB embedded?

Complete the following steps to create a new script:

1. Click the script editor window and then type the first line of your script. Click **Enter** to advance to line 2.
2. In the TSP Script line, type the name of the script and then click **Save script**.
The instrument validates the syntax and then saves the script to the nonvolatile memory.

How do I clear the script editor window in TSB embedded?

- To remove the syntax from the script editor, click **Clear**.

How to run scripts with TSB embedded

- To run a script, select the desired script from the User script window and then click **Run**.

How to stop scripts in TSB embedded

To stop a running script, click **Abort script**.

Deleting scripts

To delete a script from TSB embedded, select the desired script from the User script window and then click **Delete**.

NOTE You cannot retrieve a deleted script.

Modifying scripts

Complete the following steps to modify a script:

1. Select the desired script from the User script window and then modify the desired syntax in the script editor.
2. Click **Save script** to validate the syntax and save the script.
3. When the message "Script clearing will be overwritten" is displayed, do one of the following:
 - To overwrite the script, click **OK**.
 - To save the script with a new name, click **Cancel** and then type the name of the script in the name field.

Exporting Scripts

You can export a script to an external drive or store it as a backup on your PC.

1. To export a script, click on the name of the script in the Users script window and then click **Export**.
The **Save** dialogue box is displayed.

2. Use the drop-down arrow to change folders, and navigate to the desired file.
3. In the **File name** field, type the name of the file and then click **Save**.

How do I use Test Script Builder?

Step 1: Run Test Script Builder

Run the Test Script Builder program from the Keithley Instruments folder in the usual manner. The initial startup screen shown in [Figure 2-7](#) will be displayed. The main sections of the screen are briefly described below:

Main Bar

The menu contain following options:

- **File:** Use this option to control projects and files.
- **Edit:** Performs a number of editing functions on script files.
- **Navigate:** Navigates through projects.
- **Project:** Opens, closes, and builds projects.
- **Run:** Runs scripts.
- **Window:** Selects which window to display.
- **Help:** Provides access to online help files.

Project Navigator pane

The windowpane on the left side is where the Project Navigator is located. The navigator consists of created project folders and the script files (.tsp) created for each project. Each project folder can have one or more script files.

Script Development pane

The script chunk is written in the upper windowpane. It is in this area that scripts are written and/or modified. Notice that there is a tab available for each opened script file. A script project is then downloaded to the Series 2600A and run.

Series 2600A/Script Interaction pane

A number of tabs in the lower windowpane provide additional interaction between the Test Script Builder, the Series 2600A and the opened script (the tabs displayed will depend on those selected in the menu).

Figure 2-7
Test Script Builder initial startup screen

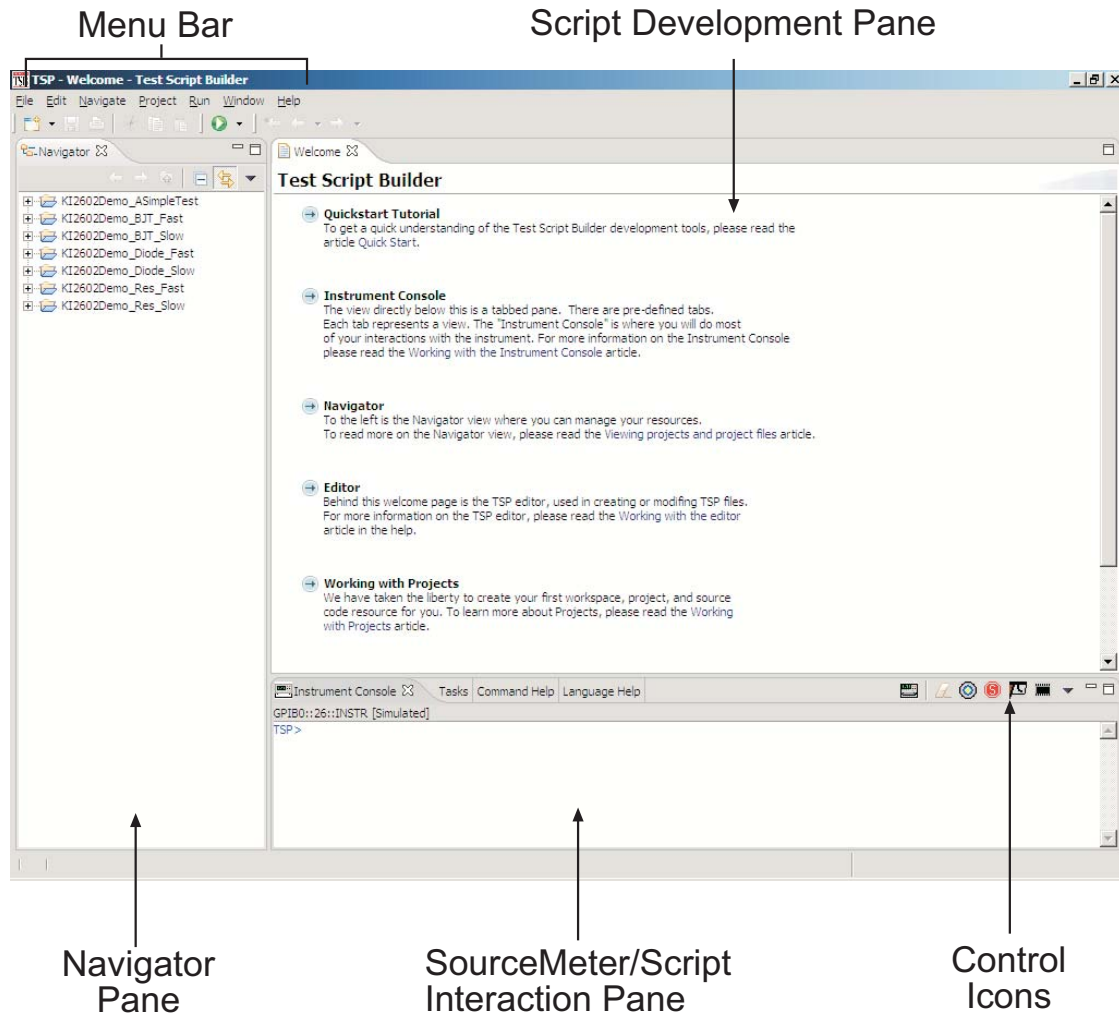

Key tabs include:

Instrument Console: The Instrument Console is used to send commands to the connected Series 2600A. Retrieved data (for example, readings) from commands and scripts appear in the console.

Problems: When a script is saved, error checking is performed. If a script error is detected, an “X” will appear in the script at or near the corrupt line of code. The Problems tab in the lower windowpane will open automatically and provide a description of the error.

Tasks: When writing a script, a double dash (--) is used to designate that the text that follows is a comment and not script code. When using the “--TODO” comment in a script, it will also appear in the Tasks tab, where additional information can be added.

Command Help: Provides online help to the Instrument Command Library (ICL).

Language Help: Provides online help to the TSL programming language.

Control icons

Control icons (shown in [Figure 2-8](#)) include:









1. **Open/Close Instrument**  – Opens instrument resource if closed. Closes instrument resource if open.
2. **Clear Console Window**  – Clears the instrument console window.
3. **Abort Execution**  – Halts execution of commands or scripts.
4. **Reset**  – Aborts whatever the unit is doing and resets everything to the default state with the output off.
5. **Send Software Trigger**  – Sends a software trigger to take readings.
6. **Delete a Script From NVRAM**  – Opens a window that lists the scripts stored in the unit's nonvolatile memory, and allows you to remove scripts.
7. **Menu**  – Accesses the console menu.
8. **Minimize/Maximize**  – Minimizes or maximizes the console window.

Figure 2-8
Instrument console control icons



Step 2: Open and close an instrument resource

Before you can send commands or run scripts to control the Series 2600A, you must first open the instrument resource as follows:

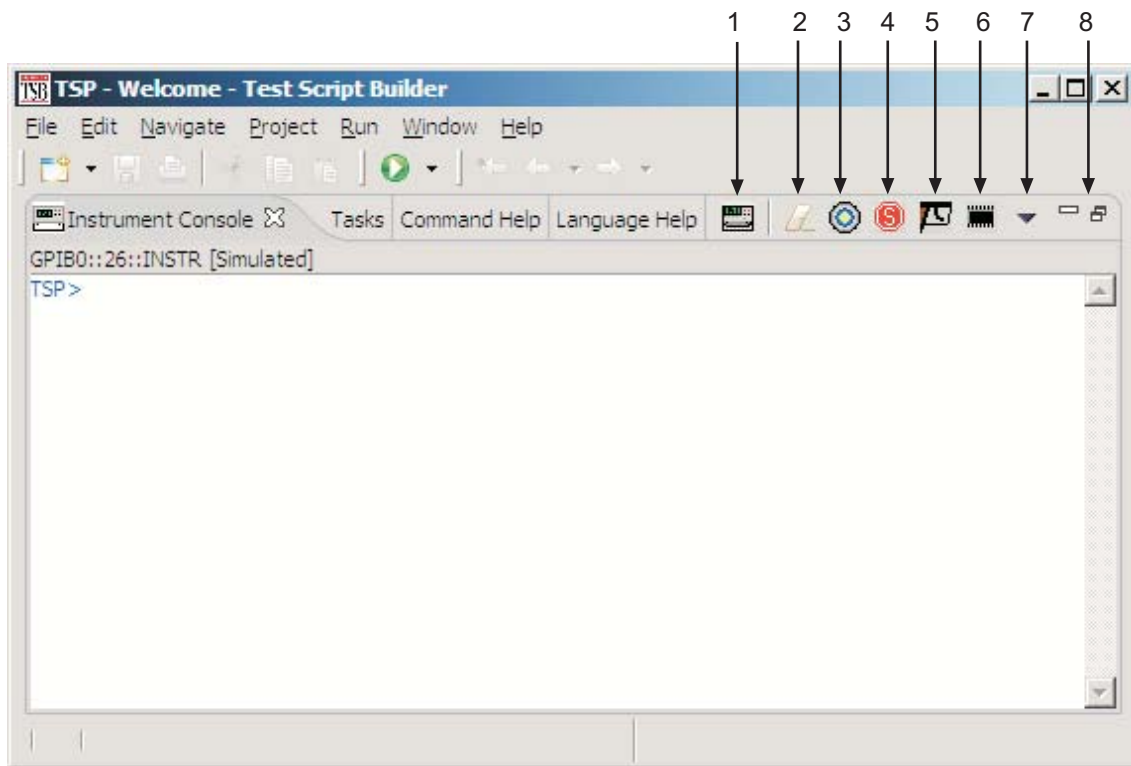
1. Click on the **Open Instrument** icon (see [Figure 2-8](#)).
2. Choose the desired instrument from the dialog box (see [Figure 2-9](#)) drop-down menu to select a communications resource:

- **GPIB:** At the factory, the GPIB address for the Series 2600A is set to 26. If using the GPIB interface board 0 and address 26, the resource setting should be **GPIB0::26::INSTR**. Resource settings for other GPIB board numbers and primary addresses are available from the dialog box.
 - **RS-232:** Typically, the COM1 serial port of the PC is used for RS-232 communications. For COM1, use the **ASRL1::INSTR** resource setting. Resource settings for other COM ports are available from the dialog box.
3. If you select the **Simulate** option, the Instrument Console will become active even though there will be no actual communication with the Series 2600A. You can simulate running a script or sending a command, but the Series 2600A will not respond.
 4. To close the resource, click on the **Instrument** icon again. The resource will close, and the console window will become inactive.

Figure 2-9

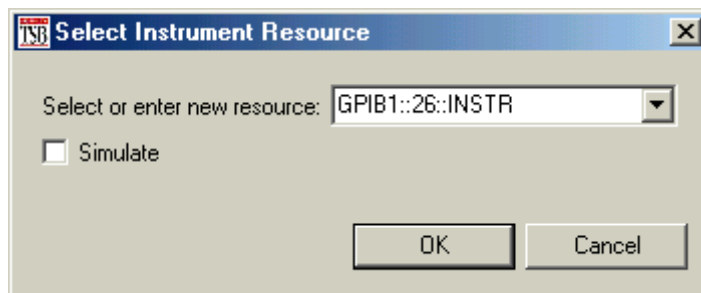
Select Instrument Resource dialog box**Step 3: Save and clear console window**

You can save and clear the console window as follows:

- **Save console:** Click on the **Menu** arrow (see [Figure 2-7](#)), choose **Save Console**, then choose the folder and filename desired.
- **Clear console:** Click on the **Clear Console** icon (see [Figure 2-7](#)) to clear the console window.

Step 4: Select command and language reference views

You can access online help for the ICL (Instrument Control Library) and TSL (Test Script Language) as follows:

- **ICL:** Click on the **Command Help** tab at the top, then click the **Maximize** icon. You can then quickly get information on all commands in the library.
- **TSL:** Click on the **Language Help** tab at the top, then click the **Maximize** icon to quickly access details on the script language.

How do I use TSB to make measurements?

The following procedure uses the TSB Instrument Console to send commands to source voltage and measure current on Channel A using a 10kΩ resistor as the DUT. The complete command sequence as it would appear in the console window is shown in [Figure 2-10](#) along with instrument responses.

The procedure assumes the DUT (10kΩ resistor) is already connected to the Series 2600A (see [Figure 1-4](#)), and that the instrument resource has already been opened (see [Open and close an instrument resource](#)).

Figure 2-10

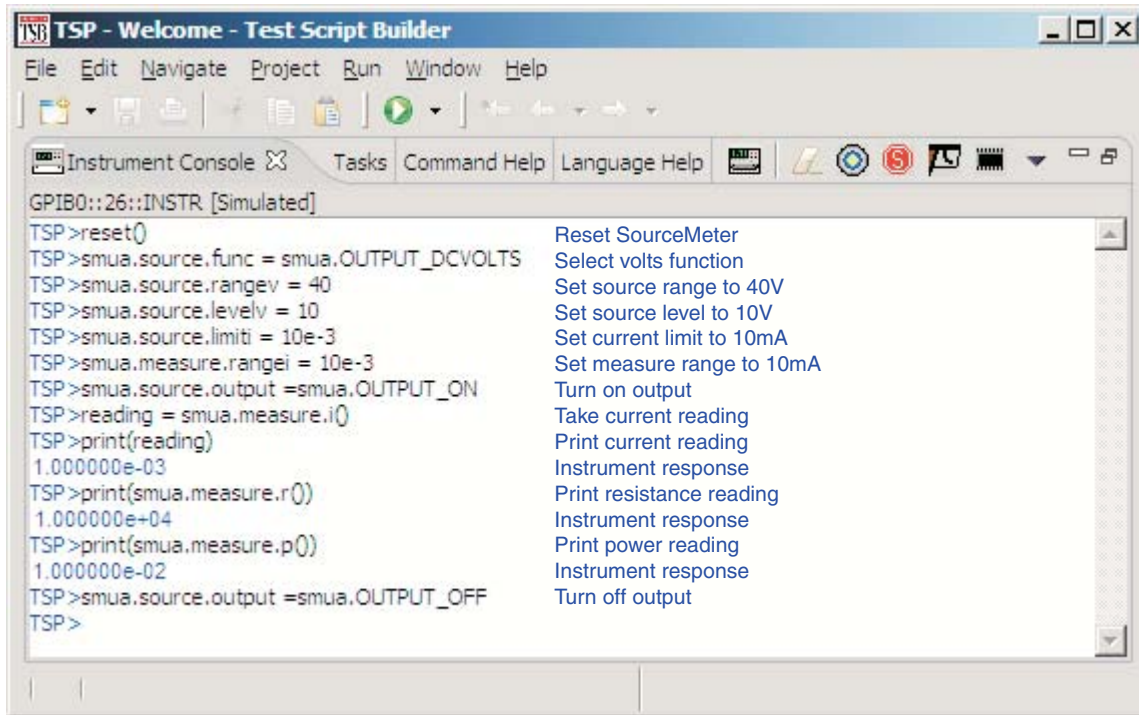
Source-measure command sequence in console window (2601A/2602A version shown)

WARNING *Hazardous voltages may be present on the output and guard terminals. To prevent electrical shock that could cause injury or death, NEVER make or break connections to the Series 2600A while the output is on. Power off the equipment from the front panel or disconnect the main power cord from the rear of the Series 2600A before handling cables connected to the outputs. Putting the equipment into standby does not guarantee the outputs are not powered if a hardware or software fault occurs.*

Step 1: Reset instrument

A good practice is to reset the instrument to its default settings before the start of a test. To reset the Series 2600A, type the following command into the console window, then press the **Return** key:

```
reset()
```

Channel A (all models) or Channel B (2602A, 2612A, 2636A only) defaults can be reset as follows:

```
smua.reset()
```

```
smub.reset()
```

Step 2: Select source function and set output value

Enter the following commands to select the source voltage function, set the source range to 20V (Model 2611A/2612A/2635A/2636A) or 40V Model 2601A/2602A), and set the source value to 10V:

```
smua.source.func = smua.OUTPUT_DCVOLTS
smua.source.rangev = 40                (Use for Model 2601A/2602A)
smua.source.rangev = 20                (Use for Model 2611A/2612A/2635A/2636A)
smua.source.levelv = 10
```

Step 3: Set compliance value and measure range

Enter the following commands to set the compliance limit and measure range to 10mA:

```
smua.source.limiti = 10e-3
smua.measure.rangei = 10e-3
```

Step 4: Turn on output

Send the following command to turn on the output:

```
smua.source.output = smua.OUTPUT_ON
```

Step 5: Make a measurement

Enter the following command to take a current measurement:

```
reading = smua.measure.i()
```

Step 6: Print the result

Print the result in the console window with the following command:

```
print(reading)
```

Note that the reading response will appear in the console window (see [Figure 2-10](#)).

Alternatively, you can also take and print readings by including the appropriate `measure` command as the argument in the `print` command. For example, the following commands will take and print ohms and power readings respectively:

```
print(smua.measure.r())
print(smua.measure.p())
```

Again, readings will be displayed in the console window.

Step 7: Turn off output

Send the following command to turn off the output when measurements are complete:

```
smua.source.output = smua.OUTPUT_OFF
```

How do I use other programs?

Reference See the LabVIEW and Visual Basic documentation for details on using those programs.

Basic source-measure examples using LabVIEW and Visual Basic are shown below. See also Section 3 for more examples to load and run scripts.

Using LabVIEW

The source-measure example using LabVIEW is shown in [Figure 2-11](#). The test steps are:

1. Reset instrument.
2. Select source voltage function.
3. Set source output voltage.
4. Turn on output.
5. Take current measurement.
6. Reset instrument.

The command sequence for this source-measure example is shown below:

```
localnode.prompts = 0           -- Disable prompts.
reset()                         -- Reset Series 2600A.
smua.source.func = smua.OUTPUT_DCVOLTS -- Select voltage source
                                   -- function.
smua.source.levelv = volts      -- Set voltage source level.
smua.source.output = smua.OUTPUT_ON -- Turn on source output.
print(smua.measure.i())        -- Take and return current
                                   -- reading.
reset()                         -- Reset Series 2600A.
```

The commands above are sent out in LabVIEW using either GPIB or VIS VIs. Refer to the LabVIEW documentation for information on using VIs.

Figure 2-11
LabVIEW source-measure example block diagram

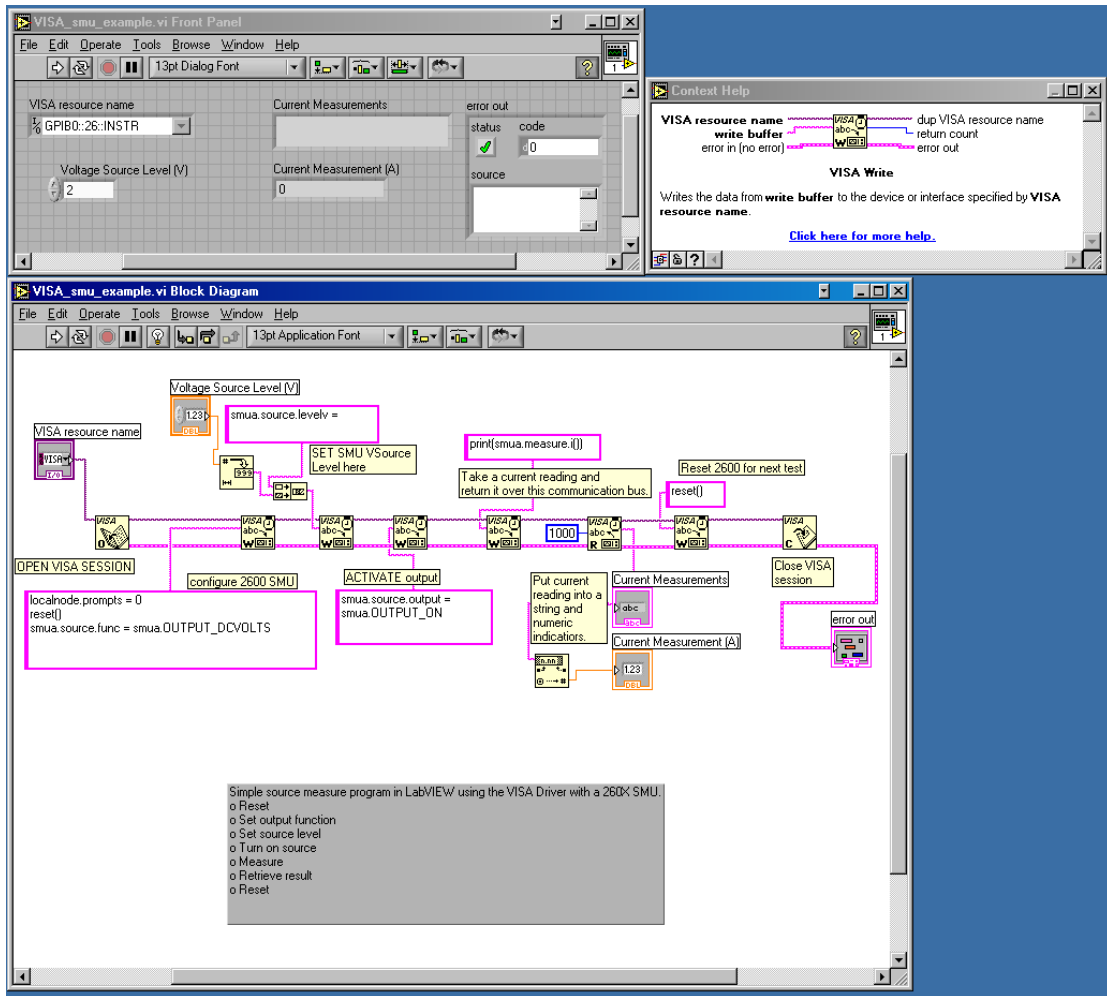

Using Visual Basic

User interface

The GUI (graphical user interface) shown in [Figure 2-12](#) was created to demonstrate how to control a Keithley Instruments Series 2600A SourceMeter® instrument using Visual Basic 6.0. Source code for this example program can be downloaded from the Keithley Instruments internet site, www.keithley.com.

Figure 2-12
Visual Basic example user interface

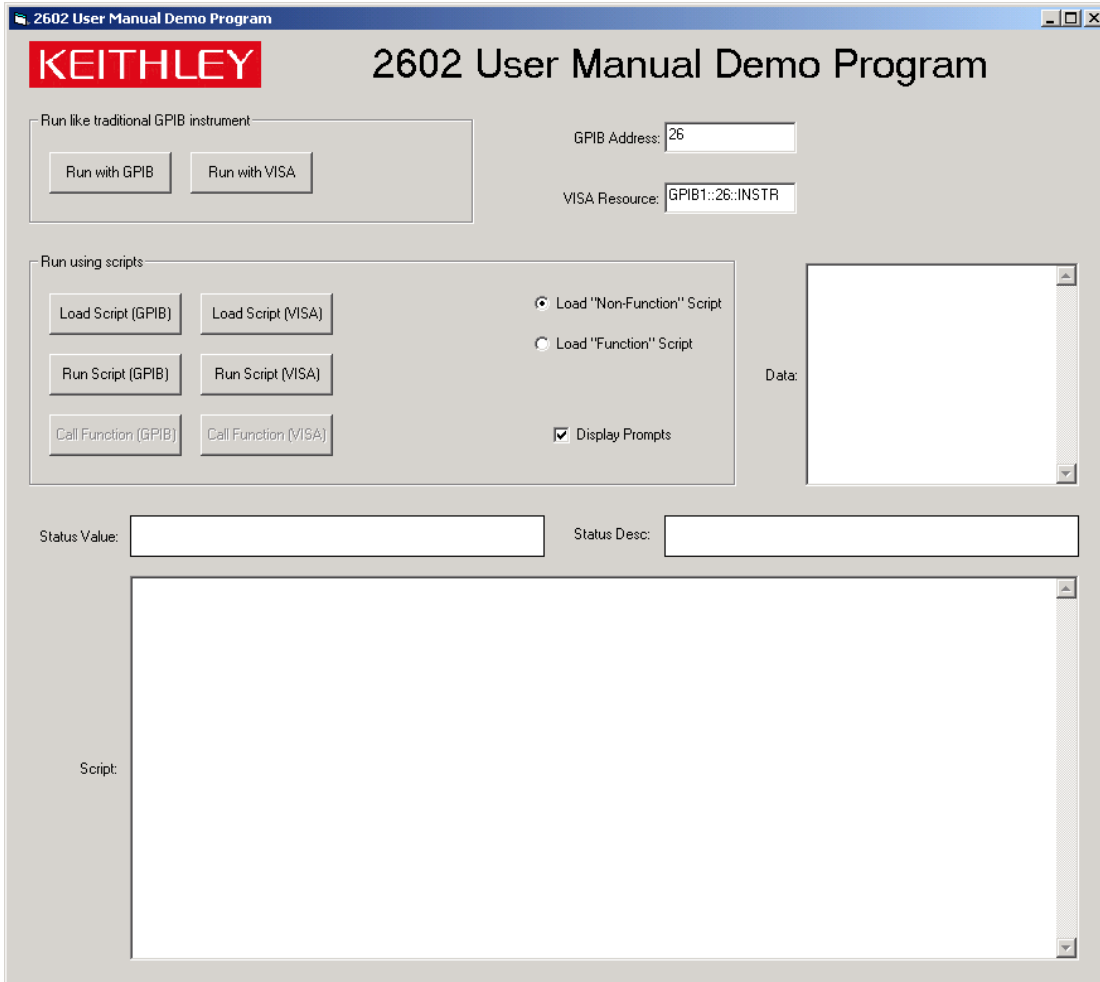

Using the Series 2600A as a traditional GPIB instrument

The following pseudocode describes how the Series 2600A will be configured and controlled to source voltage and measure current for this example. Some of the settings are default values restored by resetting the instrument, but they are included to show a typical setup and measure sequence that might be used for such a test.

1. Reset Series 2600A to default settings.
2. Set display to show SMU A source and limit settings.
3. Set display to show current measurement.
4. Set source function to DCV.

5. Enable source autorange.
6. Set source level to 5V.
7. Set current compliance to 100mA.
8. Set current measurement range to 100mA.
9. Set integration time to 1PLC.
10. Turn on SMU A output.
11. Measure the current and put reading in instrument output queue. This step is similar to using a SCPI "READ?" query to take a single reading.
12. Turn off SMU A output.

Command sequence

The commands that implement the pseudocode are listed below. The syntax for the "send" and "enter" commands is designed for a Keithley Instruments GPIB card. To use a Keithley Instruments GPIB card in Visual Basic, you must include the "ieeevb.bas" module in your project. This module is included on the CD that comes with your GPIB card.

When you click the **Run with GPIB** button on the GUI, the commands are sent to the Series 2600A and executed. The single reading returned by these commands is displayed in the Data text box as shown in [Figure 2-13](#).

NOTE Addr% is the GPIB address of the instrument and is assigned the value of 26.

```
Call send(Addr%, "localnode.prompts = 0", intStatus)
Call send(Addr%, "reset()", intStatus)
Call send(Addr%, "display.screen = display.SMUA", intStatus)
Call send(Addr%, "display.smua.measure.func = display.MEASURE_DCAMPS",
  intStatus)
Call send(Addr%, "smua.source.func = smua.OUTPUT_DCVOLTS", intStatus)
Call send(Addr%, "smua.source.autorangev = smua.AUTORANGE_ON", intStatus)
Call send(Addr%, "smua.source.levelv = 5", intStatus)
Call send(Addr%, "smua.source.limiti = 0.1", intStatus)
Call send(Addr%, "smua.measure.rangei = 0.1", intStatus)
Call send(Addr%, "smua.measure.nplc = 1", intStatus)
Call send(Addr%, "smua.source.output = smua.OUTPUT_ON", intStatus)
Call send(Addr%, "print(smua.measure.i())", intStatus)
Call send(Addr%, "smua.source.output = smua.OUTPUT_OFF", intStatus)
Call enter(strBuffer, 256, intNbytes, Addr%, intStatus)
txtData.Text = strBuffer
```

Using VISA

Clicking on the "Run with VISA" button will send the same commands to the Series 2600A using National Instruments® (NI) VISA. The VISA resource is for an instrument at address 26 connected to GPIB interface #1. Once again, a Keithley Instruments GPIB card was used for this example. However, VISA allows the same code to be used with GPIB cards made by other manufacturers, or with altogether different interfaces such as the RS-232 or the Ethernet.

Figure 2-13
Example program test results

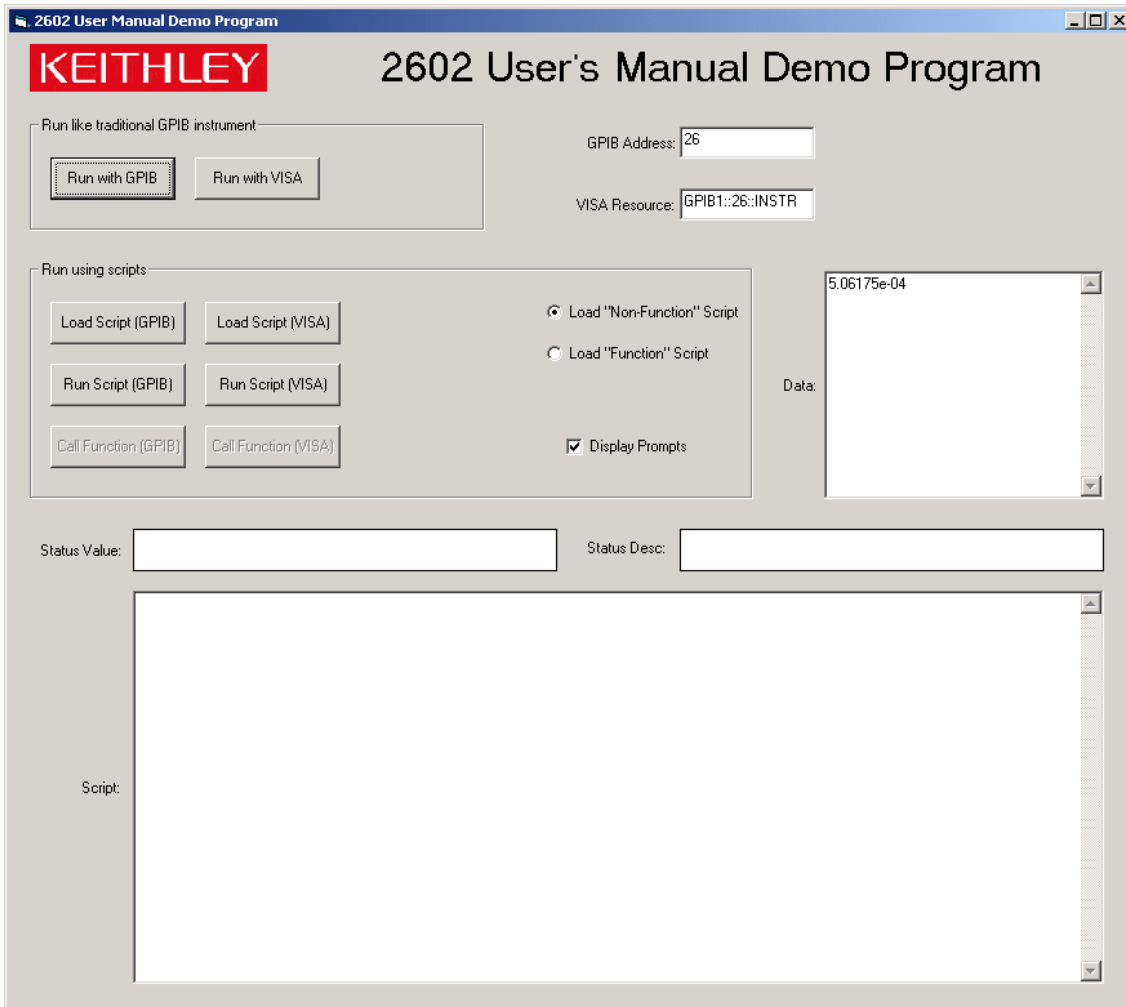

This page left blank intentionally.

Test Script Processor Interaction

In this section:

Topic	Page
What is a script?	3-2
Factory scripts	3-2
User scripts.....	3-2
How do I run a script from the front panel?	3-2
How do I interact with scripts using Test Script Builder?.....	3-4
Running a factory script.....	3-4
Modifying a factory script.....	3-6
Running the user script.....	3-11
Deleting a user script and user tests	3-12
How do I use other programs?	3-12
Using LabVIEW	3-12
Using Visual Basic	3-14

What is a script?

A script is a collection of instrument control commands and programming statements to perform one or more operations or tasks. A script is stored in a Series 2600A instrument and is run by its Test Script Processor (TSP).

Factory scripts

The Series 2600A is shipped from the factory with at least one factory script stored in its nonvolatile memory. Each factory script is made up of a series of functions to perform specific tests. A factory script function can be called (run) from the front panel or called using remote programming. A factory script cannot be deleted from nonvolatile memory.

User scripts

A user script is a script created by a user using the Test Script Builder or an external program. The user script is loaded in the Series 2600A and stored in volatile or nonvolatile memory. If stored in nonvolatile memory, the script will not be lost when the instrument is turned off.

Keithley Instruments will be posting approved user scripts donated by registered users on its web site. You will be able to download these user scripts into your Series 2600A. Visit www.keithley.com for details.

How do I run a script from the front panel?

Choose to run scripts from the following options:

- Factory
- Users
- Scripts

All factory script functions are interactive if accessed from the front panel. This means you must manually enter the parameters.

A user script can be non-interactive or interactive. A non-interactive script does not require user input.

NOTE If the Series 2600A is in remote operation, press the **LOCAL** key to return control to the front panel.

To run a script from the front panel:

In order to run a script from the front panel, an entry for the script needs to be added to the user menu for the **LOAD** key. The following commands are used to enter or delete a name into the user menu:

```
display.loadmenu.add(displayname, script)
display.loadmenu.delete(displayname)
```

Where: `displayname` is the name to be added to (or deleted from) the user menu and `script` is a string with the code that will be associated with the `displayname`.

It does not matter what order the items are added to the user menu. Menu items will be displayed in alphabetical order when the menu is selected.

Example:

Assume a user script named "Test9" has been loaded into the run-time environment. Add the name ("Test9") to the User menu for the script as follows:

```
display.loadmenu.add("Test9", "Test9()")
```

After adding a name to the User menu, the script can then be run from the front panel as follows:

1. Press the **LOAD** key to display the LOAD TEST menu.
2. Position the blinking cursor on the FACTORY or USER menu item and press the **ENTER** key or the **navigation wheel**. NOTE: The Series 2600A is shipped with no user scripts loaded.
3. Position the blinking cursor on the test to be run, and then press the **ENTER** key.
4. Press the **RUN** key to start the test.
5. Enter required test parameters using the front panel controls.

How do I save scripts to the USB flash drive?

The Series 2600A supports the standard USB 2.0 device interface. You can save data to the USB flash drive from the front panel while executing a script or from a remote interface.

Connecting the USB flash drive

To connect the USB flash drive, insert the USB flash drive into the USB connector, located on the front panel of the instrument.

Saving scripts to the USB flash drive

Complete the following steps to save a script to the USB flash drive from the front panel:

1. Press **MENU > SCRIPT** and then select **SAVE**.
2. Do one of the following:
 - Turn the **navigation wheel** to the left or to the right to select the script to be saved.
 - Push the **navigation wheel** or press the **ENTER** key to select the desired script from the list.
3. Press **USB1**.
4. (Optional) Use the **navigation wheel** to change the last three characters of the file name.
5. Press the **ENTER** key to save the script to the USB flash drive.

NOTE The message "Overwrite" is displayed if the file already exists.

How do I interact with scripts using Test Script Builder?

The following function for factory script “KIPulse” is stored in the nonvolatile memory of the Series 2600A:

```
PulseVMeasureI(smu, bias, level, ton, toff, points)
```

The above function performs a specified number of pulse V, measure I cycles:

- Sets the `smu` to output `bias` volts and dwell for `ton` seconds.
- Sets the `smu` to output `level` volts and dwell for `ton` seconds.
- Performs current measurement with the source at `level` volts.
- Sets the `smu` to output `bias` volts for `toff` seconds.
- Repeats the above sequence for `points` pulse-measure cycles.

Figure 3-1 shows one pulse-measure cycle for the function.

Figure 3-1

Pulse-measure cycle for the `PulseVMeasureI` function

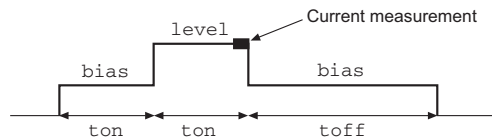

Running a factory script

NOTE All commands to run a factory script are to be executed from the Instrument Console of the Test Script Builder.

The following steps explain how to run the `PulseVMeasureI` function and read the data stored in the buffer.

NOTE The “KIPulse” factory script is an autorun script. The script runs automatically when the Series 2600A is turned on. The functions of the script are ready to be called.

Step 1: Call the function

The following are example parameters for the `PulseVMeasureI` function which will perform three pulse voltage, measure current cycles:

```
smu      SMU A
bias     -1V
level    1V
ton      1ms
toff     2ms
points   3
```

The following command will execute the `PulseVMeasureI` function using the above parameters:

```
PulseVMeasureI(smua, -1, 1, 1E-3, 2E-3, 3)
```

Step 2: Read the buffer

The above function stores the three current measurements in the reading buffer (`smua.nvbuffer1`). Also stored in the buffer are the voltage source settings and timestamps for the measurements. The timestamps (in seconds) are referenced to the start of the test. The timer for the timestamps starts at zero seconds when the test is started.

The `printbuffer` function is used to print (output) measured readings, timestamps and/or source values stored in the buffers.

Print readings: The following code will return the three measured current readings stored in `nvbuffer1`:

```
rb1 = smua.nvbuffer1
printbuffer(1, rb1.n, rb1)
Example output: 1.234567e-03, 2.362360e-03, 2.362368e-03
```

For the above `printbuffer` function, 1 is the starting index for values to print, `rb1.n` is the ending index (for this function, `n = 3`), and `rb1` is the reading buffer (`smua.nvbuffer1`).

Print time stamps: The following command will print the time stamps for the three measured current readings:

```
printbuffer(1, rb1.n, rb1.timestamps)
Example output: 5.555555e-02, 8.888888e-02, 1.111111e-01
```

Print source values: The following command will print the voltage source values for the three measured current readings:

```
printbuffer(1, rb1.n, rb1.sourcevalues)
Output: 1.000000e+00, 1.000000e+00, 1.000000e+00
```

Print readings, time stamps, and source values: The following command will return the three sets of data (nine values) in the same message:

```
printbuffer(1, rb1.n, rb1, rb1.timestamps, rb1.sourcevalues)
Example output:
1.234567e-03, 5.555555e-02, 1.000000e+00, 2.362360e-03, 8.888888e-02,
1.000000e+00, 2.362368e-03, 1.111111e-01, 1.000000e+00
```

The above output is returned in the following order:

reading1, timestamp1, sourcevalue1, reading2, timestamp2, sourcevalue2, reading3, timestamp3, sourcevalue3

Calling a function without parameters

When the command to call a script function is sent without parameters, input value fields and messages will appear on the display to prompt the operator to input the parameters using the front panel controls.

The following command will call the `SourceVMeasureI` function and then require operator interaction:

```
PulseVMeasureI()
```

After sending the above command, the Series 2600A display will prompt the operator to input the following parameters from the front panel:

- Enter BIAS voltage.
- Enter PULSE (level) voltage.
- Enter pulse ON time.

- Enter pulse OFF time.
- Enter number of pulses (points).

After the operator keys in each parameter and presses the **ENTER** key (or the **navigation wheel**), the display will proceed to the next input prompt. After the last parameter (number of pulses) is entered, the test will continue.

The following message will be displayed when the test is finished:

```
PulseVMeasureI
```

```
Test complete.
```

Modifying a factory script

A factory script can be imported from the Series 2600A into the Test Script Builder where it can be modified. The modified script can then be loaded back into the Series 2600A and saved as a user script.

The following procedure will import the KIGeneral factory script into the Test Script Builder, modify code for the `SourceVMeasureI` function, load the script in the Series 2600A as a user script under a different name, and then configure the test to call the `SourceVMeasureI` function.

Step 1: Importing a factory script project

A factory script project is made of many executable functions. The `SourceVMeasureI` function is one of the functions that make up the KIGeneral factory script that is stored in the Series 2600A.

[Figure 3-2](#) shows how to import the KIGeneral factory script project from the Series 2600A into the Test Script Builder. After importing the script, the project will appear as a folder in the Project Navigator with a script file named “main.tsp” (see [Figure 3-3](#)).

Figure 3-2
Importing a factory script project from the Series 2600A

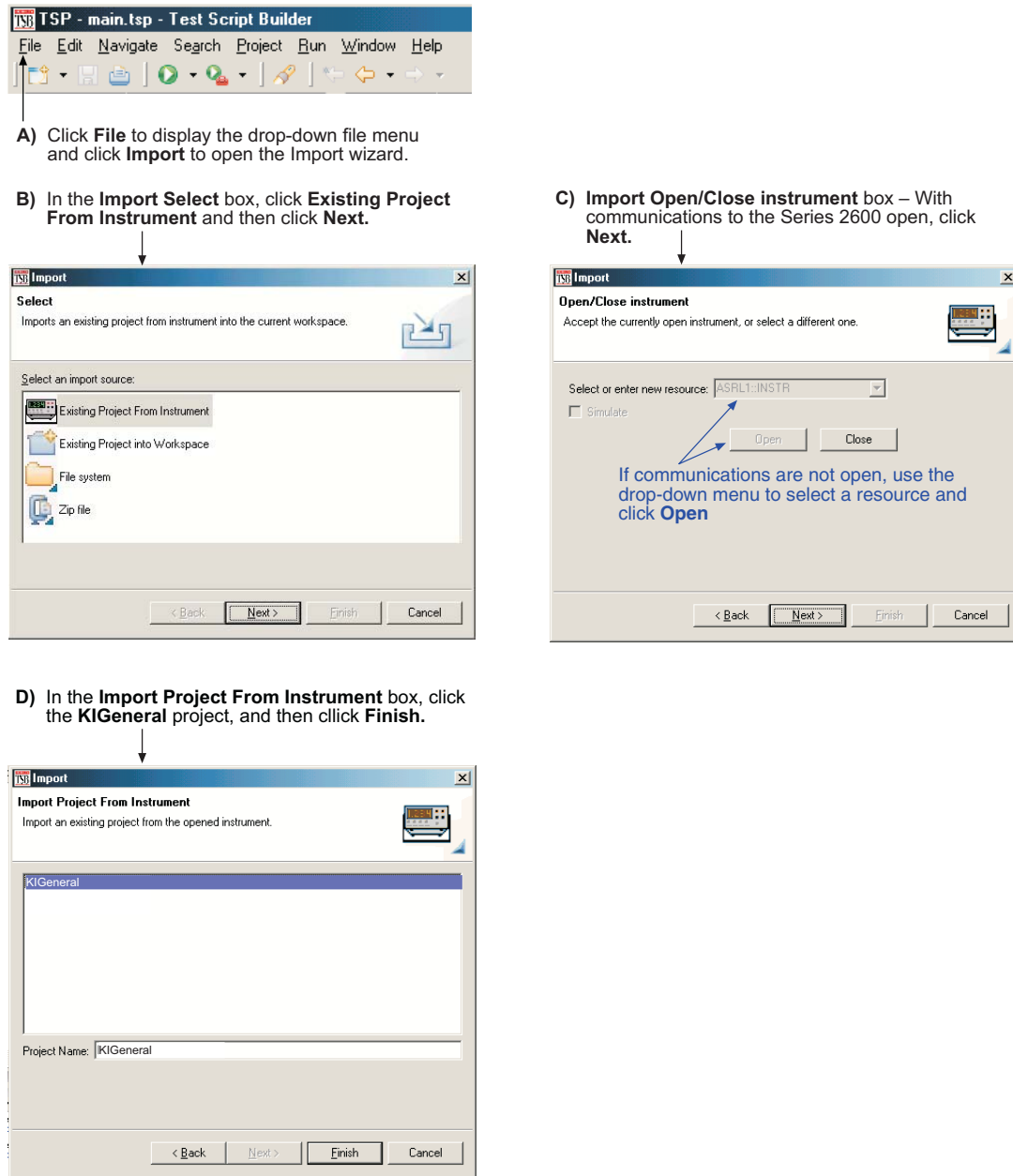

Step 2: Modifying the test code for the SourceVMeasureI function

As shown in [Figure 3-3](#), the test code for the script functions is contained in the tab for the “main.tsp” script file. The test code for all of the functions of the KIGeneral factory script are in this tab. Use the scroll buttons on the right side of the tab to view more code.

Editing example

The following line of code in the “main.tsp” script file applies to the SourceVMeasureI function:

```
bias = display.prompt("+00.000", " Seconds", "Enter BIAS Voltage.", 0, -40,
                    40)
```

The above command defines a display input field and message prompt for entering the bias voltage. The `-40` parameter sets the minimum voltage that can be entered, and the `40` parameter sets the maximum voltage that can be entered.

Now assume you wish to change the bias input limits to $\pm 10V$. Edit the line of code to the following:

```
bias = display.prompt("+00.000", " Seconds", "Enter BIAS Voltage.", 0, -10,
                    10)
```

Saving the script: After modifying the script file, it must be saved by clicking the save icon on the toolbar of the Test Script Builder as follows:

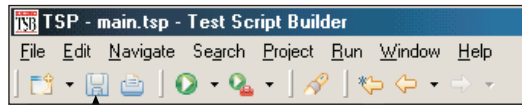

Click to save the "main.tsp" script file

Figure 3-3
KIGeneral project imported into the Test Script Builder

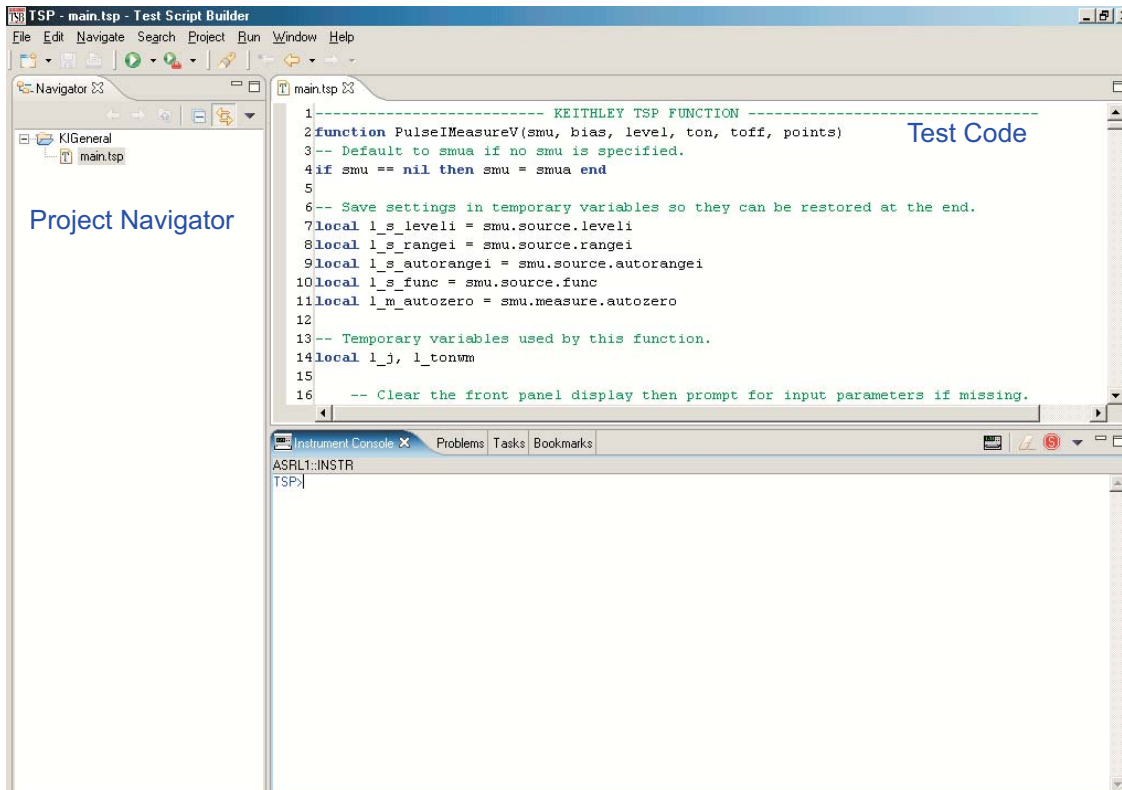

Step 3: Storing the script in nonvolatile memory of the Series 2600A

After modifying a factory script, it can be loaded back into the Series 2600A and saved in nonvolatile memory as a user script.

1. The **Run** configuration box is used to launch (load) a user script into the Series 2600A and save it in nonvolatile memory. As shown below, open the **Run** box and then click **Run** in the drop-down menu:

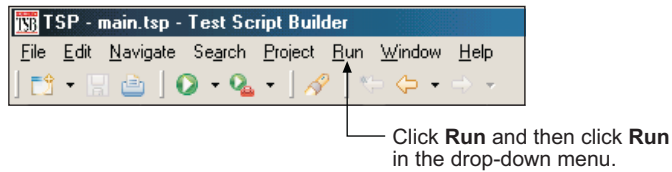

NOTE [Figure 3-4](#) and [Figure 3-5](#) show how the Run box will look after the launch is configured.

2. In the Configurations area of the Run box, select the KIGeneral script. The launch configuration tabs for that script will appear in the Run box.
3. Presently, the name of the script is KIGeneral. You should change the name so the script is not confused with the factory script of the same name that is stored in the Series 2600A. For example, change the script Name to "KIGeneralUser" and click the **Apply** button.
4. As shown in [Figure 3-4](#), the main.tsp file must be in the Load Order area of the Run box. If it is in the Available Project Files area, double-click main.tsp to move the file over.
5. Click the **Script Attributes** tab to display the load and store options and select the **LoadOnly** run action and nonvolatile storage as shown in [Figure 3-5](#).
6. Click the **Apply** button to set the run configuration.
7. Click the **RUN** key to load the user script into nonvolatile memory of the Series 2600A.

NOTE There is a small bar graph at the bottom-right of the Test Script Builder that will appear while a script is loading. The bar graph will continuously sequence through its segments while the script is loading.

Figure 3-4
Run configuration example - Main tab shown

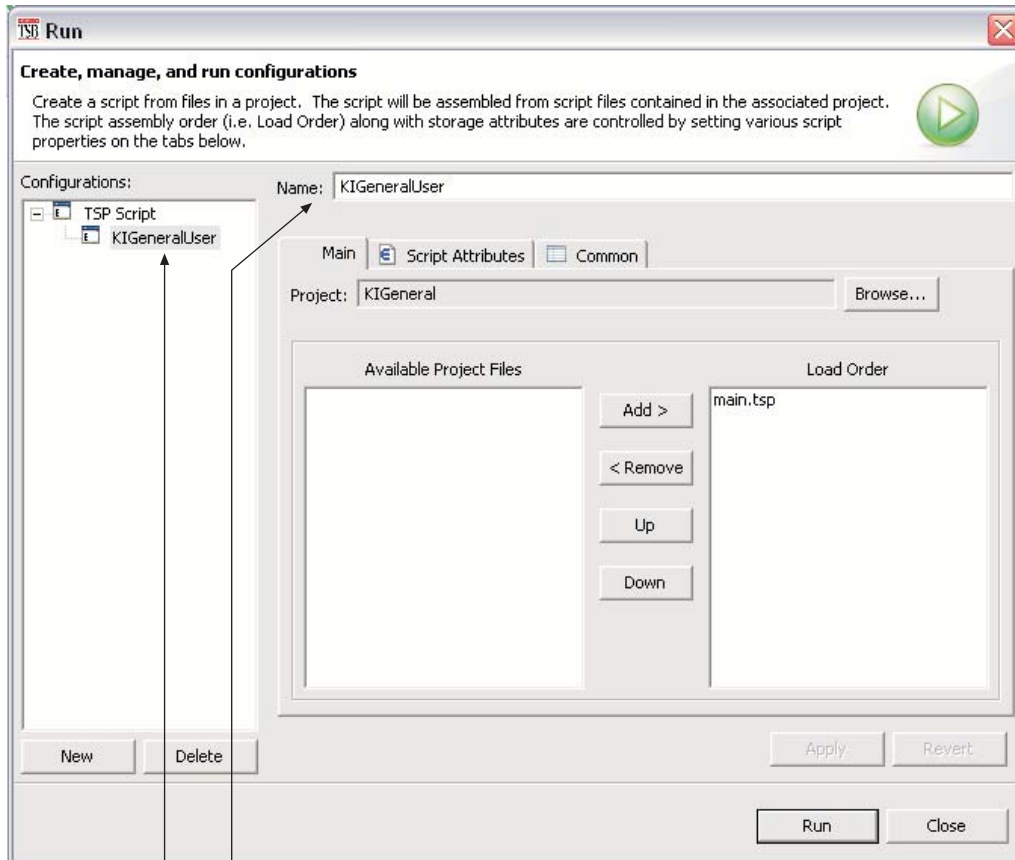

Changing the script **Name** from **KIGeneral** to **KIGeneralUser** also changes the name in the **Configurations** area.

Figure 3-5
Run configuration example - Script Attributes tab shown

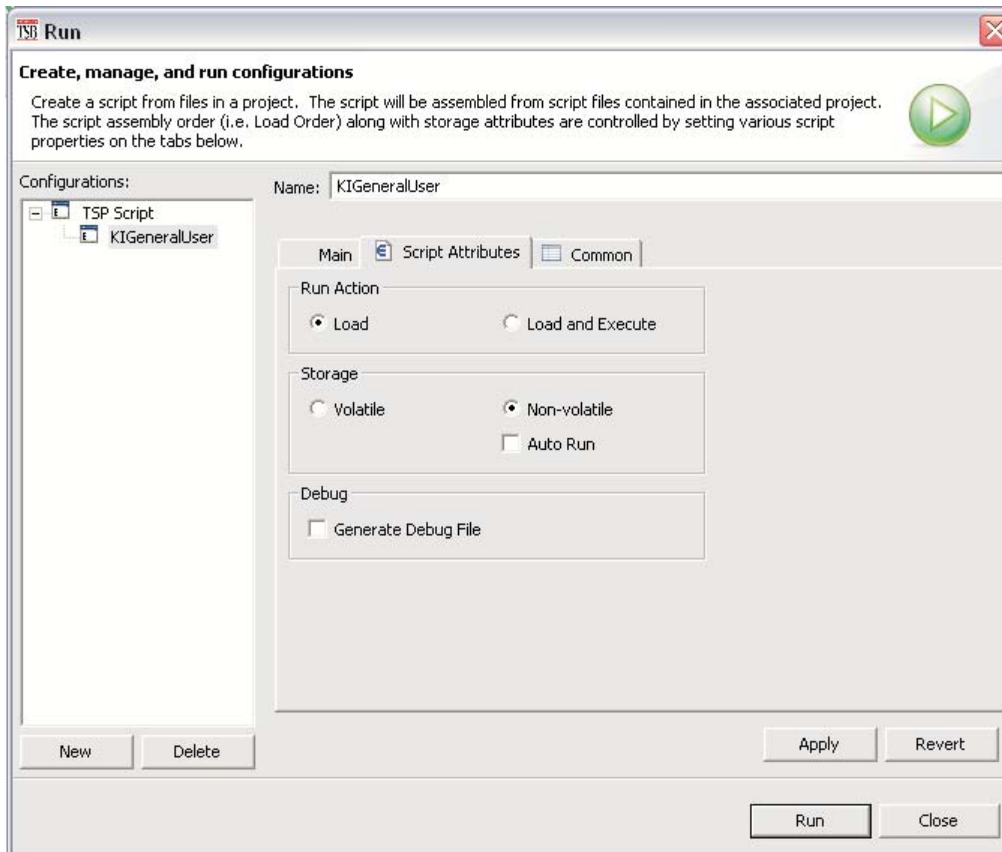

Running the user script

Remote programming

The functions for the KIGeneralUser user script can be called after the script is run as follows:

```
KIGeneralUser()
```

After the above command is executed, any of the functions that make up the user script can be called in the same manner that factory script functions are called (see [Step 1: Call the function](#)).

Front panel operation

To run the script from the front panel, a test name has to be added to the **USER TESTS** submenu of the **LOAD TEST** menu. Since the KIGeneralUser script is made up of eight functions, a front panel user test must run the script and also call a function. The following command will add the test name "PulseVMeasI" to the menu. It will also configure the test to run the KIGeneralUser script and call the PulseVMeasureI function:

```
display.loadmenu.add("PulseVMeasI", "KIGeneralUser() PulseVMeasureI()",  
display.SAVE)
```

Because no parameters are used in the function (PulseVMeasureI()), the test will be interactive and require the operator to input the test parameters using the front panel controls. See [How do I run a script from the front panel?](#) for details on running a user script from the front panel.

The command `display.loadmenu.add` can be used to configure front panel user tests for the other functions of the script. Make sure to use a different menu name for each function. For

example, the following command will add the name "PulseI MeasV" for a test to call the `PulseI MeasureV` function.

```
display.loadmenu.add("PulseI MeasV", "KIGeneralUser() PulseI MeasureV()",  
display.SAVE)
```

Deleting a user script and user tests

Deleting a user script

A user script can be deleted from nonvolatile memory of the Series 2600A. The following command will delete the `KIGeneralUser` user script:

```
script.delete("KIGeneralUser")
```

Deleting a user test

After deleting a script, you should also delete the test from the USER TESTS menu since it no longer exists. The following command deletes the "PulseV MeasI" test from the menu:

```
display.loadmenu.delete("PulseV MeasI")
```

How do I use other programs?

NOTE See the LabVIEW and Visual Basic documentation for details on using those programs.

Using LabVIEW

Source step example

The source step example is shown in [Figure 3-6](#). The example steps the source voltage from 1V to 10V in 1V steps, measures the current at each step, and stores the result in a table. Once all steps are completed, the stored table current values are printed.

The Series 2600A command sequence:

```

localnode.prompts = 0
data_table = {}
reset()
smua.source.output = 1
for i=1,10 do
  smua.source.levelv = i
  mi = smua.measure.i()
  table.insert(data_table,mi)
end
smua.source.output = 0
print(table.concat(data_table,','))
reset()
    
```

-- Disable prompts.
-- Clear table.
-- Reset Series 2600A.
-- Turn on source output.
-- Loop for 10 steps.
-- Set source level.
-- Take a current measurement.
-- Store measurement in table.
-- End of loop.
-- Turn off output.
-- Print table of current values.
-- Reset instrument.

Figure 3-6
LabVIEW source step example

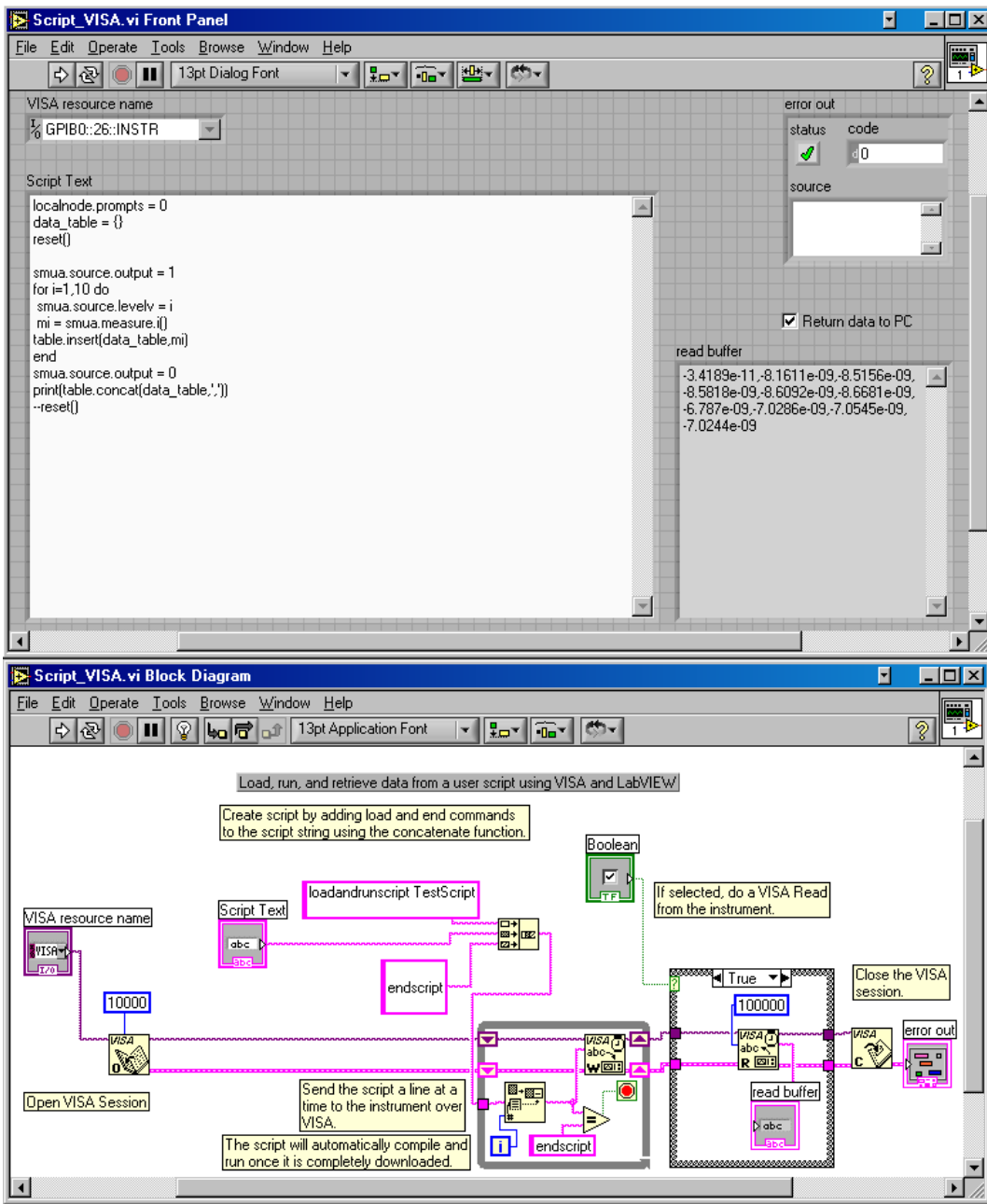

Using Visual Basic

NOTE The form file (UserManualExample.frm) can be opened using any text editor to view the code executed by the various command buttons.

The following examples look at how you can download and run Model 2600A Series scripts using Visual Basic. Two scripts were created for these examples. Both scripts are based on the pseudocode and instrument commands presented in [Section 2](#) on using the Series 2600A as a traditional GPIB instrument while they perform multiple measurements. Source code for this example program can be downloaded from the Keithley Instruments internet site, www.keithley.com.

Example script 1: script that does not use functions

The following script is in the file named "MeasCurrScript.tsp." Note that the actual script contains additional comments, which have not been included here. Comments are identified by double dashes (--).

```

reset()
display.screen = display.SMUA
display.smua.measure.func = display.MEASURE_DCAMPS
smua.source.func = smua.OUTPUT_DCVOLTS
smua.source.autorangev = smua.AUTORANGE_ON
smua.source.levelv = 5
smua.source.limiti = 0.1
smua.measure.rangei = 0.1
smua.measure.nplc = 1
smua.source.output = smua.OUTPUT_ON
ntimes = 10
for i = 1, ntimes do           -- Perform following command(s) ntimes.
    print(smua.measure.i())   -- Measure current and put reading in out-
put queue.
end --for
smua.source.output = smua.OUTPUT_OFF

```

The primary code that reads the file and downloads the script to the Series 2600A is listed below. This code is executed when you select the **Load "Non-Function" Script** option, and then click the **Load Script (GPIB)** command button. Although not required, TSP prompts are enabled for this example because they provide useful test script processor status information when loading and running scripts. See the Series 2600A Reference Manual for more information about using prompts. As the script is being downloaded, it is displayed in the **Script** text box of the GUI (Graphical User Interface), as shown in [Figure 3-7](#).

<pre> Call send(Addr%, "localnode.showerrors = 0", intStatus) </pre>	<pre> 'Disable automatic display of errors 'leave error messages in queue and 'enable Error Prompt. The "localnode" is 'unit being communicated with via GPIB 'or RS-232. </pre>
<pre> Call send(Addr%, "localnode.prompts = 1", intStatus) strReturnMessage = udfGetTspResponse() Open App.Path & "\" & "MeasCurrScript.tsp" For Input As #1 Call send(Addr%, "loadscript MeasCurrScript", intStatus) strReturnMessage = udfGetTspResponse() </pre>	<pre> 'Turn on prompts; need to start 'handling the prompts as soon as this 'command is sent. 'Open the script file for sequential 'input. '"loadscript" identifies the beginning 'of the script. "MeasCurrScript" is the 'name assigned to the script. </pre>
<pre> Do While Not EOF(1) Line Input #1, strScriptline Call send(Addr%, strScriptline, intStatus) strReturnMessage = udfGetTspResponse() strReturnMessage = Left(strReturnMessage, 4) Select Case strReturnMessage Case ">>>>" Case "TSP>" Exit Do Case "TSP?" Case Else End Select Loop Close #1 Call send(Addr%, "endscript", intStatus) strReturnMessage = udfGetTspResponse() Call send(Addr%, "localnode.prompts = 0", intStatus) </pre>	<pre> 'Read the file. 'Loop until the end of the script file. 'Read a line from the script file. 'Send script line to Series 2600A. 'Continuation prompt. 'TSP received script line successfully; 'waiting for next line. 'Ready prompt. 'TSP received script successfully; 'ready for next command. 'Error prompt. 'Error occurred; handle as desired. 'Use "errorqueue" commands to read 'and clear errors. 'No prompt received. 'Response other than shell prompt was 'received; handle as desired. 'Close the script file. 'Tell TSP complete script has been 'downloaded. 'Disable prompts. </pre>

Figure 3-7
GUI after loading the non-function script (GPIB)

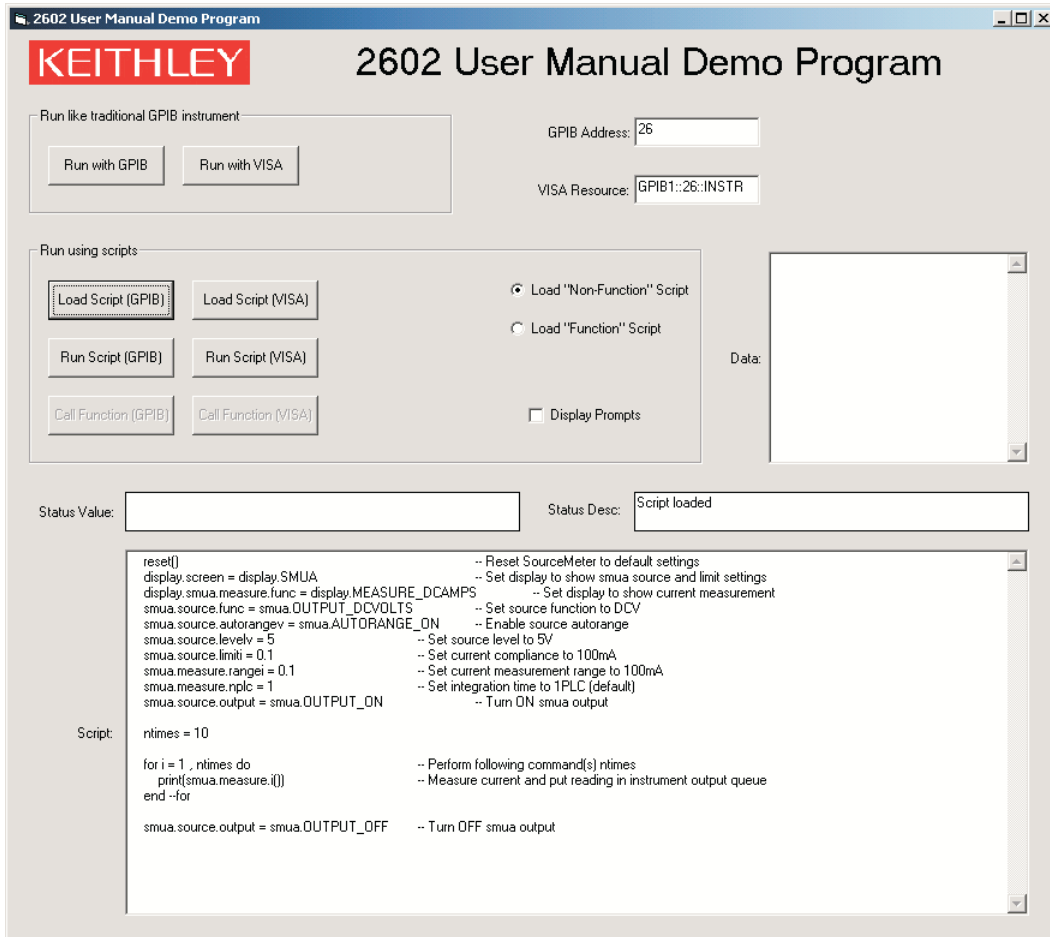

The primary code that runs the script and retrieves the measurement results is listed below. This code is executed when you click the **Run Script (GPIB)** command button. When you run this script it will perform ten measurements and send the readings to the PC. The results are displayed in the **Data** text box of the GUI as shown in [Figure 3-8](#). TSP prompts are enabled prior to running the script.

```
Call send(Addr%, "MeasCurrScript.run()", intStatus) 'The following command runs
                                                    'the script; you can also
                                                    'use MeasCurrScript() form of
                                                    'the command.
```

```
Do
strReturnMessage = udfGetTspResponse()
  txtData.Text = txtData.Text & strReturnMessage
Loop Until Left(strReturnMessage, 3) = "TSP"
If strReturnMessage = "TSP?" Then
  txtStatusDesc.Text = "Error Occurred"
  Call send(Addr%, "print(errorqueue.next())",
intStatus)
  strReturnMessage = udfGetTspResponse()
  txtStatusDesc.Text = txtStatusDesc.Text & strRe-
turnMessage & vbCrLf
```

```
End If 'Get output from script.
```

Figure 3-8
GUI after running the non-function script (GPIB)

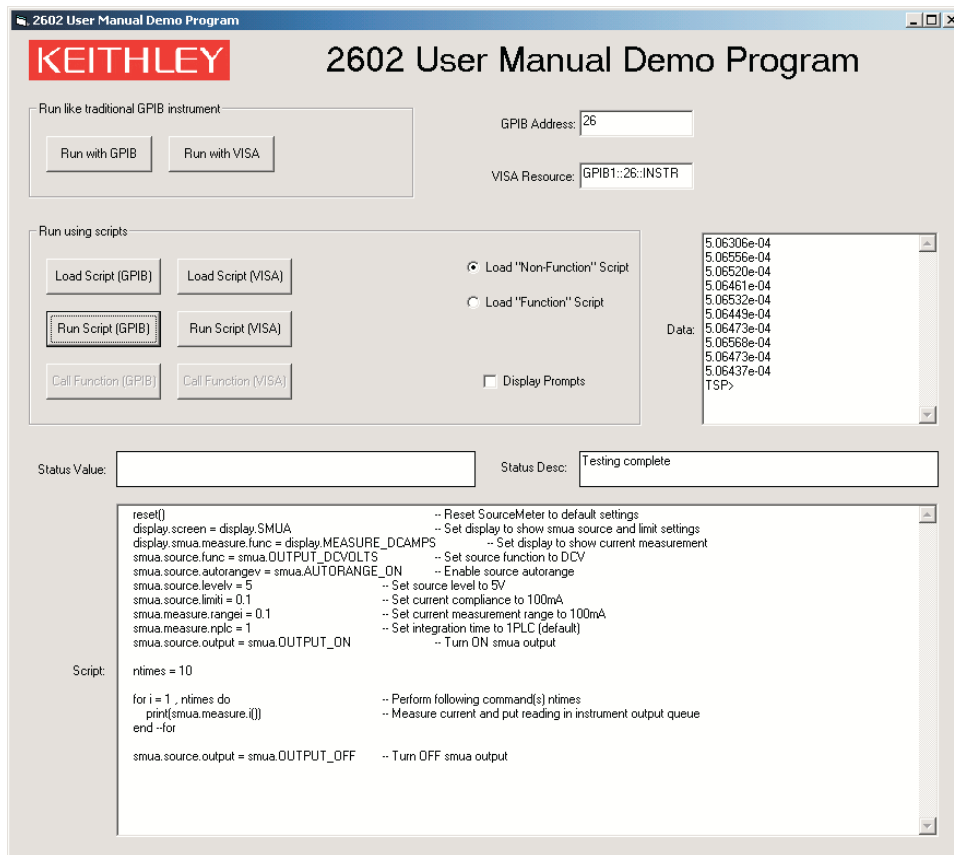

Example script 2: script that uses functions

The script used in this example is in the file named “MeasCurrFunctionScript.tsp.” This script is downloaded to the Series 2600A by selecting the **Load “Function” Script** option, and then clicking the **Load Script (GPIB)** command button. The script is downloaded exactly as shown in the previous example, except the “open file” and “loadscript” commands reflect the different script name as shown below.

```
Open App.Path & "\" & "MeasCurrFunctionScript.tsp" For Input As #1
Call send(Addr%, "loadscript MeasCurrFunctionScript", intStatus)
```

The other difference is in the script itself, which is listed below. This script does not perform multiple current measurements, but rather it creates a function named “MeasCurr,” which performs one or more current measurements when it is called. The number of measurements depends on the value of “ntimes,” which is passed to the function when it is called. [Figure 3-9](#) shows the GUI (Graphical User Interface) after loading and running the script. Note that the **Data** text box does not contain any readings as in the previous example; it simply indicates that the “MeasCurr(ntimes)” function has been created.

```
function MeasCurr(ntimes)
    local l_i -- Local counter variable
    reset()
    display.screen = display.SMUA
    display.smua.measure.func = display.MEASURE_DCAMPS
    smua.source.func = smua.OUTPUT_DCVOLTS
    smua.source.autorangev = smua.AUTORANGE_ON
```

```

smua.source.levelv = 5
smua.source.limiti = 0.1
smua.measure.rangei = 0.1
smua.measure.nplc = 1
smua.source.output = smua.OUTPUT_ON
for l_i = 1, ntimes do
    print(smua.measure.i())
end --for
smua.source.output = smua.OUTPUT_OFF
end --function
print("Function 'MeasCurr(ntimes)' created")

```

Figure 3-9
GUI after loading and running the function script (GPIB)

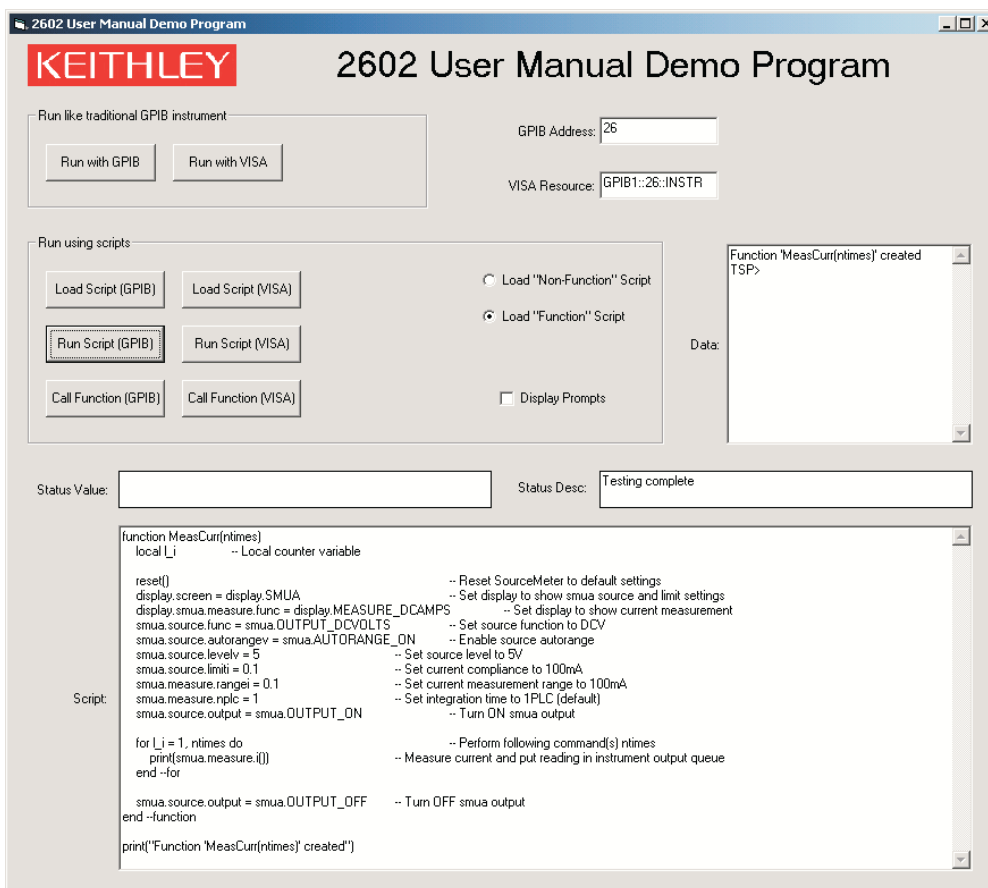

The primary code that calls the function and retrieves the measurement results is listed below. TSP prompts are enabled prior to calling the function. This code is executed when you click the Call Function (GPIB) command button. In this example, the function performs ten current measurements and sends the readings to the PC because “*ntimes*” is set to 10 when the function is called. The results are displayed in the data text box as shown in Figure 3-10. Note that it would be just as easy to take one or 100 readings simply by calling the function with a different value for “*ntimes*,” for example, `MeasCurr(100)`. You can pass parameters to a function, but not to a script. However, you must initially run a script to create a function. See the Series 2600A Reference Manual for more information.

```

Call send(Addr%, "MeasCurr(10)", intStatus)

Do
  strReturnMessage = udfGetTspResponse()
  txtData.Text = txtData.Text & strReturnMessage &
  vbCrLf
Loop Until Left(strReturnMessage, 3) = "TSP"
If strReturnMessage = "TSP?" Then
  txtStatusDesc.Text = "Error Occurred"
  Call send(Addr%, "print(errorqueue.next())", intStatus)
  strReturnMessage = udfGetTspResponse()
  txtStatusDesc.Text = txtStatusDesc.Text &
  strReturnMessage & vbCrLf
End If

```

'Call function with
'ntimes=10 and then
'enter data.
'Get output from
'function.

'Take appropriate
'action based on
'error message.

Figure 3-10
GUI after calling the function (GPIB)

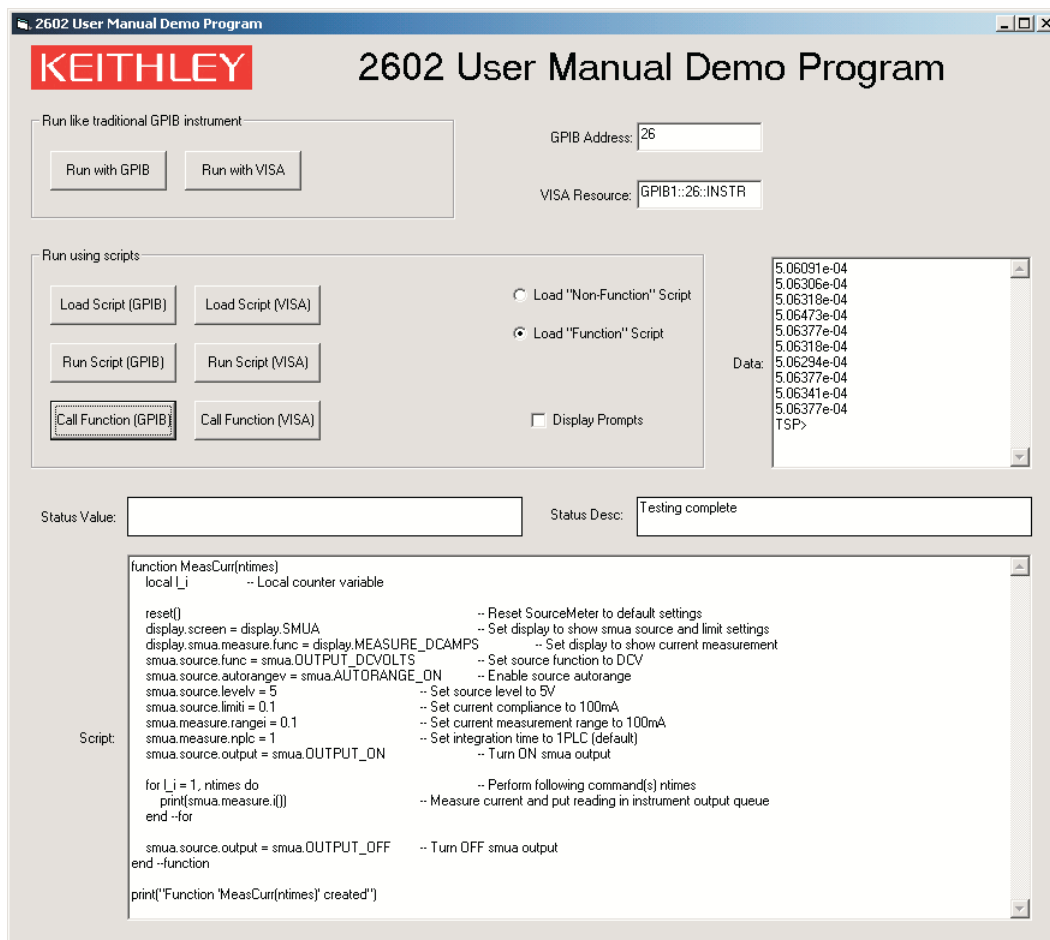

This page left blank intentionally.

Controlling Multiple Series 2600As (TSP-Link)

In this section:

Topic	Page
How do I set up the TSP-Link system?.....	4-2
Connect the TSP-Link system.....	4-2
Assign node numbers.....	4-2
Reset the TSP-Link	4-3
Check the state of the TSP-Link system	4-3
How do I use the expanded system?	4-3
Accessing resources of TSP-Link nodes.....	4-3
Running scripts in a TSP-Link system.....	4-4

How do I set up the TSP-Link system?

Up to 32 TSP-Link enabled instruments (for example, Series 2600A System SourceMeter™ instruments) can be connected together to form a TSP-Link system.

Step 1: Connect the TSP-Link system

A connection example for an expanded system is shown in [Figure 4-1](#). All the TSP-Link-enabled instruments in the system are daisy-chained together using LAN crossover cables. In this example, the unit connected to the PC is the Master and the other units are its Slaves. Note that the Master does not have to be assigned as Node 1, nor does it have to be at the end of the node chain.

Figure 4-1
TSP-Link connections

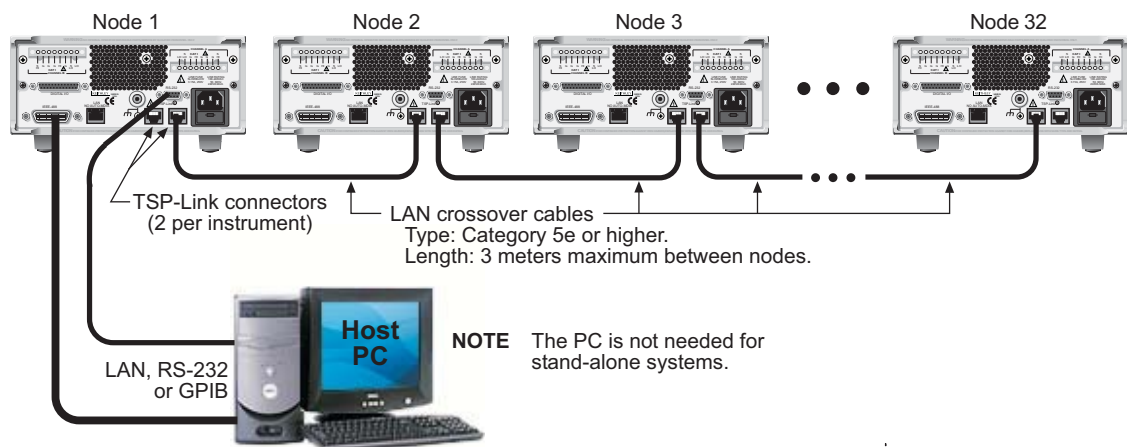

Step 2: Assign node numbers

Each instrument in the TSP-Link system must have a unique node number assigned to it. The node number for each instrument is stored in its nonvolatile memory and will not be lost when the instrument is turned off.

Complete the following steps to assign a node number.

1. From the front panel, press the **MENU > TSPLINK**.
2. Select **NODE** and then use the **navigation wheel** to assign the node number.
Note: The node number can range from 1 - 64.

For remote programming, the `tsplink.node` attribute is used to set the node number for an instrument:

```
tsplink.node = N
```

Where: $N = 1$ to 64. The node number of an instrument can be determined by reading the `tsplink.node` attribute as follows:

```
nodenumber = tsplink.node
print(nodenumber)
```

The above `print` command will return the node number. For example, if the node number is 1, the value `1.000000e00` will be returned.

Step 3: Reset the TSP-Link

After all the node numbers are set, you must reset (initialize) the TSP-Link interface system. For initialization to succeed, all units must be powered on when the TSP-Link reset is performed.

Complete the following steps to reset the TSP-Link.

1. From the front panel, press **MENU > TSPLINK**.
2. Choose **Reset**.

For remote programming, the following command initializes the TSP-Link:

```
tsplink.reset()
```

Step 4: Check the state of the TSP-Link system

The `tsplink.state` read-only attribute is used to verify that the TSP-Link reset routine was completed successfully. The returned value `online` indicates that the reset was successful for all instruments (nodes) in the system. The value `offline` indicates that the reset has failed.

A few typical reasons for a reset failure include the following:

- Two or more instruments in the system have the same node number.
- There are no other instruments connected to the unit performing the reset.
- One of the units in a properly-connected system is not powered on.

Programming example: After assigning node numbers to the instruments in the system, the following command checks the state of the TSP-Link:

```
print(tsplink.state)
```

If the reset is successful, `online` will be the output to indicate that communication to all nodes is established.

How do I use the expanded system?

Accessing resources of TSP-Link nodes

After a successful TSP-Link reset, the `node` and `localnode` variables can be used to access resources of any node in the system.

Using node[N]

The `node[N]` variable (where `N = 1 to 64`) is used to send a command to any node in the system. The node can be the master or a slave. Examples:

```
node[4].smua.reset()           -- Resets SMU A of Node 4.
node[1].smua.reset()           -- Resets SMU A of Node 1.
```

Using the alias (localnode)

The variable `localnode` is an alias for `node[N]`, where `N` is the node number of the node executing the command.

For example, assume that node 1 is the master in a TSP-Link system. To send a command to node 1, you can use `node[1]` or `localnode` as follows:

```
-- Resets SMU A of the Master (Node 1).
node[1].smua.reset()
-- Resets SMU A of the Master (Node 1).
localnode.smua.reset()
```

Running scripts in a TSP-Link system

Refer to the Series 2600A Reference Manual for more information on running scripts in parallel on a TSP-Link system.

Frequently Asked Questions

In this appendix:

Topic	Page
How do I optimize performance?	A-2
Setting speed	A-2
Disabling auto zero to increase speed	A-2
How do I use the Digital I/O port?	A-3
Digital I/O port terminals	A-3
Controlling the digital I/O port	A-3
How do I trigger other instruments?	A-3
Triggering a scanner	A-3
Programming triggering	A-4
How do I generate a service request?	A-4
Setting up a service request	A-4
Service request programming example	A-4
Polling for SRQs	A-5
How do I store measurements in nonvolatile memory?	A-5
Front panel operation	A-5
Remote programming	A-5
How do I stack channels to output higher voltage?	A-6
How do I parallel channels to output higher current?	A-7
How do I make contact check measurements?	A-8
Contact check connections	A-8
Model 2601A/2602A/2611A/2612A contact check connections	A-8
How do I make low-current measurements?	A-9
Low-current connections	A-9
Low-current measurement programming example	A-10

NOTE Visit the Keithley Instruments website at www.keithley.com for more information on Frequently Asked Questions.

How do I optimize performance?

There are three primary factors that affect measurement accuracy and speed:

- Warm-up: For rated measurement accuracy, allow the Series 2600A to warm up for at least two hours before use.
- Speed setting: The Speed setting affects both speed and accuracy.
- Auto zero: Auto zero can be disabled to increase speed at the expense of accuracy.

Setting speed

Press the **SPEED** key, then choose the setting based on your requirements:

- Choose the **FAST** setting for the fastest measurements, but measurement accuracy will be reduced.
- For best accuracy, use the **HI-ACCURACY** setting, but speed will be reduced.
- To compromise between accuracy and speed, use the **MED** or **NORMAL** setting.

Disabling auto zero to increase speed

In certain measuring situations, disabling auto zero can increase measurement speed, but accuracy will drift with time and temperature. To disable auto zero, select **CONFIG > MEAS > AUTO-ZERO**, then set to **OFF**. To minimize drift with auto zero disabled, use the **ONCE** selection just before measuring.

How do I upgrade the firmware?

You can use a USB flash drive to upgrade and install the firmware.

CAUTION Disconnect the input and output terminals before you upgrade the flash drive.

Complete the following steps to upgrade the firmware.

1. From your PC, go to www.keithley.com and download the latest version of the appropriate firmware.
2. Insert the USB flash drive into the USB port on your PC.
3. Transfer the firmware file to the USB flash drive.
4. Insert the USB flash drive into the USB port on the front panel of the Series 2600A instrument.
5. From the front panel, press **MENU > UPGRADE**.
6. Select the appropriate version of firmware on the USB flash drive.
7. Press the **ENTER** key to finish the firmware upgrade on the Series 2600A.

CAUTION Do not turn the unit off while an upgrade is in progress.

How do I use the Digital I/O port?

Digital I/O port terminals

The Digital I/O port, located on the rear panel (see [Figure 1-2](#)), provides 14 digital I/O lines ([Figure A-1](#)). Each output can be set high (+5V) or low (0V), read high or low logic levels, and can be set up for triggering. Make connections using a cable with a Male DB-25 connector (Keithley Instruments part number CA-126-1).

Figure A-1
Digital I/O port terminals

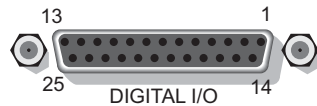

1 = Digital I/O #1	11 = Digital I/O #11
2 = Digital I/O #2	12 = Digital I/O #12
3 = Digital I/O #3	13 = Digital I/O #13
4 = Digital I/O #4	14 = Digital I/O #14
5 = Digital I/O #5	15-21 = Ground
6 = Digital I/O #6	22 = +5V
7 = Digital I/O #7	23 = +5V
8 = Digital I/O #8	24 = Output Enable (OE); 2601/2602
9 = Digital I/O #9	24 = Interlock (INT); 2611/2612/2635/2636
10 = Digital I/O #10	25 = +5V

Controlling the digital I/O port

From the front panel, select **MENU > DIGOUT > DIG-IO-OUTPUT**, then enter the decimal value to set I/O lines high or low (16,383 maximum). Commands for basic I/O are summarized in [Table A-1](#). For example, to set all 14 lines high, send:
`digio.write.port(16383).`

Table A-1
Commands for basic I/O port

Command	Description
<code>digio.readbit(bit)</code>	Read one digital I/O input line.
<code>digio.readport()</code>	Read digital I/O port.
<code>digio.writebit(bit, data)</code>	Write data to one digital I/O output line.
<code>digio.writeport(data)</code>	Write data to digital I/O port.

How do I trigger other instruments?

Triggering a scanner

A typical test scenario might call for using the Series 2600A with a scanner to test a number of DUTs in sequence. A basic example that uses the Series 2600A Digital I/O port to trigger a scanner is shown in [Figure A-2](#). In this case, line 1 of the I/O port is used as a trigger output and connected to the scanner mainframe trigger input, while line 2 of the I/O port is used as a trigger input.

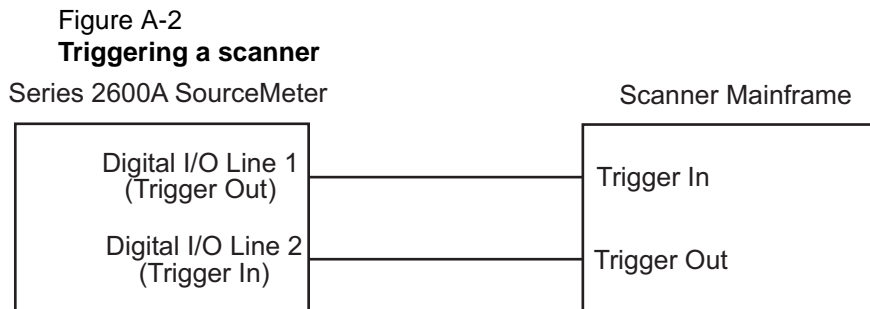

Programming triggering

A simple command sequence that sets up triggering is shown below. The first two commands set the output pulse width on line 1 and program line 2 for falling edge input triggers. The second two commands assert and then wait for a trigger on lines 1 and 2 respectively.

```

digio.trigger[1].pulsewidth = 1e-5 -- Set line 1 pulse width to 10ms.
digio.trigger[1].mode =           -- Set line 1 mode to falling edge.
digio.TRIG_FALLING
digio.trigger[2].mode =           -- Set line 2 mode to falling edge.
digio.TRIG_FALLING
digio.trigger[1].assert()         -- Assert trigger on line 1.
digio.trigger[2].wait(timeout)   -- Wait for trigger on line 2.
  
```

How do I generate a service request?

Setting up a service request

The exact programming steps necessary to generate a GPIB service request (SRQ) will vary somewhat depending on the event(s) intended to generate the SRQ. In general, the steps used will be as follows:

- Clear all status registers to prevent anomalous events from generating an SRQ.
- Set bits in the appropriate operation: questionable, measurement enable, or transition register(s).
- Set the proper summary bit in the service request enable register. At least one bit in this register must always be set, but the exact bit(s) to be set will depend on the desired SRQ event(s).

Service request programming example

The example below shows how to program the SourceMeter to generate an SRQ when the current limit on Channel A is exceeded.

```

status.reset() -- Clear all registers.
status.measurement.current_limit.enable = -- Enable current limit bit in
status.measurement.current_limit.SMUA -- current limit register.
status.measurement.enable = -- Enable status measure
status.measurement.IILMT -- current limit bit.
status.request_enable = status.MSB -- Enable status SRQ MSB.
  
```

Polling for SRQs

To determine if the SourceMeter is the GPIB device that generated the SRQ, simply serial poll the unit for the status byte, and test to see if the corresponding summary bit or bits are set. For example, the following commands request the status byte and prints the result:

```
status_byte = status.condition
print(status_byte)
```

How do I store measurements in nonvolatile memory?

Each SMU has two dedicated reading buffers for measured readings, source values, and timestamps: Buffer 1 (`nvbuffer1`) and Buffer 2 (`nvbuffer2`). Reading buffers can be saved to nonvolatile memory so that saved data will load automatically when power is cycled.

Front panel operation

See [How do I use the reading buffer?](#) for details on storing data from the front panel of the Series 2600A.

Remote programming

The following example demonstrates a typical way to use a reading buffer. The commands in the following steps will perform three SMU A voltage measurements, store them in `nvbuffer1`, and then read the buffer:

Step 1: Clear and configure the buffer

The following command sequence will clear the buffer of all readings, and configure the buffer to store timestamps and source values:

```
smua.nvbuffer1.clear()
smua.nvbuffer1.collecttimestamps = 1
smua.nvbuffer1.collectsourcevalues = 1
```

NOTE Setting `collecttimestamps` to 0 and `collectsourcevalues` to 0 will disable the storage of timestamps and source values.

Step 2: Perform measurements

The following command sequence sets the measure count to three, turns on the output, performs the three measurements, and then turns off the output:

```
smua.measure.count = 3
smua.source.output = smua.OUTPUT_ON
smua.measure.v(smua.nvbuffer1)
smua.source.output = smua.OUTPUT_OFF
```

The three measure readings, timestamps, and source values will be stored in the buffer.

Step 3: Read the buffer

The following code will output the three sets of data (nine values) in the same message:

```
rb1 = smua.nvbuffer1
printbuffer(1, rb1.n, rb1, rb1.timestamps, rb1.sourcevalues)
```

For the above `printbuffer` function, 1 is the starting index for values to output, `rb1.n` is the ending index (n = the number of readings in the buffer, which in this case is 3), `rb1` includes the measured readings, `rb1.timestamps` includes the timestamps, and `rb1.sourcevalues` includes the source values.

Example output:

```
1.234567e-03, 5.555555e-02, 1.000000e+00, 2.362360e-03, 8.888888e-02,  
1.000000e+00, 2.362368e-03, 1.111111e-01, 1.000000e+00
```

The above output is returned in the following order:

reading1, timestamp1, sourcevalue1, reading2, timestamp2, sourcevalue2, reading3, timestamp3, sourcevalue3

See Step 3 of [Running a factory script](#) for more examples on reading the buffer.

Step 4: Save the data

After the measurements are complete, you can save the reading buffer data to the nonvolatile memory in the instrument.

To save the reading buffer data:

1. From the front panel, press **STORE** and then choose **SAVE**.
2. Select **INTERNAL** to save to internal nonvolatile memory.
3. Select one of the following:
 - **SMUA-BUFFER1**
 - **SMUA-BUFFER2**
 - **SMUB-BUFFER1**
 - **SMUB-BUFFER2**
4. The front panel displays Saving... This may take awhile.
5. Press the **EXIT** key to return to the main menu.

How do I stack channels to output higher voltage?

The maximum output voltage of a Model 2601A or Model 2602A channel is 40.4, and the maximum output voltage of a Model 2611A/2612A or 2635A/2636A channel is 202V. Higher voltage can be output by stacking (connecting in series) channels.

Stacking channels requires that all SMU channels (except one) float off earth ground. [Figure A-3](#) shows two Model 2602As configured with the four channels connected in series to output up to 161.6V (40.4V per channel). Additional channels can be added (stacked), but the LO terminal of any SMU channel in the stack must never exceed 250V with respect to earth ground.

WARNING *The maximum floating (common mode) voltage for a SMU is $\pm 250V$. Exceeding this level may cause damage to the instrument and create a shock hazard.*

Whenever hazardous voltage (>30 V RMS, 42 V peak) will be output, a safety shield must completely surround the DUT test circuit. When using a metal safety shield, it must be connected to a known safety earth ground and chassis ground.

Figure A-3
Stacking channels for higher voltage

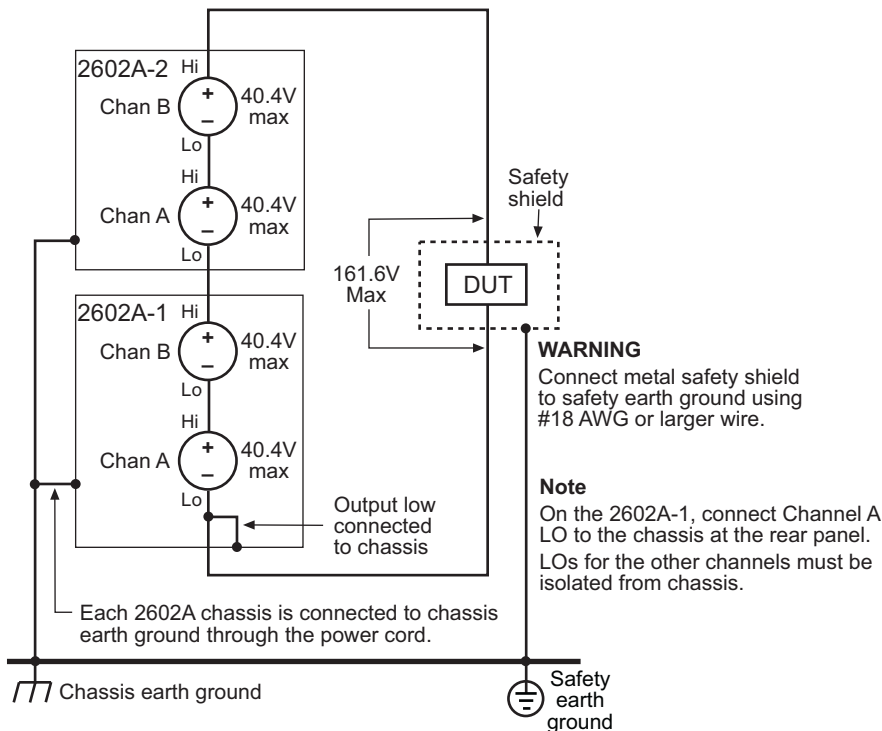

NOTE Each stacked channel adds approximately $100\mu\text{A}$ of common mode current that is seen by the channels below it. Therefore, in the example above, Model 2602A-1 Chan A will measure approximately $100\mu\text{A} \times 3 = 300\mu\text{A}$ higher than Model 2602A-2 Chan B. Similarly, Model 2602A-1 Chan B will measure approximately $100\mu\text{A} \times 2 = 200\mu\text{A}$ higher than Model 2602A-2 Chan B. The most accurate measurement of actual current flowing through the DUT will be obtained from Model 2602A-2 Chan B.

How do I parallel channels to output higher current?

The maximum DC output current of a Model 2601A or Model 2602A channel is as follows:

- 1.01A @ up to 40.4V
- 3.03A @ up to 6.06V

The maximum DC output current of a Model 2611A/2612A or Model 2635A/2636A channel is as follows:

- 101mA @ up to 202V
- 1.515A @ up to 20.2V

Higher current can be output by connecting channels in parallel. Figure A-4 shows four channels of two Model 2602As, 2612As, or 2636As connected in parallel. Two Model 2602As can output up to 4.04A at up to 40.4V and 12.12A at up to 6.06V, while two Model 2612As and Model 2636As can output up to 404mA at up to 202V and 6.06A at up to 20.2V. The current delivered to the DUT is the sum of currents output by the four SMU channels. More current can be output by connecting additional channels in parallel.

Figure A-4
Connecting channels in parallel for higher current

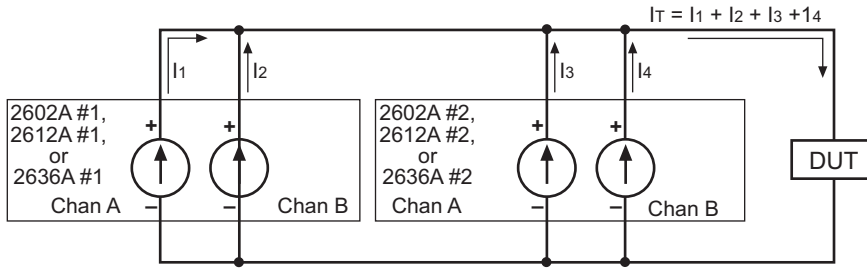

How do I make contact check measurements?

Contact check connections

The contact check function prevents measurement errors due to excessive resistance in the force or sense leads caused by poor contact at the DUT, failing relay contacts on a switching card, or wires that are too long or thin. The contact check function will also detect an open circuit that may occur with a four-point probe if misplaced or misaligned. Figure A-5 shows Model 2601A/2602A/2611A/2612A contact check connections, and Figure A-6 shows Model 2635A/2636A contact check connections. R_C is the resistance of the mechanical contact at the DUT, and R_S is the series resistance of relays and cables.

Figure A-5
Model 2601A/2602A/2611A/2612A contact check connections

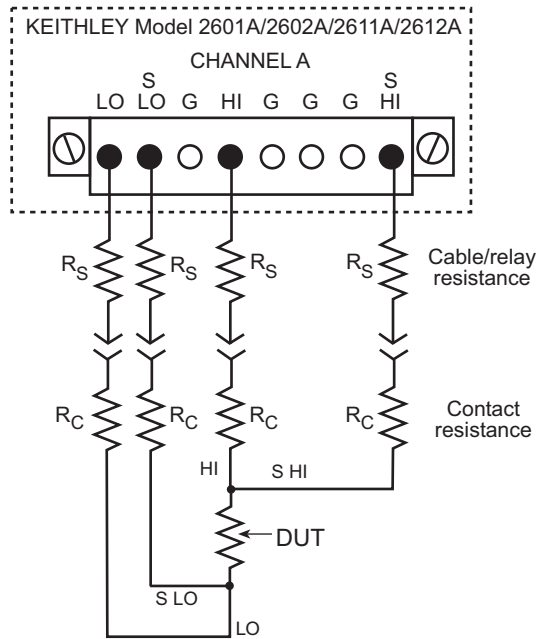
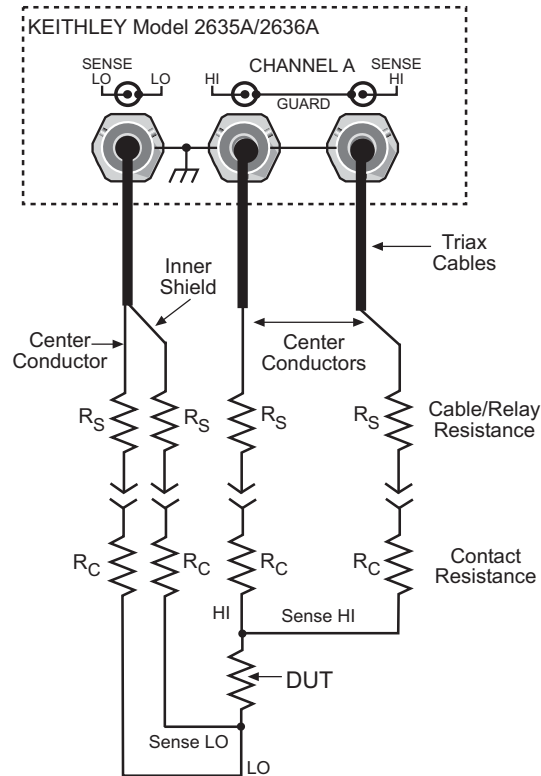

Figure A-6
Model 2635A/2636A contact check connections



```

smua.reset()
smua.contact.speed = smua.CONTACT_FAST
smua.contact.threshold = 10
if (not smua.contact.check()) then
    --One/both contact resistances are not
    --below the programmed threshold.
    smua.contact.speed = smua.CONTACT_SLOW
    rhi, rlo = smua.contact.r()
    print(rhi, rlo)
    exit()
end

smua.source.output = smua.OUTPUT_ON

```

-- Restore defaults.
-- Set speed to fast.
-- Set threshold to 10W.
-- Check contacts against threshold.
-- Set speed to slow.
-- Get resistance readings.
-- Return contact resistances to the
-- host.
-- Terminate execution.
-- Turn on output and continue.

How do I make low-current measurements?

Low-current connections

Low-current measurements ($<1\mu\text{A}$) are subject to errors caused by leakage currents and leakage resistances in the signal path. For that reason, Models 2635A and 2636A are equipped with triax connectors to minimize these problems. To assure accurate low-level measurements, the integrity of the signal path must be maintained to the DUT, including using both low-noise triax cables and a suitable test fixture.

Figure A-7 shows typical connections for low-current measurements. The DUT in this example could be a low-current semiconductor device, a high-megohm resistor, or any other passive or active electronic device requiring low-current measurements. Note that the DUT is enclosed in

both a guard shield and a safety shield, which is necessary when hazardous voltages are used. The inner shield (guard) of the HI triax cable is connected to the test fixture guard shield, and the outer cable shield (chassis ground) is connected to the safety shield.

Figure A-7
Model 2635A/2636A low-current connections

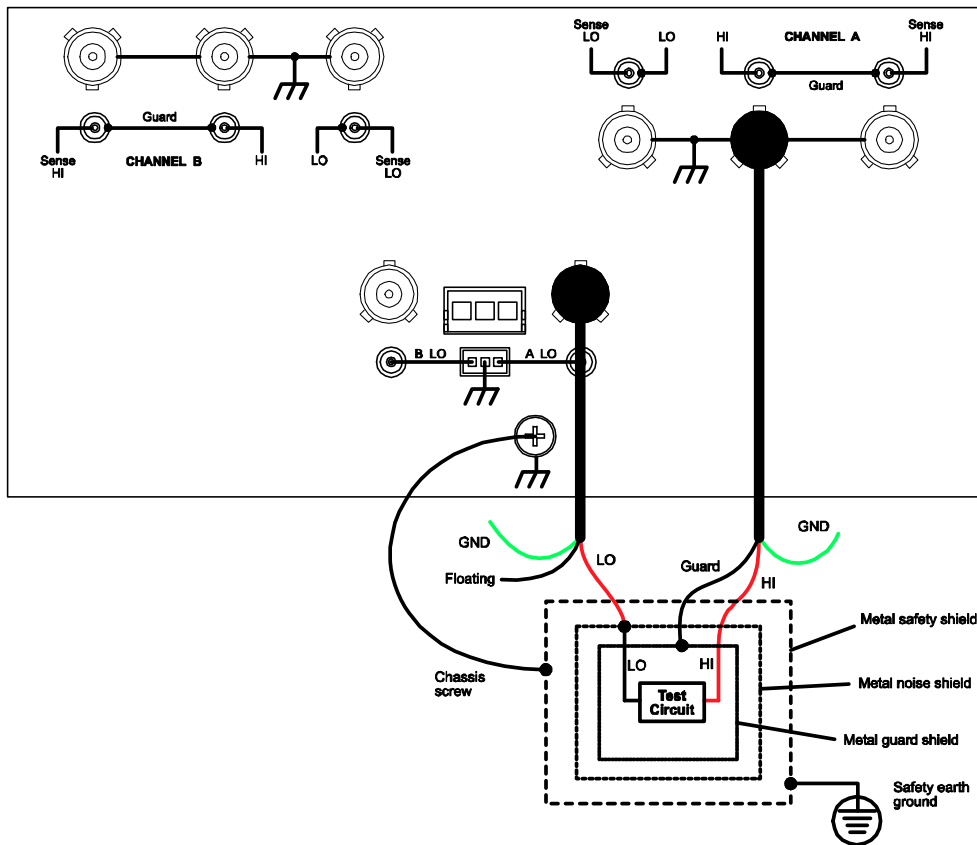

Low-current measurement programming example

The command sequence for typical low-current measurements is shown below. The sequence assumes that a 100GΩ resistor is being tested. These commands set the output voltage to 100V and then measure and display both the current through the device as well as the resistance.

```

smua.reset()
smua.source.func = smua.OUTPUT_DCVOLTS
smua.source.rangev = 200
smua.source.levelv = 100
smua.measure.rangei = 1e-9
smua.source.limiti = 1e-9
smua.source.output = smua.OUTPUT_ON
print(smua.measure.i())
print(smua.measure.r())
smua.source.output = smua.OUTPUT_OFF

-- Restore defaults.
-- Set source to DCV.
-- Select 200V source range.
-- Output 100V DC.
-- Select 1nA range.
-- Set current limit to 1nA.
-- Turn on output.
-- Display current reading.
-- Display resistance reading.
-- Turn off output.
    
```

- A**
 - Auto zero
 - Disabling A-2
- B**
 - Basic measurements 1-10
 - Buffer
 - Configuration 1-15
 - Configuring 1-15
 - Overview 1-15
 - Recalling readings 1-16
 - Storing readings 1-16
 - Using 1-15
- C**
 - Calling a function 3-4
 - Operator interaction 3-5
 - Chassis ground 1-6, 1-8
 - Clearing a buffer A-5
 - Command help 2-14
 - Compliance
 - Setting limit 1-11
 - Configuring a buffer A-5
 - Connections
 - DUT 1-11, 1-15
 - Connectors
 - Digital I/O 1-5, 1-8
 - IEEE-488 1-6, 1-8
 - Output 1-5, 1-7
 - Power module 1-6, 1-8
 - RS-232 1-6, 1-8
 - TSP-Link 1-6, 1-8
 - Console window
 - Clearing 2-14
 - Saving 2-14
 - Contact check
 - Connections A-8
 - Measurements A-8
 - Control icons 2-13
- D**
 - Digital I/O port
 - Controlling A-3
 - Terminals A-3
 - Display
 - Annunciators 1-4
 - Display modes 1-12
 - DUT connections 1-11
- F**
 - Factory scripts 3-2
 - Front panel summaries 1-2
- G**
 - GPIB interface 2-2, A-2
- H**
 - How do I interact with scripts using 3-4
 - How do I parallel channels to output higher current?
A-7
 - How do I run a script from the front panel? 3-2
 - How do I stack channels to output higher voltage?
A-6
 - How do I store measurements in non-volatile
memory? A-5
 - How do I use other programs? 3-12
 - How do I use the expanded system? 4-3
- I**
 - IEEE-488 interface 2-2, A-2
 - Importing a factory script project 3-6
 - Input/output connections 1-5, 1-7
 - Instrument resource
 - Closing 2-13
 - Opening 2-13
 - Interface configuration
 - GPIB 2-2
 - RS-232 2-3
- K**
 - Keys
 - Function 1-3
 - Output control 1-4
 - Range 1-4
 - Special 1-3
- L**
 - LabVIEW 2-17, 3-12
 - Language help 2-14
 - Line frequency 1-10
 - Line power
 - Connecting to 1-10
 - Setting line frequency 1-10
 - Turning on 1-10
 - Low current
 - Connections A-9
 - Measurements A-9
 - Programming example A-10

M

Measurement	
Function	1-12
Making	1-12
Range	1-12
Setting functions	1-15
Measurements	
Basic	1-11
Using Test Script Builder	2-14
Modifying a factory script	3-6
Modifying the test code	3-7

O

Optimizing performance	A-2
Output	
Turning off	1-12
Turning on	1-12, 1-16

P

Performing measurements	A-5
Power module	1-6, 1-8
Power switch	1-3
Programs	
Using	2-17
Using LabVIEW	2-17, 3-12
Using Visual Basic	2-19, 3-14
Project Navigator pane	2-11
PulseVMeasure function	3-4

R

Reading a buffer	3-5, A-5, A-6
Readings	
Recalling	1-16
Storing	1-16
Rear panel summaries	1-2
Recalling readings	1-16
Remote interface	
Configuring	2-2
Connections	2-2
Using	2-2, A-2
Rotary knob	1-4
RS-232 interface	2-2, A-2
Running a factory script	3-4
Running a user script	3-11

S

Saving a script	3-8
Script Development pane	2-11
Service request	
Generating	A-4
Polling for	A-5
Programming example	A-4
Setting up	A-4
Source	
Selecting	1-11
Setting functions	1-15
Setting level	1-11
Source-measure capabilities	1-6
Model 2601/2602	1-9
Model 2611/2612	1-9
Model 2635/2636	1-9
SourceMeter/Script Interaction pane	2-11

Speed	
Setting	A-2
SRQ (Service request)	A-4
Storing a script in non-volatile memory	3-8
Storing readings	1-16

T

Test Script Builder	
Running	2-11
Using	2-11
Timestamp	1-16
Triggering	
Other instruments	A-3
Programming	A-4
Scanner	A-3
TSP-Link	
Accessing node resources	4-3
Connections	4-2
Initialization (reset)	4-3
localnode variable (alias)	4-3
Node number assignments	4-2
node variable	4-3
Running scripts	4-4
Setup	4-2
System check	4-3

U

User scripts	3-2
--------------	-----

V

Vents	
Cooling	1-6, 1-8
Visual Basic	2-19

W

What is a script?	3-2
-------------------	-----

Model No. _____ Serial No. _____ Date _____

Name and Telephone No. _____

Company _____

List all control settings, describe problem and check boxes that apply to problem. _____

Intermittent Analog output follows display Particular range or function bad; specify _____

IEEE failure Obvious problem on power-up Batteries and fuses are OK

Front panel operational All ranges or functions are bad Checked all cables

Display or output (check one)

- Drifts Unable to zero
 Unstable Will not read applied input
 Overload

Calibration only Certificate of calibration required

Data required

(attach any additional sheets as necessary)

Show a block diagram of your measurement system including all instruments connected (whether power is turned on or not). Also, describe signal source.

Where is the measurement being performed? (factory, controlled laboratory, out-of-doors, etc.)

What power line voltage is used? _____ Ambient temperature?°F _____

Relative humidity? _____ Other? _____

Any additional information. (If special modifications have been made by the user, please describe.)

Be sure to include your name and phone number on this service form.

Specifications are subject to change without notice.
All Keithley trademarks and trade names are the property of Keithley Instruments, Inc.
All other trademarks and trade names are the property of their respective companies.



A G R E A T E R M E A S U R E O F C O N F I D E N C E

Keithley Instruments, Inc.

Corporate Headquarters • 28775 Aurora Road • Cleveland, Ohio 44139 • 440-248-0400 • Fax: 440-248-6168 • 1-888-KEITHLEY • www.keithley.com