

"Save These Instructions"

V-50



Dear

Pellet Stove Owner:

CONGRATULATIONS on the purchase of your wood pellet appliance! You have selected the finest in residential wood pellet heating technology.

Let us pass on a few "*tips*" concerning installing your stove and heating with wood pellets.

1. Whether you install your stove yourself or hire a professional installer, ***a quality installation is a must*** for the safety of your family and for efficient, satisfactory operation of your stove.
2. ***Initial Burn Setup of the stove is the most important step*** to ensure the efficient and satisfactory operation of your appliance for many years to come.

Know the quality and characteristics of the pellets you burn. Pellets can vary greatly from company to company, from load to load and occasionally from bag to bag.

4. ***Be extra diligent in your cleaning program***

5. Remember that ***most operational dilemmas*** with a pellet stove are usually traced back to ***Improper installation, poor quality pellets and/or a lack of timely cleaning***

With just a minimum of daily care your pellet appliance will provide years of clean, efficient, comfortable and environmentally sound heating.

Thank you for selecting a wood pellet appliance.

Sincerely, Sincere

TABLE OF CONTENTS

GENERAL INFORMATION	
SAFETY PRECAUTIONS	4,5
SAFETY TESTING	5
HOW YOUR VULCAN "V" SERIES STOVE WORKS	6
AUTOMATIC SAFETY FEATURES	7
SPECIFICATIONS	8
INSTALLATION	
INSTALLATION PLANNING & CHECK LISTS	9
INSTALLATION OPTIONS	10
EXHAUST SYSTEMS	11
SIZING	11
TERMINATION	12
CLEARANCES	12
OUTSIDE AIR	13
FREESTANDING INSTALLATION	
STOVE PLACEMENT	14
FLOOR PROTECTION	14
CLEARANCES	14
ALCOVE	15
THROUGH THE WALL DIRECT INSTALLATION	16
VERTICAL INSTALLATIONS	17
MOBILE HOME INSTALLATION	18
INSERT / BUILT-IN INSTALLATION	
IN A WOOD OR COAL BURNING FIREPLACE	19
IN A WALL OR MANTEL	21
OPERATION	
LIGHTING A FIRE	23
THE ACUTRON CONTROLS	24
SHUTTING THE STOVE OFF	25
ACUTRON WALL THERMOSTAT (OPTIONAL)	26
INITIAL BURN SETUP	27
PERFORMANCE ENHANCEMENT TIPS	28
PELLETS	
PELLET QUALITY	29
PELLET CONSUMPTION	29
FACTORS EFFECTING PELLET FEED RATES	29
FINE TUNING THE PELLET FEED RATES	29
ASH and CLINKERS	30
FINES	30
PFI PELLET STANDARDS	30
MAINTENANCE	
INSERTING, REMOVING, AND ADJUSTING THE BURN GRATE	31
REQUIRED CLEANING	32
PERIODIC MAINTENANCE	33
TROUBLE SHOOTING	35
LIMITED WARRANTY	36
APPENDIX "A" - VULCAN "V" SERIES OPTIONS	37
APPENDIX "B" - VULCAN "V" SERIES ACCESSORIES	38
SERVICE LOG	40

SAFETY PRECAUTIONS

IMPORTANT: Read, save and follow the instructions in this manual. It contains important Safety, Operating and Maintenance instructions you will need.

- **BEFORE** installing or having the pellet appliance installed contact the local building officials to obtain the necessary permits and information on any installation restrictions or inspection requirements in your area and notify your insurance company you have installed a pellet appliance.
- This unit must be properly installed to prevent the possibility of a house fire. The instructions and local building codes requirements must be strictly adhered to. **Do not**; use makeshift methods or material that may compromise the installation.
- When the pellet appliance is installed in a mobile home, the heater must be bolted to the floor, have outside air, and **MUST NOT BE INSTALLED IN THE BEDROOM** (Per H.U.D. requirements). Check with local building officials.
- **NEVER** try to repair or replace any part of the heater unless instructions for consumer are given in this manual or instructed by Dansons Customer Service Department. A trained technician should do all other work.
- **Educate** all children of the danger of a high-temperature heater. Young children should be supervised when they are in the same room as the heater.
- This heater is designed and approved for pelletized wood fuel only. Any other type of fuel burned in this heater will void the warranty and safety listing. Keep foreign objects out of the hopper.
- **NEVER** use gasoline, gasoline-type lantern fuel, kerosene, charcoal lighter fluid, or similar liquids to start or “freshen up” a fire in this appliance. Keep all such liquids well away from the appliance while it is in use.
- This heater must be connected to a standard 115 V., 60 Hz grounded electrical outlet. **A grounded surge-protection unit is recommended.**
- **Do not** use an adapter plug or sever the grounding prong on the electrical plug.
- **Do not** route the electrical cord underneath, in front of, or over the heater.
- **Do not** unplug the stove if you suspect a malfunction. Push the “OFF” Touch Pad and inspect the heater.
- The heater will not operate during a power outage. If a power outage does occur, check the heater for smoke spillage and open a window if any smoke spills into the room.
- **DO NOT** operate the heater if you smell smoke coming from the heater. Push the “OFF” Touch Pad, monitor your pellet appliance, and call your local authorized dealer.
- **Do not** place clothing or other flammable items on or near the heater. When installed with a thermostat there is a possibility of the heater turning on and igniting any items placed on or near the unit.
- **CAUTION: NEVER** put fingers in or near pellet feed auger. The pellet fuel is fed to the burn pot by a screw auger that is driven by a high torque motor. This auger can start and stop anytime automatically without warning while stove is operating.

SAFETY PRECAUTIONS . . . Continued

- **DO NOT** operate the stove if the flame becomes dark and sooty or if the firepot overfills with pellets. Push the **OFF** Touch Pad and inspect the heater. (See Operating Your Stove). Soot or creosote may accumulate in the exhaust vent system when the stove is operated under incorrect conditions such as an extremely rich burn. The flame will have a lazy orange color with black tips. This indicates poor pellet fuel combustion.
- **NEVER** block free airflow through the open vents of the unit. The viewing door and ash pan must be closed and latched during operation.
- The pellet appliance exhaust system works with **negative** combustion chamber pressure and a **positive** chimney pressure, therefore the exhaust system must be completely airtight and properly installed. All exhaust system vent joints must be sealed, gas tight, with HI-TEMP RTV silicone sealant, and/or at least 3 sheet metal screws **per joint and to the heater** also.
- Your heater requires periodic maintenance and cleaning (Refer to "Routine Cleaning" section of the manual). Failure to maintain your heater may lead to smoke spillage in your home.
- **Disconnect** the power cord from the electrical outlet before performing any maintenance. Pushing "OFF" Touch Pad does not disconnect all power to the heater.
- **BEFORE** carrying out any maintenance or cleaning, allow the heater to cool. Ashes must be disposed in a metal container with a tight lid and placed on a non-combustible surface or on the ground, well away from all combustible materials, pending final disposal.
- The exhaust system should be checked twice a year minimum for any build-up of soot or creosote. Do not touch the hot surfaces of the heater.

Note: Canadian Comfort Industries grants no warranty, implied or stated, for the installation or maintenance of your heater, and assumes no responsibility of any consequential damage(s).

SAFETY TESTING

In accordance with the procedures and specifications listed in UL1482 – 1998 & ASTM E 1509-95, and ULC-S627-00 and ULC-S628-M93 for solid fuel room heater, the Canadian Comfort Industries pellet stove has been independently tested and listed by I.T.S. (an accredited testing laboratory) to UL, ULC and CSA standards. It is tested and listed for residential installation according to current national and local building codes as:

- A Freestanding Room Heater
- A hearth insert when installed into a masonry or factory built fireplace.
- A Mobile Home Heater.
- A Built-In Heater.

The Safety Listing Label is located on the rear inspection panel for model FPP and on the side panel for model IPP. Please read the label carefully. It contains important information about installation and operation of your pellet appliance. Note that your STOVE'S serial number is located on the safety label. Your appliance serial number is preceded by a "WH-" (example WH-00000)



AUTOMATIC SAFETY FEATURES

L120 LOW LIMIT SWITCH

This limit switch is mounted on the exhaust blower housing and has 2 main functions.

1. Should the fire happen to go out, for any reason, this limit switch will shut the stove off when the exhaust temperature drops below 120deg F.
2. Upon starting the appliance, the AcuTron control board has a 15 minute "Lighting Mode", if the stove exhaust does not reach 120deg F in that 15 minutes the stove will shut off. As soon as the stove exhaust does reach 120deg F, the limit switch opens and the AcuTron enters a 5 minute "Safety Delay" mode.

F140 FAN LIMIT SWITCH

Your pellet appliance has a convection fan control limit switch. The room air fan's (F140) temperature limit snap switch automatically sets the fan on high when your stove is producing heat faster than the fan is carrying it into the room. This may occur when the heat control lever is set at [3 or 4] and the **FAN SPEED** is set to a very low or off setting. After the fan runs at this automatic high setting a few minutes, it may cycle back to its lower setting and may continue to cycle between [HIGH] and your selected setting. The circulation (room air) fan cycling from high to low is a normal condition as well as a safety feature of your appliance. To compensate for the fan cycling, adjust the FAN SPEED to a higher setting.

L250 HIGH LIMIT SWITCH

Your pellet appliance has a high temperature limit switch installed. If the temperature at the back of the firebox reaches approximately 250deg F., the switch will shut off the electricity going to the Vacuum Switch and to the Auger Motor. The auger will automatically stop, and the appliance will shut down when the exhaust temperature cools (120deg F). If this happens call your dealer or Dansons Customer Service (1-866-456-9269).

IT IS IMPORTANT TO FIND THE REASON WHY THE UNIT OVERHEATED.

VACUUM SWITCH

This safety device (mounted on the back panel pillar) detects vacuum in the exhaust system, firebox, and air intake. If the exhaust blower fails, the vent pipe becomes plugged, the viewing door is open, or if you are out of pellets, this switch will sense that there is a lack of vacuum and will stop the auger from continuing to feed pellets.

If the power does go out, the pellet appliance will stop running. When the power comes back on, the stove will not restart if the switch is in the manual mode. If the exhaust temperature is above 120deg F or the switch is in the manual position, the stove will start to feed pellets again and may re-light itself.

NOTE: If power outages are a concern you may wish to purchase a back-up generator system.

For further information contact your local Specialty Retailer, Certified HVAC Service Depot, or Dansons Group Inc. Customer Service Department at 1-866-456-9269.

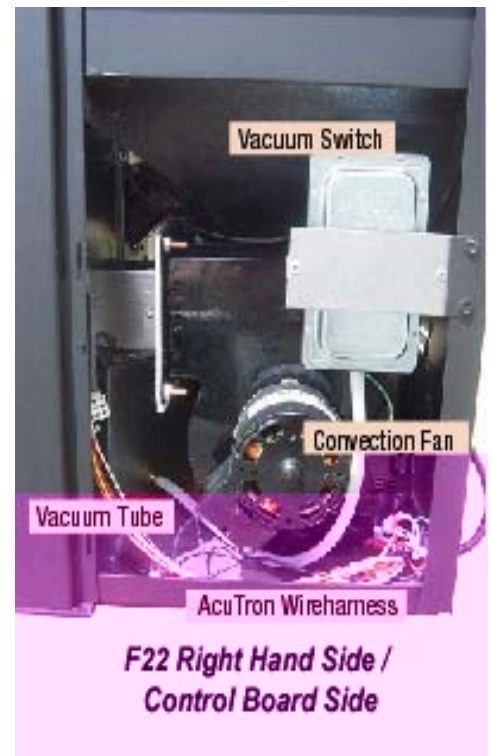

HEATING SPECIFICATIONS

Approx. Heating capacity (sq. feet)

Approx. Fuel burn rate per hour **

Hopper Capacity - Traditional Stove

Hopper Capacity - Bay View Free

Hopper Capacity - Bay View Insert

* Heating capacity will vary depending on temperature. Fuel size, quality, density.

** Pellet size may effect the actual rate. Use PFI listed fuel for best results.

time at lowest setting 27 hrs

time at lowest setting 48 hrs

time at lowest setting 27-48

of the outside

20%. Use

DIMENSIONS

	Pedestal	Leg
A	24"	24"
B	28"	26 1/2"
C	18 3/4"	18 3/4"
D	24"	24"
E	22 1/4"	22 1/4"
F	6 3/4"	6 3/4"
G	16 3/4"	15 1/4"
H	2 1/8"	2 1/8"
I	9"	9"

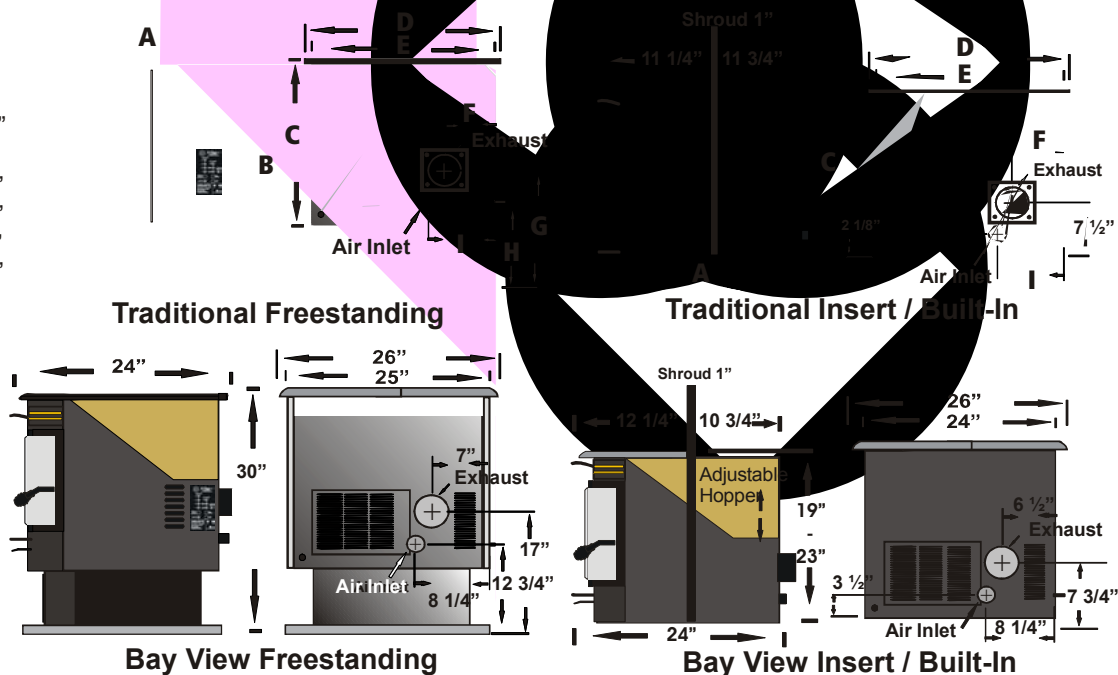

ELECTRICAL SPECIFICATIONS

Electrical Rating

= 110-120 Volts 60 HZ 2.0 Amps

Watts (operational)

= 175 (approximately)

Watts (optional igniter)

= 475 (approximately)

A voltage surge protector is required for this unit.

EPA COMPLIANCE

This heater is exempt from EPA Phase II requirements, but has been tested for emissions using EPA test methods by Warnock Hersey, USA.

FUEL CONSIDERATIONS

Your VULCAN "V" SERIES pellet appliance, is designed to burn pellets that comply with the Pellet Fuel Institute Standards. (Minimum of 40lbs density per cubic ft, 1/4 to 5/16" diameter length no greater than 1.5", not less than 8,200 BTU's/lb, moisture under 8% by weight, ash under 1% by weight, and salt under 300 parts per million) Pellets that are soft, contain excessive amounts of loose sawdust, have been or are wet, produce clinkers and/or heavy ash will result in reduced performance and may actually cause the fire to go out.

For further information visit www.pelletheat.org

PLANNING & INSTALLATION CHECK LIST

Unless you are knowledgeable and experienced in stove installation, we recommend your **VULCAN "V" SERIES** stove receive a Pre-delivery Check and be installed by your local Specialty Retailer or Certified HVAC Service Depot.

COMPLETE THIS CHECK LIST PRIOR TO INSTALLING YOUR PELLET APPLIANCE:

- _____ Carefully read this "Owner's Manual". **SAVE THIS MANUAL.**
- _____ Have your local Dealer **demonstrate all the operational, cleaning and maintenance steps necessary for your stove.**
- _____ **Select a location.** The design of your home and the stove placement will determine its value as a source of heat. A pellet appliance depends primarily on air circulation to disperse its heat. There are other practical considerations, which must be considered before a final placement is decided on: **Existing Chimneys, Pellet Fuel Storage, Aesthetic Considerations, Roof Design (rafter locations & roof pitch), Room Traffic, Clearances to Combustibles, and Existing Wiring.**
- _____ The installation of this appliance **must conform to local codes and applicable state and federal requirements.** Becoming familiar with these requirements **before** installation is essential.
- _____ Sign and keep a copy of the **Pre-delivery Check List** supplied by your **Authorized VULCAN "V" SERIES Dealer, OR "Dansons Certified Installer",** found inside our appliance or available online. Register online at www.dansons.com/support for Extended Warranty.
- _____ Register your purchase online at www.dansons.com/support.

COMPLETE THIS CHECK LIST WHILE INSTALLING YOUR PELLET APPLIANCE:

- _____ Carefully read the **ENTIRE** installation section first.
- _____ Read the Freestanding or Insert or Built-In section (which ever applies)
- _____ **Determine** the location and measurement needed your chosen location.
- _____ **Be sure to pre-fit** all items before you install, fasten or install the stove permanently. **Remember measure twice, cut once.**
- _____ **Ensure ALL** joints of "PL" vent and single wall stainless steel liner are tightly connected, **sealed with RTV Silicone, including to the exhaust connector,** and is correctly installed. (Follow vent manufacturer's instructions.)

COMPLETE THIS CHECK LIST PRIOR TO LIGHTING YOUR FIRST FIRE:

- _____ **Obtain final inspection** and approval by local building officials.
- _____ Carefully **clean all marks off the brass, nickel or pewter parts** before the first fire is lit. Use a soft cloth and a gentle type cleaner. **Caution:** Never use an abrasive cleaner on any part of your stove.
- _____ **Polish the hopper** to remove the oil type coating used in manufacturing.
- _____ The high temp. stove paint used on your stove may take several hours of burning at a high fuel setting to fully cure. During this time an odor, which is not harmful, may be evident. The area around the stove should be well ventilated.
- _____ Review and follow the **Lighting and Controls Instructions.**
- _____ **Fill the hopper with quality pellets to prime the unit;** Using the CCI "AcuTron", (figure 5), **PUSH the FEED RATE** Touch Pad and this will start the auger and the combustion fan.

INSTALLATION OPTIONS

READ THIS ENTIRE MANUAL BEFORE YOU INSTALL AND USE YOUR VULCAN "V" SERIES HEATER. FAILURE TO FOLLOW INSTRUCTIONS MAY RESULT IN PROPERTY DAMAGE, BODILY INJURY OR EVEN DEATH!

(See specific Installation details for clearances and other installation requirements)

The two **VULCAN "V" SERIES** models are the: "**FPP**" **Freestanding**: a Traditional styled stove mounted on a pedestal (figure 1) or Leg platform (figure 2), and a Bay View style (figure 3); and the "**IPP**" **Fireplace Insert / Built-In**: a Traditional style (figure 4), and a Bay View style (figure 5). Both models are available in black, pewter or gold plated doors, legs, and louvers.

All models may be installed to code in both **conventional** and **mobile homes**.

INSTALLATION OPTIONS INCLUDE:

1. A **FREESTANDING STOVE**: Set on a pedestal or legs and placed on a non-combustible floor pad. (figure 1, 2 & 3)
2. An **ALCOVE**: Set on a pedestal and placed on a non-combustible floor pad in compliance with clearance requirements for an installation in an **alcove**. (figure 1, 2 & 3)
3. A **HEARTH STOVE**: When installed with or without a pedestal on a non-combustible hearth of a masonry or factory built wood or coal burning fireplace. (figure 1, 2 & 3)
4. A **FIREPLACE INSERT**: When installed, with a shroud, in a masonry or a factory built, wood or coal burning fireplace. (figure 4 & 5)
5. A **BUILT-IN INSERT**: When installed on a non-combustible pad, in a wall or custom built mantel and where adequate airflow around the stove is provided. (figure 4 & 5)



FPP
Freestanding Pedestal



FPP
Freestanding Leg



FPP
Bay View Freestanding



IPP
Insert / Built-In



IPP
Bay View Insert / Built-In

EXHAUST SYSTEMS (GENERAL)

PELLET VENT MUST MAINTAIN A MINIMUM 3" CLEARANCE TO ANY COMBUSTIBLE
(INSTALL VENT AT CLEARANCES SPECIFIED BY THE VENT MANUFACTURER).

**DO NOT CONNECT THE PELLET VENT TO A VENT SERVING ANY OTHER APPLIANCE
OR STOVE.**

DO NOT INSTALL A FLUE DAMPER IN THE EXHAUST VENTING SYSTEM OF THIS UNIT.



PELLET VENT TYPE:

Must be an approved 3" or 4" Diameter Type "PL" vent, vented to the outside (fig. 7) or connect the vent to a factory built type "A" chimney using an adaptor; and/or "All Fuel" Stainless Steel chimney liner for masonry fireplace installations (fig. 8) . Use 4" dia. vent if vent or liner height is over 15' or if installation is over 4,000' above sea level.

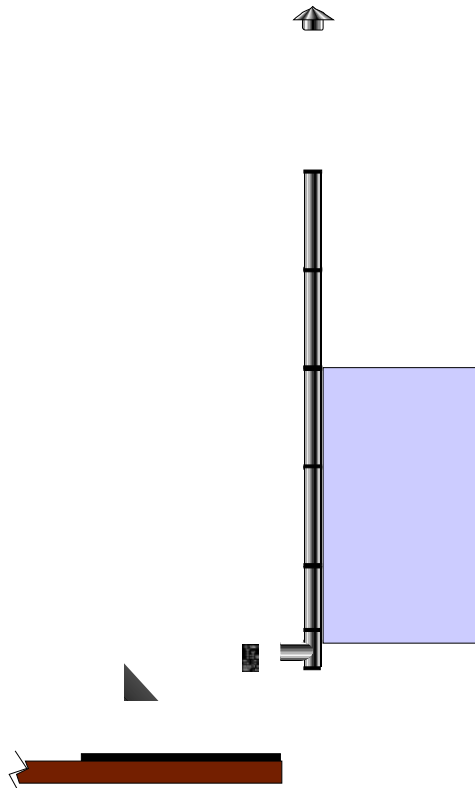
MAXIMUM VENTING SIZE:



VENT INSTALLATION:

-  Termination must exhaust above the air inlet elevation, and parallel or above the exhaust output of the pellet appliance. It is recommended that at least 3' of vertical pipe be installed to create some natural draft. This is to help prevent the possibility of smoke or odor during the appliance shut down.
-  Horizontal sections must have a 1/4" rise every 12" of travel after 3' long.
-  Pellet Vent connections must be sealed with HI-Temp RTV Silicone and screwed together with at least 3 x 3/8" long stainless steel screws. Seal each vent section by injecting a liberal amount of HI-TEMP RTV silicone sealant into the gap.

EXHAUST SYSTEMS . . . Continued

PELLET VENT TERMINATION: (Figures 7 & 8)

- ☪ Termination must be a minimum of 6" above the chimney (B) (note: the chimney must meet local codes for height above the roof or other obstructions)
- ☪ Must have an approved cap (to prevent water from entering) or a 45° elbow downturn
- ☪ If the termination is located on a windy side of house, an approved house shield is recommended to prevent soot from accumulating on the side of the house.
- ☪ Must not be located where snow or other materials will plug it.
- ☪ Must have a "Metal Seal Plate" or "Wall Thimble" at point (A)

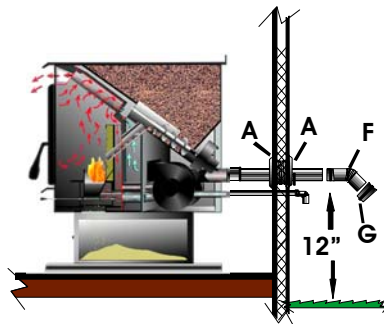

Figure 7

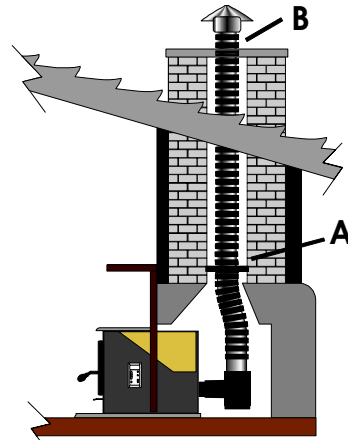

Figure 8

VENT TERMINATION CLEARANCES:

- Horizontal terminations must protrude 12" from the wall, vertical terminations 24"

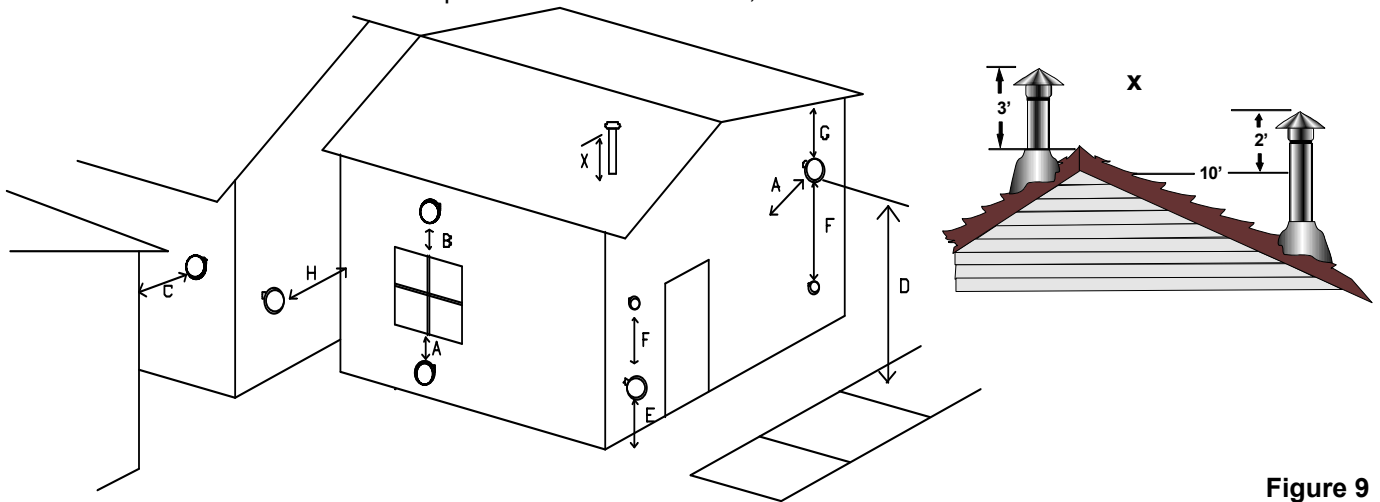

Figure 9

- A Minimum 4' clearance below or beside any door or window which opens.
- B Minimum 1' clearance above any door or window that opens.
- C Minimum 3' clearance from any adjacent building.
- D Minimum 7' clearance above any grade when adjacent to public walkways.
- NOTE: Vent may not terminate in covered walkway or breezeway.
- E Minimum 2' clearance above any grass, plants, or other combustible material.
- F Minimum 3' clearance from any forced air intake of any other appliance.
- G Minimum 2' clearance below eaves or overhang.
- H Minimum 1' clearance horizontally from combustible wall.
- X Must be a minimum of 36" above the roof and 24" above the highest point of the roof within 10'.

Outside Kits **REQUIRE**

Outside air is supplied
in a proper manner

Local pipe
NOT

the outside air pipe or a 90 degree elbow or bend directed
the prevailing winds **MUST** be used when an outside air pipe is used
Keep the outside air pipe termination at least 1 foot away from the exhaust system



The outside air pipe on your stove is 2" OD. The outside air connecting pipe must be 2" OD.
The outside air connecting pipe must be as short and free of elbows as possible. Do not use
(A), not inside, the outside air pipe on your stove.

Air may also be drawn from a vented crawl space under the home. All openings must be properly
secured.

Through The Wall Kits Include:

3 FOOT PACKAGE – PART# ACFAKT03

- 1 – 2" Galvanized Hood c/w screen
- 1 – 2" Aluminum Flex Duct –
compressed 15" length, extends to 30" – 36"
- 2 – 2" Worm Gear Clamps



10 FOOT PACKAGE – PART# ACFAKT04

- 1 – 2" Galvanized Hood c/w screen
- 1 – 2" Aluminum Flex Duct –
compressed 15" length, extends to 30" – 36"
- 2 – 2" Worm Gear Clamps



NOTE: Available from your local Authorized Dealer

FREESTANDING STOVE INSTALLATION

STOVE PLACEMENT:

-  Stove must be placed so that no combustibles are within, or can swing within (i.e. drapes doors), 36" of the heater.
-  If the stove is placed in a location where the ceiling height is less than 7', it must follow the requirements in the section "Alcove Installation".
-  Stove and floor protection must be installed on a level secure floor

FLOOR PROTECTION REQUIREMENTS:

-  The stove must be installed on a non-combustible floor protector (i.e. sheet steel with cement, tile or slate) extending the full width and depth of the stove and extending 6" in front of the stove. Floor protector needs to be a minimum of 24.5" deep X 30.5" wide and must be a minimum of .018" thick (26 gauge).
-  Must extend under and 2" to each side of chimney tee (if used).

MINIMUM CLEARANCES TO COMBUSTIBLES (FIGURES 10 – 15)

- | | |
|---|---|
| 1" From Back Of Heater To Combustibles | 3" From PL Vent to Combustibles |
| 2" From Side of Heater to Combustibles | 6" Non Combustible Surface In Front Of Heater |
| 1" From Back Corner of Heater to Combustibles | 36" to drapes, doors, anything that can swing |
| 16" From Top Of Heater to Combustibles | |

CLEARANCES – "STRAIGHT INSTALLATION":

THROUGH THE WALL

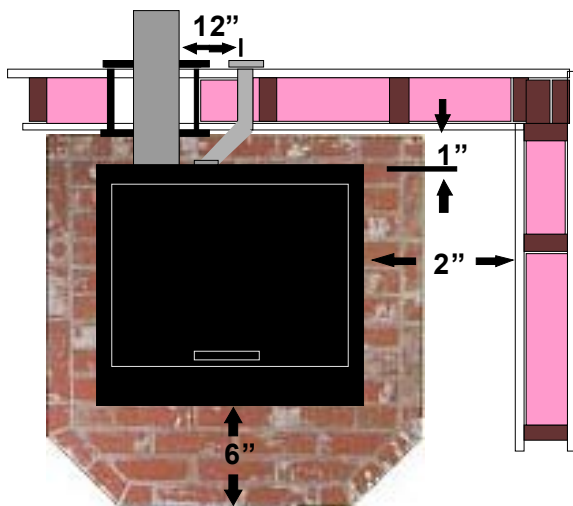

Figure 10

INTERIOR VERTICAL

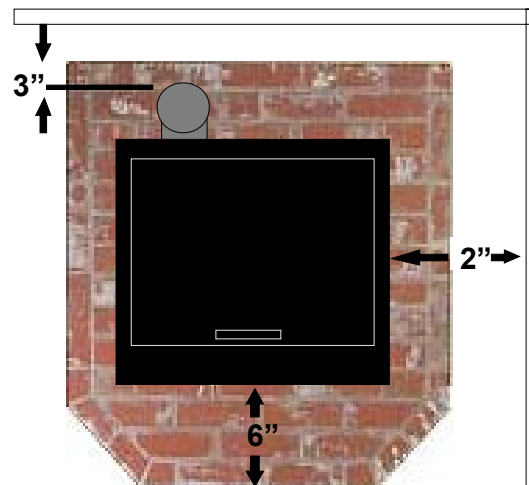

Figure 11

FREESTANDING INSTALLATION . . . continued

CLEARANCES – “CORNER INSTALLATION”:

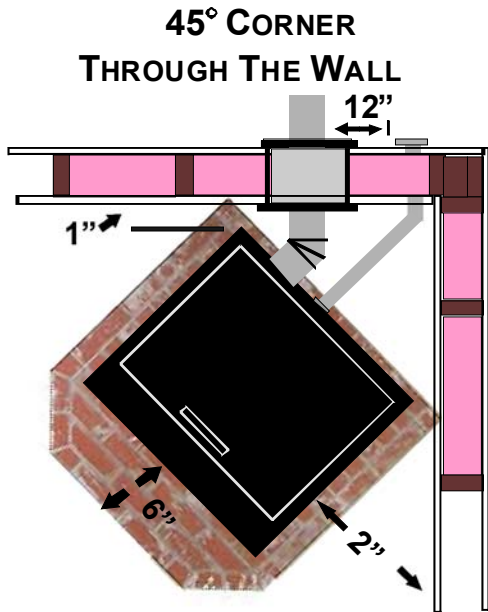

Figure 12

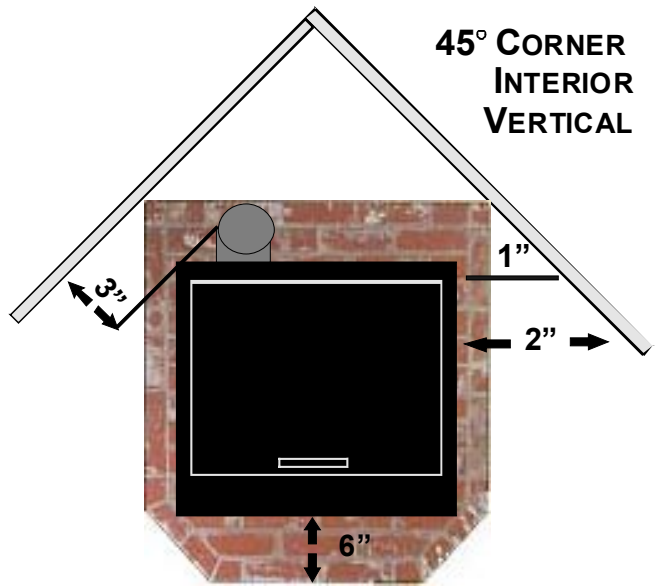

Figure 13

Note: If interior vertical vent is used, the clearance to the back wall is determined by the upward-turned elbow or “Tee”. It will vary in depth depending on the brand of PL vent used. Before placing the stove, connect the elbow or “Tee” and measure off the 3” clearance.

ALCOVE INSTALLATION:

Minimum clearances to combustibles for a stove. (Figures 14 and 15)

- 1 inch from the back
- 16 inches from the top
- 6 inches from the sides
- 30 inches deep

Figure 14

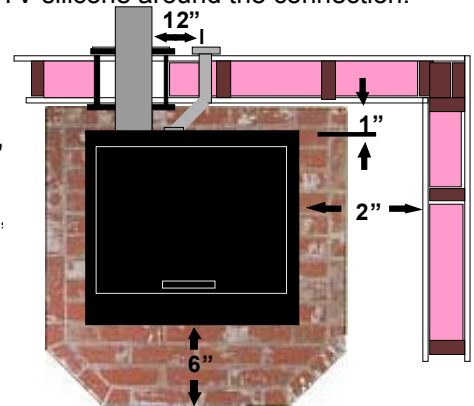

Figure 15

FREESTANDING INSTALLATION . . . continued

THROUGH THE WALL, DIRECT VENT INSTALLATION. (Figure 18)

1. Select the location for your stove, design the exhaust system and determine the brand and size of "PL" vent to be used.
2. Position the floor pad.
3. Following the "PL" vent manufacturer's specifications, mark and cut a hole through the wall to accommodate the wall thimble, (F), and the outside air pipe, (I), if outside air is to be used. Remember that the outside air intake must be located no closer than 12" from the vent exhaust. Try to avoid cutting wall studs, and use extreme caution to avoid cutting into power or water lines within the wall of your home.
4. Install the wall thimble, (F). Be sure to run a bead of silicone around the outside edges of the wall thimble to reduce drafts, both inside and outside. Insert the proper size of "PL" vent, (E), through the wall thimble, (F).
5. Place your stove on the floor pad, close to its final position. Leave room to connect the "PL" vent to "Quick Connect" end collar. If not already factory installed, install the gasket (B) and "Quick Connect" exhaust end (C) to your stove to the "Quick Connect" mounting plate. Use the 4 x 7/16" nuts, supplied and secure tightly.
6. Place a bead of RTV silicone around the end collar of the "Quick Connect" of your stove's exhaust, (C). Firmly push the "PL" vent pipe adaptor (J) into the bead of RTV silicone.
Note: If 4" PL vent is required, use an 3" to 4" Pipe Adaptor Increaser, (J), on the stove exhaust pipe.
7. Connect the length of "PL" vent, (E), that is in the thimble, (F), onto the pipe adaptor (D). Fasten together with at least three sheet metal screws (approx. 3/8" in length). Place a bead of RTV silicone around the connection.
8. Place your stove in its final position on the pad. Place another bead of RTV silicone around the "PL" vent (E) and the inside of the wall thimble, to stop cold air drafts.
9. On the outside of the building, place an exhaust cap (G) or a 45 degree "PL" type elbow, (G), onto the end of the horizontal "PL" vent, (E).
 Optionally, place a rodent screen cap, (G), (may be required in some locals), on the end of the elbow, (G). Secure all connections using 3 sheet metal screws and run a bead of RTV silicone around all connections and around the "PL" vent pipe and the outside of the wall thimble.



Note: The end of the exhaust pipe must extend a minimum of 12" from the

Figure 16

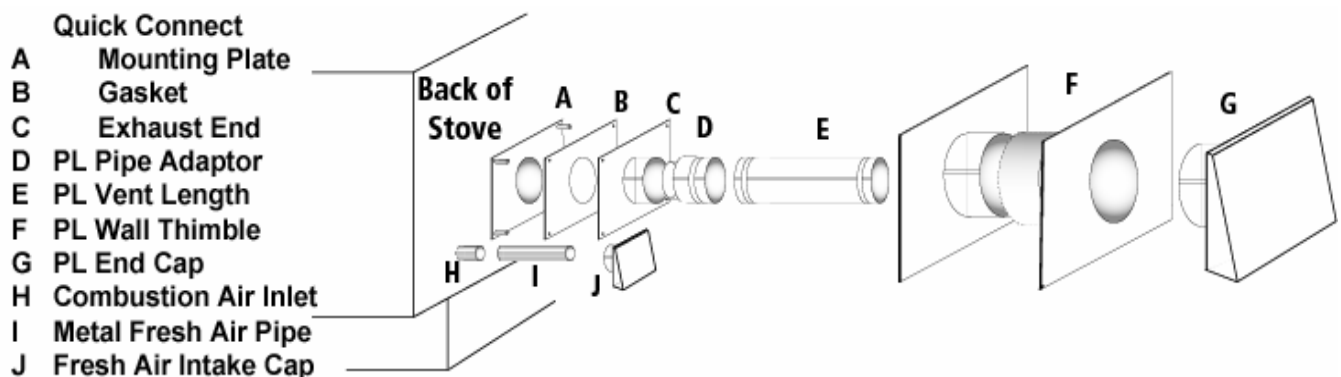

NOTE: Some horizontal, through the wall installations may require a Clean-Out Tee and a minimum 3' vertical rise of pipe inside or outside the building to help draft the stove. This is required if a proper burn cannot be maintained, after the stove has been tested and the airflow set. This is due to backpressure in the exhaust, caused by the airflow around the house.







MOBILE HOME INSTALLATION

CAUTION: DO NOT INSTALL STOVE IN SLEEPING ROOM
THE STRUCTURAL INTEGRITY OF THE MANUFACTURED HOME FLOOR, CEILING/ROOF MUST BE MAINTAINED!

Your **VULCAN "V" SERIES** stove has been tested and listed for mobile home installation. It may be installed in a mobile home as a "Free Standing Stove", a "Hearth Stove", as an "Insert" installed in an existing wood or coal-burning fireplace or as an "Built –In Insert" installed with a mantel.

In addition to all previously detailed installation requirements, mobile home installations must meet the following requirements:

-  Permanently bolt your stove to the floor, (A). Figure 23, 24
-  Electrically ground your stove or the pedestal to the steel frame of the home. Use a number 8 gauge copper wire, (B) figure 24, or equivalent.
-  The stove must have a permanent outside air source with a ¼ inch screen over the inlet. Figure 23, (B,C, D)
-  For transportation all chimney / vent above the mobile home must be removed.
-  "PL" or "L" Vent must be 3" or 4" and must extend a minimum of 36" above the roofline of the mobile home and must be installed using a UL/ULC listed ceiling fire stop (J), figure 23, and rain cap (L), figure 23.

INSTALL VENT AT CLEARANCES SPECIFIED BY THE VENT MANUFACTURER.

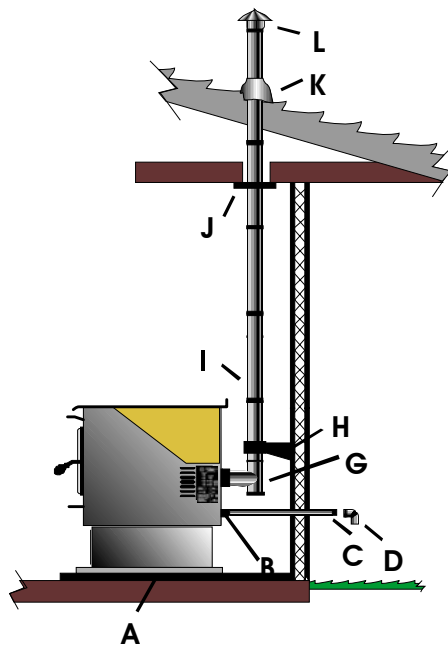

Figure 23

A	Floor Pad
B	Combustion Air Intake
C	Fresh Air Duct
D	Fresh Air Hood
E	Stove Exhaust
F	Pipe Adapter
G	Clean Out Tee
H	Tee Support Bracket
I	Pipe
J	Firestop Spacer / Ceiling Support
K	Roof Flashing / Storm Collar
L	Rain Cap

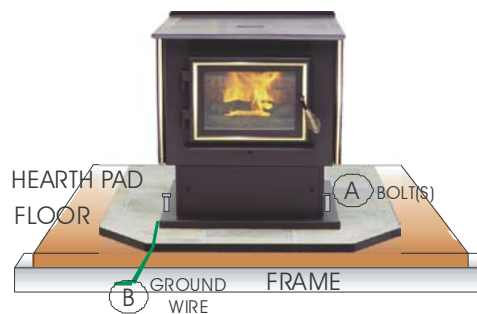

Figure 24

Note: When moving your Mobile Home, all exterior venting must be removed while Mobile Home is being relocated. Upon completion of relocation all venting must be reinstalled and securely fastened.

FIREPLACE INSERT INSTALLATION











VENTING INTO AN EXISTING CHIMNEY:

CAUTION:

MAKE SURE THE CHIMNEY AND FIREBOX ARE CLEAN AND FREE OF SOOT AND ASHES BEFORE INSTALLATION BEGINS. FAILURE TO DO SO MAY RESULT IN THE TRANSFER OF SOOT INTO THE ROOM BY WAY OF THE CONVECTION FAN.

The VULCAN "V" SERIES Insert may be installed in a masonry or factory built fireplace as shown in Figure 25 & 26

INSTALLING SOLID-FUEL INSERTS INTO FACTORY BUILT FIREPLACES:

-  The insert must be tested and meet the requirements of UL 1482 (U.S.) and or ULC 8628 (Canada) when tested in a masonry fireplace built per ULC S628.
-  The factory-built fireplace must be listed per UL 127 or ULC 8610.
-  Clearances obtained from the masonry fireplace tests are also relevant for installation in factory-built fireplaces.
-  Installation must include a full height listed chimney liner meeting type HT requirements (2100 degree F.) per UL 1777 (U.S.) or ULC 8635 (Canada). The stainless steel liner must be securely attached to the insert flue collar and the chimney top.
-  Means must be provided to prevent room air passage to the chimney cavity of the fireplace. This may be accomplished by sealing the damper area around the chimney liner, or sealing the fireplace front.
-  The airflow within and around the fireplace shall not be altered by the installation of the insert (i.e. no louvers or outlet ports are blocked), unless specifically tested as such for each factory-built fireplace manufacturer and model line. (Note - using a louvered faceplate (surround) complies with this requirement).
-  Alteration of the fireplace in any manner is not permitted with the following exceptions;
 1. External trim pieces which do not affect the operation of the fireplace may be removed providing they can be stored on or within the fireplace for re-assembly if the insert is removed.
 2. The chimney damper may be removed to install the chimney liner.
-  Circulating air chambers (i.e. in a steel fireplace liner or metal heat circulator) shall not be blocked.
-  Means must be provided for removal of the insert to clean the chimney flue.
-  Inserts that project in front of the fireplace must be supplied with appropriate supporting means.
-  A permanent metal warning label must be attached to the back of the fireplace stating that the fireplace must be restored to its original condition for safe use with out the insert. This sticker is supplied in the packaging for the insert shroud.

(See Following statement)

**THIS FIREPLACE HAS BEEN ALTERED TO ACCOMMODATE
A FIREPLACE INSERT AND SHOULD BE INSPECTED BY A
QUALIFIED PERSON PRIOR TO RE-USE AS A CONVENTIONAL FIREPLACE!**

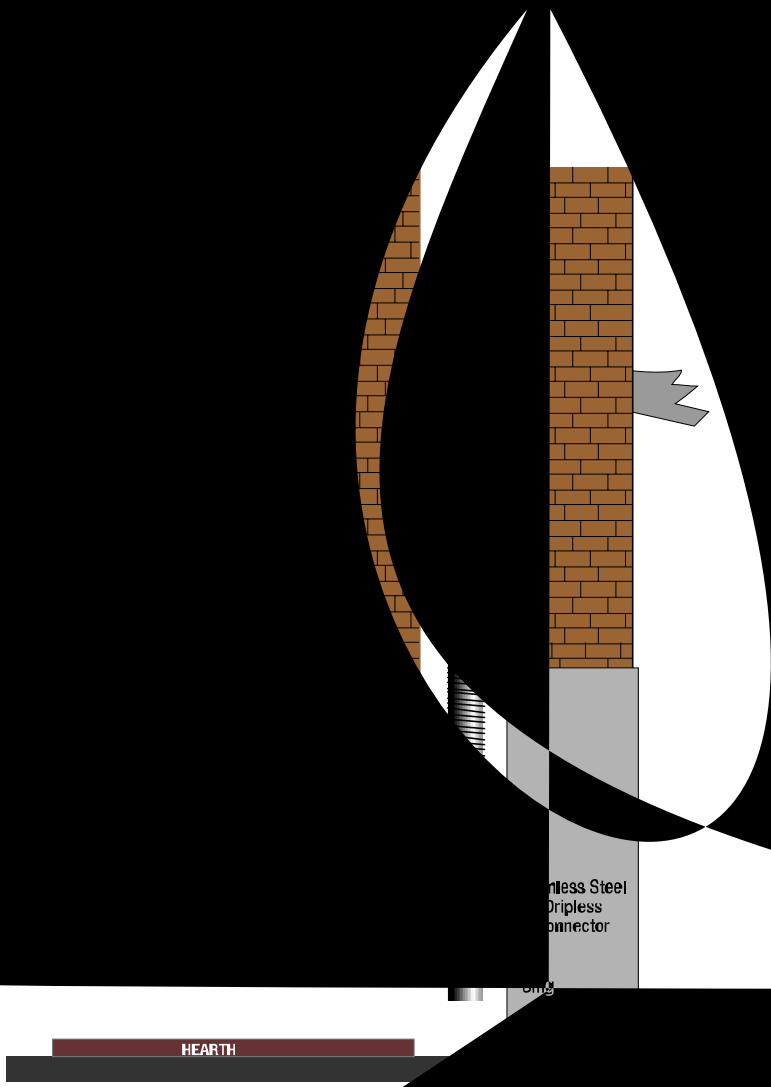

Figure 25

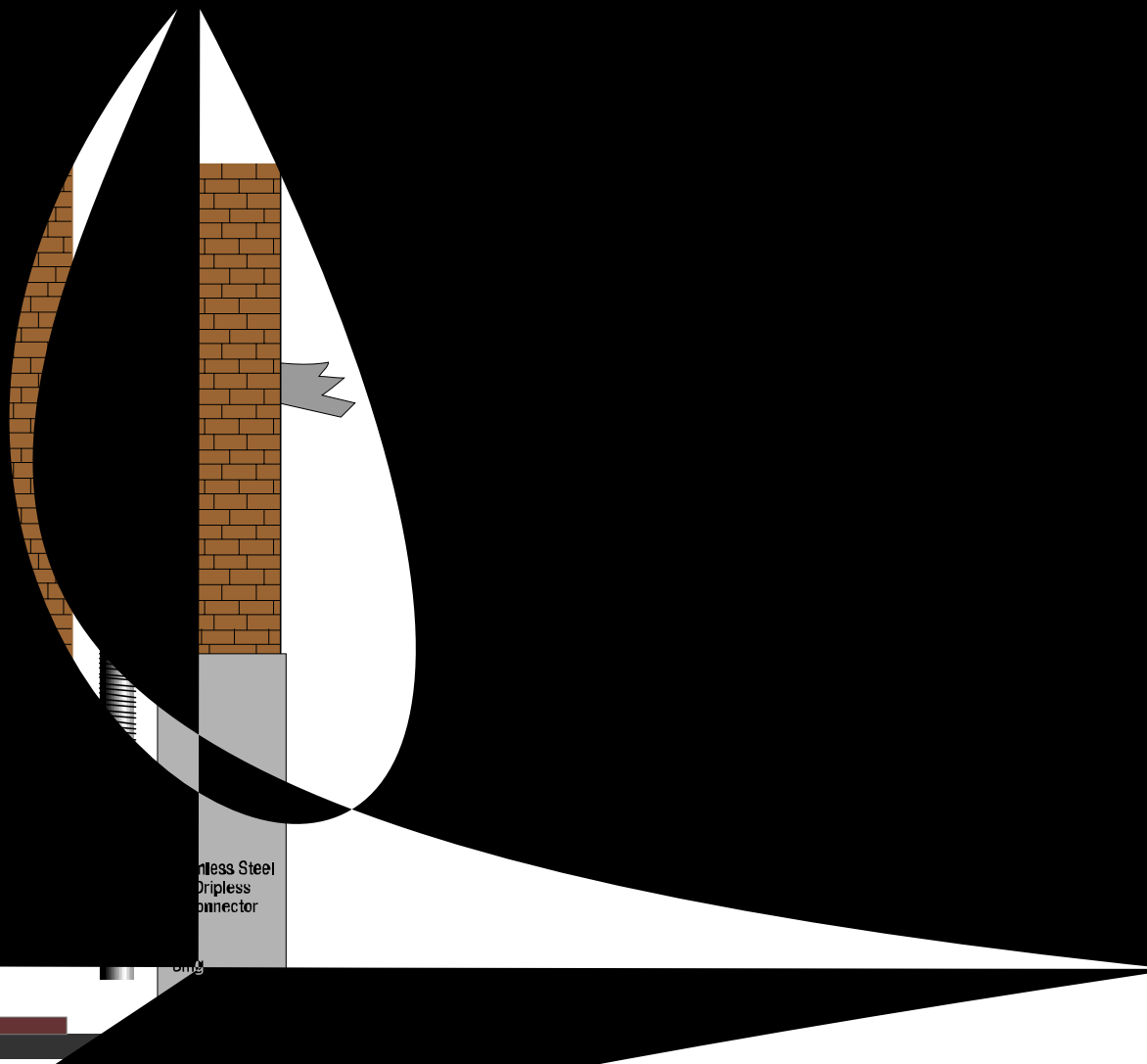
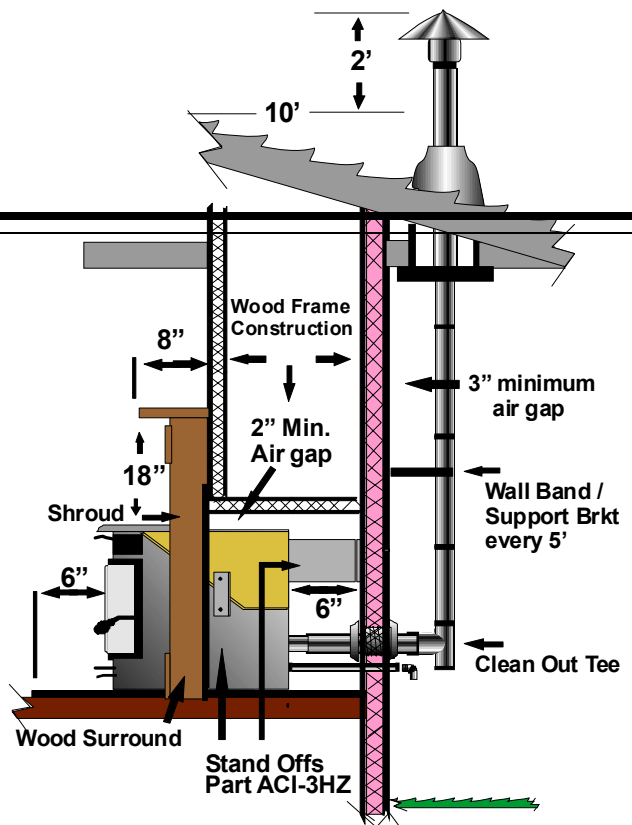

Figure 26

BUILT-IN INSERT INSTALLATION 2'

Horizontal Vent Installation Exterior Wall



BUILT-IN INSERT INSTALLATION . . . CON'T

- 🔥 PELLET VENT MUST MAINTAIN A MINIMUM 3" CLEARANCE TO ANY COMBUSTIBLE (INSTALL VENT AT CLEARANCES SPECIFIED BY THE VENT MANUFACTURER).
- 🔥 DO NOT CONNECT THE PELLET VENT TO A VENT SERVING ANY OTHER APPLIANCE OR STOVE.
- 🔥 DO NOT INSTALL A FLUE DAMPER IN THE EXHAUST VENTING SYSTEM OF THIS UNIT.

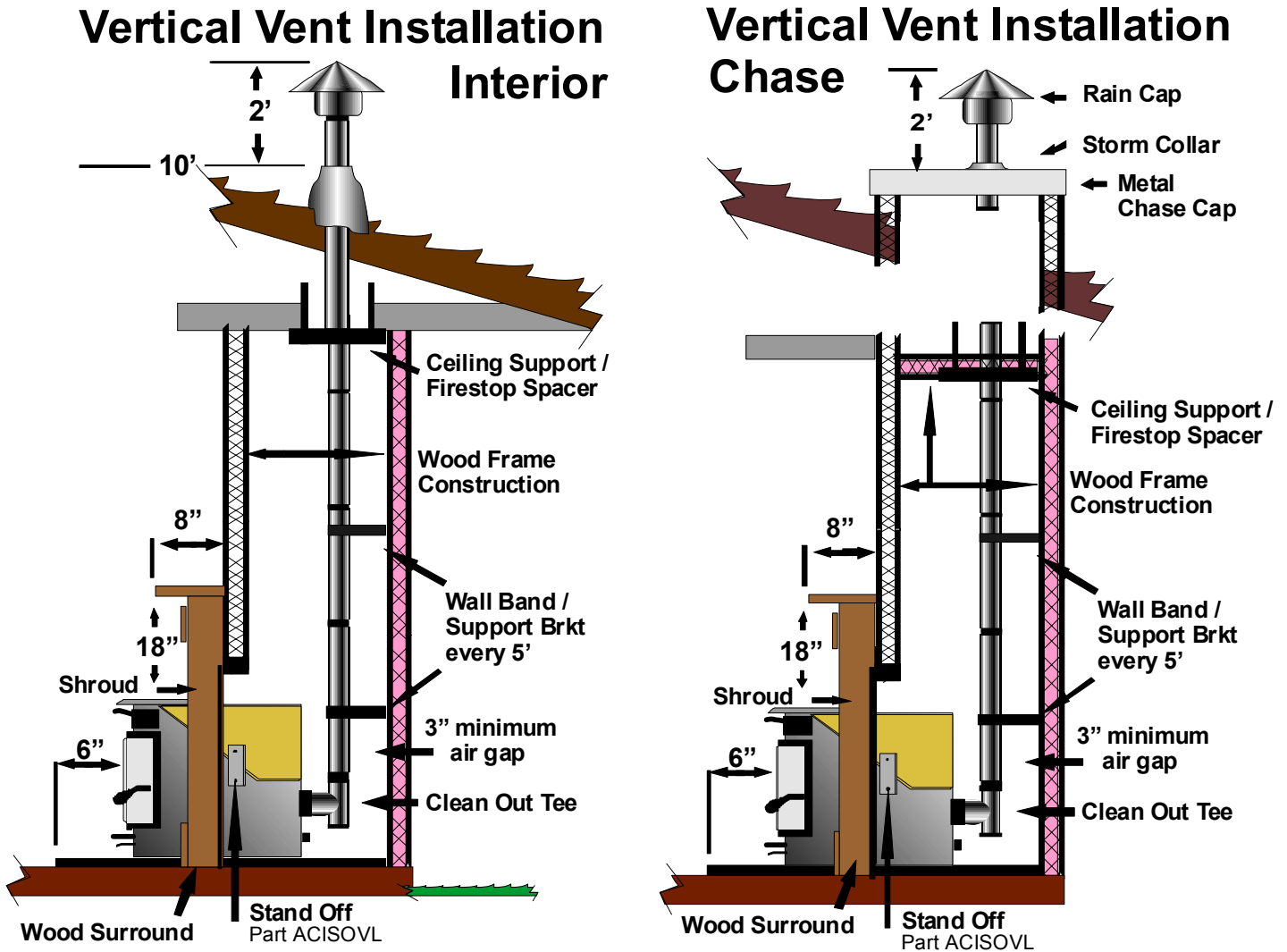

Figure 28

These examples show two styles of vertical install. These require **Spacer Kit # ACI-3VL**. The framed openings for these installations need to be:

	Tradition	Bay View
Height	21"	21 - 25"
Width	28 1/4"	30"
Depth	18"	17"

If constructing a chase, adequate, insulation, vapor barrier, drywall, and caulking must be used.

LIGHTING YOUR STOVE

Before lighting a fire check to ensure the Burn Grate is clean and adjusted and the Ash Tray is not full.
For safety reasons use extra caution when lighting a stove that is HOT!

Lighting stove manually (No Igniter) In the NON-Thermostat Mode

1. Push firmly on the **FEED RATE** or **START** touch pad.
 - The **COMBUSTION FAN** (exhaust) will start and operate at full speed for 60 seconds, then adjust downward to match feed rate #1
 - The **CONVECTION FAN** (heating) will start and the LED will go solid on LOW setting
 - The **AUGER CYCLE** LED will go solid for 3 seconds, indicating signal being sent to auger motor.
2. Place a small amount of a solid fuel fire starter, such as those made from sawdust and wax or use wood shavings, in the bottom of the burn grate.
Add a small handful of pellets to the starter material.
Add a small amount of fire starter over the pellets.

CAUTION: DO NOT USE ANY FLAMMABLE LIQUIDS SUCH AS GASOLINE, GASOLINE-TYPE LANTERN FUEL, KEROSENE, CHARCOAL LIGHTER FLUID, OR SIMILAR LIQUIDS TO START OR FRESHEN-UP THE FIRE! KEEP ALL SUCH LIQUIDS WELL AWAY FROM THE HEATER WHILE IT IS IN USE.

3. Light the fire starter and slowly close the **MAIN DOOR**, leaving it about 1 inch open. When the pellets are burning, close and latch the main door. If the fire goes out when the main door is closed, add more fire starter, re-light the fire and leave the main door open an inch or so until the pellets start to burn, then close and latch the main door.
4. Adjust the **FUEL RATE** and the **FAN SPEED** to your desired settings you require upon completion of startup sequence.

NOTE: If the fire does not start, your stove will continue to feed pellets and the fans will run for approximately 15 minutes. The stove will then automatically shut off. If this happens, some unburned pellets will build up in the burn grate. To restart the fire, clean the excess pellets out of the burn grate and follow the above "Lighting a Fire".

NOTE: Some odors may be given off a new stove during the initial few hours of burning while the stove and the paint are being cured. These odors are not harmful. However, ventilating the room until the odors disappear is strongly recommended.

CAUTION: Never use liquid or volatile fire starters to start a fire in your stove! Do not install or operate your stove in any room where any liquid or volatile fuels or any other highly combustible items are in the air or stored in the room. These could cause a safety hazard.

Lighting stove with Auto-Igniter In the NON-Thermostat Mode

1. Push firmly on the **FEED RATE** or **START** touch pad.
 - The **COMBUSTION FAN** (exhaust) will start and operate at full speed for 60 seconds, then adjust downward to match feed rate #1
 - The **CONVECTION FAN** (heating) will start and the LED will go solid on LOW setting
 - The **AUGER CYCLE** LED will go solid for 3 seconds, indicating signal being sent to auger motor.
 - The **IGNITER** LED will light up solid and the 300 watt igniter will begin to operate.
2. On a primed **AUGER** system pellets will begin to fall into the **BURN GRATE**, and the **AUTO SELF IGNITER** will automatically ignite the pellets in approx. 3 – 5 min.
Note: If stoves fails to light within 15 minutes, shut off the stove, remove the pellets from the burn grate and repeat step 2. If stove fails to ignite a second time, disconnect and contact your dealer.
3. Adjust the **FUEL RATE** and the **FAN SPEED** to your desired settings you require upon completion of startup sequence.

should be set high
mmended to set the
and Fan on MED on

the **AUGER CYCLE** LED with
h pad is pushed [OFF], the auger
will die.

ed manner setting both the
fuel is increased by sett
increased and visa ve

THE CONTROLS ... CONTINUED

TRIM POTS (Fine Tune Adjustments)– Factory Settings

The **COMBUSTION FAN (FAN)**, **HI (4)** and **LO (1) FEED RATE trim pots** have been preset at the factory, but may need to be adjusted onsite after your installation is complete. Due to different installation setups, length and size of venting, and pellet fuel quality, the preset from the factory will not always be correct. These settings will accommodate virtually all wood pellet fuels.

FUEL FEED rates at the Lowest (number 1) and highest (number 4) settings can be adjusted by adjusting the fine tune trim pots located on the control panel. To **raise fuel feed** turn trim pot **counter clockwise** and to **lower** turn **clockwise**. To assist in knowing what the change is you should note the amount of time the light on the **AUGER CYCLE LED** stays OFF.

Lengthening the time this

LED stays OFF lowers the fuel feed and shortening the off-time increases the fuel feed.

COMBUSTION FAN SPEED (FAN)

In a few instances because of prevailing conditions pertinent to your specific installation, or even different batches of pellet fuel, the **COMBUSTION FAN SPEED** may be adjusted to raise or lower the amount of air moving through the grate for the cleanest burn. The **FAN** speed can be adjusted by adjusting the **FAN** trim pot **COUNTER CLOCKWISE to INCREASE** the speed and **CLOCKWISE** of the combustion fan.



Note: If you attempt to adjust the Fuel Feed Trim Pots, use a small precision screwdriver. The Trim Pots do not make a full rotation. If using a metal screwdriver, be gentle as the plastic trim pot slot can be damaged or stripped.

FAN SPEED (Convection or heating)

The **FAN SPEED** controls the speed of the room air fan. This fan blows room air through exchange tubes and back into the room. The **FAN SPEED** has 5 different speeds, these controlled by pushing the **FAN SPEED** touch pad. The **LOW** LED will be solid when on that speed, the **LOW & MED** will both be solid when the next highest speed is selected and when the **FEED RATE** is set to a higher position, the **FAN SPEED** should be set higher accordingly. When the **FEED RATE** is set at [3 OR 4] set the **FAN SPEED** to [MED/HIGH]. If your room air fan's (L140) temperature limit snap switch automatically sets the fan on high when producing heat faster than the fan is carrying it into the room. This may occur when the heat control lever is set at [3 or 4] and the **FAN SPEED** is set to a very low or off setting. After the fan runs at this automatic high setting a few minutes, it may cycle back to its lower setting and continue to cycle between [HIGH] and your selected setting. The circulation (room air) fan cycle from high to low is a normal condition, as well as a safety feature of your appliance.

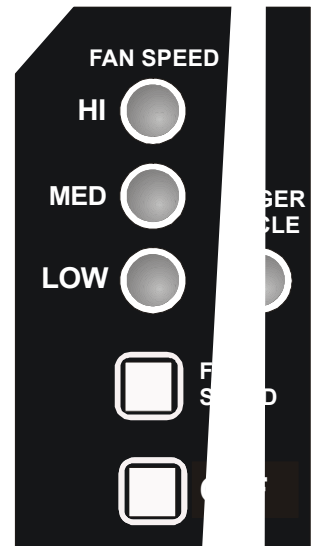

AUGER CYCLE

The **AUGER CYCLE** LED indicates when an electrical signal is being sent to the auger motor. It is NOT used to indicate the actual movement of the auger. When the signal is being sent the LED will be solid for 3 seconds. When the LED is off no signal is being sent.

SHUTTING THE STOVE OFF

Note: DO NOT UNPLUG your stove if there is a fire in the room. Remember the **EXHAUST FAN**...

... if the stove is still active. This could result in smoke coming out of the stove.

On the CCI "AcuTron" Board firmly touch the **STOP** button. The auger will stop feeding fuel into the fire pot. The fire will go out and the fans will automatically shut off and NO LED...

... pad. The **FUEL RATE** LED will turn off. The **AUGER CYCLE** LED will flash indicating that the appliance is in the "Down" mode. The fire will go out and the fans will continue to run until your stove cools down at which time the fans will...

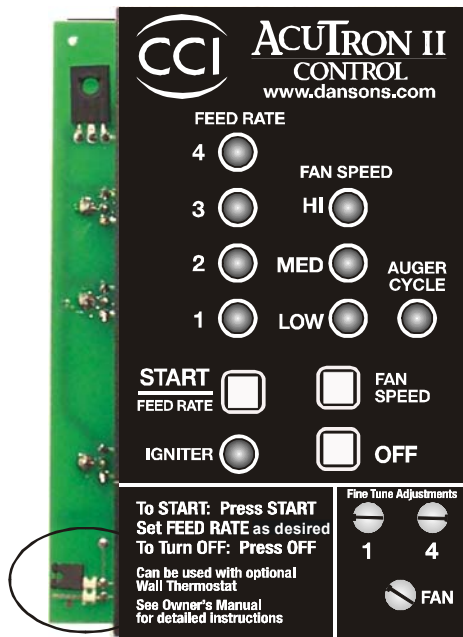

OPERATION

Your pellet appliance is capable of running in an automatic mode with the use of the optional "Wall Thermostat Add-On Kit". The "AcuTron" will then give you a choice, "ON / OFF on Demand" or "LOW / HIGH". The ON / OFF mode automatically turns the heater On and will Shut Off on demand. The LOW / HIGH mode will keep your heater active and cycle between #1 (LOW) setting and your selected (HIGH) setting.

In most circumstances the BEST operation, and recommended, under thermostat control is the LOW / HIGH cycle.

Upon Start Up, in thermostat mode, the default running mode will be the LOW / HIGH mode. (Flashing 3 & 4)

When operating in either mode should your unit run out of pellet fuel it will automatically go through the normal SHUT DOWN cycle. After completing the SHUT DOWN cycle the appliance will try to restart one time only before shutting off completely, till you refill the hopper and reactivate the FUEL FEED pad.

To CHANGE BETWEEN THE TWO MODES,

Press and hold the OFF touch pad firmly, for 3 to 5 seconds, when the FEED RATE LED's #3 and #4 flash together this indicates the thermostat will run in the HIGH / LOW cycle. When the #1 and #2 LED's flash together this indicates the ON / OFF cycle has been chosen.

HIGH / LOW CYCLE Option (Flashing 3 & 4)

Once this mode has been selected, you simply press the START touch pad to activate the stove. You can now select the HIGH heat output level (2,3 or 4) by pushing the START / FEED RATE touch pad, you can also select the FAN setting you desire. When you have selected your high level and fan speeds the LED's will continue to flash. The appliance will automatically start at the #1 feed rate until the Start-up procedure is complete.

The LOW (number 1) or selected High (2,3 or 4) Feed Rate indicator light will light up depending on if the thermostat is calling for heat or not. When the desired room temperature is reached the stove will automatically go into the low heat (#1) cycle. When the temperature in the room drops to the level set at the thermostat, the stove will again cycle to the HIGH (#2,3 or 4) preselected setting. For optimum heat transfer, the FAN setting should be set at LOW or MEDIUM. The appliance will run the FAN at HIGH speed when needed, automatically.

ON / OFF Option (Flashing 1 & 2)

To activate the thermostat to the ON / OFF feature, press and HOLD the OFF touch pad. If the FEED numbers 3 & 4 flash together, you will need to push and hold the OFF touch pad a second time. The numbers 1 & 2 will flash together to indicate that this is the cycle you are in. You can now select the HIGH heat output level (2,3 or 4) by pushing the START touch pad, you can also select the FAN setting you desire. The stove will now go through its normal start up cycle. Once completed the appliance is now in the ON / OFF mode.

The thermostat should be set for the desired room temperature. If the room temperature drops below the level on the thermostat the stove will automatically begin the start-up cycle, as explained in the manual operation section.

Once the start-up cycle is completed the stove run on the pre-selected "HIGH" (number 2,3 or 4) setting, till the temperature is reached. For optimum heat transfer, the FAN setting should be set at LOW or MEDIUM. The appliance will run the FAN at HIGH speed when needed, automatically.

When the desired room temperature is reached the stove will automatically go into the shut down cycle. The pellet feed will stop and the blowers will continue for a controlled time allowing safe shut down of your heater. When the temperature in the room drops to the level set at the thermostat, the stove will again begin the start-up cycle and resume automatic operation.

The Feed Rate numbers 1 & 2 will flash while the appliance is in the OFF part of this mode to give you a visual indication that the appliance is still active and in the ON / OFF cycle.

INITIAL APPLIANCE BURN SETUP

IT IS CRITICAL FOR THE CORRECT OPERATION OF YOUR STOVE THAT THE BURN GRATE, AIR INLET DAMPER, COMBUSTION FAN SPEED, AND 1 & 4 FUEL RATE BE SET CORRECTLY!

A **HIGH QUALITY FIRE** should burn with a brisk, yellow flame. A flame exhibiting a lazy, orange or sooty characteristic is a poor quality and inefficient flame. A poor flame produces less heat, increases sooting and may cause a smoky exhaust. If a poor flame exists for any period of time, clean your stove and exhaust system.

Note: if log option is purchased, do not install until initial setup is complete

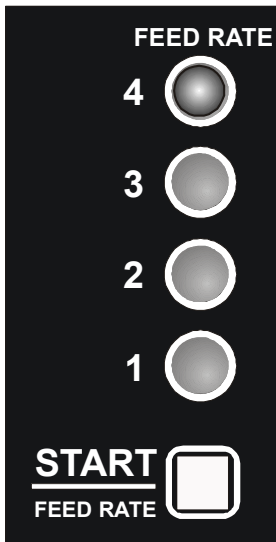

START APPLIANCE AS PER LIGHTING INSTRUCTIONS,

let stove run for approx. 10 minutes before turning the stove to the # 4 setting (or High), to begin to make fine adjustments. **AUGER CYCLE indicator** should be lit "ON" for 3 seconds and "OFF" for 3-5 seconds. Adjust the **AIR INLET DAMPER**. This will have to be set, as the factory sends all units out with the damper wide open to accommodate a wide range of installations and elevations.

AIR INLET DAMPER: Slide open or close damper as needed to obtain a fire that is brisk enough to carry ash out of the grate, but not so brisk that it carries pellets out as well (known as "Pop corning"). Normally you should find that the damper will need to be closed two-thirds to three quarters, but will vary with length of vent run, pellet quality and elevation. The best way to set this is at the **FUEL SETTING #4**.

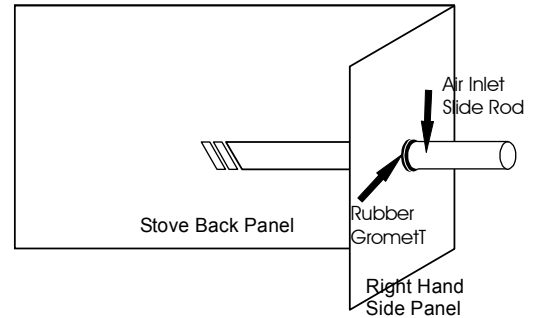

When you are pleased with the burn and how the appliance is operating, you are now ready to set the board up at **LOW** setting.

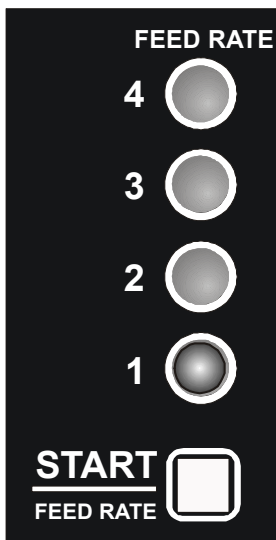

Set **FUEL RATE** to **#1 or LOW setting**. Again let this burn for approx. 10 minutes before making any adjustments. The **AUGER CYCLE** indicator should be "OFF" for approx 9 – 14 seconds between auger turnings (light ON). If "Pop corning" is taking place at this setting adjust the **COMBUSTION FAN SPEED**.

COMBUSTION FAN SPEED (Draft): In a few instances because of prevailing conditions pertinent to your specific installation, or even different batches of pellet fuel, the **COMBUSTION FAN SPEED** may be adjusted to increase or decrease the amount of air moving through the grate for the cleanest burn. Fan speed can be adjusted by adjusting the **FAN** trim pod **COUNTER CLOCKWISE** to **INCREASE** the speed and **CLOCKWISE** to **DECREASE** the speed of the combustion fan.

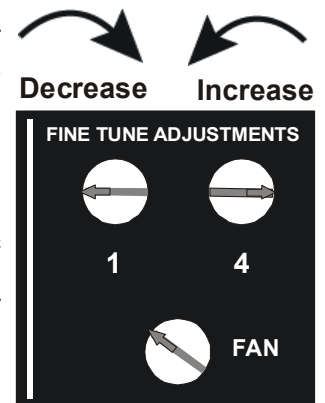

FUEL RATE: Fuel rate at the Lowest (number 1) and highest (number 4) settings can be changed by adjusting the **#1 or #4 TRIM PODS** located on the control panel. To **INCREASE** fuel rate turn trimmer **COUNTER CLOCKWISE** and to **LOWER** turn **CLOCKWISE**. To assist in knowing what changes you made, you should note the amount of time the light on the **AUGER CYCLE** stays "OFF".

Lengthening the time this light stays "OFF"

lowers the fuel feed and shortening the "OFF" time increases the fuel feed. Factory Setting #1 light "OFF" is approx. 9-11 seconds, #4 light "OFF" is 3-4 seconds.

PERFORMANCE ENHANCEMENT TIPS

Quality care and **quality pellets** will help your stove operate at its peak efficiency. Consider:



If any **fin**es are noticed in the pellets or in the hopper, you may wish to screen the pellets.



Periodically check the hopper to make sure there are no fines or pellets building up in the corners of the sloping sides. Clean and polish the hopper as needed.



Be diligent in performing your **CLEANING** and **MAINTENANCE** requirements.

IT IS CRITICAL FOR THE CORRECT OPERATION OF YOUR STOVE THAT THE DAMPER, COMBUSTION FAN SPEED AND HI-LO FUEL FEED RATES BE SET CORRECTLY!

AIR INLET DAMPER:

The damper is a plate that helps control the amount of airflow supplied for combustion. With the damper pushed all the way in the airflow is at its minimum. As the damper is pulled out, more air is allowed to flow through the combustion area.

It will be necessary to monitor the appearance of the flame. Start by running your heater on HIGH (#4) setting for approximately 10 minutes, then push the damper all the way in and evaluate the appearance of the flame. If your flame is smoky red / orange with evidence of soot at the top of the flame, you need more combustion air. Continue to pull out the damper about a 1/8" at a time, opening the damper as needed to obtain a flame that is yellow and a fire that is brisk enough to carry ash out of the grate, but not so brisk that it carries pellets out as well (known as "Pop corning"). Normally you should find that the damper will need to be closed two-thirds to three quarters, but will vary with length of vent run, pellet quality and elevation.

Damper Adjustment Guideline

Lack of Combustion Air:

Symptoms of insufficient combustion air include: unburned fuel, lazy smoky or red / orange flame, excessive ash or soot, excessive buildup on glass, as well as excessive amounts of ash build up in the grate.

Contributing factors: High Altitude – Lack of oxygen, Restrictive Venting, Dirty / Poor quality fuel or the burn grate may not be seated properly.

Excessive Combustion Air:

Symptoms of excessive combustion air include: fuel burns too quickly resulting in smoking or smoldering pellets, white to yellow flame, and the burning pellets will lift off the grate and fly up into the air (popcorning)

Contributing factors: venting system providing excessive draft.

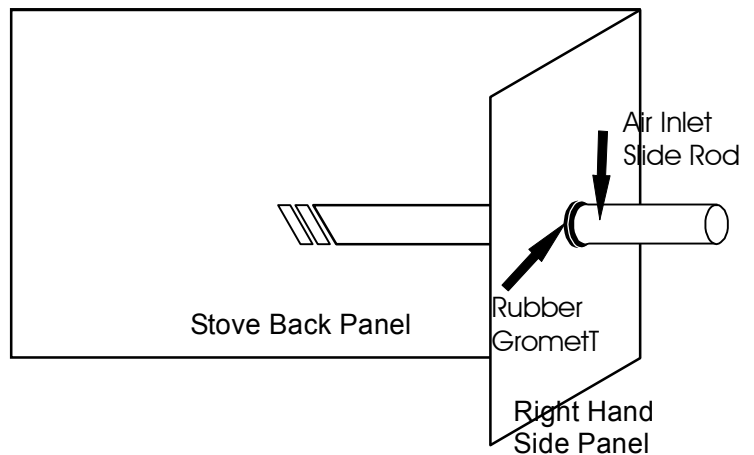

Refer to the "Trouble Shooting Guide" section of this manual, and if necessary, **contact your local Specialty Retailer, Certified HVAC Service Depot, or Dansons Group Inc. Customer Service Department at 1-866-456-9269.**

PELLET FUEL

The performance of your pellet appliance is greatly affected by the type and quality of wood pellets burned. As the heat output of various quality wood pellets differ, so will the performance and heat output of your appliance.

PELLET QUALITY

Your **VULCAN "V" SERIES** stove, with its standard "Super Grate", is designed to burn PFI (Pellet Fuel Institute), "Premium" or "Standard" quality wood pellets. Pellets that are soft, contain excessive amounts of loose sawdust, have been or are wet, produce clinkers and/or heavy ash will result in reduced performance and may actually cause the fire to go out.

PELLET CONSUMPTION

Fuel consumption will vary somewhat between fuel brands and stoves. The following "**ROUGH GUIDE**" to pellet usage's may be useful in assessing your stove's operation, in ordering fuel and in providing information to your Authorized **VULCAN "V" SERIES** Dealer.

Fuel Rate Setting...

Setting	Approx. Burn time on 40lb hopper	Amount of pellets burned
1	20 – 30 hours	1.50 to 2.25 lbs. Per hour
2	15 – 20 hours	2.25 to 3.00 lbs. Per hour
3	10 – 15 hours	3.50 to 4.00 lbs. Per hour
4	7 - 10 hours	4.00 to 5.50 lbs. Per hour

* Fuel flow and burn times quoted are approximate. And may vary with type of fuel used.

FACTORS EFFECTING PELLET FEED RATES

Generally, the smaller, harder and cleaner, free from fines the pellets are the faster they will feed at a given setting and visa versa. The extremes in pellet size and quality can cause several hours difference in burning time for a 40 pound bag of pellets. Heat production is directly related to the pounds of fuel burned per hour. As fuel consumption goes down so will heat output and visa versa. Pellet feed rate, at the same fuel settings, may vary greatly from brand to brand and may vary somewhat from batch to batch within the same brand.

FINE TUNING THE PELLET FEED RATES

If the fire goes out at the LO (# 1) setting the pellets being used may not be feeding fast enough. Likewise if the fire is too high, i.e. burning fuel at the LO (# 1) setting the pellets being used may be feeding too fast. The fuel feed rate for each setting may be increased or decreased somewhat to accommodate different pellets

NOTE: Fine tuning the feed rates beyond the fuel settings provided, involves technical adjustments that you may wish to have performed by an **Authorized VULCAN "V" SERIES Dealer**. There may be a service charge for these adjustments.

ASH and CLINKERS

Ash is a by-product of all pellets. Clinkers may be produced from some pellets and not from others. High quality pellets will produce less ash and fewer clinkers than lower quality pellets.

ASH is a natural product of burning wood. As the amount of ash in the wood increases the amount of ash left after burning high ash wood pellets will increase.

ASH AND CLINKERS CONTINUED

CLINKERS are those solid, glassy or porous accumulations that may result from burning some types of wood pellets. Clinkers are formed in the bottom of the burn grate and if left undisturbed will accumulate and shut off the combustion air. As clinkers grow and shut off combustion air the fire becomes orange/brown and lazy. Pellets may build up in the burn grate. The firebox and window becomes sooty. Exhaust gases may become smoky.

VULCAN "V" SERIES appliances come complete with a "SUPER" grate. These grates reduce the amount of clinkers formed by lower quality pellets. The "Super Grate" is a stationary grate that allows more air flow through the bottom. If ashes are quickly blown out of the grate they cannot easily stay in one spot, heat up to the melting point and fuse into a clinker. Clinkers form when pellets are of such poor quality their ashes contain minerals that easily melt under high firebox temperatures, are not blown out of the grate, and stay there until larger and larger clinkers are produced.

Since wood and the methods of handling wood used in making pellets can vary from plant to plant and year to year some clinking must always be expected. Stove owners without a "SUPER" grate must remove clinkers manually, some times several times a day. Stove owners using a "SUPER" grate and quality pellets may experience days or even weeks of burning without the need to remove any clinkers from the grate.

FINES

FINES in pellets are pieces of sawdust that were not properly formed or are the results of pellets breaking down from handling, transporting and/or storage. Fines adversely affect the operations and heat production of a pellet shop and home heater and greatly increase the requirements for daily and periodic cleaning. Fines cause pellets to feed slower thus reducing the amount of heat produced at any given heat control setting.

NOTE: It is much easier to remove fines from pellets before they are placed in the stove than it is to service your stove for a plugged hopper, jammed auger and plugged exhaust system. Pellets with excessive sawdust may be screened to remove most of the fines. Pellet screeners may be built or purchased from most pellet stove Dealers.

PFI PELLET STANDARDS

The Pellet Fuel Institute, standards for residential quality pellets are:

Length	1.5 inches, maximum.
Diameter	.235 to .350 inches, (approx. 1/4" to 3/8").
Fines:	.2# maximum per 40# bag.
Salts:	.005 % by weight, maximum.
Ash Content:	
- Premium Quality	.75% by weight, maximum, (.3# per 40# of pellets.)
- Standard Quality	2.5% by weight, maximum, (1# per 40# of pellets.)

Check with your Authorized **VULCAN "V" SERIES** Dealer, on the quality of pellets in your local area and for information on what can be expected from the various local brands.

NOTE: Since Dansons Group Inc. or Canadian Comfort Industries has no control over the quality of pellets that you use, we assume no liability caused by the quality of wood pellets used.

CLEANING YOUR SUPER GRATE

INSERTING, REMOVING & ADJUSTING THE BURN GRATE

The burn grate top, (D), must fit and seal firmly on the upper lips, of the burn box, (A). An improper seal will allow incoming combustion air to escape, not passing up through the burn grate thus reducing the amount of combustion air in the area needed to efficiently burn pellets.

- A Burn Box
 - Combustion air is brought into the backside and through the burn grate bottom, back and front
 - Check periodically for fly ash build up
- B "SUPER GRATE"
 - Stainless steel construction, slotted bottom and air holes on front and back
 - Slotted hole for Igniter air flow
- C Adjustment Tab
 - Used to fine tune and level burn grate
- D Super Grate Upper Lip

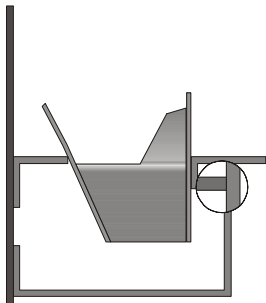
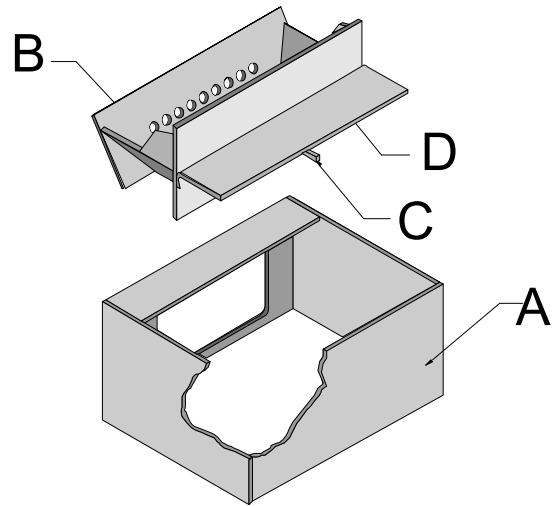

Adjust the burn grate top so that the burn grate top sits firmly on the top of the burn box and level.

Removal of burn grate top:

- (1) Lift upward while sliding lip out from under lip of slide
- (2) Then pull out toward outside of burn box
- (3) Installation is reverse of this.

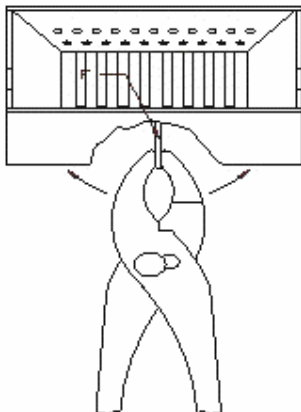
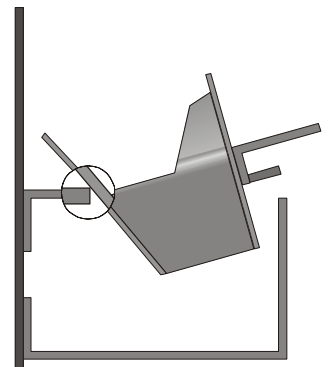

Grasp the burn grate adjustment tab, with a pair of pliers and bend it slightly to left or right (and re-install into burn box) until its length allows the burn grate top to rest tightly onto the burn grate bottom

REQUIRED ROUTINE CLEANING

Proper care of your **VULCAN "V" SERIES** pellet appliance is required for peak, sustained performance. The need for and frequency of cleaning depends on the amount of pellets burned, pellet quality, length of time since last cleaning and the quality of the fire. While becoming acquainted with your new stove and the types of local pellets, **inspect your BURN GRATE, BURN POT, HEAT TUBES, ASH PIT, and WINDOW daily and clean until a pattern of cleaning requirement is determined.** As heating demands increase the need for stove and exhaust system cleaning and ash removal will increase.

WARNING: Disconnect the electrical cord prior to opening the sides of your stove or opening the exhaust system for any inspection, cleaning, maintenance or service work. **NEVER** perform any inspection, cleaning, maintenance or service on a **HOT STOVE** or when the electrical cord is plugged in.

EVERY 2 –3 DAYS / WEEKLY

BURN GRATE: (A)
[COLD STOVE ONLY] Clean as needed, scraping off any residue that may stick to grate bottom or sides.

BURN POT: (B)
[COLD STOVE ONLY] Remove the burn grate. Clean out the burn pot. **CAUTION:** When replacing the grate make sure it fits properly in the burn pot with the lip on the burn grate, toward the front of your stove.

HEAT TUBES: [COLD STOVE ONLY] With your stove's main door closed pull the HEAT TUBE SCRAPER ROD forward and backwards a few times. As different types of pellets produce different amounts of ash, cleaning the tubes enables the heat exchange to operate efficiently.
CAUTION: On a burning stove the heat tube scraper rod will be hot.

ASH CATCHER
NOTE: Place the ash in a metal container with a tight fitting lid. Place container on a non-combustible surface well away from all combustible materials. Retain all ash material in container until all cinders have been thoroughly cooled.

WINDOW CLEANING: [COLD STOVE ONLY as hot glass may cause serious burns] To enjoy a clear view of the fire you should clean your window as needed with a soft cloth or paper towel. You may use a glass cleaner to remove heavy build up on the window. **HOME TIP:** Dampen a piece of newsprint with water, dip this into the fly ash, then rub down the glass. This works like a charm. Do not use abrasive chemical cleaners. **DO NOT OPERATE STOVE WITH BROKEN GLASS AS LEAKAGE OF FLUE GASES MAY RESULT.**

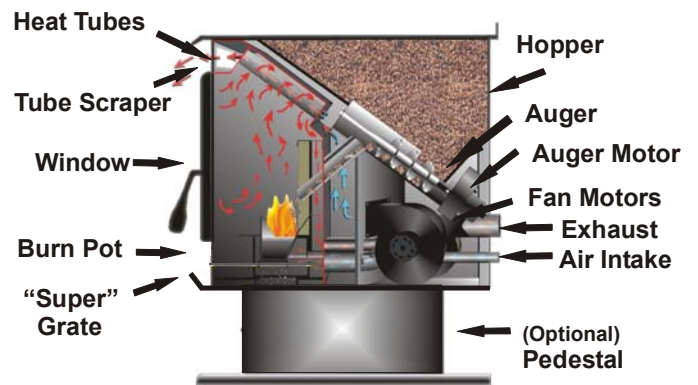

PERIODIC MAINTENANCE

SOOT - FLY ASH:

The by products of combustion contain small particles of fly ash. Fly ash will collect in the exhaust venting system and restrict the flow of flue gases. Incomplete combustion, (such as during startup) shutdown or incorrect operation of the room heater will lead to some sort of soot formation which will collect in the exhaust system. Because of this it is important that the exhaust system be **inspected and cleaned at least once a year to determine if cleaning is needed. It is a good practice to inspect after every 1–2 tons of pellet fuel burning.**

With proper cleaning and the use of quality pellets, your **VULCAN “V” SERIES appliance** requires very little maintenance. However, **the following periodic maintenance is strongly recommended.** This should be performed seasonally, bi-seasonally, or every 1-2 tons of fuel usage.

WARNING: Unplug your stove's electrical cord prior to opening the sides of the stove or opening the exhaust system for any inspection, cleaning, maintenance or service work.

NEVER perform any inspections, cleaning, maintenance or service on a HOT STOVE.

 **ASH TRAPS: [COLD STOVE ONLY]** Remove the back plate from the firebox area. This will expose the two ash traps and the fuel drop shute. Fly ash may be removed by vacuuming inside the trap areas. It is also good to use a brush (bottle cleaner) to reach up and down to scrape the build up off the metal areas.

 **BURN GRATE:** Periodically remove and clean your grate. In particular it is advisable to clean out the holes to remove any build up that may prevent air from moving through grate freely. If grate has become plugged with hard residue from burning lower quality fuel, you may need to use a sharp awl or drill bit to open holes back to their original size.

 **BURN POT:** This is the “pot” where the pellets are burned in the grate. When removing your grate for cleaning, check the burn pot area for ash build up. Some ash will fall through the grate holes and build up under the grate. This needs to be cleaned out to prevent lack of air flow through the burn grate.

 **DOOR GASKET:** Inspect the main door gasket periodically. The main door may be removed to have frayed, broken or compacted gaskets replaced by your Authorized **VULCAN “V” SERIES Dealer.**

 **FAN MOTORS:** Clean the in-take on CONVECTION (ROOM AIR) fan as well as the air holes on the motors of both COMBUSTION and CONVECTION fans annually. Disassemble the COMBUSTION AIR FAN and clean out the internal fan blades as part of your fall start up.

 **FRESH AIR INTAKE:** Inspect periodically to be sure that it is not clogged with any foreign materials. A plugged screen will restrict or shut off combustion air and cause a fire to die or burn poorly.

 **GOLD / BRASS / NICKEL /PEWTER TRIM CLEANING:** Use a damp cloth to clean your door. **DO NOT USE ANY ABRASIVE CLEANERS AS YOU WILL REMOVE OR SCRATCH THE PLATING!**

 **CHECK AND CLEAN THE HOPPER:**
Check the hopper periodically to determine if there is any sawdust or pellets that are sticking to the hopper surface. Clean as needed.

 **GLASS (High Temp, Neo-Ceram):** We recommend using a high quality glass cleaner. Should a build up of creosote or carbon accumulate you may wish to use 000 steel wool and water to clean glass. Ceramic is very hard and will not scratch from the steel wool.

 **GLASS REPLACEMENT:** In the event you need replacement only Neo-Ceram of the correct size and thickness may be used. Contact your local **VULCAN “V” SERIES dealer** to obtain this glass.
DO NOT OPERATE STOVE WITH BROKEN GLASS AS LEAKAGE OF FLUE GASES MAY RESULT.

PERIODIC MAINTENANCE ... CONTINUED

INSPECT AND CLEAN THE CHIMNEY: [ELECTRICAL CORD UNPLUGGED] Under some conditions fly ash build up in the chimney system may occur rapidly. The fly ash will collect in the exhaust venting system and restrict the flow of the flue gases. Incomplete combustion, such as occurs during startup, shutdown, or incorrect operation of the room heater will lead to some soot formation which will collect in the exhaust venting system. Check the clean out tees and elbows in the exhaust system periodically to determine the cleaning schedule. To remove dust from the vent pipe, tap lightly on the pipe to dislodge any loose ash. Open the bottom of the "T" to dump the ash, then vacuum as much of the ash out of the vent pipe as possible. 3 or 4-inch chimney brushes are available for chimney cleaning. If the exhaust system has a screen on it, frequently clean the screen. A plugged screen will shut off combustion air and cause a fire to die or burn poorly.

PAINTED SURFACES: Painted surfaces may be wiped down with a damp cloth. If scratches appear or you wish to renew your paint, contact your Dealer to obtain a can of Satin Black ("Stove Bright") paint.
Tip: use a hair dryer to warm the surface prior to touching up the paint, this helps to reduce paint runs.

Note: Do not use any other brand than "Stove Bright" as they may not be compatible.

FALL START UP: Prior to lighting the first fire check the outside area around the exhaust and air intake systems for obstructions. Clean the screens on the exhaust system and the outside air intake pipe. Turn all controls on to make sure they are working prior to lighting the first fire. Clean and remove fly ash from exhaust venting. Your local Authorized Dealer should have 3" and 4" chimney brushes available. This is also a good time to give the entire stove a good cleaning throughout.

SPRING SHUTDOWN: [COLD STOVE AND COLD ASHES ONLY]. After the last burn in the spring remove pellets from the hopper and the auger. Scoop out the pellets then run the auger until the hopper is empty and pellets stop flowing. Vacuum out the hopper. Thoroughly clean the burn grate, burn box, ashtray and ash traps. It's desirable to spray the inside of the cleaned hopper with an aerosol silicone spray if your stove is in a high humidity area. The **exhaust system** should be thoroughly cleaned.

YEARLY SERVICING: A yearly servicing and cleaning by your Authorized **VULCAN "V" SERIES Dealer** is recommended. A fee may be charged for this service.

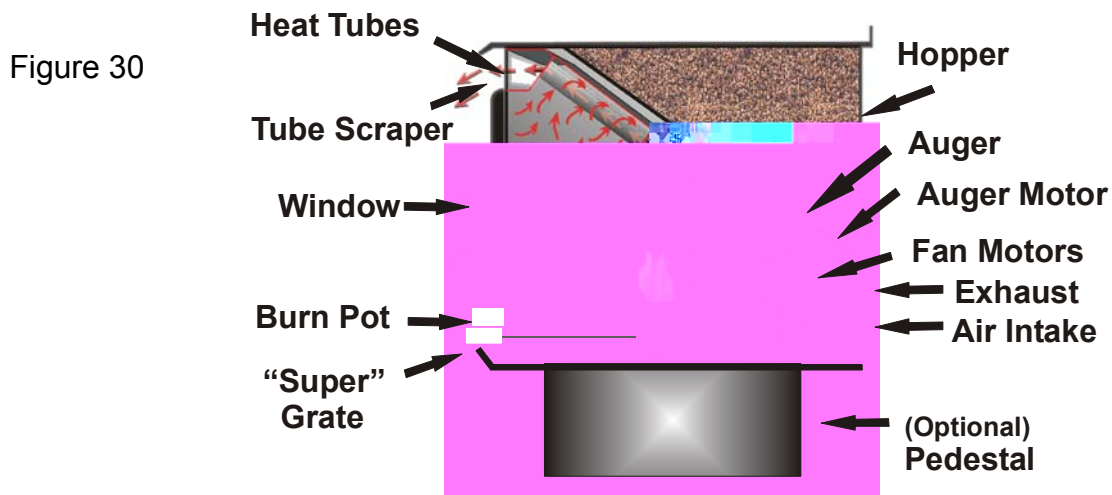

TROUBLE SHOOTING

Proper cleaning, maintenance and the use of quality pellets will prevent the more common stove operational problems. However, when your stove is simply operating poorly or not at all, the following trouble shooting tips may be helpful.

WARNING: Disconnect the electrical cord prior to opening the sides of your stove for any inspection, cleaning, maintenance or service work. **NEVER** perform any inspection, cleaning, maintenance or service on a **HOT STOVE**.

PROBLEM

SOLUTION

Orange, lazy flame.

- * Clean out the burn grate and burn pot.
- * Check the ash traps, clean as needed.
- * Check exhaust system, clean as needed.

Window soots.

- * Check outside air and exhaust screens, unplug if necessary.
- * Check to make sure the main door and ash door are tightly closed.

Pellets build up in burn grate.

- * Check main and ash door gaskets, replace if worn.
- * Check pellet. Replace if moist, wet, dirty or high in ash or "fines".
- * Check with **Dansons Customer Service**.

Fire goes out. Fans will not run when START button is pushed.

- * Check to see that your stove is plugged in and electricity is flowing from the electrical outlet.
- * Check with **Dansons Customer Service**.

Pellets will not feed.

- * Hopper is empty, fill the hopper.
- * Fuel switch has not been pushed to "on".
- * Auger system or controls need service.
- * Exhaust system is plugged. Clean chimney.
- * Check with **Dansons Customer Service**.

Stove runs 30 minutes then shuts off.

- * Start up fire did not catch, light new fire.
- * Check with **Dansons Customer Service**.

Fans do not shut off when stove cools down.

- * Check with **Dansons Customer Service**.

Ash and/or pellet dust in the house

- * Check and correct any leaks in the exhaust system.
- * Take more care in handling ashes, cleaning the window glass, opening the doors slower and pouring pellets into the hopper.
- * Check with **Dansons Customer Service**.

CAUTION: The electrical, auger and heat control components of your stove are not owner serviceable. **Contact your local Specialty Retailer, Certified HVAC Service Depot, or Dansons Group Inc. Customer Service Department at 1-866-456-9269** for proper diagnosis of problems and service of those components.

Note: There may be a charge for all travel, labor and parts on service calls.

LIMITED WARRANTY

The **VULCAN "V" SERIES** wood pellet appliance, carries a five (5) year limited warrant for from the date of sale to the original owner against defects and workmanship on all steel parts, (excluding the burn grate), and one (1) year on electrical components. There specifically is no warranty on the paint, glass, burn grate, fire brick and all gaskets or against damage caused from corrosion.

Extended Warranty

Canadian Comfort Industries will offer an additional **one (1)** year limited warranty on electrical component parts, when your VULCAN "V" SERIES wood pellet stove and insert is installed by a "**Dansons Certified Installer**".

To qualify for this extended warranty the unit must be:

1. Installed by a "Dansons Certified Installer"
2. "**Pre-Delivery & Install Check List**" form must be filled out and received at Canadian Comfort Industries Fax 1-780-960-0430 or online at www.dansons.com/support

There is no written or implied performance warranty on VULCAN "V" SERIES stoves as the manufacturer has no control over the installation, operations, cleaning, maintenance or the type of fuel burned.

This limited warranty will not apply if your stove has not been installed, operated, cleaned and maintained in strict accordance with the manufacturer's instructions. Burning other than quality wood pellets may void the warranty. The warranty does not cover damage or breakage due to misuse, improper handling or modifications.

Your purchase must be registered with **CANADIAN COMFORT INDUSTRIES, INC.** This can be done online at www.dansons.com/support.

All claims under this limited warranty must be made through the dealer where your stove was purchased. If an inspection by the dealer indicates that a limited warranty claim is justified, and all conditions of this limited warranty have been met, the manufacturer's total responsibilities and liabilities shall be to repair or replace, at the manufacturer's option, the defective part(s). All costs of removal, shipment to and from the dealer or manufacturer, any losses during shipment and reinstallation, and any other losses due to your stove being removed, shall be covered by the owner of the stove.

NEITHER THE MANUFACTURER, NOR THE SUPPLIERS TO THE PURCHASER, ACCEPTS RESPONSIBILITY, LEGAL OR OTHERWISE, FOR THE INCIDENTAL OR CONSEQUENTIAL DAMAGE TO THE PROPERTY OR PERSONS RESULTING FROM THE USE OF THIS PRODUCT. ANY WARRANTY IMPLIED BY LAW, INCLUDING BUT NOT LIMITED TO IMPLIED WARRANTIES OF MERCHANTABILITY OR FITNESS, SHALL BE LIMITED TO ONE (1) YEAR FROM THE DATE OF ORIGINAL PURCHASE. WHETHER A CLAIM IS MADE AGAINST THE MANUFACTURER BASED ON THE BREACH OF THIS WARRANTY OR ANY OTHER TYPE OF WARRANTY EXPRESSED OR IMPLIED BY LAW, MANUFACTURER SHALL IN NO EVENT BE LIABLE FOR ANY SPECIAL, INDIRECT, CONSEQUENTIAL OR OTHER DAMAGES OF ANY NATURE WHATSOEVER IN EXCESS OF THE ORIGINAL PURCHASE PRICE OF THIS PRODUCT. ALL WARRANTIES BY MANUFACTURER ARE SET FORTH HEREIN AND NO CLAIM SHALL BE MADE AGAINST MANUFACTURER ON ANY ORAL WARRANTY OR REPRESENTATION.

Some states do not allow the exclusion or limitation of incidental or consequential damages, or limitations of implied warranties, so the limitations or exclusions set forth in this limited warranty may not apply to you. This limited warranty gives you specific legal rights and you may have other rights, which vary from state to state.

APPENDIX "A"

OPTIONAL ACCESSORIES

Description	Model
Doors c/w neo-ceramic glass - Brass Trim	APDRGAS
Grate - "Super Grate"	ACSUGR
Hearth Extension	ACHEEX
Hopper Extension - 6" high (approx. 50lbs.)	APHOEX06
Hopper Extension – 12" high (approx. 100lbs.)	APHOEX12
Insert Shroud Trim - Small – Brass	APSHTSG
Insert Shroud Trim - Small – Stainless Steel	APSHTSS
Insert Shroud Trim - Large – Brass	APSHTLG
Insert Shroud Trim - Large – Stainless Steel	APSHTLS
Self Igniter - 300 watt ceramic igniter assembly	ACIGNAS
Log Set - 1pc Stainless Steel	ACLOGCL1
"Acu-Tron" Wall Thermostat Add-On - includes Thermostat Interface, Wall Thermostat, 25' x18/2 wire	
Fahrenheit -	ACWTKTF
Celsius	ACWTKTC
Wall Thermostat Assembly - includes "Acu-Tron" Control Board, Wiring Harness, Thermostat Interface, Wall Thermostat, 25' x18/2 wire	
Fahrenheit -	ACWTASF
Celsius	ACWTASC

Contact your local Specialty Retailer, Certified HVAC Service Depot, or Dansons Group Inc. Customer Service Department at 1-866-456-9269 for additional information.

Appendix "B"

REPLACEMENT PARTS

Description	Model
Air Deflector	
Air Deflector Louvre - Brass	ACADB
Air Deflector Louvre - Stainless Steel	ACADS
Assembly Packages	
Auger Motor	ACAMTRAS
- includes (1) 2.1 RPM Gear Motor, (1) Auger Motor Bracket w/screws	
Auger Shaft	ACAUSHAS
- includes: shaft and fighting	
Combustion Fan	ACCBFNAS
- includes: (1) Draft Induction Fan, (1) Aluminum Adapter w/screws, (1) 1/8" Fibreglass	
Convection Fan	ACCVFNAS
- includes (1) Centrifugal Blower, (1) 1/8" Fibreglass Paper Gasket	
Igniter	ACIGNAS
- includes (1) 300 watt Ceramic Igniter, (1) igniter Tube Assembly	
Grate Motor	ACGMTRAS
- includes (1) 1 RPM Gear Motor, (1) Grate Motor Bracket w/screws	
Body Panels	
Right Side Stove Panel	
Left Side Stove Panel	
Hopper Lid	
Back Side Stove Panel	
Back Side Slotted Stove Panel	
Pedestal c/w ash drawer	
Ash Lip Drawer	
Insert Slide Top - Black	
Clips	
Door / Glass Clips	ACDRCLP
Door / Glass Air Wash Clips	ACDRAWC
Firebrick Clips (2)	ACFBCLP
Insert Side Panel (pkg 6)	ACISPCLP
Control Panels - Complete	
Standard - Stove	ACSCLTAS
"Acu-Tron" Digital - Stove	ACSCLTDAS
Standard - Insert	ACICLTAS
"Acu-Tron" Digital - Insert	ACICLTDAS
Door Assembly	
Door c/w neo-ceramic glass, - Black	AGDRBAS
Door c/w neo-ceramic glass, - Gold Plated	AGDRGAS
Door c/w neo-ceramic glass, - Nickel Plated	AGDRNAS

Description	Model
Firebrick	
1pc Fibreboard Firebrick Panel	ACFBPL
Gaskets	
Glass Gasket -	ACGLGA
Door Gasket - 60"	AGDRGA60
Combustion Fan - 1/8" Fibreglass Paper Gasket	ACCBFGA
Convection Fan - 1/8" Fibreglass Paper Gasket	ACCVFGA
Ash Door Gasket -	AGADGA
Glass	
Neo-Ceramic - plain -	AGNCGP
Neo-Ceramic - etched - Glow Boy logo	AGNCGE
Grates	
Grate - Standard	ACSDGR
Grate - "Sta-Clean" - top & bottom only	AGSCGR
Grate - "Sta-Clean" Grate Kit	AGSCGRKT
- includes (1) Sta-Clean grate, (1) Grate Motor Assembly, (1) rod, (1)	
Grate - "Super Grate"	ACSLGR
Extensions	
Hearth Extension	ACHEEX
Hopper Extension - 6" high (approx. 50lbs.)	AGHOEX06
Hopper Extension - 12" high (approx. 100lbs.)	AGHOEX12
Kits	
Dealers Standard Parts Kit - 1of each fan, motor, timers, side clips and switches	AGDSPKT
Dealers Stove Analysis Kit	AGDSAKT
- draft guage, volt meter,	
Dwyer Draft Gauge	ACDDG
Volt Meter	ACCVLTM
Knobs & Handles	
Door Spring Handle - Brass	ACDSHB
Fan Control Knob	ACFNCKN
Fuel Control Knob	ACFLCKN

REPLACEMENT PARTS ...continued

Description	Model
Insert Shroud Trim	
Insert Shroud Trim - Small - Brass	AGSHTSG
Insert Shroud Trim - Small - Stainless Steel	AGSHTSS
Insert Shroud Trim - Large - Brass	AGSHTLG
Insert Shroud Trim - Large - Stainless Steel	AGSHTLS
Insert Sliding Top Trim	
Insert Sliding Top Trim - Black	AGITBAS
Insert Sliding Top Trim - Gold Plated	AGITGAS
Insert Sliding Top Trim - Nickel Plated	AGITNAS
Log Set	
Log Set - handcrafted stainless steel - 1 pc.	ACLOGCL1
Switches	
Low Limit Switch - SE-L120	ACLSW120
High Limit Switch - SE-L250	ACHSW250
Fan Limit Switch - SE-L150D	ACFSW150
Igniter Limit Switch - SE-F140	ACISW140
Pressure Switch -	ACPRSW
Illuminated Fuel Rocker Switch	ACFUSWIR
Push Button Start Switch	ACSTSWPB
Fan Speed Control Switch	ACFCTL
Timer Blocks	
Timer Block - 30 minute	ACTMR30M
Timer Block - 3 second	ACTMR03S
Timer Block - AC Phase Control	ACTMRPHA
Fuel Setting Module	ACFUSTMD
Wire	
Wire Harness - Main Assembly - with igniter	ACMNWH
Wire Harness - Control Box Assembly	ACCPWH
3 Prong Plug Power Cord w/ ends	ACPWCDAS
Wall Thermostat Kit	
"Acu-Tron" Board c/w Low Volt Wall Thermostat	ACWTKT

Contact your local Specialty Retailer, Certified HVAC Service Depot, or Dansons Group Inc. Customer Service Department at 1-866-456-9269 for additional information.

