

ACL

- Advanced Central Logger



USER MANUAL

MoTeC

© Copyright – MoTeC Pty Ltd – 2015

The information in this document is subject to change without notice.

While every effort is taken to ensure correctness, no responsibility will be taken for the consequences of any inaccuracies or omissions in this manual.

PN 63028 Rev C, 10 April, 2015

Contents

Introduction	1
Overview	2
System Overview	2
ACL Advanced Central Logger	3
Connected Devices	4
VIM Versatile Input Module	4
Display Devices	4
BR2 Beacon Receiver	5
SLM Shift Light Module	5
E888 / E816 Expanders	6
GPS Global Positioning System	6
PLM Lambda Meter	6
Telemetry Radio System	7
ECU Engine Management Systems	7
Operation	9
PC Communications	9
Software	9
ACL Manager	9
i2 Pro Data Analysis	10
Telemetry Monitor	10
Display	10
Alarms	11
Data Logging	11
Overview	11
Retrieving the Logged Data	14
Track Map Sensor Requirements	14
Functions & Calculations	15
Measurement Inputs	16
Sensors	16
Input Basics	17
Input Types	18
Auxiliary Outputs	22
Communication Ports	22
Installation & Configuration	25
Wiring	25
ACL Central Logger	26
Connected Devices	28
VIM Input Module	28
Display Logger Devices	30
Display Only Devices	31
BR2 Beacon Receiver	31

SLM Shift Light Module	32
E888 / E816 Expanders.....	33
GPS Global Positioning System	34
PLM Lambda Meter	34
Telemetry Radio System	35
ECU Engine Management Systems	35

ACL Manager Software..... 39

Introduction	39
Computer Requirements.....	39
Installing ACL Manager.....	39
Mouse & Keyboard	40
Main Menu	40
Toolbar.....	41
Online / Offline	41
Configuration	41
Configuration Files.....	42
Changing the Configuration	43
Configuration Versions and Updating	44
Channels.....	46
Channel List.....	47
Channel Properties.....	47
Selecting Channels.....	48
Conditions Overview.....	50
Checking Operation	51
Sensor Zeroing	52
Details Editor	52

Windows Keyboard Use 53

Appendices..... 58

Appendix A: ACL General Specifications.....	58
Appendix B: ACL Options Summary.....	59
Appendix C: VIM General Specifications	60
Appendix D: VIM Input Specifications.....	61
Analogue Inputs.....	61
VIM Speed Inputs.....	63
Appendix E: Update Rate Summary	64
Appendix F: CAN Bus Bandwidth Limit.....	65
Appendix G: ACL Manager Command Line.....	67
Appendix H: Comms Error Codes.....	69
Appendix I: Ethernet Communications Cable	73
Appendix J: ECU to ACL Wiring (RS232)	74
Appendix K: CAN Bus Wiring.....	76
Appendix L: Wire Information.....	77
Appendix M: Connector Details	78
Appendix N: VIM Pin List by Function.....	80
Appendix O: VIM Pin List by Pin Number	83
Appendix P: ACL Pin List by Pin Number	85

Appendix Q: ACL Case Dimensions 86
Appendix R: VIM Case Dimensions..... 87

Introduction

Thank you for purchasing a **MoTeC** Central Logging System.

This Manual Covers:

- Overview, Operation, Installation & Specifications for the ACL & VIM.
- Overview of the **MoTeC** ACL Manager software.

Other Manuals

Separate manuals for other devices mentioned in this manual are available from the MoTeC web site.

Sensor Details

Drawings are available for all **MoTeC** sensors and can be found on the **MoTeC** Resource CD (included) or on the **MoTeC** website at www.motec.com.au . The drawings detail the mounting and wiring requirements for each sensor.

Overview

System Overview

The ACL (Advanced Central Logger) forms the heart of a sophisticated and highly configurable data acquisition system. The ACL can be connected to as many as eight VIMs (Versatile Input Modules) to provide measurement of more than 200 inputs. The ACL can also be connected to a display system and many other devices.

The system offers simplicity of configuration with most devices in the system being configured and upgraded from the one software application.

The diagram below shows a typical system consisting of an ACL, two VIMs, SDL display, SLM shift light module, BR2 beacon receiver, PLM lambda meter and M800 ECU. The devices all communicate with the ACL via the 2-wire CAN bus.

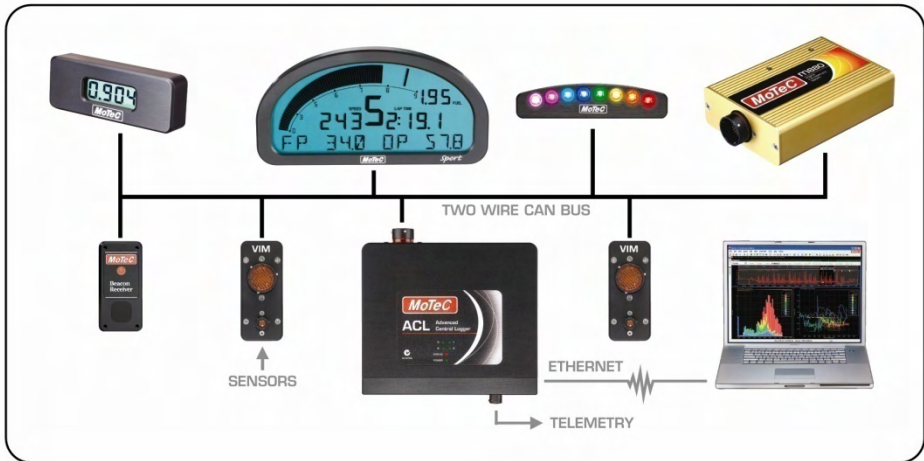

ACL Advanced Central Logger

The ACL collects data from various measurement devices such as VIMs and records the data to the large internal memory. It can also control display devices and collect data from devices such as engine management systems, and perform functions such as Warning Alarms, Fuel Prediction, Engine Logs, Lookup Tables and many more.

The ACL includes 1 gigabyte of logging memory, high speed Ethernet download, dual CAN bus communications and multiple RS232 ports. The ACL can log up to 1000 channels at rates between 1 Hz and 5000 Hz.

Measurement Devices

The ACL uses sophisticated communications technology that allows it to gather data from a number of measurement devices at high speed and in perfect synchronisation.

This allows the measurement devices to be located close to the measurement sources, minimising wiring complexity and weight. This also provides a flexible and expandable system where the optimum number of measurement devices can be used for a particular task.

Options

The ACL has a number of options that allow it to be upgraded to perform additional functions. The options can be enabled at any time by purchasing a password from **MoTeC**.

Refer to Appendix B: ACL Options Summary.

Memory Card

The ACL is fitted with a special high temperature memory card which includes features to protect it against permanent damage during power down. This card must not be replaced with any other type of card.

The card should not be removed from the ACL.

More Information

Refer to the other sections in this manual for detailed information about Software, PC Communications, Logging Operation, Input Measurements, and Installation and Configuration.

Refer to the Appendices for details about Specifications, Wiring and Dimensional information.

Connected Devices

The following topics describe the basic functions of the main devices that can be connected to the ACL.

VIM Versatile Input Module

The VIM is a compact and versatile input expander module with 24 analogue inputs of various types including high speed, high resolution and differential types. The VIM also has two digital inputs with programmable trigger levels.

Up to eight VIMs may be connected to the ACL providing more than 200 sensor inputs. The VIMs connect to the ACL via a CAN bus.

The VIM supports many different types of sensors including unamplified thermocouples and strain gauges.

For more detailed information please refer to the Measurement Inputs section and the Installation and Configuration section in this manual.

For detailed specifications please refer to Appendix C: VIM General Specifications and Appendix D: VIM Input Specifications.

Input Summary

Qty	Input Description	Update Rate (Hz)	Resolution (bits)
6	Analogue Voltage Fast	5000	12
8	Analogue Voltage High Resolution	500	15
2	Analogue Voltage Special	2000	15
8	Analogue Voltage Differential	1000	15 +sign
2	Speed / Digital	100	

Display Devices

A display device may be connected to the ACL to allow display of any value that the ACL calculates, such as lap times, and warning alarm messages.

The ACL supports ADL2, SDL or MDD displays which are connected to the ACL via CAN.

The input and output pins on the display devices are fully accessible (dependant on the I/O options enabled), with exception of access to RS232 and beacon connection on the digital inputs for ADL2 and SDL.

The update rate and other specifications for the inputs are the same as when the display devices are used standalone. Refer to Appendix E: Update Rate Summary.

An exception is the SDL, where SDL inputs AV1 - AV4 can be logged at up to 1000 Hz. Other Analogue Voltage and Analogue Temperature inputs can be logged at up to 500 Hz and the Switch, Digital and Speed inputs at 100 Hz.

For more detail please refer to the Display section and the Installation and Configuration section in this manual.

For other details including specifications and wiring information please refer to the display's user manual.

BR2 Beacon Receiver

A BR2 Beacon Receiver may be connected to the ACL, which allows the ACL to calculate lap times for display and to provide lap information for the data logging analysis software.

Note The BR2 must be connected to the ACL via CAN; the ACL does not support connecting the BR2 to a digital input on the ADL2 or SDL.

Multiple beacon transmitters may also be used to generate split times.

For more detail please refer to the Installation and Configuration section in this manual and the BR2 Beacon Receiver user manual.

SLM Shift Light Module

The **MoTeC** SLM Shift Light Module can be used for shift lights, warning lights and other information lights.

The SLM includes 8 LEDs that can be programmed to any colour.

The SLM connects to the ACL via CAN.

For more detail please refer to the Installation and Configuration section in this manual and the help screens in the ACL Manager software.

E888 / E816 Expanders

The ACL supports two E888 or E816 Expanders allowing expansion of the number of inputs and outputs.

The E888 / E816 connect to the ACL via CAN.

The E888 has 8 x 10 bit thermocouple inputs, 8 x 10 bit voltage inputs, 4 digital inputs, 2 switch inputs and 8 outputs.

The E816 has 16 x 10 bit voltage inputs, 4 digital inputs, 2 switch inputs and 8 outputs.

Note The E888 / E816 inputs have lower resolution than the VIM inputs and have slower update rates. Refer to Appendix E: Update Rate Summary.

For more detail please refer to the Measurement Inputs section and the Installation and Configuration section in this manual.

For other information such as wiring information refer to the E888 / E816 user manual.

GPS Global Positioning System

The ACL supports many GPS (Global Positioning System) devices allowing the ACL to record speed and position information.

This information can be used in the **i2** data analysis software to create track maps, and plot and compare driven lines.

For more detail please refer to the Installation and Configuration section in this manual. For other information please refer to the **i2** help screens and the documentation supplied with the GPS.

PLM Lambda Meter

The ACL supports connection to one or more PLMs (Professional Lambda Meter) via CAN, allowing measurement of the air/fuel ratio on one or more cylinders.

The ACL also supports lambda measurement via an SDL, ADL2 or Engine Management System.

Telemetry Radio System

The ACL supports transmission of data via a telemetry radio to a remote location such as a pit garage. This allows monitoring of the current vehicle condition, position on the track, lap times, fuel remaining, laps remaining etc.

The telemetry system provides three major functions:

1. Real time data that is transmitted continuously and can be shown on graphs, gauges and other displays.
2. End of lap data which shows summary information at the end of a lap such as lap time, maximum temperatures etc.
3. Telemetry analysis which exports the real time data to the *i2* analysis software at the end of each lap which allows normal analysis of the data including maths calculations, while the vehicle is still on the track.

Note This feature requires the Remote Logging option.

Other telemetry features include: warning alarms, position of multiple vehicles on a track map, broadcast data via DDE (Dynamic data Exchange) or via IP (Internet Protocol).

Note The Telemetry option is required for the basic functionality and the Remote Logging option is also required for the Telemetry Analysis function.

For more detail please refer to the Installation and Configuration section in this manual and the documentation supplied with the telemetry system.

ECU Engine Management Systems

The ACL can be connected to most **MoTeC** ECUs (Engine Control Unit or EMS Engine Management System) either via CAN or RS232. This avoids duplication of sensors and allows the ACL to display and log many ECU parameters.

The update rate depends on how many parameters are transmitted, the communications baud rate, and if the communications is via CAN or RS232. For RS232, the typical update rate is about 20 times per second and for CAN it is about 50 times per second.

For more detail please refer to the Installation and Configuration section in this manual and the Engine Management System documentation.

Operation

PC Communications

The ACL includes an Ethernet port which is used for communications with a PC. Most modern PCs have an Ethernet port that can be used for this purpose.

The Ethernet connector on the ACL is the 5 pin Auto Sport connector.

The ACL can be either directly connected to a PC or it can be connected to a network. When connected to a network, any PC on the network may communicate with the ACL.

For details refer to the *PC Communications* topic in the ACL Manager help system.

Software

The ACL comes with various software applications for managing the ACL and its connected devices, and for analysing the logged data and monitoring telemetry data.

The software must be run on an IBM compatible PC running Windows XP or Vista.

The following software applications are provided:

ACL Manager

ACL Manager is used for configuration, testing, retrieving the logged data, and for general management of the ACL.

An overview of ACL Manager is included later in this manual. For detailed information use the ACL Manager help system.

Connected Devices

ACL Manager supports configuration of the following connected devices: VIM, E888 / E816, SLM, ADL2, SDL, MDD.

Communications Cable

ACL Manager communicates with the ACL via an Ethernet cable. Refer to the PC Communications section for setup details.

Firmware Updating

ACL Manager is used to update the firmware in the ACL, VIMs and display devices.

The firmware is field updatable so that new features can be used as they become available.

i2 Pro Data Analysis

i2 Pro data analysis software is used to analyse the logged data that has been recorded by the ACL.

For more detail please refer to the ***i2 Pro*** help.

Telemetry Monitor

The Telemetry Monitor software is used to monitor the optional telemetry link and allows viewing of the telemetry data in various graphical formats such as Charts, Bar Graphs and Dial Gauges. It can also show the vehicles current track position on a track map and compare the current vehicle data to reference data.

Alarms can be set to indicate when a particular value, such as Engine Temperature exceeds a user programmable limit.

Display

A display device can be connected to the ACL which allows display of any measured or calculated value. The display can also show alarm messages.

Configuration, upgrading and testing of the display device must be done using the ACL Manager software. Do not use the configuration software that is normally used with the display device.

For further details relating to the display, refer to the relevant User Manual for the display device being used.

Alarms

Alarms are normally displayed on the bottom line of the connected display device.

The alarms are controlled by the alarm setup within the ACL. When an alarm is activated, a message is shown on the bottom line of the display and a warning light can also be activated.

The message displayed can include the current sensor reading or the sensor reading when the alarm was triggered.

For further details relating to the display of alarms, refer to the relevant User Manual for the display device being used.

Data Logging

Overview

Data logging allows the sensor readings (or any calculated value) to be stored in the ACL for later analysis on a PC using the **i2** Data Analysis application.

Power Supply

Control of the power supply to the ACL is important to maintain the integrity of the data on your ACL. The ACL file system requires a specific power down process to ensure the reliability of your data. The ACL should be powered with permanent power to Pin 2; the ACL's Permanent 12V pin. Pin 22 is the Ignition Input Switch which should be used as a signal to start up and shut down the system. A backup battery can be fitted if required to ensure the ACL shuts down properly under all circumstances.

Logging Memory

The ACL is fitted with a special high temperature memory card which includes special features to protect it against permanent damage during power down. This card should not be removed from the ACL nor be replaced with any other type of card.

Logging Time

The maximum logging time is dependent on the number of items logged and the rate at which they are logged. The configuration software will report the logging time available, taking all these factors into account.

Start and Stop Logging Conditions

To avoid logging data unnecessarily, logging can be started and stopped by user definable conditions. For example, logging might start when the vehicle exceeds 50 km/h, and stop when the engine RPM is below 500 RPM for 10 seconds.

Note The Start Condition must be true and the Stop Condition must be false before logging will start.

Memory Filling Options

When the logging memory is full the ACL will stop logging. However there is an option to cycle through the available memory.

Logging Rate

The logging rate sets how often each channel is logged and can be set individually for each channel.

The rate at which the values are logged is very important – the value must be logged fast enough to record all variations in the reading. If the value is logged too slowly, the readings can be totally meaningless. For example, suspension position normally needs to be logged at 200 times per second or more.

However, if a value is logged faster than necessary it will not improve the accuracy of the logged data, it will just reduce the total logging time available and increase the logging unload time. For example, the engine temperature only needs to be logged once per second.

CAN Bus Bandwidth Limit

High logging rates also increase the amount of data that is being received from the measurement devices which increases the amount of data on the CAN bus. This can lead to exceeding the CAN bus bandwidth limit. Refer to Appendix F: CAN Bus Bandwidth Limit.

Note The ACL Manager will warn if the bandwidth is likely to be exceeded.

Maximum Logging Rate

The maximum logging rate is limited to the update rate of the particular channel. This varies significantly depending on the source of the channel. For example, some VIM inputs update at 5000 Hz, whereas some communications devices may only update at 50 Hz. Also some internal calculations may be limited to 100 Hz.

Update Rate

Each input is measured at a maximum rate which is dependent on the capabilities of the measuring device and may also vary between inputs on that device. For example the VIM has some inputs that update at 500 Hz and others that update as fast as 5000 Hz.

Refer to Appendix E: Update Rate Summary.

Anti-Alias Filter

If a channel is logged at a rate slower than its specified update rate then an optional anti-alias filter can be applied.

The anti-alias filter is used to average out any variations in the signal between logged values. This ensures that unrepresentative values are not logged.

The anti-alias filter is implemented by averaging the channel values between logging events. For example, if a channel has an update rate of 1000 Hz and it is logged at 100 Hz then the preceding 10 samples will be averaged each time it is logged.

The anti-alias filter is normally turned on by default when a channel is added to the logging list, but may be turned off if required. For normal purposes it is recommended that the anti-alias filter is left turned on.

Note For some channels the anti-alias filter cannot be turned on because the averaging performed the filter would cause incorrect values. This is the case for on/off channels and channels where the bit values have a particular meaning, for example error group channels.

Real Time Value (VIM, ADL2, SDL)

For channels that come from a VIM, an ADL2 or an SDL the logging anti-alias filter also affects the real-time value of the channel. This is the value that all other parts of the system see, such as the various calculations.

Note The anti-alias filter is limited to 50 Hz for real time values even if the channel is logged at a lower rate. For example, a channel logged at 10 Hz will be filtered and updated at 10 Hz in the logging and 50 Hz for the real time value.

Note Channels that are not logged are updated at 50 Hz.

Real Time Value (For devices other than VIM, ADL2, SDL)

The real time value from other devices and from internal calculations is not anti-aliased at the logging rate, however the value can be anti-aliased in the logging.

Phase Shift

The anti-alias filter will cause a phase shift (time delay) of half the logging rate. For example, a channel logged at 100 Hz is logged every 10 milliseconds, so it is delayed by 5 milliseconds.

For most purposes this time delay is not an issue.

Channels logged at the same rate are delayed by the same amount, which negates this effect when comparing these channels.

This applies to all channels whether they are generated internally from a calculation or whether they are generated externally from devices such as a VIM or a display device.

Retrieving the Logged Data

A PC is used to unload the logged data from the ACL. The logged data is then stored on the computer's hard disk.

The logged data may be retrieved at very high speed using the Ethernet connection. After each unload, the user has the option to clear the ACL logging memory.

The unload may be interrupted part way through if necessary by disconnecting the computer. The partial unload will contain the most recently logged data and will be stored on the computer's hard disk. In this case the ACL logging memory is not cleared and logging will continue as normal at the end of the existing data. Next time the logged data is unloaded both the new data and the previously partly unloaded data will be retrieved.

Track Map Sensor Requirements

In order for the logging analysis software to plot a track map the following sensors are required and must be logged.

- BR2 Beacon Receiver (Note that the 'Beacon' Channel must be logged)
- Lateral G force
- Wheel Speed
- Longitudinal G force (Optional: See Below)

A Longitudinal G force sensor should be used if the vehicle has only one wheel speed sensor. This allows the analysis software to eliminate wheel lockups which is essential when creating or using a track map.

Alternatively, GPS data can be used to draw a track map in which case the following sensors are required.

- BR2 Beacon Receiver (Note that the 'Beacon' Channel must be logged)
- GPS Latitude
- GPS Longitude

Functions & Calculations

The ACL can perform many other functions and calculations including the following:

Functions:

- Shift Lights – Controls up to 4 staged shift light channels.
- Tell-tales – Stores minimum or maximum values.
- Engine Log (Up to four separate engine logs with separate conditions).
- Diagnostics Log (Event Recorder).

For details on these functions refer to the help in ACL Manager.

Special Calculations:

The ACL can calculate and display any of the following:

- Lap Time, Lap Speed, Running Lap Time, Split Lap Times, Lap Number, Laps Remaining.
- Ground Speed, Drive Speed, Wheel Slip, Lap Distance, Trip Distance, Odometer.
- Lap Time Gain / Loss – Continuously displays how far behind or ahead the vehicle is compared to a reference lap.
- Gear Detection.
- Minimum Corner Speed, Maximum Straight Speed and other Min/Max values.
- Fuel Used, Fuel Usage, Fuel Remaining, Laps Remaining, Fuel Used per Lap.

General Purpose Calculations:

The ACL also provides a number of general purpose calculations including:

- 2D and 3D Lookup Tables
- User Defined Conditions
- General Purpose Timers
- Mathematics
- Bit Combine
- PID Control

The user defined conditions or tables can be used to activate items such as a Thematic Fan or Gearbox Oil Pump.

For details on all calculations refer to the help in ACL Manager.

Measurement Inputs

The ACL's external measurement devices have inputs that can be connected to a wide variety of sensors.

Sensors

Different types of sensors are available to suit different types of measurements, for example: temperature, pressure, movement etc.

Sensors convert a physical measurement (e.g. pressure) into an electrical signal (e.g. volts).

Different types of sensors generate different types of electrical signals. For example most temperature sensors convert the temperature into a variable resistance which may be measured by an Analogue Temperature input, however most wheel speed sensors generate a variable frequency signal which must be connected to either a Digital input or a Speed input.

Sensor Amplifiers

Some sensors may require an amplifier to be connected between their output and the measurement device input. This will depend on whether the measurement device supports direct measurement of the particular type of sensor. For example an ADL2 does not allow direct measurement of thermocouples whereas both the E888 and VIM do.

To connect a thermocouple to an ADL2 a **MoTeC** thermocouple amplifier may be used. The amplifier measures the very weak signal from the thermocouple and amplifies it so that it is suitable for connection to an Analogue Voltage (or Analogue Temperature) input on the ADL2.

Note Sensor amplifiers normal require power to be supplied to them, often a regulated 5 volt or 8 volt supply. This means that they cannot be simply connected to the vehicle battery voltage. The various **MoTeC** measurement devices usually have a number of 5V and 8V sensor supply pins for this purpose.

Amplified Sensors

Some sensors have an internal amplifier to convert the signal from the internal sensing element to a voltage suitable to connect to an Analogue Voltage input or in some cases to a Digital input. Many pressure sensors and crank trigger sensors work this way.

These sensors normally require power to be supplied to them as described for Sensor Amplifiers above.

Input Basics

Calibration

Calibration is the process of converting the electrical value, for example voltage, into a number that represents the physical value, for example temperature.

The calibrations can be selected from a number of predefined calibrations provided by **MoTeC**, or they can be entered by the user.

Read Value Feature

Note To use the Read Value feature in ACL manager, a channel must already be assigned to that pin and sent to the device (unlike the same feature in ADL2 / SDL).

Range

Each input will have a range over which it will work. For example some analogue voltage inputs will work over a range of 0 to 5 volts and others may work over a range of 0 to 15 volts. Similarly digital frequency inputs will only work over a certain range of frequencies.

Caution Operation outside the specified voltage range may cause damage to the device.

The various measurement devices will specify the available input range in their specifications.

Resolution

The resolution is the minimum change that the input can measure. For example an input that has a 12 bit analogue to digital converter can measure 4096 different steps. If the input has a range of 0 to 5 volts, it will have a measurement resolution of 0.0012 volts (5 volts divided by 4096 steps).

The resolution will correspond to a certain physical change. For example, if measuring suspension position, the resolution will correspond to the minimum distance change that can be measured.

For many measurements 12 bits (4096 steps) is sufficient; however there are some applications where a higher resolution is desirable. In this case the VIM can be used to measure up to 15 bits (32767 steps), providing enough resolution for very demanding applications.

The various measurement devices will specify the available resolution in their specifications.

Update Rates

Each input is measured at a certain maximum rate. The rate is dependent on the capabilities of the measuring device and can vary from one input to another. For example the VIM has some inputs that update at 500 Hz and some that update as fast as 5000 Hz.

See the Data Logging section for details on the relationship between logging rates and update rates.

Refer to Appendix E: Update Rate Summary.

Input Types

The various measurement devices have a number of different input types which are designed to suit the different types of sensors.

The various **MoTeC** measurement devices will contain one or more of the following input types.

Analogue Voltage Inputs

Available on: VIM, ADL2, SDL, E888, E816

Analogue voltage inputs are normally used to measure the signals from sensors with variable voltage outputs, such as potentiometers, 3-wire pressure sensors, thermocouple amplifiers, accelerometers.

These inputs can be configured to use several measurement methods to suit the various types of sensors.

Absolute Voltage	The sensor voltage is independent of the sensor supply voltage
Ratiometric Voltage	The sensor voltage is proportional to the 5 V sensor supply voltage
Variable Resistance	The sensor resistance can be entered directly. Note The external pull-up resistor value must also be entered

Converting Analogue Voltage Inputs to Analogue Temperature Inputs

Analogue voltage inputs can be converted to analogue temperature type inputs allowing them to measure 2 wire variable resistance sensors. To do this, a pull-up resistor needs to be connected from the input to the 5 V sensor supply.

Note The VIM has pull-up pins to simplify this. The pull-up pins can be spliced with the desired analogue voltage input, which will connect an internal 1000 ohm resistor to that input pin.

Analogue Temperature Inputs

Available on: ADL2, SDL

The analogue temperature inputs are the same as analogue voltage inputs, except that they have a pull-up resistor connected internally from the input pin to the 5 V sensor supply.

This allows the analogue temperature inputs to be used with 2 wire variable resistance sensors such as 2 wire temperature sensors and 2-wire pressure sensors.

Some voltage output sensors can be used to connect to the analogue temperature inputs if they can drive the pull-up resistor without causing an error in their reading (e.g. **MoTeC** Thermocouple Amplifier).

Additionally, on/off switch signals may be connected if required.

The analogue temperature inputs have the same measurement methods as the analogue voltage inputs.

Thermocouple Inputs

Available on: E888

Thermocouple inputs are specifically designed for measuring K type thermocouples.

Note Isolated tip thermocouples are recommended, however in most cases the E888 will cope with grounded tip thermocouples.

Differential Voltage Inputs

Available on: VIM

These inputs are generally used for strain gauges or thermocouples.

Differential voltage inputs have two input pins which allow them to measure one voltage with respect to another.

A differential voltage input will read a negative value when its positive input is less than its negative input.

Differential voltage inputs generally have a programmable amplifier gain, which allows a small signal to be amplified so that it can be measured with sufficient resolution. The VIM differential voltage inputs have a gain range of 1 to 64.

Note While it is possible to measure negative differential voltages (when the positive input is less than the negative input) both inputs must be within the specified common mode voltage range which may not include negative voltages. In the case of the VIM the common mode range is normally 0 V to 3 V. However, if the first four or the second four inputs all have their gain set to 1, the common mode range for the group of four inputs is 0 to 5 V.

Note Isolated tip thermocouples should be used when connecting to a VIM, because grounded tip thermocouples could force the inputs slightly negative, which is not allowed.

Lambda Inputs

Available on: ADL2, SDL

Lambda inputs allow the direct connection of a wide band lambda sensor.

In the case of the ADL2 and SDL this is a 4-wire Bosch LSM sensor.

Note 5-wire Bosch LSU sensors should be connected via an appropriate amplifier. **MoTeC** has various solutions available to allow connection via an analogue voltage input or CAN.

Switch Inputs

Available on: ADL2, SDL, E888, E816

Switch inputs are generally used for the external toggle switches or press buttons.

Switches are typically used to operate features such as Change Display Mode, Alarm Acknowledge, Fuel Used Reset and other similar functions. They can also be used to monitor items such as brake status.

Normally the switch inputs have a pull-up resistor connected internally from the input pin to the 12 V or the 5 V sensor supply. This allows a switch to be connected between the input pin and 0 V, so that the input is pulled to 0 V when the switch is closed.

Digital Inputs

Available on: VIM, ADL2, SDL, E888, E816

Digital inputs are identical to the switch inputs, except that they include the ability to measure frequency, period or pulse width.

Note Not all these measurement methods are available on all input devices, for example the E888 can only measure frequency.

Speed Inputs

Available on: VIM, ADL2, SDL

Speed inputs are similar to the digital inputs, except that they can also be configured to suit variable reluctance (magnetic) sensors such as some wheel speed sensors.

Because the amplitude of the signal from these sensors varies with speed of rotation, variable trigger levels are required, which must vary with the frequency of the input signal.

The speed inputs can also be used with Hall Effect (open collector output) type wheel speed sensors.

Note It is possible to monitor the voltage of the input signal directly as well as reading the speed. While not intended for precision measurement, this is especially useful when setting magnetic sensor levels, where the measured voltages on the pin can be used to set the trigger voltages.

Internal Sensors

The various measurement devices may also contain internal sensors. For example, most devices measure battery voltage and internal temperature. They may also measure other internal voltages for diagnostic purposes and, in the case of the SDL, an internal accelerometer is included.

Auxiliary Outputs

The ACL has no auxiliary outputs itself, but it can control the auxiliary outputs of the connected devices, such as ADL2, SDL, E888, E816.

These outputs may be used to control various vehicle functions such as: Warning Lights, Thermatic Fan, Gear Box Oil Pump, etc.

Items such as Thermatic Fans or Pump Control should be setup using the user conditions or the general purpose tables. There is no specific setup item for these types of devices.

Refer to the Installation and Configuration section for more information.

Refer to the device specifications for details on the characteristics of its outputs.

Communication Ports

The ACL has various communications ports which are used to communicate with other devices.

Ethernet Communications Port

The Ethernet communications port is used to connect the ACL to a PC which allows configuration of the ACL and unloading of the logged data.

For more detail refer to the PC Communications via Ethernet section

CAN Communications Ports

The ACL has two independent CAN (Control Area Network) Communications ports that can be connected to other devices with a compatible CAN port. The bus speed for each interface can be set independently.

The advantage of CAN over other communication ports such as RS232, is that many devices can be connected to the CAN bus at one time, which

allows all connected devices to communicate with each other. The CAN bus also has the advantage of being able to communicate at high speeds.

MoTeC products that use CAN for intercommunication include M400 / M600 / M800 / M880 engine management systems, BR2 beacon receiver, PLM Lambda meter, VIM input module, SLM shift light module, SDL and ADL2 displays, RTC real time clock, SDC and MDC diff controllers, and MDD mini display.

Note These devices communicate at 1 Mbit/sec, so any other devices connected on the CAN bus must also communicate at 1 Mbit/sec. If a device communicates at another speed, it should be wired to the other CAN bus, and the speed of that CAN bus must be set to match the speed of the device.

Serial Communications Ports

The serial communications ports can be used to receive data from an ECU, a GPS or a similar device with a compatible communications port. They can also be used to transmit data to other devices such as a radio telemetry device.

The port labelled RS232-1 will only send and receive RS232 data, the port labelled RS422 supports both RS422 and RS485 in addition to RS232 data.

Note The ACL can only communicate with devices for which it has the appropriate communications protocol defined.

Installation & Configuration

Wiring

Wire

MoTeC recommends the use of Tefzel insulated wire.

For general sensor hook-up 22# wire is recommended (5 amps maximum at 100 °C ambient temperature)

Note The Tefzel wire is difficult to strip unless the correct stripping tool is used. Be careful not to nick the wires as this may result in wire failure or poor crimping.

Refer to Appendix L: Wire Information for more detail.

Connectors

For details on mating connectors for the ACL and VIM refer to Appendix M: Connector Details. For other products refer to the product's user manual.

To ensure that the connector is sealed, plug unused holes with filler plugs. A heat shrink boot may also be used if desired.

Crimping

Ensure that the correct crimping tool is used for all contacts to ensure a reliable connection.

Refer to Appendix M: Connector Details for information on the appropriate crimping tool.

Ground Wiring

Ground the ACL to a good ground. The ground should have a direct connection to the vehicle battery.

CAN Bus Wiring

The CAN bus has special wiring requirements, refer to Appendix K: CAN Bus Wiring for details.

ACL Central Logger

ACL Mounting

Dimensions

Refer to Appendix Q: ACL Case Dimensions.

Attachment

Attach at the four mounting points using M3 screws. Do not over tighten the screws to avoid twisting the case.

Vibration isolation will help prolong the unit life if the vehicle vibrates severely.

Note The maximum internal operating temperature for the ACL is 85 °C, so it should not be mounted in a position where it will be exposed to temperatures that will cause an internal temperature greater than this.

Orientation

The ACL may be mounted in any orientation however the following points should be considered.

Mount so that the connectors can be easily accessed, particularly the 5 pin communications connector, which is used for configuration and data unload.

Mount so that the status LEDs are visible.

ACL Wiring

Pin Connection Details

Refer to Appendix P: ACL Pin List by Pin Number

Connector

The ACL uses a 22 pin Auto Sport connector for device connection and power, and a 5 pin Auto Sport connector for PC Ethernet communications.

Refer to Appendix M: Connector Details.

Power Wiring

The ACL uses a file system to store the logged data and needs to be shut down correctly to ensure data integrity. The ACL should not have the power disconnected without first shutting it down. Doing so is the equivalent of just pulling the battery out of your laptop to turn it off rather than using the shut down menu. Incorrectly powering down the ACL may corrupt the data on the memory card and should be avoided.

The ACL is ready to be powered off when all LEDs are off.

Note The shut down process can take up to 13 seconds.

Pin 2 of the ACL is the power pin. When the system is starting up, running or shutting down, it will draw its power from this pin. Pin 22 is a switched input that is used to signal to the ACL to begin startup or shut down. If pin 22 has more than 8 volts the ACL will start up, if it is less than 8 volts it will shut down.

One method of wiring this is as follows:

Wire the ACL constant power (pin 2) to the switching side of the master switch, then use a 3 position switch as the ignition switch for the vehicle.

Wire the 3 position switch as follows:

Pos (1): All off

Pos (2): Ignition off, ACL (pin 22) on

Pos (3): Ignition on, ACL (pin 22) on

This setup allows for the ACL to remain on when cranking an engine without ignition power, and also allows for proper shut down by allowing the ignition to be turned off without turning the ACL off.

ACL Setup

All configuration is done using ACL Manager, including configuration of the logging, communications, alarms, display device, VIMs and much more.

ACL Firmware

The firmware controls the operation of the ACL and can be updated as new versions become available. The firmware is included with ACL Manager.

To send new firmware to the ACL, in ACL Manager, select *Online | Upgrade ACL Version* from the main menu.

Connected Devices

VIM Input Module

VIM Mounting

Refer to Appendix R: VIM Case Dimensions.

Attachment

Attach at the four mounting points using M3 screws.

Vibration isolation will help prolong the unit life if the vehicle vibrates severely.

Note The maximum internal operating temperature for the VIM is 85 °C. It should not be mounted in a position where it will be exposed to temperatures that will cause an internal temperature greater than this.

Orientation

The VIM may be mounted in any orientation.

VIM Wiring

The VIMs must be wired to the ACL via one of the ACL's two CAN buses and should be powered from the vehicle battery.

Pin List

Refer to Appendix O: VIM Pin List by Pin Number.

Connector

The VIM uses a 55 pin Auto Sport connector for sensor connection, and a 5 pin Auto Sport connector for power and communications.

Refer to Appendix M: Connector Details.

VIM Inputs

The sensors should be wired to the appropriate input type.

The differential voltage inputs can be used to directly connect thermocouples and strain gauges.

The other inputs can be used for potentiometers, voltage output devices and 2-wire variable resistance sensors.

Note 2-wire variable resistance sensors require a pull-up resistor to be connected. This can be achieved by connecting one of the pull-up resistor pins to the required input pin.

Refer to the Measurement Inputs section for more detail on sensors and input types.

CAN Bus Limits

If using multiple VIMs and fast logging rates, it may be necessary to put some VIMs on one CAN bus and some on the other to avoid exceeding the CAN bus bandwidth limit.

The ACL Manager will warn if the bandwidth is likely to be exceeded. Refer to Appendix F: CAN Bus Bandwidth Limit for details.

VIM Setup

All configuration is done using ACL Manager - There is no separate configuration program for the VIM.

ACL Setup

Inputs Setup

Using ACL Manager, select *Inputs | ACL connections*, then in the Connections screen select *Edit | Add* to add a VIM to the devices list and enter the device's serial number and CAN bus number in the Connection Properties screen.

The various inputs can then be assigned to a channel and calibrated.

Communications Setup

There is no need to configure the communications section of the ACL; this is done automatically if the VIM is configured.

VIM Firmware

ACL Manager will automatically update the firmware version in the VIM if necessary, when sending the configuration to the ACL.

Display Logger Devices

Wiring

The display device must be wired to the ACL via one of the ACL's two CAN buses and should be powered from the vehicle battery.

Refer to the relevant display logger's user manual for further details.

Setup

All configuration is done using ACL Manager.

Important Do not use display's Dash Manager software.

ACL Setup

Inputs Setup

Using ACL Manager, select *Inputs | ACL Connections*, then in the Connections screen, select *Edit | Add* to add one of the supported display devices to the devices list and enter the device's serial number and CAN bus number in the Connection Properties screen.

The various inputs can then be assigned to a channel and calibrated.

Refer to the Measurement Inputs section for more detail on sensors and input types.

Outputs Setup

Using ACL Manager, select *Functions | Auxiliary Outputs* to configure the Outputs in the setup screen.

Displayed Items Setup

Using ACL Manager, Select *Functions | Display* to use the Display Setup screen to configure the displayed items.

Communications Setup

There is no need to configure the communications section of the ACL; this is done automatically if the display device is configured.

Display Device Firmware

ACL Manager will automatically update the firmware version in the device if necessary, when sending the configuration to the ACL.

Display Only Devices

Wiring

The display must be wired to the ACL via one of the ACL's two CAN buses and should be powered from the vehicle battery.

Refer to the relevant display's user manual for further details.

Setup

For the MDD, setup requirements are the same as when the MDD is connected to an ADL2/ADL3.

Refer to the relevant display's user manual for details.

All configuration is done using ACL Manager.

ACL Setup

Displayed Items Setup

Using ACL Manager, Select *Functions | Display* to use the Display Setup screen to configure the displayed items.

Communications Setup

Using ACL Manager, select *Inputs | Communications* to assign the desired Transmit template to one of the CAN sections.

If not using CAN bus 0, click on the Advanced button to select the correct CAN bus.

BR2 Beacon Receiver

BR2 Wiring

The BR2 beacon receiver must be wired to the ACL via one of the ACL's two CAN buses and should be powered from the vehicle battery.

Note When using a BR2 with an ACL, it must be connected to the ACL via CAN. The BR2 cannot be connected to a digital input on any of the other connected devices.

Refer to the BR2 user manual for further details.

BR2 Setup

The BR2 beacon receiver has its own configuration program, however it is not necessary to change the BR2 configuration when using it with an ACL.

Configuration of the BR2 is only required when using its switched output function, which is not supported by the ACL, or if the BR2 switched output is to be connected to another device such as an ECU.

ACL Setup

Inputs Setup

Using ACL Manager, select *Calculations | Lap Time and Number* to configure the BR2 Mode and ID.

Communications Setup

Using ACL Manager, select *Inputs | Communications* to assign the BR2 template to one of the CAN sections.

If not using CAN bus 0, click on the Advanced button to select the correct CAN bus.

SLM Shift Light Module

SLM Wiring

The SLM must be wired to the ACL via one of the ACL's two CAN buses and should be powered from the vehicle battery.

Refer to the SLM drawing, available online at www.motec.com.au, for further details.

SLM Setup

The SLM is configured using ACL Manager, which includes a specific setup screen for the SLM.

ACL Setup

Outputs Setup

Using ACL Manager, select *Functions | Shift Light Module* to configure the SLM.

Note The CAN bus number is also selected in the Shift Light Module Setup screen.

Communications Setup

There is no need to configure the communications section of the ACL, this is done automatically if the SLM is configured.

E888 / E816 Expanders

E888 / E816 Wiring

The E888 / E816 must be wired to the ACL via one of the ACL's two CAN buses and should be powered from the vehicle battery.

Up to two E888 or E816 can be connected.

Note The second expander unit must be configured to a different CAN address by **MoTeC** before it can be connected. This must be specified when ordering the expander.

Refer to the E888 / E816 user manual for further details.

E888 / E816 Setup

There is no separate configuration program for the E888 / E816, all configuration is done via ACL Manager.

ACL Setup

Inputs Setup

Using ACL Manager, select *Inputs | Expander Inputs* to assign inputs to a channel and calibrate the inputs.

Inputs Communications Setup

Using ACL Manager, select *Inputs | Communications* to assign the Expander Inputs template to one of the CAN sections.

If not using CAN bus 0, click on the Advanced button to select the correct CAN bus.

If a second expander is connected, assign the Expander Inputs (2nd Expander) template to another CAN section.

Outputs Setup

Using ACL Manager, select *Functions | Auxiliary Outputs* to configure the Expander Outputs in the setup screen.

Outputs Communications Setup

Using ACL Manager, select *Inputs | Communications* to assign the Expander Outputs template to one of the CAN sections.

If not using CAN bus 0, click on the Advanced button to select the correct CAN bus.

If a second expander is connected, assign the Expander Outputs (2nd Expander) template to another CAN section.

GPS Global Positioning System

GPS units can be connected to the ACL via CAN or via RS232, depending on the unit.

MoTeC GPS

Refer to the appropriate GPS user manual for wiring and configuration details.

Non MoTeC GPS Connection via RS232

GPS Setup

Configure the GPS to send NMEA RMC & GGA messages. Refer to the device's user manual for further details.

ACL Setup

Using ACL Manager, select *Inputs | Communications*, to assign the GPS - Standard RMC GGA template to one of the RS232 sections.

Non MoTeC GPS Connection via CAN

If connecting the GPS via CAN, a custom template will be required to suit the unit. Contact **MoTeC** for details.

PLM Lambda Meter

One or more PLMs can be connected to the ACL via CAN. For installations with multiple PLMs it is recommended that one PLM is configured as a 'Master' and the remaining units as 'Slave' devices.

PLM Setup

Use the separate PLM software to setup the PLM.

ACL Setup

Using ACL Manager, select *Inputs | Communications* to assign the PLM template to one of the CAN sections.

Telemetry Radio System

Telemetry Radio Wiring

A telemetry radio can normally be wired to one of the RS232 ports.

Refer to the wiring details supplied with the telemetry system.

Telemetry Radio Setup

Configure the telemetry radios according to the instructions supplied with the radios.

ACL Setup

Telemetry Output Setup

Select *Functions | Telemetry* to set up the channels that are to be transmitted via telemetry.

Communications Setup

Using ACL Manager, select *Inputs | Communications* to assign the Telemetry template to one of the RS232 sections.

Set the Baud Rate to suit the radio.

Note The same RS232 port can also be used to communicate with an ECU. In this case the telemetry baud rate must be the same as the ECU communications baud rate.

ECU Engine Management Systems

An ECU may be connected to the ACL which will make some of the information in the ECU available to the ACL for display or logging or any other purpose.

The **MoTeC** M4, M48 & M8 ECUs must be connected via RS232.

The **MoTeC** M400 / M600 / M800 / M880 ECUs may be connected via CAN or via RS232.

Many other ECUs are also supported.

ECU Connection via RS232

ECU Wiring

If the ECU sends data via RS232, it may be wired to one of the RS232 ports on the ACL.

Refer to Appendix J: ECU to ACL Wiring (RS232) for details.

ECU Setup

Use the separate ECU Manager software to setup the ECU.

The ECU Telemetry Set and Telemetry Baud Rate should be selected to suit an RS232 communications template supported by the ACL.

ACL Setup

Using ACL Manager, select *Inputs | Communications* to assign the desired ECU template to one of the RS232 sections.

Select the ECU template that matches the ECU type and ECU telemetry set.

In the displayed channel list, tick the channels that are to be received in the ACL.

Note If metric calibration is not used in the ECU, special scaling is required in the ACL communications setup.

ECU Connection via CAN

ECU Wiring

If the ECU transmits data on CAN then it can be wired to one of the ACL's two CAN buses.

Refer to Appendix K: CAN Bus Wiring for details.

ECU Setup

Use the separate ECU manager software to setup the ECU.

Select a CAN Data Set that is supported by the ACL (normally set 1).

The CAN Address must also be entered. Normal value for ACL is 1520. This is a decimal value that corresponds to a hexadecimal value of 0x5F0 in the ACL.

ACL Setup

Using ACL Manager, select *Inputs | Communications* to assign the desired ECU template to one of the CAN sections.

Select the ECU template that matches the ECU type and ECU telemetry set.

In the displayed channel list, tick the channels that are to be received in the ACL.

If not using CAN bus 0, click on the Advanced button to select the correct CAN bus.

Note If metric calibration is not used in the ECU, special scaling is required in the ACL communications setup.

ACL Manager Software

Introduction

The following is an overview of the main concepts of the ACL Manager software. More detailed information is available from the online help provided with ACL Manager. Online help is accessed by clicking on the help buttons that appear on most ACL Manager screens and by selecting Help from the main menu.

The ACL Manager software is used for:

- Editing ACL configuration files
- Sending configuration files to the ACL, VIMs, SDL and ADL2
- Retrieving the logged data from the ACL
- Testing the ACL and connected devices
- Enabling ACL options
- Upgrading the ACL, VIM, SDL and ADL2 firmware versions
- Changing event, venue and vehicle details

Computer Requirements

The PC must be IBM compatible, running Windows XP or Vista.

Recommended Minimum Specifications

Pentium 4 processor, 512 MB RAM memory, Ethernet port.

Installing ACL Manager

From a CD-ROM

Place the CD-ROM into the CD drive of the PC.

A new window will appear. This can be navigated using the on screen buttons.

If the new window does not appear, click on the Windows *Start* button and select *Run*. Type 'D:\moteccd'

Click on the button marked 'Software', then 'ACL'.

Select the version of ACL Manager (or other software) that you wish to install and click on the name.

When the dialog appears asking you to 'Open' or 'Save' the selected file, choose 'Open' and then follow the installation program instructions.

From the Internet

Go to the **MoTeC** web site at www.motec.com.au and navigate to the current release software. Click on *ACL Manager* to start the download and choose to save the file to a location where it can be easily located after downloading (such as the desktop). After downloading double click on the file to start the installation process.

Mouse & Keyboard

The ACL Manager Software may be operated using the keyboard or a mouse.

On many Notebook PCs the pointing device (mouse substitute) is difficult to use and in many cases it is much easier and faster to use the keyboard. For details on using the keyboard refer to the Windows Keyboard Use section later in this manual.

Main Menu

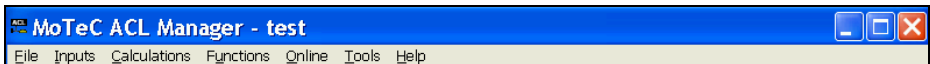

The main menu is used to access all of the features of the ACL Manager software. Click the mouse on one of the menu items or press ALT + the key for the underlined letter in the menu name. For example, press ALT + F to select the File menu.

Unavailable Menu Items

When ACL Manager is started, the items related to changing the configuration will be unavailable because a configuration file has not yet been loaded.

Unavailable items appear in grey as shown below.

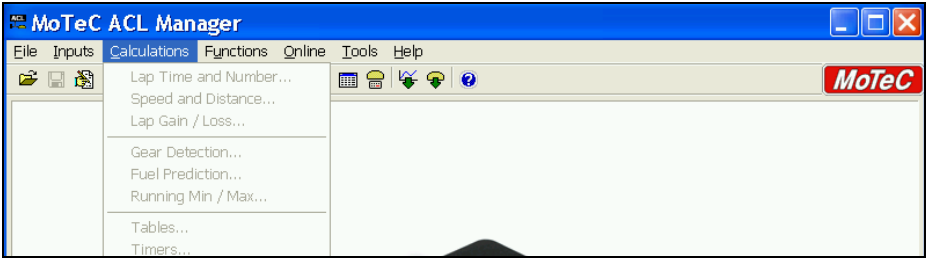

Toolbar

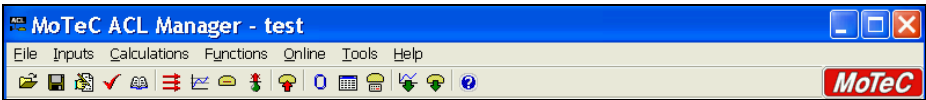

The Tool Bar provides an alternative way of activating some of the commonly used items on the main menu. To find out what each item does hold the mouse pointer over the button of interest until a hint appears.

Online / Offline

All changes to the ACL configuration are performed Offline, i.e. without the PC communicating with the ACL. Once the configuration changes have been made and saved to a file, they can be sent to the ACL which is an Online process, i.e. the PC is communicating with the ACL.

Many other functions are also performed online, for example, Get Logged Data, Zero Sensors, Monitor Active Channels.

Configuration

The configuration of the ACL determines exactly how it operates.

The strength of the ACL lies in its flexibility of configuration. All aspects of the ACL can be configured including; which sensor is connected to which input, the calibration of each sensor, what to display and where to display it, what to log and how fast to log it, tachometer range, warning alarms, multi stage shift lights, etc.

Configuration Files

The ACL configurations are stored in files on the PC hard disk and can be sent to the ACL at any time.

When changing the configuration, changes are only made to the file on the PC. The file must be sent to the ACL before the changes take effect.

Creating a New Configuration File

A new configuration file can be created by selecting *File | New* from the main menu, This will create a new configuration based on one of a number of predefined templates.

After a new configuration has been defined, it should be saved with a meaningful name by selecting *File | Save* from the main menu. The file may then be sent to the ACL by selecting *Online | Send Configuration* from the main menu.

Alternatively a new file can be created by loading an existing configuration file and saving it to a new file by selecting *File | Save As* from the main menu.

Opening an Existing File

Before an existing configuration file can be modified or sent to the ACL it must first be opened.

To open a configuration file select *File | Open* from the main menu and select the desired file.

Note The most recently used files appear at the bottom of the File menu, which is often the easiest way to open a recently used file.

Sending the Configuration to the ACL

The currently open configuration file can be sent to the ACL by selecting *Online | Send Configuration* from the main menu.

When a configuration file is sent to the ACL any changes are automatically saved to the file.

Retrieving the Configuration from the ACL

The configuration can be retrieved from the ACL if necessary by selecting *Online | Get Configuration* from the Online menu. However this is not normally necessary unless the original file is not available on the PC.

Backups

Whenever a file is saved, the previous contents of the file are saved in the 'Save Backups' directory. The total number of backup files is limited to 100.

When a file is sent to the ACL, the existing ACL data is retrieved and stored in the 'From Dash Backups' directory, this is in case the data in the ACL needs to be restored. The total number of these backup files is limited to 10.

File Management

The configuration files may be renamed, deleted, sent to another disk etc by clicking the right mouse button on the desired file when the Open File screen is displayed.

Changing the Configuration

Once an existing configuration file has been opened or a new one created, the various parts of the configuration may be modified by choosing the appropriate items from the main menu. The configuration setup items are accessed from the main menu items: *Inputs*, *Calculations* and *Functions*.

Setup Details

For details on each of the ACL Manager setup screens click on the *Help* button that is provided on each screen.

Configuration Sequence

The configuration is best setup in the following order:

1. Inputs (Input Pins & Communications)
2. Calculations (Lap Time, Fuel Prediction etc)
3. Functions (Logging, Display, Alarms, Auxiliary Outputs etc)

This simplifies the setup procedure by ensuring that the required channels are available for the functions that use them.

Note Channels cannot be used until they have been generated by an input, calculation or function.

Configuration Versions and Updating

Updating

The firmware inside the ACL can be updated by the user at any time to take advantage of the latest features offered by **MoTeC**.

To update the ACL firmware version select *Online | Upgrade ACL Firmware* from the ACL Manager main menu.

Matching Versions

The version of firmware inside the ACL must match the version of the ACL Manager software. If the versions do not match, ACL Manager will show a warning when it attempts to communicate with the ACL.

To check the version of ACL Manager, select *Help | About MoTeC ACL Manager* from the main menu.

Configuration File Version

After the ACL firmware version has been upgraded the configuration file in the ACL must also be updated to match the new version. The display will show a warning until a new configuration has been sent to the ACL.

Note There is an option to automatically upgrade the configuration file in the ACL when performing an upgrade. This eliminates the necessity to manually upgrade the file and then send it. (refer to the Converting Older Version Files section)

Converting Older Version Configuration Files

An older version configuration file can be converted to the latest version by selecting the appropriate version in the 'File of type' entry box on the File Open screen. When the file is opened the file is converted to the new version format and saved with the same file name but with the new version file extension. The old file is not changed.



Converting ADL2 or SDL Configuration Files

A configuration from an ADL2 or SDL can be imported as a starting point for an ACL configuration. This is particularly useful if the ADL2 or SDL will be connected to the ACL with most of the same sensors connected to it.

Note Additional configuration will be required to configure features that are new or different in the ACL.

Channels

Channels are used to convey information between the various systems of the ACL. For example an input pin may feed a channel called 'Engine Temperature'. This channel may then be used by any other system, such as the Display System or Data Logging systems.

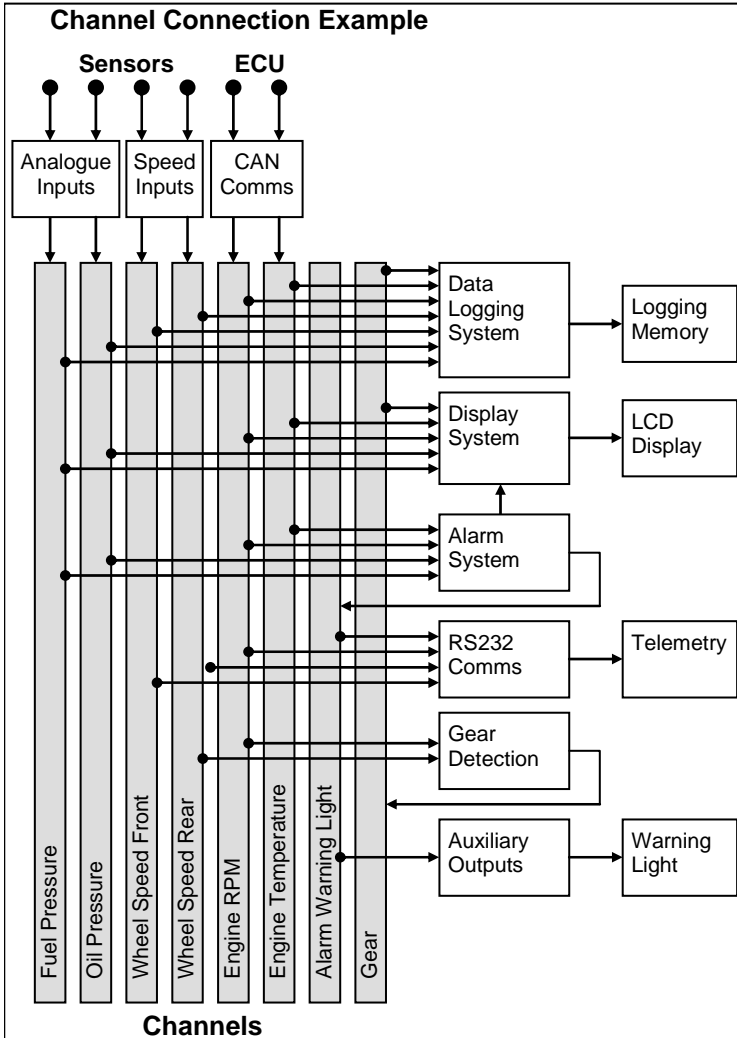

Channel List

MoTeC has defined an extensive list of channels. All systems within the ACL that generate values must choose to feed one of these channels.

General Purpose Channels

Since the use of all channels cannot be predetermined, a number of general purpose channels have been included for occasions when a suitable predefined channel is not available.

These channels may be required when measuring an uncommon value, or when a general purpose function needs to generate a special output channel. For example, a 3D table may generate an output channel to control a valve of some sort, in which case a general purpose channel may be used and renamed appropriately.

Channel Usage

The ACL channel scheme allows complete flexibility in channel usage, as any available channel can be used by any other function, i.e. any channel can be logged, displayed, used in conditions, used in alarms, used as an input to the user definable tables, etc.

Channel Properties

For each channel the following properties have been defined, some of which may be modified by the user.

Properties that may be modified by the user:

- Name
- Abbreviation
- Units (e.g. degrees Celsius, degrees Fahrenheit etc)

Fixed Details

- Measurement type (e.g. Temperature)
- Resolution (e.g. 0.1 °C for Engine Temperature)
- Suitable logging rates
- Suitable display filtering
- Minimum and maximum range

Predefining these properties makes the channels easy to use throughout the rest of the software. Knowing the measurement type allows the channels to be displayed in any unit suitable for that type, with automatic conversion between the units. For example all temperature channels can be displayed in degrees Celsius, Fahrenheit or Kelvin.

Channel Names & Abbreviations

The channel names may be changed if necessary. However name changes should be limited to name preferences rather than redefining the purpose of the channel, except for the general purpose channels which may be renamed to suit the current use.

Channel Units

The units for a channel can be selected from a predefined list, for example the Engine Temperature channel may have units of degrees Celsius, Fahrenheit or Kelvin. Conversion between units is automatically handled by the software.

Note The units are used for display purposes only. This means that the units can be changed at any time without affecting the calibration of the channel.

Channel Resolution

The resolution of all channels is fixed, for example the resolution of the Engine Temperature channel is fixed at 0.1 °C.

Fixed channel resolutions ensure that the unit conversion system works properly and that channel comparisons can be performed correctly.

Selecting Channels

There are two methods of selecting channels, either the Category Method or the Search Method.

Category Method

This method divides all the channels into categories and sub categories, so that the list can be narrowed down to a small list of channels. For example, the 'Engine Sensors / Cooling' category shows a list of channels associated with the cooling system of the engine.

When selecting a channel from the complete list of channels, it is usually easiest to use the category selection method, for example when assigning a channel to an input pin.

To expand a category click on the plus sign (+) next to the category name.

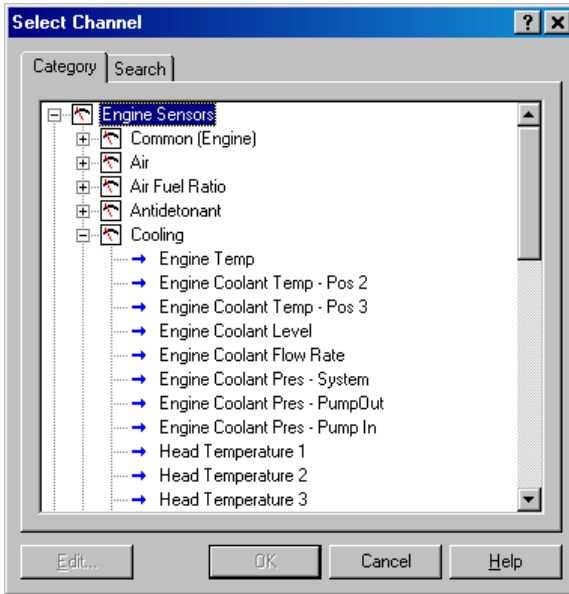

Search Method

This method lists all channels in alphabetical order and allows a channel to be found either by typing the first few letters of any word in the channel name, or by scrolling through the list.

Note The words may be typed out of order so that 'Engine Oil Temp' could be found by typing "temp eng oil" or "oil t eng" or "e o t"

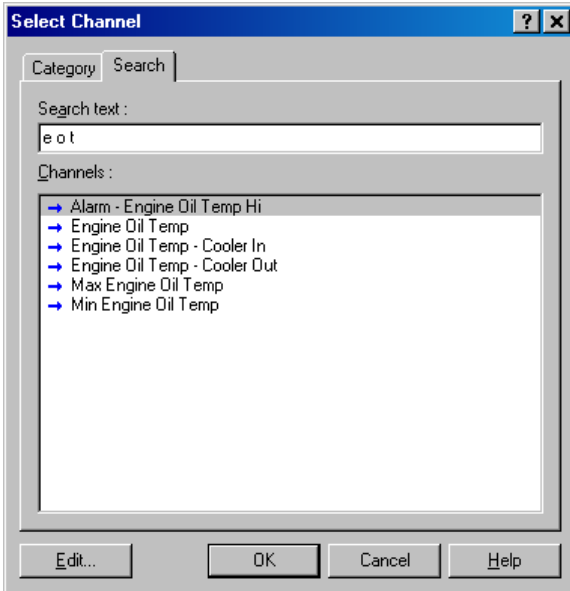

This method is most useful when selecting a channel from the available channels. For example, if 'Engine Temperature' has been assigned to an input pin, it can be easily located in the Search list, since this list normally only contains 50 to 100 items.

Conditions Overview

Conditions are used extensively throughout the software to define a true / false condition based on comparing one or more channels to a value. Most conditions can perform up to 6 comparisons.

Conditions are used to define features such as when to start logging, or when to activate an alarm.

For example an engine oil pressure alarm may read as: Activate the alarm when: Engine Oil Pressure < 200 kPa for 0.5 seconds AND Engine RPM > 1500 RPM for 1 second. This condition could also include a test for lower

engine speeds but set at a lower engine oil pressure, which would cover the range from 500 to 1500 RPM, which might read as: Engine Oil Pressure < 50 kPa for 1 second AND Engine RPM > 500 RPM for 2 seconds.

The following shows an example of an Engine Oil Pressure alarm condition.

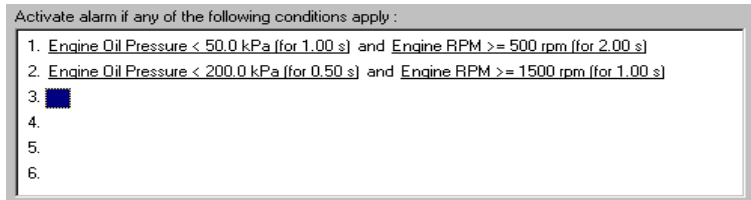

In the case of alarms, the condition can also contain an increment or decrement amount, which may increase or decrease the test value by a certain amount each time the alarm is acknowledged. The number of times this value is incremented can be limited.

Checking Operation

Monitor Channels

The currently active channels can be monitored to allow checking of the operation of all functions and measurements.

To monitor the active channels select *Online | Monitor Channels* from the main menu.

Oscilloscope Screen

Any channel may also be shown on an oscilloscope style screen by pressing the *Utilities | Oscilloscope* button on the Monitor Channels screen.

Simulate

The Simulate feature allows most input channels to be manually changed so that the ACL operation can be checked under abnormal conditions, e.g. high engine temperature.

This is extremely useful for checking that the ACL is working as expected.

To activate the Simulate screen select *Online | Simulate* from the main menu.

Tests

A number of tests are provided to check the operation of the ACL, such as the Inputs Test.

To run one of the tests select the appropriate test from the *Online* menu.

Note To test any input on the ACL, the input must first have a channel and calibration assigned, and have had that configuration sent to the ACL.

Sensor Zeroing

Some sensors require regular zeroing, for example steering angle, suspension position, ride heights, G-force sensors and throttle position. ACL Manager provides a screen to allow easy zeroing of all these sensors.

To zero the sensors select *Online | Zero Sensors* from the main menu.

Details Editor

The Details Editor allows details about the Event, Venue and Vehicle to be entered.

This data is attached to the logged data file for later reference.

Some of this data is also attached to the configuration to determine the operation of some functions, for example, the track length is used to determine lap speed, if used.

To change the details select *File | Edit Details* from the main menu.

Windows Keyboard Use

This section gives some details on how to use the keyboard with Windows applications.

Main Menu

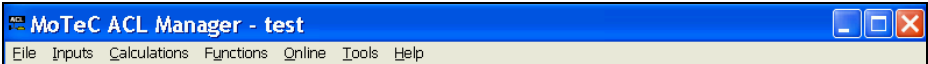

To access the main menu, press ALT + the key for the underlined letter in the menu, followed by the underlined letter of the item in the drop down menu. E.g. ALT + F, N for File New.

Alternatively press and release ALT, select the desired menu item using the arrow keys, press ENTER to activate it.

Closing a Window

Press ENTER for OK or Close (only works when the OK or Cancel button has a bold line around it)

Press ESC to Cancel or Close

Getting Help

To get help on the current screen or screen item press F1, or press ALT + H if the screen has a Help button.

To access the main help system select Help from the Main Menu.

Selecting an Item in a Window

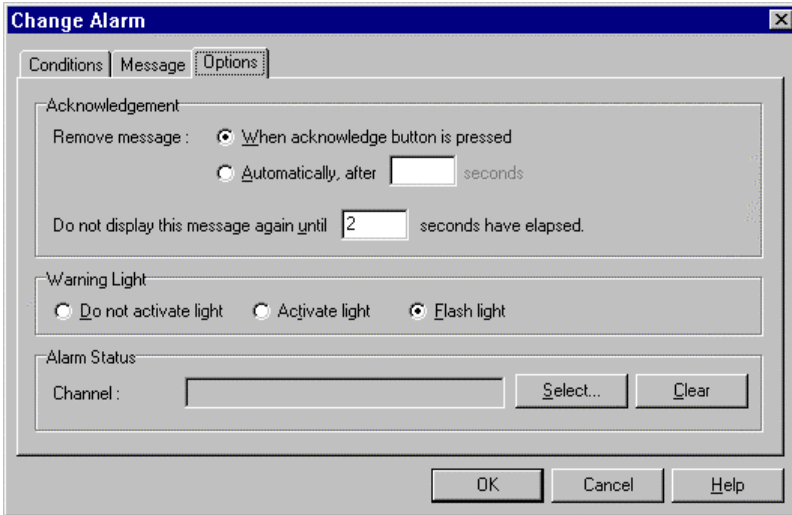

To access the various items in a window, press ALT + the key for the underlined letter of the item of interest, e.g. to select the 'Flash Light' item press ALT + F

Alternatively use the TAB key to move through the dialog box (use SHIFT + TAB to move backwards). The selected control is usually indicated by a dotted line around it, or by highlighting the text or item selected within the control.

Using the Selected Item

The method of using the selected item (or control) depends on the type of control. The common controls are detailed below:

Button

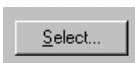

Buttons are generally used to show another screen or perform a particular function.

Press ALT + the key for the underlined letter (S), or use the TAB key to navigate to the Button. To select, press ENTER or SPACEBAR.

Check Box



Flash Message

A check box is used to tick on or off a particular option.

Press ALT + the key for the underlined letter (F), or use the TAB key to navigate to the Check Box. To select, press SPACEBAR.

Radio Buttons

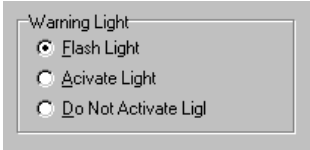

Warning Light

- Flash Light
- Activate Light
- Do Not Activate Light

Radio buttons are used to select an item from a group of options.

Press ALT + the key for the underlined letter (F, A or D), or use the TAB key to navigate to the Radio Buttons group. To select, use the arrow keys.

Edit

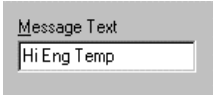

Message Text

An edit control is used to enter a value or text.

Press ALT + the key for the underlined letter (M) or use the TAB key to navigate to the Edit Box, type in the new value or text. Use the BACKSPACE or DELETE to remove unwanted characters.

List

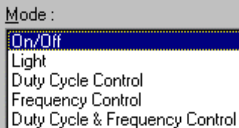

Mode :

- On/Off
- Light
- Duty Cycle Control
- Frequency Control
- Duty Cycle & Frequency Control

A list is used to select from a number of options.

Press ALT + the key for the underlined letter (M) or use the TAB key to navigate to the List Box. To select, use the arrow keys.

Drop down List

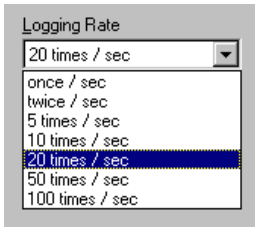

A drop down list is used to select from a number of items, but only the selected item is shown until a new item needs to be selected.

Press ALT + the key for the underlined letter (L) or use the TAB key to navigate to the Drop down List Box. To select the desired item, use the arrow keys, and press ENTER to close the list.

Tabs



Tabs are used to select the different tab pages of a screen.

To select the next tab, press CTRL + TAB. To select the previous tab, press CTRL + SHIFT +TAB.

Tree View

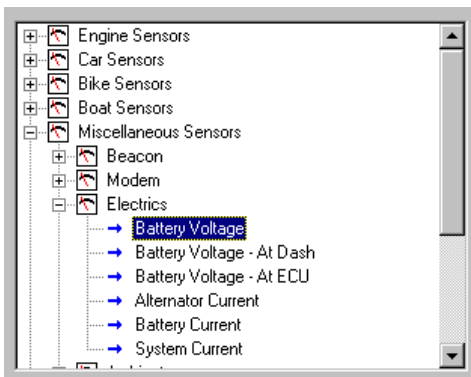

A Tree View is used to select items from a hierarchical list

The UP ARROW key moves the cursor up (selects the item above)

The DOWN ARROW key moves the cursor down (selects the item below)

The RIGHT ARROW key expands; expandable branches indicated by a plus sign (+)

The LEFT ARROW key collapses; collapsible branches indicated by a minus sign (-)

Appendices

Appendix A: ACL General Specifications

Physical

Case Size 151(w) x 134(h) x 28(d) mm (excluding connector)

Weight 460 grams

Power Supply

Operating Voltage: 7 to 30 volts DC

Operating Current: 0.20 ampere typical

Reverse Battery Protection

Battery Transient Protection

Operating Temperature

Internal Temperature Range -40 to 85 °C

Ambient Temperature Range -40 to 70 °C typical

CAN Busses

Maximum Data Rate: 1 Mbit/sec

Recommended terminating impedance: 100 ohms.

Appendix B: ACL Options Summary

The following options are available when the devices are used as part of the Central Logging System.

i2 Pro Analysis Option

Allows use of *i2 Pro* data analysis software.

Telemetry Option

Allows the viewing of live data transmitted from an ACL via radio modem to a PC.

Remote Logging Option

Allows telemetry data to be converted to a log file for analysis.

Appendix C: VIM General Specifications

Physical

Case Size 38(w) x 90(h) x 26.2(d) mm (excluding connector)

Weight 120 grams (0.85 lb)

Power Supply

Operating Voltage: 7 to 30 volts DC

Operating Current: 0.15 amperes typical (excluding sensor currents)

Reverse Battery Protection

Battery Transient Protection

Operating Temperature

Internal Temperature Range -40 to 85 °C

Ambient Temperature Range -40 to 70 °C typical

Sensor Supply Current

5 V Sensor Supply: 0.2 amperes max

Internal Sensors

Battery Voltage

Internal Temperature

Internal Voltages

Appendix D: VIM Input Specifications

Analogue Inputs

VIM Analogue Input Specifications

Input Type	Qty	Update Rate (Hz) ++	Analogue Filter (Hz) *	Digital Filter	Bits	Effective Input Resistance (ohms)
AV F	6	5000	4400	8xAvg **	12	66k
AV H	8	500	330	6.4kHz #	15	150k (Gain=1) 4.7k (Gain=64)
AV S	2	2000	720	6.4kHz #	15	150k (Gain=1) 4.7k (Gain=64)
AV D	8	1000	360	6.4kHz #	15 +Sign	150k (Gain=1) >1M (Gain>1)
AV SPD ##	2	100	7000	None	12	90k @

VIM Analogue Input Specifications Continued

Input Type	Gain Range	Range & Resolution at Gain = 1	Range & Resolution at Gain = 64
AV F	1	0 to 5V, 1.22 mV steps	N/A
AV H	1-64	0 to 5V, 153 uV steps	0 to 78 mV, 2.38 uV steps
AV S	1-64	0 to 5V, 153 uV steps	0 to 78 mV, 2.38 uV steps
AV D	1-64	-5 to +5 V differential, 0 to 5 V absolute, 153 uV steps ***	-78 to +78 mV differential, 0 to 3 V absolute, 2.38 uV steps
AV SPD ##	1	0 to 10.3 V, 2.5 mV steps	N/A

++ If the channel is logged at a lower rate than the update rate an optional anti-alias filter can be applied which averages the values between each log event. In this case the effective update rate is equal to the logging rate. The anti-alias filter causes a phase shift equal to half the logging rate. The anti-alias filter also affects the real time value of the channel which is filtered and updated at the logging rate or at 50 Hz whichever is greater. If the channel is not logged then the real time value is updated at 50 Hz.

* First order RC type. The frequency is the 3 dB point.

** Inputs are sampled at 40 kHz, 8 samples are averaged to give a 5 kHz update rate.

*** This specification only applies if the gains of a group of four inputs are all set to 1 otherwise the differential range is -3 V to 3 V and the common mode range is 0 V to 3 V absolute. There are two groups of four inputs; AVD1-4 and AVD5-8.

5th order digital sync filter. The frequency specifies the 3 dB point.

These inputs are not intended for precision measurements, they are intended for checking the voltage levels of the speed sensors.

@ Input set to magnetic type.

VIM Pull-up Resistor Pins

The Pull-up Resistor pins R1 to R4 have a 1000 ohms resistor internally connected to the 5 V sensor supply.

VIM Analogue Input Sampling Times

This table shows the time at which each input is sampled relative to an arbitrary zero point.

Where multiple VIMs are used, all VIMs are precisely synchronised so that the same inputs on each VIM sample at exactly the same time.

Input	Sample Time (usec)	Update Rate (Hz)
AV F1	100	5000
AV F2	100	5000
AV F3	100	5000
AV F4	100	5000
AV F5	100	5000
AV F6	100	5000
AV H1	1550	500
AV H2	1800	500
AV H3	50	500

AV H4	300	500
AV H5	550	500
AV H6	800	500
AV H7	1050	500
AV H8	1300	500
AV S1	150	2000
AV S2	400	2000
AV D1	550	1000
AV D2	800	1000
AV D3	50	1000
AV D4	300	1000
AV D5	650	1000
AV D6	900	1000
AV D7	150	1000
AV D8	400	1000
AV SPD1	1200	500
AV SPD2	1450	500

VIM Speed Inputs

The Speed inputs can be individually set to be used in one of the two modes: Hall or Magnetic. The VIM Speed input can also be set to measure analogue voltages. This is especially useful when setting levels for magnetic type sensors since the measured voltage can be used to determine the voltage levels to use for the mag levels.

Note The same pin is allocated twice in the VIM, one input is when the pin is being measured in analogue voltage mode. The other input is when the same pin is being measured in a digital mode.

In Hall mode, a 4700 ohms pull-up resistor is connected to 5 V and the trigger level is set with a single Hall Voltage Threshold setting.

In Magnetic mode, the pull-up resistor is disengaged and the trigger levels can be varied depending on the input frequency.

Update rate is 100 Hz for speed measurement.

Appendix E: Update Rate Summary

The following table shows the maximum update rates for the various measurement devices

Device	Input Type	Maximum Update Rate (per second)
ACL	RS232 Communications	200 *
ACL	General CAN communications	200 *
VIM	AV Fast Inputs	5000
VIM	AV Differential Voltage Inputs	1000
VIM	AV High Resolution Inputs	500
VIM	AV Special Inputs	2000
VIM	Speed Inputs	100
ADL2/SDL	Analogue Voltage Inputs 1 to 4 (ADL2/SDL) and 11 to 14 (ADL2)	1000
ADL2/SDL	Other Analogue Voltage Inputs	500
ADL2/SDL	Analogue Temperature Inputs	500
ADL2/SDL	Lambda Inputs	100
ADL2/SDL	Digital & Speed Inputs	100
SDL	Internal G Sensors	100
E888	Thermocouple Inputs (First Device / Second Device)	100 / 50
E888/816	Analogue Voltage & Digital Inputs (First Device / Second Device)	200 / 50

*RS232 & General CAN Communications update rate depends on how frequently the data is sent from the device. Typically the update rate from an M4, M48, M8 or M800 ECU is about 20 times per second using RS232 and about 50 times per second for the M800 using CAN.

Appendix F: CAN Bus Bandwidth Limit

The total available CAN bandwidth available on a single CAN bus is 1 Mbit/sec.

The bandwidth used by the total of all devices on a particular CAN bus must not exceed approximately 90% of this value (900000 bits/second)

If the total bandwidth required exceeds this specification then some devices should be connected to the second CAN bus.

Note ACL Manager will warn if the bandwidth is likely to be exceeded.

VIM

Approximate Bandwidth = Total Measurement Rate (samples/sec) x 30 (bits per sample)

Note The Measurement Rate for each input is equal to the logging rate for that input or 50 Hz, whichever is higher.

Example Calculation

4 channels at 2000 Hz

20 channels at 500 Hz

40 channels at 20 Hz (Occupies 50 Hz)

Calculation:

Total Measurement Rate = $4 \times 2000 + 20 \times 500 + 40 \times 50 = 20000$ (samples/sec)

Approximate Bandwidth = $20000 \times 30 = 600000$ (bits/sec)

E888/E816

Device on first CAN Address

Bandwidth = 145000 (bits/sec)

Device on second CAN Address

Bandwidth = 55000 (bits/sec)

Other Devices

BR2	Negligible
SLM	Negligible
PLM	Negligible
SDL	TBD
ADL2	TBD
MDD	TBD
M800 ECU	TBD

Appendix G: ACL Manager Command Line

Usage:

aclmanager.exe -c[connection name] -x -l -e -t -p -s -u [config file name]

[config file name]

(Optional)

Fully qualified path to the configuration file.

(eg "c:\motec\dash\config\bathurst.d30")

Note The path must include the file extension (eg .d30)

Options:

Each of the following options can be given as /[character] or -[character]. They are shown here as -[character].

-c[connection name]

(Optional)

Select a preconfigured connection by name as configured in the dash connections dialog.

(eg -c"Primary CAN Connection").

Note There must **not** be a space between the c and the connection name.

-x

(Optional)

Causes the application to terminate when one of the following tasks has been performed.

Tasks:

One or more of the following may be specified.

-l

(Optional)

Perform a "Get Logged Data" operation.

-e

(Optional)

Perform a "Get Engine Log" operation.

-t

(Optional)

Perform a "Get Tell-tale Values" operation.

-p

(Optional)

Perform a "Print Summary" operation.

Note The config file must be specified using a fully qualified path including the file extension.

(eg -p "c:\motec\dash\config\bathurst.d30")

Note There must be a space between -p and the config file name.**-s**

(Optional)

Perform a "Send Configuration" operation.

Note The config file must be specified using a fully qualified path including the file extension.

(eg -s "c:\motec\dash\config\bathurst.d30")

Note There must be a space between -s and the config file name.**-u**

(Optional)

Perform an "Upgrade Dash Version" operation.

Appendix H: Comms Error Codes

The "Comms CAN x Diagnostic" and "Comms RS232 Diagnostic" channels seen can be used to diagnose communications problems.

Multiple errors are shown by error codes added together. For example: A RS232 error of 9 = parity + overrun.

The error values have the following definitions:

RS232 Errors

Errors generated by RS232 communications.

1	PARITY	Parity bit incorrect. The comms parity setup is wrong, or there is electrical interference causing errors in the data.
2	FRAMING	Not seeing the stop bit. The baud rate or stop bit setup is wrong or there is electrical interference causing errors in the data.
4	NOISE	Glitch in the data. Electrical interference is causing glitches in the signal. (ACL does not generate this error)
8	OVERRUN	A byte was received before the previous byte was read indicating that the processor was too busy to read the message.
512	NO DATA	A valid message header was not found - either there is a wiring fault or comms is setup incorrectly.
1024	CHECKSUM	A valid message header was found, but the checksum was wrong. If seen in combination with other errors there is electrical noise. If only checksum errors occur there may be a software incompatibility between the ACL and the other device.
2048	WRONG DATA	Could not decode the protocol.

General CAN Errors

Errors Generated by general CAN communications.

2	FRAMING	Only generated when used with an E888/E816 expander. Inconsistent message
---	---------	---

		length.
8	OVERRUN	Receive or transmit overrun error. In the receive case a byte was received before the previous byte was read indicating that the processor is too busy to read the message. In the transmit case the transmit buffer is full which could happen if the CAN bus is too busy.
256	BAD CONFIG	The device configuration is not valid (eg overlapping CAN addresses)
512	NO DATA	A valid message header was not found - either there is a wiring fault or comms is setup incorrectly, (problem could be at either end). E.g.: transmit and receive CAN IDs do not match.
1024	CHECKSUM	Only generated when used with an Async Expander. See RS232 errors
2048	WRONG DATA	Only generated when used with an Async Expander or E888/E816 Expander. Async Expander: Could not decode the protocol. E888/E816: Compound ID incorrect.
4096	BUS WARNING	More than 96 errors have occurred on the CAN bus. Check wiring and termination resistors. The CAN bus may still be operational.
8192	BUS OFF	More than 255 errors have occurred on the CAN bus. CAN communications is suspended when this error occurs. Check wiring, termination resistors and the CAN baud rate. Also check that CAN HI and CAN LO are correct (not swapped).
16384	CAN TRANSMIT	CAN bus transmit warning

"VIMCOM" Errors

Errors generated by "VIMCOM" devices (VIM, ADL2, SDL).

Note VIM COM devices are connected via CAN.

ACL Errors

These errors are generated by the ACL communications system.

2	FRAMING	Incorrect number of samples received.
256	BAD CONFIG	Configuration mismatch between ACL and device. Resend the configuration.
512	NO DATA	VIMCOM packets have not been found. Either there is a wiring fault or ACL Connections is setup incorrectly.
2048	WRONG DATA	VIMCOM packet has bad length.
4096	BUS WARNING	More than 96 errors have occurred on the CAN bus. Check wiring and termination resistors. The CAN bus may still be operational.
8192	BUS OFF	More than 255 errors have occurred on the CAN bus. CAN communications is suspended when this error occurs. Check wiring, termination resistors and the CAN baud rate. Also check that CAN HI and CAN LO are correct (not swapped).

VIMCOM Device Errors.

These error codes are sent once by the VIMCOM device on resuming data transmission and therefore indicate why data was previously not being transmitted.

4097	STARTUP	Device has restarted (normally due to power up) Data is not sent until sync is achieved.
4098	HALT	Data not sent due to deliberate halt. For example configuration or firmware being sent.
4099	OVERRUN	Data not sent due to transmit buffer overrun (possibly due to CAN bus too busy)
4100	SYNC TIMEOUT	Data not sent due to ACL sync message timeout (sync not received from ACL)
4101	CAN ERROR	Data not sent due to error on CAN bus

4102	SYNC EXCEEDED	Data not sent due to excessive sync error (synchronisation too far out)
------	------------------	--

Appendix I: Ethernet Communications Cable

The ACL communicates with a PC via a CAT5 Ethernet cable that is terminated with a 5 pin Auto Sport connector.

Only 4 of the 8 Ethernet wires are required as shown in the schematic below.

The wire must be CAT5 UTP.

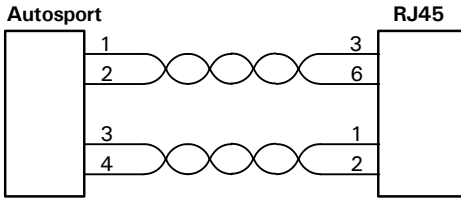

Appendix J: ECU to ACL Wiring (RS232)

The following details the methods for connecting the various **MoTeC** ECUs to the ACL via RS232. In all cases this is done using the serial data stream generated by the Telemetry function of each ECU.

In the case of the M800, M880 and M4e the ACL may be directly wired to the ECU because these ECUs use RS232 interface levels. On the M48, M4 (pre M4e) and the M8, a Computer Interface Module (CIM) or a PCI cable is required to convert the signals to RS232.

M800 / M880

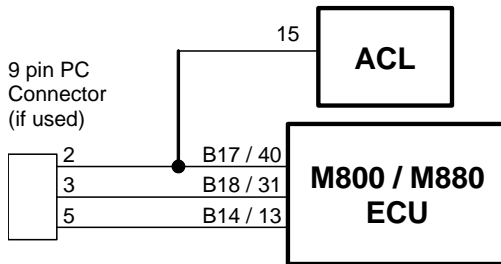

Note The data to the ACL will be interrupted while a PC is connected (DOS software only)

Note The 9 pin connector is not used if using the Windows Calibration software.

Note Data may be sent to the ACL via the CAN bus as an alternative to the serial connection.

M4e

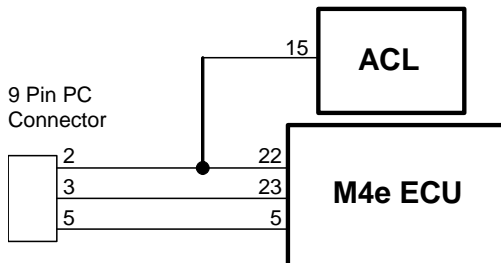

Note Older M4 ECUs require a different connection method

Note The data to the ACL will be interrupted while a PC is connected.

M48, M4 (pre M4e) and M8

The M48 & M8 and M4 (pre M4e) require the use of a CIM module or a PCI Cable to convert the logic level signals used by these ECUs into RS232 levels.

Using a CIM Module

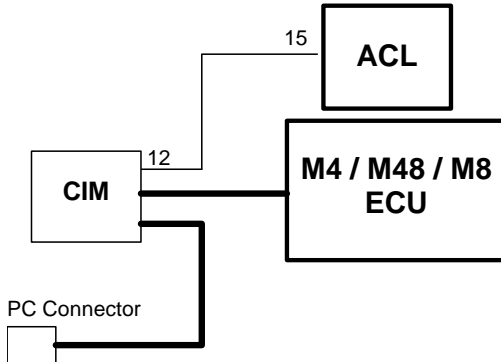

Refer to the CIM module drawing for full wiring details.

Note The data to the ACL will be interrupted while a PC is connected.

Appendix K: CAN Bus Wiring

The CAN bus should consist of a twisted pair trunk with 100R (0.25 watt) terminating resistors at each end of the trunk.

The preferred cable for the trunk is 100R Data Cable but twisted 22# Tefzel is usually OK.

The maximum length of the bus is 16 m (50 ft)

CAN Devices (such as **MoTeC** ACL, ADL2, BR2 etc) may be connected to the trunk with up to 500 mm (20 in) of twisted wire.

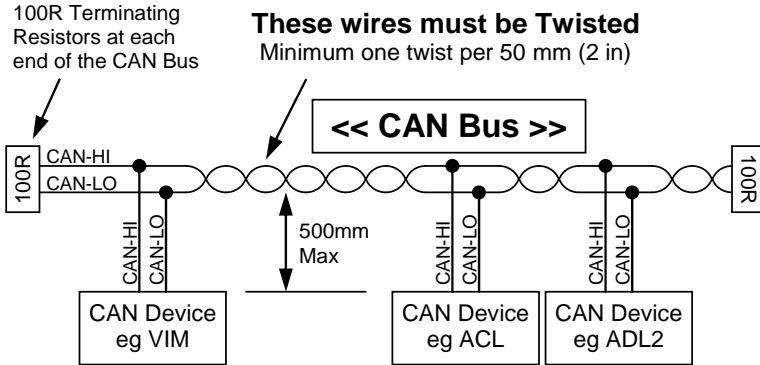

Appendix L: Wire Information

M22759/16 Wire Ratings (For Various Wire Gauges)

Insulation Material : Tefzel

Conductor : Tin Plated Copper

Voltage Rating : 600 V

Maximum Temperature : 150 °C

Wire Gauge (AWG)	Cross Sectional Area (mm ²)	Max Current at 100 °C Ambient (amperes)	Resistance (ohm / m)	Resistance (ohm / 1000 ft)
22	0.38	5	0.045	14
20	0.61	6	0.028	8.5
18	0.96	9	0.018	5.5
16	1.2	12	0.014	4.3
14	1.9	18	0.009	2.7
12	3.0	24	0.006	1.8

Wire Stripping Tool

The following tool is recommended

Ideal Industries 45-2133 stripping tool with LB1195 wire stop.

Appendix M: Connector Details

ACL Mating Connectors

22 Pin Connector: Deutsch AS612-35SN

5 Pin Connector: Deutsch ASL606-05SN-HE

VIM Mating Connectors

55 Pin Connector: Deutsch AS616-35SN

5 Pin Connector: Deutsch ASL606-05SN-HE

Wire

Wire to suit connectors : 22# Tefzel, Mil Spec : M22759/16-22

Crimp Tool

Crimp Tool : M22520/2-01

Positioner for 22 pin and 55 pin connectors

Positioner for Crimp Tool : M22520/2-07

Note The Crimp Contacts are type 22D (needed to set the crimp tool correctly)

Positioner for 5 pin connector

Positioner for Crimp Tool : Deutsch 604973

Wire Stripping Tool

The following tool is recommended

Ideal Industries 45-2133 stripping tool with LB1195 wire stop.

Heatshrink Boots

For 5 Pin

Straight Raychem 202A111, Hellerman 113-4-G

Right Angle Raychem 222A111, Hellerman 1108-4-G

For 22 Pin

Straight Raychem 202K142, Hellerman 154-42-G
Right Angle Raychem 222K142, Hellerman 1154-42-G

For 55 Pin

Straight Raychem 202K153, Hellerman 156-42-G
Right Angle Raychem 222K153, Hellerman 1156-42-G

Appendix N: VIM Pin List by Function

VIM 5 Pin Connector

Pin	Name	Function
-----	------	----------

Power

1	BAT –	Battery –
3	BAT +	Battery +

CAN Bus

4	CAN LO	CAN Low
5	CAN HI	CAN High

Not Used

2		Not Used
---	--	----------

VIM 55 Pin Connector

Pin	Name	Function
-----	------	----------

Fast Analogue Volt Inputs

47	AV F1	Analogue Voltage Fast 1
48	AV F2	Analogue Voltage Fast 2
49	AV F3	Analogue Voltage Fast 3
50	AV F4	Analogue Voltage Fast 4
51	AV F5	Analogue Voltage Fast 5
52	AV F6	Analogue Voltage Fast 6

High Resolution Analogue Volt Inputs

2	AV H1	Analogue Voltage High Resolution 1
3	AV H2	Analogue Voltage High Resolution 2
6	AV H3	Analogue Voltage High Resolution 3
7	AV H4	Analogue Voltage High Resolution 4
8	AV H5	Analogue Voltage High Resolution 5
9	AV H6	Analogue Voltage High Resolution 6
13	AV H7	Analogue Voltage High Resolution 7
14	AV H8	Analogue Voltage High Resolution 8

Special Analogue Volt Inputs

19	AV S1	Analogue Voltage Special (Fast High Resolution) 1
20	AV S2	Analogue Voltage Special (Fast High Resolution) 2

Differential Analogue Volt Inputs

15	AV D1+	Analogue Voltage Differential 1+
16	AV D1-	Analogue Voltage Differential 1-
23	AV D2+	Analogue Voltage Differential 2+
24	AV D2-	Analogue Voltage Differential 2-
45	AV D3+	Analogue Voltage Differential 3+
46	AV D3-	Analogue Voltage Differential 3-
36	AV D4+	Analogue Voltage Differential 4+
37	AV D4-	Analogue Voltage Differential 4-
30	AV D5+	Analogue Voltage Differential 5+
31	AV D5-	Analogue Voltage Differential 5-
38	AV D6+	Analogue Voltage Differential 6+
39	AV D6-	Analogue Voltage Differential 6-
28	AV D7+	Analogue Voltage Differential 7+
29	AV D7-	Analogue Voltage Differential 7-
21	AV D8+	Analogue Voltage Differential 8+
22	AV D8-	Analogue Voltage Differential 8-

Pull-up Resistors

11	R1	Pull-up Resistor 1
12	R2	Pull-up Resistor 2
33	R3	Pull-up Resistor 3
34	R4	Pull-up Resistor 4

Speed Inputs

41	SPD1	Speed 1
42	SPD2	Speed 2

Sensor 5 V

18	5V	Sensor 5 V
26	5V	Sensor 5 V
27	5V	Sensor 5 V
35	5V	Sensor 5 V
43	5V	Sensor 5 V
44	5V	Sensor 5 V

Sensor 0 V

1	0V 1	Sensor 0 V 1
5	0V 1	Sensor 0 V 1

32	0V 2	Sensor 0 V 2
40	0V 2	Sensor 0 V 2
17	0V 3	Sensor 0 V 3
25	0V 3	Sensor 0 V 3
4	0V 4	Sensor 0 V 4
10	0V 4	Sensor 0 V 4

Not Used

53	Not Used
54	Not Used
55	Not Used

Appendix O: VIM Pin List by Pin Number

VIM 5 Pin Connector

Pin	Name	Function
1	BAT –	Battery –
2		Not Used
3	BAT +	Battery +
4	CAN LO	CAN Low
5	CAN HI	CAN High

VIM 55 Pin Connector

Pin	Name	Function
1	0V 1	Sensor 0 V 1
2	AV H1	Analogue Voltage High Resolution 1
3	AV H2	Analogue Voltage High Resolution 2
4	0V 4	Sensor 0 V 4
5	0V 1	Sensor 0 V 1
6	AV H3	Analogue Voltage High Resolution 3
7	AV H4	Analogue Voltage High Resolution 4
8	AV H5	Analogue Voltage High Resolution 5
9	AV H6	Analogue Voltage High Resolution 6
10	0V 4	Sensor 0 V 4
11	R1	Pull-up Resistor 1
12	R2	Pull-up Resistor 2
13	AV H7	Analogue Voltage High Resolution 7
14	AV H8	Analogue Voltage High Resolution 8
15	AV D1+	Analogue Voltage Differential 1 +
16	AV D1–	Analogue Voltage Differential 1 –
17	0V 3	Sensor 0 V 3
18	5V	Sensor 5 V
19	AV S1	Analogue Voltage Special (Fast High Resolution) 1
20	AV S2	Analogue Voltage Special (Fast High Resolution) 2
21	AV D8+	Analogue Voltage Differential 8 +
22	AV D8–	Analogue Voltage Differential 8 –
23	AV D2+	Analogue Voltage Differential 2 +
24	AV D2–	Analogue Voltage Differential 2 –

25	0V 3	Sensor 0 V 3
26	5V	Sensor 5 V
27	5V	Sensor 5 V
28	AV D7+	Analogue Voltage Differential 7 +
29	AV D7-	Analogue Voltage Differential 7 -
30	AV D5+	Analogue Voltage Differential 5 +
31	AV D5-	Analogue Voltage Differential 5 -
32	0V 2	Sensor 0 V 2
33	R3	Pull-up Resistor 3
34	R4	Pull-up Resistor 4
35	5V	Sensor 5 V
36	AV D4+	Analogue Voltage Differential 4 +
37	AV D4-	Analogue Voltage Differential 4 -
38	AV D6+	Analogue Voltage Differential 6 +
39	AV D6-	Analogue Voltage Differential 6 -
40	0V 2	Sensor 0 V 2
41	SPD1	Speed 1
42	SPD2	Speed 2
43	5V	Sensor 5 V
44	5V	Sensor 5 V
45	AV D3+	Analogue Voltage Differential 3 +
46	AV D3-	Analogue Voltage Differential 3 -
47	AV F1	Analogue Voltage Fast 1
48	AV F2	Analogue Voltage Fast 2
49	AV F3	Analogue Voltage Fast 3
50	AV F4	Analogue Voltage Fast 4
51	AV F5	Analogue Voltage Fast 5
52	AV F6	Analogue Voltage Fast 6
53		Not Used
54		Not Used
55		Not Used

Appendix P: ACL Pin List by Pin Number

ACL 5 Pin Connector

Pin	Name	Function
1	RX+	Ethernet Receive + (Orange/White)
2	RX –	Ethernet Receive – (Orange)
3	TX +	Ethernet Transmit + (Green/White)
4	TX –	Ethernet Transmit – (Green)
5		Not Used

ACL 22 Pin Connector

Pin	Name	Function
1	BAT –	Battery –
2	BAT +	Battery +
3	J1850	J1850 Comms
4	LIN	LIN Comms
5	CAN 0 LO	CAN Bus 0 Low
6	CAN 0 HI	CAN Bus 0 High
7	CAN 1 LO	CAN Bus 1 Low
8	CAN 1 HI	CAN Bus 1 High
9	Reserved	Reserved (RS232 0 Carrier Detect)
10	Reserved	Reserved (RS232 0 Receive)
11	Reserved	Reserved (RS232 0 Transmit)
12	Reserved	Reserved (RS232 0 Request to Send)
13	Reserved	Reserved (RS232 0 Clear to Send)
14	RS232 1 CD	RS232 1 Carrier Detect
15	RS232 1 RX	RS232 1 Receive
16	RS232 1 TX	RS232 1 Transmit
17	RS422 TX+	RS422 Transmit + (RS485 +)
18	RS422 TX–	RS422 Transmit – (RS485 –)
19	RS422 RX+	RS422 Receive +
20	RS422 RX–	RS422 Receive –
21	SW IN	Not Used
22	IGN ON	Power Request On/Off (Switch to Battery +)

Appendix Q: ACL Case Dimensions

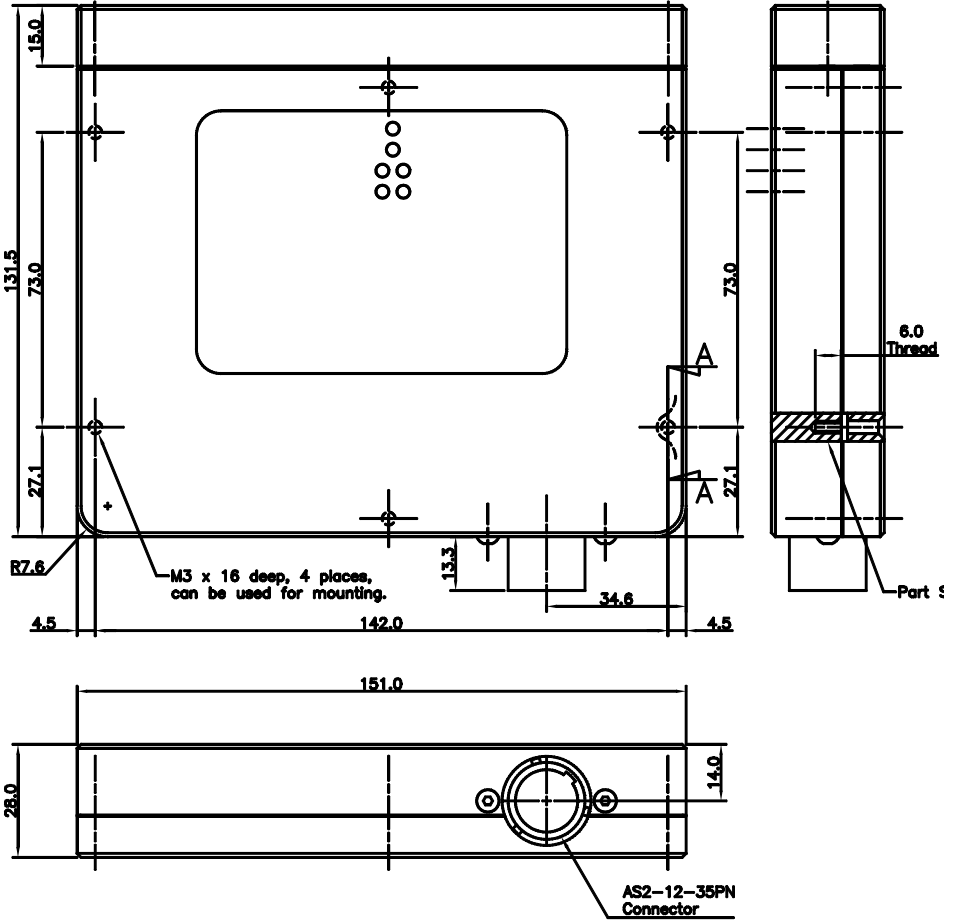

Appendix R: VIM Case Dimensions

