

MICREX-SX *series*

SPH

USER'S MANUAL

High-speed Multi-range Analog Module

| | |
|---------------------------|----------------------------------|
| 8Ch Voltage Input | <Type: NP1AXH8V-MR> |
| 8Ch Current Input | <Type: NP1AXH8I-MR> |
| 8Ch Voltage Output | <Type: NP1AYH8V-MR> |
| 8Ch Current Output | <Type: NP1AYH8I-MR> |
| 4Ch Voltage Output | <Type: NP1AYH4V-MR> |
| 4Ch Current Output | <Type: NP1AYH4I-MR> |
| 6Ch Input/Output | <Type: NP1AWH6-MR> |

Preface

This user's manual describes the system configuration, specifications and operating method of the following modules for MICREX-SX series:

- ◆ Multi-range analog 8ch voltage input module (type: NP1AXH8V-MR)
- ◆ Multi-range analog 8ch current input module (type: NP1AXH8I-MR)
- ◆ Multi-range analog 8ch voltage output module (type: NP1AYH8V-MR)
- ◆ Multi-range analog 8ch current output module (type: NP1AYH8I-MR)
- ◆ Multi-range analog 4ch voltage output module (type: NP1AYH4V-MR)
- ◆ Multi-range analog 4ch current output module (type: NP1AYH4I-MR)
- ◆ Multi-range analog 6ch input/output module (type: NP1AWH6-MR)

Read this manual carefully to ensure correct operation. When using modules or peripheral devices, be sure to read the corresponding user's manuals listed below:

<SX-Programmer Expert (D300win)>

| Title | Manual No. | Contents |
|---|------------|--|
| User's Manual Instruction, MICREX-SX series | FEH200 | Explains the memory, language and system definitions of the MICREX-SX series. |
| User's Manual Hardware, MICREX-SX series SPH | FEH201 | Explains the system configuration, the specifications and operations of modules in the MICREX-SX series. |
| User's Manual D300win <Reference>, MICREX-SX series | FEH257 | Explains the methods for installing, the functions and the operations of D300winV3. |
| User's Manual D300win <LD/FBD Editor>, MICREX-SX series | FEH257-1 | Explains the operations of LD/FBD added to D300winV3. |
| | | |

<SX-Programmer Standard (Standard loader)>

| Title | Manual No. | Contents |
|--|------------|--|
| User's Manual Instruction, MICREX-SX series | FEH588 | Explains the memory, language and system definitions of the MICREX-SX series. |
| User's Manual Hardware, MICREX-SX series SPH | FEH201 | Explains the system configuration, the specifications and operations of modules in the MICREX-SX series. |
| User's Manual SX-Programmer Standard <Reference>, MICREX-SX series | FEH590 | Explains the functions and the operations of SX-Programmer Standard. |
| | | |

* This manual is structured such that you can consult it, whether you use SX-Programmer Expert (D300win) or SX-programmer standard (Standard loader).

* In addition to the above manuals, the following Fuji Electric FA Components & Systems Co., Ltd. site offers various manuals and technical documents associated with MICREX-SX.

URL <http://www.fujielectric.co.jp/fcs/eng/>

Notes

1. This manual may not be reproduced in whole or part in any form without prior written approval by the manufacturer.
2. The contents of this manual (including specifications) are subject to change without prior notice.
3. If you find any ambiguous or incorrect descriptions in this manual, please write them down (along with the manual No. shown on the cover) and contact FUJI.

Safety Precautions

Be sure to read the “Safety Precautions” thoroughly before using the module.
Here, the safety precautions items are classified into “Warning” and “Caution”.

 **Warning** : Incorrect handling of the device may result in death or serious injury.

 **Caution** : Incorrect handling of the device may result in minor injury or physical damage.

Even some items indicated by “Caution” may result in a serious accident.
Both safety instruction categories provide important information. Be sure to strictly observe these instructions.
The items to be cared most are shown below:

Warning

- Never touch any part of charged circuits as terminals and exposed metal portion while the power is turned ON. It may result in an electric shock to the operator.
- Turn OFF the power before mounting, dismounting, wiring, maintaining or checking, otherwise, electric shock, erratic operation or troubles might occur.
- Place the emergency stop circuit, interlock circuit or the like for safety outside the PLC. A failure of PLC might break or cause problems to the machine.
- Do not connect in reverse polarity, charge (except rechargeable ones), disassemble, heat, deform, throw in a fire or short-circuit the batteries, otherwise, they might burst or take fire.
- If batteries have any deformation, spilled fluids, or other abnormality, do not use them. The use of such batteries might cause explosion or firing.

Safety Precautions



- Do not use one found damaged or deformed when unpacked, otherwise, fire, failure or erratic operation might be caused.
- Do not shock the product by dropping or tipping it over, otherwise, it might be damaged or troubled.
- Follow the directions of the operating instructions and manual when mounting the product.
If mounting is improper, the product might drop or develop problems or erratic operations.
- Use the rated voltage and current mentioned in the operating instructions and manual. Use beyond the rated values might cause fire, erratic operation or failure.
- Operate (keep) in the environment specified in the operating instructions and manual. High temperature, high humidity, condensation, dust, corrosive gases, oil, organic solvents, excessive vibration or shock might cause electric shock, fire, erratic operation or failure.
- Select a wire size to suit the applied voltage and carrying current. Tighten the wire terminals to the specified torque. Inappropriate wiring or tightening might cause fire, malfunction or failure, or might cause the product to drop from its mounting.
- Contaminants, wiring chips, iron powder or other foreign matter must not enter the device when installing it, otherwise, fire, accident, erratic operation or failure might occur.
- Remove the dust-cover seals of modules or units after wiring, otherwise, fire, accident, erratic operation or failure might occur.
- Connect the ground terminal to the ground, otherwise, electric shock or erratic operation might occur.
- Periodically make sure the terminal screws and mounting screws are securely tightened.
Operation at a loosened status might cause fire or erratic operation.
- Put the furnished connector covers on unused connectors, otherwise, erratic operation or failure might occur.
- Put the furnished terminal covers on the terminal blocks, otherwise, electric shock or fire might occur.
- Sufficiently make sure of safety before program change, forced output, starting, stopping or anything else during a run.
Wrong operation might break or cause problems to the machine
- Engage the loader connector in a correct orientation, otherwise, an erratic operation might occur.
- Before touching the PLC, discharge any static electricity that may have been collected on your body. To discharge it, touch a grounded metallic object. Static electricity might cause erratic operation or failure.
- Be sure to install the electrical wiring correctly and securely, observing the directions of the operating instructions and manual. Wrong or loose wiring might cause fire, accident or failure.
- When disengaging the plug from the outlet, do not pull the cord, otherwise, break of cable might cause fire or failure.
- Do not attempt to change system configurations (such as installing or removing I/O modules) while the power is ON, otherwise, erratic operation or failure might occur.
- Do not attempt to repair the module by yourself, but contact your Fuji Electric agent. When replacing the batteries, correctly and securely connect the battery connectors, otherwise, fire, accident or failure might occur.
- Do not remodel or disassemble the product, otherwise, failure might occur.
- Follow the regulations of industrial wastes when the device is to be discarded.
- The modules covered in these operating instructions have not been designed or manufactured for use in equipment or systems which, in the event of failure, can lead to loss of human life.
- If you intend to use the modules covered in these operating instructions for special applications, such as for nuclear energy control, aerospace, medical or transportation, please consult your Fuji Electric agent.
- Be sure to provide protective measures when using the module covered in these operating instructions in equipment which, in the event of failure, can lead to loss of human life or other grade results.
- External power supply (such as 24 V DC power supply) which is connected to DC I/O should be strongly isolated from AC power supply. (Use of EN60950 conforming power supply is recommended.) Otherwise, accident or failure might be caused.

Revisions

*The manual No. is printed at the bottom right of the cover of this manual.

| Printed on | *Manual No. | Revision contents |
|------------|-------------|--|
| Sep. 2002 | FEH206 | First edition |
| Jun. 2004 | FEH206a | ♦ Operations when using SX-Programmer Standard were added. |
| Apr. 2006 | FEH206b | ♦ Specifications of Analog Input/Output Module (type: NP1AWH6-MR) were added. |
| May 2007 | FEH206c | ♦ Some errors in writing were corrected. ♦ Expository writing was reviewed. (The expressions were revised.) |

Contents

Preface

Safety Precautions

Revisions

Contents

| | Page |
|---|------------|
| Section 1 General | 1-1 |
| 1-1 List of Modules | 1-1 |
| 1-2 Supported Versions of Program Loader | 1-1 |
| Section 2 Specifications | 2-1 |
| 2-1 General Specifications | 2-1 |
| 2-2 Performance Specifications | 2-2 |
| 2-2-1 8ch voltage input module | 2-2 |
| 2-2-2 8ch current input module | 2-2 |
| 2-2-3 8ch voltage output module | 2-3 |
| 2-2-4 8ch current output module | 2-3 |
| 2-2-5 4ch voltage output module | 2-4 |
| 2-2-6 4ch current output module | 2-4 |
| 2-2-7 6ch input/output module | 2-5 |
| 2-3 Conversion Characteristics | 2-6 |
| 2-3-1 Conversion characteristics of analog voltage input | 2-6 |
| 2-3-2 Conversion characteristics of analog current input | 2-8 |
| 2-3-3 Conversion characteristics of analog voltage output | 2-10 |
| 2-3-4 Conversion characteristics of analog current output | 2-12 |
| 2-4 Functional Specifications | 2-13 |
| 2-4-1 Analog input module functions | 2-13 |
| 2-4-2 Analog output module functions | 2-14 |
| 2-4-3 Analog input/output module functions | 2-15 |
| 2-5 Names and Functions | 2-16 |
| 2-5-1 Analog input module (NP1AXH8V-MR/NP1AXH8I-MR) | 2-16 |
| 2-5-2 Analog output module (NP1AYH8V-MR, NP1AYH8I-MR, NP1AYH4V-MR, NP1AYH4I-MR) | 2-18 |
| 2-5-3 Analog input/output module (NP1AWH6-MR) | 2-21 |
| 2-6 Dimensions | 2-23 |
| Section 3 System Configuration | 3-1 |
| 3-1 Mounting on the Base Board | 3-1 |
| 3-1-1 Mounting position | 3-1 |
| 3-1-2 Number of mountable modules | 3-1 |
| Section 4 Software Interface | 4-1 |
| 4-1 Analog Input Module | 4-1 |
| 4-1-1 Memory allocation in Switch Batch Setting mode | 4-1 |
| 4-1-2 Memory allocation in Software Set Range Operation mode | 4-2 |
| 4-2 Analog Output Module | 4-14 |
| 4-2-1 Memory allocation in Switch Batch Setting mode | 4-14 |
| 4-2-2 Memory allocation in Software Set Range Operation mode | 4-16 |
| 4-3 Analog Input/Output Module | 4-26 |
| 4-3-1 Memory allocation in Switch Batch Setting mode | 4-26 |
| 4-3-2 Memory allocation in Software Set Range Operation mode | 4-27 |

Contents

| | Page |
|---|----------------|
| Section 5 Wiring | 5-1 |
| 5-1 Wiring of Analog Input Module | 5-1 |
| 5-1-1 Terminal arrangement | 5-1 |
| 5-1-2 Wiring example | 5-2 |
| 5-2 Wiring of Analog Output Module | 5-3 |
| 5-2-1 Terminal arrangement | 5-3 |
| 5-2-2 Wiring example | 5-4 |
| 5-3 Wiring of Analog Input/Output Module | 5-5 |
| 5-3-1 Terminal arrangement | 5-5 |
| 5-3-2 Wiring example | 5-6 |
| Appendix 1 Offset/Gain Adjustment <D300win> | App.1-1 |
| Appendix 1-1 Offset/Gain Adjustment of Analog Input Module | App.1-1 |
| Appendix 1-2 Offset/Gain Adjustment of Analog Output Module | App.1-6 |
| Appendix 2 Offset/Gain Adjustment <SX-Programmer Standard> | App.2-1 |
| Appendix 2-1 Offset/Gain Adjustment of Analog Input Module | App.2-1 |
| Appendix 2-2 Offset/Gain Adjustment of Analog Output Module | App.2-6 |

Section 1 General

1-1 List of Modules

Analog modules listed below are described in this manual.

| Type | Analog voltage input 0 to 5V, 1 to 5V, 0 to 10V, -10 to 10V | Analog current input 4 to 20mA, 0 to 20mA, -20 to 20mA | Analog voltage output 0 to 5V, 1 to 5V, 0 to 10V, -10 to 10V | Analog current output 0 to 20mA, 4 to 20mA |
|-------------|---|--|--|---|
| NP1AXH8V-MR | 8 channels | - | - | - |
| NP1AXH8I-MR | - | 8 channels | - | - |
| NP1AYH8VMR | - | - | 8 channels | - |
| NP1AYH8I-MR | - | - | - | 8 channels |
| NP1AYH4V-MR | - | - | 4 channels | - |
| NP1AYH4I-MR | - | - | - | 4 channels |
| NP1AWH6-MR | 4 channels | | 2 channels | |

1-2 Supported Versions of Program Loader

| Type | D300winV2 NP4H-SEDBV2 | SX-Programmer Expert D300winV3 NP4H-SEDBV3 | SX-Programmer Standard NP4H-SWN |
|-------------|--------------------------|--|------------------------------------|
| NP1AXH8V-MR | V2.2.0.0 or later | V3.0.0.0 or later | V2.0.0.0 or later |
| NP1AXH8I-MR | | | |
| NP1AYH8VMR | | | |
| NP1AYH8I-MR | | | |
| NP1AYH4V-MR | | | |
| NP1AYH4I-MR | | | |
| NP1AWH6-MR | - | V3.3.3.0 or later | V2.2.3.0 or later |

Section 2 Specifications

2-1 General Specifications

| Item | | Specification |
|-----------------------------------|--------------------------------------|--|
| Physical environmental conditions | Operating ambient temperature | 0 to + 55 °C |
| | Storage (transportation) temperature | -20 to 70 °C |
| | Relative humidity | 20 to 95%RH, no condensation |
| | Pollution degree | 2 (no condensation) |
| | Corrosion immunity | Free from corrosive gases. Not stained with organic solvents |
| | Corrosive gas | Free from corrosive gases. |
| | Operating altitude | 2000 m or less above sea level Transport condition: 70 kPa (equivalent to 3000 m above sea level) or more |
| Mechanical service conditions | Vibration | Half amplitude: 0.15 mm, Constant acceleration: 19.6 m/s ² 2 hours in each of X, Y and Z directions, total 6 hours |
| | Shock | Peak acceleration: 147 m/s ² (3 cycles in each direction) |
| Electrical service conditions | Noise immunity | Rise time 1 ns, pulse width 1 μs, 1.5 V (noise simulator) |
| | Electrostatic discharge | Contact discharge: ±6 kV, Aerial discharge: ±8 kV |
| | Radioelectromagnetic field | 10 V/m (80 MHz to 1,000 MHz) |
| Isolation method | | Between external terminal and internal logic circuit: photocoupler (signal), isolated power supply (DC/DC converter) Between channels: Not insulated |
| Dielectric strength | | 500 V AC, 1 minute (between external wires connected together and ground) |
| Insulation resistance | | 10 MΩ or more with 500 V DC megger (between external wires connected together and ground) |
| Internal current consumption | Analog input | NP1AXH8V-MR: 24 V DC, max. 200 mA (supplied from the power module) NP1AXH8I-MR: 24 V DC, max. 200 mA (supplied from the power module) |
| | Analog output | NP1AYH8V-MR: 24 V DC, max. 240 mA (supplied from the power module) NP1AYH8I-MR: 24 V DC, max. 300 mA (supplied from the power module) NP1AYH4V-MR: 24 V DC, max. 200 mA (supplied from the power module) NP1AYH4I-MR: 24 V DC, max. 200 mA (supplied from the power module) |
| | Analog input/output | NP1AWH6-MR: 24V DC, max. 200mA (supplied from the power module) |
| Installation conditions | Structure | Panel built in type, IP30 |
| | Cooling method | Natural air cooled |
| Mass | Analog input | NP1AXH8V-MR: approx. 240 g NP1AXH8I-MR: approx. 240 g |
| | Analog output | NP1AYH8V-MR: approx. 240 g NP1AYH8I-MR: approx. 240 g NP1AYH4V-MR: approx. 240 g NP1AYH4I-MR: approx. 240 g |
| | Analog input/output | NP1AWH6-MR: approx. 240g |
| Outside dimensions | | W35*H105*D111 mm (protrusion 21 mm) |

Section 2 Specifications

2-2 Performance Specifications

2-2-1 8ch voltage input module

| Item | Specification | | | |
|---------------------------------|---|----------|-----------|---------------|
| Type | NP1AXH8V-MR | | | |
| No. of input points | 8 | | | |
| Analog input range | 0 to 5 V | 1 to 5 V | 0 to 10 V | -10 to 10 V |
| Input impedance | 1 MΩ | | | |
| Maximum allowable input | ±15 V | | | |
| Maximum resolution | 1.25 mV | 1.25 mV | 1.25 mV | 1.25 mV |
| Digital output value (INT type) | 0 to 16000 | | | -8000 to 8000 |
| Measurement accuracy | Ambient temperature 18 to 28°C: ±0.1% (of full scale) Ambient temperature 0 to 55°C: ±0.2% (of full scale) (See note 1.) | | | |
| Sampling time | 0.27 ms x (Number of conversion enabled channels + 1) | | | |
| Input filtering time | Max. approx. 100 μs (hard filter) | | | |
| Input delay time | Max. 2.5 ms/8 points + takt time (ms) | | | |
| External connecting method | Detachable terminal block: M3 screw, 20 poles For the signal assignment of terminals, refer to "Section 5 Wiring". | | | |
| Cable to use | Be sure to use shielded twisted pair cable. | | | |
| Treatment of unused input | To basically be short-circuited | | | |
| No. of occupied slots | 1 (one) | | | |
| No. of occupied words | Input: 8 words, output: 4 words (fixed) | | | |

Note: For the range of 1 to 5 V, ±0.3% (of full scale) when ambient temperature is 0 to 55°C.

2-2-2 8ch current input module

| Item | Specification | | |
|---------------------------------|---|------------|--------------|
| Type | NP1AXH8I-MR | | |
| No. of input points | 8 | | |
| Analog input range | 4 to 20 mA | 0 to 20 mA | -20 to 20 mA |
| Input impedance | 250 Ω | | |
| Maximum allowable input | ±30 mA | | |
| Maximum resolution | 2.5 μA | | |
| Digital output value (INT type) | 0 to 16000 | | |
| Measurement accuracy | Ambient temperature 18 to 28°C: ±0.1% (of full scale) Ambient temperature 0 to 55°C: ±0.4% (of full scale) | | |
| Sampling time | 0.27 ms x (Number of conversion enabled channels + 1) | | |
| Input filtering time | Max. approx. 100 μs (hard filter: time constant of primary delay) | | |
| Input response time | Max. 2.5 ms/8 points + takt time | | |
| External connecting method | Detachable terminal block: M3 screw, 20 poles For the signal assignment of terminals, refer to "Section 5 Wiring". | | |
| Cable to use | Be sure to use shielded twisted pair cable. | | |
| Treatment of unused input | To basically be short-circuited | | |
| No. of occupied slots | 1 (one) | | |
| No. of occupied words | Input: 8 words, output: 4 words (fixed) | | |

Section 2 Specifications

2-2 Performance Specifications

2-2-3 8ch voltage output module

| Item | Specification | | | |
|--------------------------------|---|-----------|-----------|---------------|
| Type | NP1AYH8V-MR | | | |
| No. of output points | 8 | | | |
| Analog output range | 0 to 5 V | 1 to 5 V | 0 to 10 V | -10 to 10 V |
| External load resistance | Min. 500Ω | Min. 500Ω | Min. 1kΩ | Min. 1kΩ |
| Maximum resolution | 1.25 mV | 1.25 mV | 1.25 mV | 1.25 mV |
| Digital input value (INT type) | 0 to 16000 | | | -8000 to 8000 |
| Measurement accuracy | Ambient temperature 18 to 28°C: ±0.1% (of full scale) Ambient temperature 0 to 55°C: ±0.2% (of full scale) (See note 1.) | | | |
| Output response time | Max. 2.0 ms + takt time (ms) Max. 1.0 ms + takt time (ms) when output is disabled for channels 5 to 8 | | | |
| Load short-circuit protection | Provided. (See note 2.) | | | |
| External connecting method | Detachable terminal block: M3 screw, 20 poles For the signal assignment of terminals, refer to "Section 5 Wiring". | | | |
| Cable to use | Be sure to use shielded twisted pair cable. | | | |
| Treatment of unused output | To basically be opened | | | |
| No. of occupied slots | 1 (one) | | | |
| No. of occupied words | Input: 4 words, output: 8 words (fixed) | | | |

Note 1: For the range of 1 to 5 V, ±0.3% (of full scale) when ambient temperature is 0 to 55°C.

Note 2: Short-circuit protection for arbitrary one channel. The occurrence of short-circuit on multiple channels in an environment where ambient temperature is higher than 30°C may have a bad influence on internal electronic component of the module.

2-2-4 8ch current output module

| Item | Specification | |
|--------------------------------|---|------------|
| Type | NP1AYH8I-MR | |
| No. of output points | 8 | |
| Analog output range | 0 to 20 mA | 4 to 20 mA |
| External load resistance | Max. 600Ω | |
| Maximum resolution | 2.5 μA | |
| Digital input value (INT type) | 0 to 16000 | |
| Measurement accuracy | Ambient temperature 18 to 28°C: ±0.1% (of full scale) Ambient temperature 0 to 55°C: ±0.4% (of full scale) | |
| Output response time | Max. 2.0 ms + takt time (ms) Max. 1.0 ms + takt time (ms) when output is disabled for channels 5 to 8 | |
| External connecting method | Detachable terminal block: M3 screw, 20 poles For the signal assignment of terminals, refer to "Section 5 Wiring". | |
| Cable to use | Be sure to use shielded twisted pair cable. | |
| Treatment of unused output | To basically be short-circuited | |
| No. of occupied slots | 1 (one) | |
| No. of occupied words | Input: 4 words, output: 8 words (fixed) | |

Section 2 Specifications

2-2 Performance Specifications

2-2-5 4ch voltage output module

| Item | Specification | | | |
|--------------------------------|---|-----------|-----------|---------------|
| Type | NP1AYH4V-MR | | | |
| No. of output points | 4 | | | |
| Analog output range | 0 to 5 V | 1 to 5 V | 0 to 10 V | -10 to 10 V |
| External load resistance | Min. 500Ω | Min. 500Ω | Min. 1kΩ | Min. 1kΩ |
| Maximum resolution | 1.25 mV | 1.25 mV | 1.25 mV | 1.25 mV |
| Digital input value (INT type) | 0 to 16000 | | | -8000 to 8000 |
| Measurement accuracy | Ambient temperature 18 to 28°C: ±0.1% (of full scale) Ambient temperature 0 to 55°C: ±0.2% (of full scale) (See note 1.) | | | |
| Output response time | Max. 1.0 ms + takt time (ms) | | | |
| Load short-circuit protection | Provided. (See note 2.) | | | |
| External connecting method | Detachable terminal block: M3 screw, 10 poles For the signal assignment of terminals, refer to "Section 5 Wiring". | | | |
| Cable to use | Be sure to use shielded twisted pair cable. | | | |
| Treatment of unused output | To basically be opened | | | |
| No. of occupied slots | 1 (one) | | | |
| No. of occupied words | Input: 4 words, output: 4 words (fixed) | | | |

Note 1: For the range of 1 to 5 V, ±0.3% (of full scale) when ambient temperature is 0 to 55°C.

Note 2: Short-circuit protection for arbitrary one channel. The occurrence of short-circuit on multiple channels in an environment where ambient temperature is higher than 30°C may have a bad influence on internal electronic component of the module.

2-2-6 4ch current output module

| Item | Specification | |
|--------------------------------|---|------------|
| Type | NP1AYH4I-MR | |
| No. of output points | 4 | |
| Analog output range | 0 to 20 mA | 4 to 20 mA |
| External load resistance | Max. 600Ω | |
| Maximum resolution | 2.5 μA | |
| Digital input value (INT type) | 0 to 16000 | |
| Measurement accuracy | Ambient temperature 18 to 28°C: ±0.1% (of full scale) Ambient temperature 0 to 55°C: ±0.4% (of full scale) | |
| Output response time | Max. 1.0 ms + takt time (ms) | |
| External connecting method | Detachable terminal block: M3 screw, 10 poles For the signal assignment of terminals, refer to "Section 5 Wiring". | |
| Cable to use | Be sure to use shielded twisted pair cable. | |
| Treatment of unused output | To basically be short-circuited | |
| No. of occupied slots | 1 (one) | |
| No. of occupied words | Input: 4 words, output: 4 words (fixed) | |

Section 2 Specifications

2-2 Performance Specifications

2-2-7 6ch input/output module

| Item | | Specification | |
|----------------------------|---|--|-----------------------------------|
| Type | | NP1AWH6-MR | |
| Analog input | No. of input points | 4 | |
| | Analog input range | 0 to 5V, 1 to 5V, 0 to 10V, -10 to 10V | 0 to 20mA, 4 to 20mA, -20 to 20mA |
| | Input impedance | 1 MΩ | 250 Ω |
| | Maximum allowable input | ±15 V | ±30 mA |
| | Maximum resolution | 0.625 mV | 2.5 μA |
| | Digital output value (INT type) | 0 to 16000, -8000 to 8000 | |
| | Sampling time | 0.25 ms x (Number of conversion enabled channels + 1) | |
| | Input filtering time | Max. approx. 47 μs (hard filter: time constant of primary delay) | |
| | Input delay time | Max. 1.0 ms/4 channels + takt time (ms) | |
| Analog output | No. of output points | 2 | |
| | Analog output range | 0 to 5V, 1 to 5V, 0 to 10V, -10 to 10V | 0 to 20mA, 4 to 20mA |
| | External load resistance | Min. 2 kΩ | Max. 500 Ω |
| | Maximum resolution | 0.625 mV | 2.5 μA |
| | Digital input value (INT type) | 0 to 16000, -8000 to 8000 | |
| | Output response time | Max. 0.5 ms + takt time (ms) | |
| | Load short-circuit protection | Provided (voltage output) (See note 1.) | |
| Measurement accuracy | Ambient temperature 18 to 28°C: ±0.1% (of full scale) Ambient temperature 0 to 55°C: ±0.2% (of full scale) (See note 2.) | | |
| External connecting method | Detachable terminal block: M3 screw, 10 poles For the signal assignment of terminals, refer to "Section 5 Wiring". | | |
| Cable to use | Be sure to use shielded twisted pair cable. | | |
| Treatment of unused input | Input: To basically be short-circuited (between V+ and COM) Output: To basically be opened | | |
| No. of occupied slots | 1 (one) | | |
| No. of occupied words | Input: 4 words, Output: 4 words (fixed) | | |

Note 1: Short-circuit protection for arbitrary one channel. The occurrence of short-circuit on multiple channels in an environment where ambient temperature is higher than 30°C may have a bad influence on internal electronic component of the module.

Note 2: For the range of 4 to 20 mA and 0 to 20 mA, ±0.3% (of full scale) when ambient temperature is 0 to 55°C.

Section 2 Specifications

2-3 Conversion Characteristics

2-3-1 Conversion characteristics of analog voltage input

| Output range | Digital input range | |
|--------------|---------------------|------------|
| 0 to 5 V | 0 to 16000 | 0 to 10000 |
| 1 to 5 V | 0 to 16000 | 0 to 10000 |
| 0 to 10 V | 0 to 16000 | 0 to 10000 |
| -10 to 10 V | -8000 to 8000 | 0 to 10000 |

1) Characteristic curve for the input range of 0 to 5 V

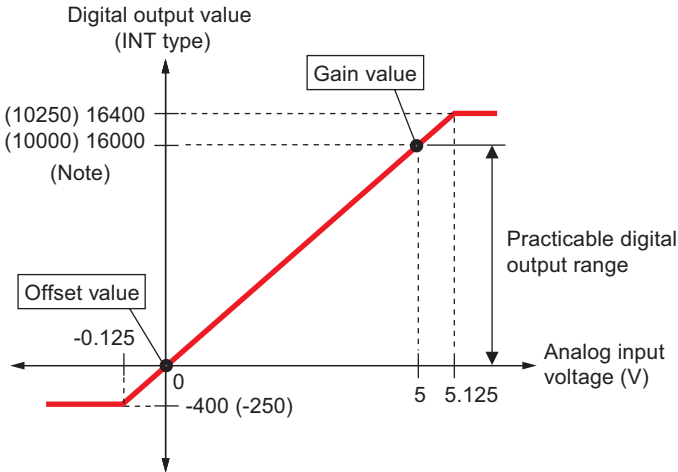

2) Characteristic curve for the input range of 1 to 5 V

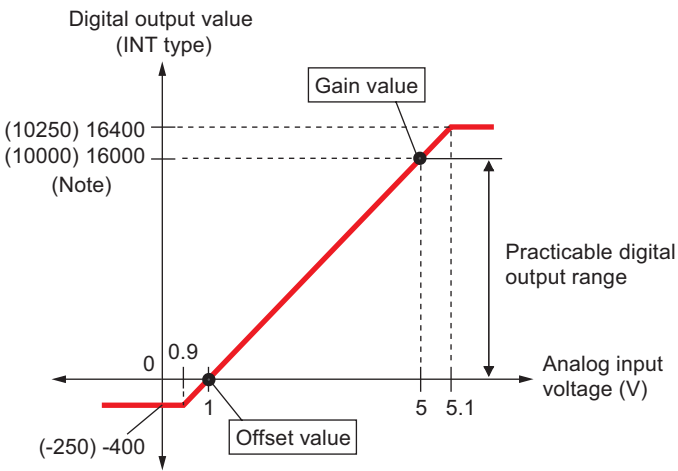

<NP1AWH6-MR only>

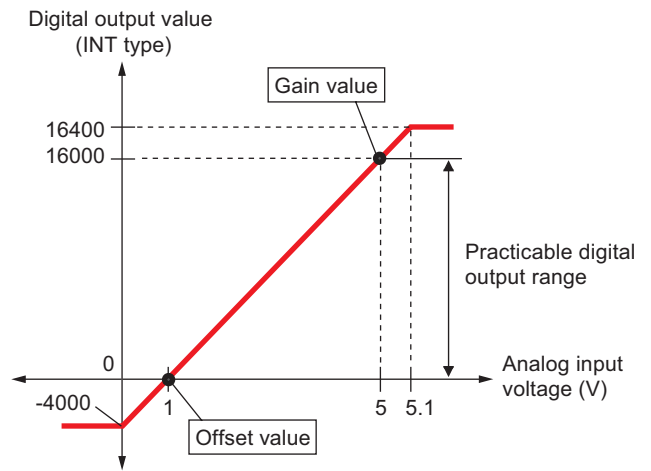

Note: Parenthesized figures mean the values when the unit of digital output value is % in Fixed Range Operation mode (excl. NP1AWH6-MR). In software Set Range Operation mode, scaling is necessary to express output values by the %.

Section 2 Specifications

2-3 Conversion Characteristics

3) Characteristic curve for the input range of 0 to 10 V

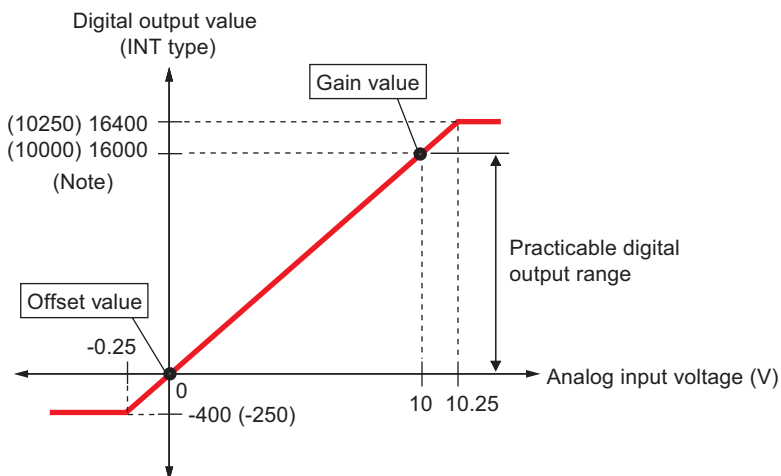

4) Characteristic curve for the input range of -10 to 10 V

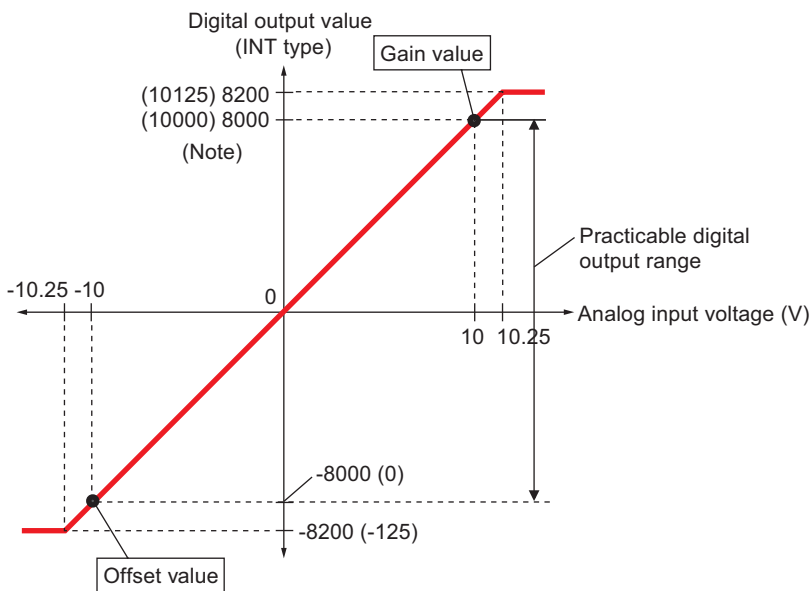

Note: Parenthesized figures mean the values when the unit of digital output value is % in Fixed Range Operation mode (excl. NP1AWH6-MR). In software Set Range Operation mode, scaling is necessary to express output values by the %.

Section 2 Specifications

2-3 Conversion Characteristics

2-3-2 Conversion characteristics of analog current input

| Input range | Digital output range | |
|--------------|----------------------|------------|
| 4 to 20 mA | 0 to 16000 | 0 to 10000 |
| 0 to 20 mA | 0 to 16000 | 0 to 10000 |
| -20 to 20 mA | -8000 to 8000 | 0 to 10000 |

1) Characteristic curve for the input range of 4 to 20 mA

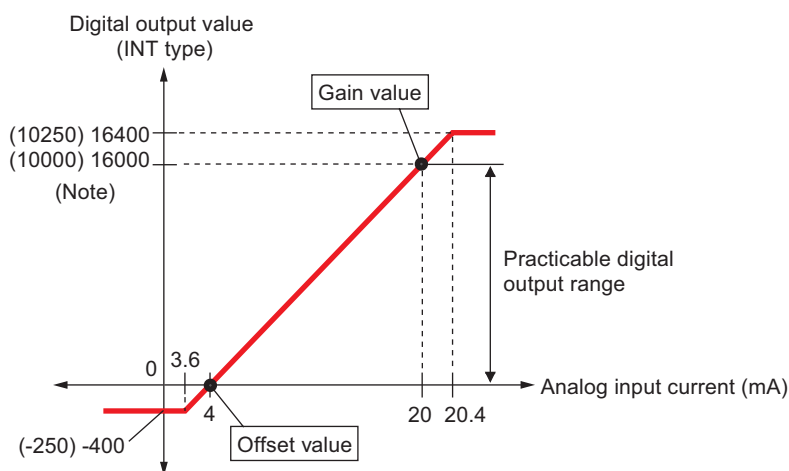

2) Characteristic curve for the input range of 0 to 20 mA

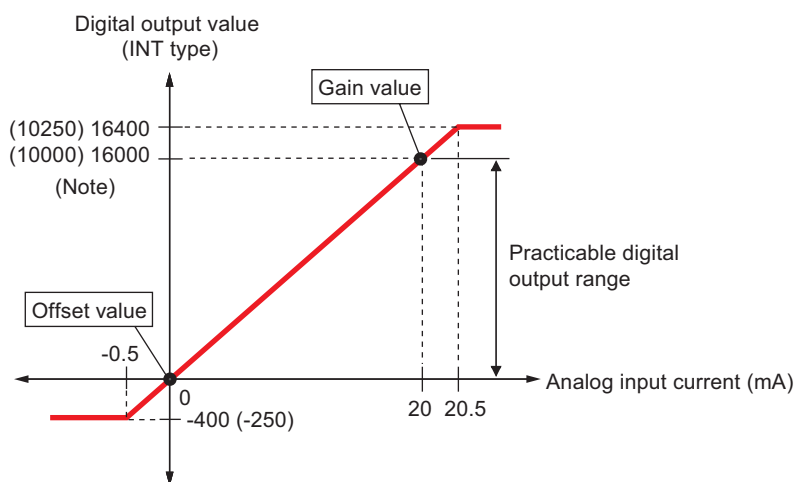

Note: Parenthesized figures mean the values when the unit of digital output value is % in Fixed Range Operation mode (excl. NP1AWH6-MR). In software Set Range Operation mode, scaling is necessary to express output values by the %.

Section 2 Specifications

2-3 Conversion Characteristics

3) Characteristic curve for the input range of -20 to 20 mA

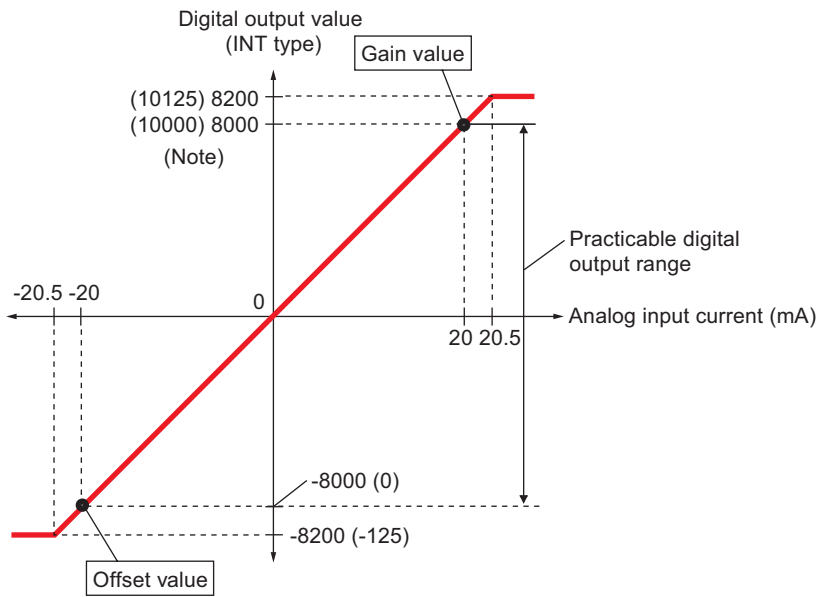

Note: Parenthesized figures mean the values when the unit of digital output value is % in Fixed Range Operation mode (excl. NP1AWH6-MR). In software Set Range Operation mode, scaling is necessary to express output values by the %.

Section 2 Specifications

2-3 Conversion Characteristics

2-3-3 Conversion characteristics of analog voltag output

| Output range | Digital input range | |
|--------------|---------------------|------------|
| 0 to 5 V | 0 to 16000 | 0 to 10000 |
| 1 to 5 V | 0 to 16000 | 0 to 10000 |
| 0 to 10 V | 0 to 16000 | 0 to 10000 |
| -10 to 10 V | -8000 to 8000 | - |

1) Characteristic curve for the output range of 0 to 5 V

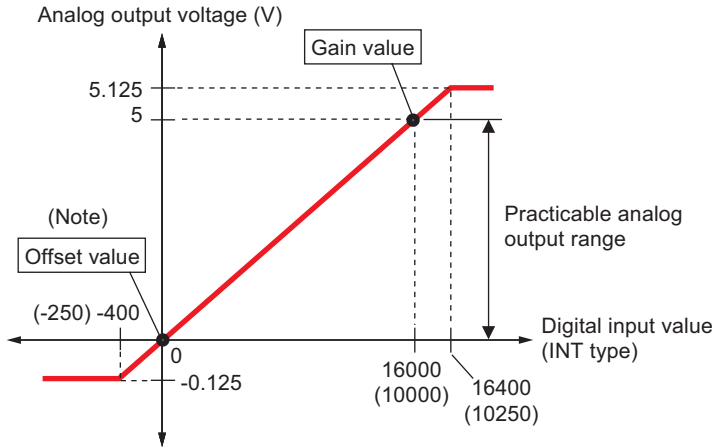

2) Characteristic curve for the output range of 1 to 5 V

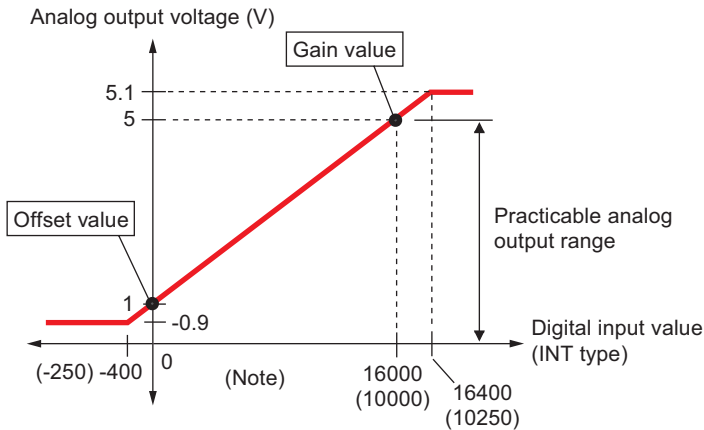

Note 1: Parenthesized figures mean the values when the unit of digital input value is % in Fixed Range Operation mode (excl. NP1AWH6-MR). In Software Set Range Operation mode, scaling is necessary to express input values by the %.

Note 2: If parameter mode is activated in Software Set Range Operation mode, analog output value becomes equal to the offset value.

Section 2 Specifications

2-3 Conversion Characteristics

3) Characteristic curve for the output range of 0 to 10 V

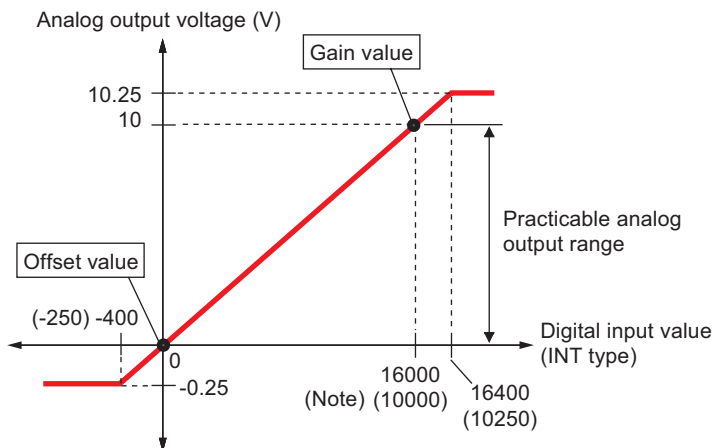

4) Characteristic curve for the output range of -10 to 10 V

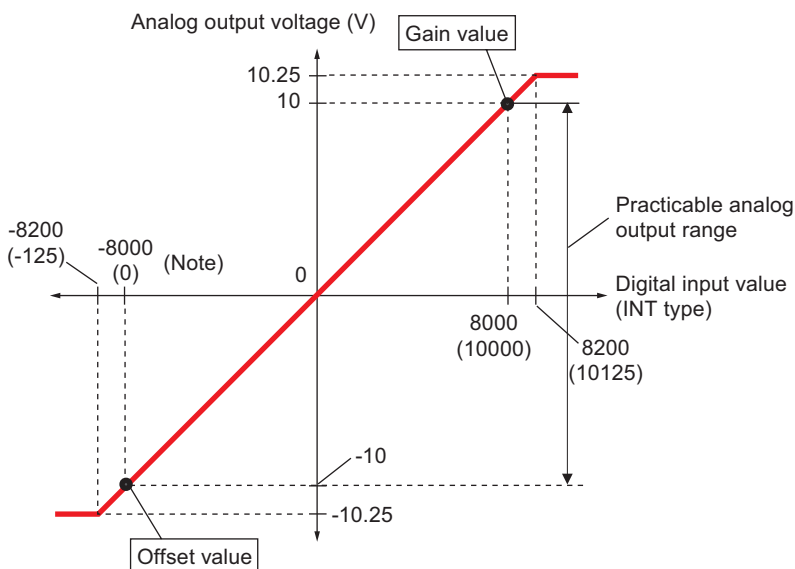

Note 1: Parenthesized figures mean the values when the unit of digital input value is % in Fixed Range Operation mode (excl. NP1AWH6-MR). In Software Set Range Operation mode, scaling is necessary to express input values by the %.

Note 2: For the range of -10 to 10 V, the unit of % cannot be selected by switch setting.

Note 3: If parameter mode is activated in Software Set Range Operation mode, analog output value becomes equal to the offset value, except that 0 V is output for the range of -10 to 10 V.

Section 2 Specifications

2-3 Conversion Characteristics

2-3-4 Conversion characteristics of analog current output

| Output range | Digital input range | |
|--------------|---------------------|------------|
| 4 to 20 mA | 0 to 16000 | 0 to 10000 |
| 0 to 20 mA | 0 to 16000 | 0 to 10000 |

1) Characteristic curve for the output range of 4 to 20 mA

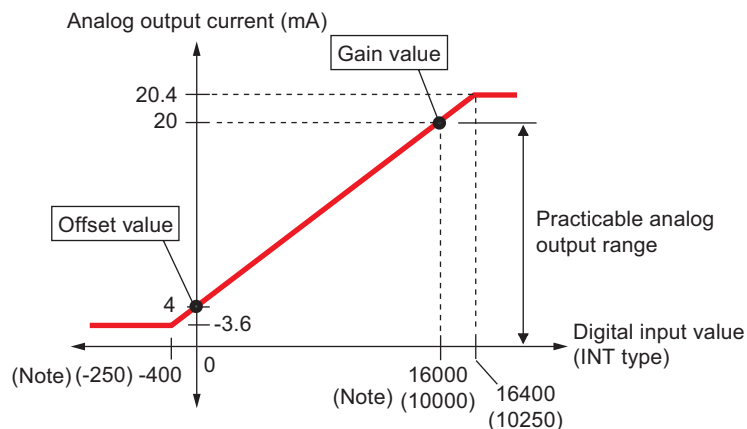

2) Characteristic curve for the output range of 0 to 20 mA

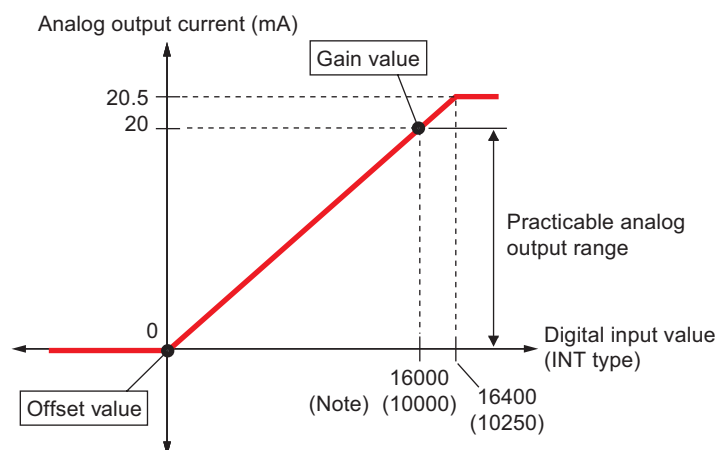

Note 1: Parenthesized figures mean the values when the unit of digital input value is % in Fixed Range Operation mode (excl. NP1AWH6-MR). In Software Set Range Operation mode, scaling is necessary to express input values by the %.

Note 2: If parameter mode is activated in Software Set Range Operation mode, analog output value becomes equal to the offset value.

Section 2 Specifications

2-4 Functional Specifications

2-4-1 Analog input module functions

(1) Switch batch setting function

With the operation setting switches provided on the module rear panel, it is possible to set the following items for all the channels in a batch:

- ◆ Operation range and the unit for digital conversion
- ◆ Moving average execution times (can be selected from 1, 2, 4 and 8 times).

When the unit of digital output value is set to %, the module operates, regarding

Lower limit value of range as 0.00%,
Upper limit value of range as 100.00%, and
Digital output range as -2.50% to 102.5%.

Note 1: If the Switch Batch Setting function is enabled after scaling values or other parameters have been changed from the parameter setting window, the changed parameters are not reflected on operation and the parameters return to the default values.

Note 2: When the switch is set to an invalid value, the status code of "30005" is returned to all the channels.

Note 3: The setting of the switch cannot be checked from application program. Be sure to check the switch setting before the system is started or before maintenance or replacement is performed.

⇒ For how to set the switch, refer to "2-5 Names and Functions".

(2) Individual channel operation range setting function

When the operation setting switch on the module rear panel is set to "Software Set Range", operation range can be set for individual channel by application program.

(3) Individual channel moving average execution times setting function

When the operation setting switch on the module rear panel is set to "Software Set Range", moving average execution times can be set for individual channel by application program. Default is once (sampling operation). Averaging execution times can be selected from 1, 2, 4 and 8.

Note: The "Average" switch on the module rear panel is disabled.

(4) Individual channel conversion enable/disable setting function

When the operation setting switch on the module rear panel is set to "Software Set Range", enable/disable of A/D conversion can be set for individual channel by application program. Default is "enable conversion".

Sampling time can be reduced by disabling A/D conversion for unused channels. For conversion disabled channels, digital output value is fixed to 0 (zero).

(5) Individual channel gain/offset value fine adjustment function

When the operation setting switch on the module rear panel is set to "Software Set Range", gain and offset values can finely be adjusted for individual channel by application program.

* For the detailed specifications and setting, refer to "4-1-2 (6)".

(6) Scaling function

When the operation setting switch on the module rear panel is set to "Software Set Range", the scale for A/D conversion can be set for individual channel by application program.

* For the detailed specifications and setting, refer to "4-1-2 (6)".

Section 2 Specifications

2-4 Functional Specifications

2-4-2 Analog output module functions

(1) Switch batch setting function

With the operation setting switches provided on the module rear panel, it is possible to set operation range and the unit for digital input value for all the channels in a batch.

When the unit of digital input value is set to %, the module operates, regarding

Lower limit value of range as 0.00%,
Upper limit value of range as 100.00%
Digital output range as 2.50% to 102.5%.

Note 1: If the Switch Batch Setting function is enabled after scaling values or other parameter have been changed from the parameter setting window, the changed parameters are not reflected on operation and the parameters return to the default values.

Note 2: When the switch is set to an invalid value, bit 11 of offset address +0 is set ON.

Note 3: The setting of the switch cannot be checked from application program. Be sure to check the switch setting before the system is started or before maintenance or replacement is performed.

⇒ For how to set the switch, refer to “2-5 Names and Functions”.

(2) Individual channel operation range setting function

When the operation setting switch on the module rear panel is set to “Software Set Range”, operation range can be set for individual channel by application program.

(3) Output enable/disable setting function (analog 8ch output modules only)

When the operation setting switch on the module rear panel is set to “Software Set Range”, “enable output for all channels” or “enable output for CH1 to CH4, disable output for CH5 to CH8” can be set by application program.

When “enable output for CH1 to CH4, disable output for CH5 to CH8” is set, sampling time is halved, and the output disabled channels output 0 V or 0 mA.

Note: Because the accuracy of output value is not guaranteed for output disabled channels, these channels may output slightly offset values.

(4) Individual channel gain/offset value fine adjustment function

When the operation setting switch on the module rear panel is set to “Software Set Range”, gain and offset values can finely be adjusted for individual channel by application program.

* For the detailed specifications and setting, refer to “4-2-2 (8)”.

(5) Scaling function

When the operation setting switch on the module rear panel is set to “Software Set Range”, the scale for D/A conversion can be set for individual channel by application program.

* For the detailed specifications and setting, refer to “4-2-2 (8)”.



When the system is started up, the analog value that corresponds to digital value “0” (zero) is output (for approximately several hundreds milliseconds since the “ONL” LED has lit till the application program starts). Therefore, for scaling, the value that corresponds to digital value “0” (zero) should be set such that fail safe operation will be performed. Also when the system is shut down or becomes abnormal, the analog value that corresponds to digital value “0” (zero) is output (when this module in I/O Reset mode).

Section 2 Specifications

2-4 Functional Specifications

2-4-3 Analog input/output module functions

(1) Switch batch setting function

With the operation setting switches provided on the module rear panel, it is possible to set operation range. For analog input, it can be set for 4 channels in a batch; for analog output, 2 channels in a batch.

Note 1: If the Switch Batch Setting function is enabled after scaling values or other parameter have been changed from the parameter setting window, the changed parameters are not reflected on operation and the parameters return to the default values.

Note 2: When the switch is set to an invalid value, the status code of "30005" is returned to all the channels.

Note 3: The setting of the switch cannot be checked from application program. Be sure to check the switch setting before the system is started or before maintenance or replacement is performed.

⇒ For how to set the switch, refer to "2-5 Names and Functions".

(2) Individual channel operation range setting function

When the operation setting switch on the module rear panel is set to "Software Set Range", operation range can be set for individual channel by application program.

(3) Individual channel moving average execution times setting function

When the operation setting switch on the module rear panel is set to "Software Set Range", moving average execution times can be set for individual channel by application program. Default is once (sampling operation). Averaging execution times can be selected from 1, 2, 4 and 8.

(4) Individual channel conversion enable/disable setting function

When the operation setting switch on the module rear panel is set to "Software Set Range", enable/disable of A/D conversion can be set for individual channel by application program. Default is "enable conversion".

Sampling time can be reduced by disabling A/D conversion for unused channels. For conversion disabled channels, digital output value is fixed to 0 (zero).

(5) Individual channel gain/offset value fine adjustment function

When the operation setting switch on the module rear panel is set to "Software Set Range", gain and offset values can finely be adjusted for individual channel by application program.

* For the detailed specifications and setting, refer to "4-3-2 (8)".

(6) Scaling function

When the operation setting switch on the module rear panel is set to "Software Set Range", the scale for A/D conversion can be set for individual channel by application program.

* For the detailed specifications and setting, refer to "4-3-2 (8)".

Section 2 Specifications

2-5 Names and Functions

2-5-1 Analog input module (NP1AXH8V-MR/NP1AXH8I-MR)

(1) Names

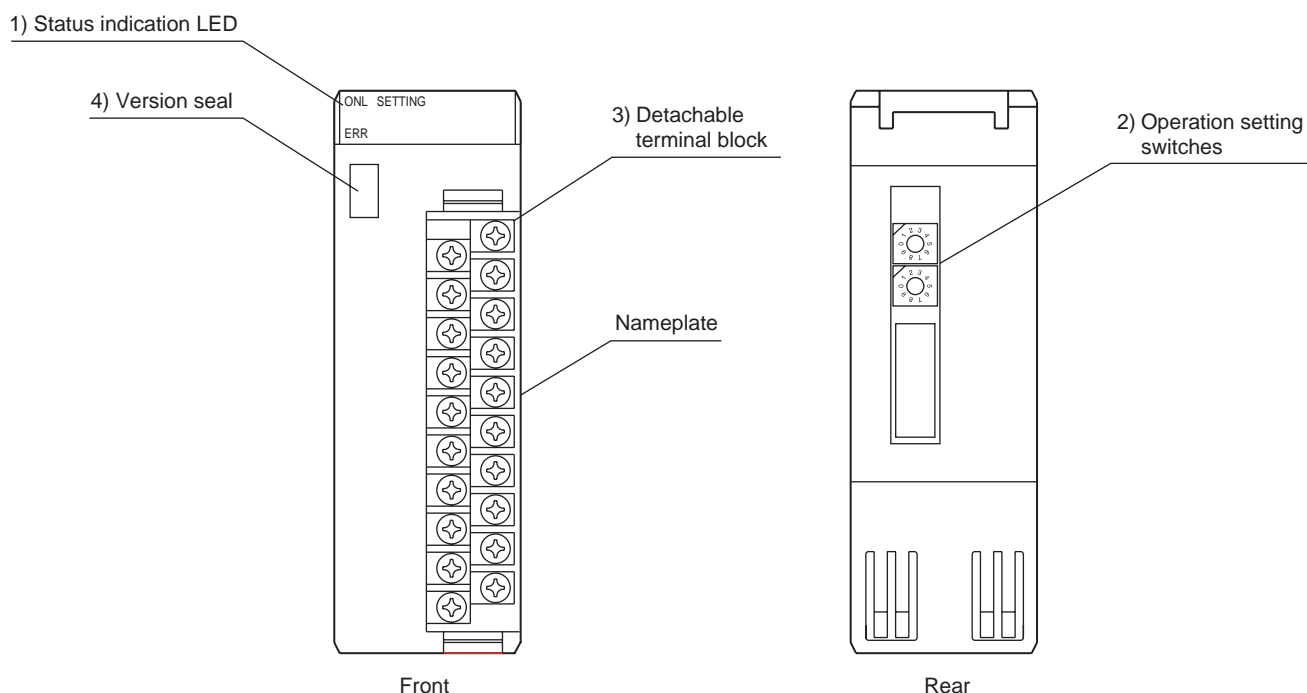

(2) Functions

1) Status Indication LED

Indicates the current status of the analog input module.

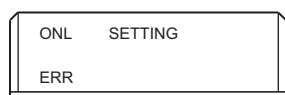

| Symbol | Color | Description |
|---------|-------|--|
| ONL | Green | Lights when the module is operating normally. Blinks while connecting to SX bus. |
| ERR | Red | Lights when the module is abnormal. |
| SETTING | Green | Blinks while gain or offset value is being adjusted. |

<Example of status indication>

O: Lighting, Δ : Blinking, -: Unlit

| Status | ONL (green) | ERR (red) | SETTING (green) |
|-----------------------------|-------------|-----------|-----------------|
| Initializing | Δ | - | - |
| Normally operating | O | - | - |
| Adjusting offset/gain value | O | - | Δ |
| Fatal fault | - | O | - |

Section 2 Specifications

2-5 Names and Functions

2) Operation setting switches

These switches are used to set input range and moving average execution times.

“Average” switch: Used to set a same value of moving average execution times for all channels. In Software Set Range Operation mode, the setting of this switch is ignored, and instead the initial value is used for operation. For more information, refer to “Section 4 Software Interface”.

“Range” switch: When this switch is set to one of numbers “0” to “7”, same range is set for all channels. It is impossible to set input range differently for individual channels. When this switch is set to “8”, Software Set Range Operation mode is activated, and it becomes possible to set various parameters differently for individual channels. For more information, refer to “Section 4 Software Interface”.

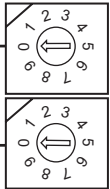

← At shipment, both “Average” and “Range” switches are set to “0” (zero).

<Range switch setting list>

| Switch No. | NP1AXH8V-MR | |
|------------------|---|----------------------|
| | Input range | Digital output range |
| 0 At shipment | -10 to 10 V | -8000 to 8000 |
| 1 | 0 to 10 V | 0 to 16000 |
| 2 | 0 to 5 V | |
| 3 | 1 to 5 V | |
| 4 | -10 to 10 V | 0 to 10000 |
| 5 | 0 to 10 V | |
| 6 | 0 to 5 V | |
| 7 | 1 to 5 V | |
| 8 | Software Set Range Operation mode (Note1) | |
| 9 | Unused (Note 2) | |

| Switch No. | NP1AXH8I-MR | |
|------------------|-----------------------------------|----------------------|
| | Input range | Digital output range |
| 0 At shipment | 4 to 20 mA | 0 to 16000 |
| 1 | 0 to 20 mA | |
| 2 | -20 to 20 mA | -8000 to 8000 |
| 3 | 4 to 20 mA | |
| 4 | 0 to 20 mA | 0 to 10000 |
| 5 | -20 to 20 mA | |
| 6 | Software Set Range Operation mode | |
| 7 | | |
| 8 | Unused (Note 2) | |
| 9 | | |

<Average switch setting list>

| Switch No. | NP1AXH8V-MR | NP1AXH8I-MR |
|------------------|----------------------------|-------------|
| 0 At shipment | Once (no moving average) | |
| 1 | Twice | |
| 2 | 4 times | |
| 3 | 8 times | |
| 4 to 9 | Unused (no moving average) | |

Note 1: For how to set in Software Set Range Operation mode, refer to “Section 4 Software Interface”.

Note 2: If an unused number is set, a “switch setting error” will occur.

3) Detachable terminal block

M3 20-pole detachable terminal block. For terminal arrangement, refer to “5-1-1 Terminal arrangement”. For wiring, be sure to use crimp type terminals and surely tighten them (tightening torque: 0.5 to 0.7 N-m.)

4) Version seal

Versions of the hardware and firmware of the module are indicated on this seal.

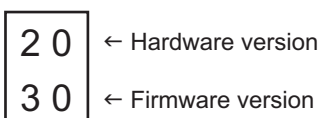

Section 2 Specifications

2-5 Names and Functions

2-5-2 Analog output module (NP1AYH8V-MR, NP1AYH8I-MR, NP1AYH4V-MR, NP1AYH4I-MR)

(1) Names

<Analog 8ch output module>

1) Status indication LED

4) Version seal

3) Detachable terminal block

2) Operation setting switches

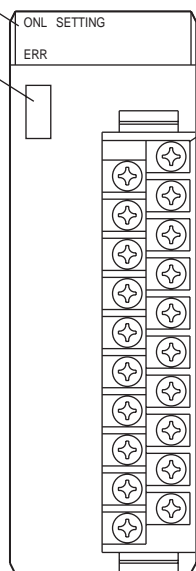

Front

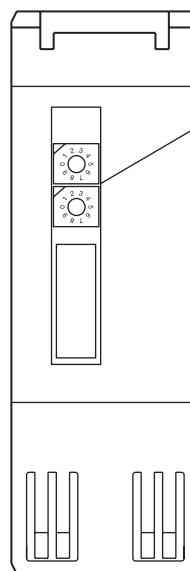

Rear

<Analog 4ch output module>

1) Status indication LED

4) Version seal

3) Detachable terminal block

2) Operation setting switches

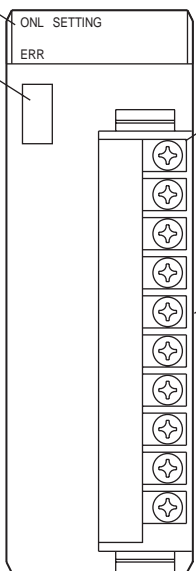

Front

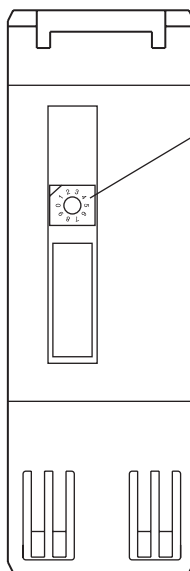

Rear

Section 2 Specifications

2-5 Names and Functions

(2) Functions

1) Status indication LED

Indicates the current status of the analog output module.

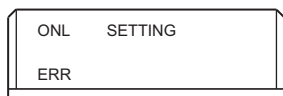

| Symbol | Color | Description |
|---------|-------|--|
| ONL | Green | Lights when the module is operating normally. Blinks while connecting to SX bus. |
| ERR | Red | Lights when the module is abnormal. |
| SETTING | Green | Blinks while gain or offset value is being adjusted. |

<Example of status indication>

O: Lighting, Δ: Blinking, -: Unlit

| Status | ONL (green) | ERR (red) | SETTING (green) |
|-----------------------------|-------------|-----------|-----------------|
| Initializing | Δ | - | - |
| Normally operating | O | - | - |
| Adjusting offset/gain value | O | - | Δ |
| Fatal fault | - | O | - |

2) Operation setting switch

Used to set output range.

“Range” switch: When this switch is set to one of numbers “0” to “7” (“0” to “3” for current output modules), same output range is set for all channels. It is impossible to set output range differently for individual channel. When this switch is set to “8” (“4” for current output modules), Software Set Range Operation mode is activated, and it becomes possible to set various parameters differently for individual channel. For more information, refer to “Section 4 Software Interface”.

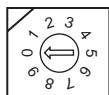

← At shipment, this switch is set to “0” (zero).

<Range switch setting list>

| Switch No. | NP1AYH8V-MR | |
|------------------|--|---------------------|
| | Output range | Digital input range |
| 0 At shipment | 0 to 10 V | 0 to 16000 |
| 1 | 0 to 5 V | |
| 2 | 1 to 5 V | |
| 3 | -10 to 10 V | -8000 to 8000 |
| 4 | 0 to 10 V | 0 to 10000 |
| 5 | 0 to 5 V | |
| 6 | 1 to 5 V | |
| 7 | Unused (the operation for switch No. 0) | |
| 8 | Software Set Range Operation mode (Note) | |
| 9 | Unused (the operation for switch No. 0) | |

| Switch No. | NP1AYH8I-MR | |
|------------------|---|---------------------|
| | Output range | Digital input range |
| 0 At shipment | 4 to 20 mA | 0 to 16000 |
| 1 | 0 to 20 mA | |
| 2 | 4 to 20 mA | 0 to 10000 |
| 3 | 0 to 20 mA | |
| 4 | Software Set Range Operation mode | |
| 5 | Unused (the operation for switch No. 0) | |
| 6 | | |
| 7 | | |
| 8 | Unused (the operation for switch No. 0) | |
| 9 | Unused (the operation for switch No. 0) | |

Note: For how to set in Software Set Range Operation mode, refer to "Section 4 Software Interface".

Section 2 Specifications

2-5 Names and Functions

3) Detachable terminal block

M3 20-pole detachable terminal block (M3 10-pole for 4ch output modules). For terminal arrangement, refer to “5-2-1 Terminal arrangement”. For wiring, be sure to use crimp type terminals and surely tighten them (tightening torque: 0.5 to 0.7 N-m.)

4) Version seal

Versions of the hardware and firmware of the module are indicated on this seal.

| | |
|----|--------------------|
| 20 | ← Hardware version |
| 30 | ← Firmware version |

Section 2 Specifications

2-5 Names and Functions

2-5-3 Analog input/output module (NP1AWH6-MR)

(1) Names

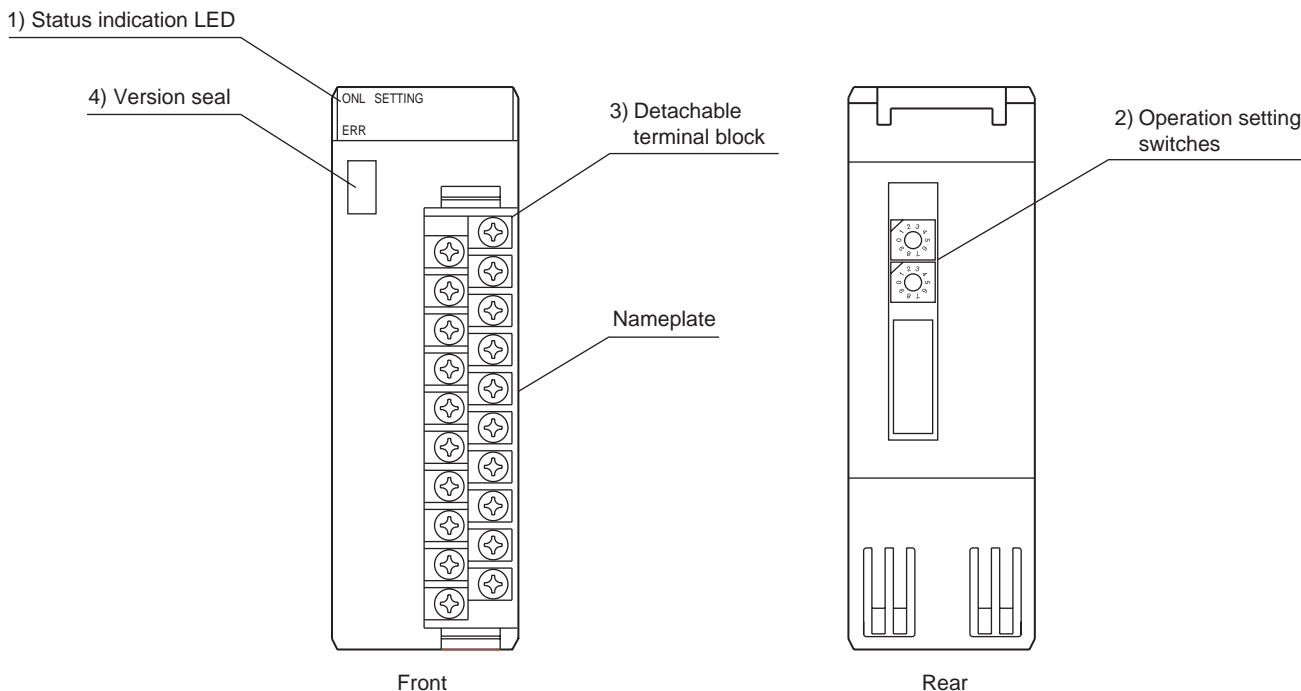

(2) Functions

1) Status Indication LED

Indicates the current status of the analog input/output module.

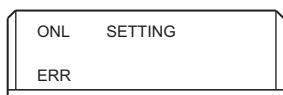

| Symbol | Color | Description |
|---------|-------|--|
| ONL | Green | Lights when the module is operating normally. Blinks while connecting to SX bus. |
| ERR | Red | Lights when the module is abnormal. |
| SETTING | Green | Blinks while gain or offset value is being adjusted. |

<Example of status indication>

O: Lighting, Δ : Blinking, -: Unlit

| Status | ONL (green) | ERR (red) | SETTING (green) |
|-----------------------------|-------------|-----------|-----------------|
| Initializing | Δ | - | - |
| Normally operating | O | - | - |
| Adjusting offset/gain value | O | - | Δ |
| Fatal fault | - | O | - |

Section 2 Specifications

2-5 Names and Functions

2) Operation setting switches

These switches are used to set input/output range. When input/output range is set with these switches, the same range is set for input and output channels. It is impossible to set input range differently for individual channels.

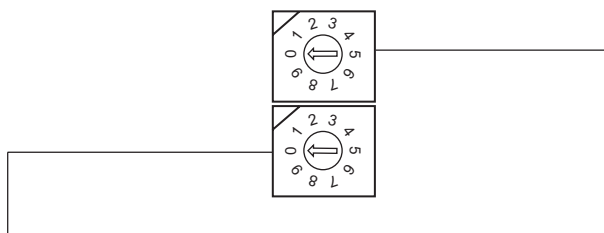

| Switch No. | Input range | Digital output range | Switch No. | Output range | Digital input range |
|------------------|--|----------------------|------------------|---|---------------------|
| 0 At shipment | 0 to 10 V | 0 to 16000 | 0 At shipment | 0 to 10V | 0 to 16000 |
| 1 | 0 to 5 V | | 1 | 0 to 5V | |
| 2 | 1 to 5 V | | 2 | 1 to 5V | |
| 3 | -10 to 10 V | -8000 to 8000 | 3 | -10 to 10V | -8000 to 8000 |
| 4 | 0 to 20 mA | 0 to 16000 | 4 | 0 to 20 mA | 0 to 16000 |
| 5 | 4 to 20 mA | | 5 | 4 to 20 mA | |
| 6 | -20 to 20mA | -8000 to 8000 | 6 | Unused (the operation for switch No. 0) | |
| 7 | Software Set Range Operation mode (Note) | | 7 | | |
| 8 | Unused (the operation for switch No. 0) | | 8 | | |
| 9 | Unused (the operation for switch No. 0) | | 9 | | |

Note: For how to set in Software Set Range Operation mode, refer to "Section 4 Software Interface".

3) Detachable terminal block

M3 20-pole detachable terminal block. For terminal arrangement, refer to "5-3-1 Terminal arrangement". For wiring, be sure to use crimp type terminals and surely tighten them (tightening torque: 0.5 to 0.7 N-m.)

4) Version seal

Versions of the hardware and firmware of the module are indicated on this seal.

| | |
|----|--------------------|
| 20 | ← Hardware version |
| 30 | ← Firmware version |

Section 2 Specifications

2-6 Dimensions

(Unit: mm)

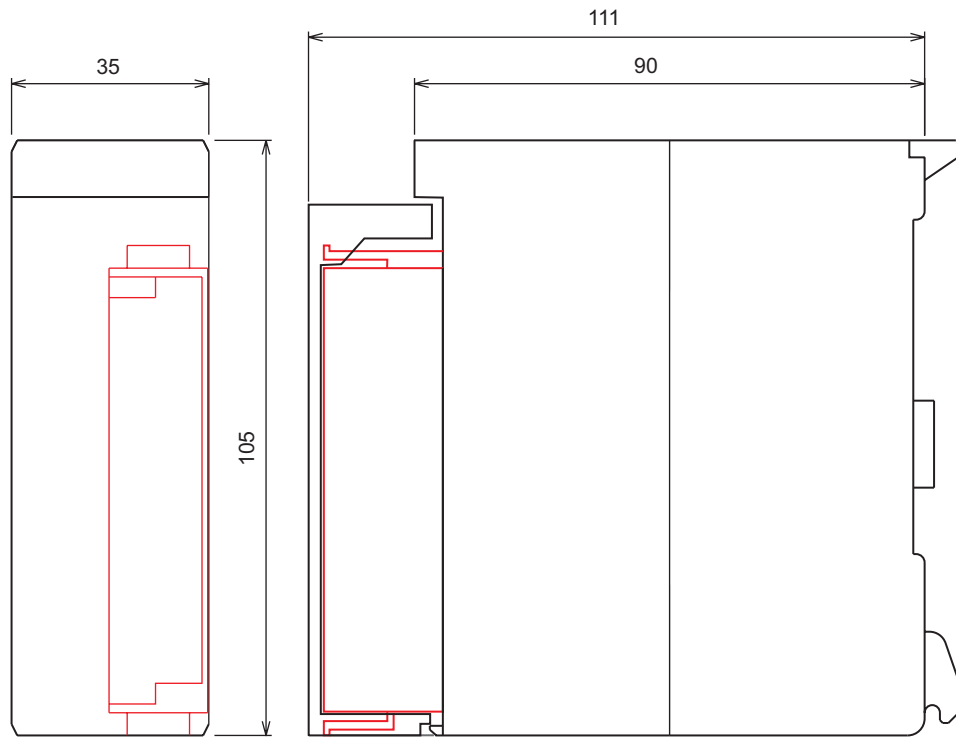

Section 3 System Configuration

3-1 Mounting on the Base Board

3-1-1 Mounting position

To use these modules, they need to be connected to the SX bus of MICREX-SX series SPH or to the link (remote I/O) of I/O master module. Their mounting position on the base board is as follows.

<8/11/13-slot base board>

These modules can be mounted in any slot except those for the power supply module (the two slots from the left on the base board).

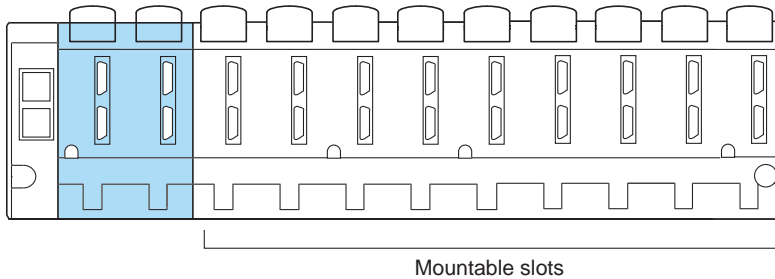

<3/6-slot base board>

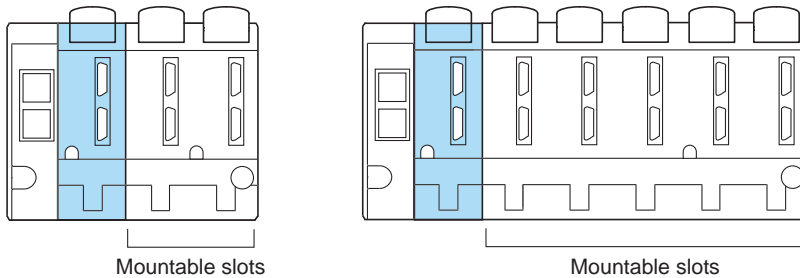

Note: These modules can be mounted also on the base board of remote I/O such as T-link, OPCN-1 and DeviceNet.

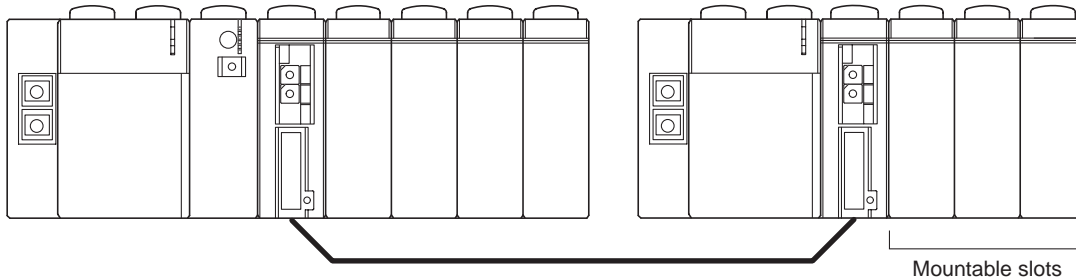

3-1-2 Number of mountable modules

It is possible to connect a maximum of 238 modules to the SX bus (a maximum of 254 modules in one configuration including the link of the I/O master) (due to hardware limitation). It should be noted, however, that the maximum number of analog voltage/current input modules and analog voltage/current output modules that can actually be connected is limited by the number of words (512 words) they occupy in the input/output areas (I/Q areas).

Because the number of words occupied by an analog 8ch module is 12 words and that occupied by an analog 4ch output module and analog input/output module is 8 words, the maximum number of mountable modules becomes as follows:

Analog 8ch modules: $512 \text{ words} / 12 \text{ words} = 42 \text{ units}$

Analog 4ch modules / Analog input/output module: $512 \text{ words} / 8 \text{ words} = 64 \text{ units}$

Note: Suppose that 42 units of 8ch analog modules are connected in one configuration, then the input/output areas that other input/output modules can use become 8 words.

Section 4 Software Interface

4-1 Analog Input Module

NP1AXH8V-MR (voltage input module) and NP1AXH8I-MR (current input module) occupy 12 words of I/O area (input: 8 words, output: 4 words).

4-1-1 Memory allocation in Switch Batch Setting mode

Moving average execution times for conversion operation is set with the “Average” switch (upper side switch on the module rear panel), and operation range is set with the “Range” switch (lower side switch on the module rear panel).

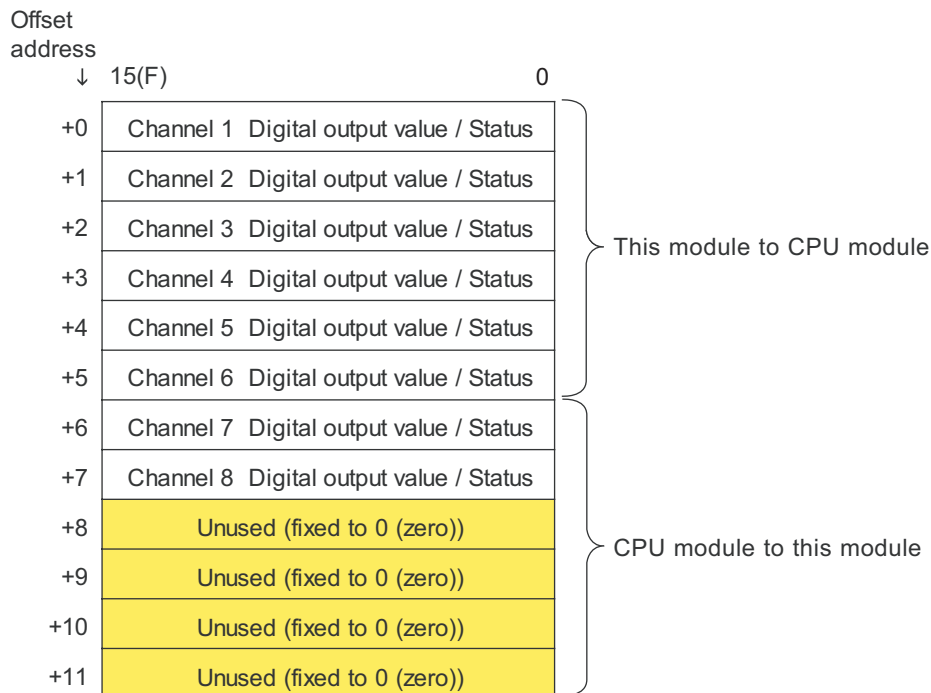

<Status list>

| Status code | Error | Description |
|------------------|--|--|
| 30002 (7532h) | EEPROM calibration data error (Module fatal fault) | If the calibration data of EEPROM is destroyed or if EEPROM cannot be written or read, this error is notified. Module internal EEPROM is abnormal. If this error occurred, it is necessary to replace the module. |
| 30003 (7533h) | EEPROM user setting data error | If the user setting data of EEPROM is destroyed, this error is notified. If this error occurred, all parameters need to be reset. If this error recurs even after parameters are reset, the module seems to have failed. |
| 30004 (7534h) | Internal power supply down | If the internal power supply of the module becomes down, this error is notified. |
| 30005 (7535h) | Switch setting error | If the operation setting switch on the module rear panel is set at invalid position, this error is notified. |
| 30006 (7536h) | Conversion error | If conversion became abnormal because the module failed or was used in an out-of-spec environment, this error is notified. |

| | |
|---|---|
|  | <p>Ordinarily digital output values (INT type) are stored in the registers explained above. If the module becomes abnormal, the following status code (INT type) is stored in these registers. When making an application program, be sure to interlock erroneous and normal (A/D conversion) conditions.</p> |
|---|---|

Section 4 Software Interface

4-1 Analog Input Module

4-1-2 Memory allocation in Software Set Range Operation mode

In Software Set Range Operation mode, memory allocation differs between when operating in A/D conversion mode (during normal operation) and when operating in parameter mode.

<When operating in A/D conversion mode>

When operating in A/D conversion mode, memory allocation becomes as follows:

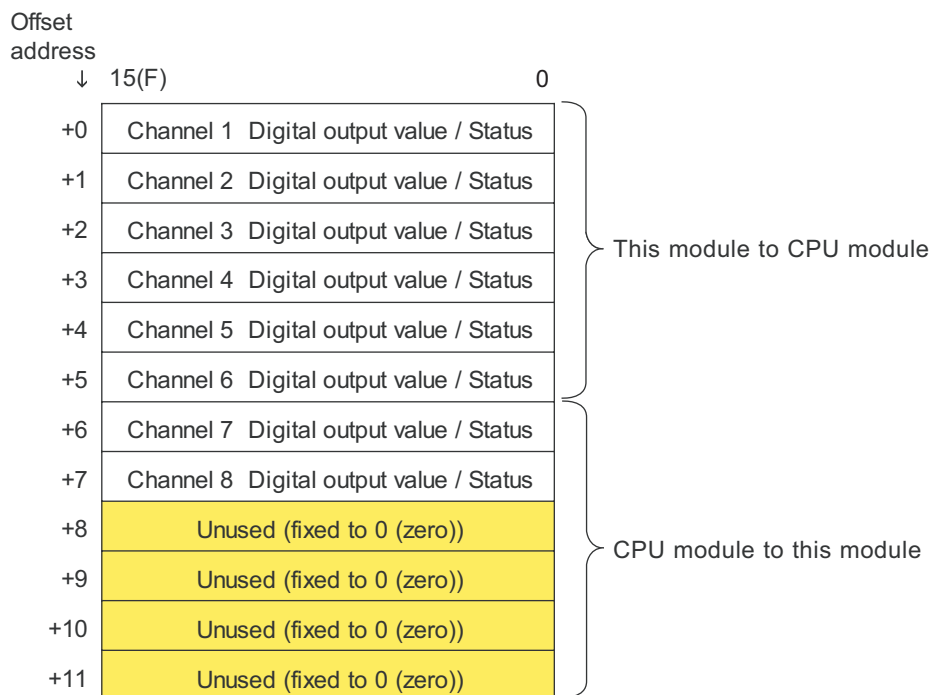

<When operating in parameter mode>

Parameter mode is activated when bit 7 of the parameter type setting register is set ON. In parameter mode, memory allocation becomes as follows:

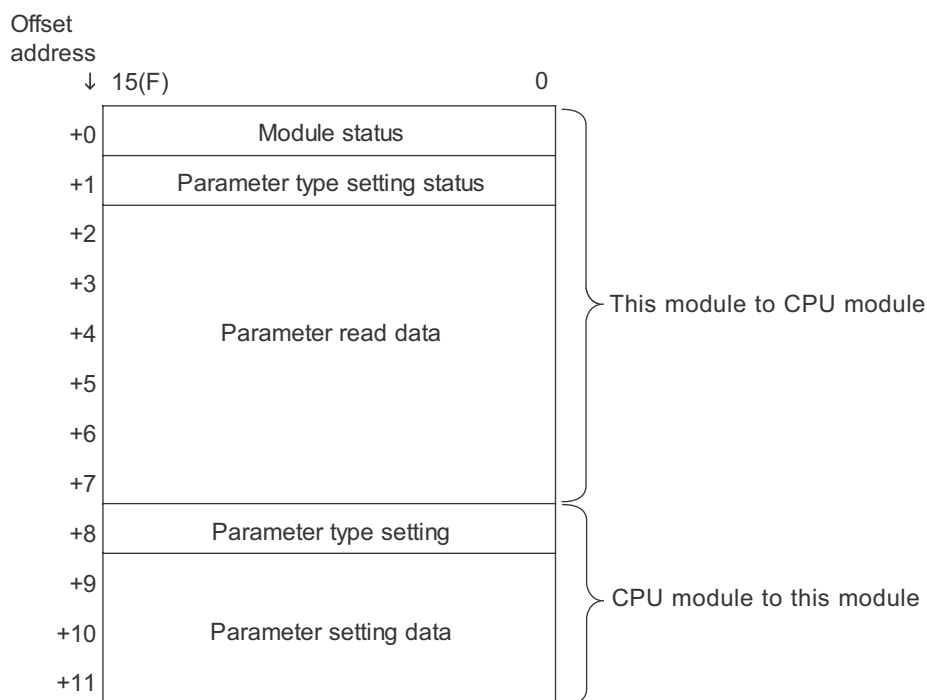

Section 4 Software Interface

4-1 Analog Input Module

(1) Digital output value/status register (offset address: +0 to +7)

When this module is in A/D conversion mode, digital output values and/or statuses are stored in the registers of offset address +0 to +7.

* When using D300win, assign INT type variables to these registers.

| | |
|----------------|---|
| Offset address | |
| ↓ 15(F) | 0 |
| +0 | Channel 1 Digital output value / Status |
| +1 | Channel 2 Digital output value / Status |
| +2 | Channel 3 Digital output value / Status |
| +3 | Channel 4 Digital output value / Status |
| +4 | Channel 5 Digital output value / Status |
| +5 | Channel 6 Digital output value / Status |
| +6 | Channel 7 Digital output value / Status |
| +7 | Channel 8 Digital output value / Status |

<Status list>

| Status code | Condition of modul | Description |
|------------------|---|--|
| 30001 (7531h) | Parameter mode | Parameters are now being set or read out. |
| 30002 (7532h) | EEPROM calibration data error (Module fatal fault) | If the calibration data of EEPROM is destroyed or if EEPROM cannot be written or read, this error is notified. Module internal EEPROM is abnormal. If this error occurred, it is necessary to replace the module. |
| 30003 (7533h) | EEPROM user setting data error | If the user setting data of EEPROM is destroyed, this error is notified. If this error occurred, all parameters need to be reset. If this error recurs even after parameters are reset, the module seems to have failed. |
| 30004 (7534h) | Internal power supply down | If the internal power supply of the module becomes down, this error is notified. |
| 30005 (7535h) | Switch setting error | If the operation setting switch on the module rear panel is set at invalid position, this error is notified. |
| 30006 (7536h) | Conversion error | If conversion became abnormal because the module failed or was used in an out-of-spec environment, this error is notified. |



Ordinarily digital output values (INT type) are stored in the registers explained above. If the module becomes abnormal, the following status code (INT type) is stored in these registers. When making an application program, be sure to interlock erroneous and normal (A/D conversion) conditions.

(2) Module status register (offset address +0)

When the module is in parameter mode, offset address +0 becomes the “module status register”, in which the code “30001” (INT type) is stored, indicating that the parameter mode (parameters are now being set or read out) is activated.

* When using D300win, assign an INT type variable to this register.

| | |
|----|--------------|
| +0 | 30001(7531h) |
|----|--------------|

Section 4 Software Interface

4-1 Analog Input Module

(3) Parameter type setting status register (offset address +1)

This register stores the information of what parameter is now being written or read by the module.

* When using D300win, assign a WORD type variable to this register. If you access by the bit, assign a BOOL type variable to each bit.

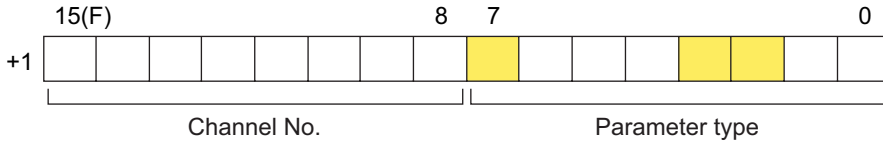

| Bit | Flag name | Description |
|-------|--------------------------------|--|
| 0 | Operation parameter read mode | ON: Operation parameter read mode (all channels in a batch) |
| 1 | Scaling parameter read mode | ON: Scaling parameter read mode (individual channel) |
| 2, 3 | Unused | |
| 4 | Operation parameter write mode | ON: Operation parameter write mode (all channels in a batch) |
| 5 | Scaling parameter write mode | ON: Scaling parameter write mode (individual channel) |
| 6 | Offset/gain adjustment mode | ON: Offset/gain adjustment mode (individual channel) |
| 7 | Unused | |
| 8 | Channel 1 | In "scaling parameter read mode", "scaling parameter write mode" or "offset/gain adjustment mode", one of bits 8 to 15 is set ON to indicate which channel is now being set or read out. |
| 9 | Channel 2 | |
| 10(A) | Channel 3 | |
| 11(B) | Channel 4 | |
| 12(C) | Channel 5 | |
| 13(D) | Channel 6 | |
| 14(E) | Channel 7 | |
| 15(F) | Channel 8 | |

(4) Parameter read data register (offset address +2 to +7)

In "operation parameter read mode", "scaling parameter read mode" or "offset/gain adjustment mode", the content of the setting for the corresponding mode is stored in this register.

1) When operation parameter read mode is activated

When parameter mode (module status register = 30001(7531h)) is activated and bit 0 of the parameter type setting status register is set ON, the status of the operation parameter is stored.

* When using D300win, assign WORD type variables to these registers.

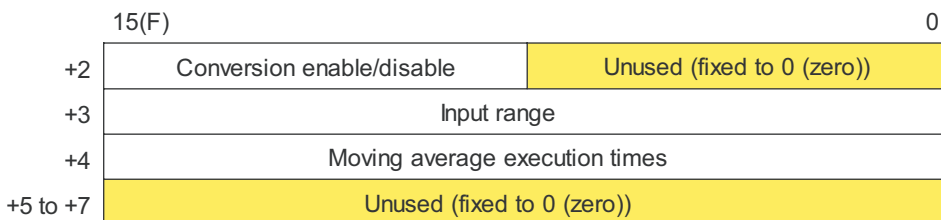

Section 4 Software Interface

4-1 Analog Input Module

<Conversion enable/disable, the unit of digital output value> (offset address +2)

| Bit | Flag name | Description |
|--------|-------------------------------------|-----------------------------|
| 0 to 7 | Unused | |
| 8 | Channel 1 Conversion enable/disable | OFF: Enable, ON: Disable |
| 9 | Channel 2 Conversion enable/disable | |
| 10 | Channel 3 Conversion enable/disable | |
| 11 | Channel 4 Conversion enable/disable | |
| 12 | Channel 5 Conversion enable/disable | |
| 13 | Channel 6 Conversion enable/disable | |
| 14 | Channel 7 Conversion enable/disable | |
| 15 | Channel 8 Conversion enable/disable | |

<Input range setting> (Offset address +3)

| Bit | Flag name | Description |
|------------------|-----------------------|--|
| 0 (L) 1 (H) | Channel 1 Input range | The set range is indicted by a combination of ON/OFF status of two bits. |
| 2 (L) 3 (H) | Channel 2 Input range | <NP1AXH8V-MR> H L OFF OFF : -10 to 10 V OFF ON : 0 to 10 V ON OFF : 0 to 5 V ON ON : 1 to 5 V |
| 4 (L) 5 (H) | Channel 3 Input range | |
| 6 (L) 7 (H) | Channel 4 Input range | |
| 8 (L) 9 (H) | Channel 5 Input range | |
| 10 (L) 11 (H) | Channel 6 Input range | <NP1AXH8I-MR> H L OFF OFF : 4 to 20 mA OFF ON : 0 to 20 mA ON OFF : -20 to 20 mA ON ON : 4 to 20 mA |
| 12 (L) 13 (H) | Channel 7 Input range | |
| 14 (L) 15 (H) | Channel 8 Input range | |

Section 4 Software Interface

4-1 Analog Input Module

<Moving average execution times setting> (offset address +4)

| Bit | Flag name | Description | | | | | | | | | | | | | | | |
|--------|--------------------------------|---|-----------|---|--|-----|-----|--------|-----|----|---------|----|-----|-----------|----|----|-----------|
| 0 (L) | Channel 1 | Moving average execution times is indicated by a combination of ON/OFF status of two bits. <table border="0"> <tr> <td>H</td> <td>L</td> <td></td> </tr> <tr> <td>OFF</td> <td>OFF</td> <td>: Once</td> </tr> <tr> <td>OFF</td> <td>ON</td> <td>: Twice</td> </tr> <tr> <td>ON</td> <td>OFF</td> <td>: 4 times</td> </tr> <tr> <td>ON</td> <td>ON</td> <td>: 8 times</td> </tr> </table> | H | L | | OFF | OFF | : Once | OFF | ON | : Twice | ON | OFF | : 4 times | ON | ON | : 8 times |
| H | L | | | | | | | | | | | | | | | | |
| OFF | OFF | | : Once | | | | | | | | | | | | | | |
| OFF | ON | | : Twice | | | | | | | | | | | | | | |
| ON | OFF | | : 4 times | | | | | | | | | | | | | | |
| ON | ON | | : 8 times | | | | | | | | | | | | | | |
| 1 (H) | Moving average execution times | | | | | | | | | | | | | | | | |
| 2 (L) | Channel 2 | | | | | | | | | | | | | | | | |
| 3 (H) | Moving average execution times | | | | | | | | | | | | | | | | |
| 4 (L) | Channel 3 | | | | | | | | | | | | | | | | |
| 5 (H) | Moving average execution times | | | | | | | | | | | | | | | | |
| 6 (L) | Channel 4 | | | | | | | | | | | | | | | | |
| 7 (H) | Moving average execution times | | | | | | | | | | | | | | | | |
| 8 (L) | Channel 5 | | | | | | | | | | | | | | | | |
| 9 (H) | Moving average execution times | | | | | | | | | | | | | | | | |
| 10 (L) | Channel 6 | | | | | | | | | | | | | | | | |
| 11 (H) | Moving average execution times | | | | | | | | | | | | | | | | |
| 12 (L) | Channel 7 | | | | | | | | | | | | | | | | |
| 13 (H) | Moving average execution times | | | | | | | | | | | | | | | | |
| 14 (L) | Channel 8 | | | | | | | | | | | | | | | | |
| 15 (H) | Moving average execution times | | | | | | | | | | | | | | | | |

2) When scaling parameter read mode is activated

When parameter mode is activated (module status register = 30001) and bit 1 of the parameter type setting status register is set ON, the scaling parameter setting status of the corresponding channel is stored.

* When using D300win, assign INT type variables to these registers.

| | | |
|---------|----------------------------|---|
| | 15(F) | 0 |
| +2 | Offset value | |
| +3 | Gain value | |
| +4 to 7 | Unused (fixed to 0 (zero)) | |

Section 4 Software Interface

4-1 Analog Input Module

3) When offset/gain adjustment mode is activated

When parameter mode is activated (module status register = 30001(7531h)) and bit 6 of the parameter type setting status register is set ON, the status of offset/gain adjustment is indicated. For this, the digital output values of the 5 channels starting with specified channel, EEPROM writing completion flag, and offset/gain value indication flag are displayed.

* When using D300win, assign an WORD type variable to this register (offset address+2). If you access by the bit, assign a BOOL type variable to each bit.

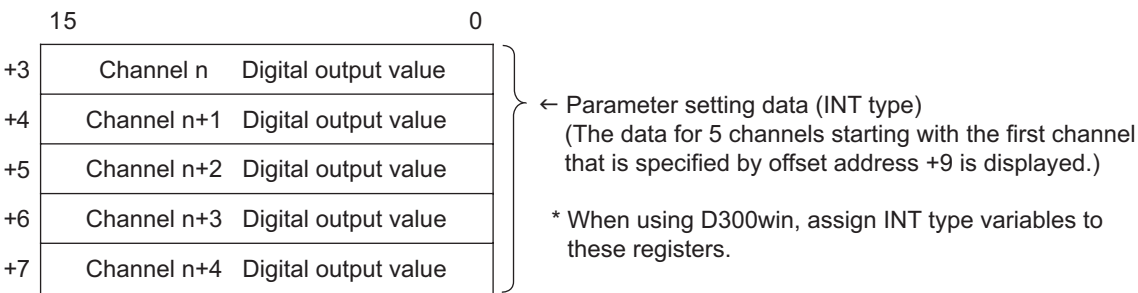
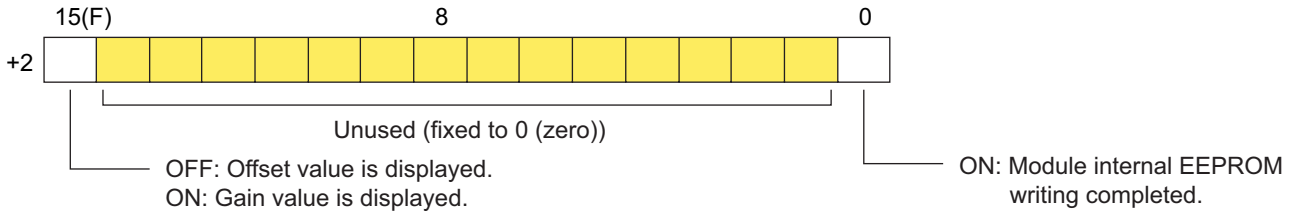

(5) Parameter type setting register (Offset address +8)

Parameter type and channel number for reading/writing parameters are set in this register.

* When using D300win, assign a WORD type variable to this register. If you access by the bit, assign a BOOL type variable to each bit.

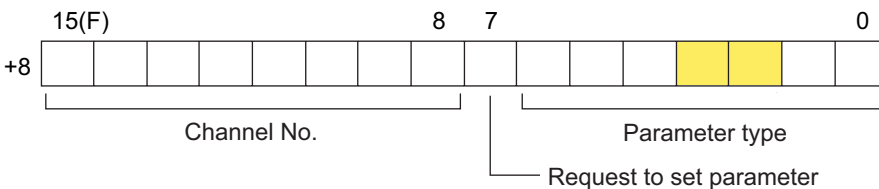

| Bit | Flag name | Description |
|------|--------------------------------|---|
| 0 | Operation parameter read mode | ON: Operation parameter read mode (all channels in a batch) |
| 1 | Scaling parameter read mode | ON: Scaling parameter read mode (individual channel) |
| 2, 3 | Unused | |
| 4 | Operation parameter write mode | ON: Operation parameter write mode (all channels in a batch) |
| 5 | Scaling parameter write mode | ON: Scaling parameter write mode (individual channel) |
| 6 | Offset/gain adjustment mode | ON: Offset/gain adjustment mode (individual channel) |
| 7 | Parameter mode | ON: Parameter mode, OFF: A/D conversion mode |
| 8 | Channel 1 | In "scaling parameter read mode", "scaling parameter write mode" or "offset/gain adjustment mode", arbitrary channel is specified. In "scaling parameter read mode", one of bits 8 to 15 is set ON to specify a channel for which parameters are to be set. When same data is to be set in "scaling parameter write mode" or "offset/gain adjustment mode", multiple arbitrary channels may be specified. |
| 9 | Channel 2 | |
| 10 | Channel 3 | |
| 11 | Channel 4 | |
| 12 | Channel 5 | |
| 13 | Channel 6 | |
| 14 | Channel 7 | |
| 15 | Channel 8 | |

Section 4 Software Interface

4-1 Analog Input Module

(6) Parameter setting data register (offset address +9 to +11)

When bit 7 of the parameter type setting register (offset address +8) is set ON, module status (offset address +0) becomes "30001" (INT type) and "parameter mode" is activated.

The set values of "operation parameter write" mode, "scaling parameter" mode or "offset/gain adjustment" mode are written in this register.

1) When operation parameter write mode is activated

In this mode, data is set in the locations as shown below, and "operation parameter write mode flag" (bit 4 of the parameter type setting register) is set ON.

* When using D300win, assign WORD type variables to these registers. If you access by the bit, assign a BOOL type variable to each bit.

| | | |
|--------|--------------------------------|----------------------------|
| | 15(F) | 0 |
| +9 | Conversion enable/disable | Unused (fixed to 0 (zero)) |
| +10(A) | Input range | |
| +11(B) | Moving average execution times | |

<Conversion enable/disable> (offset address +9)

| Bit | Flag name | Description |
|--------|-------------------------------------|--|
| 0 to 7 | Unused | |
| 8 | Channel 1 Conversion enable/disable | Conversion is enabled or disabled when the corresponding bit is set to OFF or ON. OFF: Enable, ON: Disable |
| 9 | Channel 2 Conversion enable/disable | |
| 10 | Channel 3 Conversion enable/disable | |
| 11 | Channel 4 Conversion enable/disable | |
| 12 | Channel 5 Conversion enable/disable | |
| 13 | Channel 6 Conversion enable/disable | |
| 14 | Channel 7 Conversion enable/disable | |
| 15 | Channel 8 Conversion enable/disable | |

<Input range> (offset address +10)

| Bit | Flag name | Description | | | | | | | | | | | | | | | | | | | | | | | | |
|----------------|-----------------------|---|--|-----------------------|--|---------------|--|-----|--|-----|--|-----------------------|--|----------------------|--|--------------------|--|---------------------|--|-------------------|--|-----------------------|--|------------------|--|--------------------|
| 0 (L), 1 (H) | Channel 1 Input range | Range is set by a combination of ON/OFF status of two bits. | | | | | | | | | | | | | | | | | | | | | | | | |
| 2 (L), 3 (H) | Channel 2 Input range | <table style="width: 100%; border: none;"> <tr> <td style="width: 50%;"></td> <td style="text-align: center;"><NP1AXH8V-MR></td> <td style="width: 50%;"></td> <td style="text-align: center;"><NP1AXH8I-MR></td> </tr> <tr> <td></td> <td style="text-align: center;">H L</td> <td></td> <td style="text-align: center;">H L</td> </tr> <tr> <td></td> <td>OFF OFF : -10 to 10 V</td> <td></td> <td>OFF OFF : 4 to 20 mA</td> </tr> <tr> <td></td> <td>OFF ON : 0 to 10 V</td> <td></td> <td>OFF ON : 0 to 20 mA</td> </tr> <tr> <td></td> <td>ON OFF : 0 to 5 V</td> <td></td> <td>ON OFF : -20 to 20 mA</td> </tr> <tr> <td></td> <td>ON ON : 1 to 5 V</td> <td></td> <td>ON ON : 4 to 20 mA</td> </tr> </table> | | <NP1AXH8V-MR> | | <NP1AXH8I-MR> | | H L | | H L | | OFF OFF : -10 to 10 V | | OFF OFF : 4 to 20 mA | | OFF ON : 0 to 10 V | | OFF ON : 0 to 20 mA | | ON OFF : 0 to 5 V | | ON OFF : -20 to 20 mA | | ON ON : 1 to 5 V | | ON ON : 4 to 20 mA |
| | <NP1AXH8V-MR> | | | <NP1AXH8I-MR> | | | | | | | | | | | | | | | | | | | | | | |
| | H L | | | H L | | | | | | | | | | | | | | | | | | | | | | |
| | OFF OFF : -10 to 10 V | | | OFF OFF : 4 to 20 mA | | | | | | | | | | | | | | | | | | | | | | |
| | OFF ON : 0 to 10 V | | | OFF ON : 0 to 20 mA | | | | | | | | | | | | | | | | | | | | | | |
| | ON OFF : 0 to 5 V | | | ON OFF : -20 to 20 mA | | | | | | | | | | | | | | | | | | | | | | |
| | ON ON : 1 to 5 V | | | ON ON : 4 to 20 mA | | | | | | | | | | | | | | | | | | | | | | |
| 4 (L), 5 (H) | Channel 3 Input range | | | | | | | | | | | | | | | | | | | | | | | | | |
| 6 (L), 7 (H) | Channel 4 Input range | | | | | | | | | | | | | | | | | | | | | | | | | |
| 8 (L), 9 (H) | Channel 5 Input range | | | | | | | | | | | | | | | | | | | | | | | | | |
| 10 (L), 11 (H) | Channel 6 Input range | | | | | | | | | | | | | | | | | | | | | | | | | |
| 12 (L), 13 (H) | Channel 7 Input range | | | | | | | | | | | | | | | | | | | | | | | | | |
| 14 (L), 15 (H) | Channel 8 Input range | | | | | | | | | | | | | | | | | | | | | | | | | |

Section 4 Software Interface

4-1 Analog Input Module

<Moving average execution times> (offset address +11)

| Bit | Flag name | Description |
|--------|--------------------------------|---|
| 0 (L) | Channel 1 | Moving average execution times is set by a combination of ON/OFF status of two bits. H L OFF OFF : Once OFF ON : Twice ON OFF : 4 times ON ON : 8 times |
| 1 (H) | Moving average execution times | |
| 2 (L) | Channel 2 | |
| 3 (H) | Moving average execution times | |
| 4 (L) | Channel 3 | |
| 5 (H) | Moving average execution times | |
| 6 (L) | Channel 4 | |
| 7 (H) | Moving average execution times | |
| 8 (L) | Channel 5 | |
| 9 (H) | Moving average execution times | |
| 10 (L) | Channel 6 | |
| 11 (H) | Moving average execution times | |
| 12 (L) | Channel 7 | |
| 13 (H) | Moving average execution times | |
| 14 (L) | Channel 8 | |
| 15 (H) | Moving average execution times | |

Section 4 Software Interface

4-1 Analog Input Module

2) When scaling parameter write mode is activated

For scaling, data is set in the locations shown below.

* When using D300win, assign INT type variables to these registers.

| | |
|-------|----------------------------|
| 15(F) | 0 |
| +9 | Offset value |
| +10 | Gain value |
| +11 | Unused (fixed to 0 (zero)) |

<Scaling>

The analog input modules convert the analog values that are input to them into digital values. The operation to change the width (scale) of converted digital values is referred to as “scaling”. The available range of scaling of these modules is -25000 to 25000 (INT type). If a value that is out of this range is set, it will be limited to -25000 or 25000.

<Initial value for the scaling of input range>

| Input range | Initial value of scaling | Scaling range |
|--------------|--------------------------|-----------------|
| 0 to 5 V | 0 to 16000 | 0 to 25000 |
| 1 to 5 V | 0 to 16000 | 0 to 25000 |
| 0 to 10 V | 0 to 16000 | 0 to 25000 |
| -10 to 10 V | -8000 to 8000 | -25000 to 25000 |
| 4 to 20 mA | 0 to 16000 | 0 to 25000 |
| 0 to 20 mA | 0 to 16000 | 0 to 25000 |
| -20 to 20 mA | -8000 to 8000 | -25000 to 25000 |

Note 1: Scaling is enabled only when the operation setting switch on the module rear panel is set to “Soft Set Range Operation mode”. In fixed range operation mode, scaling is disabled.

Note 2: Over range is fixed to “(Gain value - Offset value) x 0.025 + Gain value”.

“(Gain value - Offset value) x 0.0125 + Gain value” for the range of -10 to +10 V or of -20 to +20 mA)

On the other hand, under range is fixed to “Offset value - (Gain value - Offset value) x 0.025”.

“(Offset value - (Gain value - Offset value) x 0.0125)” for the range of -10 to +10 V or of -20 to +20 mA)

Note 3: If scaling results in “resolution < maximum resolution”, digital output value does not change in steps of one.

Note 4: Once scaling values are set, they won't change even when range is changed in Soft Set Range Operation mode.

<Example of scaling>

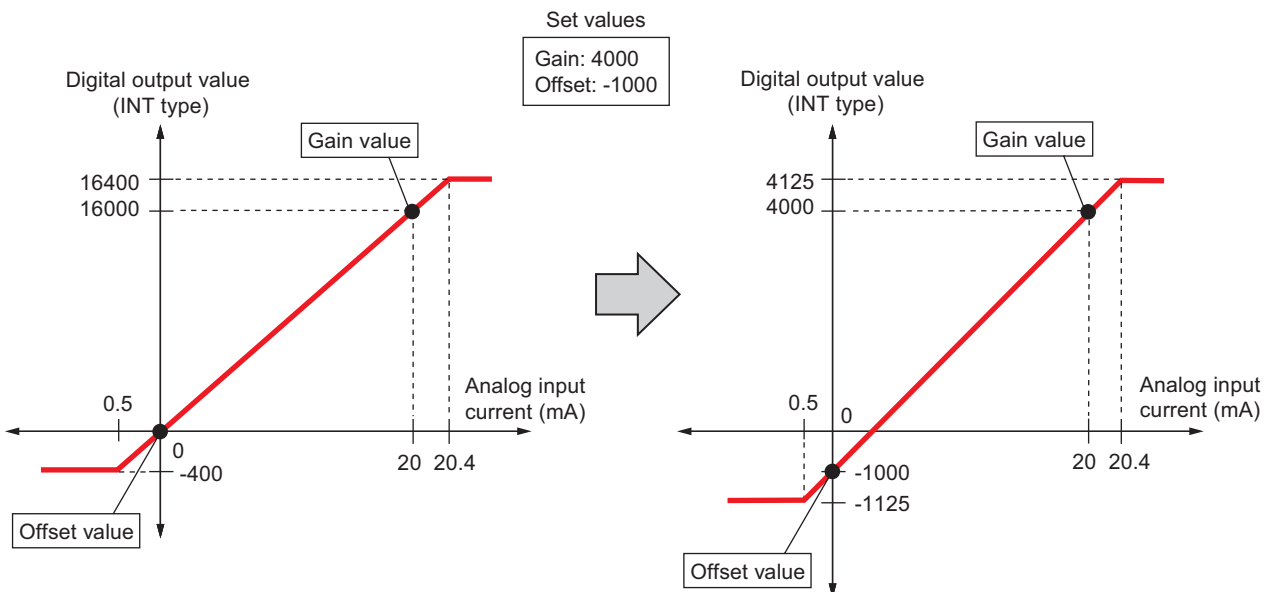

Section 4 Software Interface

4-1 Analog Input Module

<Procedure for scaling>

- 1) Set ON bit 7 of the parameter type setting register to activate parameter mode. (Make sure that module status is "30001".)
- 2) Input gain and offset values to the parameter setting data register, and set ON bit 5 and bit 8 (in the case of channel 1) of the parameter type setting register. Bit 7 must be kept ON.
(In the above example of scaling, set as follows.)

| | | |
|-----|----------------------------|---|
| | 15(F) | 0 |
| +9 | -1000 | |
| +10 | 4000 | |
| +11 | Unused (fixed to 0 (zero)) | |

- 3) Make sure that bit 5 (scaling parameter write mode) and bit 8 (channel 1) of the parameter type setting register are set ON.
- 4) Set OFF all the bits of the parameter type setting register, and clear all the bits of the parameter setting data register to zero. This completes the operation for adjustment.

Section 4 Software Interface

4-1 Analog Input Module

3) When offset/gain adjustment mode is activated

For offset/gain adjustment, data is set in the locations shown below:

* When using D300win, assign INT type variables to these registers.

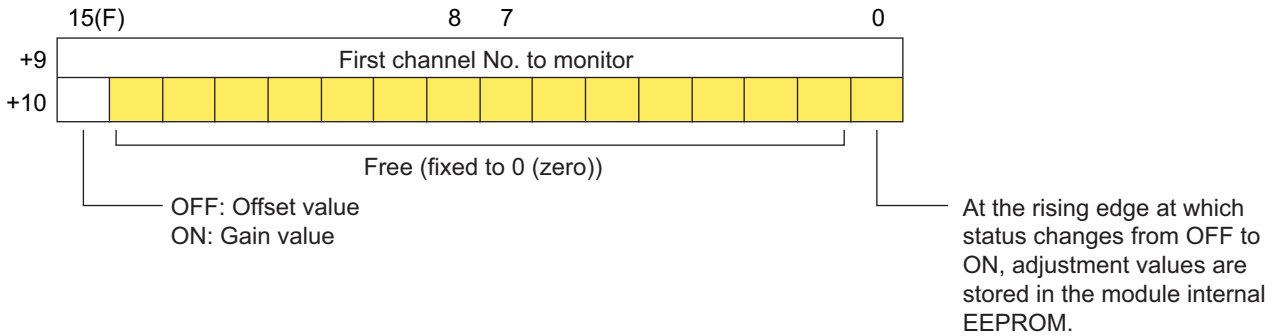

<Offset/gain adjustment>

In this mode, offset value and/or gain value can finely be adjusted for individual channel.

- Offset value: Means the lower limit value of the range span. When this value is adjusted, the conversion characteristic curve moves parallel in vertical direction.
- Gain value: Means the upper limit value of the range span. When this value is adjusted, only gain value is changed while offset value is kept unchanged.

When offset and gain values are changed by scaling, the values that are set by scaling take effect as offset and gain values. When offset and/or gain values are to be adjusted after scaling, adjust by the values of scaling.

Note 1: Offset/gain adjustable range is within $\pm 1\%$ of range span. If adjustment is made using an analog value that exceeds the adjustable range (if the value is input to a terminal of the module), the value is limited to $\pm 1\%$ of range span.

Note 2: If range is changed, offset and gain return to the default values.

Note 3: Offset/gain adjustment is disabled when analog range is set in a batch with the switch provided on the module rear panel.

<Example 1 of gain/offset adjustment>

Offset and gain values for the range of 0 to 5 V.

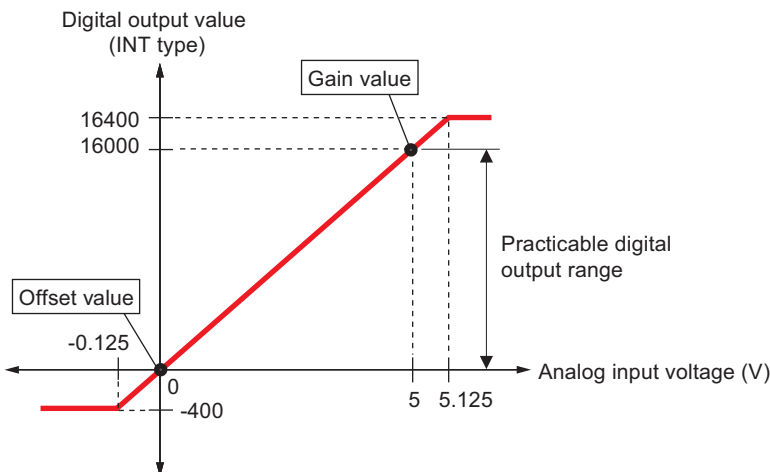

Section 4 Software Interface

4-1 Analog Input Module

<Example 2 of gain/offset adjustment>

Offset and gain values for the range of -10 to 10 V.

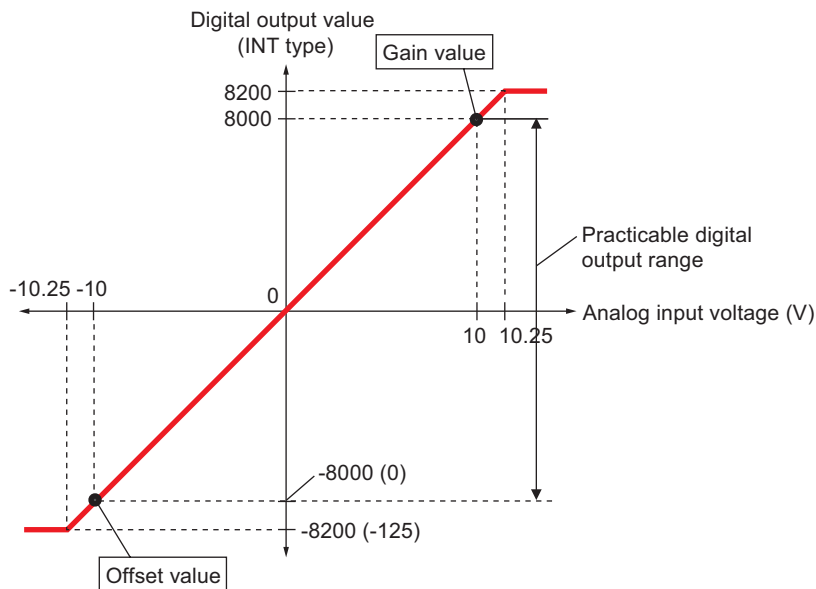

<Offset/gain adjustment procedure>

Offset is adjusted first.

- 1) Set ON bit 7 and bit 6 of the parameter type setting register to activate offset/gain adjustment mode. (Make sure that module status is "30001".)
- 2) Set ON the bit for the channel to be adjusted (the corresponding bit of bits 8 to 15 of the parameter type setting register). (The "SETTING" LED of the module blinks.)
- 3) Apply a voltage (or a current) that corresponds to the offset value to the terminal of the channel that is to be adjusted.
- 4) Set ON bit 0 (zero) of offset address +10 of the parameter type setting register to write the offset adjustment value in the module internal EEPROM. When bit 0 (zero) of offset address +2 is set ON, the writing of EEPROM is completed. After confirming this, set OFF bit 0 (zero) of the parameter setting data register.
- 5) Then set bit 0 (zero) OFF and bit 15 ON of offset address +10 of the parameter type setting register. (Gain adjustment)
- 6) Apply a voltage (or a current) that corresponds to the gain value to the terminal.
- 7) Set ON bit 0 (zero) of offset address +10 of the parameter type setting register to write the gain adjustment value in the module internal EEPROM. Confirm the completion of writing in the same way as explained for offset adjustment.
- 8) Set OFF all the bits of the parameter type setting register, and clear all the bits of the parameter setting data register to zero. This completes the operation for adjustment.

[Reference]

For concrete operating method with the SX Control Utility of D300win, refer to "Appendix 1 Offset/Gain Adjustment <D300win>". For concrete operating method with SX-Programmer Standard, refer to "Appendix 2 Offset/Gain Adjustment <SX-Programmer Standard>".

Section 4 Software Interface

4-2 Analog Output Module

NP1AYH8V-MR (voltage output module) and NP1AYH8I-MR (current output module) occupy 12 words of I/O area (input: 4 words, output: 8 words); NP1AYH4V-MR (voltage output module) and NP1AYH4I-MR (current output module) occupy 8 words of I/O area (input: 4 words, output: 4 words).

4-2-1 Memory allocation in Switch Batch Setting mode

<Analog 8ch output>

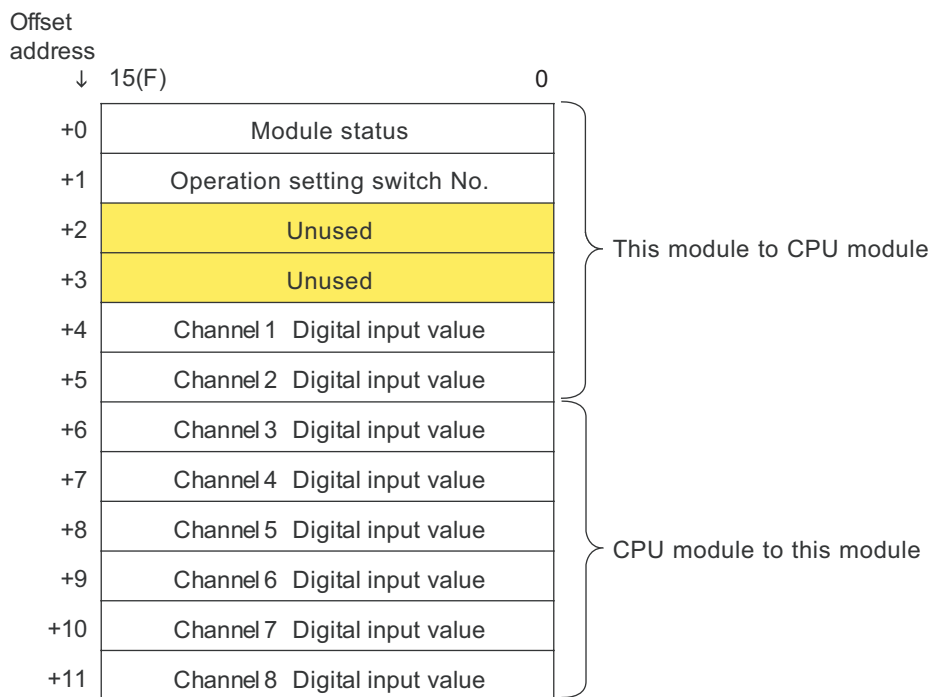

<Analog 4ch output>

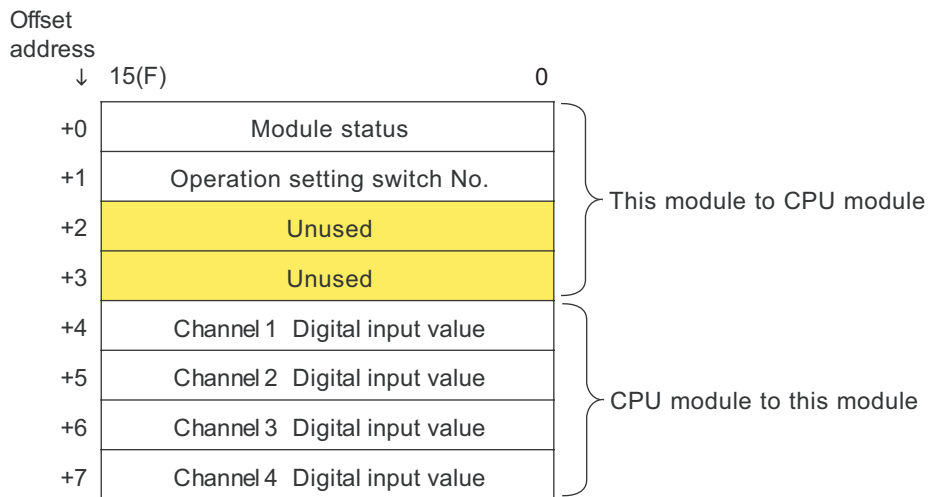

Section 4 Software Interface

4-2 Analog Output Module

(1) Module status register (offset address +0)

Operation information and RAS information of this module are stored in this register.

* When using D300win, assign a WORD type variable to this register. If you access by the bit, assign a BOOL type variable to each bit.

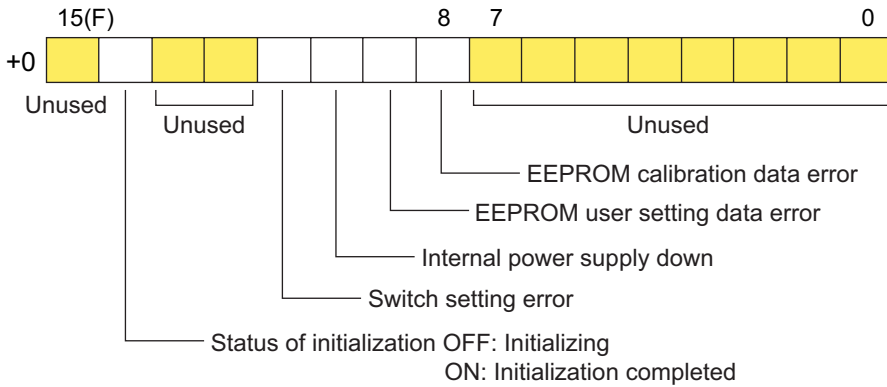

| Error | Cause and remedy |
|--------------------------------|--|
| EEPROM calibration data error | If the calibration data of EEPROM is destroyed or if EEPROM cannot be written, this error is notified. Module internal EEPROM is abnormal. |
| EEPROM user setting data error | If the user setting data of EEPROM is destroyed, this error is notified. If this error occurred, all parameters need to be reset. If this error recurs even after parameters are reset, the module seems to have failed. |
| Internal power supply down | If the internal power supply of the module becomes down, this error is notified. Because output is stopped in case of this error, interlock should be provided as needed for the interface with external devices. |
| Switch setting error | If the operation setting switch on the module rear panel is set at invalid position, this error is notified. |

(2) Switch setting No. (offset address +1)

The set value (INT type) of the operation setting switch that is provided on the module rear panel is stored in this memory area.

* When using D300win, assign an INT type variable to this register.

(3) Digital input values of channels 1 to 8 (offset address +4 to +11)

The digital values to undergo D/A conversion are stored in these memory areas. Just after the system is powered up, 0 V or 0 mA is output. When the initialization of the module is completed, the analog value that corresponds to the digital input value of 0 (zero) is output, and initialization completion flag (bit 15 of offset address +0) is set ON. For more information of conversion characteristics, refer to "2-3 Conversion Characteristics".

* When using D300win, assign INT type variables to these registers.

| Offset address | |
|----------------|-------------------------------|
| ↓ 15(F) | 0 |
| +4 | Channel 1 Digital input value |
| +5 | Channel 2 Digital input value |
| +6 | Channel 3 Digital input value |
| +7 | Channel 4 Digital input value |
| +8 | Channel 5 Digital input value |
| +9 | Channel 6 Digital input value |
| +10 | Channel 7 Digital input value |
| +11 | Channel 8 Digital input value |

← Up to this address for analog 4ch modules

Section 4 Software Interface

4-2 Analog Output Module

4-2-2 Memory allocation in Software Set Range Operation mode

In Software Set Range Operation mode, memory allocation differs between when operating in D/A conversion mode (during normal operation) and when operating in parameter mode.

<When operating in D/A conversion mode>

When operating in D/A conversion mode, memory allocation becomes as shown below:

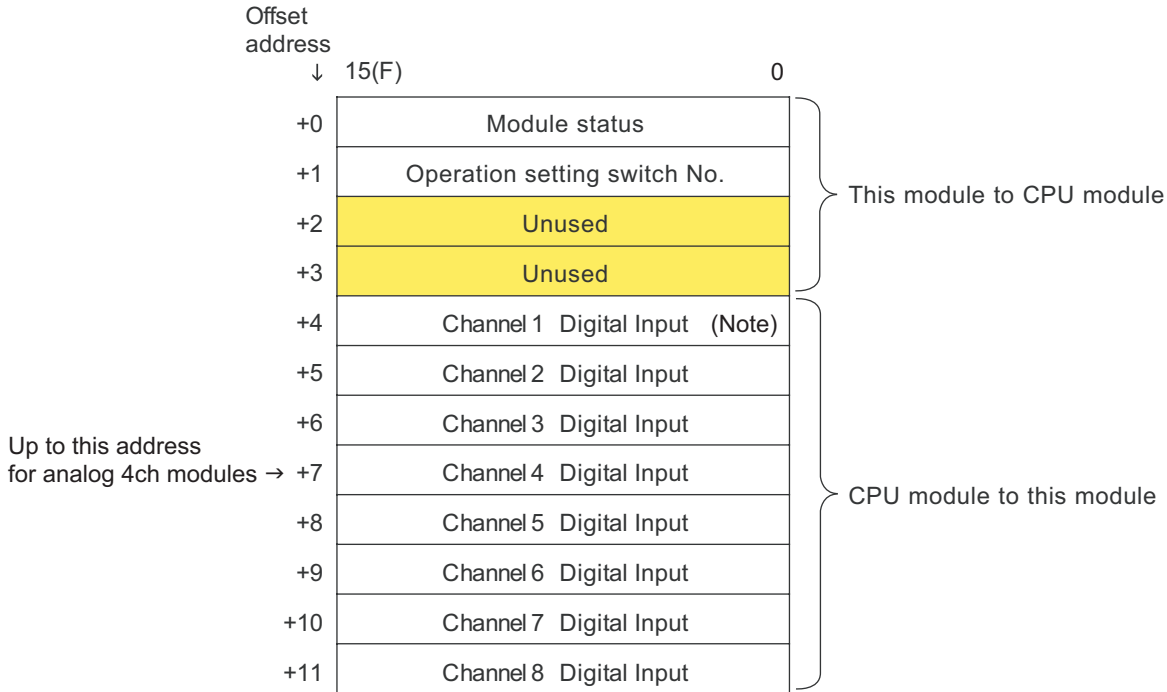

Note: In D/A conversion mode, the digital input value register for channel 1 (offset address +4) serves also as the setting command register (for changing over to parameter mode) and therefore interlock is necessary.

When a value in the range from “30000” to “32767” is input to this register, parameter mode is activated. Just after parameter mode is activated, analog output value is equal to the offset value (0 V for the range of -10 to 10 V).

<When operating in parameter mode>

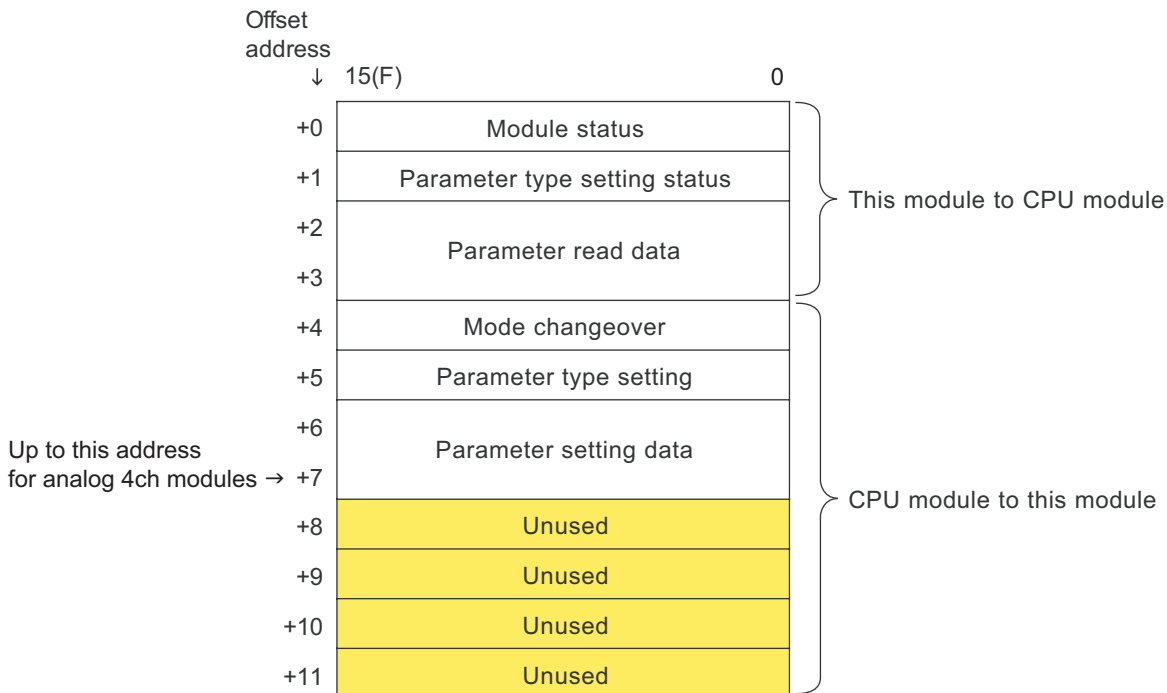

Section 4 Software Interface

4-2 Analog Output Module

(1) Module status (offset address +0)

Operation information and RAS information of this module are stored in this register. This register is common to D/A conversion mode and parameter mode.

* When using D300win, assign a WORD type variable to this register. If you access by the bit, assign a BOOL type variable to each bit.

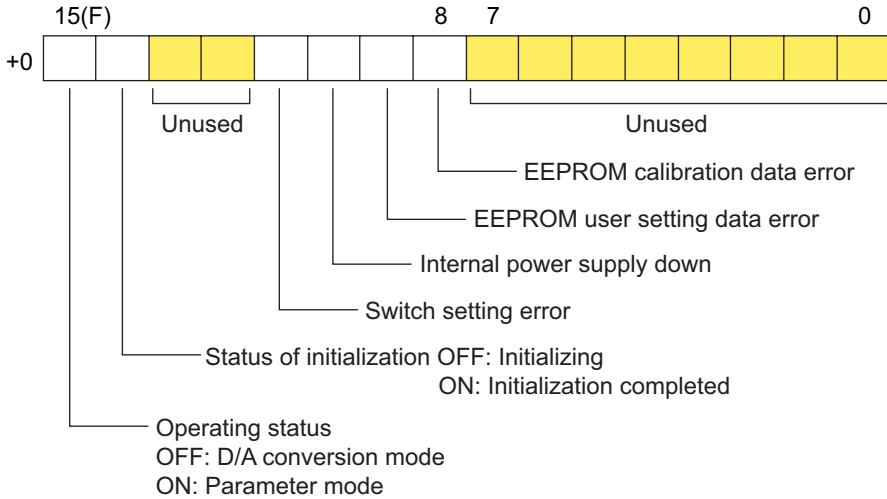

| Error | Cause and remedy |
|--------------------------------|--|
| EEPROM calibration data error | If the calibration data of EEPROM is destroyed or if EEPROM cannot be written or read out, this error is notified. Module internal EEPROM is abnormal. If this error occurred, it is necessary to replace the module. |
| EEPROM user setting data error | If the user setting data of EEPROM is destroyed, this error is notified. If this error occurred, all parameters need to be reset. If this error recurs even after parameters are reset, the module seems to have failed. |
| Internal power supply down | If the internal power supply of the module becomes down, this error is notified. Because output is stopped in case of this error, interlock should be provided as needed for the interface with external devices. |
| Switch setting error | If the operation setting switch on the module rear panel is set at invalid position, this error is notified. |

(2) Operation setting switch setting No. (offset address +1)

The set value (INT type) of the operation setting switch on the module rear panel is stored in this memory area.

* When using D300win, assign an INT type variable to this register.

Section 4 Software Interface

4-2 Analog Output Module

(3) Digital input values of channels 1 to 8 (offset address +4 to +11)

The digital values to undergo D/A conversion are stored in these memory areas. Just after the system is powered up, 0 V or 0 mA is output. When the initialization of the module is completed, the analog value that corresponds to the digital input value of 0 (zero) is output (for example, 1 V for the range of 1 to 5 V). At the same time, initialization completion flag (bit 15 of offset address +0) is set ON. When the system is started (when the CPU module starts running), the analog value that corresponds to the digital value input to this memory area is output. For more information of conversion characteristics, refer to "2-3 Conversion Characteristics".

* When using D300win, assign INT type variables to these registers.

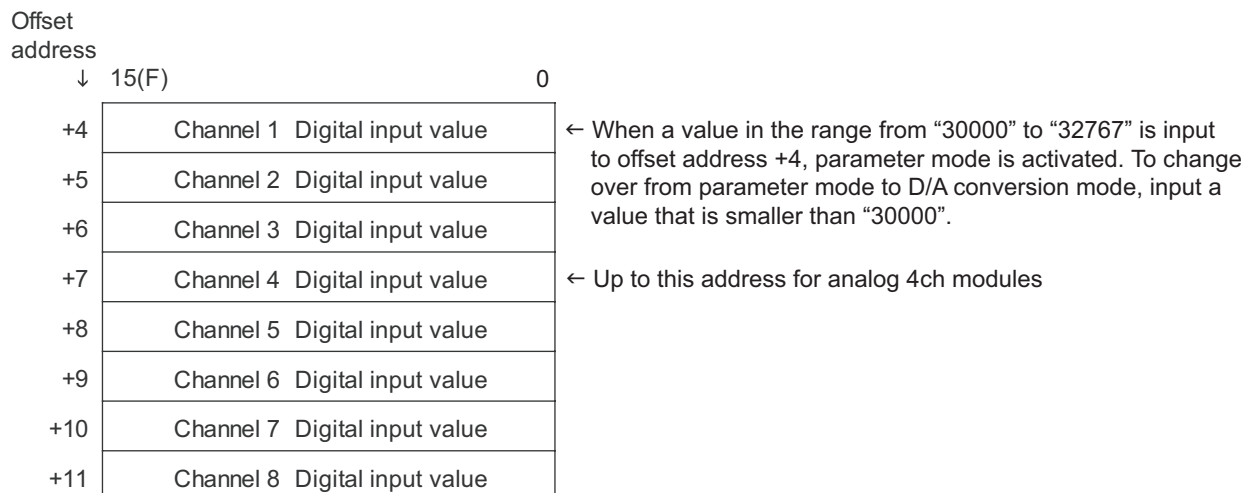

(4) Parameter type setting status register (offset address +2)

The information of which parameter is now being written or read out by this module is stored in this register.

* When using D300win, assign a WORD type variable to this register. If you access by the bit, assign a BOOL type variable to each bit.

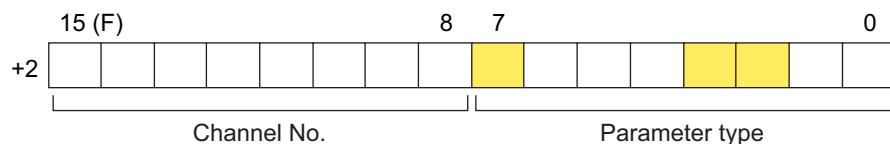

| Bit | Flag name | Description |
|-------|--------------------------------|---|
| 0 | Operation parameter read mode | ON: Operation parameter read mode (all channels in a batch) |
| 1 | Scaling parameter read mode | ON: Scaling parameter read mode (individual channel) |
| 2, 3 | Unused | |
| 4 | Operation parameter write mode | ON: Operation parameter write mode (all channels in a batch) |
| 5 | Scaling parameter write mode | ON: Scaling parameter write mode (individual channel) |
| 6 | Offset/gain adjustment mode | ON: Offset/gain adjustment mode (individual channel) |
| 7 | Unused | |
| 8 | Channel 1 | In "scaling parameter read mode", "scaling parameter write mode" or "offset/gain adjustment mode", one of bits 8 to 15 is set ON to indicate which channel is now being set or read out by this module. |
| 9 | Channel 2 | |
| 10(A) | Channel 3 | |
| 11(B) | Channel 4 | |
| 12(C) | Channel 5 | |
| 13(D) | Channel 6 | |
| 14(E) | Channel 7 | |
| 15(F) | Channel 8 | |

Section 4 Software Interface

4-2 Analog Output Module

(5) Parameter read data register (offset address +2 to +7)

In "operation parameter read mode", "scaling parameter read mode" or "offset/gain adjustment mode", the content of the setting for the corresponding mode is stored in this register.

1) When operation parameter read mode is activated

When parameter mode is activated (when bit 15 of the module status register is set ON) and bit 0 (zero) of the changeover command status register is set ON, the status of the operation parameter is stored in this memory area.

* When using D300win, assign WORD type variables to these registers. If you access by the bit, assign a BOOL type variable to each bit.

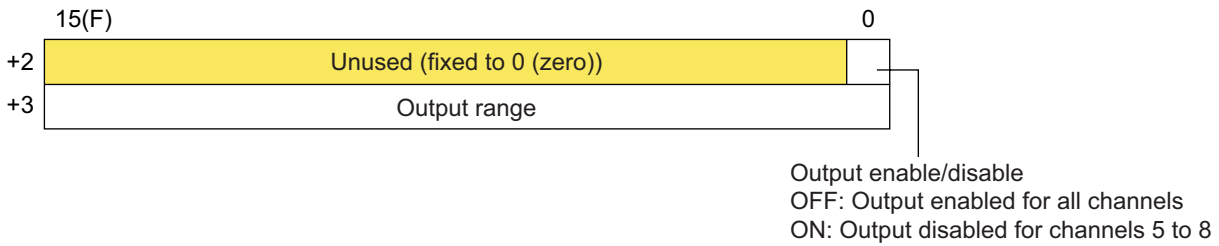

<Output range>

| Bit | Flag name | Description |
|--------|------------------------|---|
| 0 (L) | Channel 1 Output range | The set range is indicated by a combination of ON/OFF status of two bits. |
| 1 (H) | | |
| 2 (L) | Channel 2 Output range | <NP1AYH8V-MR> H L OFF OFF : 0 to 10 V |
| 3 (H) | | |
| 4 (L) | Channel 3 Output range | OFF ON : 0 to 5 V ON OFF : 1 to 5 V ON ON : -10 to 10 V |
| 5 (H) | | |
| 6 (L) | Channel 4 Output range | <NP1AYH8I-MR> H L OFF OFF : 4 to 20 mA |
| 7 (H) | | |
| 8 (L) | Channel 5 Output range | OFF ON : 0 to 20 mA ON OFF : 4 to 20 mA ON ON : 0 to 20 mA |
| 9 (H) | | |
| 10 (L) | Channel 6 Output range | |
| 11 (H) | | |
| 12 (L) | Channel 7 Output range | |
| 13 (H) | | |
| 14 (L) | Channel 8 Output range | |
| 15 (H) | | |

2) When scaling parameter read mode is activated

When parameter mode is activated (when bit 15 of the module status register is set ON) and bit 1 (one) of the parameter type setting status register is set ON, the current setting of the scaling parameter for the corresponding channel is displayed.

* When using D300win, assign INT type variables to these registers.

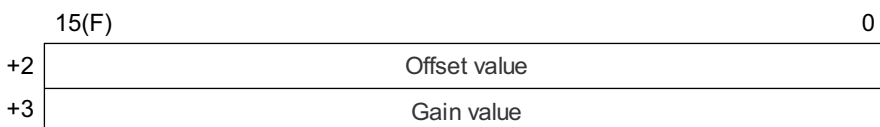

Section 4 Software Interface

4-2 Analog Output Module

3) When offset/gain adjustment mode is activated

When parameter mode is activated (when bit 15 of the module status register is set ON) and bit 6 of the parameter type setting status register is set ON, the status of offset/gain adjustment is indicated. For this, the status of EEPROM writing completion flag, voltage or current up/down status, and which of offset and gain values is now indicated are displayed. In this mode, offset address +3 is unused.

* When using D300win, assign a WORD type variable to this register. If you access by the bit, assign a BOOL type variable to each bit.

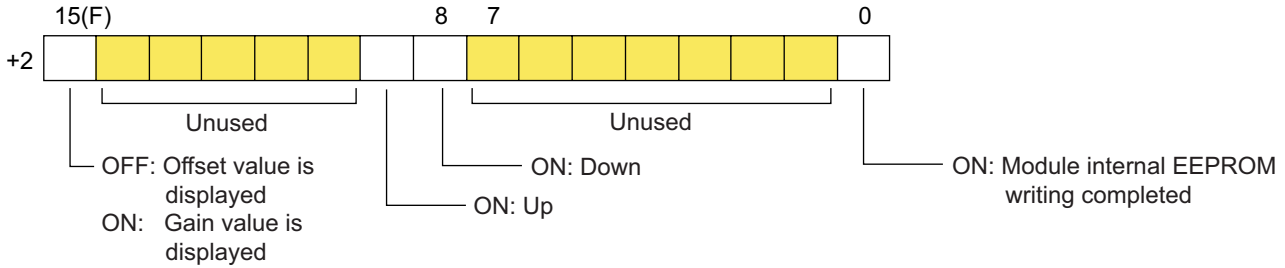

(6) Mode changeover register (offset address +4)

When a value in the range from “30000” to “32767” (INT type) is input to offset address +4, parameter mode is activated. In this mode, offset address +5 becomes the parameter type setting register, and offset addresses +6 and +7 become the parameter setting data registers.

To change over from parameter mode to D/A conversion mode, input a digital value (smaller than “30000”) that corresponds to the analog value to be output.

* When using D300win, assign an INT type variable to this register.

Note: When mode is changed over from “D/A conversion” to “parameter”, the value that corresponds to the digital input value of 0 (zero) is output as analog output value. The values shown in the table below may not apply when conversion characteristic has been changed by scaling.

| Output range | Output value in parameter mode |
|--------------|--------------------------------|
| 0 to 5 V | 0 V |
| 1 to 5 V | 1 V |
| 0 to 10 V | 0 V |
| -10 to 10V | 0 V |
| 4 to 20 mA | 4 mA |
| 0 to 20 mA | 0 mA |

Section 4 Software Interface

4-2 Analog Output Module

(7) Parameter type setting register (offset address +5)

Parameter type and channel number for reading/writing parameters are set in this register.

* When using D300win, assign a WORD type variable to this register. If you access by the bit, assign a BOOL type variable to each bit.

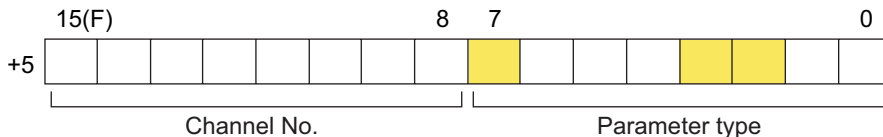

| Bit | Flag name | Description |
|------|--------------------------------|---|
| 0 | Operation parameter read mode | ON: Operation parameter read mode (all channels in a batch) |
| 1 | Scaling parameter read mode | ON: Scaling parameter read mode (individual channel) |
| 2, 3 | Unused | |
| 4 | Operation parameter write mode | ON: Operation parameter write mode (all channels in a batch) |
| 5 | Scaling parameter write mode | ON: Scaling parameter write mode (individual channel) |
| 6 | Offset/gain adjustment mode | ON: Offset/gain adjustment mode (individual channel) |
| 7 | Unused | |
| 8 | Channel 1 | In "scaling parameter read mode", "scaling parameter write mode" or "offset/gain adjustment mode", arbitrary channel is specified. In "scaling parameter read mode", one of bits 8 to 15 is set ON to indicate for which channel to set parameters. When same data is to be set in "scaling parameter write mode" or "offset/gain adjustment mode", multiple arbitrary channels may be specified. |
| 9 | Channel 2 | |
| 10 | Channel 3 | |
| 11 | Channel 4 | |
| 12 | Channel 5 | |
| 13 | Channel 6 | |
| 14 | Channel 7 | |
| 15 | Channel 8 | |

Section 4 Software Interface

4-2 Analog Output Module

(8) Parameter setting data register (offset address +6, +7)

When a value in the range from “30000” to “32767” (INT type) is input to the mode changeover register (offset address +4), bit 15 of the module status register (offset address +0) is set ON, and “parameter mode” is activated.

The set values of “operation parameter write” mode, “scaling parameter” mode or “offset/gain adjustment” mode are written in this register.

1) When operation parameter write mode is activated

Data is set in the locations shown below, and “operation parameter write mode flag” (bit 4 of the parameter type setting register) is set ON.

* When using D300win, assign WORD type variables to these registers. If you access by the bit, assign a BOOL type variable to each bit.

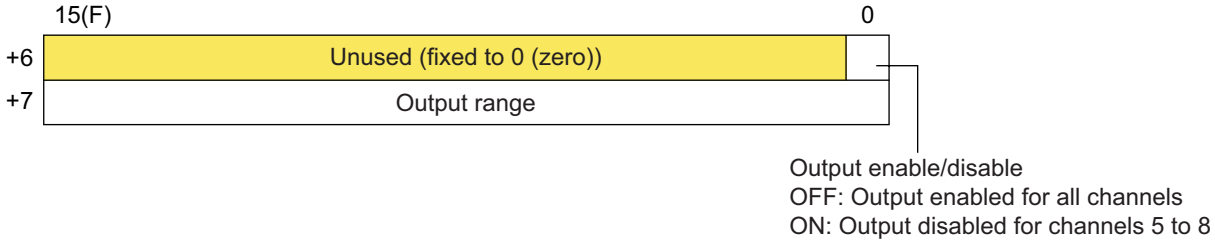

<Output range>

| Bit | Flag name | Description |
|--------|------------------------|---|
| 0 (L) | Channel 1 Output range | Output range is set by a combination of ON/OFF status of two bits. |
| 1 (H) | | |
| 2 (L) | Channel 2 Output range | <NP1AYH8V-MR> H L OFF OFF : 0 to 10 V OFF ON : 0 to 5 V |
| 3 (H) | | |
| 4 (L) | Channel 3 Output range | ON OFF : 1 to 5 V ON ON : -10 to 10 V |
| 5 (H) | | |
| 6 (L) | Channel 4 Output range | <NP1AYH8I-MR> H L OFF OFF : 4 to 20 mA OFF ON : 0 to 20 mA |
| 7 (H) | | |
| 8 (L) | Channel 5 Output range | ON OFF : 4 to 20 mA ON ON : 0 to 20 mA |
| 9 (H) | | |
| 10 (L) | Channel 6 Output range | |
| 11 (H) | | |
| 12 (L) | Channel 7 Output range | |
| 13 (H) | | |
| 14 (L) | Channel 8 Output range | |
| 15 (H) | | |

2) When scaling parameter setting mode is activated

For scaling, offset and gain values are set in the locations shown below.

* When using D300win, assign INT type variables to these registers.

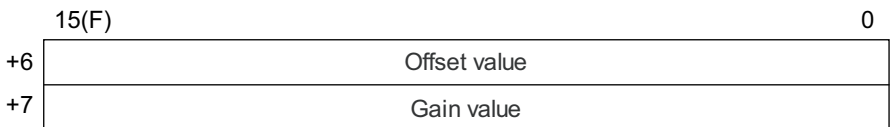

<Scaling>

The analog output modules convert the digital values that are input to them by application program into analog values. The operation to change the width (scale) of input digital values is referred to as “scaling”. The available range of scaling of these modules is -25000 to 25000 (INT type). If a value that is out of this range is set, it will be limited to -25000 or 25000.

Section 4 Software Interface

4-2 Analog Output Module

<Initial value of scaling for each output range>

| Output range | Initial value of scaling | Available range of scaling (See note.) |
|--------------|--------------------------|--|
| 0 to 5 V | 0 to 16000 | 0 to 25000 |
| 1 to 5 V | 0 to 16000 | 0 to 25000 |
| 0 to 10 V | 0 to 16000 | 0 to 25000 |
| -10 to 10 V | -8000 to 8000 | -25000 to 25000 |
| 4 to 20 mA | 0 to 16000 | 0 to 25000 |
| 0 to 20 mA | 0 to 16000 | 0 to 25000 |

Note 1: Scaling is enabled only when the operation setting switch on the module rear panel is set to "Soft Set Range Operation mode". In fixed range operation mode, scaling is disabled.

Note 2: Over range is fixed to " $(\text{Gain value} - \text{Offset value}) \times 0.025 + \text{Gain value}$ ".

" $(\text{Gain value} - \text{Offset value}) \times 0.0125 + \text{Gain value}$ " for the range of -10 to +10 V

On the other hand, under range is fixed to " $\text{Offset value} - (\text{Gain value} - \text{Offset value}) \times 0.025$ ".

" $\text{Offset value} - (\text{Gain value} - \text{Offset value}) \times 0.0125$ " for the range of -10 to +10 V

Note 3: If scaling results in "resolution < maximum resolution", digital output value does not change in steps of one.

Note 4: Once scaling values are set, they won't change even when range is changed.

<Example 1 of scaling>

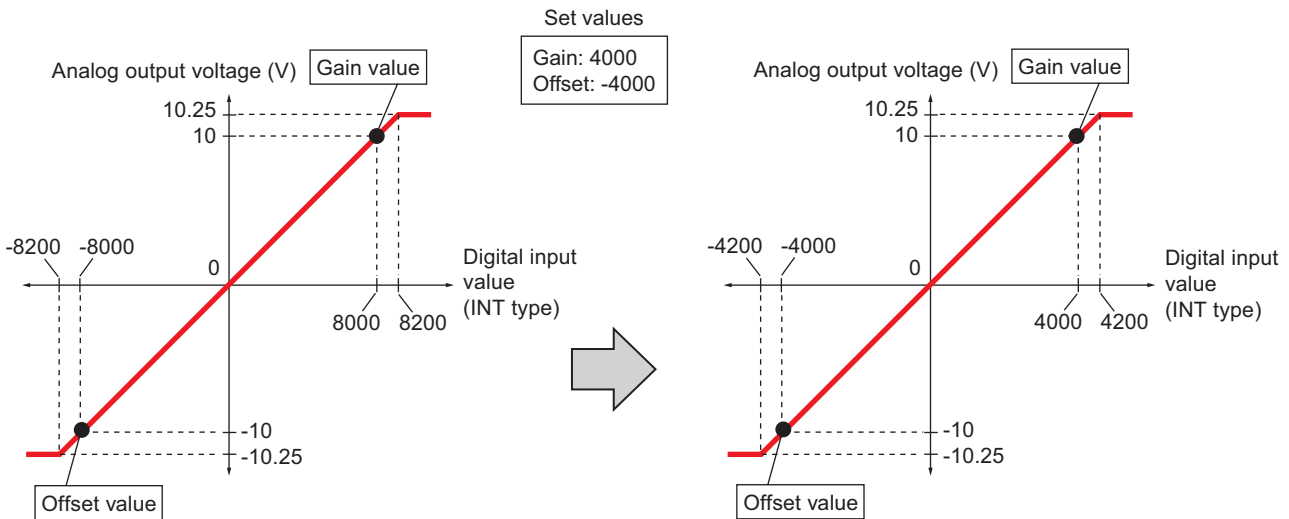

<Example 2 of scaling>

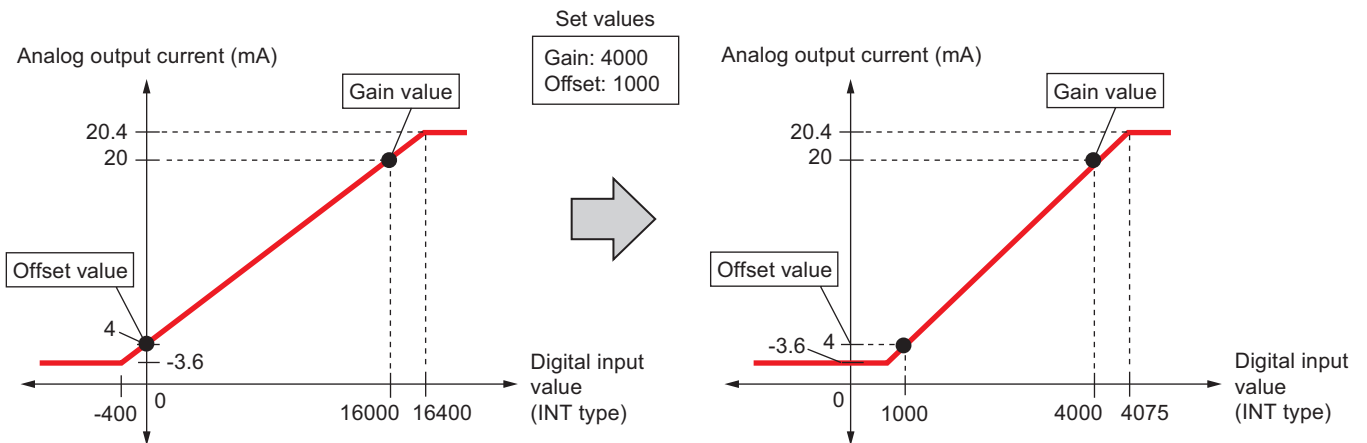

Section 4 Software Interface

4-2 Analog Output Module

<Procedure for scaling>

- 1) Input "30000" (INT type) to the mode changeover register (offset address +4) to activate parameter mode. (Make sure that bit 15 of the module status register is set ON.)
- 2) Input gain and offset values to the parameter setting data register, and set ON bit 5 and bit 8 (in the case of channel 1) of the parameter type setting register. (In the above example 1 of scaling, set as follows.)

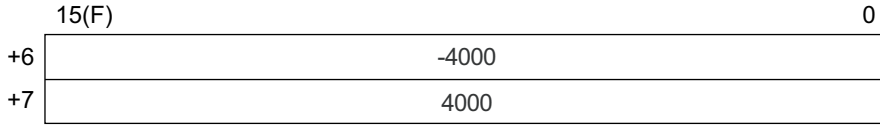

- 3) Make sure that bit 5 (scaling parameter write mode) and bit 8 (channel 1) of the parameter type setting register are set ON.
- 4) Set OFF all the bits of the parameter setting data register, and clear all the bits of the parameter setting data register to zero. This completes the operation for scaling.

3) When offset/gain adjustment mode is activated

For offset/gain adjustment, data is set in the locations shown below:

* When using D300win, assign a WORD type variable to this register. If you access by the bit, assign a BOOL type variable to each bit.

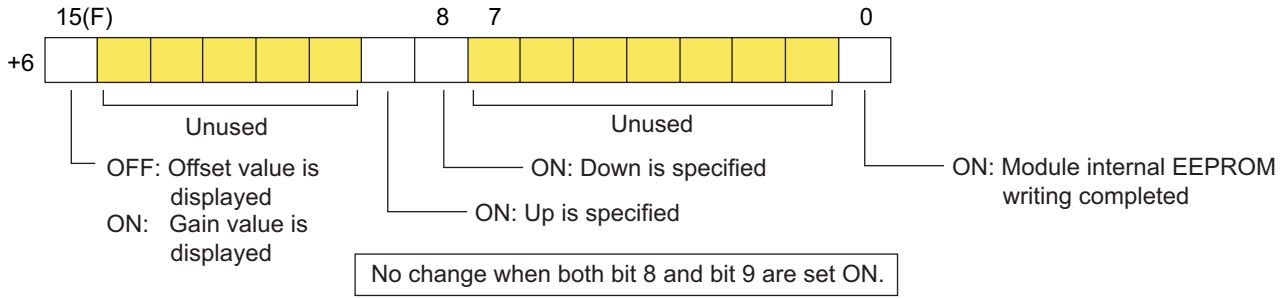

<Offset/gain adjustment>

In this mode, offset value and/or gain value can finely be adjusted for individual channel.

- Offset value: Means the lower limit value of the range span. When this value is adjusted, the conversion characteristic curve moves parallel in vertical direction.
- Gain value: Means the upper limit value of the range span. When this value is adjusted, only gain value is changed while offset value is kept unchanged.

When offset and gain values are changed by scaling, the values that are set by scaling take effect as offset and gain values. When offset and/or gain values are to be adjusted after scaling, adjust by the values of scaling.

Note 1: Offset/gain adjustable range is within $\pm 1\%$ of range span. It takes approximately 2 minutes to adjust from 0% to $\pm 1\%$. If adjustment is made using an analog value that exceeds the adjustable range (if the value is input to a terminal of the module), the value is limited to $\pm 1\%$ of range span.

Note 2: If range is changed, offset and gain return to the default values.

Note 3: Negative current value cannot be output. If offset value is set too low, the conversion characteristic curve becomes as follows:

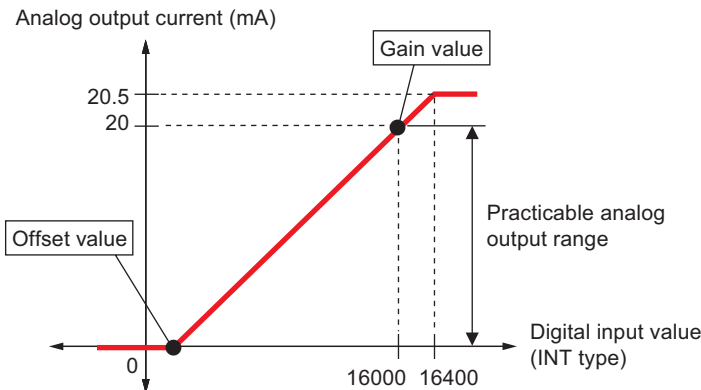

Section 4 Software Interface

4-2 Analog Output Module

Offset and gain values for the range of -10 to 10 V.

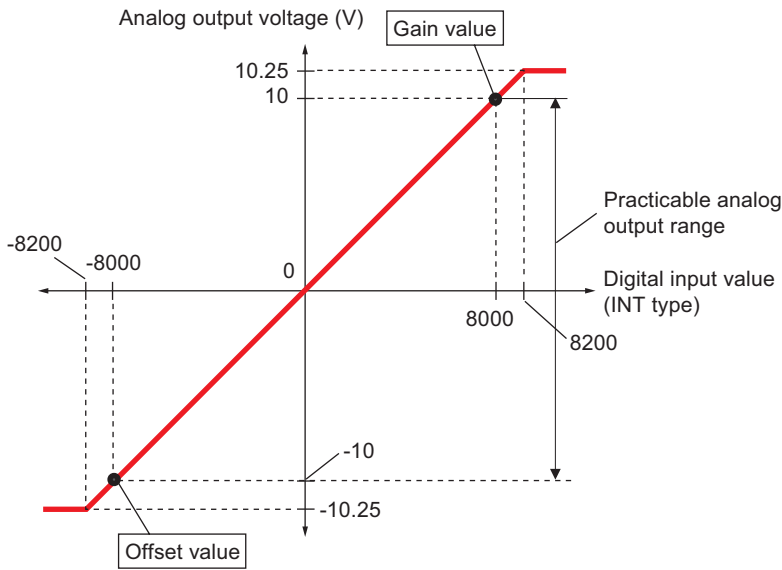

<Offset/gain adjustment procedure>

Offset is adjusted first.

- 1) Input "30000" (INT type) to the mode changeover register (offset address +4) to activate parameter mode. (Make sure that bit 15 of the module status register is set ON.)
- 2) Set ON bit 6 of the parameter type setting register to activate offset/gain adjustment mode. (Make sure that bit 15 of the module status register is set ON.)
- 3) Set ON the bit for the channel to be adjusted (the corresponding bit of bits 8 to 15 of the parameter type setting register). (The "SETTING" LED of the module blinks.)
- 4) With an external device, etc. connected to the terminal of the channel that is to be adjusted, observe the output voltage or current value.
- 5) First, in the condition that bit 15 of the parameter setting data register (offset address +6) is set OFF, adjust output value by setting ON and OFF bit 8 (output value Down) and bit 9 (output value Up).
- 6) After the completion of offset adjustment, set ON bit 0 (zero) of the parameter setting data register (offset address +6) to write the offset adjustment value in the module internal EEPROM. When bit 0 (zero) of offset address +2 is set ON, the writing of EEPROM is completed. After confirming this, set OFF bit 0 (zero) of the parameter setting data register.
- 7) Then set bit 15 ON of the parameter setting data register (offset address +6) and, in the same way as offset adjustment, adjust output value by setting ON and OFF bit 8 (output value Down) and bit 9 (output value Up). (Gain adjustment)
- 8) After the completion of gain adjustment, set ON bit 0 (zero) of the parameter setting data register (offset address +6) to write the gain adjustment value in the module internal EEPROM. Confirm the completion of EEPROM writing, in the same way as explained for offset adjustment.
- 9) Set OFF all the bits of the parameter type setting register, and clear all the bits of the parameter setting data register to zero. This completes the adjustment work.

[Reference]

For concrete operating method with the SX Control Utility of D300win, refer to "Appendix 1 Offset/Gain Adjustment <D300win>". For concrete operating method with SX-Programmer Standard, refer to "Appendix 2 Offset/Gain Adjustment <SX-Programmer Standard>".

Section 4 Software Interface

4-3 Analog Input/Output Module

NP1AWH6-MR occupies 8 words of I/O area (input: 4 words, output: 4 words).

4-3-1 Memory allocation in Switch Batch Setting mode

| Offset address | Value | Direction |
|----------------|---|---------------------------|
| ↓ 15(F) | 0 | |
| +0 | Channel 1 Digital output value / Status | This module to CPU module |
| +1 | Channel 2 Digital output value / Status | |
| +2 | Channel 3 Digital output value / Status | |
| +3 | Channel 4 Digital output value / Status | |
| +4 | Channel 5 Digital input value | CPU module to this module |
| +5 | Channel 6 Digital input value | |
| +6 | Unused (fixed to 0 (zero)) | |
| +7 | Unused (fixed to 0 (zero)) | |

| Status code | Error | Description |
|------------------|--|--|
| 30002 (7532h) | EEPROM calibration data error (Module fatal fault) | If the calibration data of EEPROM is destroyed or if EEPROM cannot be written or read, this error is notified. Module internal EEPROM is abnormal. If this error occurred, it is necessary to replace the module. |
| 30003 (7533h) | EEPROM user setting data error | If the user setting data of EEPROM is destroyed, this error is notified. If this error occurred, all parameters need to be reset. If this error recurs even after parameters are reset, the module seems to have failed. |
| 30004 (7534h) | Internal power supply down | If the internal power supply of the module becomes down, this error is notified. |
| 30006 (7536h) | Conversion error | If conversion became abnormal because the module failed or was used in an out-of-spec environment, this error is notified. |



Ordinarily digital output values (INT type) are stored in the registers explained above. If the module becomes abnormal, the following status code (INT type) is stored in these registers. When making an application program, be sure to interlock erroneous and normal (A/D conversion) conditions.

Section 4 Software Interface

4-3 Analog Input/Output Module

4-3-2 Memory allocation in Software Set Range Operation mode

In Software Set Range Operation mode, memory allocation differs between when operating in A/D conversion mode (during normal operation) and when operating in parameter mode.

<When operating in conversion mode>

When operating in conversion mode, memory allocation becomes as follows:

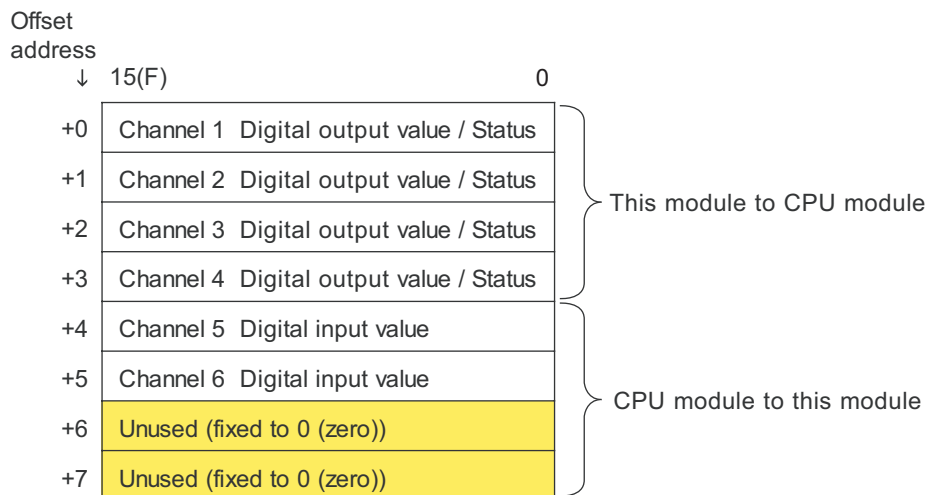

<When operating in parameter mode>

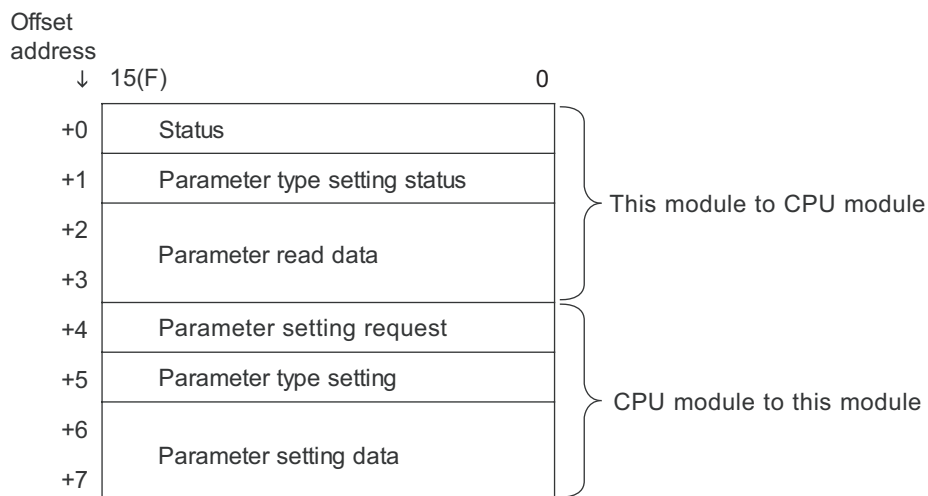

Section 4 Software Interface

4-3 Analog Input/Output Module

(1) Digital output value/status register (offset address: +0 to +3)

When this module is in conversion mode, digital output values and/or statuses are stored, in the registers of offset address +0 to +3.

* When using D300win, assign INT type variables to these registers.

| | | |
|----------------|---|---|
| Offset address | ↓ 15(F) | 0 |
| +0 | Channel 1 Digital output value / Status | |
| +1 | Channel 2 Digital output value / Status | |
| +2 | Channel 3 Digital output value / Status | |
| +3 | Channel 4 Digital output value / Status | |

| Status code | Condition of modul | Description |
|------------------|---|--|
| 30002 (7532h) | EEPROM calibration data error (Module fatal fault) | If the calibration data of EEPROM is destroyed or if EEPROM cannot be written or read, this error is notified. Module internal EEPROM is abnormal. If this error occurred, it is necessary to replace the module. |
| 30003 (7533h) | EEPROM user setting data error | If the user setting data of EEPROM is destroyed, this error is notified. If this error occurred, all parameters need to be reset. If this error recurs even after parameters are reset, the module seems to have failed. |
| 30004 (7534h) | Internal power supply down | If the internal power supply of the module becomes down, this error is notified. |
| 30006 (7536h) | Conversion error | If conversion became abnormal because the module failed or was used in an out-of-spec environment, this error is notified. |



Ordinarily digital output values (INT type) are stored in the registers explained above. If the module becomes abnormal, the following status code (INT type) is stored in these registers. When making an application program, be sure to interlock erroneous and normal (A/D conversion) conditions.

(2) Digital input values of channels 5 and 6 (offset address +4 and +5)

The digital values to undergo D/A conversion are stored in these memory areas. Just after the system is powered up, 0 V or 0 mA is output. When the initialization of the module is completed, the analog value that corresponds to the digital input value of 0 (zero) is output (for example, 1 V for the range of 1 to 5 V).

When the system is started (when the CPU module starts running), the analog value that corresponds to the digital value input to this memory area is output. For more information of conversion characteristics, refer to "2-3 Conversion Characteristics".

* When using D300win, assign INT type variables to these registers.

| | | |
|----------------|-------------------------------|---|
| Offset address | ↓ 15(F) | 0 |
| +4 | Channel 5 Digital input value | |
| +5 | Channel 6 Digital input value | |

(3) Status register (offset address +0)

When parameters are being set or read out, "30001" is output by the module.

Section 4 Software Interface

4-3 Analog Input/Output Module

(4) Parameter type setting status register (offset address +1)

This register stores the information of what parameter is now being written or read by the module.

* When using D300win, assign a WORD type variable to this register. If you access by the bit, assign a BOOL type variable to each bit.

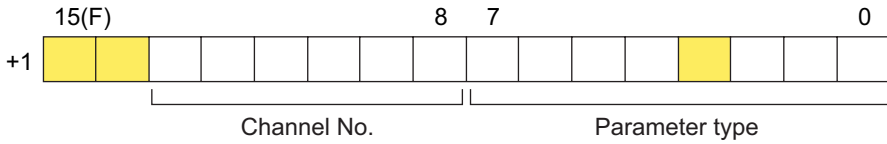

| Bit | Flag name | Description |
|-----|--------------------------------------|---|
| 0 | Operation parameter read mode | ON: Operation parameter read mode (all channels in a batch) |
| 1 | Scaling parameter read mode | ON: Scaling parameter read mode (individual channel) |
| 2 | Operation range parameter read mode | ON: Operation range parameter read mode (all channels in a batch) |
| 3 | Unused | |
| 4 | Operation parameter write mode | ON: Operation parameter write mode (all channels in a batch) |
| 5 | Scaling parameter write mode | ON: Scaling parameter write mode (individual channel) |
| 6 | Operation range parameter write mode | ON: Operation range parameter write mode (all channels in a batch) |
| 7 | Offset/gain adjustment mode | ON: Offset/gain adjustment mode (individual channel) |
| 8 | Channel 1 | In "scaling parameter read mode" or "scaling parameter write mode", one of bits 8 to 15 is set ON to indicate which channel is now being set or read out. |
| 9 | Channel 2 | |
| 10 | Channel 3 | |
| 11 | Channel 4 | |
| 12 | Channel 5 | |
| 13 | Channel 6 | |
| 14 | Unused | |
| 15 | Unused | |

(5) Parameter read data register (offset address +2 and +3)

In "operation parameter read mode", "scaling parameter read mode", "operation range parameter read mode" or "offset/gain adjustment mode", the content of the setting for the corresponding mode is stored in this register.

1) When operation parameter read mode is activated

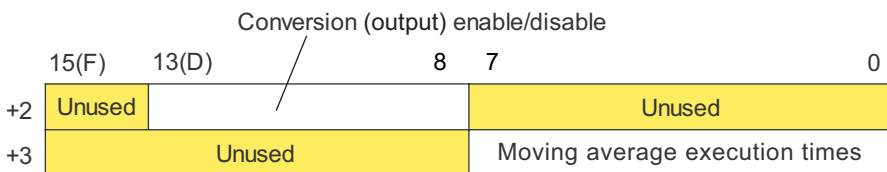

Conversion (output) enable/disable OFF: (Output) enable, ON: (Output) disable

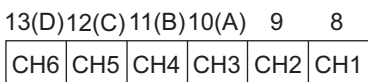

Moving average execution times H/L = OFF/OFF: Once, OFF/ON: Twice, ON/OFF: 4 times, ON/ON: 8 times

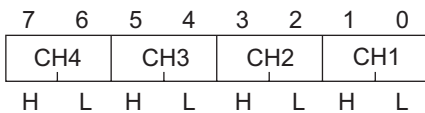

* When using D300win, assign WORD type variables to these registers. If you access by the bit, assign a BOOL type variable to each bit.

Section 4 Software Interface

4-3 Analog Input/Output Module

2) When scaling parameter read mode is activated

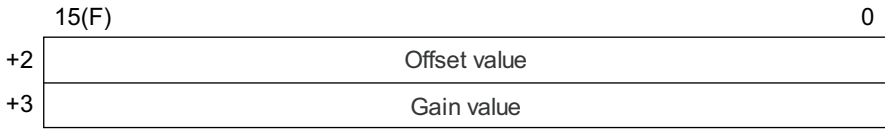

* When using D300win, assign INT type variables to these registers.

3) When operation range parameter read mode is activated

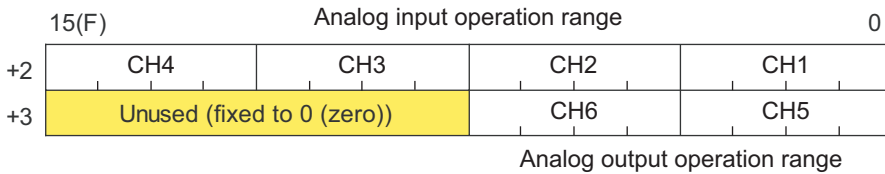

- OFF/OFF/OFF/OFF : 0 to 10 V
- OFF/OFF/OFF/ON : 0 to 5 V
- OFF/OFF/ON/OFF : 1 to 5 V
- OFF/OFF/ON/ON : -10 to 10 V
- OFF/ON/OFF/OFF : 4 to 20 mA
- OFF/ON/OFF/ON : 0 to 20 mA
- OFF/ON/ON/ON : -20 to 20 mA
- Others : 0 to 10 V

4) When offset/gain adjustment mode is activated

* When using D300win, assign a WORD type variable to this register (offset address +2). If you access by the bit, assign a BOOL type variable to each bit.

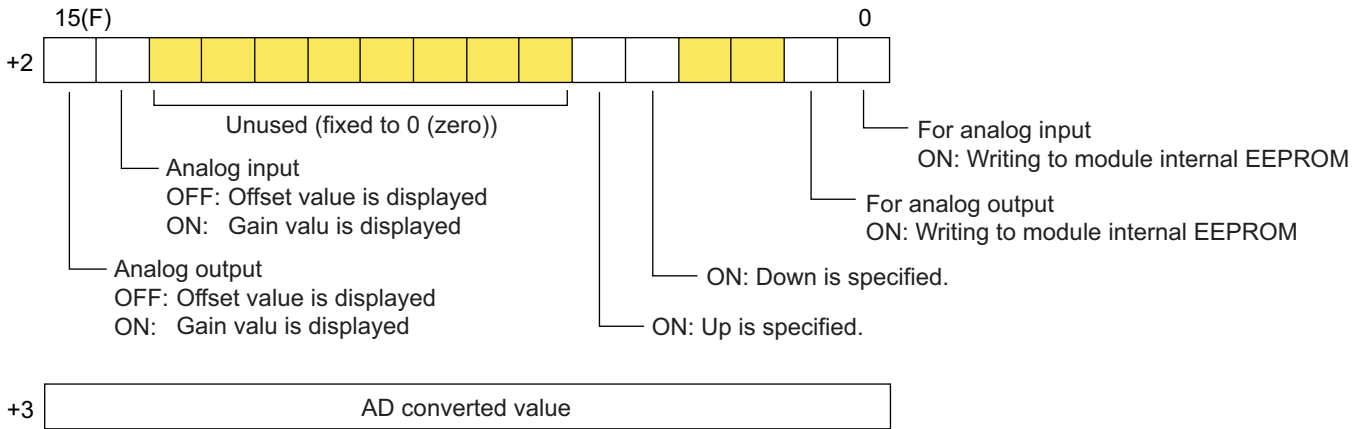

AD converted value (INT type)
(A converted value of a channel specified by the offset address +6 can be monitored.)

* When using D300win, assign an INT type variable to this register.

Section 4 Software Interface

4-3 Analog Input/Output Module

(6) Parameter setting request (offset address +4)

When a value in the range from “30000” to “32767” is input to the parameter setting request register (offset address +4), the status register (offset address +0) becomes “30001”, and “parameter” mode is activated. Make sure that the status register (offset address +0) is “30001” and then set parameters.

If a value that is smaller than “30000” is input to this register, the mode is changed over from “parameter” mode to “conversion mode (normal mode)”.

(7) Parameter type setting register (offset address +5)

Parameter type and channel number for reading/writing parameters are set in this register.

* When using D300win, assign a WORD type variable to this register. If you access by the bit, assign a BOOL type variable to each bit.

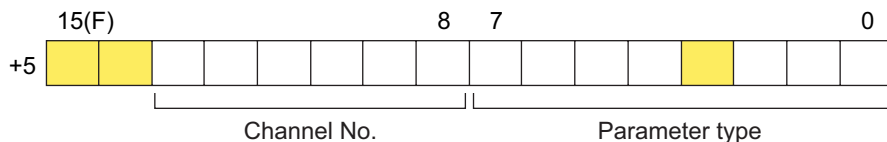

| Bit | Flag name | Description |
|-----|--------------------------------------|---|
| 0 | Operation parameter read mode | ON: Operation parameter read mode (all channels in a batch) |
| 1 | Scaling parameter read mode | ON: Scaling parameter read mode (individual channel) |
| 2 | Operation range parameter read mode | ON: Operation range parameter read mode (all channels in a batch) |
| 3 | Unused | |
| 4 | Operation parameter write mode | ON: Operation parameter write mode (all channels in a batch) |
| 5 | Scaling parameter write mode | ON: Scaling parameter write mode (individual channel) |
| 6 | Operation range parameter write mode | ON: Operation range parameter write mode (all channels in a batch) |
| 7 | Offset/gain adjustment mode | ON: Offset/gain adjustment mode (individual channel) |
| 8 | Channel 1 | In "scaling parameter read mode", "scaling parameter write mode" or "offset/gain adjustment mode", one of bits 8 to 15 is set ON to specify a channel for which parameters are to be set. |
| 9 | Channel 2 | |
| 10 | Channel 3 | |
| 11 | Channel 4 | |
| 12 | Channel 5 | |
| 13 | Channel 6 | |
| 14 | Unused | |
| 15 | Unused | |

Section 4 Software Interface

4-3 Analog Input/Output Module

(8) Parameter setting data register (offset address +6 and +7)

When “parameter” mode is activated, the set values of “operation parameter write” mode, “scaling parameter” mode “operation range parameter” mode or “offset/gain adjustment” mode are written in this register.

1) When operation parameter write mode is activated

Data is set in the locations shown below, and “operation parameter write mode flag” (bit 4 of the parameter type setting register) is set ON.

* When using D300win, assign WORD type variables to these registers. If you access by the bit, assign a BOOL type variable to each bit.

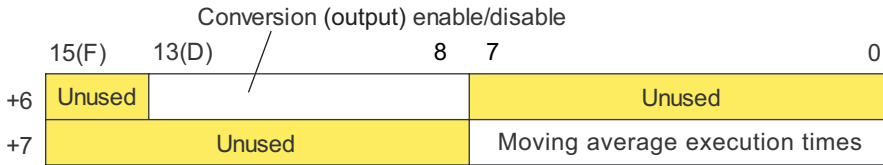

Conversion (output) enable/disable OFF: (Output) enable, ON: (Output) disable

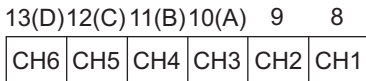

Moving average execution times H/L = OFF/OFF: Once, OFF/ON: Twice, ON/OFF: 4 times, ON/ON: 8 times

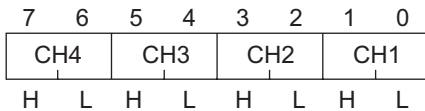

2) When scaling parameter write mode is activated

For scaling, offset and gain values are set in the locations shown below, and “scaling parameter write mode flag” (bit 5 of the parameter type setting register) is set ON.

* When using D300win, assign INT type variables to these registers.

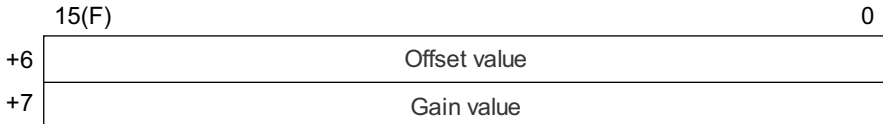

| Input range | Initial value of scaling | Scaling range |
|--------------|--------------------------|-----------------|
| 0 to 5 V | 0 to 16000 | 0 to 25000 |
| 1 to 5 V | 0 to 16000 | 0 to 25000 |
| 0 to 10 V | 0 to 16000 | 0 to 25000 |
| -10 to 10 V | -8000 to 8000 | -25000 to 25000 |
| 4 to 20 mA | 0 to 16000 | 0 to 25000 |
| 0 to 20 mA | 0 to 16000 | 0 to 25000 |
| -20 to 20 mA | -8000 to 8000 | -25000 to 25000 |

Note 1: Scaling is enabled only when the operation setting switch on the module rear panel is set to “Soft Set Range Operation mode”. In fixed range operation mode, scaling is disabled.

Note 2: Over range is fixed to “(Gain value - Offset value) x 0.025 + Gain value”.
 (“(Gain value - Offset value) x 0.0125 + Gain value” for the range of -10 to +10 V or of -20 to +20 mA)
 On the other hand, under range is fixed to “Offset value - (Gain value - Offset value) x 0.025”.
 (“Offset value - (Gain value - Offset value) x 0.0125” for the range of -10 to +10 V or of -20 to +20 mA)

Note 3: If scaling results in “resolution < maximum resolution”, digital output value does not change in steps of one.

Note 4: Once scaling values are set, they won't change even when range is changed in Soft Set Range Operation mode.

Section 4 Software Interface

4-3 Analog Input/Output Module

<Example of scaling>

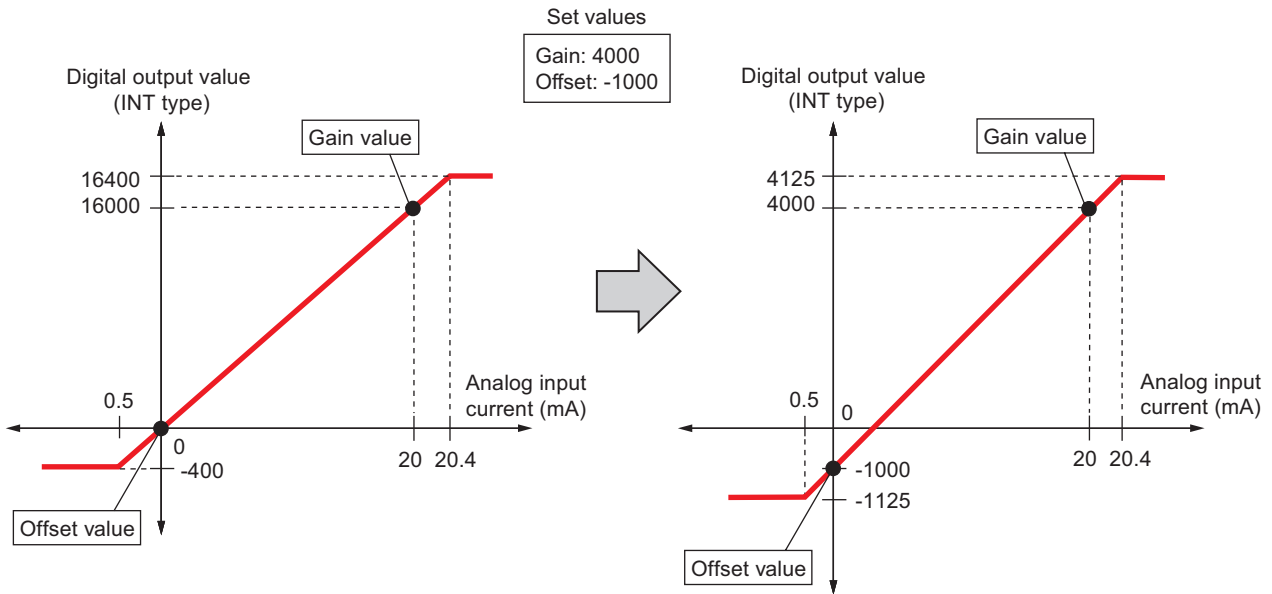

<Procedure for scaling>

- 1) Input "30000" to the parameter setting request register to activate parameter mode. (Make sure that the status register is "30001".)
- 2) Input gain and offset values to the parameter setting data register, and set ON bit 5 and bit 8 (in the case of channel 1) of the parameter type setting register. (In the above example of scaling, set as follows.)

| | | |
|----|-------|---|
| | 15(F) | 0 |
| +6 | -1000 | |
| +7 | 4000 | |

- 3) Make sure that bit 5 (scaling parameter write mode) and bit 8 (channel 1) of the parameter type setting register are set ON.
- 4) Set OFF all the bits of the parameter type setting register, and clear all the bits of the parameter setting data register to zero. This completes the operation for adjustment.

<Scaling for analog output>

The analog output converts the digital values that are input to them by application program into analog values. The operation to change the width (scale) of input digital values is referred to as "scaling". The available range of scaling of these modules is -25000 to 25000 (INT type). If a value that is out of this range is set, it will be limited to -25000 or 25000.

<Initial value of scaling for each output range>

| Output range | Initial value of scaling | Available range of scaling (See note.) |
|--------------|--------------------------|--|
| 0 to 5 V | 0 to 16000 | 0 to 25000 |
| 1 to 5 V | 0 to 16000 | 0 to 25000 |
| 0 to 10 V | 0 to 16000 | 0 to 25000 |
| -10 to 10 V | -8000 to 8000 | -25000 to 25000 |
| 4 to 20 mA | 0 to 16000 | 0 to 25000 |
| 0 to 20 mA | 0 to 16000 | 0 to 25000 |

Section 4 Software Interface

4-3 Analog Input/Output Module

Note 1: Scaling is enabled only when the operation setting switch on the module rear panel is set to “Soft Set Range Operation mode”. In fixed range operation mode, scaling is disabled.

Note 2: Over range is fixed to “(Gain value - Offset value) x 0.025 + Gain value”.

“(Gain value - Offset value) x 0.0125 + Gain value” for the range of -10 to +10 V

On the other hand, under range is fixed to “Offset value - (Gain value - Offset value) x 0.025”.

“(Offset value - (Gain value - Offset value) x 0.0125)” for the range of -10 to +10 V

Note 3: If scaling results in “resolution < maximum resolution”, digital output value does not change in steps of one.

Note 4: Once scaling values are set, they won't change even when range is changed.

<Example 1 of scaling>

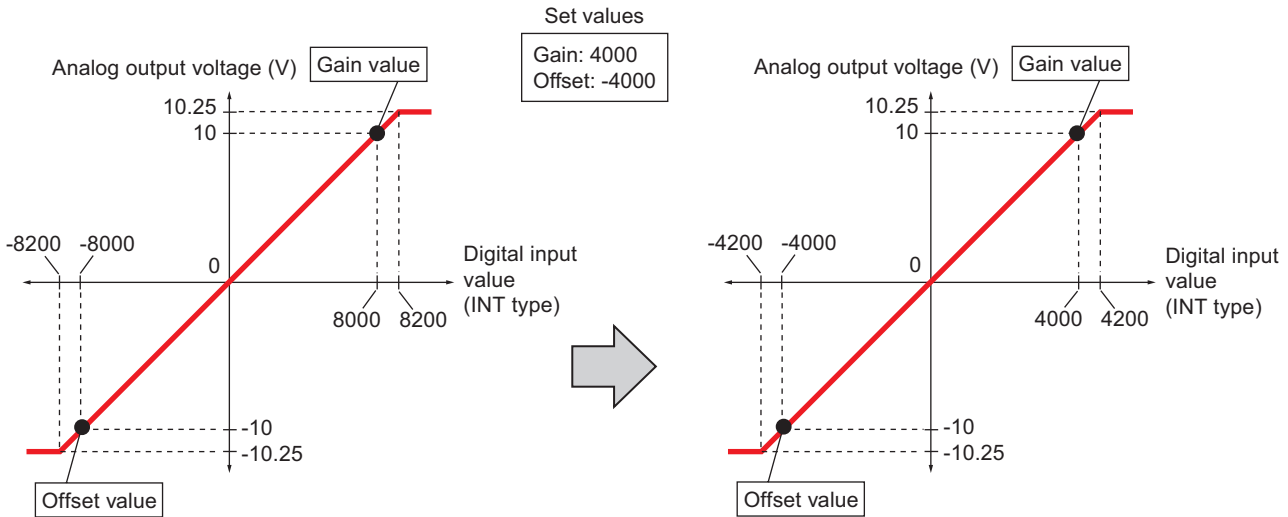

<Example 2 of scaling>

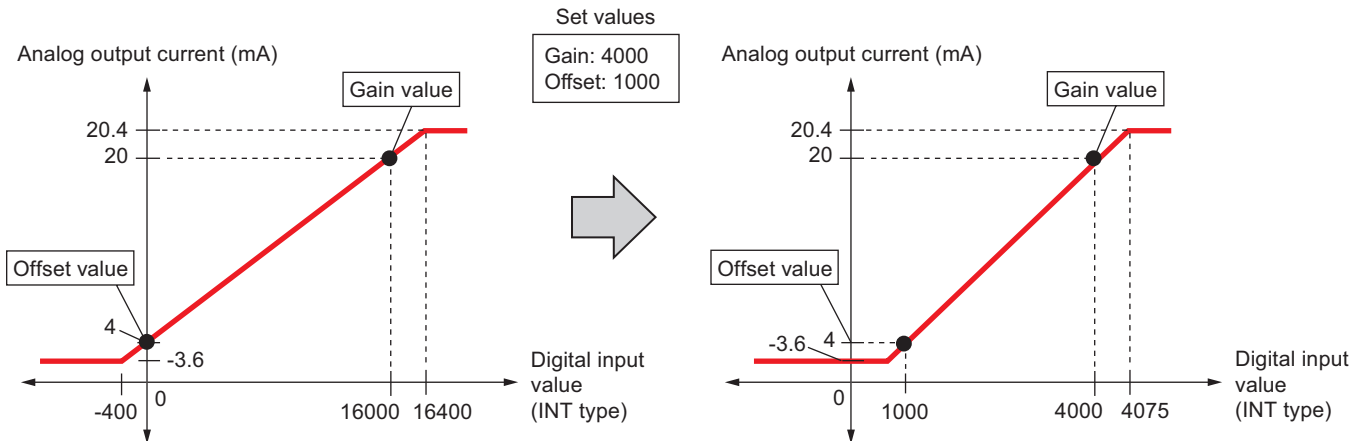

<Procedure for scaling>

- 1) Input “30000” to the parameter setting request register (offset address +4) to activate parameter mode. (Make sure that the status register is “30001”.)
- 2) Input gain and offset values to the parameter setting data register, and set ON bit 5 and bit 12 (in the case of channel 5) of the parameter type setting register. (In the above example 1 of scaling, set as follows.)

| | |
|-------|-------|
| 15(F) | 0 |
| +6 | -4000 |
| +7 | 4000 |

- 3) Make sure that bit 5 (scaling parameter write mode) and bit 12 (channel 5) of the parameter type setting register are set ON.
- 4) Set OFF all the bits of the parameter setting data register, and clear all the bits of the parameter setting data register to zero. This completes the operation for scaling.

Section 4 Software Interface

4-3 Analog Input/Output Module

3) When operation range parameter write mode is activated

For offset/gain adjustment, data is set in the locations shown below:

* When using D300win, assign INT type variables to these registers.

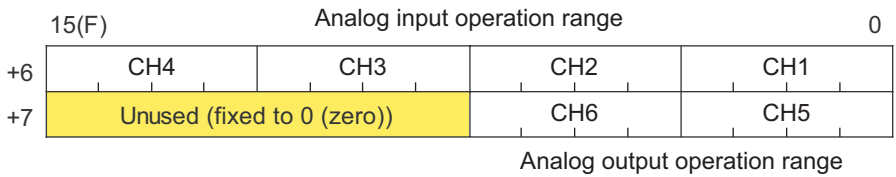

- OFF/OFF/OFF/OFF : 0 to 10 V
- OFF/OFF/OFF/ON : 0 to 5 V
- OFF/OFF/ON/OFF : 1 to 5 V
- OFF/OFF/ON/ON : -10 to 10 V
- OFF/ON/OFF/OFF : 4 to 20 mA
- OFF/ON/OFF/ON : 0 to 20 mA
- OFF/ON/ON/ON : -20 to 20 mA
- Others : 0 to 10 V

4) When offset/gain adjustment mode is activated

For offset/gain adjustment, data is set in the locations shown below:

* When using D300win, assign INT type variables to these registers.

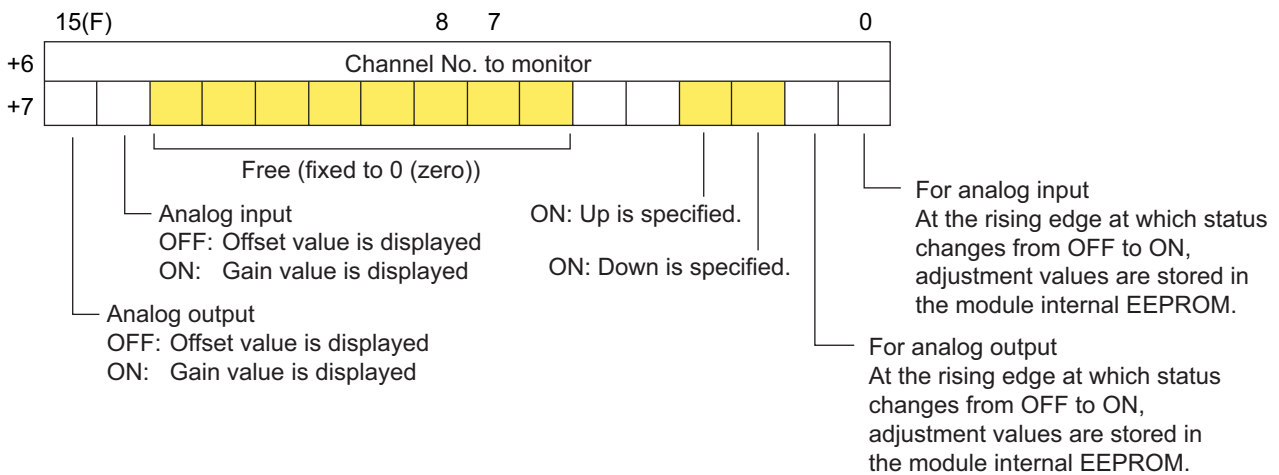

<Analog input Offset/gain adjustment>

In this mode, offset value and/or gain value can finely be adjusted for individual channel.

- Offset value: Means the lower limit value of the range span. When this value is adjusted, the conversion characteristic curve moves parallel in vertical direction.
- Gain value: Means the upper limit value of the range span. When this value is adjusted, only gain value is changed while offset value is kept unchanged.

When offset and gain values are changed by scaling, the values that are set by scaling take effect as offset and gain values. When offset and/or gain values are to be adjusted after scaling, adjust by the values of scaling.

Note 1: Offset/gain adjustable range is within $\pm 1\%$ of range span. If adjustment is made using an analog value that exceeds the adjustable range (if the value is input to a terminal of the module), the value is limited to $\pm 1\%$ of range span.

Note 2: If range is changed, offset and gain return to the default values.

Note 3: Offset/gain adjustment is disabled when analog range is set in a batch with the switch provided on the module rear panel.

Section 4 Software Interface

4-3 Analog Input/Output Module

<Example 1 of gain/offset adjustment>

Offset and gain values for the range of 0 to 5 V.

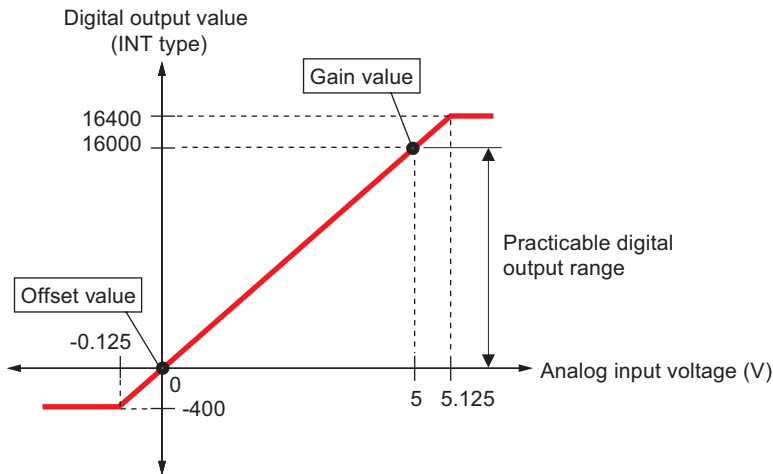

<Example 2 of gain/offset adjustment>

Offset and gain values for the range of -10 to 10 V.

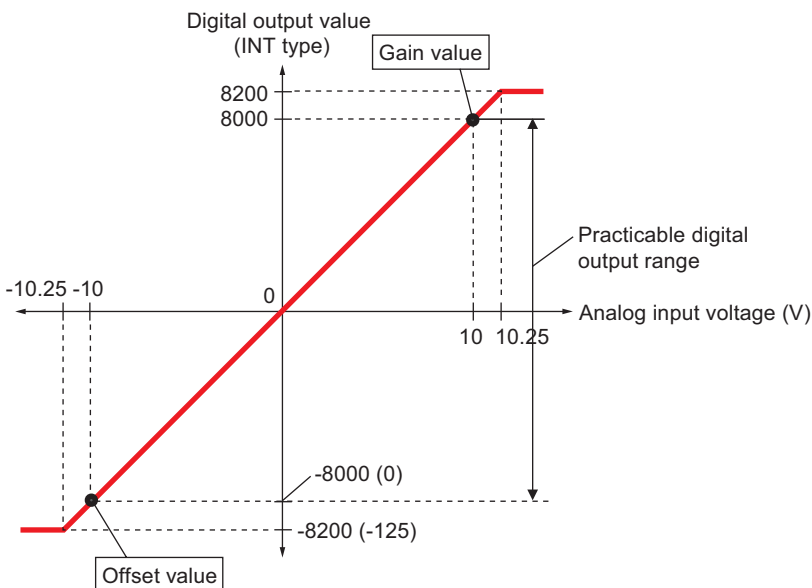

<Offset/gain adjustment procedure>

Offset is adjusted first.

- 1) Input "30000" to the the parameter setting request register to activate parameter mode. (Make sure that the status register is "30001".)
- 2) Set ON bit 7 of the parameter type setting register to activate offset/gain adjustment mode.
- 3) Set ON the bit for the channel to be adjusted (the corresponding bit of bits 8 to 15 of the parameter type setting register). (The "SETTING" LED of the module blinks.)
- 4) Apply a voltage (or a current) that corresponds to the offset value to the terminal of the channel that is to be adjusted.
- 5) Set ON bit 0 (zero) of offset address +7 of the parameter setting data register to write the offset adjustment value in the module internal EEPROM. When bit 0 (zero) of offset address +2 is set ON, the writing of EEPROM is completed. After confirming this, set OFF bit 0 (zero) of the parameter setting data register (offset address +7).
- 6) Then set bit 14 ON of offset address +7 of the parameter setting data register. (Gain adjustment of analog input)
- 7) Apply a voltage (or a current) that corresponds to the gain value to the terminal.
- 8) Set ON bit 0 (zero) of offset address +7 of the parameter type setting register to write the gain adjustment value in the module internal EEPROM. Confirm the completion of writing in the same way as explained for offset adjustment.
- 9) Set OFF all the bits of the parameter type setting register, and clear all the bits of the parameter setting data register to zero. This completes the operation for adjustment.

Section 4 Software Interface

4-3 Analog Input/Output Module

<Analog output Offset/gain adjustment>

In this mode, offset value and/or gain value can finely be adjusted for individual channel.

- Offset value: Means the lower limit value of the range span. When this value is adjusted, the conversion characteristic curve moves parallel in vertical direction.
- Gain value: Means the upper limit value of the range span. When this value is adjusted, only gain value is changed while offset value is kept unchanged.

When offset and gain values are changed by scaling, the values that are set by scaling take effect as offset and gain values. When offset and/or gain values are to be adjusted after scaling, adjust by the values of scaling.

Note 1: Offset/gain adjustable range is within $\pm 1\%$ of range span. It takes approximately 2 minutes to adjust from 0% to $\pm 1\%$. If adjustment is made using an analog value that exceeds the adjustable range (if the value is input to a terminal of the module), the value is limited to $\pm 1\%$ of range span.

Note 2: If range is changed, offset and gain return to the default values.

Note 3: Negative current value cannot be output. If offset value is set too low, the conversion characteristic curve becomes as follows:

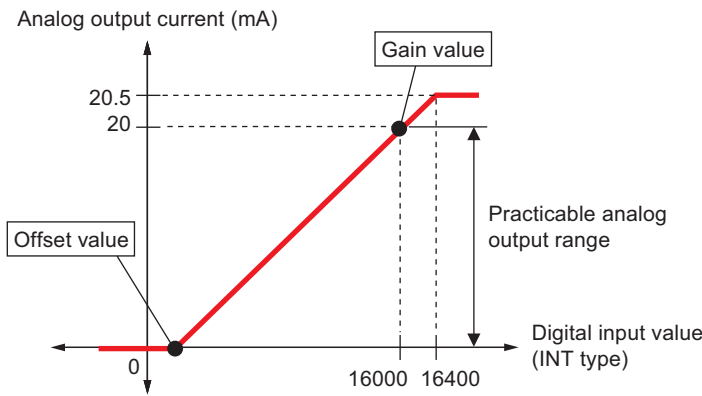

Offset and gain values for the range of -10 to 10 V.

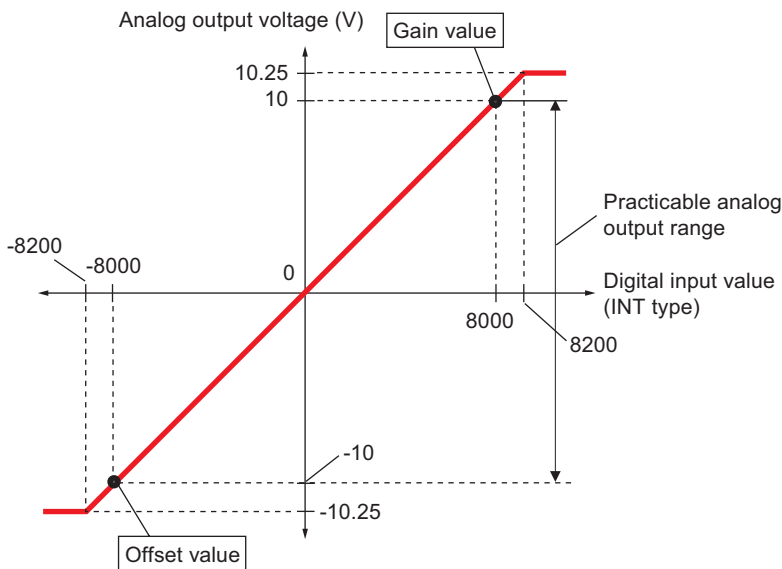

Section 4 Software Interface

4-3 Analog Input/Output Module

<Offset/gain adjustment procedure>

Offset is adjusted first.

- 1) Input "30000" to the parameter setting request register to activate the parameter mode. (Make sure that the status register is "30001".)
- 2) Set ON bit 7 of the parameter type setting register to activate offset/gain adjustment mode.
- 3) Set ON the bit for the channel to be adjusted (the corresponding bit of bits 12 or 13 of the parameter type setting register). (The "SETTING" LED of the module blinks.)
- 4) With an external device, etc. connected to the terminal of the channel that is to be adjusted, observe the output voltage or current value.
- 5) First, in the condition that bit 15 of the parameter setting data register (offset address +7) is set OFF, adjust output value by setting ON and OFF bit 4 (output value Down) and bit 5 (output value Up).
- 6) After the completion of offset adjustment, set ON bit 0 (zero) of the parameter setting data register (offset address +7) to write the offset adjustment value in the module internal EEPROM. When bit 0 (zero) of offset address +2 is set ON, the writing of EEPROM is completed. After confirming this, set OFF bit 0 (zero) of the parameter setting data register (offset address +7).
- 7) Then set bit 15 ON of the parameter setting data register (offset address +7) and, in the same way as offset adjustment, adjust output value by setting ON and OFF bit 4 (output value Down) and bit 5 (output value Up). (Gain adjustment)
- 8) After the completion of gain adjustment, set ON bit 0 (zero) of the parameter setting data register (offset address +7) to write the gain adjustment value in the module internal EEPROM. Confirm the completion of EEPROM writing, in the same way as explained for offset adjustment.
- 9) Set OFF all the bits of the parameter type setting register, and clear all the bits of the parameter setting data register to zero. This completes the adjustment work.

Section 5 Wiring

5-1 Wiring of Analog Input Module

5-1-1 Terminal arrangement

<NP1AXH8V-MR>

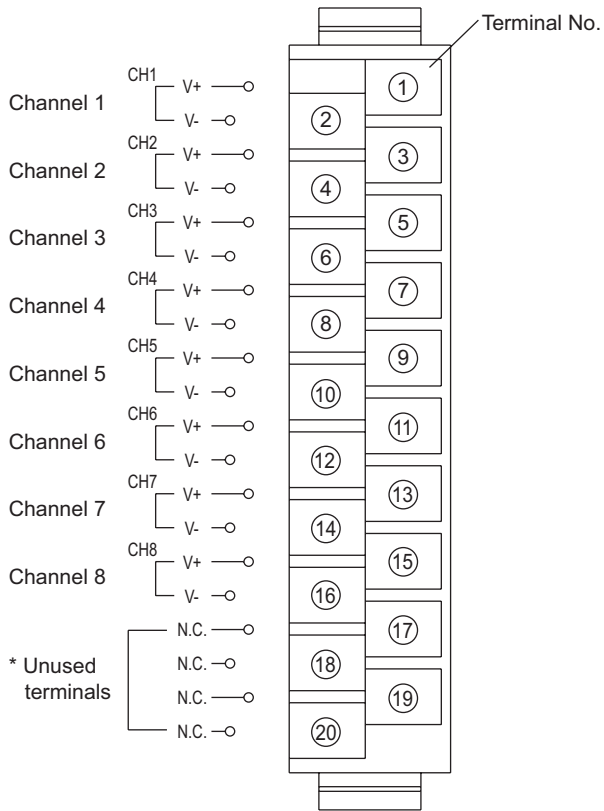

<NP1AXH8I-MR>

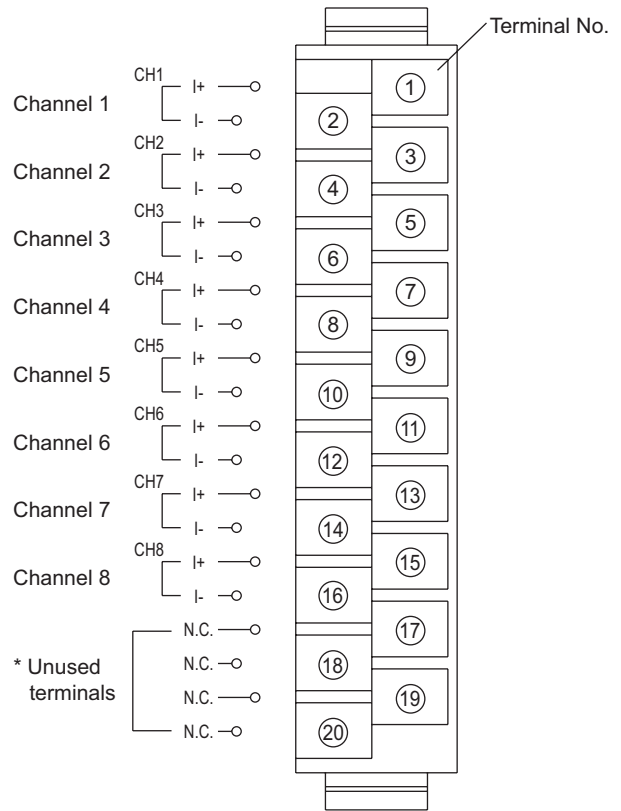

* Unused terminals can be used as relay terminals for shielded wires or analog signal cables.

Section 5 Wiring

5-1 Wiring of Analog Input Module

5-1-2 Wiring example

The analog input modules shall be wired according to the figure below, using shielded twisted pair cables.

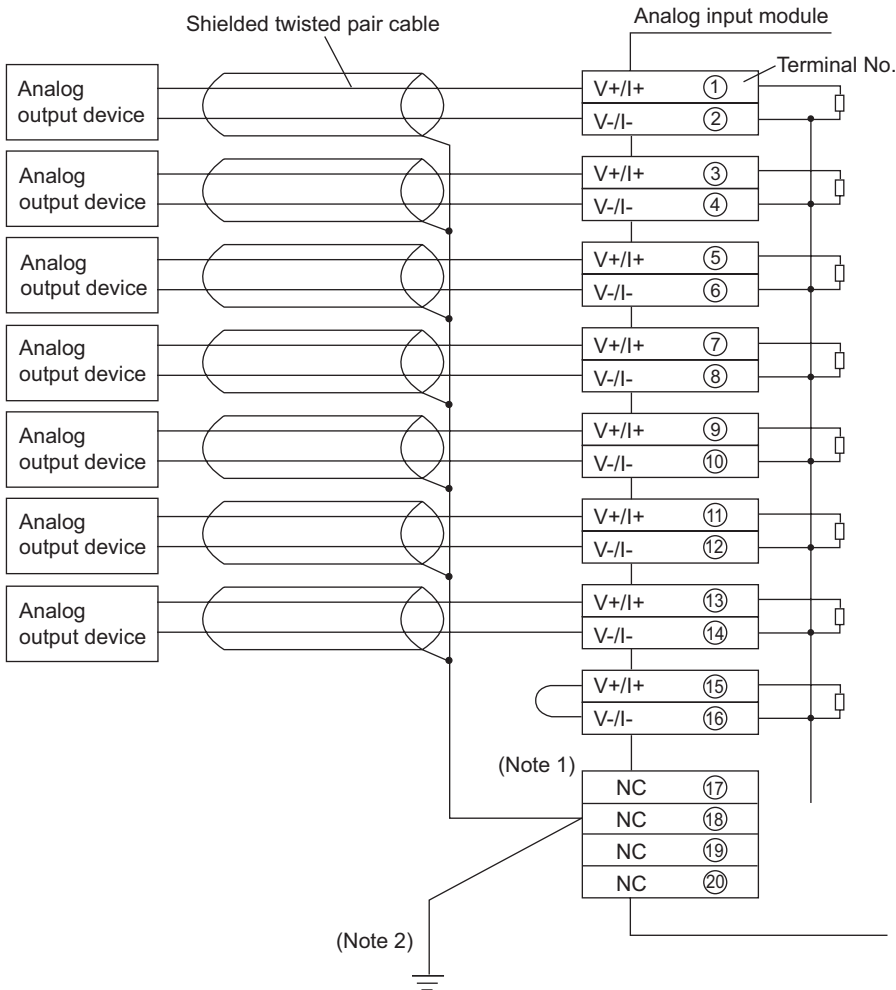

Note 1: Unused channels shall basically be short-circuited.

Note 2: Ground shielded wires at one point on the PC side (class D grounding). However, when shielded wires had better be grounded on the external device side due to the condition of external noise, their ends on the module side must be open. For grounding, NC terminals can be used as relay terminals for shielded wires. However, they must not be used as relay terminals for other control signal cables or power cables.

Note 3: Keep signal wires that go out of this module sufficiently away from high-voltage or power cables, and avoid parallel wiring.

Note 4: Avoid wiring the signal cables in the vicinity of load cables coming from devices other than PLC or bundling them with such cables.

Note 5: Keep the signal cables sufficiently away from circuits where high frequencies occur, such as inverter main load circuit.

Section 5 Wiring

5-2 Wiring of Analog Output Module

5-2-1 Terminal arrangement

<NP1AYH8V-MR>

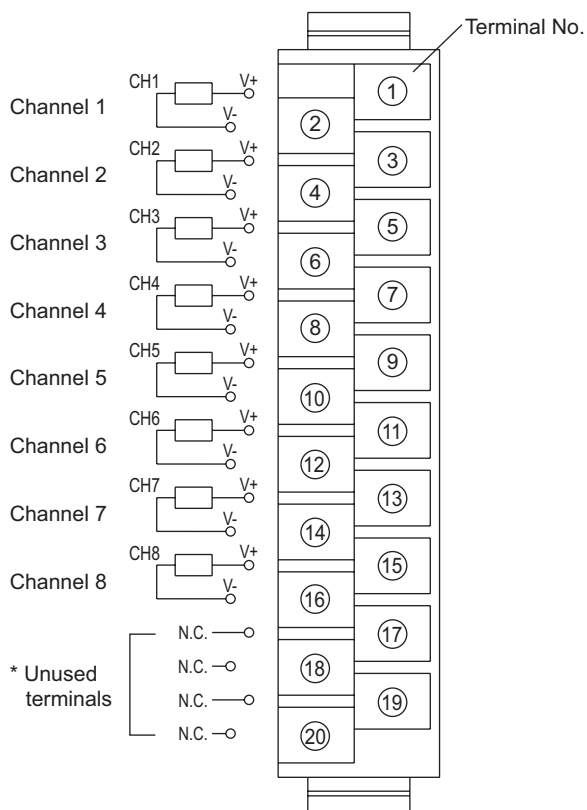

<NP1AYH8I-MR>

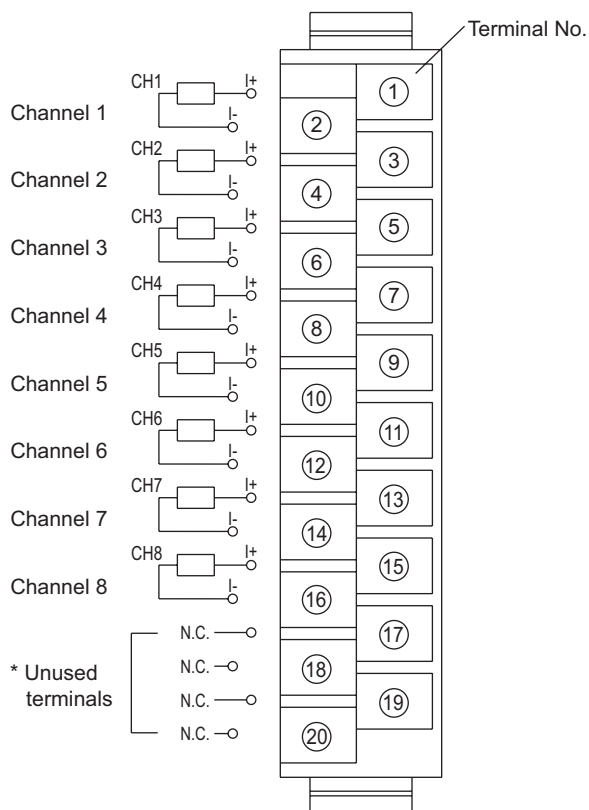

<NP1AYH4V-MR>

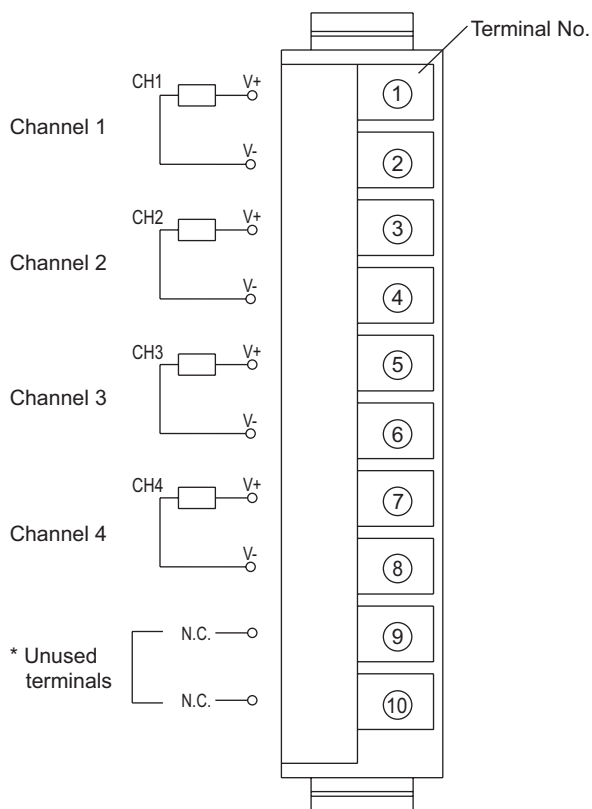

<NP1AYH4I-MR>

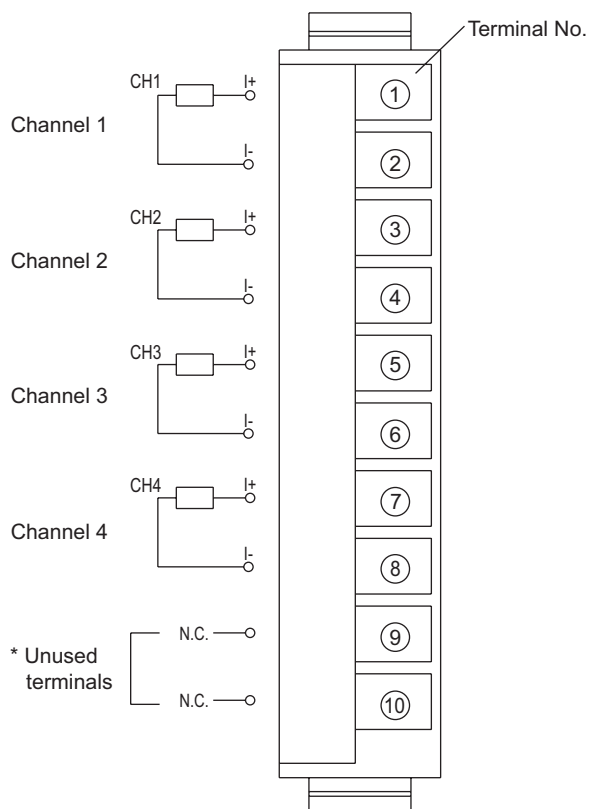

* Unused terminals can be used as relay terminals for shielded wires or analog signal cables.

Section 5 Wiring

5-2 Wiring of Analog Output Module

5-2-2 Wiring example

The analog output modules shall be wired according to the figure below, using shielded twisted pair cables.

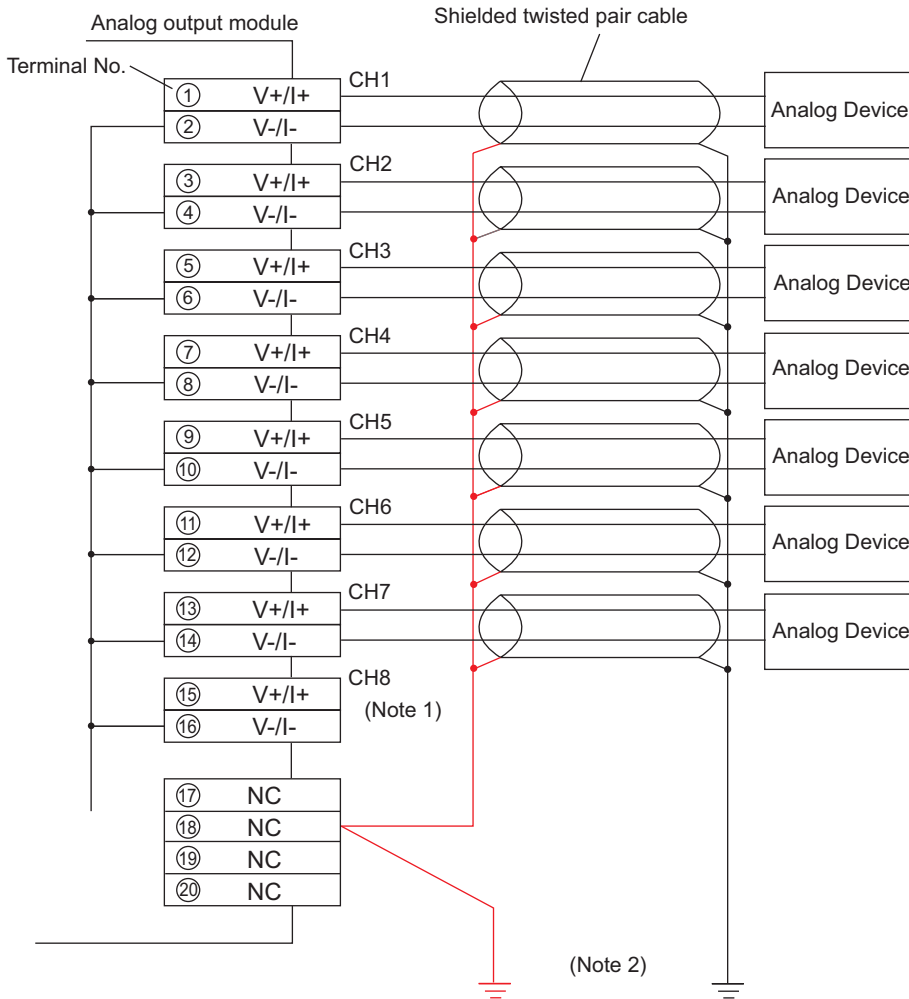

- Note 1: Unused channels shall basically be opened when the voltage output module is used or short-circuited when the current output module is used.
- Note 2: Shielded wires shall be grounded basically on the external device side (class D grounding). When shielded wires are grounded on the analog output module side (class D grounding) due to the condition of external noise, NC terminals can be used as relay terminals for shielded wires. However, they must not be used as relay terminals for other control signal cables or power cables.
- Note 3: Keep signal wires that go out of this module sufficiently away from high-voltage or power cables, and avoid parallel wiring.
- Note 4: Avoid wiring the signal cables in the vicinity of load cables coming from devices other than PLC or bundling them with such cables.
- Note 5: Keep the signal cables sufficiently away from circuits where high frequencies occur, such as inverter main load circuit.

Section 5 Wiring

5-3 Wiring of Analog Input/Output Module

5-3-1 Terminal arrangement

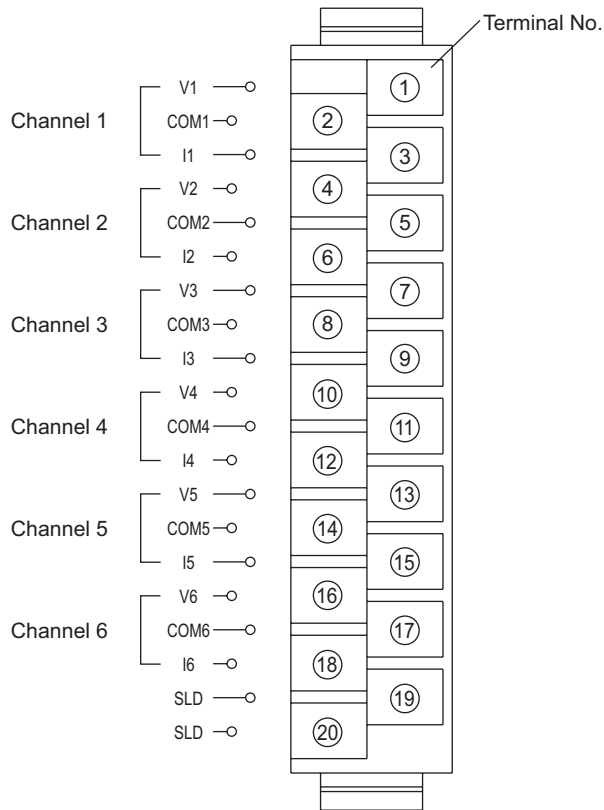

Section 5 Wiring

5-3 Wiring of Analog Input/Output Module

5-3-2 Wiring example

The analog input/output module shall be wired according to the figure below, using shielded twisted pair cables.

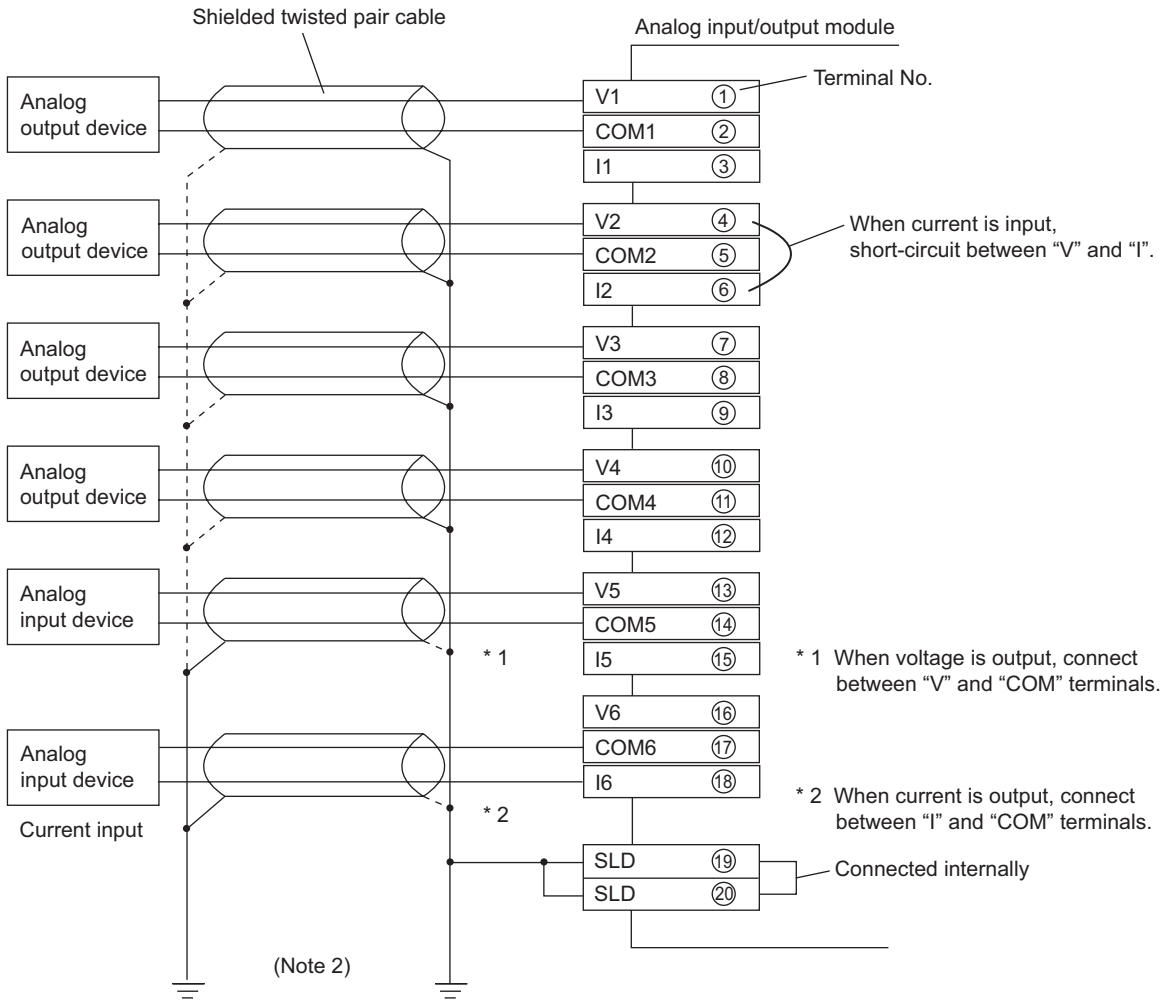

- Note 1: Unused channels shall basically be short-circuited and output terminals shall be open.
- Note 2: Ground shielded wires at one point on the PC side (class D grounding). However, when shielded wires had better be grounded on the external device side due to the condition of external noise, their ends on the module side must be open. If an external input device has the same FG, it may be better to ground both sides.
- Note 3: Keep signal wires that go out of this module sufficiently away from high-voltage or power cables, and avoid parallel wiring.
- Note 4: Avoid wiring the signal cables in the vicinity of load cables coming from devices other than PLC or bundling them with such cables.
- Note 5: Keep the signal cables sufficiently away from circuits where high frequencies occur, such as inverter main load circuit.

Appendix 1 Offset/Gain Adjustment <D300win>

Appendix 1-1 Offset/Gain Adjustment of Analog Input Module

<Offset/gain adjustment>

In this mode, offset value and/or gain value can finely be adjusted for individual channel.

- Offset value: Means the lower limit value of the range span. When this value is adjusted, the conversion characteristic curve moves parallel in vertical direction.
- Gain value: Means the upper limit value of the range span. When this value is adjusted, only gain value is changed while offset value is kept unchanged.

When offset and gain values are changed by scaling, the values that are set by scaling take effect as offset and gain values. When offset and/or gain values are to be adjusted after scaling, adjust by the values of scaling.

Note 1: Offset/gain adjustable range is within $\pm 1\%$ of range span. If adjustment is made using an analog value that exceeds the adjustable range (if the value is input to a terminal of the module), the value is limited to $\pm 1\%$ of range span.

Note 2: If range is changed, offset and gain return to the default values.

Note 3: Offset/gain adjustment is disabled when analog range is set in a batch with the switch provided on the module rear panel.

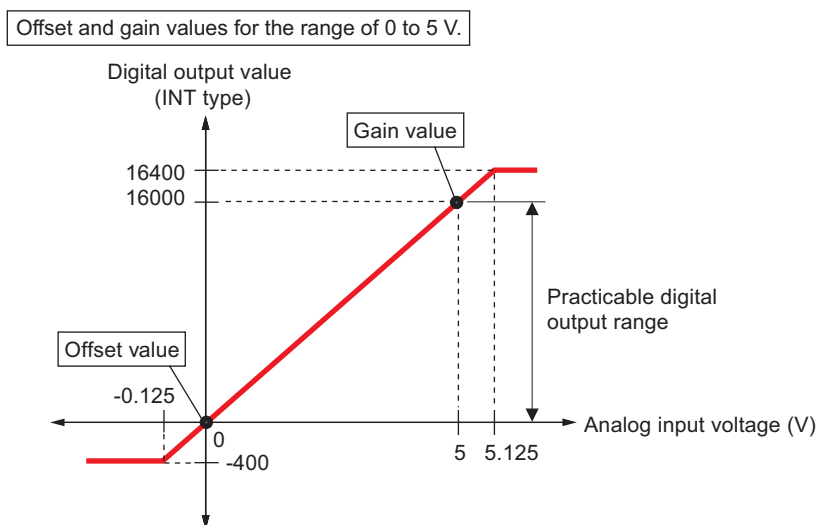

<Offset/gain adjustment with SX Control Utility of D300win>

1) Start SX Control Utility to monitor the input/output areas of the analog input module that is to be adjusted.

| CPU No. / Address | BIN | DEC(Signed) | HEX |
|-------------------|---------------------|---------------|------|
| 0 / I 1.0 | 1111 0010 0000 0000 | -3584 | F200 |
| 0 / Q 2.0 | 0000 0000 0000 0000 | 0 | 0000 |
| 0 / I 3.0 | 0000 0111 1101 0011 | 2003 | 07D3 |
| 0 / I 3.1 | 1111 1111 1110 1000 | -24 | FFE8 |
| 0 / I 3.2 | 1111 1111 1110 1001 | -23 | FFE9 |
| 0 / I 3.3 | 1111 1111 1110 1000 | -24 | FFE8 |
| 0 / I 3.4 | 1111 1111 1110 1000 | -24 | FFE8 |
| 0 / I 3.5 | 1111 1111 1110 0111 | -25 | FFE7 |
| 0 / I 3.6 | 1111 1111 1110 1000 | -24 | FFE8 |
| 0 / I 3.7 | 1111 1111 1110 0111 | -25 | FFE7 |
| 0 / Q 3.8 | 0000 0000 0000 0000 | 0 | 0000 |
| 0 / Q 3.9 | 0000 0000 0000 0000 | 0 | 0000 |
| 0 / Q 3.10 | 0000 0000 0000 0000 | 0 | 0000 |
| 0 / Q 3.11 | 0000 0000 0000 0000 | 0 | 0000 |
| 0 / I 4.0 | 0100 0000 0000 0000 | 16384 | 4000 |

Appendix 1 Offset/Gain Adjustment <D300win>

Appendix 1-1 Offset/Gain Adjustment of Analog Input Module

2) Offset is adjusted first.

Set ON bit 7 and bit 6 of the parameter type setting register (offset address +8) to activate offset/gain adjustment mode.

Bit 6 of the parameter type setting status register (offset address +1) is set ON, indicating that offset/gain adjustment mode is activated.

Make sure that module status is "30001".

| CPU No. / Address | BIN | DEC(Signed) | HEX |
|-------------------|---------------------|---------------|------|
| 0 / I 1.0 | 1111 0010 0000 0000 | -3584 | F200 |
| 0 / Q 2.0 | 0000 0000 0000 0000 | 0 | 0000 |
| 0 / I 3.0 | 0111 0101 0011 0001 | 30001 | 7531 |
| 0 / I 3.1 | 0000 0000 0100 0000 | 64 | 0040 |
| 0 / I 3.2 | 0000 0000 0000 0000 | 0 | 0000 |
| 0 / I 3.3 | 0000 0000 0000 0000 | 0 | 0000 |
| 0 / I 3.4 | 0000 0000 0000 0000 | 0 | 0000 |
| 0 / I 3.5 | 0000 0000 0000 0000 | 0 | 0000 |
| 0 / I 3.6 | 0000 0000 0000 0000 | 0 | 0000 |
| 0 / I 3.7 | 0000 0000 0000 0000 | 0 | 0000 |
| 0 / Q 3.8 | 0000 0000 1100 0000 | 192 | 00C0 |
| 0 / Q 3.9 | 0000 0000 0000 0000 | 0 | 0000 |
| 0 / Q 3.10 | 0000 0000 0000 0000 | 0 | 0000 |
| 0 / Q 3.11 | 0000 0000 0000 0000 | 0 | 0000 |
| 0 / I 4.0 | 0100 0000 0000 0000 | 16384 | 4000 |

3) Set ON the bit for the channel that is to be adjusted (the corresponding one of bits 8 to 15 of the parameter type setting register). (The "SETTING" LED of the module starts blinking.)

The bit of the parameter type setting status register that corresponds to the channel to be adjusted is set ON. In this example, bit 8 (channel 1) is set ON.

| CPU No. / Address | BIN | DEC(Signed) | HEX |
|-------------------|---------------------|---------------|------|
| 0 / I 1.0 | 1111 0010 0000 0000 | -3584 | F200 |
| 0 / Q 2.0 | 0000 0000 0000 0000 | 0 | 0000 |
| 0 / I 3.0 | 0111 0101 0011 0001 | 30001 | 7531 |
| 0 / I 3.1 | 0000 0001 0100 0000 | 320 | 0140 |
| 0 / I 3.2 | 0000 0000 0000 0000 | 0 | 0000 |
| 0 / I 3.3 | 0000 0000 0000 0000 | 0 | 0000 |
| 0 / I 3.4 | 0000 0000 0000 0000 | 0 | 0000 |
| 0 / I 3.5 | 0000 0000 0000 0000 | 0 | 0000 |
| 0 / I 3.6 | 0000 0000 0000 0000 | 0 | 0000 |
| 0 / I 3.7 | 0000 0000 0000 0000 | 0 | 0000 |
| 0 / Q 3.8 | 0000 0001 1100 0000 | 448 | 01C0 |
| 0 / Q 3.9 | 0000 0000 0000 0000 | 0 | 0000 |
| 0 / Q 3.10 | 0000 0000 0000 0000 | 0 | 0000 |
| 0 / Q 3.11 | 0000 0000 0000 0000 | 0 | 0000 |
| 0 / I 4.0 | 0100 0000 0000 0000 | 16384 | 4000 |

Channel 8 Channel 7 Channel 6 Channel 5 Channel 4 Channel 3 Channel 2 Channel 1

Appendix 1 Offset/Gain Adjustment <D300win>

Appendix 1-1 Offset/Gain Adjustment of Analog Input Module

- 4) Apply a voltage (or a current) that corresponds to **the offset value** to the terminal of the channel that is to be adjusted. Set ON bit 0 (zero) of the parameter setting data register (offset address +0) to write the offset adjustment value in the module internal EEPROM. The completion of EEPROM writing can be confirmed by that bit 0 (zero) of offset address +2 is set ON.

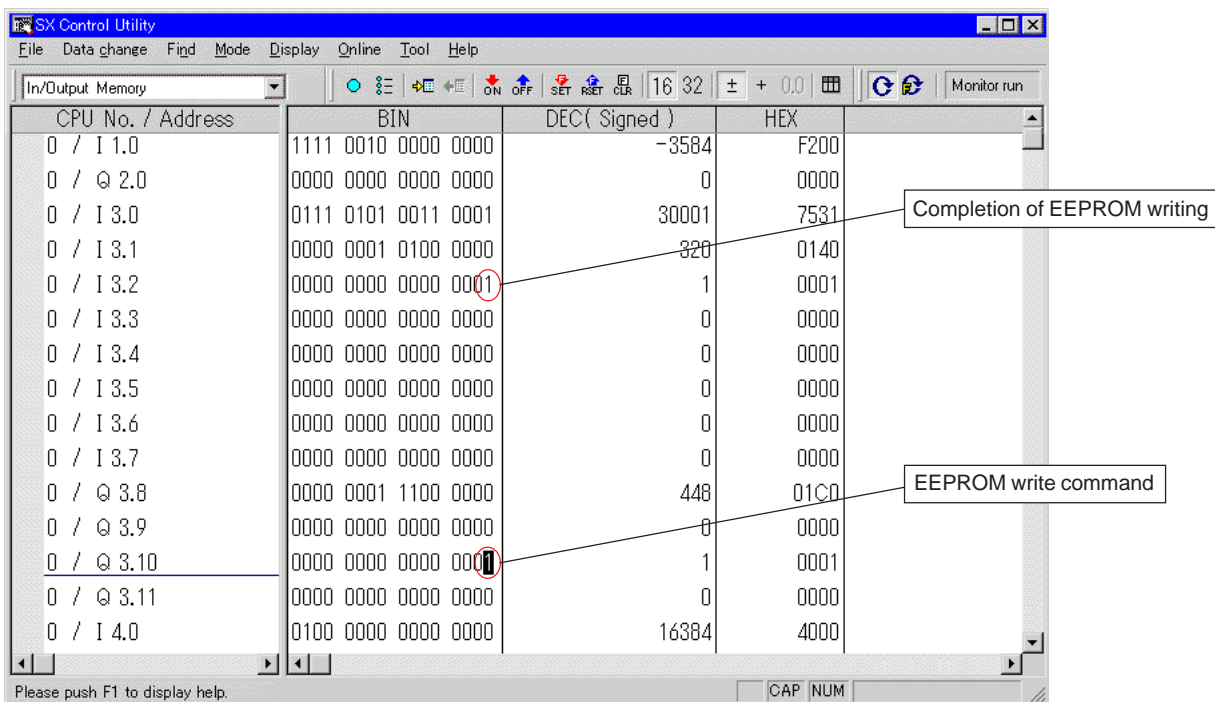

- 5) After confirming that the data is written in the EEPROM, set OFF bit 0 (zero) of offset address +10 of the parameter type setting register.

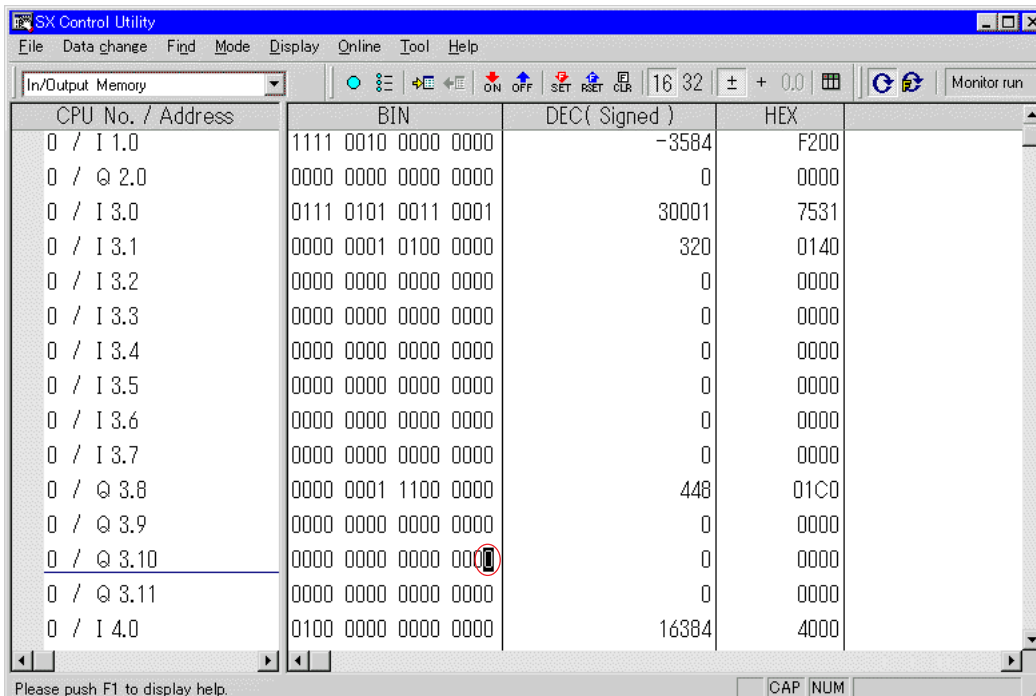

Appendix 1 Offset/Gain Adjustment <D300win>

Appendix 1-1 Offset/Gain Adjustment of Analog Input Module

- 6) When offset/gain adjustment mode is activated, offset adjustment value can be monitored.
Input the first channel number of the channels that are to be monitored to the parameter setting data register (offset address +9), and the statuses of offset values for 5 channels will be displayed in the fields for offset addresses +3 to +7 of the parameter read data register. (Gain adjustment values can be monitored in the same way.)

| CPU No. / Address | BIN | DEC(Signed) | HEX |
|-------------------|---------------------|---------------|------|
| 0 / I 2.0 | 0111 0101 0011 0001 | 30001 | 7531 |
| 0 / I 2.1 | 0000 0001 0100 0000 | 320 | 0140 |
| 0 / I 2.2 | 0000 0000 0000 0000 | 0 | 0000 |
| 0 / I 2.3 | 1111 1111 1111 1100 | -4 | FFFC |
| 0 / I 2.4 | 1111 1111 1101 0000 | -48 | FFD0 |
| 0 / I 2.5 | 1111 1111 1101 0010 | -46 | FFD2 |
| 0 / I 2.6 | 1111 1111 1101 0000 | -48 | FFD0 |
| 0 / I 2.7 | 1111 1111 1101 0001 | -47 | FFD1 |
| 0 / Q 2.8 | 0000 0001 1100 0000 | 448 | 01C0 |
| 0 / Q 2.9 | 0000 0000 0000 0001 | 1 | 0001 |
| 0 / Q 2.10 | 0000 0000 0000 0000 | 0 | 0000 |
| 0 / Q 2.11 | 0000 0000 0000 0000 | 0 | 0000 |
| 0 / I 3.0 | 0100 0000 0000 0000 | 16384 | 4000 |
| 0 / I 3.1 | 0000 0000 0000 0100 | 4 | 0004 |
| 0 / I 3.2 | 0000 0000 0000 0000 | 0 | 0000 |

- 7) Set ON bit 15 of the parameter type setting register and adjust gain.

| CPU No. / Address | BIN | DEC(Signed) | HEX |
|-------------------|---------------------|---------------|------|
| 0 / I 1.0 | 1111 0010 0000 0000 | -3584 | F200 |
| 0 / Q 2.0 | 0000 0000 0000 0000 | 0 | 0000 |
| 0 / I 3.0 | 0111 0101 0011 0001 | 30001 | 7531 |
| 0 / I 3.1 | 0000 0001 0100 0000 | 320 | 0140 |
| 0 / I 3.2 | 1000 0000 0000 0000 | -32768 | 8000 |
| 0 / I 3.3 | 0000 0000 0000 0000 | 0 | 0000 |
| 0 / I 3.4 | 0000 0000 0000 0000 | 0 | 0000 |
| 0 / I 3.5 | 0000 0000 0000 0000 | 0 | 0000 |
| 0 / I 3.6 | 0000 0000 0000 0000 | 0 | 0000 |
| 0 / I 3.7 | 0000 0000 0000 0000 | 0 | 0000 |
| 0 / Q 3.8 | 0000 0001 1100 0000 | 448 | 01C0 |
| 0 / Q 3.9 | 0000 0000 0000 0000 | 0 | 0000 |
| 0 / Q 3.10 | 1000 0000 0000 0000 | -32768 | 8000 |
| 0 / Q 3.11 | 0000 0000 0000 0000 | 0 | 0000 |
| 0 / I 4.0 | 0100 0000 0000 0000 | 16384 | 4000 |

Appendix 1 Offset/Gain Adjustment <D300win>

Appendix 1-1 Offset/Gain Adjustment of Analog Input Module

- 8) Apply a voltage (or a current) that corresponds to the gain adjustment value to the terminal.
 Set ON bit 0 (zero) of offset address +10 of the parameter type setting register to write gain adjustment value in the module internal EEPROM. Confirm the completion of EEPROM writing in the same way as offset adjustment.

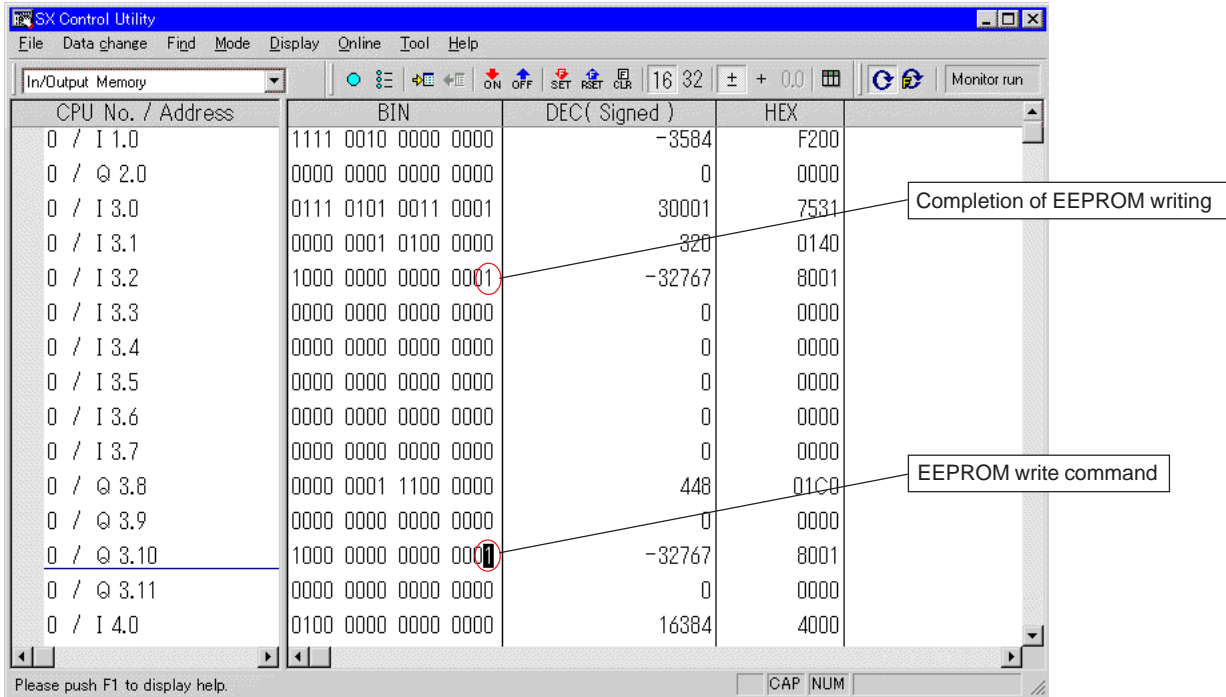

- 9) Set OFF all the bits of the parameter type setting register and clear all the bits of the parameter setting data register to zero. This completes the adjustment work.

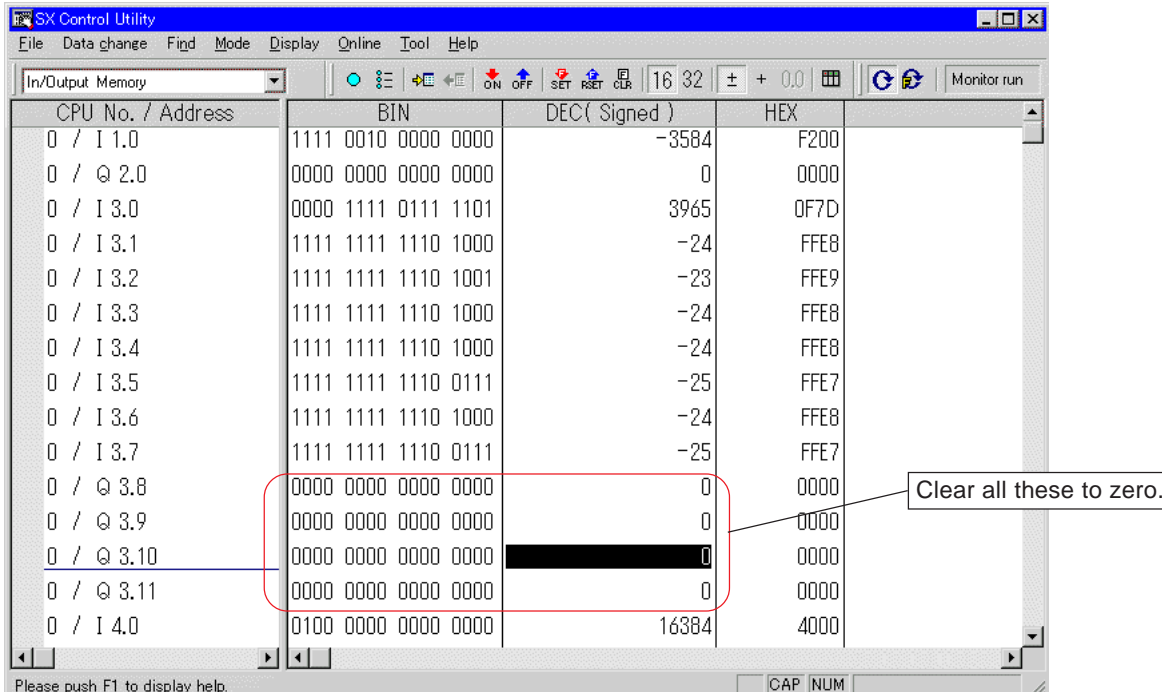

Appendix 1 Offset/Gain Adjustment <D300win>

Appendix 1-2 Offset/Gain Adjustment of Analog Output Module

<Offset/gain adjustment>

In this mode, offset value and/or gain value can finely be adjusted for individual channel.

- Offset value: Means the lower limit value of the range span. When this value is adjusted, the conversion characteristic curve moves parallel in vertical direction.
- Gain value: Means the upper limit value of the range span. When this value is adjusted, only gain value is changed while offset value is kept unchanged.

When offset and gain values are changed by scaling, the values that are set by scaling take effect as offset and gain values. When offset and/or gain values are to be adjusted after scaling, adjust by the values of scaling.

Note 1: Offset/gain adjustable range is within $\pm 1\%$ of range span. It takes approximately 2 minutes to adjust from 0% to $\pm 1\%$. If adjustment is made using an analog value that exceeds the adjustable range (if the value is input to a terminal of the module), the value is limited to $\pm 1\%$ of range span.

Note 2: If range is changed, offset and gain return to the default values.

Note 3: The current output modules cannot output negative current value.

Offset and gain values for the range of -10 to 10 V.

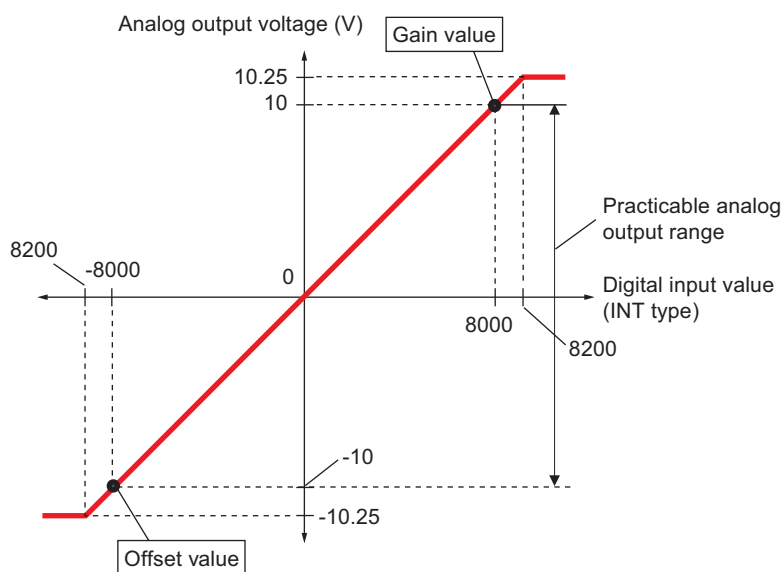

Appendix 1 Offset/Gain Adjustment <D300win>

Appendix 1-2 Offset/Gain Adjustment of Analog Output Module

<Offset/gain adjustment with SX Control Utility of D300win>

1) Start SX Control Utility to monitor the input/output areas of the analog output module that is to be adjusted.

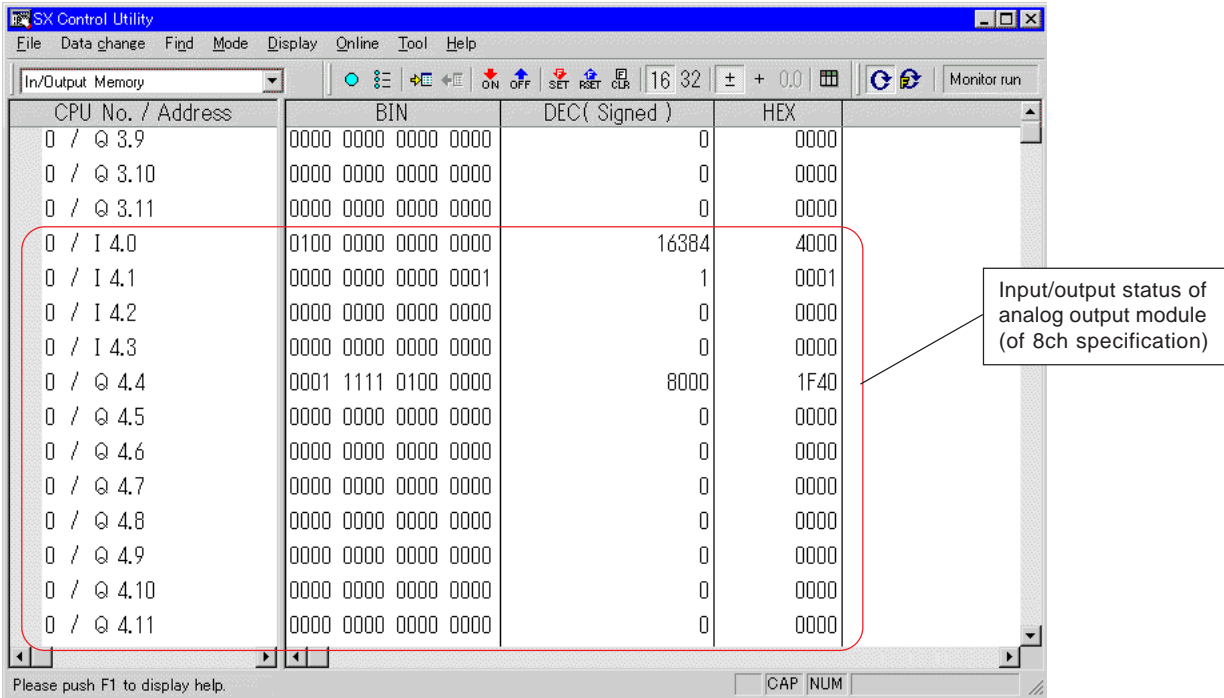

2) Offset is adjusted first.

Input a value in the range from "30000" to "32767" to offset address +4 to change mode.

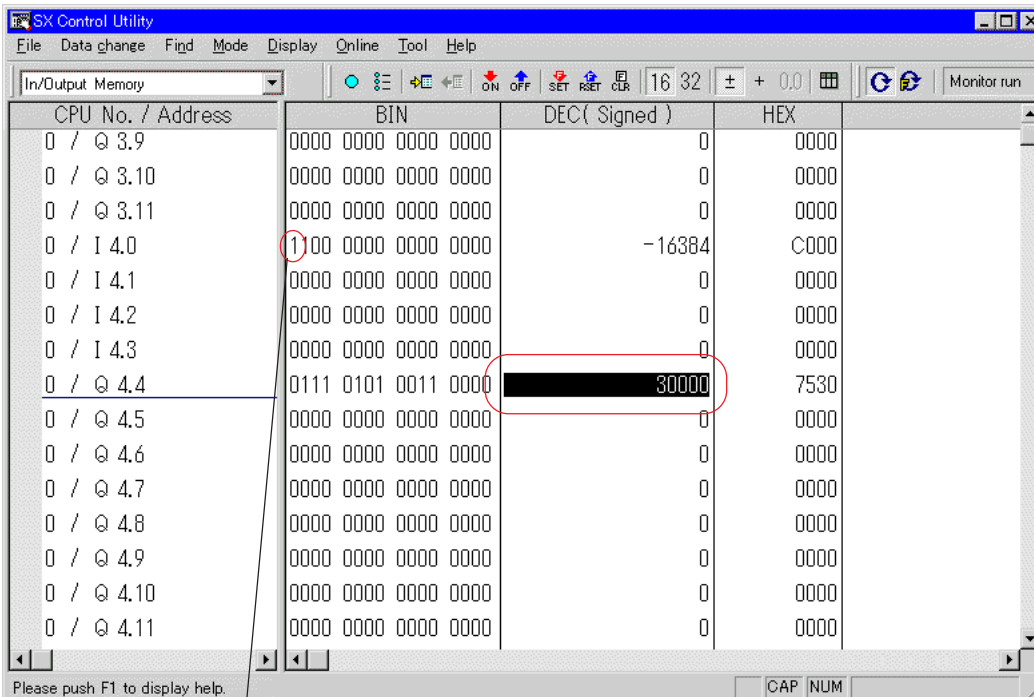

Make sure that bit 15 of the module status register (offset address +0) is set ON (parameter mode).

Appendix 1 Offset/Gain Adjustment <D300win>

Appendix 1-2 Offset/Gain Adjustment of Analog Output Module

- 3) Set ON bit 6 of the parameter type setting register (offset address +5) to activate offset/gain adjustment mode, and set ON the bit for the channel that is to be adjusted (the corresponding one of bits 8 to 15 of the parameter type setting register).

| CPU No. / Address | BIN | DEC(Signed) | HEX |
|-------------------|---------------------|---------------|------|
| 0 / Q 3.9 | 0000 0000 0000 0000 | 0 | 0000 |
| 0 / Q 3.10 | 0000 0000 0000 0000 | 0 | 0000 |
| 0 / Q 3.11 | 0000 0000 0000 0000 | 0 | 0000 |
| 0 / I 4.0 | 1100 0000 0000 0000 | -16384 | C000 |
| 0 / I 4.1 | 0000 0001 0100 0000 | 320 | 0140 |
| 0 / I 4.2 | 0000 0000 0000 0000 | 0 | 0000 |
| 0 / I 4.3 | 0000 0000 0000 0000 | 0 | 0000 |
| 0 / Q 4.4 | 0111 0101 0011 0000 | 30000 | 7530 |
| 0 / Q 4.5 | 0000 0001 0100 0000 | 320 | 0140 |
| 0 / Q 4.6 | 0000 0000 0000 0000 | 0 | 0000 |
| 0 / Q 4.7 | 0000 0000 0000 0000 | 0 | 0000 |
| 0 / Q 4.8 | 0000 0000 0000 0000 | 0 | 0000 |
| 0 / Q 4.9 | 0000 0000 0000 0000 | 0 | 0000 |
| 0 / Q 4.10 | 0000 0000 0000 0000 | 0 | 0000 |
| 0 / Q 4.11 | 0000 0000 0000 0000 | 0 | 0000 |

Channel 8 Channel 7 Channel 6 Channel 5 Channel 4 Channel 3 Channel 2 Channel 1

- 4) With an external device, etc. connected to the terminal of the channel to be adjusted, observe output voltage or current value. First, in the condition that bit 15 of the parameter setting data register (offset address +6) is set OFF, adjust output value by setting ON and OFF bit 8 (output value Down) and bit 9 (output value Up).

| CPU No. / Address | BIN | DEC(Signed) | HEX |
|-------------------|---------------------|---------------|------|
| 0 / I 3.7 | 1111 1111 1001 1110 | -98 | FF9E |
| 0 / Q 3.8 | 0000 0000 0000 0000 | 0 | 0000 |
| 0 / Q 3.9 | 0000 0000 0000 0000 | 0 | 0000 |
| 0 / Q 3.10 | 0000 0000 0000 0000 | 0 | 0000 |
| 0 / Q 3.11 | 0000 0000 0000 0000 | 0 | 0000 |
| 0 / I 4.0 | 1100 0000 0000 0000 | -16384 | C000 |
| 0 / I 4.1 | 0000 0001 0100 0000 | 320 | 0140 |
| 0 / I 4.2 | 0000 0001 0000 0000 | 256 | 0100 |
| 0 / I 4.3 | 0000 0000 0000 0000 | 0 | 0000 |
| 0 / Q 4.4 | 0111 0101 0011 0000 | 30000 | 7530 |
| 0 / Q 4.5 | 0000 0001 0100 0000 | 320 | 0140 |
| 0 / Q 4.6 | 0000 0001 0000 0000 | 256 | 0100 |
| 0 / Q 4.7 | 0000 0000 0000 0000 | 0 | 0000 |
| 0 / Q 4.8 | 0000 0000 0000 0000 | 0 | 0000 |
| 0 / Q 4.9 | 0000 0000 0000 0000 | 0 | 0000 |

0: Offset value adjustment
Output value Down
Output value Up

* While the output value up bit and down bit are on, the values change. (1% per 2minutes)

Appendix 1 Offset/Gain Adjustment <D300win>

Appendix 1-2 Offset/Gain Adjustment of Analog Output Module

5) After the completion of offset adjustment, set ON bit 0 (zero) of the parameter setting data register (offset address +6) to write the offset adjustment value in the module internal EEPROM. When bit 0 (zero) of offset address +2 is set ON, the writing of EEPROM is completed. After confirming this, set OFF bit 0 (zero) of the parameter setting data register.

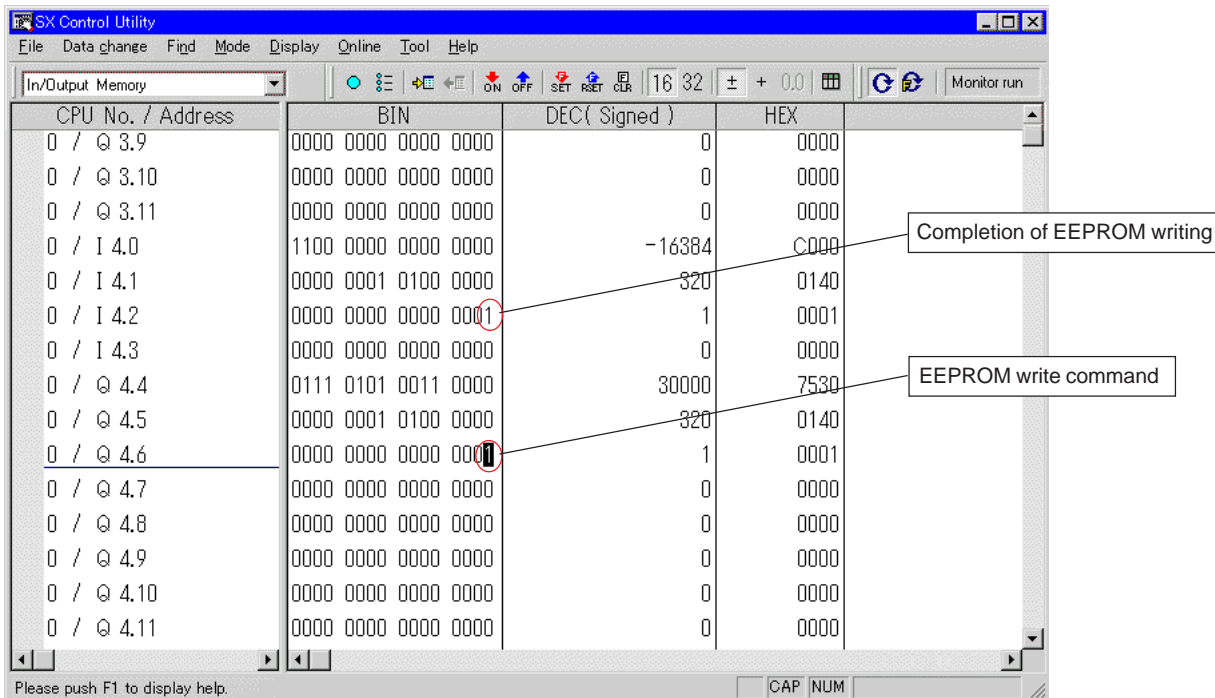

6) Then set bit 15 ON of the parameter setting data register (offset address +6) and, in the same way as offset adjustment, adjust output value by setting ON and OFF bit 8 (output value Down) and bit 9 (output value Up). (Gain adjustment)

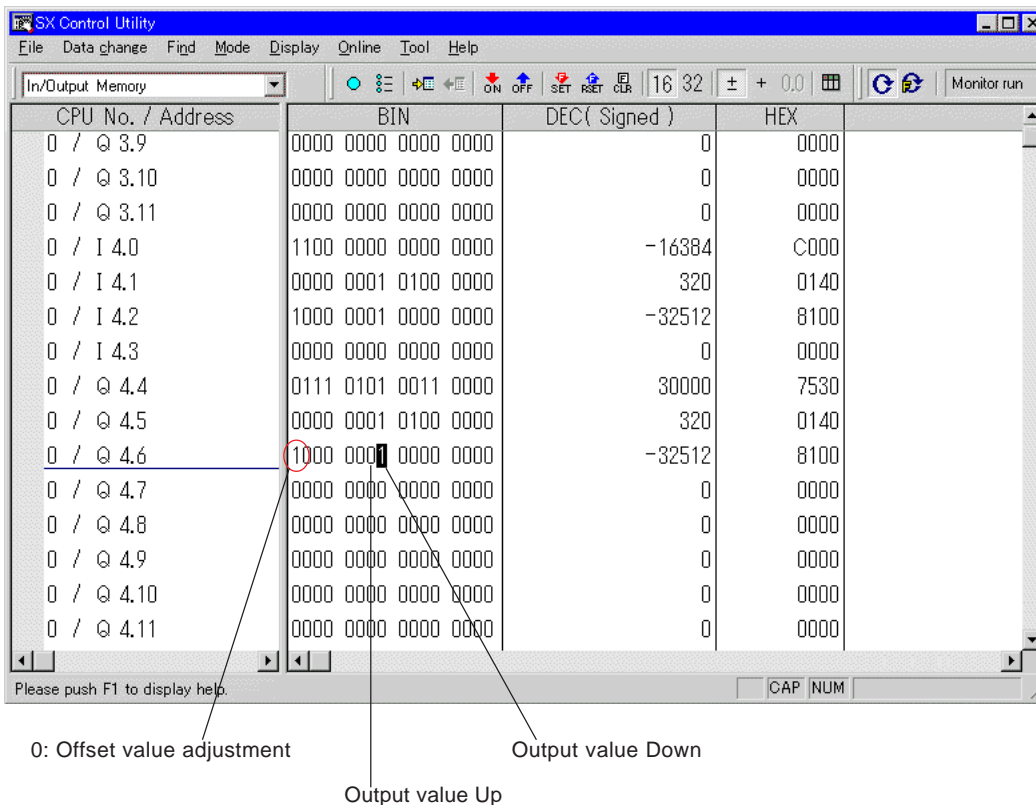

* While the output value up bit and down bit are on, the values change. (1% per 2minutes)

Appendix 1 Offset/Gain Adjustment <D300win>

Appendix 1-2 Offset/Gain Adjustment of Analog Output Module

7) After the completion of gain adjustment, set ON bit 0 (zero) of the parameter setting data register (offset address +6) to write the gain adjustment value in the module internal EEPROM. Confirm the completion of EEPROM writing, in the same way as explained for offset adjustment.

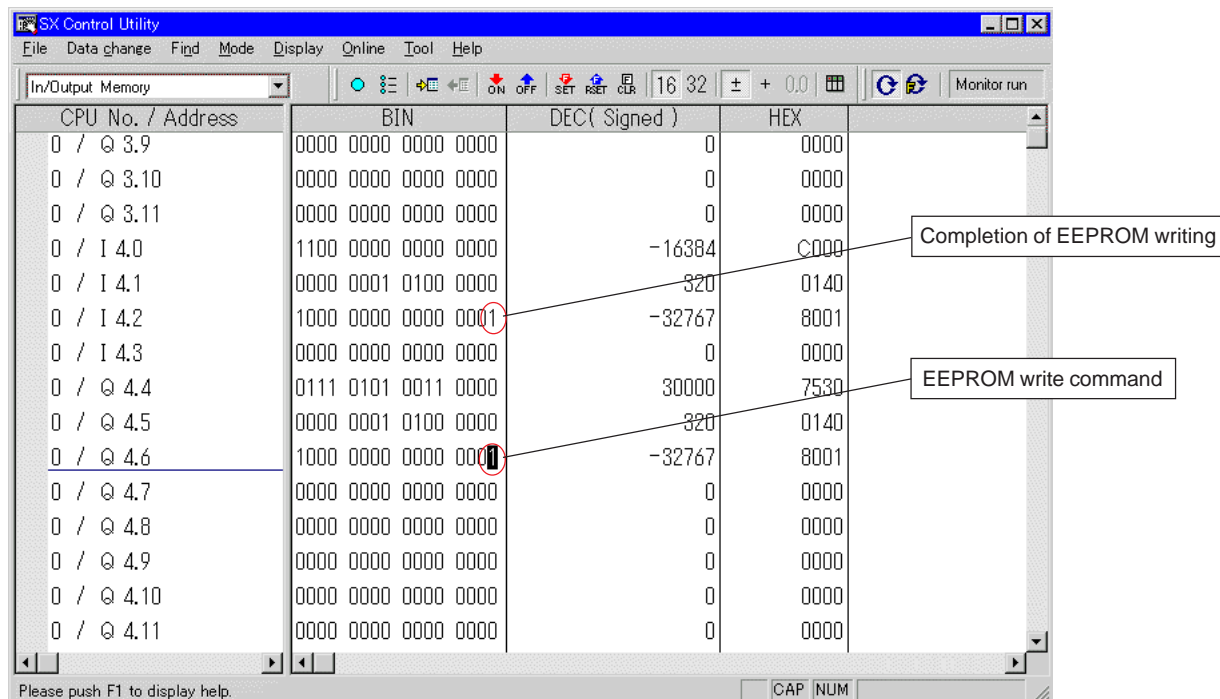

8) Set OFF all the bits of the parameter type setting register, and clear all the bits of the parameter setting data register to zero. This completes the adjustment work.

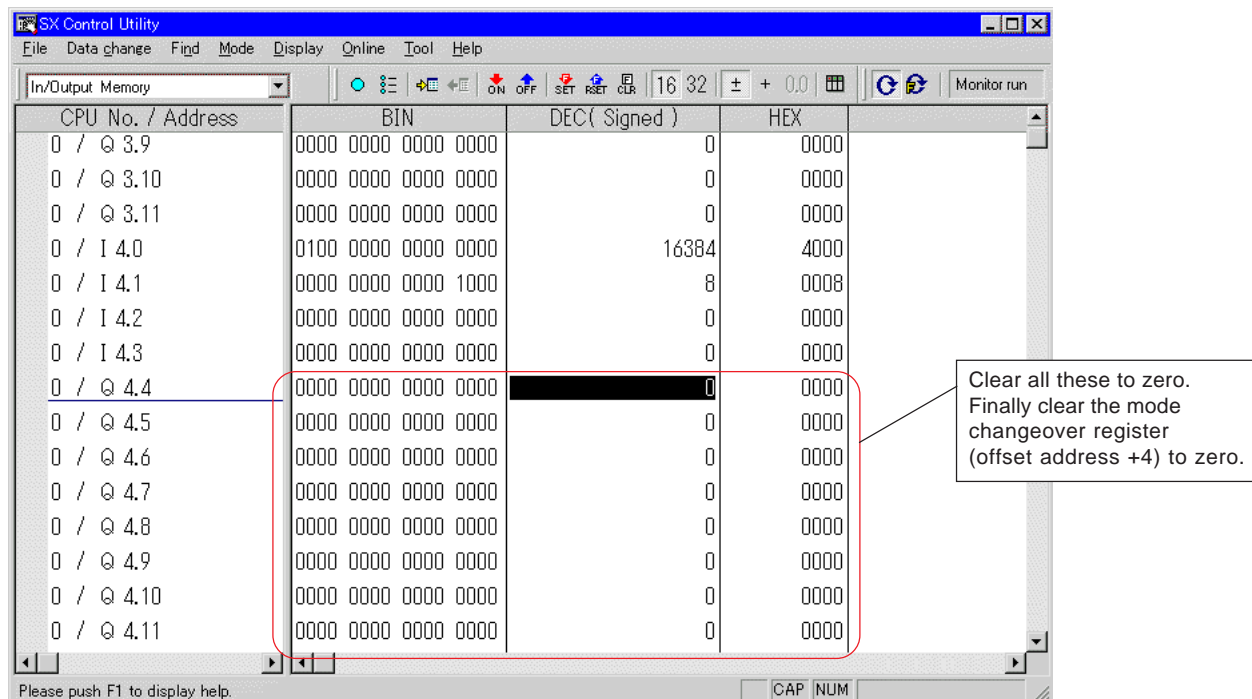

Appendix 2 Offset/Gain Adjustment <SX-Programmer Standard>

Appendix 2-1 Offset/Gain Adjustment of Analog Input Module

<Offset/gain adjustment>

In this mode, offset value and/or gain value can finely be adjusted for individual channel.

- Offset value: Means the lower limit value of the range span. When this value is adjusted, the conversion characteristic curve moves parallel in vertical direction.
- Gain value: Means the upper limit value of the range span. When this value is adjusted, only gain value is changed while offset value is kept unchanged.

When offset and gain values are changed by scaling, the values that are set by scaling take effect as offset and gain values. When offset and/or gain values are to be adjusted after scaling, adjust by the values of scaling.

Note 1: Offset/gain adjustable range is within $\pm 1\%$ of range span. If adjustment is made using an analog value that exceeds the adjustable range (if the value is input to a terminal of the module), the value is limited to $\pm 1\%$ of range span.

Note 2: If range is changed, offset and gain return to the default values.

Note 3: Offset/gain adjustment is disabled when analog range is set in a batch with the switch provided on the module rear panel.

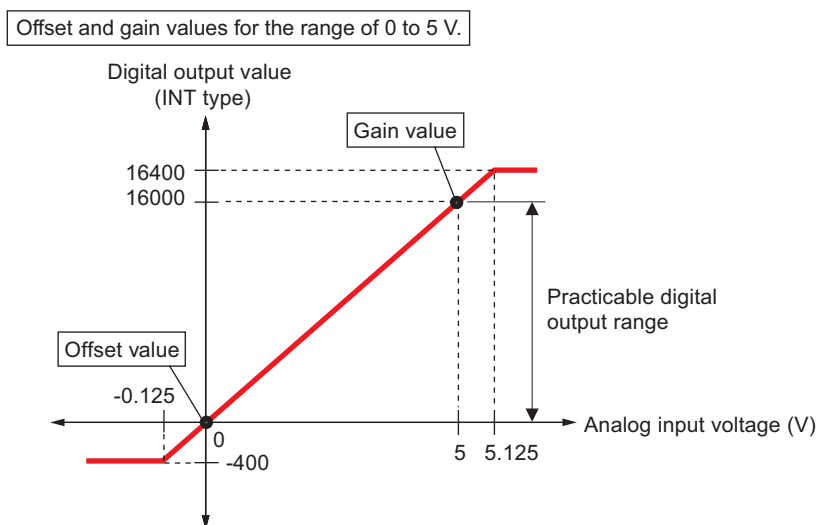

<Offset/gain adjustment with the data monitor and the setting function of SX-Programmer Standard>

1) Connect the loader to the PLC online to monitor the input/output areas of the analog input module that is to be adjusted.

| Address | Tag | | DEC | HEX | ASCII |
|-----------|-----|---------------------|-------|------|-------|
| WX02.0000 | | 1111 1111 1101 0001 | -47 | FFD1 | ↳ |
| WX02.0001 | | 1111 1111 1110 1001 | -23 | FFE9 | . |
| WX02.0002 | | 1111 1111 1110 1010 | -22 | FFEA | . |
| WX02.0003 | | 1111 1111 1110 1000 | -24 | FFE8 | . |
| WX02.0004 | | 1111 1111 1110 1001 | -23 | FFE9 | . |
| WX02.0005 | | 1111 1111 1110 1000 | -24 | FFE8 | . |
| WX02.0006 | | 1111 1111 1110 1000 | -24 | FFE8 | . |
| WX02.0007 | | 1111 1111 1110 0111 | -25 | FFE7 | . |
| WY02.0008 | | 0000 0000 0000 0000 | 0 | 0000 | |
| WY02.0009 | | 0000 0000 0000 0000 | 0 | 0000 | |
| WY02.000A | | 0000 0000 0000 0000 | 0 | 0000 | |
| WY02.000B | | 0000 0000 0000 0000 | 0 | 0000 | |
| WX03.0000 | | 0100 0000 0000 0000 | 16384 | 4000 | @ |

Input/output status of analog input module

Appendix 2 Offset/Gain Adjustment <SX-Programmer Standard>

Appendix 2-1 Offset/Gain Adjustment of Analog Input Module

2) Offset is adjusted first.

Set ON bit 7 and bit 6 of the parameter type setting register (offset address +8) to activate offset/gain adjustment mode.

Bit 6 of the parameter type setting status register (offset address +1) is set ON, indicating that offset/gain adjustment mode is activated.

Make sure that module status is "30001".

| Address | Tag | | DEC | HEX | ASCII |
|-----------|-----|---------------------|-------|------|-------|
| WX02.0000 | | 0111 0101 0011 0001 | 30001 | 7531 | 1 |
| WX02.0001 | | 0000 0000 0100 0000 | 64 | 0040 | @ |
| WX02.0002 | | 0000 0000 0000 0000 | 0 | 0000 | |
| WX02.0003 | | 0000 0000 0000 0000 | 0 | 0000 | |
| WX02.0004 | | 0000 0000 0000 0000 | 0 | 0000 | |
| WX02.0005 | | 0000 0000 0000 0000 | 0 | 0000 | |
| WX02.0006 | | 0000 0000 0000 0000 | 0 | 0000 | |
| WX02.0007 | | 0000 0000 0000 0000 | 0 | 0000 | |
| WY02.0008 | | 0000 0000 1100 0000 | 192 | 00C0 | ? |
| WY02.0009 | | 0000 0000 0000 0000 | 0 | 0000 | |
| WY02.000A | | 0000 0000 0000 0000 | 0 | 0000 | |
| WY02.000B | | 0000 0000 0000 0000 | 0 | 0000 | |
| WX03.0000 | | 0100 0000 0000 0000 | 16384 | 4000 | @ |

3) Set ON the bit for the channel that is to be adjusted (the corresponding one of bits 8 to 15 of the parameter type setting register). (The "SETTING" LED of the module starts blinking.)

The bit of the parameter type setting status register that corresponds to the channel to be adjusted is set ON. In this example, bit 8 (channel 1) is set ON.

| Address | Tag | | DEC | HEX | ASCII |
|-----------|-----|---------------------|-------|------|-------|
| WX02.0000 | | 0111 0101 0011 0001 | 30001 | 7531 | 1 |
| WX02.0001 | | 0000 0001 0100 0000 | 320 | 0140 | @ |
| WX02.0002 | | 0000 0000 0000 0000 | 0 | 0000 | |
| WX02.0003 | | 0000 0000 0000 0000 | 0 | 0000 | |
| WX02.0004 | | 0000 0000 0000 0000 | 0 | 0000 | |
| WX02.0005 | | 0000 0000 0000 0000 | 0 | 0000 | |
| WX02.0006 | | 0000 0000 0000 0000 | 0 | 0000 | |
| WX02.0007 | | 0000 0000 0000 0000 | 0 | 0000 | |
| WY02.0008 | | 0000 0001 1100 0000 | 448 | 01C0 | ? |
| WY02.0009 | | 0000 0000 0000 0000 | 0 | 0000 | |
| WY02.000A | | 0000 0000 0000 0000 | 0 | 0000 | |
| WY02.000B | | 0000 0000 0000 0000 | 0 | 0000 | |
| WX03.0000 | | 0100 0000 0000 0000 | 16384 | 4000 | @ |

Channel 8 Channel 7 Channel 6 Channel 5 Channel 4 Channel 3 Channel 2 Channel 1

Appendix 2 Offset/Gain Adjustment <SX-Programmer Standard>

Appendix 2-1 Offset/Gain Adjustment of Analog Input Module

4) Apply a voltage (or a current) that corresponds to **the offset value** to the terminal of the channel that is to be adjusted. Set ON bit 0 (zero) of the parameter setting data register (offset address +0) to write the offset adjustment value in the module internal EEPROM. The completion of EEPROM writing can be confirmed by that bit 0 (zero) of offset address +2 is set ON.

| Address | Tag | | DEC | HEX | ASCII |
|-----------|-----|---------------------|-------|------|-------|
| WX02.0000 | | 0111 0101 0011 0001 | 30001 | 7531 | 1u |
| WX02.0001 | | 0000 0001 0100 0000 | 320 | 0140 | @r |
| WX02.0002 | | 0000 0000 0000 0001 | 1 | 0001 | r |
| WX02.0003 | | 0000 0000 0000 0000 | 0 | 0000 | |
| WX02.0004 | | 0000 0000 0000 0000 | 0 | 0000 | |
| WX02.0005 | | 0000 0000 0000 0000 | 0 | 0000 | |
| WX02.0006 | | 0000 0000 0000 0000 | 0 | 0000 | |
| WX02.0007 | | 0000 0000 0000 0000 | 0 | 0000 | |
| WY02.0008 | | 0000 0001 1100 0000 | 448 | 01C0 | ꜧr |
| WY02.0009 | | 0000 0000 0000 0000 | 0 | 0000 | |
| WY02.000A | | 0000 0000 0000 0001 | 1 | 0001 | r |
| WY02.000B | | 0000 0000 0000 0000 | 0 | 0000 | |
| WX03.0000 | | 0100 0000 0000 0000 | 16384 | 4000 | @ |

Completion of EEPROM writing

EEPROM write command

5) After confirming that the data is written in the EEPROM, set OFF bit 0 (zero) of offset address +10 of the parameter type setting register.

| Address | Tag | | DEC | HEX | ASCII |
|-----------|-----|---------------------|-------|------|-------|
| WX02.0000 | | 0111 0101 0011 0001 | 30001 | 7531 | 1u |
| WX02.0001 | | 0000 0001 0100 0000 | 320 | 0140 | @r |
| WX02.0002 | | 0000 0000 0000 0000 | 0 | 0000 | |
| WX02.0003 | | 0000 0000 0000 0000 | 0 | 0000 | |
| WX02.0004 | | 0000 0000 0000 0000 | 0 | 0000 | |
| WX02.0005 | | 0000 0000 0000 0000 | 0 | 0000 | |
| WX02.0006 | | 0000 0000 0000 0000 | 0 | 0000 | |
| WX02.0007 | | 0000 0000 0000 0000 | 0 | 0000 | |
| WY02.0008 | | 0000 0001 1100 0000 | 448 | 01C0 | ꜧr |
| WY02.0009 | | 0000 0000 0000 0000 | 0 | 0000 | |
| WY02.000A | | 0000 0000 0000 0000 | 0 | 0000 | |
| WY02.000B | | 0000 0000 0000 0000 | 0 | 0000 | |
| WX03.0000 | | 0100 0000 0000 0000 | 16384 | 4000 | @ |

Appendix 2 Offset/Gain Adjustment <SX-Programmer Standard>

Appendix 2-1 Offset/Gain Adjustment of Analog Input Module

- 6) When offset/gain adjustment mode is activated, offset adjustment value can be monitored.
 Input the first channel number of the channels that are to be monitored to the parameter setting data register (offset address +9), and the statuses of offset values for 5 channels will be displayed in the fields for offset addresses +3 to +7 of the parameter read data register. (Gain adjustment values can be monitored in the same way.)

| Address | Tag | | DEC | HEX | ASCII |
|-----------|-----|---------------------|-------|------|-------|
| WX02.0000 | | 0111 0101 0011 0001 | 30001 | 7531 | 1u |
| WX02.0001 | | 0000 0001 0100 0000 | 320 | 0140 | 0r |
| WX02.0002 | | 0000 0000 0000 0000 | 0 | 0000 | |
| WX02.0003 | | 0000 0000 0000 0010 | 2 | 0002 | 1 |
| WX02.0004 | | 1111 1111 1110 1000 | -24 | FFE8 | . |
| WX02.0005 | | 1111 1111 1110 1010 | -22 | FFEA | . |
| WX02.0006 | | 1111 1111 1110 1000 | -24 | FFE8 | . |
| WX02.0007 | | 1111 1111 1110 1001 | -23 | FFE9 | . |
| WY02.0008 | | 0000 0001 1100 0000 | 448 | 01C0 | 5r |
| WY02.0009 | | 0000 0000 0000 0001 | 1 | 0001 | r |
| WY02.000A | | 0000 0000 0000 0000 | 0 | 0000 | |
| WY02.000B | | 0000 0000 0000 0000 | 0 | 0000 | |
| WX03.0000 | | 0100 0000 0000 0000 | 16384 | 4000 | 0 |

The statuses of offset values can be monitored.

Set "1" (one) when you want to monitor channel 1 (one) and following channels.

- 7) Set ON bit 15 of the parameter type setting register and adjust gain.

| Address | Tag | | DEC | HEX | ASCII |
|-----------|-----|---------------------|--------|------|-------|
| WX02.0000 | | 0111 0101 0011 0001 | 30001 | 7531 | 1u |
| WX02.0001 | | 0000 0001 0100 0000 | 320 | 0140 | 0r |
| WX02.0002 | | 1000 0000 0000 0000 | -32768 | 8000 | 0 |
| WX02.0003 | | 0000 0000 0000 0011 | 3 | 0003 | L |
| WX02.0004 | | 1111 1111 1110 1001 | -23 | FFE9 | . |
| WX02.0005 | | 1111 1111 1110 1010 | -22 | FFEA | . |
| WX02.0006 | | 1111 1111 1110 1001 | -23 | FFE9 | . |
| WX02.0007 | | 1111 1111 1110 1001 | -23 | FFE9 | . |
| WY02.0008 | | 0000 0001 1100 0000 | 448 | 01C0 | 5r |
| WY02.0009 | | 0000 0000 0000 0001 | 1 | 0001 | r |
| WY02.000A | | 1000 0000 0000 0000 | -32768 | 8000 | 0 |
| WY02.000B | | 0000 0000 0000 0000 | 0 | 0000 | |
| WX03.0000 | | 0100 0000 0000 0000 | 16384 | 4000 | 0 |

Bit 15 of the parameter type setting status register is set ON.

Appendix 2 Offset/Gain Adjustment <SX-Programmer Standard>

Appendix 2-1 Offset/Gain Adjustment of Analog Input Module

8) Apply a voltage (or a current) that corresponds to the gain adjustment value to the terminal.

Set ON bit 0 (zero) of offset address +10 of the parameter type setting register to write gain adjustment value in the module internal EEPROM. Confirm the completion of EEPROM writing in the same way as offset adjustment.

| Address | Tag | | DEC | HEX | ASCII |
|-----------|-----|---------------------|--------|------|-------|
| WX02.0000 | | 0111 0101 0011 0001 | 30001 | 7531 | 1u |
| WX02.0001 | | 0000 0001 0100 0000 | 320 | 0140 | @r |
| WX02.0002 | | 1000 0000 0000 0001 | -32767 | 8001 | # |
| WX02.0003 | | 0000 0000 0000 0010 | 2 | 0002 | γ |
| WX02.0004 | | 1111 1111 1110 1000 | -24 | FFE8 | . |
| WX02.0005 | | 1111 1111 1110 1010 | -22 | FFE9 | . |
| WX02.0006 | | 1111 1111 1110 1001 | -23 | FFE9 | . |
| WX02.0007 | | 1111 1111 1110 1001 | -23 | FFE9 | . |
| WY02.0008 | | 0000 0001 1100 0000 | 448 | 01C0 | ḡr |
| WY02.0009 | | 0000 0000 0000 0001 | 1 | 0001 | r |
| WY02.000A | | 1000 0000 0000 0001 | -32767 | 8001 | # |
| WY02.000B | | 0000 0000 0000 0000 | 0 | 0000 | |
| WX03.0000 | | 0100 0000 0000 0000 | 16384 | 4000 | @ |

Completion of EEPROM writing

EEPROM write command

9) Set OFF all the bits of the parameter type setting register and clear all the bits of the parameter setting data register to zero. This completes the adjustment work.

| Address | Tag | | DEC | HEX | ASCII |
|-----------|-----|---------------------|-------|------|-------|
| WX02.0000 | | 0000 0000 0000 0010 | 2 | 0002 | γ |
| WX02.0001 | | 1111 1111 1110 1001 | -23 | FFE9 | . |
| WX02.0002 | | 1111 1111 1110 1001 | -23 | FFE9 | . |
| WX02.0003 | | 1111 1111 1110 1001 | -23 | FFE9 | . |
| WX02.0004 | | 1111 1111 1110 1001 | -23 | FFE9 | . |
| WX02.0005 | | 1111 1111 1110 1000 | -24 | FFE8 | . |
| WX02.0006 | | 1111 1111 1110 1001 | -23 | FFE9 | . |
| WX02.0007 | | 1111 1111 1110 1001 | -23 | FFE9 | . |
| WY02.0008 | | 0000 0000 0000 0000 | 0 | 0000 | |
| WY02.0009 | | 0000 0000 0000 0000 | 0 | 0000 | |
| WY02.000A | | 0000 0000 0000 0000 | 0 | 0000 | |
| WY02.000B | | 0000 0000 0000 0000 | 0 | 0000 | |
| WX03.0000 | | 0100 0000 0000 0000 | 16384 | 4000 | @ |

Clear all these to zero.

Appendix 2 Offset/Gain Adjustment <SX-Programmer Standard>

Appendix 2-2 Offset/Gain Adjustment of Analog Output Module

<Offset/gain adjustment>

In this mode, offset value and/or gain value can finely be adjusted for individual channel.

- Offset value: Means the lower limit value of the range span. When this value is adjusted, the conversion characteristic curve moves parallel in vertical direction.
- Gain value: Means the upper limit value of the range span. When this value is adjusted, only gain value is changed while offset value is kept unchanged.

When offset and gain values are changed by scaling, the values that are set by scaling take effect as offset and gain values. When offset and/or gain values are to be adjusted after scaling, adjust by the values of scaling.

Note 1: Offset/gain adjustable range is within $\pm 1\%$ of range span. It takes approximately 2 minutes to adjust from 0% to $\pm 1\%$. If adjustment is made using an analog value that exceeds the adjustable range (if the value is input to a terminal of the module), the value is limited to $\pm 1\%$ of range span.

Note 2: If range is changed, offset and gain return to the default values.

Note 3: The current output modules cannot output negative current value.

Offset and gain values for the range of -10 to 10 V.

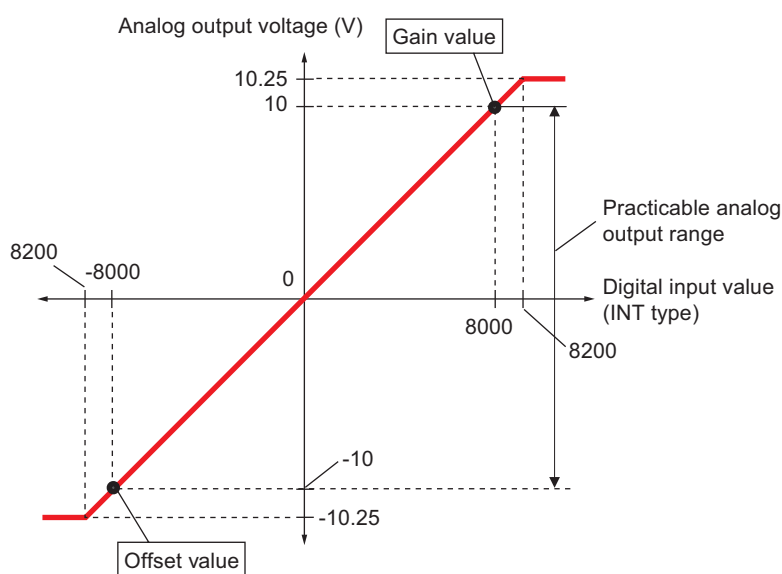

Appendix 2 Offset/Gain Adjustment <SX-Programmer Standard>

Appendix 2-2 Offset/Gain Adjustment of Analog Output Module

<Offset/gain adjustment with SX Control Utility of D300win>

1) Connect a loader to a PLC online to monitor the input/output areas of the analog input module that is to be adjusted.

| Address | Tag | | DEC | HEX | ASCII |
|------------|-----|---------------------|-------|------|-------|
| WX003.0000 | | 0100 0000 0000 0000 | 16384 | 4000 | @ |
| WX003.0001 | | 0000 0000 0000 1000 | 8 | 0008 | □ |
| WX003.0002 | | 0000 0000 0000 0000 | 0 | 0000 | |
| WX003.0003 | | 0000 0000 0000 0000 | 0 | 0000 | |
| WY003.0004 | | 0000 0000 0000 0000 | 0 | 0000 | |
| WY003.0005 | | 0000 0000 0000 0000 | 0 | 0000 | |
| WY003.0006 | | 0000 0000 0000 0000 | 0 | 0000 | |
| WY003.0007 | | 0000 0000 0000 0000 | 0 | 0000 | |
| WY003.0008 | | 0000 0000 0000 0000 | 0 | 0000 | |
| WY003.0009 | | 0000 0000 0000 0000 | 0 | 0000 | |
| WY003.0010 | | 0000 0000 0000 0000 | 0 | 0000 | |
| WY003.0011 | | 0000 0000 0000 0000 | 0 | 0000 | |

Input/output status of analog output module (of 8ch specification)

2) Offset is adjusted first.

Input a value in the range from "30000" to "32767" to offset address +4 to change mode.

| Address | Tag | | DEC | HEX | ASCII |
|------------|-----|---------------------|--------|------|-------|
| WX003.0000 | | 1000 0000 0000 0000 | -16384 | C000 | ↵ |
| WX003.0001 | | 0000 0000 0000 0000 | 0 | 0000 | |
| WX003.0002 | | 0000 0000 0000 0000 | 0 | 0000 | |
| WX003.0003 | | 0000 0000 0000 0000 | 0 | 0000 | |
| WY003.0004 | | 0111 0101 0011 0000 | 30000 | 7530 | 0u |
| WY003.0005 | | 0000 0000 0000 0000 | 0 | 0000 | |
| WY003.0006 | | 0000 0000 0000 0000 | 0 | 0000 | |
| WY003.0007 | | 0000 0000 0000 0000 | 0 | 0000 | |
| WY003.0008 | | 0000 0000 0000 0000 | 0 | 0000 | |
| WY003.0009 | | 0000 0000 0000 0000 | 0 | 0000 | |
| WY003.0010 | | 0000 0000 0000 0000 | 0 | 0000 | |
| WY003.0011 | | 0000 0000 0000 0000 | 0 | 0000 | |

Make sure that bit 15 of the module status register (offset address +0) is set ON (parameter mode).

3) Set ON bit 6 of the parameter type setting register (offset address +5) to activate offset/gain adjustment mode, and set ON the bit for the channel that is to be adjusted (the corresponding one of bits 8 to 15 of the parameter type setting register).

| Address | Tag | | DEC | HEX | ASCII |
|------------|-----|---------------------|--------|------|-------|
| WX003.0000 | | 1100 0000 0000 0000 | -16384 | C000 | ↵ |
| WX003.0001 | | 0000 0000 0100 0000 | 64 | 0040 | @ |
| WX003.0002 | | 0000 0000 0000 0000 | 0 | 0000 | |
| WX003.0003 | | 0000 0000 0000 0000 | 0 | 0000 | |
| WY003.0004 | | 0111 0101 0011 0000 | 30000 | 7530 | 0u |
| WY003.0005 | | 0000 0000 0100 0000 | 64 | 0040 | @ |
| WY003.0006 | | 0000 0000 0000 0000 | 0 | 0000 | |
| WY003.0007 | | 0000 0000 0000 0000 | 0 | 0000 | |
| WY003.0008 | | 0000 0000 0000 0000 | 0 | 0000 | |
| WY003.0009 | | 0000 0000 0000 0000 | 0 | 0000 | |
| WY003.0010 | | 0000 0000 0000 0000 | 0 | 0000 | |
| WY003.0011 | | 0000 0000 0000 0000 | 0 | 0000 | |

Channel 8 Channel 7 Channel 6 Channel 5 Channel 4 Channel 3 Channel 2 Channel 1

Appendix 2 Offset/Gain Adjustment <SX-Programmer Standard>

Appendix 2-2 Offset/Gain Adjustment of Analog Output Module

- 4) With an external device, etc. connected to the terminal of the channel to be adjusted, observe output voltage or current value. First, in the condition that bit 15 of the parameter setting data register (offset address +6) is set OFF, adjust output value by setting ON and OFF bit 8 (output value Down) and bit 9 (output value Up).

| Address | Tag | | DEC | HEX | ASCII |
|------------|-----|---------------------|--------|------|-------|
| WX003.0000 | | 1100 0000 0000 0000 | -16384 | C000 | ? |
| WX003.0001 | | 0000 0000 0100 0000 | 64 | 0040 | @ |
| WX003.0002 | | 0000 0000 0000 0000 | 0 | 0000 | |
| WX003.0003 | | 0000 0000 0000 0000 | 0 | 0000 | |
| WY003.0004 | | 0111 0101 0011 0000 | 30000 | 7530 | 0u |
| WY003.0005 | | 0000 0000 0100 0000 | 64 | 0040 | @ |
| WY003.0006 | | 0000 0001 0000 0000 | 256 | 0100 | r |
| WY003.0007 | | 0000 0000 0000 0000 | 0 | 0000 | |
| WY003.0008 | | 0000 0000 0000 0000 | 0 | 0000 | |
| WY003.0009 | | 0000 0000 0000 0000 | 0 | 0000 | |
| WY003.0010 | | 0000 0000 0000 0000 | 0 | 0000 | |
| WY003.0011 | | 0000 0000 0000 0000 | 0 | 0000 | |

0: Offset value adjustment Output value Down Output value Up

- 5) After the completion of offset adjustment, set ON bit 0 (zero) of the parameter setting data register (offset address +6) to write the offset adjustment value in the module internal EEPROM. When bit 0 (zero) of offset address +2 is set ON, the writing of EEPROM is completed. After confirming this, set OFF bit 0 (zero) of the parameter setting data register.

| Address | Tag | | DEC | HEX | ASCII |
|------------|-----|---------------------|--------|------|-------|
| WX003.0000 | | 1100 0000 0000 0000 | -16384 | C000 | ? |
| WX003.0001 | | 0000 0001 0100 0000 | 320 | 0140 | @r |
| WX003.0002 | | 0000 0000 0000 0001 | 1 | 0001 | r |
| WX003.0003 | | 0000 0000 0000 0000 | 0 | 0000 | |
| WY003.0004 | | 0111 0101 0011 0000 | 30000 | 7530 | 0u |
| WY003.0005 | | 0000 0001 0100 0000 | 320 | 0140 | @r |
| WY003.0006 | | 0000 0000 0000 0001 | 1 | 0001 | r |
| WY003.0007 | | 0000 0000 0000 0000 | 0 | 0000 | |
| WY003.0008 | | 0000 0000 0000 0000 | 0 | 0000 | |
| WY003.0009 | | 0000 0000 0000 0000 | 0 | 0000 | |
| WY003.0010 | | 0000 0000 0000 0000 | 0 | 0000 | |
| WY003.0011 | | 0000 0000 0000 0000 | 0 | 0000 | |

Completion of EEPROM writing

EEPROM write command

- 6) Then set bit 15 ON of the parameter setting data register (offset address +6) and, in the same way as offset adjustment, adjust output value by setting ON and OFF bit 8 (output value Down) and bit 9 (output value Up). (Gain adjustment)

| Address | Tag | | DEC | HEX | ASCII |
|------------|-----|---------------------|--------|------|-------|
| WX003.0000 | | 1100 0000 0000 0000 | -16384 | C000 | ? |
| WX003.0001 | | 0000 0001 0100 0000 | 320 | 0140 | @r |
| WX003.0002 | | 1000 0001 0000 0000 | -32512 | 8100 | |
| WX003.0003 | | 0000 0000 0000 0000 | 0 | 0000 | |
| WY003.0004 | | 0111 0101 0011 0000 | 30000 | 7530 | 0u |
| WY003.0005 | | 0000 0001 0100 0000 | 320 | 0140 | @r |
| WY003.0006 | | 1000 0001 0000 0000 | -32512 | 8100 | |
| WY003.0007 | | 0000 0000 0000 0000 | 0 | 0000 | |
| WY003.0008 | | 0000 0000 0000 0000 | 0 | 0000 | |
| WY003.0009 | | 0000 0000 0000 0000 | 0 | 0000 | |
| WY003.0010 | | 0000 0000 0000 0000 | 0 | 0000 | |
| WY003.0011 | | 0000 0000 0000 0000 | 0 | 0000 | |

0: Offset value adjustment Output value Down Output value Up

Appendix 2 Offset/Gain Adjustment <SX-Programmer Standard>

Appendix 2-2 Offset/Gain Adjustment of Analog Output Module

7) After the completion of gain adjustment, set ON bit 0 (zero) of the parameter setting data register (offset address +6) to write the gain adjustment value in the module internal EEPROM. Confirm the completion of EEPROM writing, in the same way as explained for offset adjustment.

| Address | Tag | | DEC | HEX | ASCII |
|------------|-----|---------------------|--------|------|-------|
| WX003.0000 | | 1100 0000 0000 0000 | -16384 | C000 | ␣ |
| WX003.0001 | | 0000 0001 0100 0000 | 320 | 0140 | @r |
| WX003.0002 | | 1000 0001 0000 0001 | -32511 | 8101 | r |
| WX003.0003 | | 0000 0000 0000 0000 | 0 | 0000 | |
| WY003.0004 | | 0111 0101 0011 0000 | 30000 | 7530 | 0u |
| WY003.0005 | | 0000 0001 0100 0000 | 320 | 0140 | @r |
| WY003.0006 | | 1000 0001 0000 0001 | -32511 | 8101 | r |
| WY003.0007 | | 0000 0000 0000 0000 | 0 | 0000 | |
| WY003.0008 | | 0000 0000 0000 0000 | 0 | 0000 | |
| WY003.0009 | | 0000 0000 0000 0000 | 0 | 0000 | |
| WY003.0010 | | 0000 0000 0000 0000 | 0 | 0000 | |
| WY003.0011 | | 0000 0000 0000 0000 | 0 | 0000 | |

Completion of EEPROM writing

EEPROM write command

8) Set OFF all the bits of the parameter type setting register, and clear all the bits of the parameter setting data register to zero. This completes the adjustment work.

| Address | Tag | | DEC | HEX | ASCII |
|------------|-----|---------------------|-------|------|-------|
| WX003.0000 | | 0100 0000 0000 0000 | 16384 | 4000 | @ |
| WX003.0001 | | 0000 0000 0000 1000 | 8 | 0008 | ␣ |
| WX003.0002 | | 0000 0000 0000 0000 | 0 | 0000 | |
| WX003.0003 | | 0000 0000 0000 0000 | 0 | 0000 | |
| WY003.0004 | | 0000 0000 0000 0000 | 0 | 0000 | |
| WY003.0005 | | 0000 0000 0000 0000 | 0 | 0000 | |
| WY003.0006 | | 0000 0000 0000 0000 | 0 | 0000 | |
| WY003.0007 | | 0000 0000 0000 0000 | 0 | 0000 | |
| WY003.0008 | | 0000 0000 0000 0000 | 0 | 0000 | |
| WY003.0009 | | 0000 0000 0000 0000 | 0 | 0000 | |
| WY003.0010 | | 0000 0000 0000 0000 | 0 | 0000 | |
| WY003.0011 | | 0000 0000 0000 0000 | 0 | 0000 | |

Clear all these to zero.
Finally clear the mode changeover register (offset address +4) to zero.

Fuji Electric FA Components & Systems Co., Ltd.

Mitsui Sumitomo Bank Ningyo-cho Bldg.,
5-7, Nihonbashi Odemma-cho, Chuo-ku, Tokyo 103-0011, Japan
Phone: +81-3-5847-8011
Fax: +81-3-5847-8172
URL <http://www.fujielectric.co.jp/fcs/eng/>