

OMRON

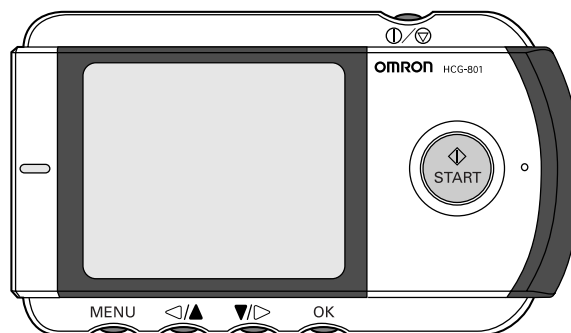

**Portable, cordless, single-channel ECG Monitor  
Model HCG-801**

**• Instruction Manual**

EN

**A Good Sense of Health**

Thank you for purchasing the OMRON Portable ECG Monitor.  
Before using this unit for the first time, please be sure to read this instruction manual carefully and use the unit properly.  
Please keep this instruction manual on hand for future reference.

OMRON assumes no responsibility for personal injury or damage sustained by or through use of this product.

## Contents

### Before Using the Unit

Introduction .....	3
Notes on Safety .....	4
1. Know Your Unit .....	6

### Operating Instructions

2. Inserting and Replacing Batteries .....	10
3. Setting the Date and Time .....	13
4. Using SD Memory Card .....	15
4.1 Inserting and Ejecting SD Memory Card .....	15
4.2 Formatting an SD Memory Card .....	19
5. Important Notes on Taking a Measurement .....	21
6. Taking a Measurement .....	22
7. Displaying ECG Data .....	28
8. Adjusting the Settings .....	30
8.1 Basic Operation .....	30
8.2 Date and Time .....	32
8.3 Volume .....	32
8.4 Brightness .....	33
8.5 Contrast .....	34
8.6 Language .....	35
8.7 Date Format .....	36
8.8 Messages .....	37
8.9 Overwrite .....	38
9. Managing ECG Data .....	39
9.1 Erasing ECG Data .....	39
9.2 Copying Data to an SD Memory Card .....	42
9.3 Copying data from the SD memory card to a PC .....	44

### Care and Maintenance

10. Care and Maintenance .....	46
10.1 Lists and Explanations of Messages .....	46
10.2 Troubleshooting .....	50
11. Maintenance and Storage .....	52
12. Technical Data .....	53
13. General Information About the Heart and ECG Measurements .....	54

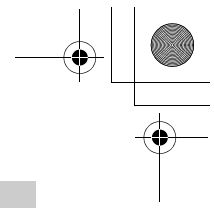
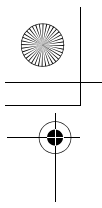

## Introduction

Your OMRON HCG-801 is an easy-to-use electrocardiograph unit that can record and store electrocardiogram (ECG) measurements of your heart rhythm. Each ECG reading records about 30-second measurement and these ECG readings can help your doctor monitor your condition. It also includes guidance screens to help you obtain good results when taking measurements.

The monitor is supplied with an SD memory card that can store up to 300 measurements, which include the ECG data along with the date and time of measurement. Storing ECG data on the SD memory card, or in unit memory, allows you or your doctor to view them later.

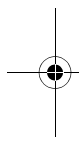

**Important: Please note that while the measurements from an ECG monitor are a useful guide for your doctor, they cannot detect all changes in heart conditions. Always consult your doctor if you notice any change in your condition, regardless of the measurement results. Consult a doctor even if “Stable waveform.” is displayed as the measurement result, if you have been diagnosed with a heart condition.**

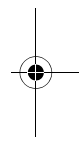

\* The illustrations used in this manual may differ slightly from the appearance of the actual product.

EN

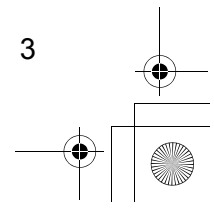
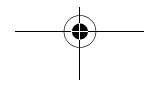
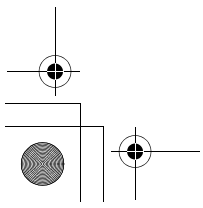

## Notes on Safety

**This unit is designed for monitoring of the ECG waveform. It is not designed or intended for medical diagnosis. Never use the unit in critical situations!**

**- Self-diagnosis and treatment is dangerous.**

The measurement results are for monitoring purposes only, and should never be used as a basis for starting or modifying treatment without independent confirmation by medical examination.

**- The values displayed by the unit are the values at the time of measurement.**

Medical conditions can change suddenly. If you notice any change in your condition, consult your doctor, regardless of the measurement results.

### Warning!

- Do not use with a cardiac pacemaker. 
- Do not use with a defibrillator.
- Do not use in the presence of flammable anesthetics, drugs or pressurised oxygen (such as in a hyperbaric chamber, ultraviolet steriliser or oxygen tent).
- Do not attempt self-diagnosis of the measurement results and analysis, always consult your doctor.
  - Self-diagnosis may lead to a deterioration in your condition.
- Do not use on people with sensitive skin or allergies.
  - This may result in exanthema, skin irritation, or eczema.
- Keep out of reach of small children and people who can not express their consent.
- Do not use for any purpose other than obtaining an electrocardiograph.
- Do not expose the unit to strong shocks or vibrations, or drop or step on the unit.
- Do not use batteries of a type other than that specified in this manual.
- Do not apply over clothing or touch the electrodes with your left hand.

- Do not take measurements when there are drops of water on your skin, such as from sweat or after bathing.
- Do not take measurements where the unit will be exposed to strong electromagnetic forces.

### Caution!

- Do not expose the unit to static electricity. Always disperse any static electricity from your body before handling the unit.
- Do not take measurements in a moving vehicle.
- Do not use a cellular phone near the unit.
- Do not disassemble, repair, or modify the unit.
- Do not insert batteries with their polarities reversed.
- The chest electrode will be impeded by excessive body hair, regularly remove hair at the electrode contact point. Omron does not recommend the use of contact gel.

### General

- Avoid extremes in temperature and humidity. Do not use this unit in locations subject to high or low temperatures or humidity.  
Use at a temperature within 10 to 40 °C and between 30 and 85% RH.
- Do not sterilise this unit in an autoclave or gas steriliser (EOG, formaldehyde, high density ozone etc.)
- Do not wash this unit with water.
- Do not store the unit in the following ambient conditions:
  - Locations exposed to direct sunlight.
  - Locations subject to high temperatures and high humidity.
  - Wet or damp locations where water may get on the unit.
  - Dusty locations.
  - Near fires or open flames.
  - Locations exposed to strong vibration.
  - Locations exposed to strong electromagnetic fields.

## 1. Know Your Unit

### Main Unit

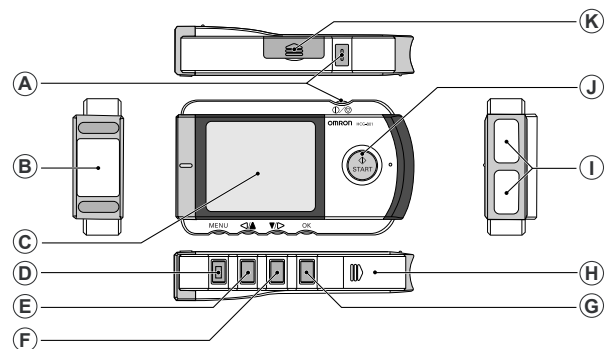

- |                                                                                                                                                                                                                                                                                                                                                                                                                                                                                                                                                                                                                                                                          |                                                                                                                                                                                                                                                                                                                                                                                                                                                  |
|--------------------------------------------------------------------------------------------------------------------------------------------------------------------------------------------------------------------------------------------------------------------------------------------------------------------------------------------------------------------------------------------------------------------------------------------------------------------------------------------------------------------------------------------------------------------------------------------------------------------------------------------------------------------------|--------------------------------------------------------------------------------------------------------------------------------------------------------------------------------------------------------------------------------------------------------------------------------------------------------------------------------------------------------------------------------------------------------------------------------------------------|
| <p><b>A.</b> ①/⊗ (Power/Cancel) button<br/>Turns the power on/off and cancels measurement.</p> <p><b>B.</b> Chest electrode<br/>Place this against your chest when taking a measurement.</p> <p><b>C.</b> Display<br/>Displays the wave pattern after measurement, and displays menus and setting options.</p> <p><b>D.</b> MENU button<br/>Displays or closes the menu screen.</p> <p><b>E.</b> ◀/▲ button<br/>Moves the desired menu or wave pattern to the left or up and decreases the number of the selected field.</p> <p><b>F.</b> ▼/▶ button<br/>Moves the desired menu or wave pattern to the right or down and increases the number of the selected field.</p> | <p><b>G.</b> OK button<br/>Selects the highlighted menu option or ECG data.<br/>Clears error messages.</p> <p><b>H.</b> Battery cover<br/>Open this cover to insert batteries.</p> <p><b>I.</b> Finger electrodes<br/>Place your right index finger over these when taking a measurement.</p> <p><b>J.</b> START button<br/>Starts measurement.</p> <p><b>K.</b> SD memory card slot cover<br/>Open this cover to insert the SD memory card.</p> |
|--------------------------------------------------------------------------------------------------------------------------------------------------------------------------------------------------------------------------------------------------------------------------------------------------------------------------------------------------------------------------------------------------------------------------------------------------------------------------------------------------------------------------------------------------------------------------------------------------------------------------------------------------------------------------|--------------------------------------------------------------------------------------------------------------------------------------------------------------------------------------------------------------------------------------------------------------------------------------------------------------------------------------------------------------------------------------------------------------------------------------------------|

## Replacements Parts



L. SD memory card

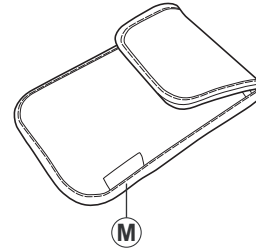

M. Storage pouch

EN

1. Know Your Unit

## Display

The screen is used to display the guidance screens and results of ECG readings, adjust settings, and manage ECG data stored on the SD memory card or in unit memory.

### Menus

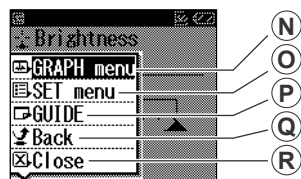

**Menu screen**

The main menu screen is displayed when you press the MENU button.



**Settings (SET menu) screen**

The setting menu screen is displayed when you select the SET menu and press the OK button.

- N. GRAPH menu  
This allows you to view ECG readings stored on the SD memory card or in unit memory. (p. 28)
- O. SET menu  
This allows you to set the date and time, and adjust other settings. (p. 30)
- P. GUIDE  
This displays the guidance screens that show you how to take a measurement.

- Q. Back  
This option takes you back to the previous screen, from the SET menu.
- R. Close  
This option closes the menu screen.



### ECG Graph

This screen is displayed when you use the GRAPH menu to select ECG data stored on the unit.

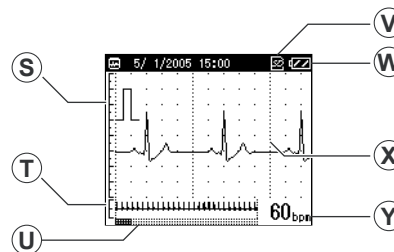

**S. Calibration guide**

Serves as a guide when your doctor analyses the stored ECG data.

**T. Full 30-second waveform**

**U. Measurement time indicator**

**V. SD memory card indicator**

Displayed when the SD memory card is in the card slot.

**W. Battery level indicator**

**X. ECG waveform**

**Y. Heart rate**

(\*bpm=beats per minute)

**Note:** During measurement, the screen displays the ECG waveform and the progress bar at the bottom of the screen displays measurement progress and a guide to the heart rate.

Depending on the waveform, situations can occur in which the device cannot assess and display the heart rate during the measurement.

## 2. Inserting and Replacing Batteries

1. Slide the battery cover in the direction of the arrow, and lift the end of the cover upwards.

**Note:** Do not pull too hard on the cover.

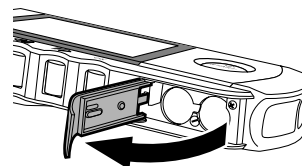
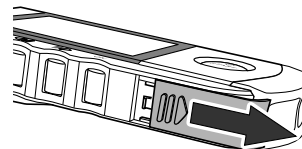

2. Insert two LR03 (AAA) batteries as indicated.

Always use LR03 (AAA) batteries.

**Note:** Make sure that the polarity of the batteries is correct.

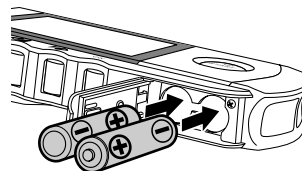

3. Close the battery cover.  
Lower the battery cover (1), then while gently pressing the cover down, slide it in the direction of the arrow (2).

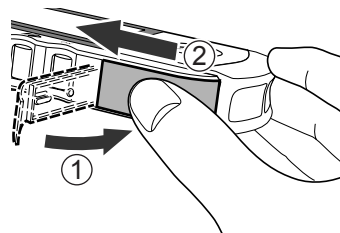



## Battery life and replacement

When the “Please insert new batteries.” message appears, replace both batteries with new ones.

- Always turn the unit off before replacing the batteries.
- Dispose of the used batteries according to applicable local regulations.

### Battery life

- Two new LR03 (AAA) batteries will last for approximately 400 measurements. (If measurements are taken once a day at room temperature (22 °C).)
- The batteries enclosed in the package are used for demonstration purpose. It is possible these batteries will therefore not last for 400 measurements.
- If the batteries are removed for more than one hour, the settings and any ECG data stored in the unit may be erased. If the date and time setting is erased, be sure to reset it before using the unit again. Any ECG data erased from the unit cannot be recovered.
- The battery life can be confirmed in the upper right of the display.

 Full power.	 Half remaining.	 Remaining power is low. Replace the batteries with new ones.
-----------------------------------------------------------------------------------------------	----------------------------------------------------------------------------------------------------	-----------------------------------------------------------------------------------------------------------------------------------------------------

### Warning!

If battery fluid should get in your eyes, immediately rinse with plenty of clean water. Consult a doctor immediately.

EN

### Caution!

- Do not use batteries not specified for this unit. Do not insert the batteries with the polarities in the wrong direction.
- Do not dispose of batteries in fire.
- If battery fluid should get on your skin or clothing, immediately rinse with plenty of clean water.

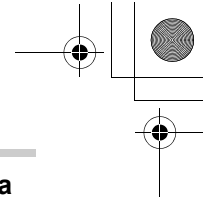
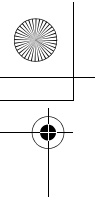

## 2. Inserting and Replacing Batteries

- **Remove the batteries from this unit when you are not going to use it for a long period of time (approximately three months or more).**
- **Do not use batteries of a different type together.**
- **Do not use new and used batteries together.**

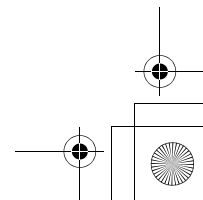
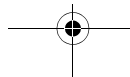
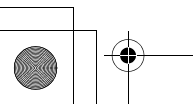
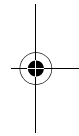
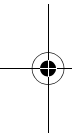



### 3. Setting the Date and Time

**Always set the date and time before using the unit for the first time.**

Check the date and time are correct before using the unit, reset them if necessary. The date and time are important indicators of when a measurement was taken.

**Note:** The date and time format can be changed to different territorial standards. ( Refer to “8.7 Date Format” on p. 36)



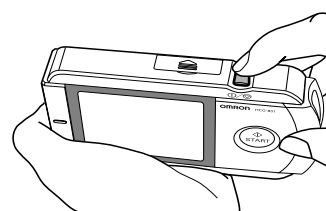



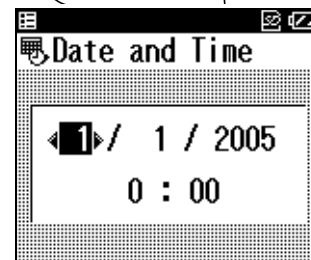

1. Press the  /  (Power/Cancel) button to turn the unit on.



When the unit is used for the first time, or if the Date and Time setting has been reset, the Date and Time setting screen is automatically displayed, and the day digits are highlighted.



EN

2. Press the  /  or  /  button to set the day.  
Press the  /  button to increase the number.  
Press the  /  button to decrease the number.

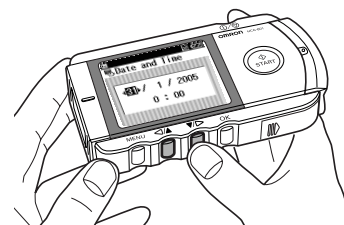

### 3. Setting the Date and Time

3. Press the OK button to confirm the day setting.

The day setting is set and the month setting is highlighted.

The display cycles through the settings, **day** -> **month** -> **year** -> **hour** -> **minute**, with each press of the OK button.

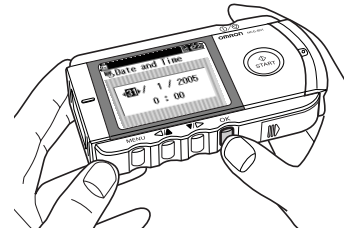

**Note:** If the setting for the date format has been changed (refer to “8.7 Date Format” on p. 36), the order in which items are highlighted may differ from the example above.

4. In the same way, press the ▼/▶ or ◀/▲ button to set the month, year, hour, and minute.

After you complete the date and time setting, the screen from step 1 appears.

Press the MENU button to return to the Menu screen at any time.

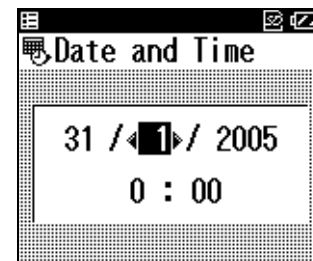

5. Press the Ⓚ/Ⓛ button for two seconds to turn off the power.

The unit beeps, then the power is turned off.

**Note:** If you forget to turn off the power, the unit will turn itself off automatically after five minutes.

Press for two seconds.

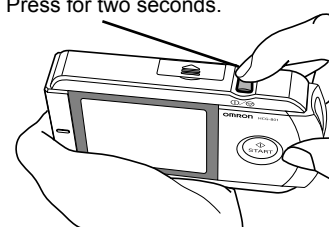

## 4. Using SD Memory Card

The unit includes an SD memory card for storing ECG data, which can then be viewed by your doctor later. This section describes how to insert and eject an SD memory card, and how to format a card so it can be used to store ECG data.

### Notes:

- If you need to purchase a new SD memory card, consult your Omron Customer Service Department (Tel. 0870-7502771).
- Do not store data other than ECG data from the unit on the card.

### 4.1 Inserting and Ejecting SD Memory Card

The SD (SD) mark is displayed in the top right corner of the screen while the SD memory card is inserted, and the unit is turned on.

#### Inserting the SD memory card

1. Check that the unit is turned off.

### Caution!

**Never insert an SD memory card while the unit is turned on.**

EN

#### 4. Using SD Memory Card

2. Open the SD memory card slot cover and insert the SD memory card into the slot.

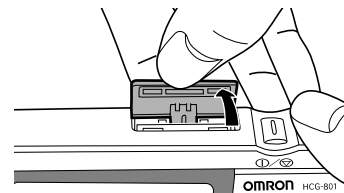

#### Notes:

- Check that the card is correctly aligned and insert it into the slot as shown.

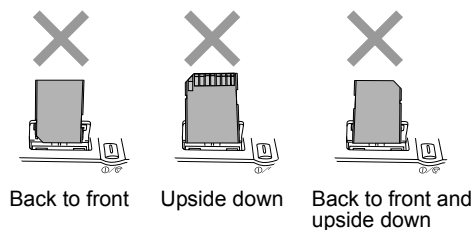
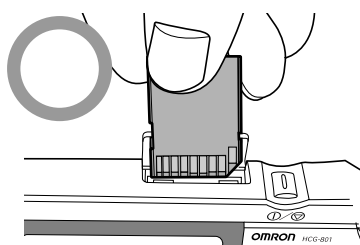

- Insert the card until it clicks into position.

#### **Write Protection (Locking the SD Memory Card)**

- Make sure that the write-protect switch is not locked, before inserting the SD memory card. If the write-protect switch is locked (down), you will not be able to store new ECG data on the SD memory card.

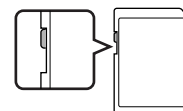

#### **Caution!**

**When inserting the SD memory card, do not try to force the card into the slot if it is upside down, back to front etc. This could damage the card or the unit itself.**



4. Using SD Memory Card

**3.** Close the SD memory card slot cover.

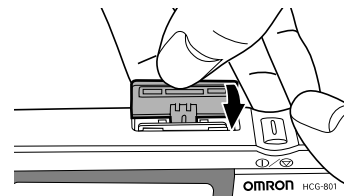

EN

#### 4. Using SD Memory Card

### To eject the SD memory card

1. Check that the device is turned off.

**Caution!**

**Only eject an SD memory card when the unit is turned off.**

2. Open the SD memory card slot cover and press the memory card.

The lock is released and the card is ejected slightly.

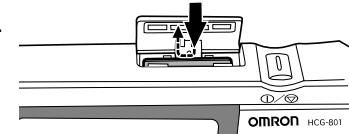

3. Remove the memory card.

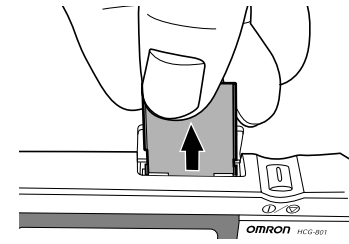

4. Close the SD memory card slot cover.

## 4.2 Formatting an SD Memory Card

You will need to format the SD memory card before you use it for the first time, and in the following circumstances.

- If you use an SD memory card that has been used by other devices.
- If a memory card error occurs.

### Notes:

- When you format an SD memory card, any data stored on the card is erased. Always copy any data you wish to keep to a computer before formatting an SD memory card.
- When you format an SD memory card, format it with the unit. Do not format an SD memory card with a computer.

1. Press the MENU button, press the  $\blacktriangledown/\blacktriangleright$  button to select **SET menu**, then press the OK button.



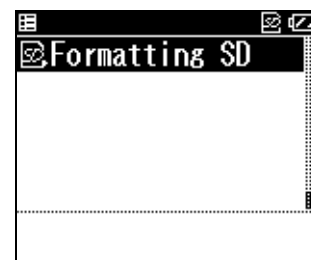

2. Press the  $\blacktriangledown/\blacktriangleright$  button to scroll through the settings and select **Formatting SD**.



#### 4. Using SD Memory Card

**3.** Press the OK button.

The message “All data in SD will be deleted. Format SD?” is displayed.

**4.** Press the / button to select **YES**, then press the OK button.

If you press the OK button while **NO** is selected, the SD memory card will not be formatted.

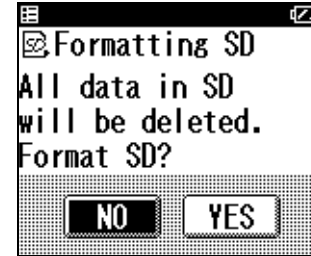

\* By default, **NO** is highlighted.

**5.** Press the OK button.

A message warning you not to remove the SD memory card while it is being formatted is displayed and the SD memory card is formatted.

Formatting can take up to eight seconds to complete.



**Caution!**

**Never remove an SD memory card while it is being formatted.**

## 5. Important Notes on Taking a Measurement

In order to obtain a good ECG reading, it is important that measurements are taken correctly.

Before taking a measurement for the first time, read these instructions carefully and make sure you observe the following points each time you take a measurement.

- Make sure that the electrodes are directly touching your skin.
- If your hands or skin are dry, wipe them with a damp towel so that they are slightly moist.
- If the electrodes are dirty, wipe any dirt off with a soft cloth moistened with disinfectant alcohol or a cotton swab.
  - Take care not to use too much disinfectant alcohol when cleaning the electrodes.
  - Do not wipe or get disinfectant alcohol on parts other than the electrodes.
- Do not move during measurement.
  - Movement, including talking, coughing, or sneezing, during measurement can affect the measurement results.
- If the position of your finger or arm is inappropriate during measurement, the results may be unreliable, so be sure to check their position before taking a measurement. (Refer to p. 22 and p. 23.)
- After taking a measurement, disinfect the electrodes by wiping them with a soft cloth or cotton swab moistened with disinfectant alcohol. If you do not disinfect the electrodes there is a risk of skin disease.

**Note:** If you have problems applying the unit so that the chest electrode is flat against your chest, please ask your doctor for advice.

EN

## 6. Taking a Measurement

1. Press the  button to turn the unit on.

The unit displays a reminder that self-measurement is not the same as medical diagnosis and then the guidance screens are displayed. (The guidance screens are displayed twice.)

**Note:** You can press the START button to begin a measurement even while the guidance screens are being displayed.

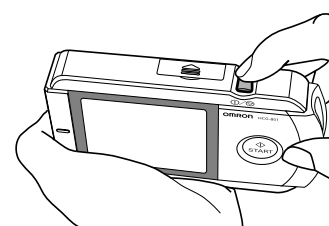

2. Make sure that you are in a relaxed position.

The ideal posture is one where you are seated comfortably with your back straight.

**Note:** You can also take a measurement while you are standing or while lying down.

3. Place your finger so that it fits closely over the two finger electrodes.

Fit finger closely on the electrodes.

**Notes:**

- Even if you are left-handed, use your right hand to take a measurement.
- Take care not to press the START button until you are ready to take the measurement.

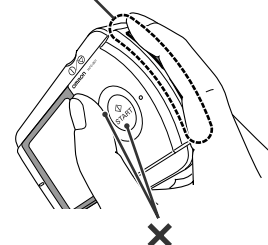

Do not press START button until ready to take measurement.

**4.** Place the chest electrode on bare skin about 5 cm below your left nipple.

**Notes:**

- Make sure that you are relaxed and that your chest is free of tension.
- Press the chest electrode close against your bare chest. Do not place the electrode on clothing as this will result in an inaccurate measurement.

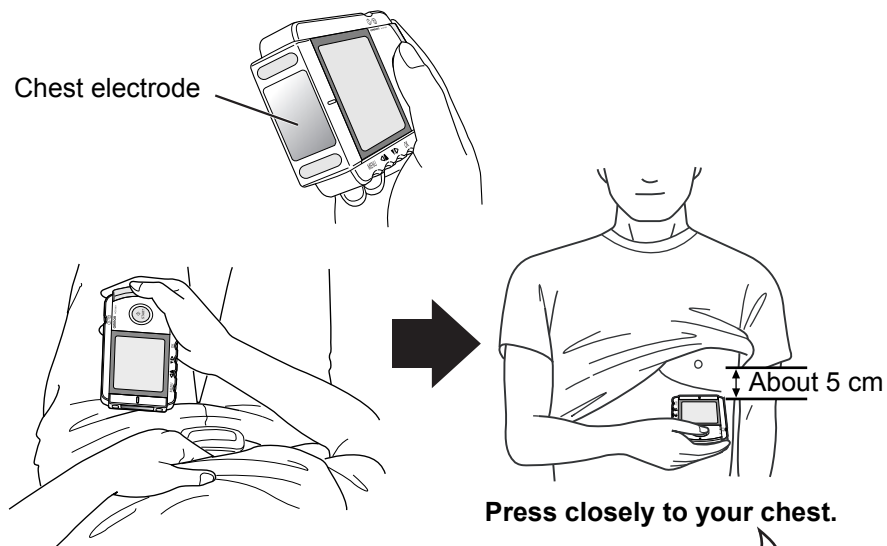

EN

**Female:**

Locate the ECG monitor at the lower end of the breastbone and move horizontally to the left to the middle of the left part of the chest. If necessary, gently lift the breast and place the Chest Electrode under the left breast. Unless the chest electrode comes in contact with the brassiere, it is not necessary to remove it; if you are unsure **please consult your doctor.**

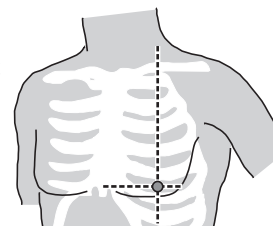

6. Taking a Measurement

5. While maintaining the same posture, press the START button.

Measurement starts

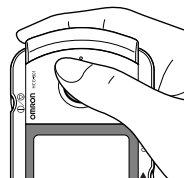

During measurement

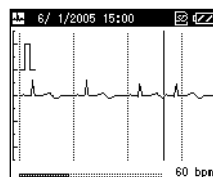

Measurement ends

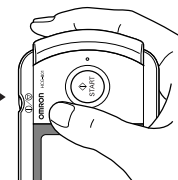

The measurement ends automatically, indicated by 4 rapid beeps.

The measurement takes about 30 seconds to complete. The unit beeps every second during measurement.

During measurement, the screen displays the ECG waveform and the progress bar at the bottom of the screen displays measurement progress and a guide to the heart rate.

Depending on the waveform, situations can occur in which the device cannot assess and display the heart rate during the measurement.

**Notes:**

- During measurement the device will only respond to the  button to discontinue the measurement.
- If the contact of the electrodes becomes loose, or the conditions change during measurement, the measurement may not be correct.

**Important: Keep still and do not move until the measurement is complete.**



## 6. Taking a Measurement

A measurement result message is displayed when the measurement has been completed. (Refer to p. 27 for details.)

If you press the OK button while the result message is displayed, the list of ECG data stored on the SD memory card or unit is displayed.

**Note:** If the “Please insert new batteries.” error message is displayed immediately after measurement, the ECG data may not be stored. If this happens, please repeat the measurement after replacing the batteries.



Example result message

6. Press the  button for two seconds, to turn the unit off.

The unit beeps, then the power is turned off.

**Note:** If you forget to turn the unit off, it will automatically shut itself off after five minutes.

## 6. Taking a Measurement

### **Common Causes of Inaccurate Measurement Results**

The following situations can result in inaccurate measurement results or errors.

- The index finger is not placed closely on the electrode.

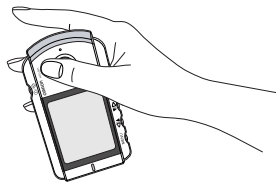

- The unit is held incorrectly.

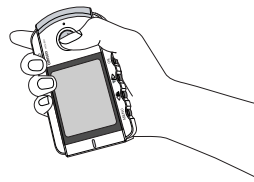

- The unit is being held in the left hand. Always use your right hand to hold the unit when taking a measurement.

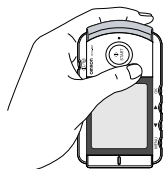

- Unit placed on clothing.

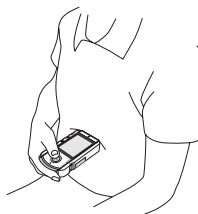

- The rear of the unit is placed against the chest.



- The chest electrode is against the finger and the finger electrode is against the chest.

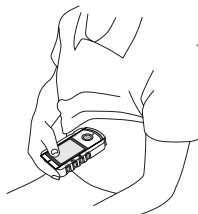

**Measurement Result**

**There are 13 messages regarding the measurement result.**

A letter of the alphabet indicates each of the 13 possible messages. This letter is displayed together with the time and date of the measurement when the **GRAPH menu** is displayed.

**Important: Do not interpret measurement results yourself, consult your doctor.**

a	Stable waveform.
b	Fast heart rate.
c	Fast and irregular heart rate.
d	Fast heart rate and deviating waveform.
e	Fast and irregular heart rate, deviating waveform.
f	Slow heart rate.
g	Slow and irregular heart rate.
h	Slow heart rate and deviating waveform.
i	Slow and irregular heart rate, deviating waveform.
j	Irregular heart rate.
k	Irregular heart rate and deviating waveform.
l	Deviating waveform.
m	Analysis impossible. Please measure again.

**Recommendation on measurement result**

In addition to the above messages the device will display the heart rate in beats per minute. Finally, the device will display one of the following messages:

EN

**Store data? Yes/No**

This message will be displayed when the unit can find none or only slight deviations from normal. This data can be saved by selecting **Yes** and pressing the OK button.

**Data is stored.**

This message will be displayed when the unit can find moderate deviation from normal. The unit will automatically store the data for future analysis by your doctor.

**Data is stored. Please show your Dr.**

This message will be displayed when the unit can find significant deviation from normal. The unit will automatically store the data for future analysis by your doctor.

## 7. Displaying ECG Data

The **GRAPH menu** is used to display the list of ECG data stored on the SD memory card or in unit memory.

1. Press the MENU button while the unit is turned on, the **GRAPH menu** is highlighted. If you then press the OK button, the list of ECG data is displayed.

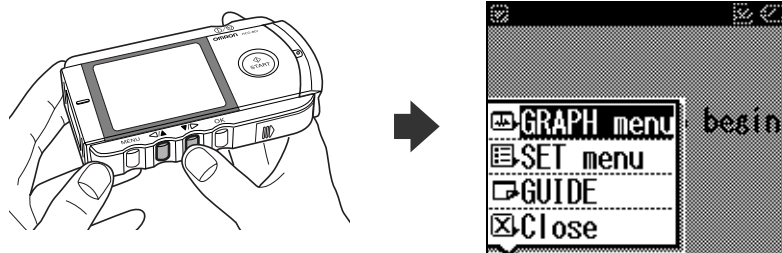

2. Select the ECG data you wish to view from the **GRAPH menu** list, then press the OK button to display the detailed view of the waveform.

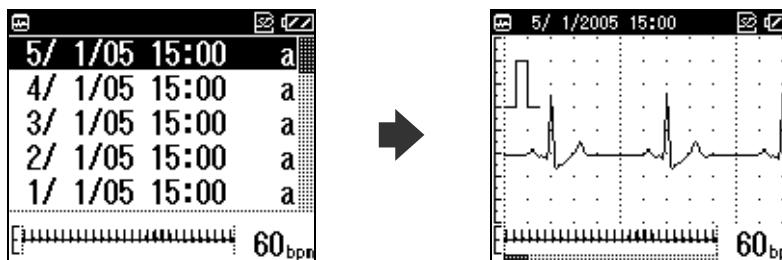

Each stored ECG data is displayed by date, time and a character representing the measurement result, refer to p. 27 for the overview of character and measurement result.

Press the  $\blacktriangledown/\triangleright$  button to move down the list, and the  $\triangleleft/\blacktriangle$  button to move up. The most recent measurement result is displayed at the top of the list and is automatically highlighted, with any previous measurement results listed below it in chronological order.

When the SD memory card is in the SD memory card slot, the list of ECG data stored on the card is displayed.

If there is no SD memory card in the card slot, the ECG data stored in unit memory is displayed.

3. If you press the  $\blacktriangledown/\triangleright$  button, you can scroll through the ECG waveform.

Press the  $\triangleleft/\blacktriangle$  button to return to the previous waveform display.

Two waveforms are displayed (the lower, smaller, waveform being a view of the whole 30-second measurement.)

At the bottom of the screen is a bar indicating the progress of the measurement. The current heart rate is shown in the lower right corner of the screen.

The shaded area in the progress bar indicates the section of the ECG waveform being displayed.

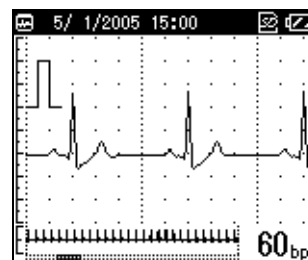

4. Press the OK button again to view the measurement comments and heart rate.

**Note:** You can specify whether a result message is displayed or not. (Refer to p. 37 for details.)

5. Press the OK button once more to return to the **GRAPH** menu list.

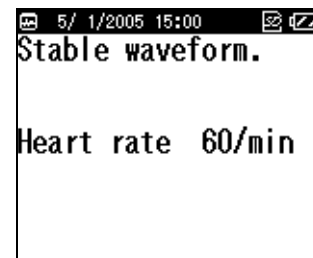

EN

## 8. Adjusting the Settings

You can use the **SET menu** to adjust various settings.

You can press the START button to begin measurement even while the **SET menu** is displayed.

### 8.1 Basic Operation

The following procedure describes how to select and adjust a setting. Refer to the following pages for details of the options available for each setting.

1. Press the MENU button, while the unit is on, to display the menu screen.



\* Initially, **GRAPH menu** is highlighted.

2. Press the **▼/▶** button to select **SET menu**.

3. Press the OK button.

Initially, the Date and Time setting is highlighted.

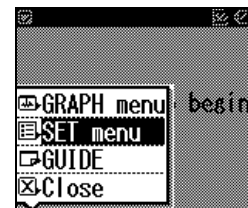

4. Press the ◀/▲ or ▼/▶ button to select the desired setting, then press the OK button to see the options for that setting.



5. Adjust the settings then press the OK button to confirm the changes.

The **SET menu** can be used to adjust the following settings or manage ECG data stored on the SD memory card or unit:

Date and Time, Volume, Brightness, Contrast, Language, Date Format, Message, Overwrite, Erase all data, Data copy to SD, Formatting SD.

**Notes:**

Refer to “9. Managing ECG Data” on p. 39 for details on **Erase all data** and **Data copy to SD**.

Refer to “4. Using SD Memory Card” on p. 15 for details on **Formatting SD**.

- To return to the menu screen from the **SET menu** screens, press the MENU button. To return to the previous screen, highlight **Back**, then press the OK button or MENU button.
- If you press the MENU button without first pressing the OK button, after making the changes to a setting, the changes to the setting will not be implemented.

## 8. Adjusting the Settings

### 8.2 Date and Time

Select this item if you need to reset the date and time for some reason. For details on setting the date and time, refer to p. 13.

**Note:** You will be prompted to set the date and time when you first insert the batteries.

### 8.3 Volume



The current volume level is displayed at the bottom of the screen.

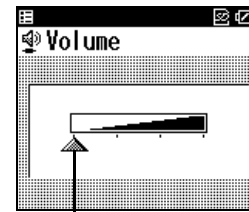

The  mark indicates the volume level.

\* The default setting is the maximum volume level.

Press the /  button or /  button to adjust the volume.

The volume increases as the  mark moves to the right.

The sound is muted (off) when the  mark is to the far left.



## 8.4 Brightness





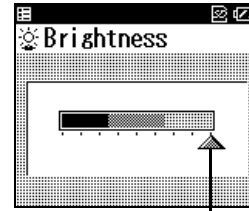

The current brightness level is displayed at the bottom of the screen.



The  mark indicates the brightness level.

\* The default setting is the maximum brightness level.

Press the / button or / button, to adjust the brightness.

The brightness can be set to one of nine levels.

The brightness increases as the  marker moves to the right.

8. Adjusting the Settings

### 8.5 Contrast



The current contrast level is displayed at the bottom of the screen.

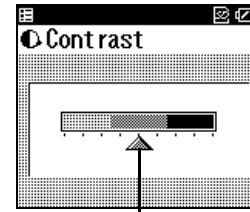

The  mark indicates the contrast level.

\* The default setting is medium contrast level.

Press the /▲ button or ▼/▶ button to adjust the contrast.

The contrast can be set to one of nine levels.

The contrast increases as the  marker moves to the right.

## 8.6 Language

This setting specifies the language to be used for the screen display.

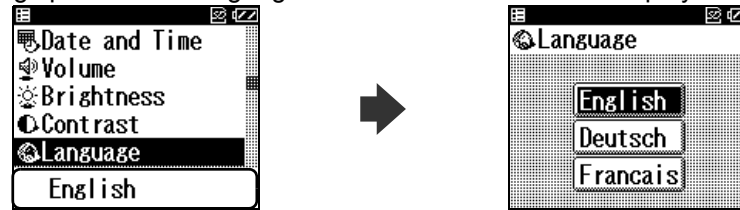

The currently selected language is displayed at the bottom of the screen.

\* The default language is **English**.

Press the ◀/▲ button or ▼/▶ button to select the desired language, then press the OK button to confirm your selection.

## 8. Adjusting the Settings

### 8.7 Date Format

You can select one of four formats, DD/MM/YY HH:MM (24 hour clock), DD/MM/YY HH:MM (AM/PM), MM-DD-YY HH:MM (AM/PM), or YY/MM/DD HH/MM (AM/PM).

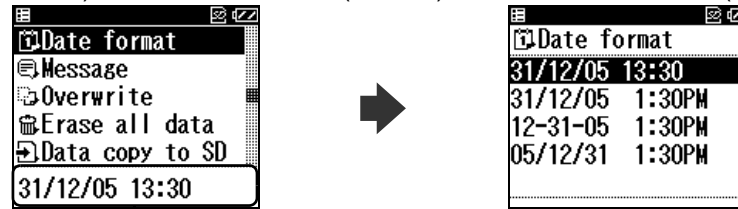

The date is displayed at the bottom of the screen using the currently selected format.

\* The default date format is DD/MM/YY HH:MM (24 hour clock).

Press the  $\triangleleft/\blacktriangle$  button or  $\blacktriangledown/\triangleright$  button to select the desired format, then press the OK button to confirm your selection.

## 8.8 Messages

This setting specifies whether to display or hide the message that appears after a measurement has been completed.

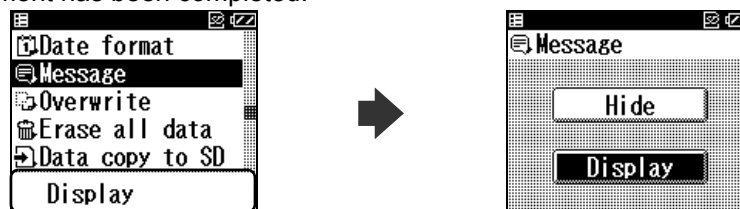

The current setting is displayed at the bottom of the screen.

\* The default setting is **Display**.

1. Press the  $\triangleleft/\blacktriangle$  button or  $\blacktriangledown/\triangleright$  button to highlight the **Display** or **Hide**, then press the OK button to confirm your selection.

**Note:** Even if **Hide** is selected, results messages are saved by the unit.

EN

## 8. Adjusting the Settings

**8.9 Overwrite**

The unit will overwrite the oldest stored reading when the SD memory card or unit memory is full. A message will warn that this will happen, you can choose to hide or display this message. (The default setting is to hide the message.)

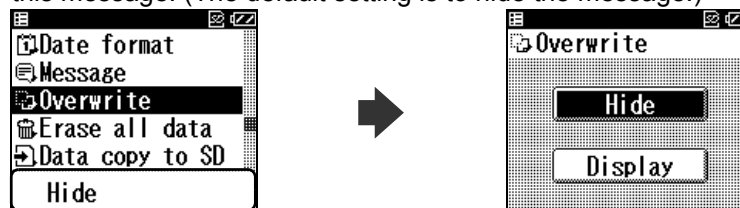

The current setting is displayed at the bottom of the screen.

1. Press the ◀/▲ button or ▼/▶ button to highlight **Display** or **Hide**, then press the OK button to confirm your selection.

**Caution!**

While **Hide** is selected, the unit will overwrite (erase and replace) the oldest measurement data with the results of the new measurement without displaying a message, when the SD memory card or unit memory are full.

**About the Overwrite message**

If you select **Display**, the unit will display a message before you take a measurement, asking if you want to overwrite existing data with the new measurement data.

Select **Yes** to overwrite the oldest ECG data with the results of the new measurement.

If you select **No**, measurement is cancelled.

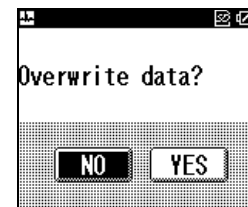

## 9. Managing ECG Data

### 9.1 Erasing ECG Data

#### Erasing All ECG Data

You can use the **SET menu** to erase all the ECG data stored on the SD memory card or in unit memory.

**Note:** If an SD memory card is inserted in the unit, all data on the card will be erased.

1. Press the **▼/▶** button to scroll through the settings and select **Erase all data**.



2. Press the OK button.

The message “**Erase all data in SD memory?**” is displayed.

**Note:** If the SD memory card is not inserted and measurements are being stored in unit memory, the message “**Erase all data in the device?**” is displayed.



EN

\* By default, **NO** is highlighted.

### 9. Managing ECG Data

3. Press the **▼/▷** button and select **YES**, then press the OK button.

The number of sets of data to be deleted is displayed.

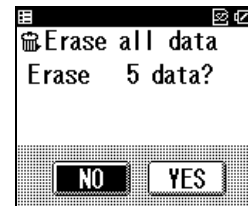

4. Press the **▼/▷** button and select **YES**, then press the OK button.

All the ECG data is erased and the screen from step 1 appears.

**Note:** If you press the OK button after selecting **NO**, the screen from step 1 appears.

### Erasing Selected ECG Data

Use the **GRAPH menu** if you only want to delete a selected set of ECG data.

For details on displaying the **GRAPH menu**, follow step 1 in “7. Displaying ECG Data” on p. 28.

1. Press the **▼/▷** button to highlight the data you want to erase.

2. Press the MENU button.

The menu screen is displayed.

3. Press the **▼/▷** button and select **Erase data**.

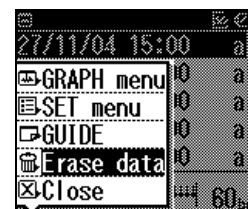



**4.** Press the OK button.

The confirmation message “**Erase selected data?**” is displayed.

**5.** Press the  button and select **YES**, then press the OK button.

The ECG data is erased and the screen from step 1 appears.



\* By default, **NO** is highlighted.

**Note:** If you press the OK button after selecting **NO**, the screen from step 1 appears.

**Important:** Never remove an SD memory card while data is being erased.

## 9. Managing ECG Data

### 9.2 Copying Data to an SD Memory Card

You can copy ECG data from the unit's internal memory to an SD memory card. This allows you to copy data to the SD memory card if measurements have been taken while the SD memory card was not inserted.

**Note:** The unit's internal memory can only store a maximum of five measurement results.

1. Press the  button and select **Data copy to SD**.



2. Press the OK button.  
The conformation message **"Copy data into SD?"** is displayed.

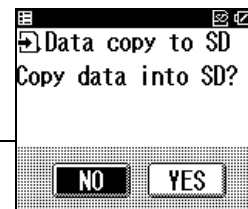

3. Press the  button to select **YES**.

**Notes:**

- If the SD memory card is full, the **"Overwrite data"** message may appear. Refer to p. 38 for details.
- ECG data stored on an SD memory card can be damaged by static electricity and other causes. Copy data to PC or other device for additional safety.

\* By default, **NO** is highlighted.

**4.** Press the OK button.

The ECG data is copied to the SD memory card.

**Caution!**

**Never remove the SD memory card while data is being copied to it. If the SD memory card is removed while data is being copied, the data may be lost or damaged.**



**Notes:**

- The copied data is displayed and the screen from step 1 appears.
- If the same ECG data already exists on the SD memory card, the data is not copied.

9. Managing ECG Data

### 9.3 Copying data from the SD memory card to a PC

#### Copying data from the SD memory card to a PC

Please follow these instructions to copy data from the SD memory card to a PC.

1. Make sure the PC is equipped with an SD memory card port or connect a commercially available SD memory card reader/writer to your PC.
2. Create a new folder on your PC where you want to save a copy of the ECG data.
3. Insert the SD memory card and browse to the SD memory card data as explained in the instruction manual of your PC and /or software. The ECG data is located in the \*:\hcg801\data\ folder (where \* stands for the character of a removable disk).
4. Select all files and copy them in the folder you have created earlier (2).
5. When copying is finished, remove the SD memory card.
6. The SD memory card can now be formatted as described in “4.2 Formatting an SD Memory Card” on p. 19, if you wish to delete the data.

### Copying data from a PC to the SD memory card

Please follow these instructions to copy data from a PC to the SD memory card.

1. Make sure the PC is equipped with an SD memory card port or connect a commercially available SD memory card reader/writer to your PC.
2. Insert the SD memory card in the SD port of your PC and confirm that there is an "hcg801" folder in the SD memory card. If there is not, format the SD memory card in the HCG-801 as described in section 4.2 of the HCG-801 instruction manual.
3. Browse to the folder where you saved the ECG data in the PC. Select all files and copy them to the SD memory card in the \*:\hcg801\data\ folder (where \* stands for the character of a removable disk)
4. When copying is finished, insert the SD memory card in the HCG-801 as described in "4.1 Inserting and Ejecting SD Memory Card" on p. 15.
5. Do not store more than 300 measurement files in this folder on the SD memory card. When more than 300 files are copied in this folder, the HCG-801 will display an error message when activated.

**EN**

## 10. Care and Maintenance

### 10.1 Lists and Explanations of Messages

This section includes a list of all messages that may appear on the display. Refer to these if you are not sure what a displayed message means.

#### Notice Messages

Message	Description	Action
Analysing.	The ECG data is being analysed.	No action required. Wait until analysis ends.
Can not measure. Please follow the instructions for use.	A ECG wave-pattern could not be detected.	Check the instructions and repeat measurement.
Measurement was stopped. Push START to begin measurement again.	The measurement was interrupted or cancelled.	Press START to resume the measurement.
Copied <input type="checkbox"/> <sup>1</sup> data into SD.	The indicated number of ECG data has been copied to an SD memory card.	No action required. Wait until the message disappears.
Erased <input type="checkbox"/> <sup>2</sup> data.	The indicated number of ECG data has been erased.	

\*1: Number of readings from 0 to 5. The number displayed represents the amount of copied ECG data.

\*2: Number of readings from 1 to 300. The number displayed represents the amount of erased ECG data.

## Warning Messages

Message	Cause	Remedy
Formatting SD memory. DO NOT REMOVE SD	The SD memory card is being formatted.	Wait until the message disappears. Do not remove the SD memory card until formatting has been completed.
Storing on SD memory. DO NOT REMOVE SD	ECG data is being written (saved) to the SD memory card.	Wait until the message disappears. Do not remove the SD memory card until data storage has been completed.
Copying SD memory. DO NOT REMOVE SD	ECG data is being copied to the SD memory card.	Wait until the message disappears. Do not remove the SD memory card until data copying has been completed.
Data in device memory is being erased.	ECG data stored on the unit is being erased.	Wait until the message disappears.
Data in SD is being erased. DO NOT REMOVE SD until erasing finishes.	ECG data stored on the SD memory card is being erased.	Wait until the message disappears. Do not remove the SD memory card until data erasing has been completed.
Reading data... DO NOT REMOVE SD.	The unit is loading ECG data stored on the SD memory card.	Wait until the message disappears. Do not remove the SD memory card until the data has been loaded by the unit.
No SD is inserted.	There is no SD memory card in the card slot.	Turn off the power and insert the SD memory card. Never insert the SD memory card while the power is turned on.

EN

10. Care and Maintenance

Message	Cause	Remedy
SD is write-protected.	The unit is unable to access data because the SD memory card inserted is write-protected.	Refer to the instruction supplied with the memory card and insert the SD memory card with write-protection turned off.
No saved data.	The battery power has run low and the ECG data stored on the unit has disappeared.	Insert new batteries and reset the Date and Time and other settings. Any ECG data that was stored on the unit cannot be recovered.
Set clock.	The battery power has run low and the Date and Time setting on the unit has disappeared.	Insert new batteries and reset the Date and Time from the <b>SET menu</b> .
No saved data. Set clock.	The battery power has run low and the ECG data stored on the unit has disappeared or the clock has been reset.	Insert new batteries and reset the Date and Time and other settings.

**Error Messages**

Error #	Message	Cause	Remedy
01	Please insert new batteries.	The batteries are worn out.	Replace both batteries with new ones.
11	Device memory error Cannot read data.	An error occurred while trying to read ECG data stored in unit memory.	Try again. If the error still occurs, consult your OMRON service representative.
12	Device memory error Cannot erase data.	An error occurred while trying to erase ECG data stored in unit memory.	
13	Device memory error Cannot write data.	An error occurred while trying to save ECG data to unit memory.	



Error #	Message	Cause	Remedy
21	SD memory error Cannot read data.	An error occurred while trying to read ECG data stored on the SD memory card.	Format the SD memory card. Refer to p. 19. *Copy any important data to a PC before formatting the SD memory card as all data on the card will be erased.
22	SD memory error Cannot erase data.	An error occurred while trying to erase ECG data stored on the SD memory card.	Use a new/different SD memory card. (Always turn off the unit before removing or inserting SD memory cards.)
23	SD memory error Cannot write data.	An error occurred while trying to save ECG data on the SD memory card.	
24	Error formatting SD memory.	An error occurred when formatting the SD memory card.	
25	SD memory error. SD memory unknown.	The SD memory card may be damaged.	Format the SD memory card. Refer to p. 19. *Copy any important data to a PC before formatting the SD memory card as all data on the card will be erased. Use a new/different SD memory card. (Always turn off the unit before removing or inserting SD memory cards.)
26	SD memory full. Please delete unnecessary data.	The SD memory card is full and there is not enough space to save new ECG data.	Either delete unnecessary data or use a new SD memory card. (Always turn off the unit before removing or inserting SD memory cards.)
27	The number of data in SD is over the limit. Please delete unnecessary data.	The SD memory card is full and there is not enough space to save new ECG data.	
91	Device error.	The unit may have been damaged or is otherwise unable to operate normally.	Turn the unit off, then on again. If this error still occurs, consult your Omron Customer Service Department (Tel. 0870-7502771).

EN

## 10. Care and Maintenance

**10.2 Troubleshooting**

Refer to this table for problems that do not result in a message on the display.

Problem	Cause	Solution
Nothing happens when you press the  button.	The batteries are worn out. The batteries are inserted incorrectly.	Replace both batteries with new ones. Insert the batteries with their polarities correctly aligned.
Measurement starts but the message "Analysis impossible. Please measure again." appears.	The measurement data could not be analysed.	Check the instructions and repeat measurement.
Measurement finishes but no result is shown.	The electrodes are not making good contact with your finger or chest.	Check the instructions and repeat measurement.
	Your body is too tense.	Relax and repeat the measurement.
	Electrode contact was broken before 30 seconds of data has been recorded.	Make sure that your finger and chest maintain contact with the electrodes for the full 30 seconds of the measurement.
	The chest electrode has been applied over clothing.	Apply the chest electrode to bare skin.
	Your skin is dry.	Moisten your skin with a damp towel.
	The ECG signal is too weak.	Make sure that the electrodes are applied correctly. However, for some individuals measurement may not be possible.

10. Care and Maintenance

Problem	Cause	Solution
ECG data has disappeared.	The batteries are worn out or have been removed for over one hour.	The unit will not be able to store data if left with worn batteries for an extended period. Replace the batteries with new ones as soon as possible after the warning message appears.
ECG data has disappeared from an SD memory card.	The card was exposed to a strong electromagnetic field, electric noise or static, damaging the data stored on the card. Or the card is defective.	Erased data cannot be recovered. Format the SD memory card again.
Other problems		Turn off the unit and try again. If the data and time or other settings have been reset to their default values, set them again.

If the problem still occurs, consult your Omron Customer Service Department (Tel. 0870-7502771)

EN

## 11. Maintenance and Storage

- Clean the unit with a cloth lightly dampened with water, disinfectant alcohol or detergent, then wipe it dry with a dry cloth. Do not wipe the SD memory card slot cover.
- Wipe the electrodes using a cloth dampened with disinfectant alcohol.
- Do not wipe the unit with benzene, gasoline, paint thinner, concentrated alcohol, or other volatile detergents.
- Do not place objects on top of the unit. This could damage the unit.
- Do not disassemble the unit. There are no user serviceable parts. Repairs should only be carried out by authorized personnel.
- Do not sterilise this unit in an autoclave, ultraviolet steriliser or gas steriliser (EOG, formaldehyde, high density ozone etc.)
- This device does not require calibration during the expected life cycle of five years.

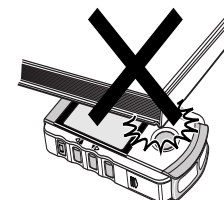
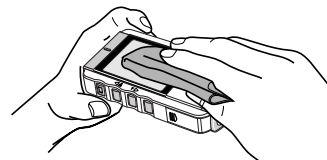

## 12. Technical Data

<b>Model</b>	HCG-801
<b>Induction system</b>	Bipolar single channel
<b>Heart rate range</b>	2 to 200 beats/min.
<b>Accuracy</b>	Bandwidth: 0.05 to 40Hz Sampling Rate: 125Hz
<b>Enclosure ingress protection</b>	IP20
<b>Display</b>	Graphic LCD
<b>Memory</b>	5 measurements (using the unit's internal memory) 300 measurements (using the supplied SD memory card)
<b>Electrical Safety</b>	Internally powered equipment, BF-type device
<b>Power Supply</b>	2 LR03 (AAA) batteries
<b>Battery life</b>	Approximately 400 measurements with alkaline batteries (When measurements are taken once a day at room temperature (22 °C).)
<b>Operating Temperature and Humidity</b>	+10 to +40 °C 30 to 85%RH
<b>Storage Temperature and Humidity</b>	-20 to +60 °C 10 to 95%RH
<b>Weight</b>	Approximately 130g (including batteries)
<b>Dimensions</b>	121 mm (W) × 67 mm (H) × 24 mm (D)
<b>Attachments</b>	Batteries 2 × LR03(AAA), SD memory card, Storage pouch, Instruction manual, Quick reference card, Registration card, Guarantee card.

**Note:** Specifications may be changed without prior notice.

- Disposal of this product and used batteries should be carried out in accordance with the national regulations for the disposal of electronic products.



= Type BF

CE 0197



EN

- This device supports SDA standard SD memory cards.
- OMRON Healthcare Inc. is a member of the SD Card Association.
- Uses bitmap font from Ricoh Co., Ltd.
- The SD logo is a registered trademark.
- This unit confirms to EMC Standard IEC 60601-1-2: 2001



### 13. General Information About the Heart and ECG Measurements

The heart is a muscular pump controlled by electrical impulses generated by the body. It is divided into two by the septa and each side has two chambers – an atrium and a ventricle – linked by a one-way valve. The left atrium and ventricle control oxygenated blood, and the right atrium and ventricle de-oxygenated (“used”) blood.

The electrical impulse that causes the heart to beat spreads across the atria, causing the left and right atrium to contract and pump blood into the left and right ventricles respectively. The two ventricles then contract and pump blood out of the heart. The heart muscle then relaxes, or re-polarises, allowing blood to fill up the heart again.

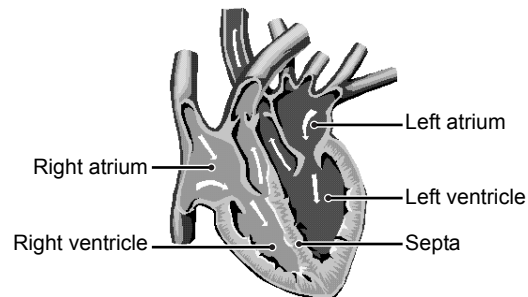

An ECG monitor is able to measure the electrical impulse as it passes across and through the heart, causing the heart to beat. An ECG does not measure the movement of your heartbeat, but rather the electrical activity that causes the heart to beat. The measurements recorded by an ECG monitor, when combined with a medical examination, can help your doctor monitor your heart condition. The ECG measurements recorded by the unit are NOT designed or intended for medical diagnosis. Conditions such as arrhythmia and Ischemia can only be diagnosed by a doctor through a special examination.

### About the ECG Waveform

The ECG waveform shows the rhythm of your heartbeat during the 30-second measurement and displays the electrical activity causing the heart to beat. The waveform for each heartbeat shows the progress of the electrical impulse across and through the heart.

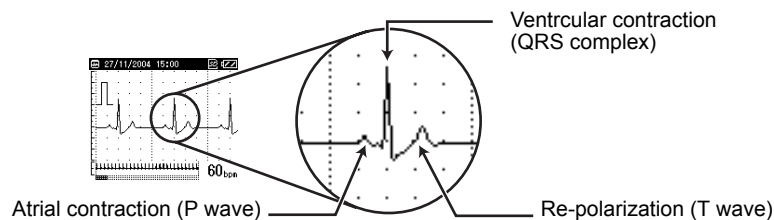

The first peak indicates the spread of the impulse over the atria and the beginning of their contraction. This is known as the P wave. The second peak indicates the spread of the impulse over the ventricles and the beginning of their contraction. This is known as the QRS complex. The third peak indicates the activity as the heart relaxes (re-polarization), and is known as the T wave.

### What is Arrhythmia?

Arrhythmia is a condition where the heartbeat rhythm is abnormal due to flaws in the bio-electrical system that drives the heartbeat. Typical symptoms are skipped heartbeats, premature contraction, an abnormally rapid (tachycardia) or slow (bradycardia) pulse. This can be caused by heart disease, ageing, physical predisposition, stress, lack of sleep, fatigue etc.

Arrhythmia can only be diagnosed by a doctor through a special examination.

### What is Ischemia?

Ischemia is a condition in which insufficient oxygen is supplied to parts of the heart or other parts of the body. This is usually due to a blockage or partial blockage of an artery.

Ischemia can only be diagnosed by a doctor through a special examination.

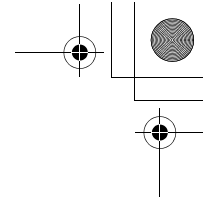
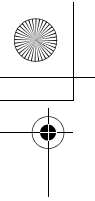

Customer services:

**OMRON HEALTHCARE UK LTD.**

Opal Drive  
Fox Milne, Milton Keynes MK 15 0DG  
United Kingdom  
**Omron Customer Service Department**  
Tel. 0870-7502771

**OMRON Medizintechnik**

**Handelsgesellschaft m.b.H.**  
Windeckstraße 81a D-68163 Mannheim  
Germany

**OMRON SANTÉ FRANCE**

14, rue de Lisbonne  
F-93561 Rosny-sous-Bois Cedex  
France

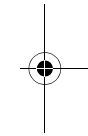
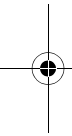

Manufacturer:

**OMRON HEALTHCARE CO., LTD.**

24, Yamanouchi Yamanoshita-cho, Ukyo-ku, Kyoto, 615-0084  
Japan



EU-representative:

**OMRON HEALTHCARE EUROPE BV**

Kruisweg 577  
2132 NA Hoofddorp  
The Netherlands



[www.omron-healthcare.com](http://www.omron-healthcare.com)

IM-HCG-801-1-04/05  
1647415-5A

