

The New Video Tardis



***Model CCT772 Video Tardis DVR &
Model CCT771 with built-in LCD screen***



***Digital Recording and Remote Monitoring
for up to 4 Cameras.
PTZ support and Internet connectivity.***

CONTENTS

Description	Page number
Contents	02
Operation Precautions	03
Accessories Checklist	03
Product Specifications	04
Product Features	04
Hard Disk Installation	06
CCT772 Front Panel Layout	07
CCT771 Front Panel Layout	08
Mouse Operation	09
Rear Panel Layout	10
25 Pin Alarm Transfer Box connections	11
System Operation	12
System Menu Structure	13
Recording Operation	14
Mouse and panel operation	16
Menu Option Schedule	17
System Operation Record Control	21
System Operation Record Playback	22
Playback Bar	23
Menu Operation	24
Network Connection	34
Network Operation - Web Browser	37
Backing Up Files	51
Playback of CR-ROM	52
Setting Up the Client Software	53
Frequently Asked Questions	55
Appendix A – Recording Times	56

Operation Precautions

- | All the safety and operating instructions should be read before the DVRs is operated.
- | All the safety and operating instructions should be retained for future reference.
- | Ensure all operating instruction and warning notes are complied with at all times.
- | Do not use strong or abrasive detergents when cleaning the DVRs.
- | There are no user-serviceable parts inside. Please contact a qualified engineer for servicing
- | Do not expose the DVRs to water or moisture and do not try to operate it in wet areas.
- | Please make sure that both ends of the power lead are plugged in.
- | Do not drop foreign objects through the DVRs case or expose it to moisture.
- | Do not attempt to disassemble the DVRs, other than to fit the Hard Drives.
- | Contact a qualified engineer if the following situation happens:
 - ÿ The power lead or plug is damaged.
 - ÿ The DVRs has been exposed to rain or water.
 - ÿ The DVRs does not operate normally by following the operating instructions.
 - ÿ The DVRs is dropped or its cover is damaged.
- | When replacement parts are required, make sure that the service engineer has used replacement parts specified by System Q Ltd or that these parts have the same characteristics as the original ones. Unauthorised substitutions may result in fire, electric shock or other hazards.
- | Never push objects of any kind into the case of the Tardis as they may touch dangerous voltage points or short out parts that could result in a fire or electric shock.
- | If an outside cable system is connected to the Tardis, be sure that the cable system is grounded so as to provide some protection against voltage surges and built-in static charges. It is recommended that this unit is connected to a power surge protection unit.
- | All normal precautions to avoid component damage due to electrostatic discharge should be taken during installation and operation.
- | To prevent electric shock, do not remove screws or the unit's cover with the power connected.
- | Do not cover the ventilation fan

Accessories Check List

1. One Power Cable
2. One HDD Data Cable
3. One Standard Cat 5 Network Patch Lead (Not a crossover lead)
4. One Packet Of Installation Fixings
5. One CD For Installation of the Client software and the Player
6. One User Manual
7. One USB Mouse

Product Features And Specifications

Product Specifications

Parameter	4 Channel
Operation system	Real-time operation system PSOS
Models	CCT770/CCT771 DVR – The Video Tardis
Video input	4 Channels (NTSC/PAL) BNC 1.0V _{P-P} 75Ω
Video output	2 Channels PAL/NTSC BNC 1.0V _{P-P} 75Ω and 1 Channel VGA output
Audio input	2 Channels 200-2500mv 30KΩ (RCA)
Audio output	2 Channels 200-3000mv 5KΩ (RCA)
Video display	1/4 windows display
Video standard	PAL 625 line, 36f/s
System resource	4 x Channels Non real-time recording / 1 Channel real-time recording. Video playback and Network operation
Image resolution	Real-time monitor 704×576 Video playback 1CIF 352×288,
Motion detection	Area setting: 192 detection areas on the screen; detection sense setting: 4 levels detection sensitivity for each area
Video compression	MPEG-4 CBR (fixed frame rate); MPEG-4 VBR (variable frame rate)
Audio compression	PCM
Video recording speed	Total resources 36frames PAL mode
Image quality	6 levels selectable
Hard disk	Internally equipped with 1 IDE port, supporting 2 drives
HDD space used	Audio 9.6 Mbyte/hour Video 56 ~ 250 Mbyte/hour
Alarm input	4 channel voltage alarm input
Alarm output	1 channel relay output, including one +12V output
Alarm relay	30VDC 2A, 125VAC 1A relay output
Port	RS232
USB Port	2 x USB2.0 interface
Network port	RJ45 10M/100M Ethernet connection
Pan-tilt control	RS485
Power	220±25% V 50±2% HZ
Power consumption	20W excluding hard drive/s
Working temperature	-10°C ~ +55°C
Working humidity	10% ~ 90%
Barometric pressure	86kpa ~ 106kpa
Size	200 (wide) x275 (deep) x130mm (high)
Weight	5KG(not including hdd)

Product Features

Real-time Monitor

- Analogue Video output and VGA port
- Single window/4 windows monitor
- Realtime display of video bit rate and hard disk space usage per hour
- System log facility

Compression Method

- MPEG4

Storage

- 1-2 IDE large capacity HDDs with infinite capacity
- Alternate HDD working method, reduce the power consumption and heat emission
- Overwrite and Stop modes, user selectable for when the HDD is full
- Backup via IDE port – USB port to storage devices
- Download files from DVR to local PC via network

Play and record

- Supports multiplex operation: live monitor, record, file search for downloading, one channel playback and remote transmission simultaneously
- Network playback of files on DVR
- Quick search for all recordings
- Multiple playback modes: fast, slow, frame by frame, jump forwards/backwards
- Display original event time when playing back

Product Features Contd

Multi - Alarm

- 4 channel external alarm input, motion detection alarm – alarm inputs could include: smog, temperature & infrared detectors etc.
- Multi channel relay switch alarm output activates alarm relay and on-site light control
- Protection circuit for Alarm input and output to protect device

Communication connection port

- Supports the pan-tilt-zoom and alarm input via RS485 port communication
- RS232 port connected to PC for system maintenance
- Standard Ethernet port for remote connection and control via a network
- Supports high speed devices via two USB 2.0 ports

Network operation

- Remote real-time monitor via network
- Record search and real-time playback (playback quality depends on network capability)
- System setting modification and system software upgrading
- Remote alarm process and system log review
- Embedded Web server direct via Internet Explorer
- Administration mode: Two level network user administration; password to protect legal login

Installation.

Hard disk installation

If there is no hard disk fitted when initially purchased, check the hard disk equipment for the first installation. It is possible to fit a maximum of 2 x 750GB capacity hard discs inside the machine. The user can decide the number of hard disks according to required image quality, recording time and HDD capacity.

Installation Steps



Remove the fixing screws securing the top cover



Dismantle the front cover

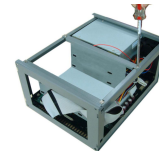

Dismantle the HD bracket



Install the first HD (Master)



Fix the HD bracket



Install the second HD (Slave)



Replace the front cover



Replace the top cover and fixing screws

CCT772 FRONT PANEL LAYOUT

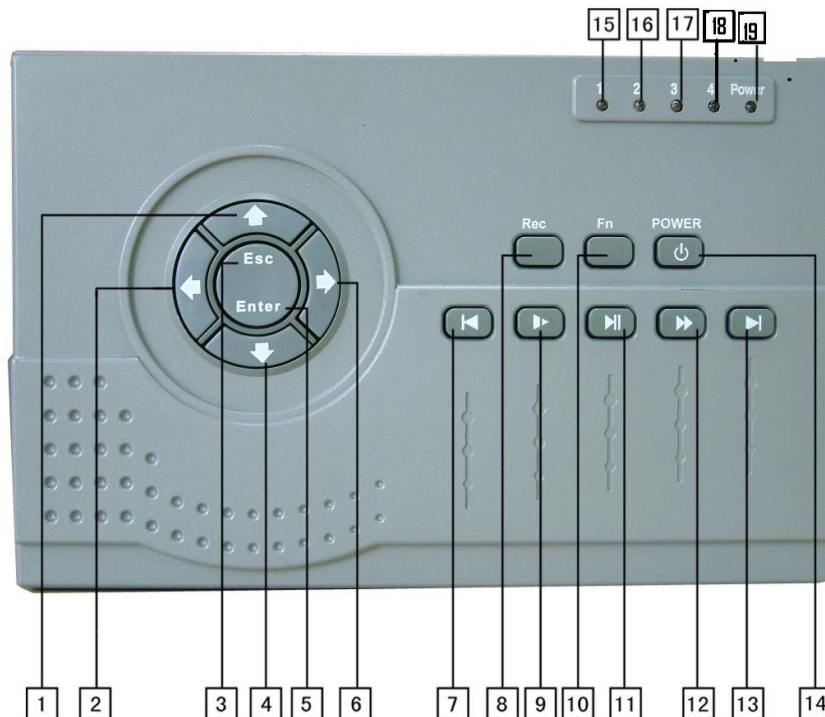

Key Functions

1. Up Direction Arrow (Press to select single window)
2. Left Direction Arrow (Press to select single window)
3. Escape/Cancel Key (See mouse and panel operation)
4. Down Arrow Direction (Press to select single window)
5. Enter/Cancel (Press to shift from 1 window to multi-window) (See mouse and panel operation)
6. Right Direction Arrow (Press to select single window)
7. Play Previous section (during playback) (Password 5 when not in playback mode)
8. Record (Controls channels in preview mode)
9. Speed Up sequencing in playback mode – fast2 – fast3 (Password 4 when not in playback mode)
10. Function Key (Acts as right mouse button in preview mode and enters shortcut menu)
11. Play/Pause - shift between play and pause (Password 3 when not in playback mode)
12. Jump Forward (during playback) (Password 2 when not in playback mode)
13. Go to next section (during playback) (Password 1 when not in playback mode)
14. Power On/Off (Power off by pressing key for three seconds)
15. Channel Record Indicator
16. Channel Record Indicator
17. Channel Record Indicator
18. Channel Record Indicator
19. Power Indicator

NOTE: Password Numeric Keys are used for entering the two levels of passwords

NOTE: Password Keys are used for entering passwords

CCT771 FRONT PANEL LAYOUT

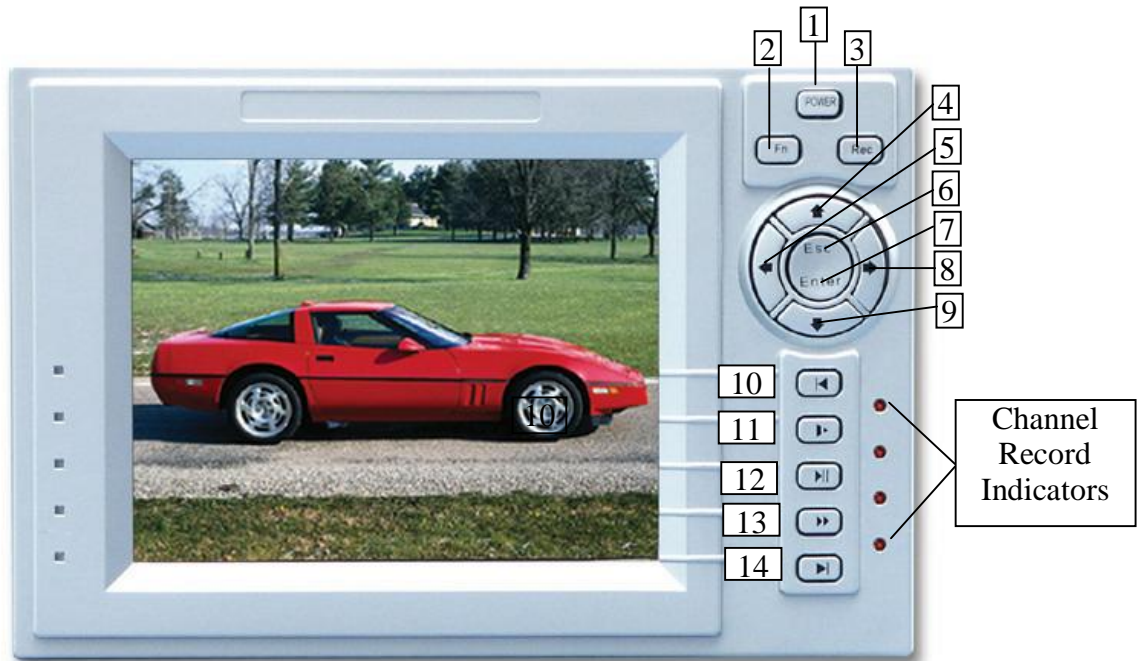

Key Functions

1. Power On/Off (Power off by pressing key for three seconds)
2. Function Key (Acts as right mouse button in preview mode and enters shortcut menu)
3. Record (Controls channels in preview mode)
4. Up Direction Arrow (Press to select single window)
5. Left Direction Arrow (Press to select single window)
6. Escape/Cancel Key (See mouse and panel operation)
7. Enter (Press to shift from one window to multi-window) (See mouse and panel operation)
8. Right Direction Arrow (Press to select single window)
9. Down Arrow Direction (Press to select single window)
10. Play Previous section (during playback) (Password 5 when not in playback mode)
11. Speed Up sequencing in playback mode – fast2 – fast3 (Password 4 when not in playback mode)
12. Play/Pause - shift between play and pause (Password 3 when not in playback mode)
13. Jump Forward (during playback) (Password 2 when not in playback mode)
14. Go to next section (during playback) (Password 1 when not in playback mode)

NOTE: Password Keys are used for entering passwords.

Mouse Operation - (plug mouse into lower USB port)

Single click left mouse button	Open password window if not logged in – enter main menu in monitor mode																																									
	Enter sub-menu																																									
	Initiate instructions to confirm, cancel, save or default an operation																																									
	Change conditions of double chosen frame or motion detection																																									
	Open list when clicking assemble frame																																									
	<p><i>Open number/abc panel when clicking EDIT, click numbers on the frame directly to finish input. In abc input mode the following characters are:-</i></p> <p>← Delete one character</p> <p>> and < capital lock shift</p> <p>Symbol X means clear all contents</p> <p>ü means confirm the input and close panel</p> <table border="1" style="display: inline-table; margin-right: 20px;"> <tr><td>q</td><td>w</td><td>e</td><td>r</td><td>t</td><td>y</td><td>u</td><td>i</td><td>o</td><td>p</td></tr> <tr><td>a</td><td>s</td><td>d</td><td>f</td><td>g</td><td>h</td><td>j</td><td>k</td><td>l</td><td>←</td></tr> <tr><td>></td><td>z</td><td>x</td><td>c</td><td>v</td><td>b</td><td>n</td><td>m</td><td>X</td><td>ü</td></tr> </table> <table border="1" style="display: inline-table;"> <tr><td>1</td><td>2</td><td>3</td></tr> <tr><td>4</td><td>5</td><td>6</td></tr> <tr><td>7</td><td>8</td><td>9</td></tr> <tr><td>0</td><td>X</td><td>ü</td></tr> </table>	q	w	e	r	t	y	u	i	o	p	a	s	d	f	g	h	j	k	l	←	>	z	x	c	v	b	n	m	X	ü	1	2	3	4	5	6	7	8	9	0	X
q	w	e	r	t	y	u	i	o	p																																	
a	s	d	f	g	h	j	k	l	←																																	
>	z	x	c	v	b	n	m	X	ü																																	
1	2	3																																								
4	5	6																																								
7	8	9																																								
0	X	ü																																								
Double click left mouse button	Special operations for controlling files e.g playback the section when double clicking it																																									
Single click right mouse button	<p>Open short cut menu in monitoring mode:</p> <table border="1" style="display: inline-table;"> <tr><td>SPLIT1</td><td>></td><td>CHN 1</td></tr> <tr><td>SPLIT4</td><td></td><td>CHN 2</td></tr> <tr><td>QUICK SEARCH</td><td></td><td>CHN 3</td></tr> <tr><td>REC CNTRL</td><td></td><td>CHN 4</td></tr> <tr><td>PTZ CNTRL (provided protocol set)</td><td></td><td></td></tr> <tr><td>COLOUR</td><td></td><td></td></tr> <tr><td>MAIN MENU</td><td></td><td></td></tr> <tr><td>ABOUT PTZ</td><td></td><td></td></tr> </table> <p>COLOUR CTRL reflects current channel selected. It will automatically switch to the channel selected in single screen mode if in multi-screen mode.</p>	SPLIT1	>	CHN 1	SPLIT4		CHN 2	QUICK SEARCH		CHN 3	REC CNTRL		CHN 4	PTZ CNTRL (provided protocol set)			COLOUR			MAIN MENU			ABOUT PTZ																			
SPLIT1	>	CHN 1																																								
SPLIT4		CHN 2																																								
QUICK SEARCH		CHN 3																																								
REC CNTRL		CHN 4																																								
PTZ CNTRL (provided protocol set)																																										
COLOUR																																										
MAIN MENU																																										
ABOUT PTZ																																										
	Do not save menu content and quit																																									
Mouse Running Roller	Change numbers when setting number frame																																									
	Shift options in assemble frame																																									
	Turn list pages																																									
Move mouse	Click items and move																																									
Drag mouse	Click and drag menu title or control row, relocate when dropping																																									
	Frame motion detection area																																									
	Move window co-ordinate when clicking menu title and drag (not all windows)																																									

Rear panel Layout

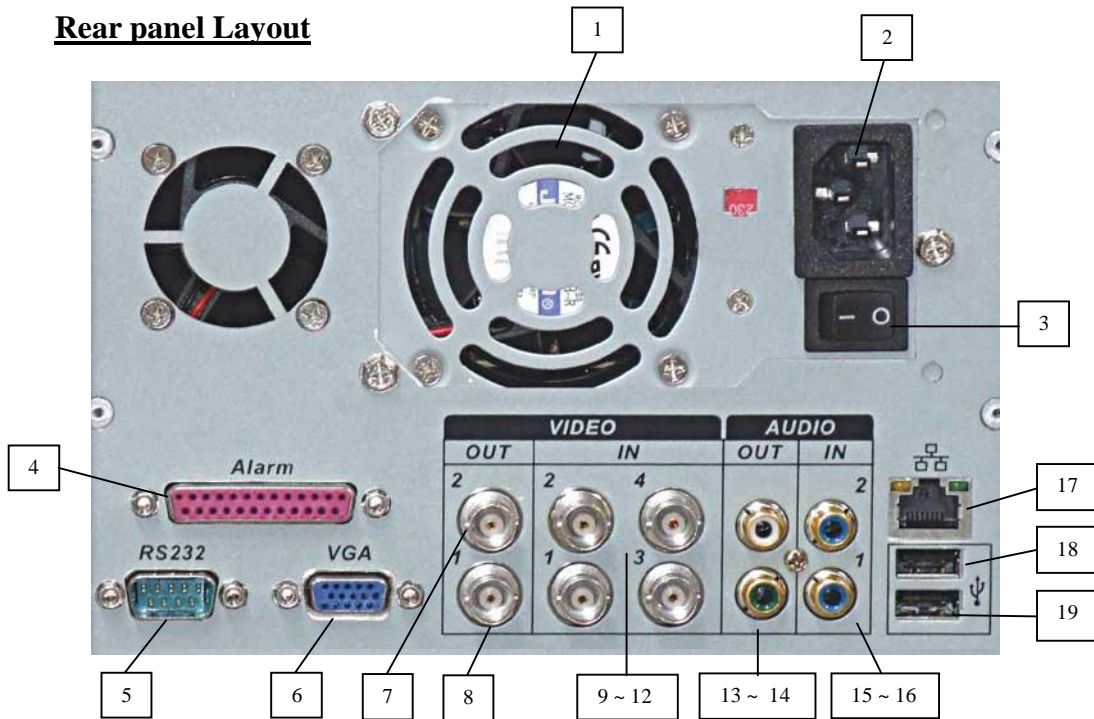

1. Cooling Fan
2. Power socket
3. Power switch
4. Alarm - RS485 connector (15 way 'D' type)
5. RS232 connector (9-way 'D' type)
6. VGA port
7. Video Out 2 (BNC) (not operational with LCD display model)
8. Video Out 1 (BNC)
9. Video In 2 (BNC)
10. Video In 1 (BNC)
11. Video In 4 (BNC)
12. Video In 3 (BNC)
13. Audio Out 2 (RCA Phono)
14. Audio Out 1 (RCA Phono)
15. Audio In 2 (RCA Phono)
16. Audio In 1 (RCA Phono)
17. Network Port
18. USB connector Upper (USB for Backup Only)
19. USB Connector Lower (USB for Mouse Only)

Alarm In/Out and RS485 Connections – (25-way 'D' type connector)

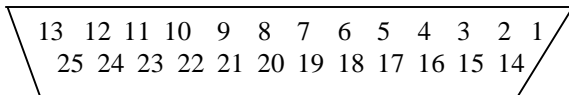

A 25 pin alarm transfer box is supplied with this DVR to provide alarm and RS485 connectivity. The transfer box is fitted directly onto the back of the DVR using the two screws supplied and plugs into the 25 pin connector. The green connectors can be easily withdrawn to fit cable connections.

25 Pin Alarm Transfer Box connections

1. "Ground" : ground line
2. "+12V" : provide the power to alarm device with current less than 2A
3. "OUT 2 1" : are the two alarm outputs switch Normally Open.
4. "485 A B" : The RS485 communication for PTZ control
5. "+12V(C)" : Controllable power output alarm. This alarm output could be used for standby power for a smoke detector device.
6. "ALARM IN (1 ~ 8) voltage alarm inputs. The input voltage is 5V ~ 15V but 12V is recommended.

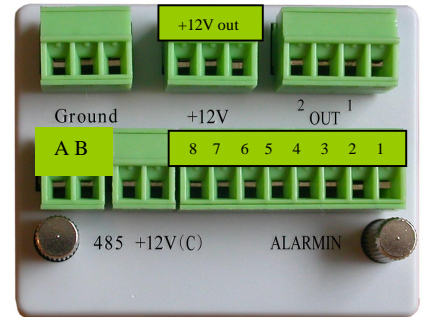

The DVR requires +12volts for its alarm input trigger. A +12volt supply is available from the DVR. This will be enough to operate approx 2 low current PIR devices (approx 50mA) as well as providing the switching voltage. If an external power supply is used then remember to connect the 0volts to the DVRs Ground connection to provide a common reference.

See Examples 1 and 2 below:

Example 1 Wiring diagram to trigger alarm using 12v supply from DVR

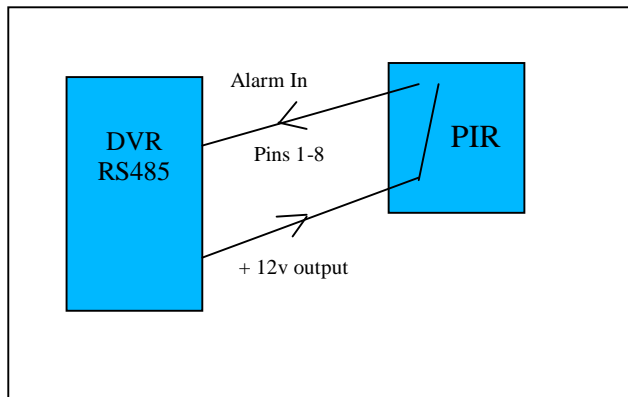

The above diagram shows a 12-volt alarm device being powered from the 25 pin alarm box on the rear of the DVR. When the device is triggered 12volts is applied to the alarm input thus activating the DVR.

Example 2 Wiring diagram to trigger alarm using external 12v supply

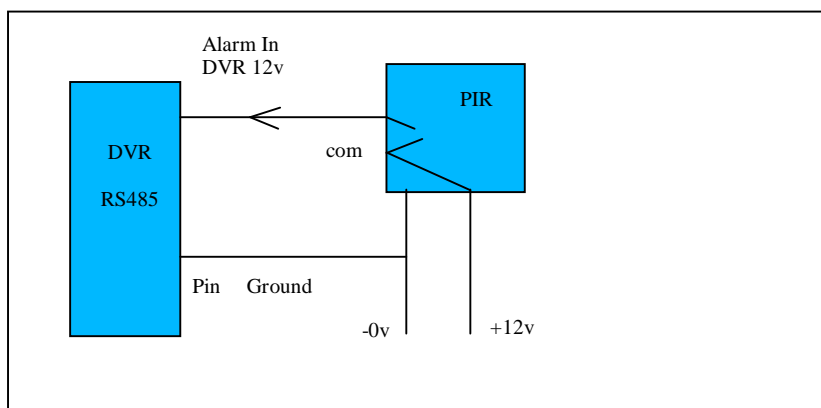

The above diagram shows a 12-volt alarm device being powered from an independent 12 volt power supply.

System operation

Before switching on the DVRs make sure that the Hard Drives have been fitted as required. Refer to Installation for further details.

Turning on the recorder

Plug in the power cable; switch on the power button at the back of the recorder; at this point the power indicator light should be on. The DVR will boot up.

Note: if the system stops during (Hard Disk Drive) detection, this means the HDD may not be installed correctly and needs to be checked. See troubleshooting.

If the settings are still at default the system will start recording automatically. The display screen will come up in quad mode. Press the **Enter** key or click the left mouse button to access the menu mode (the password screen will be displayed); the corresponding channel indicator lights will be on. A Login dialogue box will appear to enter user name and password. The default admin user will be displayed. Just enter OK as default password is “blank”.

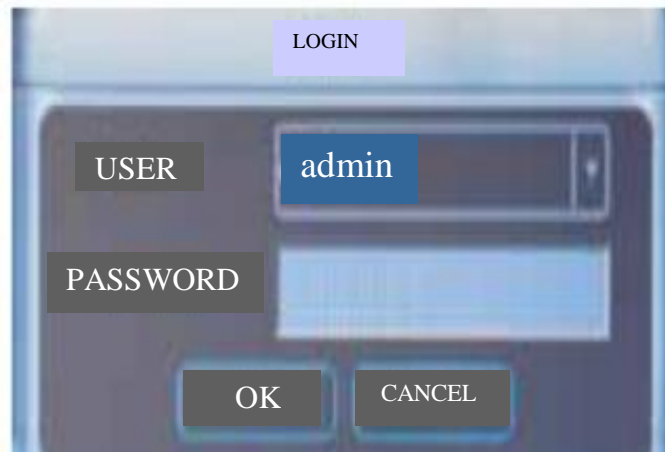

There are no restrictions to the administrator rights whereas logging on via a user group only functions like SEARCH are available. Other rights such as INFO, SETTINGS, BACKUP and ADVANCED however are restricted.

Note: For security reasons please change the default password. If you want to add a new user group, add new users or modify the related parameters of a user group, refer to chapter on Mouse, panel and remote control operation.

To protect data stored from malicious interference it is advisable to always log out after finishing an operation and then logging in again when access required.

Turning off the recorder

Press the POWER key on the front panel for 3 seconds to stop the DVR. Then switch off the power button at the rear to turn off the power. **Note: Always follow this procedure to shut down the DVR correctly to prevent data corruption.**

After pressing the rear POWER switch the user should wait for 5 seconds before trying to restart.

Automatic Power off recovery

If there is power loss during normal operation of the DVR, the recorder will preserve the recorded information and return to the previous state and continue to work at the next restart. The state will be the same as it was before the power loss.

Changing the Lithium Battery

If the unit time or date begins to show discrepancies, it may be that the lithium battery requires replacement. Use a similar type of replacement battery. Whilst the battery should last a considerable time it is recommended to check this on an annual basis.



System menu structure

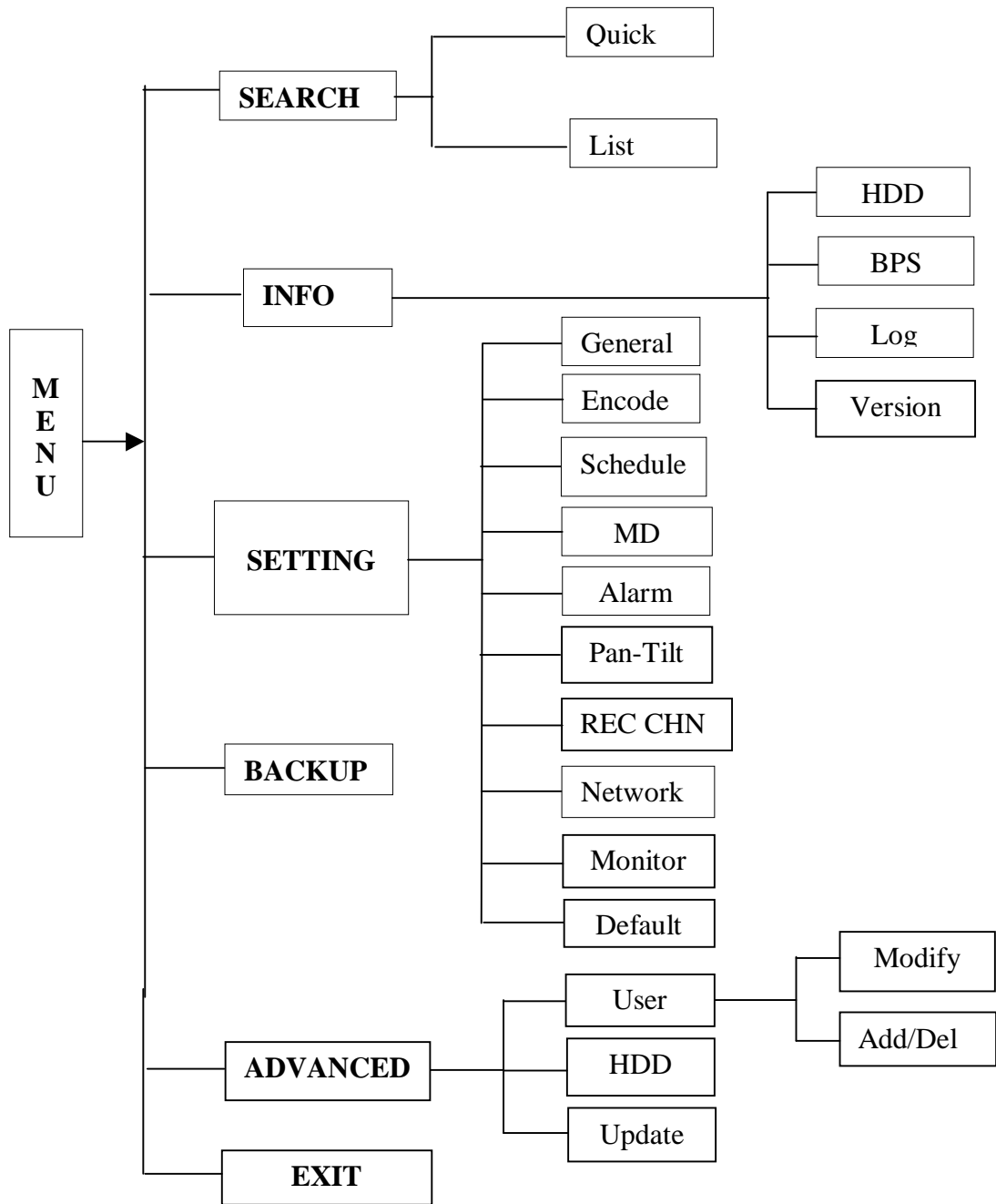

Recording operation

The default recording mode after starting the DVR is 24 hour continuous recording. The recording options are selected by the user and are as follows:

Schedule recording

Enter the menu and set the time period for the recording. See details at MAIN MENU > SETTING > SCHEDULE.

Manual recording

Press [REC] on the front panel (record settings can only be made under the admin login), click right mouse button or press [Fn] key to enter shortcut menu, select [REC CTRL].

Check the status of each channel in the recording menu, channels marked with \dot{U} are the channels set for recording.

Select the channel to be recorded (it will be \square when in non-recording mode. Press the related number key

(or \blacktriangle \blacktriangledown , jog shuttle, mouse) to mark it with \dot{U} . Then press Enter to save settings.

Press again the related number key (or \blacktriangle \blacktriangledown , jog shuttle, mouse) to stop the recording of this channel.

Press [ESC] to exit, [Enter] to save the setting.

Alarm Recording

Alarm recording allows you to increase the recording time of the DVR, as it will only start recording when the PIR etc picks up any movement.

Connect the alarm input device to the DVR according to the device connection instructions.

Connect the related alarm output e.g light, bleeper, etc.

Select the correct setting in the Alarm menu to start alarm recording. See details at MAIN MENU> SETTING > ALARM and set alarm start and end time in MAIN MENU> SETTING > SCHEDULE.

Motion Detection recording

Motion detection recording will increase the recording time of the DVR, as it will only start the DVR recording when it picks up movement.

Points to consider when using Video Motion Detection: - It is important to remember that the DVR's VMD circuits look for movement in the camera's picture, therefore if it is so dark that the camera cannot see any movement nor will the VMD circuits. However, if you were using VMD in a darkened room as soon as the light is turned on, the VMD would cause the DVR to record, as the change in light would be seen as movement. When you are using the VMD with external cameras, sudden changes of bright sunlight to cloud, may cause the VMD circuits to trigger the DVR. With this in mind, outdoor use of VMD needs careful planning.

In order for VMD to trigger the DVR you need to turn off schedule recording on the channel that requires VMD, ensuring that you do this for each day.

Now you can turn VMD on.

Set up the required times and required motion detection setting in the menu. See details at MAIN MENU > SETTING > MD.

Pan-tilt-zoom control operation

The Tardis range allows you to control Pan, Tilt & Zoom Equipment. It is possible to control PTZ equipment from the DVR unit or you can operate it over a network connection.

Confirm the correct connection of the PTZ and the decoder, then set the correct decoder address.

You should enter the corresponding protocol of the PTZ equipment that you are using, from the MAIN MENU > SETTING > PAN-TILT. Confirm the right connection of the camera's decoder A and B line and the DVR's A and B line on the 25 Pin Alarm Transfer Box. To have control over the PTZ equipment you need to ensure that the monitor is in single window mode (with the camera you require displayed). You should now press the function1 key [Fn1] or the right mouse button Select the PTZ CTRL menu. Use the direction keys to move the PTZ equipment. Please note – The PTZ protocols are of a limited range, therefore some functions that you can control on a PTZ keypad will not be available using the DVR.

Use [I ◀] or [▶ I] key to move and control selections on the screen including: direction, zoom, focus, iris & lamp.

Use [▲] [▼] [▶] [◀] keys to move and control parameters.







Video Image Control Information

Click right mouse button or [Fn] key in monitor mode, select COLOUR CTRL and set colour, brightness, contrast and saturation.



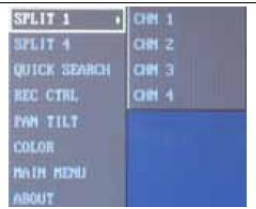





Mouse and panel operation

Menu settings





Operation step	Button-pressing order	Instruction	Screen display
Enter main menu	1 Click or press [ENTER] 2 Shortcut: right mouse button MAIN MENU	Re-login needed after restarting system or logout. Re-login and enter main menu. (Display on right shows menu when clicking right mouse button)	
Enter level 1 submenu	1.Press direction keys (jog shuttle) p q u t or move mouse	Shift main menu options	
	2. Click or Press [ENTER]	Enter the selected level 1 submenu	
Enter level 2 submenu	1.Press direction keys (jog shuttle) p q u t or move mouse	Shift level 1 submenu options	
	Click or press [ENTER]	Enter the selected level 2 submenu	
Set menu contents	1. Press direction keys u t or move mouse	Select the level 2 submenu option to be changed. Selection is highlighted.	 
	2. Press u t or roll mouse	Revise menu contents, press u t to the next option to reverse after finishing	
	3. Click mouse or press [ENTER]	Press [ENTER] to save setting or execute default. If combined with number keys or software disk (click edit menu or enter)	
Exit menu	Press [ESC] or click right mouse button	Exit to the last level menu	





You can perform multiple channels setting before exiting the same level menu and save the settings altogether



Menu option schedule

Main menu	Menu level 1	Remarks
<p>SEARCH</p>  <p>SEARCH</p> <p>Rapid Search List Search & Playback Function</p>	<p>QUICK</p> <p>SEARCH</p>  <p>RECORD</p>	Positioning playback by channel or time
	 <p>LIST</p>	<p>Search by recording type :- (all, alarm, motion detection) , channel and time.</p> <p>Results are listed. Select file for playback.</p>
 <p>SYSTEM INFO</p> <p>Look up hard disk info, bit rate stats, alarm condition and version etc.</p>	 <p>HDD STATE</p>	<p>Hard Disk number, Total capacity, Capacity left, Start & end time of recording</p>
	<p>BPS</p>	<p>Current bit rate on each channel and hard disk space occupation, Wave image display etc.</p>
	<p>LOG</p>	<p>Display login and out time of all users</p>
	 <p>VERSION</p>	<p>Display system hardware resource, hardware version, software version and software published date etc.</p>

Menu option schedule (cont.)



Main Menu	Level 1	Remarks
 <p>SYSTEM SETTING</p> <p>Basic system channel parameters, image coding / decoding parameters, schedule, motion detection, alarm and monitor parameters setting.</p>	<p>GENERAL</p>  <p>GENERAL</p>	<p>Set basic parameters: system time, date & time format, language version, video mode and DVR item number.</p> <p>If video mode is changed the system will automatically restart.</p>
	<p>ENCODE</p>	<p>Set AV parameters: coding mode, frame rate, image quality, bit rate control, resolution and sampling rate.</p>
	<p>SCHEDULE</p>  <p>TIMING</p>	<p>Schedule set for recording, motion detection, external alarm, & time zone for daily operation. Note two time zones can be allocated for each channel per day.</p>
	<p>Motion Detect</p>  <p>IMAGE</p>	<p>Set motion detection parameters: channel, sensitivity, region and processing. (alarm output and time lag switch)</p>
	 <p>ALARM</p>	<p>Set parameters including alarm input and condition, alarm time lag, screen inform, alarm output and condition.</p>

<p>SETTINGS</p>  <p>SYSTEM SETTING</p>	<p>CHANNEL</p>	<p>Set input channel and name</p>
	<p>PAN-TILT</p>  <p>CONTROL</p>	<p>Set channel pan-tilt protocol, protocol decoder address, baud rate and data format</p>
	<p>NETWORK</p>  <p>NETWORK</p>	<p>Set network parameters including IP address and video data transmission protocol.</p>
	<p>MONITOR</p>  <p>MOTION DETECTION</p>	<p>Set menu output and monitor sequence mode parameters.</p> <p>Note: menu output attribute changes will be effective when system restarts.</p>
	<p>DEFAULT</p>	<p>This option sets manufacturers default settings.</p> <p>Note: menu colour, language and video mode will stay unchanged.</p>
<p>BACKUP</p>	<p>Check backup device, select backup division, record channel, time and type.</p> <p>After setting, find recording files on hard disk and backup to USB storage device.</p>	

 ADVANCED Software upgrade, HDD settings and user management.	UPDATE	Software upgrade via U directory. Upgrade program will only be found if under U directory on USB device when unit restarted.		
	HDD	This option allows setting hard drive working mode, the recording file size and hard disk format. NOTE: Hard disk changes are effective when system restarts.		
	 USER	MODIFY	Set “user” and “administrator” password.	
		ADD/DEL	Create new user, distribute user limits, set Password, delete selected user.	
EXIT	Logout, shutdown system, restart system.			

System Operation

Record Control

Operation	Instruction	Screen Display
1. MAIN MENU > SETTING > REC CHN or right mouse button REC CTRL	Press to enter screen display (input password in logout condition)	
2. directions [p] [q] + [Enter] or click mouse	Press to set channels on or off for recording. Image on right shows all channels are in record mode.	
3. directions [u] [t]	Press to select recording channel	
4. save	Press [Enter] to save setting	

System Operation

Record Playback

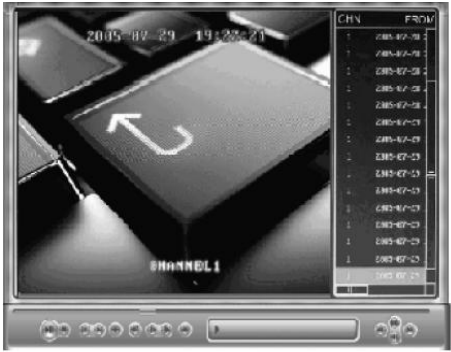
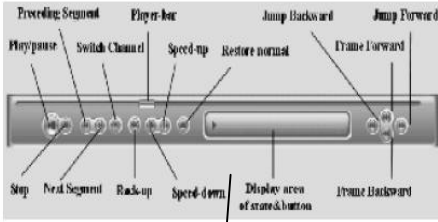
Operation	Instruction	Screen Display
<p>1. Enter playback: MAIN MENU > SEARCH > QUICK / LIST</p>	<p>Enter screen display: Set search time, press [play/pause] / [Enter] to playback. Note: This operation is invalid if recorded file in search time entered is not found.</p>	
<p>2. Operate playback mode frame</p>	<p>Playback recording (screen displays channel, date, time, playback speed and progress) and controls speed and channel.</p>	<p style="text-align: center;">Playback bar</p> 
<p>3. Simultaneous channel shift when playback.</p>	<p>Press Switch Channel key to shift relative channel recording simultaneously with current playback channel.</p>	

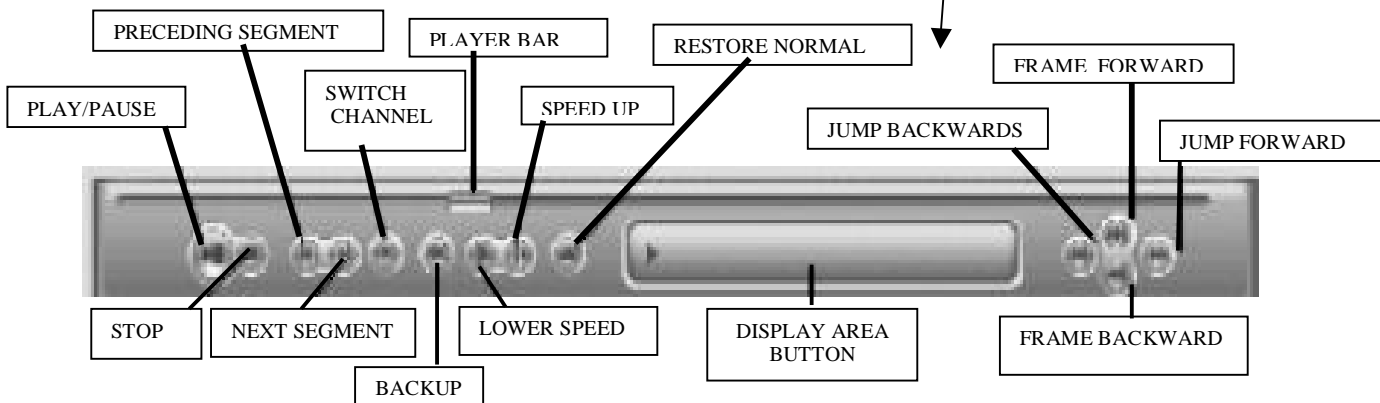

Playback Bar

Operation	Instruction	Remarks
1. pause/play [⏸]	Press to move between play and pause	
2. stop [■]	Press to stop playback	
3. previous section [⏮] next section [⏭]	Press to choose different sections in current channel	
4. switch channel	Press to select relative channel	
5. reverse	Press to playback in reverse	
6. speed down [⏪]	Press to change playback speed: total 4 levels: slow 1 / 2 > slow 1 / 3	Slow 1 / 3 means 1/3 of normal speed
7. speed up [⏩]	Press to change playback speed: total 2 levels: fast2 > fast3	fast3 means 3 times normal speed
8. restore normal [⏪]	Click to go back to normal mode from any abnormal playback mode.	
9. play forward, frame by frame [⏮] play reverse, frame by frame [⏭]	Press to play frame by frame manually (key frames per second) : including forward and reverse play.	
10. forward [⏩] rewind [⏮]	Press to change between forward and rewind.	

Note:

1. In playback mode, control frame will show file play speed, channel, time and play process.
2. Reverse function, manual frame by frame playback function and playback speed depends on machine version.
3. The rapid change from abnormal playback to normal mode is available by mouse and panel operation.
4. Circle playback is accepted in any mode. System will play the first section in the list if the last one is complete but auto replay if only one file is playing.

MENU OPERATION

LOG IN

Log In, press [Enter] / click left mouse button / click right mouse button > MAIN MENU

Six menu options displayed :

SEARCH
INFO
SETTING
BACKUP
ADVANCED
EXIT

MAIN MENU



SEARCH



INFO



SETTING



BACKUP



ADVANCED



EXIT

SEARCH MENU

Search files using **QUICK** and **LIST** modes depending on record type, channel and time.

Note: Choose file, press [Enter] to play.

SEARCH



QUICK



LIST

Search according to channel and time

QUICK

Search and playback recorded files by channel and time.

Press **t u** to choose channel and time.

Press **p q** to change content.

Press [Enter] to play back.

LIST

Search by recording type: all, alarm, motion detection, all alarm record, record channel, start and end time of recording – shows results in a list.

Set channel, date, time –
Press **SEARCH**
screen shows a list –
Press **↑** or **↓** to select a file –
Press [Enter] or click **PLAY** to play file.



INFO MENU

Four menu options are displayed :

HDD
BPS
LOG
VERSION

Note: These menus only available to Admin users.



HDD

Shows HDD ID number, total capacity, capacity left, start and end time of recordings.

Note: If you need to replace a faulty hard drive, power down and remove the faulty drive before installing the new one. If hard disks conflict when starting system, check that the time in system and hard disk is the same. If not then enter **GENERAL** menu to set system time and then restart DVR to secure changes.



BPS

Realtime display shows channel video bit rate (B/S) and hard disk space (B/H). Some versions of software support a bit-rate wave shape chart.

1
;



LOG

Displays log of all user log-ins including: username, limit, log-in time and log-out time.

Press **t** or **u** to choose user.

Note: Information display screen will show all the operations in the period (from login time to log-out time)



VERSION

Display hardware sources (channel numbers, alarm input/output channel numbers), hardware version, software version and publish date.



SETTING MENU

SETTING MENU

Ten menu options are displayed :

GENERAL
ENCODE
SCHEDULE
MD
ALARM
REC CHN
HDD
NETWORK
MONITOR
DEFAULT

Note: These menus only available to Admin users. Press SAVE to activate new settings.



GENERAL

System time: set system date & time
Date format: select: yy-mm-dd, mm-dd-yy, yy/mm/dd, mm/dd/yy
Time format : 24hr and 12hr
Language: English, Chinese
Video mode: PAL and NTSC
Item number: for one remote control

NOTE: DO NOT CHANGE DATE OR TIME AS RECORDED DATA MAY NOT BE ACCESSIBLE



ENCODE

Video channel: select channels

VIDEO SETTING:

Coding mode: MPEG4
Resolution: CIF
Bit rate control: CBR or VBR
Frame rate: 1~3 f/s, 6f/s, 12f/s, 25f/s
Image quality: 1~6 levels (6= best)

AUDIO SETTING

Audio channel: Ch1, Ch2, close
Compression mode: PCM
Sampling rate: 8KHz
BITS: 16 digits for each sample



NOTE: There are 4 video channels & 2 audio channels. Two channels are closed when all 4 channels are recording.

SCHEDULE

Includes timing recording, motion detection & external alarm – maximum 2 time zones per day.

Channel: select channel

Day of week : set time for each day

Time section 1 , Time section 2 :

Start and finish time for recording.

Allows two time periods to be set per day. If start time not earlier than end time, end time will be switched to start time. If only one time period required per day then only select Time 1.



MD

Motion Detection.

Channel : select MD channel

Region : move cursor to SET, press [Enter]. Screen divided into 192 regions. Green frame squares show cursor position. Coloured region is the area tested for motion detection. The transparent area is not motion detected. Press SAVE to save setting.

Sensitivity : high, normal, low

Recording channel : select channel/s to be recorded.

Alarm output : switch output alarm device.

Alarm time lag : time recording in seconds after MD complete – 10 secs ~ 300 secs.

Screen display : [P] means MD info on screen.



NOTE: It is easier to use the mouse for setting Motion Detection. When settings complete ensure to press SAVE.

Setting up Motion Detection

To change schedule recording to motion detect enter the Schedule, select RECORD top right and then select each channel in turn and un-tick each day scheduled and SAVE . Now go into the MD menu and set the channels for motion detect and save. Now return to the Schedule, select MD top right and then select each channel in turn and tick each day for motion detect, then SAVE. Do not select ALL as this will reset the time settings in MD and will reset the schedule to normal recording.

Recommendation: Before making changes it is advisable to set the General menu settings first to 24 hour time format. If you change settings in the General menu it is advisable to set all recordings to off first, then go to Advanced menu – HDD – and format hard disk. After reboot make changes to General menu settings and switch on recordings.

ALARM

Alarm Input Info:-

Alarm input: select alarm channel

Device type : open / close

Channel selection : select recording channel (s). Channel will record automatically when alarm is on.

Alarm time lag : auto set time lag 10~300 secs after alarm cancelled.

Pre-recording: [P] means function on

Alarm output : [P] means alarm out on

Screen output : [P] means function on.

Alarm Output Info:-

Alarm output channel : select channel

Alarm switch : [P] means function on.

Device type : open / close



REC CHN

Select Record Channels

Channel: select channel/s

Channel status : [P] means channel on

Title : channel title e.g CHN1



PAN-TILT

Channel : select channel with PTZ

Protocol : select protocol from list

Address : select PTZ decoder address

Baud rate : select baud rate

Data position : select data position

Stop position : select stop position nos.

Check : odd/even



NETWORK

Net Layer:

IP Address: set IP address

Subnet mask : set Subnet mask

Default gateway : set default gateway

Transfer Layer:

Protocol : TCP

HTTP port : set port, default 80

TCP/UDP port : default 37777

Note: set local connection protocol as TCP when monitoring via WAN



MONITOR

Menu output:

Transparency : 0 ~ 255

Time title : [P] means no time information output.

Auto log-out : 5mins, 10 mins, 15 mins, 20 mins, 30 mins, 60 mins and no auto log-out.

Monitor output:

Screen mode : single & multi-screen

Circle mode : non-circle, circle 5, 10, 15, 20, 25, 30 seconds. (circle means sequencing)

4 windows : [P] means 4 window monitor circle output is on.

1 window : [P] means single monitor circle output is on.



DEFAULT

Set system default settings.



BACKUP MENU

Target device : select target backup device (USB storage device)

Target division : select target division

Target channel : select backup channel source.

Record type : select record type including alarm records, motion detection and all records.

Start time : select start time of backup record

End time : select end time of backup record.

NOTE: Option only available to admin users.



ADVANCED MENU

Three menus are displayed:

USER

HDD

UPDATE

NOTE: Option only available to admin users.



USER

Click on USER to show two menu options.

MODIFY

ADD/DEL



MODIFY

User name : enter login user name

New password : enter new password –
(1 ~ 6 digits)

Confirm password : re-enter password

NOTE: Option only available to admin users.

Press [Enter] to confirm.

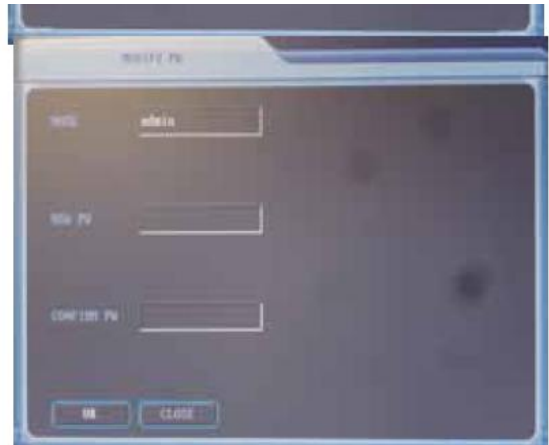

ADD/DEL

User name : enter new user/user to delete.

New password : set new user password
(1 ~ 6 digits)

Confirm password : re-enter password

User limit : select **user** for limited rights or
Administrator for full rights

Add : Press **ADD** to finish setting

Delete : Press **DELETE** to delete
password



HDD

Channel : select hard disk number

Work mode : MASTER/SLAVE

Write mode : OVERWRITE/STOP
(set to STOP unit will not overwrite HDD)

Record size : 20 min

Format : Press **FORMAT** to format HDD
Press [Enter] to proceed

NOTE: Formatting will remove all data on
HDD.

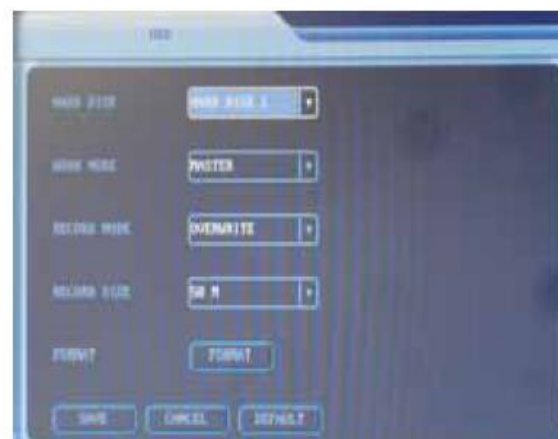

UPDATE

This option allows the installing of new BIOS software upgrades. The software is downloaded from a PC using a USB connection and entering this menu. The BIOS upgrade must be saved in the U:/ folder on the PC.

Open : Press OPEN and DVR will search for BIOS upgrade in U: drive on PC. If software not found upgrade will fail.
NOTE: Do not stop upgrade during update as this may corrupt machine BIOS.



EXIT

This menu has three options:

LOGOUT

CLOSE SYSTEM

RESTART SYSTEM

Click on drop down arrow to select option required.

Logout : Quit menu, enter password to re-enter.

Close system : Quit and switch off power.

Restart system : Quit and restart system.

NOTE: Available to users and administrators.



Network connection operation

The Tardis can be networked in three different ways; Direct connection, LAN connection or Internet connection.

Direct Connection via a crossover cable

It is possible to connect the DVR directly to a PC that has a Network Interface Card. It must be connected to a P.C using a network **crossover** lead. This lead (NET992) can be purchased from your supplier. You must give the DVR an Internet Protocol (IP) address e.g 192.168.000.005. The DVR default IP address can be found by Entering main menu > settings > network. The subnet mask should be set to 255.255.255.0 Leave the Default Gateway blank. Power down the Tardis to register the changes. Hold the front power button for 4 seconds, then switch off at the rear. Now power back on at the rear of the DVR and the unit will reboot. Now set the PC with a unique I.P address but in the same range as the DVR e.g 192.168.000.010. To set the IP address in the PC go to Control Panel > Local Area Connections then Properties > Highlight Internet Protocol (TCP/IP) then click Properties again > click "Use the following IP address". Set the IP address and subnet mask. Again leave the Gateway blank. Now load the DVR365 client and player software. Load the client software from the CD provided with the DVR. Now double click the program icon. The software will require the DVR I.P address e.g 192.168.000.005 and the subnet mask. Login by setting User admin only. Leave the password field blank.

Local Area Network via a hub, switch or modem router

You can connect the DVR to a Local Area Network (LAN) using the connection port on the rear of the DVR. You must use a **LAN cable** as per the one supplied with the unit. You must give the DVR an Internet Protocol (IP) address. This must be unique to your network but in the same range as the Router's IP address. For example if the Router's default IP address is 192.168.000.001 then use the same first three levels of the IP address i.e 192.168.000 but give the last level a unique value e.g 192.168.000.**005** If the Router's default IP address is 192.168.**001**.001 then use an IP address in the DVR e.g 192.168.**001**.005 The subnet mask should be set to 255.255.255.0 The Default Gateway should reflect the Router's IP address.

Power down the Tardis to register the changes. Hold the front power button for 4 seconds, then switch off at the rear. Now power back on at the rear of the DVR and the unit will reboot. Now set the PC with a unique I.P address but in the same range as the DVR e.g 192.168.000.010. To set the IP address in the PC go to Control Panel > Local Area Connections then Properties > Highlight Internet Protocol (TCP/IP) then click Properties again > click "Use the following IP address". Set the IP address, Subnet mask and Gateway address.

To set the IP address in the PC go to Control Panel > Local Area Connections then Properties > Highlight Internet Protocol (TCP/IP) then click Properties again > click "Use the following IP address". Set the IP address, subnet mask and Gateway. The Gateway is the Router's IP address. Now load the DVR365 client software from the CD provided with the DVR. Now double click the program icon. The software will require the DVR I.P address e.g 192.168.000.005 the Subnet mask and Gateway addresses. Login by setting User admin only. Leave the password field blank.

In order to confirm the correct network connection between DVR and computer, you can use the PING command that comes with Microsoft Windows systems. To access the PING command, follow the sequence below: Start > Programs > Accessories > Command Prompt. Once Command Prompt is open type (if 192.168.000.005 is the IP address of the DVR): PING 192.168.000.005

If it comes back and says 'Request Timed Out' then the two devices are not communicating/connected correctly. This could be due to a bad or incorrect cable connection or the incorrect IP addresses. If it comes back and says 'Reply from 192.168.000.005' the two devices are connected correctly.

Internet Connection via a modem router

CHECK LIST – for getting a Video Tardis on to the Internet

You need a broadband (ADSL) internet connection at the site where the DVR is to be installed.
The ADSL connection at the site where the DVR is installed should have a "**STATIC IP address**".

(Note - you can request a static IP address from most Internet Service Providers (ISP's), but they may charge a small fee for this.)

You will need a broadband router/modem at the DVR site. A good one is the NET800.

At the remote site where your computer will be located you will also need a broadband connection to ensure that you have a fast connection to your DVR.

TIP - You *can't* use a USB type modem connected to a stand alone PC to get the Tardis connected to the internet, you must get a router-modem, that allows multiple computers to share the broadband ADSL connection. USB modems rely on a computer's operating system to drive them and the DVR365 cannot do the same thing.

Once you have got your ADSL Internet connection with a static IP address at your DVR site, you can progress to installing the DVR.

If the site where the DVR is to be installed already has an ADSL Internet connection that is shared by one or more computers it is likely to already have an ADSL modem/router of some description. If this is the case you will have to

either configure the existing modem/router or replace it with a new one. If it's an existing installation, we strongly recommend you enlist the help of the person or company that installed and configured it originally.

The rest of these instructions now refer to installation using the NET800 modem/router.

Step 1 Getting the NET800 router-modem connected to the Internet

If you have already done this and can already “surf the internet” you can skip this section and go straight on to the next step.

Your ISP should have given you all the information you need to get your modem and computers connected to the Internet. You should have the following information;

- login user name
- password
- static IP address

Connect your computer to the NET800 modem router using the blue STRAIGHT RJ45 cable supplied with the router. Next, you need to set up the router to connect to the Internet. See the NET800 instructions of how to do this.

Once you have set up your router to work with a static IP address anyone who types this address into their web browser will be re-directed to your router from anywhere in the world. The next task is to make the router “route” this request to the DVR.

Step 2 – Setting up the DVR

The DVR needs to be connected into the same network as the NET800 router or directly to the router itself. To connect into the network or directly to the router, use the “straight” grey RJ45 cable supplied with DVR. (Note when you are connecting the DVR directly to a computer with no router you need a “crossover cable”.

In the DVR you need to set up its IP address to be the same address as you set the DMZ server to be in the NET800 router. In this example, both the DVR's IP address and the DMZ server's need to be set up to be 192.168.001.005. Also, you will set up the DVR's “gateway” as 192.168.001.001. The Static IP address supplied by your Internet Service Provider does not have to be specifically entered as this will be automatically determined by the NET800.

To get into the DVR menu press “enter” followed by the User admin. Leave the password field blank unless you have set a password. Now navigate to Settings>Network
In Network enter the details as follows:

NETWORK				
NET LAYER				
IP ADDRESS	192	168	001	005
SUBNET MASK	255	255	255	000
GATEWAY	192	168	001	001
TRANSFER LAYER				
PROTOCOL	TCP			
TCP PORT	37777			
HTTP PORT	00080			
SAVE CANCEL DEFAULT				

TIP- we recommend you do not change the subnet mask, as this is the default setting for most networks.

After you have changed *and* saved the network settings in the DVR (such as the IP address) you **MUST** reboot the DVR for these changes to take effect. Obviously please make sure you save the settings before you reboot!!m/router you will need to test it from another broadband connection to make sure it is working correctly.

Whilst we can help with the DVR settings, it is the ISP's responsibility to advise on the setup of your ADSL connection.

Step 3 – Setting up the PC

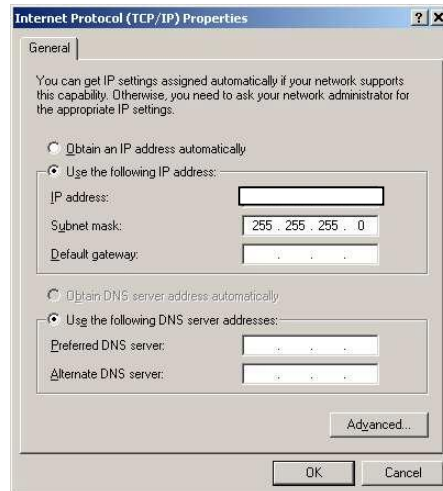
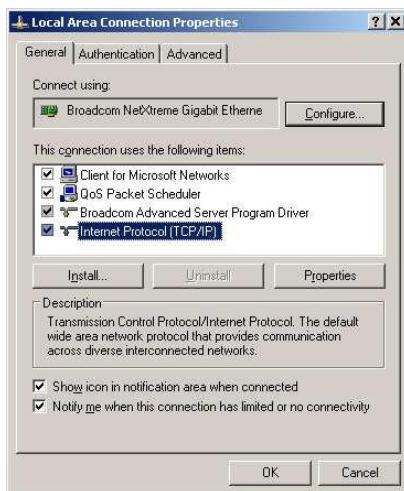

To set the IP address in the PC go to Control Panel > Local Area Connections then Properties > Highlight Internet Protocol (TCP/IP) then click Properties again > click “Use the following IP address”. Set the IP address, subnet mask and Gateway. The Gateway is the Router’s IP address. Now load the DVR365 client software from the CD provided with the DVR. Now double click the program icon. The software will require the DVR IP address e.g 192.168.001.005 the Subnet mask and Gateway addresses. Login by setting User admin only. Leave the password field blank.

In order to confirm the correct network connection between DVR and computer, you can use the PING command that comes with Microsoft Windows systems. To access the PING command, follow the sequence below: Start > Programs > Accessories > Command Prompt. Once Command Prompt is open type (if 192.168.001.005 is the IP address of the DVR): PING 192.168.001.005

If it comes back and says ‘Request Timed Out’ then the two devices are not communicating/connected correctly. This could be due to a bad or incorrect cable connection or the incorrect IP addresses. If it comes back and says ‘Reply from 192.168.001.005’ the two devices are connected correctly.

NETWORK OPERATION

Web Browser

The Client software does not need to be pre-installed. You can connect to this DVR using the Web Browser. If you cannot get a connection then to refer to the previous instructions.

LOGIN and LOGOUT

Enter the IP address of the DVR into the address line of the Web Browser. For example if the DVR IP address is 192.168.0.5 then enter <http://192.168.0.5> into the browser address line. The first time this is run a dialogue popup box will appear asking if you wish to accept ActiveX. If you reply YES, the system will install the software automatically.

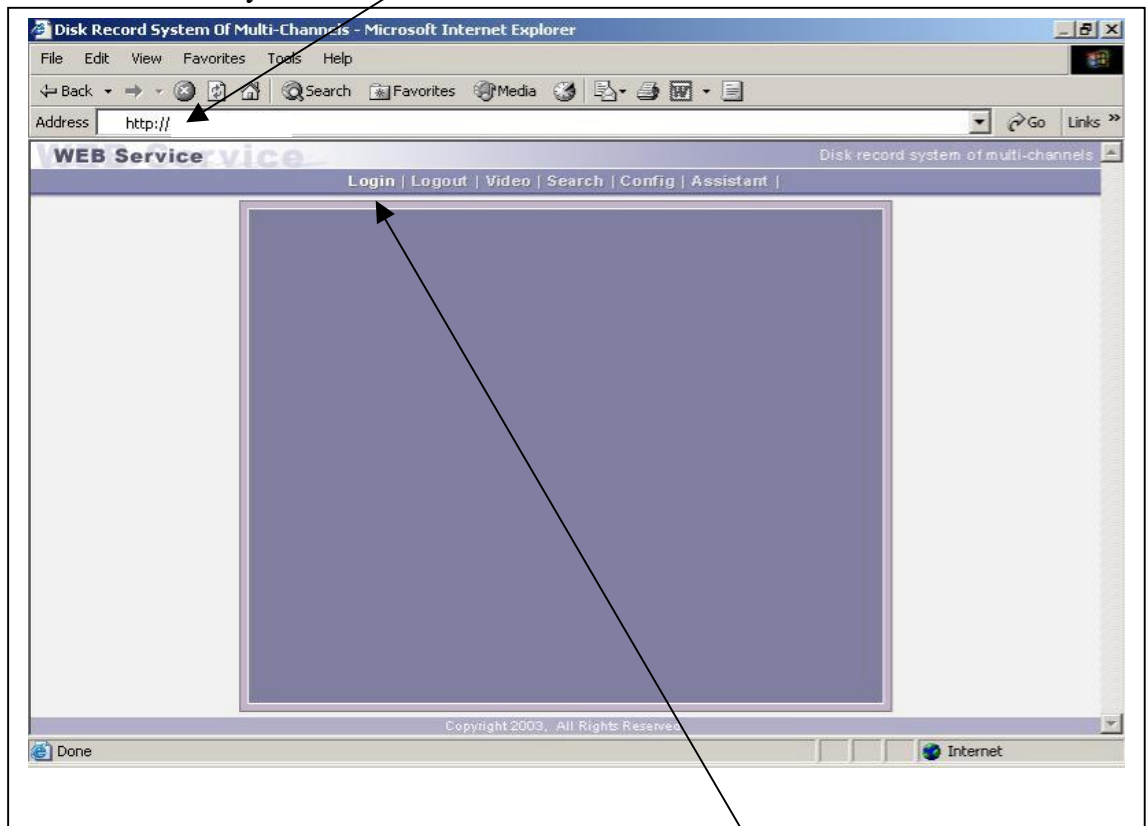

Using this interface you will see the following menus displayed across the top of the player window: **Login : Logout : Video : Search : Config : Assistant**
Login : Click Login and the following dialogue box will appear:

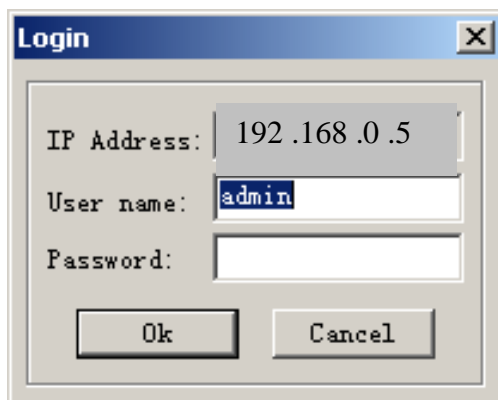

Input the username and password. There are three levels of users : Administrator, User and Guest. For detailed introduction see section on **User Manage** in Assistant setting. The default username = admin. The default password is left blank.

If the following dialogue box appears after inputting username and password, the system is indicating that the user has already logged on. Please log in using an alternative username.



If the following dialogue box pops up after inputting username and password, the system is indicating an invalid username or password has been entered.

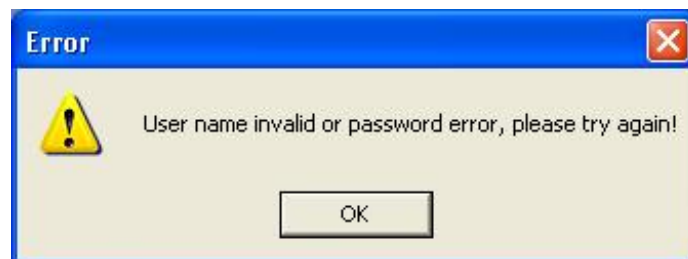

Log out : To logout please click the Logout button. When the Logout dialogue box pops up, select Yes to Logout.

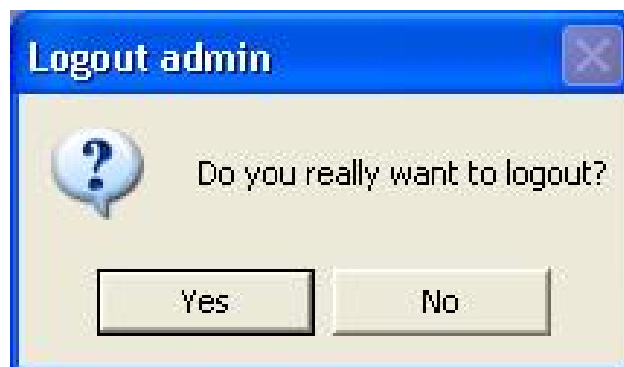

Once you have logged in as administrator the buttons Login, Logout, Video, Search, Config and Assistant are activated. Click the mouse right button and the following menu will be displayed:

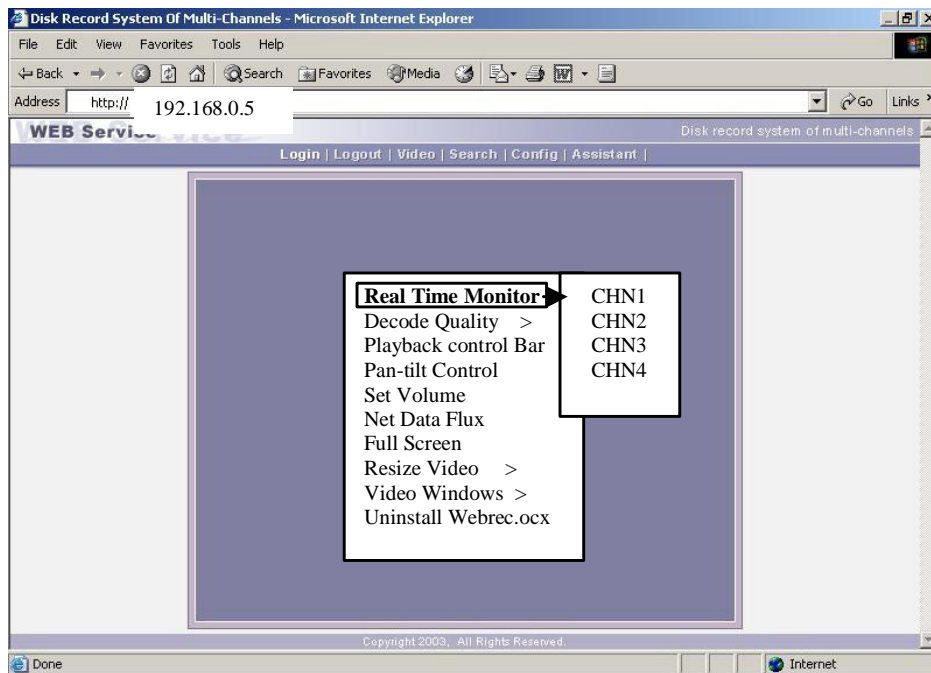

Real Time Monitor

This option allows you to select one of the four channels for monitoring. The channel name can be changed in the Assistant menu. If you right click the channel number an additional menu selection can be made available. The Prearrange set menu is inserted between Decode Quality and the Playback Control Bar menus. See details below in Pan-tilt Control option. Access will depend on your control rights.

Decode quality

Set the required decode quality.
There are four levels to choose from.

Playback Control Bar

See instructions on Playback Bar.

Pan-tilt Control

This allows the movement of the PTZ unit and includes zoom, focus and aperture settings. In order to use this facility you have to setup the PTZ menu for the address, protocol and baud rate of the PTZ unit in the DVR. A tour can be controlled by setting presets and then ticking the tour box. See the Prearrange set menu below.

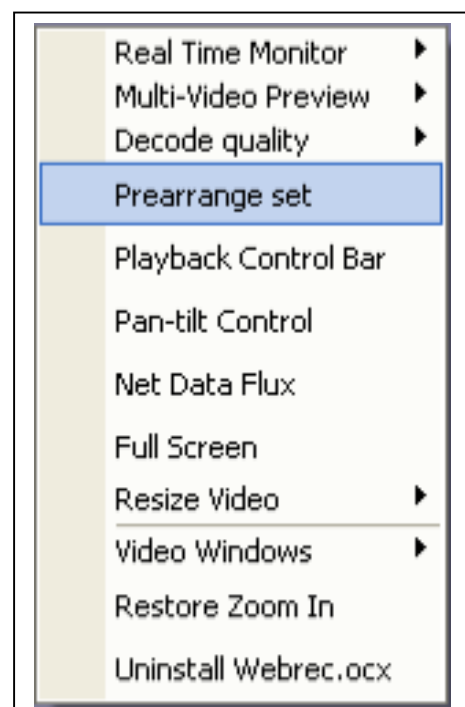

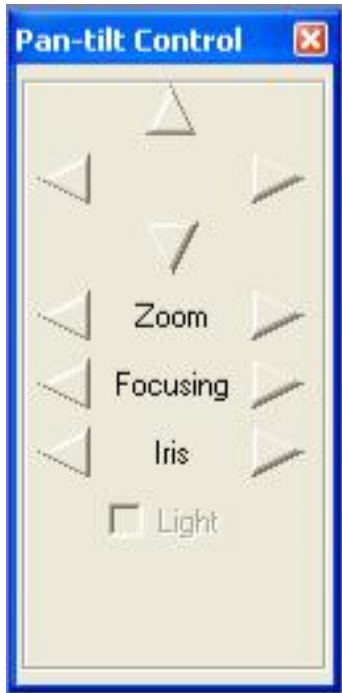

Move the camera to the prearranged position, then preset the position. Several positions can be chosen. If the check box near **tour** checked, the PTZ will cruise automatically between these positions.

Set Volume

This option control the audio volume. Drag the bar to adjust the volume or tick the Mute box to mute the sound.

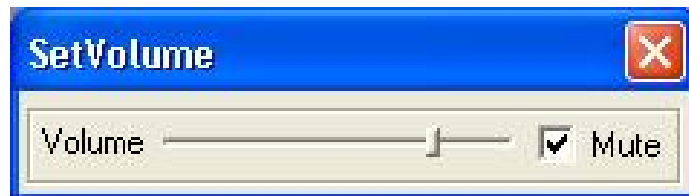

Net Data Flux

This options displays the network transmission data flux rate. When no network data transfer is occurring the display will show a zero rating.



Full Screen

There are two ways to select a full screen display. One is to double click the window directly; the other is to select **Full screen** in the right key menu. In multi-window mode, choose a window and double click in it.. It will then change to full screen mode.

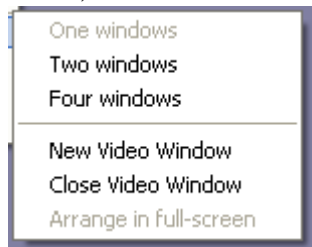

Resize video

In single window mode, the user can alter the video window ratio and size. In multi-window mode the user can see the change made.

Video windows

There are a selection of options. Either **One window**, **Two windows**, **Four windows**, **New Video Window**, **Close Video Window** and **Arrange in full screen**

New Video Window

When the number of video windows is less than 4, you can add a new video window manually.

Close Video Window

Close window monitoring.

Arrange in full-screen

If two or more windows are displayed, you can use this option to display multi-window in full screen.

Uninstall Webrec.ocx

Uninstall the Active X webrec.ocx before you upgrade the new web Active X.



SEARCH

Click on **SEARCH** and the following pop-up box will be displayed:

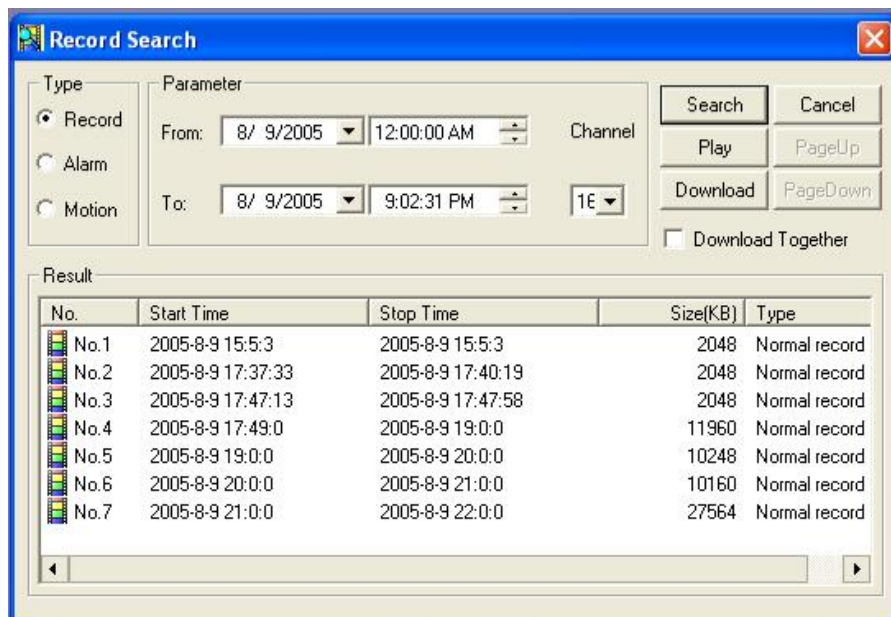

Now fill in the required info in the pop-up dialogue box. Select the Type of file being searched. This can be a schedule recorded file (Record), an Alarm record file (Alarm) or a motion detect file (Motion). Now enter date and time of start of selected incident in the **From** boxes, the end of the selected incident in the **To** boxes and the selected channel. Press **Search** and a list of the files found will be displayed in the Result screen. If only the From date and time is entered the Result screen will display all files for a 24 hour period from the time entered. The display will show only 15 files per page. Press **Page Up** or **Page Down** to scroll through pages of files found. Now double click the selected record and the file will be played. During the playback, you can operate the buttons in the playback bar like save record, stop save, capture picture, full screen. During playback on the video screen, the video displays the channel number, time and data flux of the record.

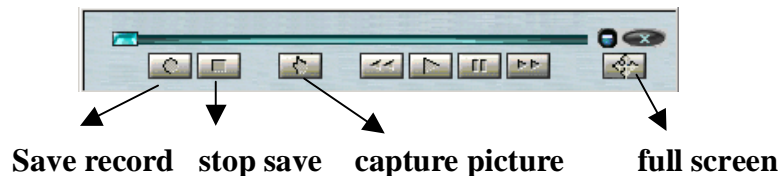

At the same time you can also perform a download to the C: drive on your P.C. by pressing the **Download** button.

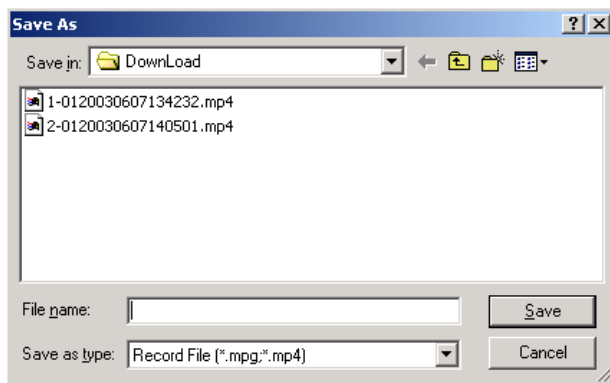

The filename will be downloaded to the PC under the default drive C:/ or drive/folder set on installation. Note that the file dialogue box allows you to enter a name for the downloaded file - for example Fred. The filenames downloaded will be in the following format:

C:/Program Files/Software Tools/DVR365/download/Fred-20060823113025[1].mpg

Fred-20060823113025[1].mpg

Fred = saved file name

2006

08 = Month

23 = Day

11 = Hours

30 = Minutes

25 = Seconds

[1] = file number

.mp4 = File Type *

*Note: Different versions of the software may produce .MP4, .dav or .mpg files. You can only playback these file/s using the DVR365 Client or Player software as the files are encrypted. The Player software downloaded from our website will allow you to re-record these files as AVI files for use with MS Media Player. MS Media Player will need the correct CODEC downloadable from the Microsoft Website.

Ensure you save the files. If you click the **Download Together** box you can select a number of files using the CTRL key and data will be written to one file.



CONFIGURATION

Click on **Config** and the DVR Menu will be displayed:

There are six submenus displayed. They are **GENERAL, SCHEDULE, IMAGE, ALARM, MOTION DETECT** and **VIDEO PARAMETER**. At the bottom of each menu page there is a **SAVE** button. If you wish to save into the whole configuration table press **SAVE CONFIG**. If you want to reload the complete configuration table then press **LOAD CONFIG**.

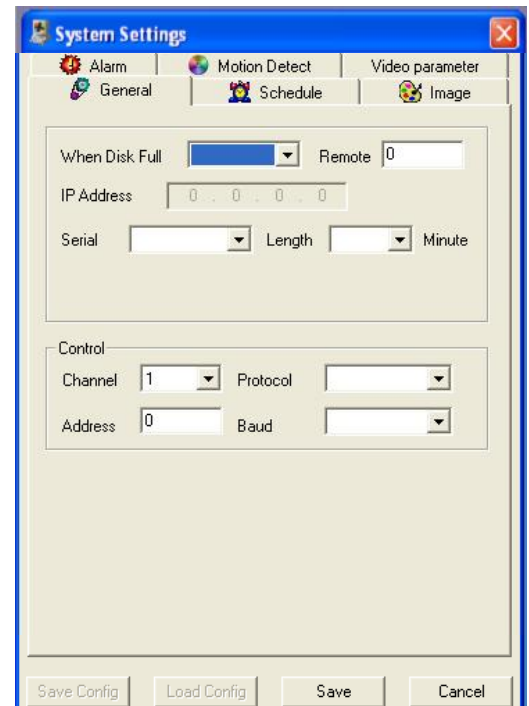

GENERAL

Disk Full - set to **OVERWRITE** or **STOP**
 Remote – set to **8** for use with a remote control
 IP Address – Greyed out – only modified at DVR
 Serial - Record length setting – set record time length
 Control PTZ – Set channel, protocol, address & baud rate

SCHEDULE

The **SCHEDULE** menu allows you to set per channel, the day of the week and the time period for continuous recording. There are two time periods per 24 hour period for continuous recording. The two slots must not overlap each other. If continuous 24 hour recording is required use only Time 1 slot and set State to ON.

A similar menu setting is available for setting Motion Detect. Again there are two time periods available per 24 hour period. Set the **STATE** to ON for the required timeslot. Ensure that slots do not overlap each other.

NOTE: You must not overlap any timeslots across the SCHEDULE and/or MOTION DETECT timeslots.

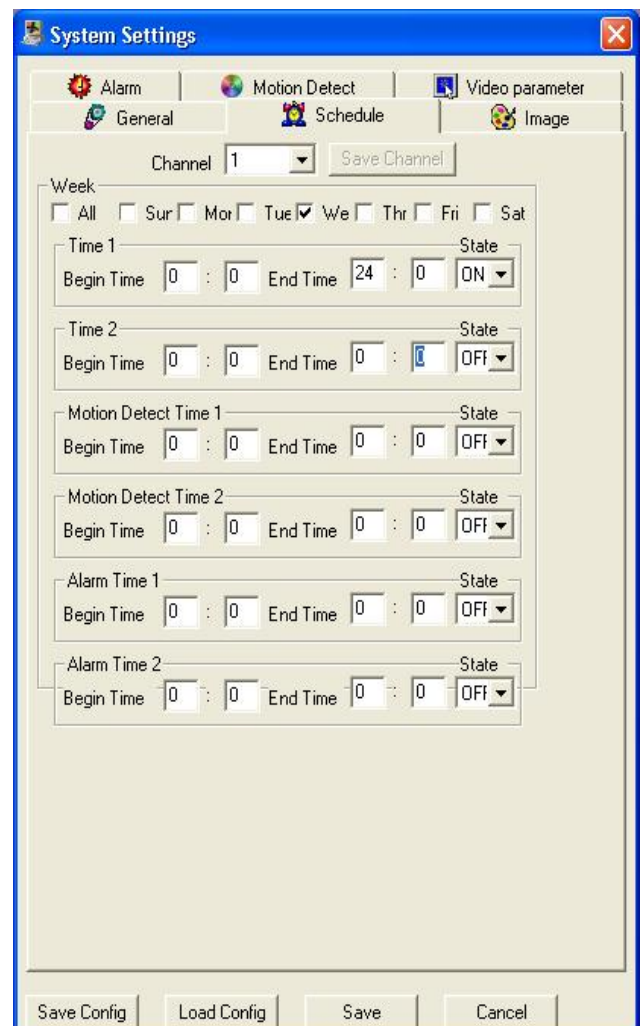

IMAGE

This menu can select the channel, frame rate, bit transfer method and resolution quality and you can set the option to alarm you when a video loss on this channel is detected. Click Save to save the setting of this channel. Finally, click Save Config to save all settings.

Channel – select channel number

Rate – The Frame Rate for this channel. The total frame rate for this unit is 50FPS (frames Per Second) but you must deduct 14FPS for the two audio channels. This leaves a total of 36FPS over four video channels. You can select variable frame rates for each channel up to the total of 36FPS. E.g CH1-25, CH2-3, CH3-4 and CH4-4 FPS. Select from 1/10, 1/5, 1/2, 1, 2, 3, 4, 5, 6, 8, 10, 12, 15, 20 & 25 Frames Per Second.

Style – Set to VBR (Variable Bit Rate) or CBR (Constant Bit Rate). Use VBR for network access – LAN or WAN.

Quality – Image Quality – set from 1 ~6.

When in VBR style, there are 1,2,3,4,5, & 6 levels of image quality. Level 6 is the highest quality but transmission loading is also the highest. When in CBR style, the selectable data flux settings are 128Kb/S, 256Kb/S, 384Kb/S, 512Kb/S, 768 Kb/S or 1024Kb/S.

Alarm when video lost

Off means no alarm. **On** means alarm when video lost.

Network Transport Protocol

Monitor and Playback

Only the TCP protocol is supported. A maximum of two TCP users are allowed.

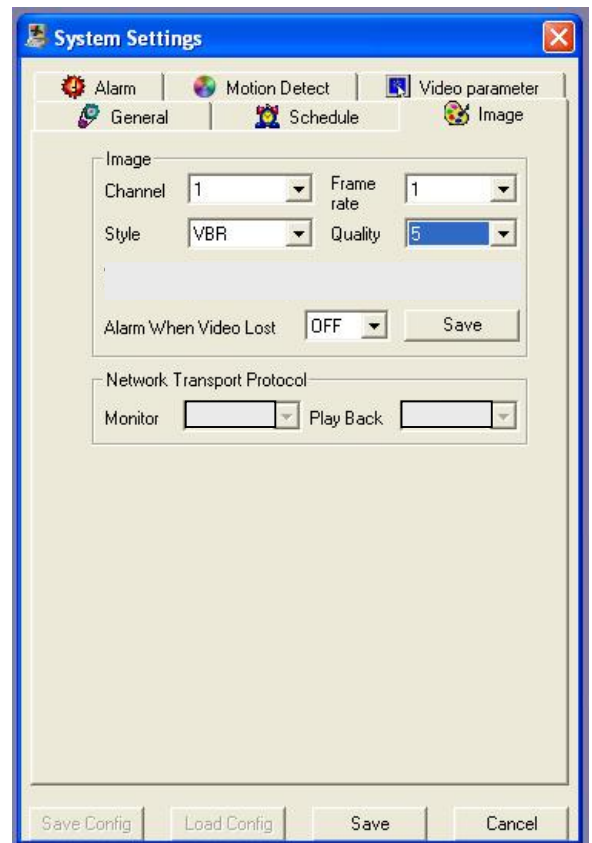

ALARM

When there are alarm input signals, the user can select the recording channel and the output port. There are 8 alarm input ports on this unit and 2 alarm output ports.

Alarm Port Set alarm input port – channel 1 ~ channel 8.

Record Channel – select record channel 1 ~ 4 for channel to record.

Output Port – select output port 1 or 2 for triggering output device.

Click SAVE to save menu page.

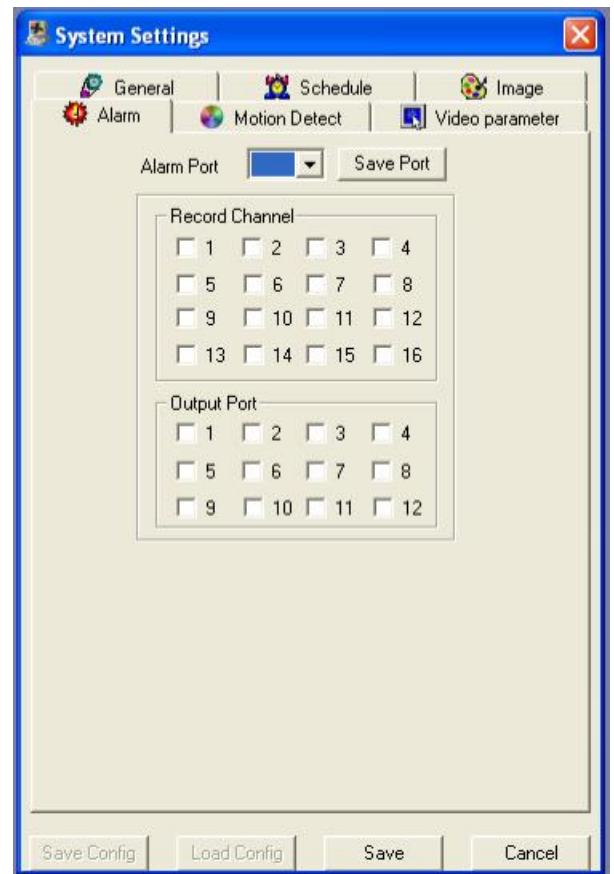

MOTION DETECT

When the user sets an MD time period (the time period cannot overlap any schedule time recording. The schedule recording always takes higher priority) motion detection will take effect.

The purple area in this menu is the selectable motion detection area. Users can move the cursor to select any area where MD is not required e.g bushes and trees or across lower section of display avoiding movement by animals, and can also set the sensitivity of the area.

Full Screen – Click Full Screen or press right mouse key on motion detection area to display full screen detection area.

Channel – Enter channel for MD

Delay time – This is the time in seconds unit will continue recording following end of MD. Recommend setting at 180 secs.

Sensitivity - MD sensitivity Low, Normal or High.

Alarm Output – Set alarm output channel when MD is activated.

Recorded Video – set channels to record when MD activated. If you use this ensure that scheduling recording is set off.

Save Channel or Clear – After setting MD area click on Save Channel or Clear to clear setting.

Save – save all settings

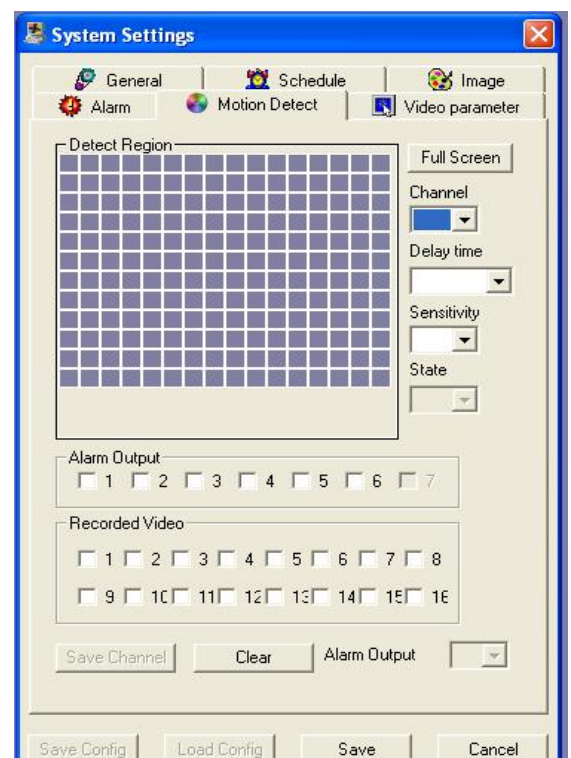

VIDEO PARAMETER

Configure the video parameters including Hue, Contrast, Brightness and Saturation for the respective channel. Click reset to return to factory default. Click SAVE to save channel and SAVE at bottom of menu to save all settings.





ASSISTANT

Click on the Assistant setting and the menu on the right will be displayed. The following option headings are described in detail but summarised as follows:

- User Manage** – set users and their rights
- Record Control** – Emergency manual record option
- Apply for Control Right** – force control
- Log Information** – system log info
- System Information** – basic system info
- Alarm Prompt** – select audio alarm sound
- Channel Name** – set a name for a channel
- Upgrade BIOS** – upgrade BIOS & Web Software
- About DS-IRECClient** -

Digital Video Recorder	<ul style="list-style-type: none"> User Manage Record Control Apply for Control Right Log Information System Information Alarm Prompt Channel Name Upgrade BIOS About DS-IRECClient
-------------------------------	--

USER MANAGE

Displays user information. The right buttons can let an administrator user save, add, modify, delete and cancel the information. Three user levels: **Administrator**—fully set the system and modify any user information; **User**—can not set system parameter and modify other users’ information; **Guest**—can not set system parameters and search records. Can only modify personal information. You can **Add**, **Modify** or **Delete** user information.

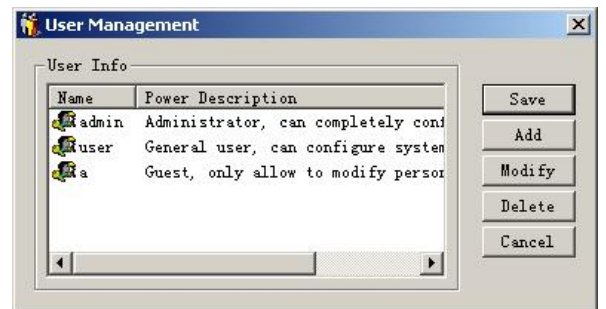

USER MANAGE - ADD

Click **Add** to show the following dialogue box:

User can add user information in this dialogue box, assign user power level. There is only one administrator allowed.



The 'Add User' dialog box has a blue title bar with a close button. The main area is titled 'User Info' and contains four input fields: 'Name', 'Password', 'Confirm', and 'Power'. The 'Power' field is a dropdown menu currently showing 'User'. At the bottom right, there are 'OK' and 'Cancel' buttons.

USER MANAGE – MODIFY & DELETE

User can modify their password. The Administrator can modify password and power rights of each user.

The DELETE option is similar but only the Administrator can delete any user.



The 'Modify User' dialog box has a blue title bar with a close button. The main area is titled 'User Info' and contains four input fields: 'Name', 'Password', 'Confirm', and 'Power'. The 'Power' field is a dropdown menu currently showing 'User'. At the bottom right, there are 'OK' and 'Cancel' buttons.

RECORD CONTROL

This option allows the manual recording of a channel and replaces the existing schedule, motion or event recording setting.



The 'Record Control' dialog box has a blue title bar with a close button. The main area is titled 'Record' and contains a table with four rows and two columns. The first column lists 'Channel1', 'Channel2', 'Channel3', and 'Channel4'. The second column has two radio buttons for each row, labeled 'Stop' and 'Start'. The 'Start' radio button is selected for all channels. To the right of the table are 'OK' and 'Cancel' buttons.

APPLY FOR CONTROL RIGHT

The Web client allows multiple user logins. If you want control power, click on this option to acquire control authority. If a user wants control power, the user must gain control authorisation from the user with control power. If the Administrator logs on, he or she can gain control power by force. If only one user logs in or the logged-in user is the user with control power, the box is greyed out.



The 'Apply For Control Right' dialog box has a blue title bar with a close button. The main area is titled 'Action' and contains two radio buttons: 'Apply' and 'Force To Apply'. The 'Apply' radio button is selected. To the right of the radio buttons are 'OK' and 'Cancel' buttons.

LOG INFORMATION

All the operations on the system are recorded in the log information table. An option to save the log is available by pressing the Save Log button. Note this option is available dependent on software level.

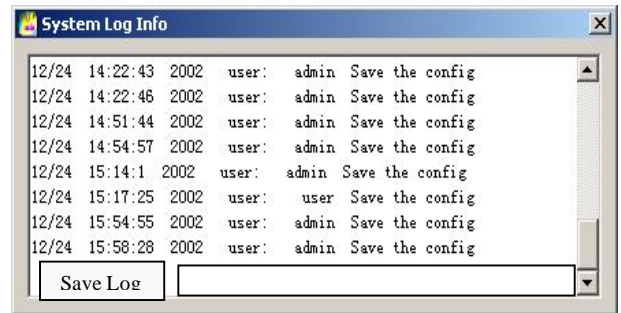

SYSTEM INFORMATION

System Information displays the basic info about your system. You can use this menu to turn on or off the audio facility. Due to the bandwidth limitation on this unit you can change the video transport mode from Real Time to a single frame extract. When in Real Time mode the network data flux statistics are displayed.

You can also set permanently the video type to PAL or NTSC mode.

If you want to initiate sequencing click on the Auto Recycle Monitoring facility open box and set the interval time in seconds for the dwell time.

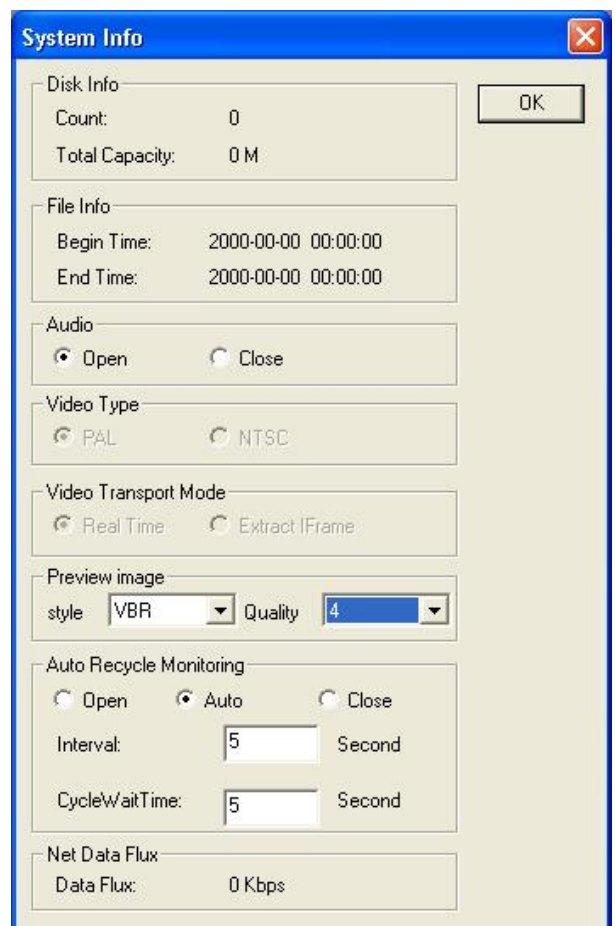

ALARM PROMPT

The user can select a different warning alarm sound by clicking on **Select audio** and choosing an audio file in the System32 directory. The audio file currently used is AlarmSound.wav.

Various alarm prompts are also selectable by clicking on the relative option.



CHANNEL NAME

This option allows the user to name each channel. The revised channel names will be displayed on the screen. The default setting is CHN1, CHN2, CHN3 & CHN4

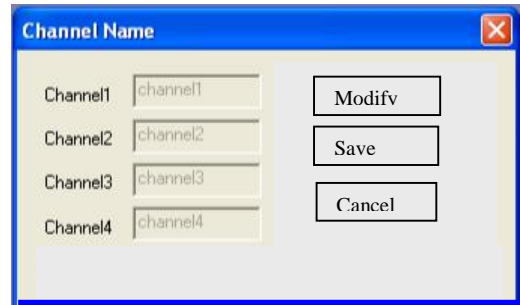

UPGRADE BIOS

You are able to upgrade the BIOS and Web software using this facility. Click on Open File, open the related program file, add it to address line and click the corresponding button to send. The system will automatically identify the file for upgrading. There are software upgrade methods for BIOS, Web and Boot options.

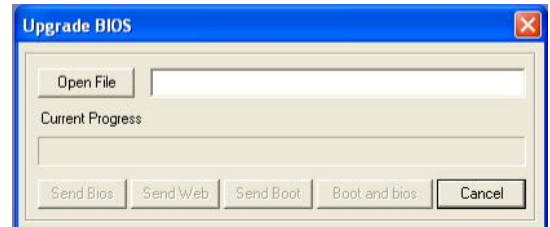

ABOUT WEBRECCLIENT

This option provides information about the WebClient Control version and the BIOS version.



PLAYBACK OF CD-ROM

When the backup CD has been created, you may wish to view the recording. You will need to have either the Client software or the Player software loaded on your P.C as the recorded data is encrypted and can only be viewed via this software. Using the client software, double click on the DVR365 icon.

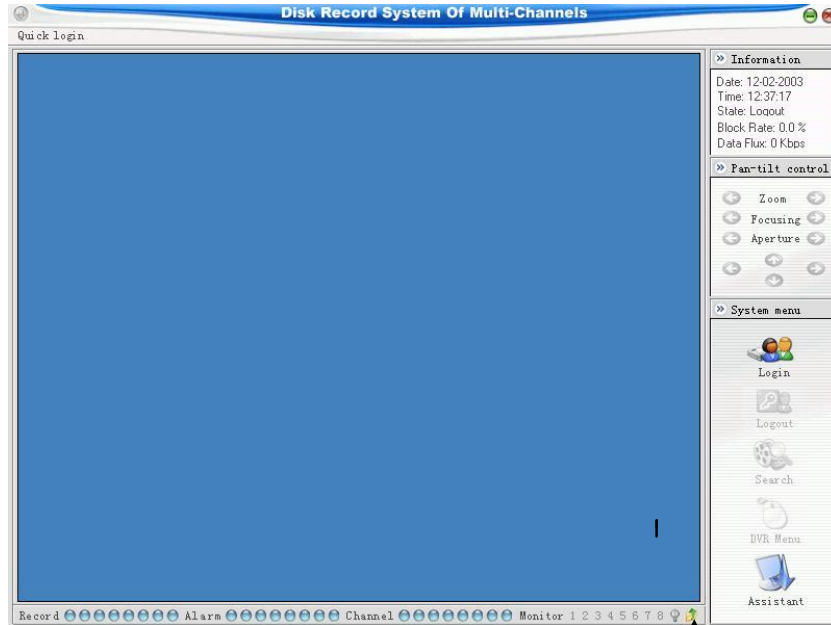

Click here

You should now see a playback module. The right hand buttons can be used to view the recording or you can record part of a video direct to your HDD by pressing the first left hand button Save Record, followed by the second Stop Save button. This is saved to C:\download. To capture a still frame, press Pause followed by Capture.

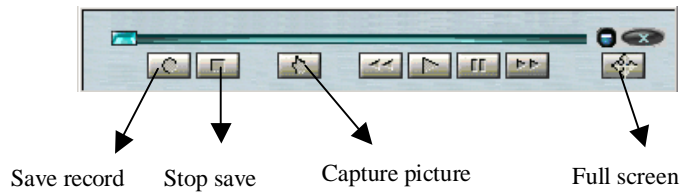

SETTING UP THE CLIENT SOFTWARE

There are two ways in which you can access the DVR over a network; one way is to use the client software that is provided on the CD, the other way is to use Internet Explorer as previously explained.

Using the client software

Once you have installed the software on your PC, there should be an icon on your desktop that points top the software.

Once you have opened the software you will see the following interface on your monitor:

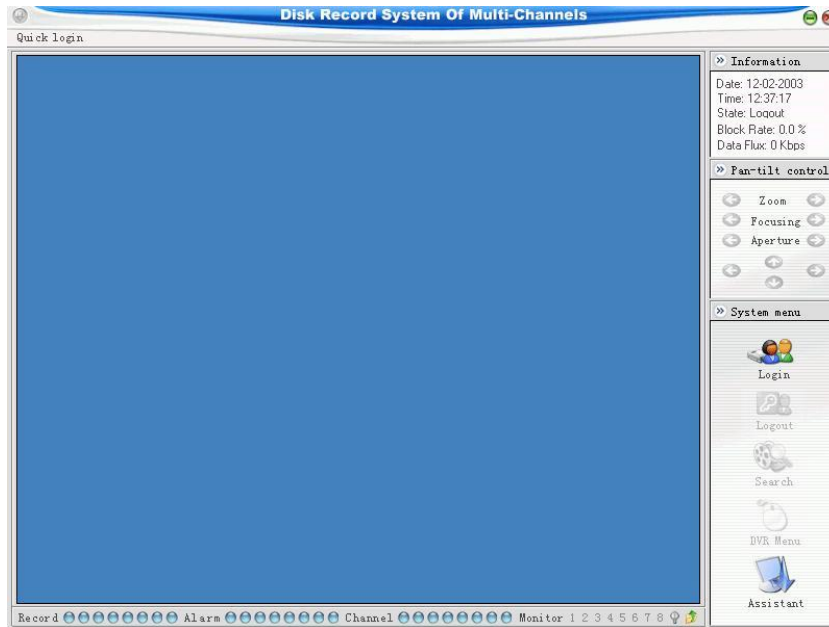

Now click on the Login icon

The following menu is now opened.



Click on the Network Login then click OK

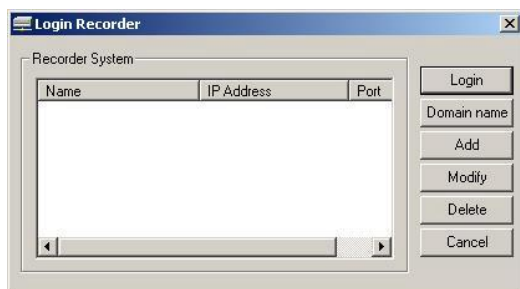

This menu allows you to add the IP number of the DVR you are accessing
Click on the Add button.



Enter a Name for your DVR, then enter the IP number and press OK (the Port number is defaulted to 37777)

NOTE: The IP address must be obtained from the Network Administrator if the DVR is to be used on an existing network.

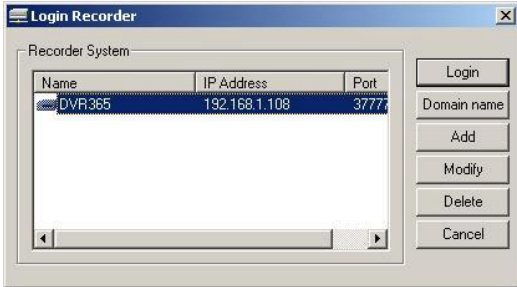

You can now click on the Login button; you will be prompted for the username and password:

The default Username is admin (lower case)

The default Password is blank so just hit OK



You should now be logged into the DVR.

The first task you should complete is to change the default administrator User & Password and add a general user. This is done through the Assistant>User Manager

The software allows you to have full control over the DVR.

Frequently Asked Questions

1. Why does the buzzer sound continuously?

When the machine is started successfully, it will give a short buzz.
If a HDD could not be identified, it would give a long continuous buzz.

2. Recording time is erratic?

This is a common fault where the timing settings for each channel and individual day are not correctly set in the menu. The best approach is to set all the channels to an off state and then set them up one by one, especially for motion detection. Set-up and confirm just one channel is working correctly before introducing any other channels.

3. The indicator light is flashing while recording

Check the external video input signal first. This could happen if there is a lack of video due to a poor connection or camera failure. If this is not the problem it can also be caused by the reading speed of the HDD being too slow. This is unlikely to be caused by pre-fitted hard drives.

4. Data Corruption on the HDD

If a bad or corrupt sector of a HDD is detected and the affected area of disk is not too large, the machine will automatically ignore it and bypass it. Otherwise the system will reject the HDD and will output corresponding information.

5. What kind of external equipment could work with the recorder?

It will work together with a variety of matrix and decoder cards for PTZ operation.
It will interface with many USB memory sticks. USB 1.1 memory sticks have been tested successfully. Not all memory sticks are compatible. It will interface directly through a P.C, or via a LAN or via a high speed Broadband Link.

6. Why is the unit producing a background noise?

Just like a P.C the Tardis needs cooling. There are two fans located in the Tardis. If the unit has a restricted air flow, the unit may run hot and consequently the fan bearing lubrication dries out causing fan noise.

7. Why is the schedule recording not allowed?

The start time and end time settings have to be set in one 24 hour period. They must not be set across two days e.g 08:00 – 08:00 but 00:00 – 24:00. You are allowed two scheduled timeslots in each 24 hour period.

8. Why am I having problems backing up data?

Only admin users can backup data. You can backup data to a CD writer *but not a combo unit with DVD or a DVD writer*. Alternatively you can backup to a memory stick. You must ensure that you are using a formatted USB memory stick and that the memory stick does not contain any other file types. Only use the upper USB slot for backup purposes on the back of this unit.

9. What record frame rates can I use on this unit?

The CCT772/771 utilises 50 FPS (frames per second.) Two audio channels use 7 FPS each, thus leaving 36 FPS spread over the remaining channels. You could therefore allocate one channel at 25 FPS, one at 3 FPS and two channels at 4 FPS each = $25 + 3 + 4 + 4 = 36$ FPS.

Appendix A - Recording Times with various HDD drives.

LOW RES SETTING 1	Gb/Hr	80Gb	160Gb	200Gb	250Gb	300Gb	400Gb
1 -4 cameras & 2 x audio	0.07	47 days (1.5 months)	95 days (3.0 months)	119 days (3.8 months)	148 days (4.8 months)	178 days (5.7 months)	238 days (7.6 months)

MEDIUM RES SETTING 4	Gb/Hr	80Gb	160Gb	200Gb	250Gb	300Gb	400Gb
1 -4 cameras & 2x audio	0.25	13 days	26 days	33 days (1.1 months)	41 days (1.3 months)	50 days (1.6 months)	66 days (2.1 months)

HIGH RES SETTING 6	Gb/Hr	80Gb	160Gb	200Gb	250Gb	300Gb	400Gb
1 -4 cameras & 2 x audio	0.5	6 days	13 days	16 days	20 days	25 days	33days (1.1 months)

NOTE: This TARDIS records at 50 Frames Per Second (FPS) overall but 14 FPS are used for two audio channels whether they are used or not. The remaining 36 FPS can be used across the four video channels. For example you can have four channels at 9FPS each. Alternatively you could have one channel at 25 FPS, one at 3 FPS and two channels at 4 FPS. If you only have three cameras connected you could have three channels at 12 FPS.

The charts above therefore show the amount of time available before disk overwriting begins. Note that these calculations are based on MPEG-4 compression with image resolution at 1CIF 352x288. These timings are only approximate and can vary according to data content. The timings above should represent the minimum recording times possible.