

Honeywell

Portable Evaporative Air Cooler for Indoor Use

OWNER'S MANUAL

Read and save these instructions before use

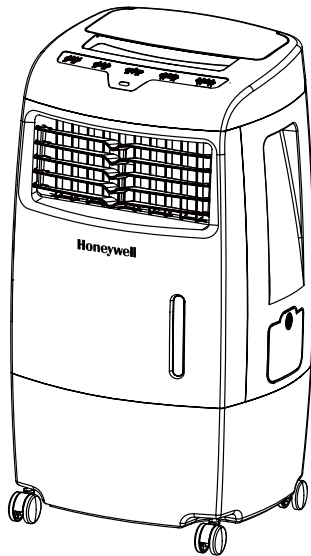

Model: CL25AE

Power rating: 230 Watts
Voltage rating: 120 Volt AC, 60Hz

For product inquiries or support, visit www.honeywellaircoolers.com

Customer Support : 1-800-474-2147

Made in P.R.C.



Fill with water and plug into a standard power outlet.

Note: Please make sure the household power voltage matches the product specifications.



Place near an open door or window.

Note : Evaporative air cooler requires cross ventilation.



Turn ON and enjoy the cooling breeze.

Note: Start with LOW speed and gradually increase to higher speed for optimum cooling performance.

Read all instructions carefully before setting up and operating the cooler, and please keep this instruction manual for future reference. This manual is designed to provide you with important information needed to setup, operate, maintain, and troubleshoot your cooler. Failure to follow these instructions may damage and/or impair its operation and void the warranty.

SECTION	PAGE
1. THANK YOU	2
2. USER TIPS	3
3. SAFETY	5
4. PARTS DESCRIPTION	7
5. USE & OPERATION	8
Control Panel	8
Function Buttons	9
Room Cooling And Humidifying	11
Remote Control	12
Filling Water	13
6. CLEANING & MAINTENANCE	14
7. TROUBLESHOOTING GUIDE	16
8. TECHNICAL SPECIFICATIONS	18
9. ELECTRICAL WIRING DIAGRAM	19
10.SERVICE AND WARRANTY	20

Congratulations on your purchase of this versatile Honeywell Evaporative Air Cooler. For optimum cooling from your cooler, fill the water tank to maximum level and load ice inside the ice compartment before you turn on your air cooler.

Cooler Location (Important - Please Read!)

Place the cooler in front of an open door or window. Ensure that there is adequate cross-ventilation in the room by leaving a door or window open opposite the cooler.

Following these guideline will ensure your cooler will work as effectively as possible.

Not an Air Conditioner (Important - Please Read!)

The evaporative air cooler is not an air conditioner as it does not use a compressor or refrigerant gas. It should not be expected to cool as efficiently as a refrigerated air conditioner.

USER TIPS

Energy Efficient, No Compressor

Honeywell Evaporative Air Coolers are built to maximize energy efficiency and keep costs low. Warm air is drawn into the cooler through a dust and odor-reducing carbon filter and enters the Honeycomb Cooling Media. Water pumped from the tank pours over the honeycomb media. As the warm air passes through the media, the water absorbs the heat, naturally cooling and humidifying the air. A fan propels the cooled air out into the room. This no-compressor system cools naturally, efficiently and inexpensively.

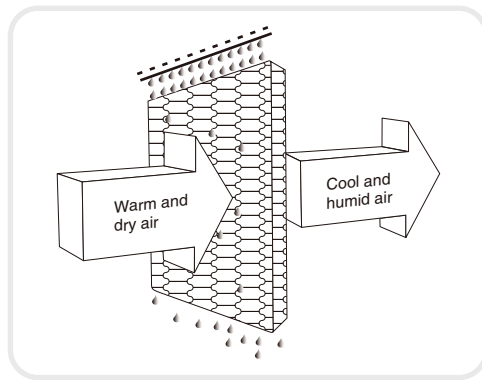
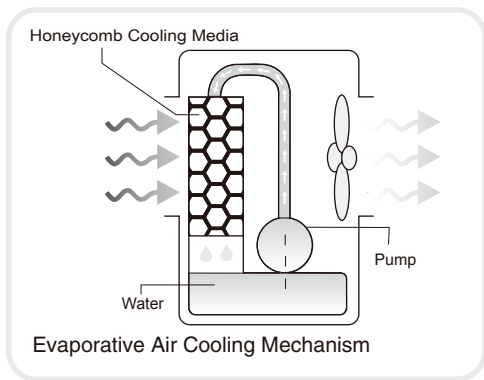

The recommended maximum relative humidity level is 60% or less, which allows a noticeable temperature decrease. The temperature decrease will be greater in drier climates because higher evaporation occurs when the humidity is low.

The evaporative air cooler should not be used in enclosed spaces. It must be kept level and there must be water in the water tank. The room should have doors and windows opened to allow free air flow. The evaporative air cooler works best when placed near an open window, so that outside air is drawn into the evaporative air cooler, the air circulates in the room, then exits via the door. The maximum cooling effect is felt when a person is in the flow of air coming out of the evaporative air cooler.

The evaporative air cooler can also be used to humidify dry air during cool weather. To be used for humidification the windows and doors should be closed to allow the humidified air to accumulate.



Room with open windows & door
(RECOMMENDED)



Room with closed windows & door
(NOT-RECOMMENDED)

NOTE

When the product is used for the first time the Honeycomb Cooling Media will have an odor which will dissipate in a few hours or so of initial use.



SAFETY

READ AND SAVE THESE INSTRUCTIONS:

When using electrical appliances, basic safety precautions should always be followed:

- Your cooler runs on 120 Volt AC, 60 Hz current. Check the household voltage to ensure it matches the appliance's rate specification.
- Before operating the product remove it from its packaging and check that it is in good condition.
- DO NOT operate any product with a damaged cord or plug.
- DO NOT run power cord under carpeting, or cover it with rugs or runners. Keep the cord away from areas where it may be tripped over.
- Always unplug the product before refilling the water tank.
- Always unplug the appliance from the power source before cleaning, servicing or relocating the unit.
- Remove the power cord from the electrical receptacle by grasping and pulling on the power cord plug-end only, never pull the cord.
- DO NOT use the product in areas where gasoline, paint or other flammable goods and objects are stored.
- When using the "COOL" setting, check the water tank to ensure that it is full. Operation of this cooler on the "COOL" setting with an empty tank may result in damage to the water pump.



120V - 60 Hz

SHOCK HAZARD

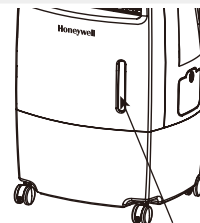

WATER LEVEL INDICATOR

- DO NOT attempt to repair or adjust any electrical or mechanical functions of the cooler, as this may void the warranty.
- DO NOT cover the air inlet or outlet on the appliance as this may cause motor damage.
- DO NOT insert or allow objects to enter any ventilation or exhaust opening as this may damage the product and could cause an electrical shock or fire.
- DO NOT operate with the Honeycomb Media removed as this will overload and damage the motor.
- DO NOT leave the operating appliance unattended for any extended period of time.
- DO NOT let children play with this appliance, packaging or plastic bags.
- If the unit is damaged or it malfunctions, do not continue to operate it. Refer to the troubleshooting section and seek professional advice.
- Place the unit on a level floor.
- This product is not intended for use in wet or damp locations.
- DO NOT use in bathrooms. Never locate the product where it may fall into a bathtub or other water container.
- Store in a dry area when not in use.
- This appliance is not intended for use by persons (including children or elderly) with reduced physical, sensory or mental capabilities, or lack of experience and knowledge, unless they have been given supervision or instruction concerning use of the appliance by a person responsible for their safety.
- Always grip the side handles to move the cooler.

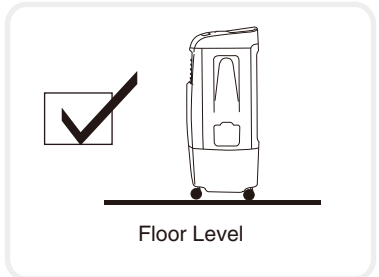

PARTS DESCRIPTION

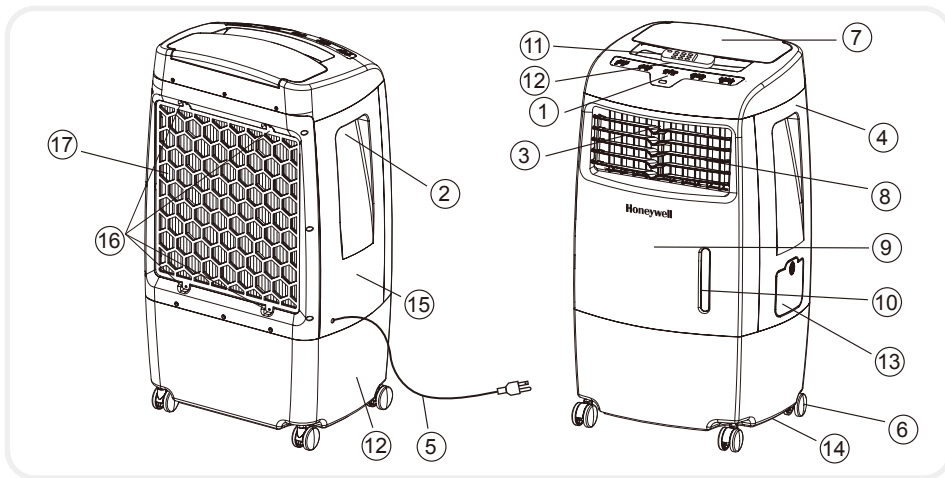

- | | |
|---|---|
| 1 Control Panel | 9 Front Panel |
| 2 Side Handle | 10 Water Level Indicator |
| 3 Horizontal Louvers
(Manual Adjustment) | 11 Remote Control |
| 4 Left Side Panel | 12 Water Tank |
| 5 Power Cord & Plug | 13 Water Fill Door |
| 6 Casters | 14 Drain Plug |
| 7 Ice Compartment Lid | 15 Right Side Panel |
| 8 Vertical Louvers
(Automatic Movement with SWING) | 16 Rear Grill Removal Screws |
| | 17 Carbon Filter &
Honeycomb cooling media |

ACCESSORIES:

Remote Control (Batteries not included)

Control Panel



Function Buttons

Power

Press the POWER button to turn the unit on. The cooler will start automatically at medium speed. After a few seconds the speed will switch to low. To turn the unit off, press the button again.



Speed

Press the 'SPEED' button repeatedly and the speed will change. The indicator light will show the selected speed. High (Hi), Medium (Med), Low (Lo) & Sleep. Sleep setting is for comfort during the night; cooler runs on high speed for 1 hr, medium speed for 1 hr and then remains in low speed.

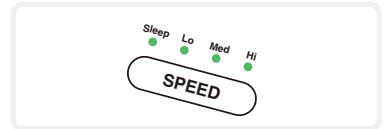

Mode

Press the 'MODE' button to switch the air cooler between FAN and COOL modes.

Cool Mode: To begin cooling the desired area, press the MODE button. The indicator light on COOL will come on and the water pump will operate. You will feel the cooler air after the honeycomb media is completely wet.

Fan Mode: To switch on the FAN only mode, press the MODE button again and the indicator light on FAN will come on.

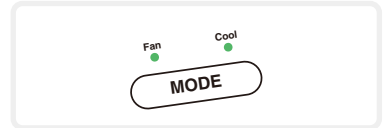

Timer

Press the "TIMER" button until the indicator light comes on to your desired time. Once the set time has passed, the unit will automatically shut off. The Timer function allows you to program the unit for up to 7.5 hours of use.

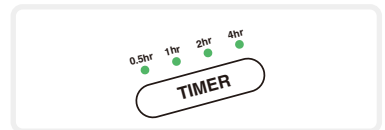

Swing

Press the "SWING " button. The indicator light will come on and the louvers will begin to move from right to left automatically.

Manually adjust the horizontal louvers to change vertical airflow.



Low Water Alarm (Will activate in COOL Only mode)

The unit is equipped with a low water sensor. When water in the tank is below the minimum level, you will hear 10 beeps and the TANK EMPTY LED indicator will flash continuously. At the same time, the power to the pump inside the unit will be cut off to protect the life of the pump.

To disengage the alarm function, turn off the unit from the power outlet. Fill the tank with water above the minimum level and turn on the unit.

To turn off the alarm function and continue to use it in FAN mode, turn off the unit and turn the unit on. If COOL button is pressed again without filling the tank with water, low water alarm will activate again.

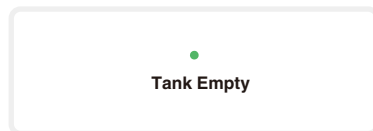

Remote Control

- Power : On/ Off
Speed : Low / Medium / High / Sleep
Mode : Controls cooling or fan option
Swing : Controls the motion of the vertical louvers
Timer : Controls timer function for automatic shut off

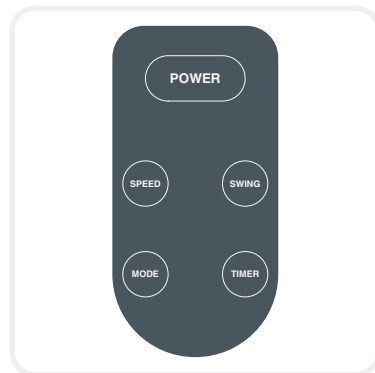

Remote Control (Batteries not included)

NOTE

- Open the battery compartment at the back of the remote control and insert two new AAA dry cell batteries. Care must be taken to insert the batteries according to the correct polarity (+ / -) markings shown inside the battery compartment.
- Always point the remote control signal transmitter towards the unit when operating.
- Make sure that the signal path is not obstructed.
- Remove the batteries if the unit is not going to be used for an extended period of time.
- Do not drop the remote control.
- Non-rechargeable batteries are not to be recharged.
- Do not mix different types of batteries such as alkaline, carbon-zinc, or rechargeable batteries.
- Do not mix old and new batteries.
- Exhausted batteries are to be removed from the product.



Room Cooling And Humidifying

When the Water Regulator is set to "MIN", the water pump distributes minimal amount of water to the Honeycomb Media. This results in less water evaporation and reduces cooling effect.

When the Water Regulator is set to "MAX", the water pump distributes the maximum amount of water to the Honeycomb Media. This results in maximum water evaporation and the cooling performance improves.

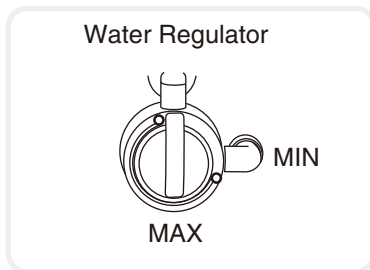

CAUTION

Unplug from power when refilling.



Filling With Water

Unplug the air cooler from power supply.

Check water level indicator located on the front of the unit to determine the level of water inside the water tank. The water tank of this cooler holds up to 6.6 gallons of water. Be sure water in the tank is always above the minimum water level mark.

To refill the water tank, open the Water Fill Door located below the left side panel and fill water to the Max Level, as indicated on the Water Level Indicator. Do not fill water above the Max water level mark.

For better cooling performance, it is recommended to put ice cubes inside the ice compartment located on the top of the cooler.

After refilling the water tank and loading ice, close the water fill door, connect the power supply and turn on.

Note :

Running the unit with inadequate water may cause pump failure.

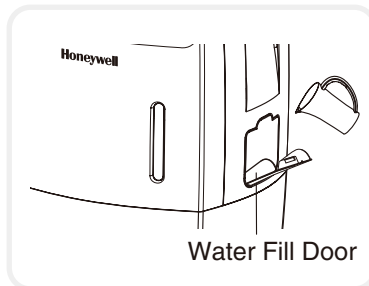

Important



- The cooler is supplied with Honeycomb Cooling Media.
- The cleaning frequency for the Honeycomb Media depends on local air and water conditions. In areas where the mineral content of water is high, mineral deposits may build up on the Honeycomb Cooling Media and restrict air flow. Draining the water reservoir and refilling with fresh water at least once a week will help reduce mineral deposits. If mineral deposits remain on the Honeycomb Media, the Media should be removed and washed under fresh water. The Media should be cleaned every two months or sooner, depending on your needs.
- Do not run the unit in COOL mode with stale water in the tank. Empty the tank and refill it with fresh water if the water has been standing in the tank for an extended period of time.
- For best results, allow the Honeycomb Cooling Media to dry after each use by turning off the cool function 15 minutes before turning the unit off.

WARNING

- Before cleaning the unit, switch it to the "off" position and unplug from the power socket.
- To clean the outside, use a damp cloth to remove dirt and dust.
- Never use corrosive elements or any chemicals to clean this product.
- When the product is not in use, store the unit in a dry place out of direct sunlight.

CLEANING & MAINTENANCE

Draining and Cleaning The Water Tank

- Turn the power “off” and disconnect the air cooler from the power supply.
- Move the unit to a location where it can be drained.
- Remove the drain plug and allow the tank to empty (refer page 7., #14).
- Refill the water tank up to the maximum level with clean water and drain it completely.
- Fill water tank and rinse at least 2-3 times before use.
- After cleaning ensure that the drain plug is back in place.
- Plug into the power supply and turn on unit.

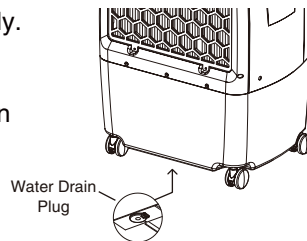

CLEANING THE HONEYCOMB COOLING MEDIA & CARBON FILTER

- Turn off the unit, and unplug the power cord from wall outlet.
- Rotate the unit facing the back panel, and locate the Rear Grill Removal Screws (refer page 7., #16). Remove the 4 screws with a screw driver.
- Pull the rear grill panel upwards, until it is completely removed.
- The Honeycomb cooling media & carbon filter can now be seen. Clean the carbon filter & honeycomb with clean cloth to remove all the dust & dirt particles.
- Once cleaning is finished, reassemble the unit as described above.
- Plug into the power supply and turn on unit.

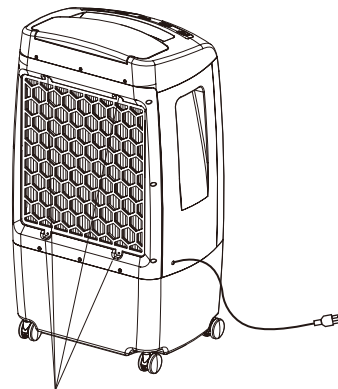

4 Rear Grill Removal Screws

The air cooler is now ready to be used. This cleaning process should be repeated monthly to maintain the integrity of the unit and to remove particles filtered from the air.

PROBLEM	POSSIBLE CAUSE	SOLUTION
No discharge of air	Cord is not plugged in.	Make sure power cord is plugged in and the supply switch is on.
	Power is not on.	Turn the unit ON by pressing button on the control panel.
Not Cooling / Unit is making noise	Pump is not turned ON.	On Control Panel, turn COOL FUNCTION to "ON".
	Low or no water in tank, when COOL is selected.	Refill water tank.
	Damaged Pump or Calcium deposits on blower.	Contact service center.
Odors	When the Cooler is new.	When the unit is used for the first time, the Honeycomb Cooling Media will have an odor, which will dissipate within a few hours of initial use.
	If the Cooler has been used.	There may be an algae issue. Replace the Honeycomb Cooling Media.

Customer Support: 1-800-474-2147

TROUBLESHOOTING GUIDE

PROBLEM	POSSIBLE CAUSE	SOLUTION
The unit does not respond to remote control	Remote control batteries.	Check batteries. Replace if needed. Try to operate using the control panel.
	Damaged PCB.	Try with remote control. If the unit responds, PCB board fasteners may be loose. Contact service center.
		If neither remote control nor control panel works, PCB board may be damaged. Contact service center.

Customer Support: 1-800-474-2147

TECHNICAL SPECIFICATIONS

MODEL NO.

CL25AE

Voltage	120 V
Frequency	60 Hz
Ampere	2.1A
Wattage	230 Watts
Water Tank Capacity	6.6 Gallons
Cooling Media	Honeycomb
Product Dimension (Inches)	18.9 (W) x 14.6 (D) x 33.4 (H)
Net Weight	25.4 lbs

ELECTRICAL WIRING DIAGRAM

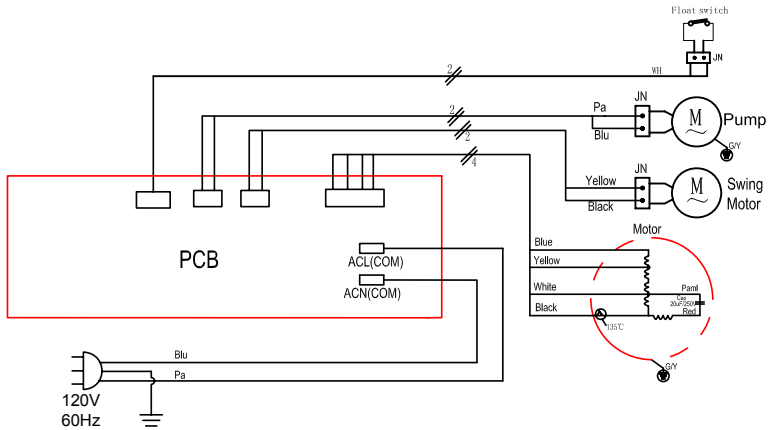

1-YEAR LIMITED WARRANTY

Read all the instructions before attempting to use this product.

This 1 year limited warranty applies to repair or replacement product found to be defective in material or workmanship.

- A. This warranty does not apply to any damage resulting from commercial, abusive, unreasonable use or supplemental damage. Defects that are the result of normal wear and tear will not be considered manufacturing defects under this warranty.

JMA NORTH AMERICA LLC IS NOT LIABLE FOR INCIDENTAL OR CONSEQUENTIAL DAMAGES OF ANY NATURE. ANY IMPLIED WARRANTY OF MERCHANTABILITY OR FITNESS FOR A PARTICULAR PURPOSE ON THIS PRODUCT IS LIMITED IN DURATION TO THE DURATION OF THIS WARRANTY.

Some jurisdictions do not allow the exclusion or limitation of incidental or consequential damages or limitations on how long an applied warranty lasts, so the above limitations or exclusions may not apply to you. This warranty gives you specific legal rights, and you also may have other rights which vary from jurisdiction to jurisdiction. This warranty applies only to the original purchaser of this product from the original date of purchase.

- B. At its option, JMA NORTH AMERICA LLC will repair or replace this product if it is found to be defective in material or workmanship.
- C. This warranty does not cover damage resulting from any unauthorized attempts to repair or from any use not in accordance with the instruction manual.

SERVICE AND WARRANTY

D. Please read the Instruction Manual carefully before setting up or using this product. If you believe this product to be suffering from a manufacturing fault, or if you have inquiries about this product, please contact our Customer Support:

CUSTOMER SUPPORT

JMA North America LLC
Ramsey, New Jersey, 07446.
Phone : 1-800-474-2147
Email : info@jmana.us

When contacting our Customer Support, please have the information below along with the proof of purchase. All warranty requests must be accompanied by a proof of purchase, which is a copy of the original receipt.

Model :
Date of purchase:
Purchased from :

Distributor:

JMA North America LLC

Ramsey New Jersey 07446

Customer Support: 1-800-474-2147

E-mail: info@jmana.us

www.honeywellaircoolers.com

November 2012; CL25AE_IM_Eng_HW_9

© 2012 AirTek International Corporation Ltd.

All rights reserved.

The Honeywell Trademark is used under license

from Honeywell International Inc.

Honeywell International Inc. makes no representations
or warranties with respect to this product.

This product is manufactured by Airtek Int'l Corp. Ltd

Honeywell