



NAVIGON 70 Plus
NAVIGON 70 Premium
NAVIGON 70 Premium Live
User's manual

English (United Kingdom)



August 2010



The crossed-out wheeled bin means that within the European Union the product must be taken to separate collection at the product end-of-life. This applies to your device but also to any enhancements marked with this symbol. Do not dispose of these products as unsorted municipal waste.

Imprint

NAVIGON AG
Schottmüllerstraße 20A
D-20251 Hamburg

The information contained herein may be changed at any time without prior notification. Neither this manual nor any parts thereof may be reproduced for any purpose whatsoever without the express written consent of NAVIGON AG, nor may they be transmitted in any form either electronically or mechanically, including photocopying and recording. All technical specifications, drawings etc. are subject to copyright law.

© 2010, NAVIGON AG

All rights reserved.

Table of contents

1	Introduction	8
1.1	About this manual	8
1.1.1	Conventions	8
1.1.2	Symbols	8
1.2	Legal notice.....	8
1.2.1	Liability	8
1.2.2	Trade marks	9
1.3	Questions about the product.....	9
2	Before you begin.....	9
2.1	Scope of Delivery	9
2.2	Description of the navigation device	10
2.3	Important safety information.....	10
2.3.1	Navigation safety information.....	10
2.3.2	Safety information for the navigation device	11
2.3.3	Safety guidelines when installing the device in your car	12
2.4	Preparing the navigation system for use.....	12
2.4.1	SIM card.....	12
2.4.2	Installing the navigation system in the vehicle	13
2.4.3	Memory card	15
2.5	Activating the NAVIGON Live services	16
2.6	Navigating with GPS	17
3	Switching on the navigation device	17
3.1	Manual	19
3.2	Options.....	20
4	Operating the navigation system	20
4.1	Information	20
4.2	Software keyboard	24
4.2.1	Special keys	24
4.2.2	Entering data.....	25
4.3	Options.....	26
4.4	Menus	26
5	Voice Command.....	26
5.1	Activating the voice commands function	27
5.2	Use Voice Command	27
5.3	Help.....	28
5.4	Deactivation of the voice commands function.....	28

5.5	Configuring the voice commands function	28
6	Navigation	29
6.1	Starting the navigation application	29
6.2	Specifying a destination	31
6.2.1	Specifying the country in which the destination is situated	31
6.2.2	Entering a destination by voice commands	32
6.2.3	Entering a destination address	33
6.2.4	Enter Coordinates	34
6.2.5	Points of interest	36
6.2.6	Information about the destination	40
6.2.7	Favourites	40
6.2.8	Last Destinations	41
6.2.9	Imported Addresses: Outlook / Internet	42
6.2.10	Imported Addresses from the phone book	42
6.2.11	Navigating home	43
6.2.12	Selecting destinations on the map	43
6.2.13	Route preview	44
6.3	Managing destinations	46
6.3.1	Saving destinations	46
6.3.2	Deleting a destination from the Favourites list	46
6.3.3	Defining the home address	47
6.3.4	Changing the home address	48
6.4	Tracks and multi-leg routes	48
6.4.1	Entering the starting point	48
6.4.2	Entering route points	49
6.4.3	Editing route points	50
6.4.4	Managing routes	50
6.4.5	Loading routes or tracks	50
6.4.6	Calculating and displaying routes	51
6.4.7	Simulating routes	51
6.4.8	Route preview	52
7	Options	54
8	Working with the map	57
8.1	Selecting the navigation map	57
8.2	Button bar	57
8.2.1	Static button bar	57
8.2.2	Dynamic button bar	58
8.3	Motion Sensor	59
8.3.1	Configuring the proximity sensor	60
8.4	Map in Standard mode	60
8.5	Map in Preview mode	61
8.6	Map in Navigation mode	63

8.6.1	Navigation in Vehicle mode	63
8.6.2	Navigation in Pedestrian mode	68
8.6.3	Navigation in Track mode	69
8.6.4	Navigation in Offroad mode	70
8.6.5	Map options in Navigation mode.....	70
8.6.6	Quitting navigation	71
8.7	Map in Destination search mode.....	71
8.7.1	Operating in Destination search mode.....	72
9	Useful functions.....	73
9.1	Route profiles	73
9.1.1	Route profile settings	73
9.1.2	NAVIGON basic profiles	74
9.1.3	Creating a new route profile.....	74
9.1.4	Selecting a route profile	75
9.1.5	Managing route profiles	75
9.2	MyPOIs	76
9.2.1	Creating your own destinations.....	77
9.2.2	Symbols for your own POIs	78
9.2.3	POI-Import: Importing your own POIs onto the navigation device.....	78
9.3	Screenshots	78
9.3.1	Enabling screenshots.....	78
9.3.2	Creating a screenshot.....	78
9.4	Tracks	79
9.5	Parking near the destination	80
9.6	Nearby.....	81
9.7	POI on Your Route.....	82
9.7.1	Displaying POIs along the route	82
9.7.2	Navigating to one of the destinations	84
9.7.3	Selecting categories.....	84
9.8	NAVIGON Sightseeing.....	84
9.9	Sightseeing Tours	86
9.10	Direct Help	88
9.11	GPS Status, saving the current location	88
9.12	Block	89
9.13	Turn-by-Turn List.....	89
9.14	TMC (Traffic Information).....	91
9.14.1	Preview TMC.....	91
9.14.2	Displaying traffic information	93
9.14.3	Showing a single message in detail.....	94
9.14.4	TMC Settings	94

9.15	Logbook	95
10	Handsfree Module.....	96
10.1	Connection with Mobile Phone.....	98
10.1.1	Searching for and pairing Bluetooth devices	98
10.1.2	Pairing from the mobile phone	100
10.1.3	Connecting to a device	100
10.1.4	Activating a mobile phone	102
10.1.5	Deleting a device	102
10.1.6	Import Phone Book	103
10.1.7	Import recent calls.....	104
10.2	Taking a call	104
10.3	Receiving a text message.....	105
10.4	Making a call	105
10.4.1	Making a call with the voice commands function	105
10.4.2	Dialling a telephone number	106
10.4.3	Dialling a Speed Call number	107
10.4.4	Calling a contact from the phone book	107
10.4.5	Calling most recently dialled, received or missed numbers	107
10.4.6	Transferring a call from your mobile telephone.....	108
10.5	During a call	108
10.5.1	Moving the navigation application to the foreground	108
10.5.2	Entering numbers.....	109
10.5.3	Muting the microphone	109
10.5.4	Transferring a call to the mobile phone.....	109
10.5.5	Ending the call	109
10.6	Useful functions.....	109
10.6.1	Navigating to a contact from the phone book	109
10.6.2	Opening the mailbox	110
10.7	Configuring the hands-free function	110
10.7.1	Preset.....	110
10.7.2	Settings	111
11	Navigon Live.....	112
11.1.1	Costs	113
11.2	Using the NAVIGON Live services.....	114
11.2.1	Weather Service	114
11.2.2	Parking	115
11.2.3	Fuel	116
11.2.4	Google Local Search	117
11.2.5	Events	118
11.2.6	Traffic Information	121
11.3	Configuring the NAVIGON Live services	121

11.4	Indicating the status	122
12	Configuring the navigation system	122
13	Appendix	124
13.1	Technical data of the navigation device	124
13.2	NAVIGON Licensing Policy	125
13.3	Declaration of Conformity	129
14	Troubleshooting	129
15	Index	133

1 Introduction

1.1 About this manual

1.1.1 Conventions

For better legibility and clarification, the following styles are used in this manual:

<i>Bold and italics:</i>	Names of products
SMALL CAPITALS:	Names of windows and dialogue boxes
Bold:	Highlighting of important parts in the text
<u>Underlined:</u>	Descriptions of buttons, input boxes and other elements on the user interface
<u><i>Underlined and italics:</i></u>	Names of control elements on the navigation device

1.1.2 Symbols

The following symbols refer to specific passages of text:



Instructions and tips for operating the software



More detailed information and explanations



Warnings

1.2 Legal notice

1.2.1 Liability

The software and manual are subject to change without notice. NAVIGON AG is not liable for the accuracy of the information contained in this manual or for damages resulting from the use of this manual.

Suggestions for improvements and information regarding errors are always welcome so that we can supply you with even better products in the future.

1.2.2 Trade marks

All brand and trade marks mentioned in this document and registered by third parties are subject without reservation to copyright law and the proprietary rights of their respective owners. All trade marks, trade names and company names used in this document are or may be trade marks or registered trademarks of their respective owners. All rights reserved except those explicitly granted.

If the registered trade marks used in this manual are not explicitly identified as such, this does not imply that the name is not subject to the rights of a third party.

- ▶ Microsoft, Outlook, Excel and Windows are registered trade marks of the Microsoft Corporation.
- ▶ NAVIGON is a registered trade mark of NAVIGON AG.

1.3 Questions about the product

You have a question concerning your product? Then visit our website www.navigon.com and click on "Customer Services". There you will find an area with frequently asked questions (FAQ Center) along with details of how to contact us by phone or e-mail.

2 Before you begin

2.1 Scope of Delivery

Please check that the contents are complete. If anything is missing, get in touch immediately with the dealer who sold you the product.

The purchased product includes the following:



- ▶ Navigation device
- ▶ Designer car cradle
- ▶ Car charger cable (10-24V adapter for the vehicle's cigarette lighter) with integrated TMC antenna
- ▶ USB cable
- ▶ Illustrated installation instructions
- ▶ Only **NAVIGON 70 Premium Live**:
 - ▶ SIM card holder. The card holder is glued in the leaflet and can be removed easily. The SIM card has been broken out of its holder already.
 - ▶ SIM card (is already inserted in the navigation device)

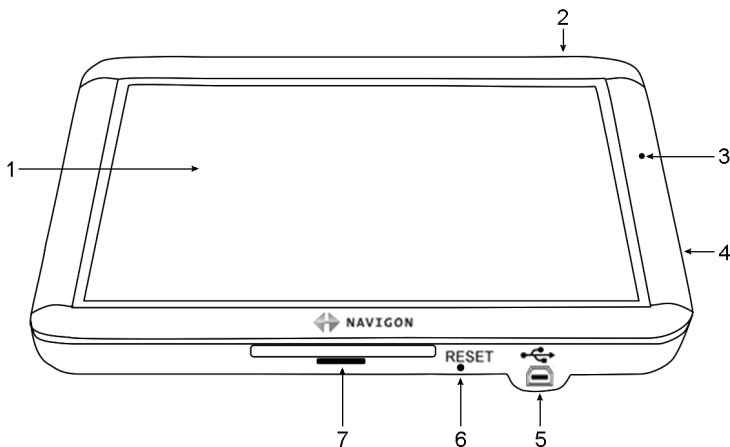

Note: Keep the SIM card holder in a safe place! You will need the data printed on this holder if you ever have to contact the **NAVIGON** Service Centre for assistance.

2.2 Description of the navigation device



- | | | |
|---|---|---|
| 1 | | Touch-screen |
| 2 |  | <u>On/Off</u> |
| 3 | | Microphone |
| 4 |  | Slot for microSD memory card |
| 5 |  | Mini USB socket for USB cable / mains adapter |
| 6 | RESET | Reset |
| 7 | | LED |

2.3 Important safety information

In your own interest, please read the following safety information and warnings carefully before starting up your navigation system.

2.3.1 Navigation safety information

Use the navigation system at your own risk.



Caution! To prevent accidents, do not operate the navigation system while driving.



Caution! Do not look at the screen unless it is absolutely safe to do so!



Caution! Traffic regulations have priority over any instructions from the navigation system.



Caution! Follow the instructions of the navigation system only when the circumstances and the road traffic regulations allow you to do so! The navigation system will still guide you to your destination even if you deviate from the calculated route.



Caution! Check that the cradle is secured and adjusted properly before each journey.

2.3.2 Safety information for the navigation device



Caution! Protect the device from moisture. The device is neither waterproof nor protected against splash water.



Caution! Do not open the case of the navigation device under any circumstances.



Caution! Do not expose the navigation device to extreme heat or cold. This may damage the device or impair its function. (Refer to "Technical data" on page 124.)



Caution! Never unplug by pulling the cable. Doing so could severely damage or destroy the device.



Caution! Do not subject the navigation device to severe temperature fluctuations. This can cause condensation to form.



Note: Do not kink the cable. Make sure that the cable cannot be damaged by sharp-edged objects.



Note: Create a backup of the data which exist in the internal memory of your navigation device.

This is very easy to do with the **NAVIGON Fresh** software which can be downloaded free of charge from our website www.navigon.com/fresh.

2.3.3 Safety guidelines when installing the device in your car



Caution! Fasten the cradle so that the navigation device is easy to see and operate by the driver. Make sure that the driver's view of the traffic is not impeded.



Caution! Do not attach the cradle within the working zone of any airbags.



Caution! Do not fasten the cradle too close to the steering wheel or other controls. The driver must not be obstructed in operating any car functions.



Caution! When installing the cradle, make sure that it will not pose a risk in the event of an accident.



Caution! Do not run cables directly next to safety-relevant devices and power supplies.



Caution! Check that the cradle is secured and adjusted properly before each journey. The suction cup may become loose after a while.



Caution! After installation, check all safety-relevant equipment in the car.



Caution! Connect the car charger cable only to cigarette lighters with an operating voltage of 10-24V.



Caution! Disconnect the car charger cable from the cigarette lighter whenever you park the car. The integrated mains adapter always consumes a small amount of energy and could drain the car battery.

2.4 Preparing the navigation system for use

2.4.1 SIM card



This chapter is relevant for you only if your navigation device is a **NAVIGON 70 Premium Live**.

The SIM card is inserted at the back under the cover in the middle of the device.

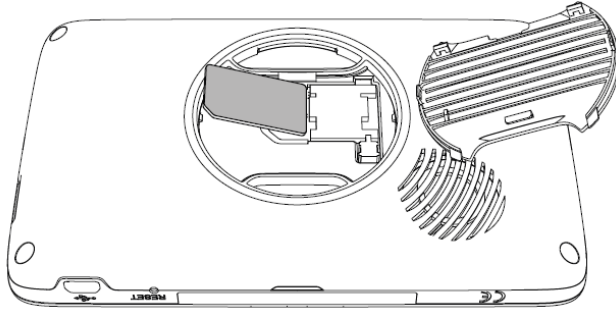

1. Switch off the navigation device.
2. Insert a finger-nail in the recess on the top of the cover.
3. Pull the cover off the device.
4. Break the SIM card out of the SIM card holder. The card holder is glued in the leaflet and can be removed easily.
5. Insert the SIM card as shown in the illustration.
6. First insert the two lower lugs of the cover.
7. Then press on the upper part of the cover so that both upper lugs engage.
8. Push the cover firmly against the device until it latches home in all corners.

The procedure for removing the SIM card is similar to that just described.



Note: If the cover does not latch home correctly, it may be impossible to establish a connection to the NAVIGON server. In this case the **NAVIGON Live** services will not be available.

2.4.2 Installing the navigation system in the vehicle



Caution! Be sure to refer to all the safety information in chapter "Important safety information" on page 10.

Securing the cradle

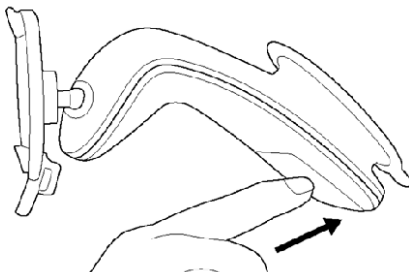

1. Clean the suction cup and that part of the windscreen to which you want to secure the cradle. Both must be dry and free of dirt and grease.
2. Open the lever on the suction cup as far as possible.
3. Place the cradle suction cup against the windscreen.
4. Press the lever towards the windscreen.

Inserting the navigation device into the cradle

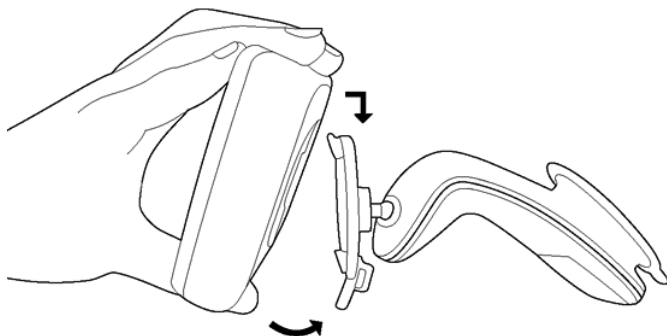

On the back of the navigation device you will see a circle with two recesses.

1. Hang the navigation device by the upper recess on the upper lug of the cradle. (See illustration)
2. Then press it towards the cradle so that it latches in place.

Supplying power to the navigation device

Included in delivery of the navigation device is a car charger cable with which power can be supplied to the navigation device via the vehicle's cigarette lighter.



Note: Use only the charger cable supplied with your navigation device or an equivalent model from NAVIGON! If you use a different charger cable, the **NAVIGON Live** services might not be available.

- ▶ Connect the car charger cable to the vehicle's cigarette lighter and to the mini USB socket of the navigation device.

The LED on the bottom of the navigation device lights up orange during charging.

As soon as the battery is fully charged, the LED lights up green.



Caution! Connect the car charger cable only to cigarette lighters with an operating voltage of 10-24V.



Note: Insert the USB connector securely in the corresponding USB sockets!



Caution! Be sure to refer to all the safety information in chapter "Important safety information" on page 10.



Note: It takes approx. 3 hours to charge the device when the battery is flat.

A fully charged battery enables up to 3 hours of use depending on the device configuration.

TMC antenna

The navigation device has an integrated TMC receiver. The TMC antenna is integrated in the car charger cable. Once the car charger cable is connected, the device can receive current traffic messages. If required, it can change your route dynamically, e.g. in order to avoid a traffic jam.

2.4.3 Memory card

A memory card is not required to operate the navigation system because all the data required for navigation are stored in the internal memory of the device.

When you connect the navigation system to your computer using a USB cable, the internal memory is detected as the 'NAVIGON' drive. The slot for the memory card is detected as the 'NAVIGON SD' drive.

Data backups, software updates and navigation map updates can be carried out quickly and conveniently with the **NAVIGON Fresh** software, which you can download free of charge from the website www.navigon.com/fresh.

If you purchase additional navigation maps but no longer have enough space for them in the internal memory of your navigation device, it is also possible for you to save these maps on a memory card which you then insert in the device. The navigation system can use navigation maps from both memories.

2.5 Activating the NAVIGON Live services



This chapter is relevant for you only if your navigation device is a **NAVIGON 70 Premium Live**.

The **NAVIGON Live** services must be activated before they are used for the first time. (Refer to "Costs" on page 113.)

You have inserted the SIM card.

The leaflet with the activation code which came with the **NAVIGON Live** module is to hand.

1. Switch on the navigation device.

The **NAVIGATION** window opens.

2. Tap on  (**NAVIGON Live**).

You will be asked whether you want to activate the **NAVIGON Live** services.

3. Tap on Yes.
4. Enter the activation code.
5. Tap on Activate.

The **NAVIGON Live** services are now activated.

6. Tap on OK.

The following message appears: "You are sending 'Floating Car Data' to NAVIGON in anonymised form. The evaluation of these data will help in calculating times of arrival more precisely, in recognising traffic congestion sooner, and in planning alternative routes more reliably. No information about your person can be derived from the data. If you do not agree, select 'No' for the setting 'Optimise Traffic Recognition'."

7. Tap on OK.

The **NAVIGATION** window is opened. From here you have access to all the functions of your navigation device and all available **NAVIGON Live** services.



Note: Even after activation, location-related **NAVIGON Live** services (e.g. **Fuel** or **Events Nearby**) will be available only when the navigation device has GPS reception and can determine its position.

2.6 Navigating with GPS

GPS is based on a total of at least 24 satellites orbiting the Earth and continuously transmitting signals of their position and time. The GPS receiver receives this data and calculates its own geographical position on the basis of the information transmitted by the various satellites.

Data from at least three satellites is required for positioning with an acceptable degree of accuracy. With data from four or more satellites it is possible in addition to determine the position's altitude above sea level. Positioning is accurate to within three metres.

Once the navigation device has determined your position, this position can be used as a starting point for calculating a route.

The map data on your navigation device includes the geographical coordinates of all digitally recorded points of interest, streets and places. This enables the device to calculate a route between a starting point and a destination.

Calculation of the current position and its representation on the map take place approximately once every second. In other words, your current position is always shown on the map.

3 Switching on the navigation device

- ▶ Press the  (*On/Off*) key and keep it pressed until the device switches on.

The **NAVIGATION** window opens.



Note: The screen lights up briefly in white, indicating that you have started the device.

When you switch on the navigation system for the first time, you will be asked to make the following settings:

- ▶ your preferred language for using the software
- ▶ the unit of length for distances
- ▶ the time format
- ▶ the date format



Note: When you start the navigation application for the first time, the **DEMO MODE** settings window opens.

Demo mode is intended only for demonstrating the product when no GPS reception is possible.

When demo mode is active, navigation is not possible! Demo mode is designed solely to simulate navigation to the centre of the indicated destination.

- ▶ Make sure that the Start in Demo Mode setting is at No. If necessary tap on the  (Toggle) button in order to change the setting from Yes to No.
- ▶ Tap on OK.



Note: How to deactivate demo mode is explained in "Troubleshooting" in section "I have accidentally activated demo mode" on page 130.

Note: If you have not used the navigation device for a long time, the battery may be flat.



When you connect the navigation device to the supplied car charger cable, it can be switched on immediately even if the battery is flat. If you use a different charger cable or have connected your device to a PC, it may need charging for a few minutes before it can be switched on.

Chargers and other accessories are available in the NAVIGON online shop at www.navigon.com or in specialist stores.

Switching the navigation device to standby mode



- ▶ Press briefly on the  (On/Off) key (max. 1 second).
A message will appear telling you that the device will be switched to standby mode in several seconds.
- ▶ Wait for the device to be switched to standby mode or tap on Standby.

Automatic Standby

You can configure the navigation device so that it is automatically switched to standby mode when not in use.

- ▶ In the **NAVIGATION** window tap on Options > Settings > General > Automatic Standby.
- ▶ Select after how much time you want the navigation device to be switched to standby mode (Never, After 10 mins., After 20 mins., After 30 mins.).
- ▶ Select Power Loss in order to switch the device to standby mode when the external power supply is interrupted. As soon as the device is connected again to the external power supply it will switch on again automatically.

Switching off the navigation device

- ▶ Press the  (On/Off) key and keep it pressed until the device switches off (approx. 10 seconds)
- or-
- 1. Press briefly on the  (On/Off) key (max. 1 second).
A message will appear telling you that the device will be switched to standby mode in several seconds.
- 2. Tap on Off.



Note: When you switch the navigation device to standby mode, the next time it is switched on it will start very quickly and with the window which was active when switched off. In standby mode the device still consumes a small amount of energy however. Depending on how full the battery is, it can become flat within a few days or a few weeks.

When you switch off the device, it consumes no energy. It can then take several months for the battery to become flat. Switching the device on again triggers a restart which can take some time (approx. 30 seconds). Your settings and your saved destinations and routes will be retained.

3.1 Manual

An excerpt of this manual describing the most important functions of the navigation software is saved on the navigation device.

To open the manual:

1. In the **NAVIGATION** window, tap on Options > Manual.
The **TABLE OF CONTENTS** window opens.
2. Tap on the name of the chapter you want to read.
The content of the chapter is shown.

With the  (Up) and  (Down) buttons you can scroll up one page and down one page respectively.

With the  (To the Left) and  (To the Right) buttons you can open the previous or the next chapter respectively.

- ▶ Tap on the Table of Contents button in order to open the Table of Contents window.
- ▶ Tap on the  (Close) button in order to close the manual.
The **NAVIGATION** window is opened.

3.2 Options

Some windows offer options that lead to more functions.



A description of all available options can be found in the chapter "Options" on page 54.

4 Operating the navigation system

4.1 Information

Various information symbols are located at the top of many windows.

GPS

The **GPS** symbol can indicate the following GPS reception states:

No GPS (No symbol): The built-in GPS receiver is not operational. Contact us if the problem persists. (Refer to "Questions about the product" on page 9.)



No Signal: Data is being received from less than three satellites. Position cannot be calculated.



GPS Ready: Data is being received from at least 3 satellites. Position can be calculated.



For details of the GPS status refer to chapter "GPS Status, saving the current location" on page 88.

Compass

The **Compass** symbol indicates in which direction you are currently heading. It can indicate the following points of the compass: N, NE, E, SE, S, SW, W, NW.

Track

The  (**Record Track**) symbol indicates that a track is being recorded at this moment.



For more information about tracks refer to chapter "Tracks" on page 79.

Energy

The **Energy** symbol can indicate the following states of the integrated battery:



The device is being supplied by an external power source. The battery is fully charged.

-or-

The battery cannot be charged because its temperature is too high or too low.



The device is being supplied by an external power source. The battery is being charged.



The device is being supplied by its internal battery. The battery charge is sufficient.



The device is being supplied by its internal battery. The battery charge is low.

NAVIGON Live Services



This section is relevant for you only if your navigation device is a **NAVIGON 70 Premium Live**.

The NAVIGON Live Services symbol indicates the availability of the **NAVIGON Live** services. The following states can be symbolised:

The NAVIGON Live Services symbol indicates the availability of the **NAVIGON Live** services. The following states can be symbolised:

(No symbol) **No NAVIGON Live Services:** The **NAVIGON Live** services are deactivated. (Refer to "Configuring the NAVIGON Live services" on page 121)



(Red) **Connecting:** There is no connection yet to the **NAVIGON Live** server. This can be due to the following:

- ▶ The mobile radio connection is interrupted.
- ▶ The **NAVIGON Live** server is not answering.



(Light grey) **NAVIGON Live Services Ready:** There is a connection to the **NAVIGON Live** server. The **NAVIGON Live** services are available.

Traffic Information

TMC

The navigation system has an integrated TMC receiver which supplies up-to-date traffic information. Using this information the navigation system can change your route dynamically, for example in order to avoid a traffic jam.



Note: This function is only available if TMC traffic messages are being transmitted in the country in which you are travelling. This is not the case in all countries.

The **TMC** symbol can display the following TMC reception status:



Tuning (in red): The TMC receiver is operational but cannot find a transmitter that is sending TCM signals. There are no active traffic messages.



Tuning: The TMC receiver is operational but cannot find a station that is transmitting TMC signals. Traffic messages are active however. This can be the case, for example, when travelling through a tunnel.



TMC on Standby (in grey): Traffic messages can be received.



Note: The TMC antenna is integrated in the car charger cable. The **Tuning** symbol may still appear therefore when the car charger cable is not connected to the navigation device.



For details of the TMC function refer to chapter "TMC (Traffic Information)" on page 91.

Traffic Live



This section is relevant for you only if your navigation device is a **NAVIGON 70 Premium Live**.

You can draw traffic information either from the **NAVIGON Live** services (Traffic Live) or from radio stations (TMC). (Refer to "Configuring the NAVIGON Live services" on page 121.)

The Traffic Live symbol appears when you are drawing traffic information from the **NAVIGON Live** service.

The Traffic Live symbol can indicate the following traffic information reception states:



(Red) **Connecting:** The last attempt to call up traffic information from the **NAVIGON Live** server failed. This can be the case, for example, when travelling through a tunnel. Information which was called up previously may still be active however.



(Light grey) **Traffic Live Ready**: Traffic information was called up successfully. The active information is up to date.

Bluetooth / Phone



This section is relevant for you only if your navigation device is one of the following devices:

- ▶ **NAVIGON 70 Premium**
- ▶ **NAVIGON 70 Premium Live**

The navigation device has an integrated Bluetooth hands-free module. This enables you to use the device as a hands-free kit for up to two mobile phones with Bluetooth capability.

The Phone symbol can display the following states of the hands-free module:

No Bluetooth (No symbol): The Bluetooth function is deactivated.



Not connected (red mobile phone): The navigation device has no Bluetooth connection to another device.



Connected (white mobile phone): The navigation device is connected to a mobile phone and can be used as a hands-free car kit. The number indicates which of the two phones is currently active.



Call in Progress (green mobile phone): The hands-free module of the navigation device is being used for a phone call. The number indicates which of the two phones is being used to make the call.



Headset: A headset is connected. All the instructions given by the navigation system are heard over the headset. The telephone functions of the hands-free module are not available.

Muting

The Muting symbol can indicate the following states:

No symbol: The navigation application is not muted.



Muting: The navigation application is muted. If the device is navigating at the moment, you will not hear any driving instructions.



Note: This icon indicates only the muted state of the navigation instructions. It says nothing about the volume of the hands-free module.

Logbook

The **Logbook** symbol can indicate the following states:

No symbol: The logbook is deactivated. There is no recording of trips.



Logbook: The logbook is activated. Before each navigation you will be prompted to enter the necessary details for the logbook entry (reason for the trip, km total, ...). It is possible however to suppress the recording of the trip.

4.2 Software keyboard

A software keyboard appears on the screen when text entries are necessary.

All entries can be made on the software keyboard using your fingertips. Only capital letters can be entered.

When entering town or street names you need not enter any special characters or umlauts. The navigation system fills in these characters for you automatically. For example, if you are looking for the town of "Bärnau", then simply type in the word "BARNAU". Special characters may be helpful however when naming saved destinations and routes.

4.2.1 Special keys



inserts a space.



deletes the character in front of the cursor.



opens the keyboard with numerals.

Latin, Cyrillic and Greek alphabet



opens the keyboard with the Latin alphabet.



Note: The layout for the keyboard with the Latin alphabet can be configured.

- ▶ In the **NAVIGATION** window tap on [Options](#) > [Settings](#) > [General](#) > [Keypad layout \(Latin Alphabet\)](#).
- ▶ Select the layout you want to use ([QWERTZ](#), [QWERTY](#), [ABCDEF](#), [AZERTY](#)).



opens the keyboard with the Cyrillic alphabet.



opens the keyboard with the Greek alphabet.

When you want to enter addresses, names or POIs, the keyboard with the alphabet for the country in question will open automatically.

When you want to save a destination to Favourites or when you enter a POI category or a country, the keyboard with the alphabet of the user interface will open automatically.

You can also switch from the Cyrillic or Greek keyboard to the Latin keyboard. Many addresses can then also be entered as transliterations or in the language of the user interface.

Example: The language of the user interface is English. You want to navigate to Moscow. You have the following options:

- ▶ "Москва" (Cyrillic)
- ▶ "Moskva" (transliterated)
- ▶ "Moscow" (English).



Note: Street names and place names can be entered only in the language of the user interface if that is how they exist in the map's database.



Note: The maximum number of keyboards is always 2.

Umlauts, accents and other letters

Another keyboard with special characters is available for each alphabet.



opens the keyboard with Latin special characters.



opens the keyboard with Cyrillic special characters.



opens the keyboard with Greek special characters.

As soon as you have entered a special character the letter keyboard reappears.

4.2.2 Entering data

Often you can select an entry from a list. This is the case, for example, when you enter a location.



As soon as you enter the first letter, the largest city in the given country that begins with this letter appears.

Enter more letters and after each entry the first city which begins with these letters will appear.

- ▶ When the correct location appears, tap on  (OK) in order to complete the entry.

You can open at any time a list containing all the locations which begin with the letters or include the text already entered. The more letters you enter, the shorter the list becomes.

- ▶ Tap on  (Open List) in order to call up this list.

You can use the  (Up) button and the  (Down) button to move through the list.

- ▶ Tap on an entry in the list to select it and transfer it to the input box. The list closes once an entry has been selected. You are now finished with entering the city.
- ▶ Tap on  (Close List) in order to close the list without selecting an entry.



Note: The list opens automatically as soon as it contains only 4 or less entries.

4.3 Options

Some windows offer options that lead to more functions.



A description of all available options can be found in the chapter "Options" on page 54.

4.4 Menus

Some buttons have menus which open when activated.

- ▶ Tap on a menu point to execute its function.

If you would like to quit the options list without selecting a function, tap on the button you used to open the menu.

5 Voice Command



This section is relevant for you only if your navigation device is one of the following devices:

NAVIGON 70 Premium

NAVIGON 70 Premium Live



Note: The **Voice Command** function is not available in every language.

For languages in which this function is available, the Voice Command button is shown in the **NAVIGATION** window. For languages which are not supported, the Voice Command button is replaced by the Show Map button.

Many functions of your navigation device can be called up conveniently by voice command.

5.1 Activating the voice commands function

The voice commands function is automatically active in many windows. This applies in particular to windows in which you are expected to provide an answer, for example when there is a new traffic message concerning your route.

Proximity sensor active:

If the proximity sensor is active, you can also activate the voice command function in the **NAVIGATION** window, in the map and in the **HANDSFREE MODULE** window as follows:

- ▶ **NAVIGON 70 Premium:** Tap on the frame of the navigation device.
- ▶ **NAVIGON 70 Premium Live:** Move your hand close to the screen. As soon as you take your hand away again you will hear a single prompt tone and you can utter your command.

Proximity sensor inactive:

On the map in **Standard** or **Navigation** mode, the Voice Command function will be activated as soon as the button bar is shown:

- ▶ Tap on any point on the map. You will hear a single acknowledgement tone and you can utter your command.



For more information on the proximity sensor refer to "Motion Sensor", page 59.

5.2 Use Voice Command

When the functions in a window can be called up by voice command, this is indicated in the top left corner of the window by the symbol



(Voice command active).

A single signal tone and the symbol  (**Speak**) indicate that the navigation system is waiting for your voice command.

- ▶ Say a command.

The positive acknowledgement tone sounds (two high-pitch tones) and the function is executed.

If the navigation system has not understood your instruction or if you do not say anything within a certain time, the negative acknowledgement tone (two short low-pitch tones) will sound.

- ▶ Say the command again.

If the navigation system has not understood you after several repetitions, the prompt "Say Help" will appear.



Note: Navigation instructions and warnings are muted for as long as the navigation device expects to receive voice commands from you.

5.3 Help

Say only "Help" if you want to know which voice commands are currently possible. In nearly all windows in which voice commands are supported the navigation system will then tell you which commands you can say in the current window.

5.4 Deactivation of the voice commands function

The voice commands function will be deactivated under the following conditions:

- ▶ If you operate the navigation device with your finger while a voice command is expected from you.
- ▶ If a call is received and during an active phone call if the navigation device is being used as a hands-free module.

5.5 Configuring the voice commands function

You can configure for which tasks you want to use voice commands.

- ▶ In the **NAVIGATION** window tap on Options > Settings > General > Use Voice Command.

Select the tasks for which you want to use Voice Command:

- ▶ Complete: You can use all the voice command functions.
- ▶ Answering: You can enter addresses and answer questions asked by the navigation device.
- ▶ Entering Addresses: You can enter only addresses with the voice command function.



Note: For details of how to enter a destination using voice commands refer to the chapter "Entering a destination by voice commands" on page 32.



Note: For details of how to make a call using voice commands refer to the chapter "Making a call with the voice commands function" on page 105.

The volume of the voice controls assistant can be controlled independently of the volume of the navigation instructions. This means you can still hear the speak prompts when you have muted the navigation instructions.

1. In the **NAVIGATION** window tap on Options > Settings > General > Volume of the Assistant.
2. Select the volume for the assistant.



Note: For details of how to configure the navigation system refer to the chapter "Configuring the navigation system" on page 122.

6 Navigation

Use the navigation system at your own risk.



Caution! Be sure to refer to all the safety information in chapter "Important safety information" on page 10.

Impaired GPS reception

If GPS reception is impaired (e.g. because you are in a tunnel), navigation will be continued. The navigation system will then calculate your likely position from the route data and your previous driving profile. As soon as GPS signals are received again, navigation will be continued with real GPS data.

Arriving at your destination

When you have reached your selected destination, a message to this effect will be displayed.

Only your current position (orange arrow) and the destination flag will now be shown on the map.

6.1 Starting the navigation application

You have switched on the navigation device.

The following message appears:

"Please note that the road traffic regulations are prior to the instructions of the navigation system. Please do not operate the device while driving."

- ▶ After you have read and fully understood the message, tap on OK.

If you do not accept the content of the message, tap on **Cancel** in order to exit the navigation application.

The **NAVIGATION** window is opened. From here you can access all the functions of the navigation application.

Initialising the GPS receiver



Note: Good reception of GPS data requires an unobstructed path from the GPS receiver to the satellites. Tunnels, narrow thoroughfares between buildings and reflecting house fronts can restrict GPS reception greatly or make it impossible. If the GPS receiver or the navigation device is inside a vehicle, a metallised windscreen or a windscreen heater can be the cause of poor GPS reception.

As soon as the navigation device has been switched on, initialisation of the GPS receiver will begin.

The integrated GPS receiver is not initialised for the first time until the navigation application is started for the first time. It can take up to 5 minutes to initialise the GPS receiver for the first time.

Each time you switch on the navigation device after this, GPS reception will start within a short time.

If the navigation device has not been switched on for more than a week, it can take up to 10 minutes to re-initialise the receiver.



Note: Directly after the **GPS** symbol indicates the **GPS Ready** state, the accuracy of the positioning may be reduced for a few minutes.

In the top right hand corner of the screen you will see the **GPS** symbol. As soon as data from at least three satellites is received, the symbol will

change to  (GPS Ready).



Note: Initialisation takes the least time if you do not start driving until the initialisation has finished.





For more details about the **GPS** symbol refer to chapter "GPS" on page 20.

Returning to the Navigation window

The **NAVIGATION** window opens when the navigation application is started.

If another window of the navigation application is open, tap on

 (**Back**). This will return you to the window you came from.

- ▶ Tap on  (Back) repeatedly until the **NAVIGATION** window is opened.

6.2 Specifying a destination

Under New Destination you can enter destinations to which you have not yet navigated or which you have not saved. Here you can

- ▶ enter the address of the destination (refer to "Entering a destination address " on page 33).
- ▶ enter the coordinates of the destination (refer to "Enter Coordinates" on page 34).
- ▶ select a point of interest (refer to "Points of interest" on page 36)
- ▶ select a destination with the Direct Access function (refer to "Direct access to POI" on page 39).



Note: The first time that you want to enter a new destination you will be asked to select the country in which your destination is situated.

Under My Destinations you can select from the following lists of destinations and addresses:

- ▶ **FAVOURITES:** All destinations that you have entered and then saved (refer to "Favourites" on page 40).

Three special destinations are also saved in the **FAVOURITES** list:

- ▶ My Address: The address which was saved as the home address (refer to "Defining the home address" on page 47).
- ▶ My Vehicle: The location of your vehicle is automatically saved when you use the **Parking Close to Destination** function (refer to "Parking near the destination" on page 80).
- ▶ My Starting Point: The starting point of the last navigation is automatically saved.
- ▶ **LAST DESTINATIONS:** Destinations to which you have navigated on a previous occasion (refer to "Last Destinations" on page 41).
- ▶ **IMPORTED ADDRESSES:** All destinations that you have imported from Microsoft Outlook or from other data sources (refer to "Imported Addresses: Outlook / Internet" on page 42 and "" on page).

6.2.1 Specifying the country in which the destination is situated

At top left in the **ADDRESS**, **POI IN A CITY** and **POI NATIONWIDE** windows you will find the Country button. It bears the flag of the country in which you can currently select destinations for the navigation application.

If your destination is in a different country, then proceed as follows:

1. Tap on the **Country** button.
2. Enter the name of the country in which your destination is situated.
The button shows the flag of the destination country.



Note: The selection list contains only those countries whose maps are available to the navigation device.

6.2.2 Entering a destination by voice commands

It is particularly convenient to select the destination by voice commands.

1. In the **NAVIGATION** window tap on **Voice Command**.
The **VOICE COMMAND** window opens.

Entering an address

2. Say "Address".
Indicated at the top is the country for which you can select addresses.
 - ▶ Tap on the country if your destination address is situated in a different country. Then follow the instructions given by the navigation system.
You will be asked for the address data in this order: City > Street > House number.
3. Follow the instructions given by the navigation system.
When you have finished entering the address, the map will open in **Preview** mode. The destination is indicated on the map.

Entering a POI nearby

2. Say "POI Nearby".
3. Say which category of POI you want (e.g. "Hotel").
A list of nearby hotels opens.
4. Say the number of the hotel to which you want to navigate.
Say "Up" or "Down" in order to scroll in the list.
When you have selected a destination, the map opens in **Preview** mode. The destination is indicated on the map.

Entering a Favourite or an address from the phone book

- Say "My Destinations".
- A list opens. It contains the destinations found in the **FAVOURITES** list, destinations imported from Outlook, and destinations from the phone book of a connected mobile phone.
- Say the number of the destination to which you want to navigate. Say "Up" or "Down" in order to scroll in the list.
When you have selected a destination, the map opens in **Preview** mode. The destination is indicated on the map.



For detailed information on how to start navigation, please refer to chapter "Route preview" on page 44. Please read on there.



Note: The **Voice Command** function is not available for every language. In the languages for which this function is not available, the Voice Command button is replaced by the Show Map button.

6.2.3 Entering a destination address

- In the **NAVIGATION** window, tap on New Destination > Enter an Address.

Note: The following description is based on City First as the order for entering the address.

If the navigation device contains the map of a country in which the street is usually listed first (e.g. Sweden, Norway, ...), you can also choose Street First as the order for entering the destination address.

You can define the order in the **NAVIGATION** window at Options > Settings > General > Input Mode for Address Data.

Please note however that the Street First order of entry is not possible for all countries. In this case you must enter the city first.



The **ADDRESS** window opens.

- Enter the name or the postal code of the destination town.
- Enter the name of the destination street.
- Enter the house number. If you do not know the house number, then leave this box empty.

If you don't know the house number but know the name of a nearby side street, then tap on the Cross Street box and enter the name of this street. The navigation system will calculate a route to the intersection of the streets you have entered.

The **DETAILED INFORMATION ABOUT THE DESTINATION** window opens.

Indicated on the [Activate MyRoutes](#) button is whether several route suggestions are to be calculated (**Yes**) or not (**No**).

- ▶ Tap on [Activate MyRoutes](#) in order to change the setting.



Note: The [Activate MyRoutes](#) button is available only when you have entered all the address information. You can also make this setting under [Options](#) > [Settings](#) > [Navigation](#) > [Activate MyRoutes](#).

4. Tap on [Start Navigation](#) in order to navigate to the stipulated address.

-or-

Tap on [Parking](#) in order to search for and navigate to a car park near your destination.

Sometimes the destination cannot be found exactly because, for example, the entered combination of place and street name exists several times.

In this case a window will open with a list of all the addresses matching your entry plus additional information.

- ▶ Tap on the address to which you want to navigate.

If the entered house number is not included on the map, the window will show an address with the house number closest to the one entered.

The map opens in **Preview** mode. The destination is indicated on the map.



For detailed information on how to start navigation, please refer to chapter "Route preview" on page 44. Please read on there.

Note: It is not necessary to enter all the address details. You can tap on



[\(Start Navigation\)](#) before you get that far.



If you specify the town only, the navigation system will calculate a route to the town centre.

If you specify only the town and street without specifying a house number or cross street, the navigation system will calculate the best route to this street.

6.2.4 Enter Coordinates

You can also enter the geographic coordinates of your destination. The coordinates can be entered as decimal degrees or in degrees, minutes and seconds.

1. In the **NAVIGATION** window, tap on [New Destination](#) > [Enter Coordinates](#).

The **ENTER COORDINATES** window opens.

Entering as a decimal number

2. Enter the degree of latitude.
Begin the entry with a minus sign if you want to enter a southern degree of latitude.
3. Enter the degree of longitude.
Begin the entry with a minus sign if you want to enter a western degree of longitude.

Entering with minutes / seconds

2. Enter the degree of latitude.
Use the corresponding buttons shown on the keyboard in order to enter the units:



(degrees),



(minutes),



(seconds).

The (N S) button alongside the entry box indicates whether it is a northern or southern degree of latitude.

- ▶ Tap on the button if you want to change the current setting.

3. Enter the degree of longitude.
Use the corresponding buttons shown on the keyboard in order to enter the units:



(degrees),



(minutes),



(seconds).

The (E W) button alongside the entry box indicates whether it is an eastern or western degree of longitude.

- ▶ Tap on the button if you want to change the current setting.

The **DETAILED INFORMATION ABOUT THE DESTINATION** window opens.

Indicated on the [Activate MyRoutes](#) button is whether several route suggestions are to be calculated (**Yes**) or not (**No**).

- ▶ Tap on [Activate MyRoutes](#) in order to change the setting.

4. Tap on [Start Navigation](#) in order to navigate to the stipulated address.

-or-

Tap on [Parking](#) in order to search for and navigate to a car park near your destination.



Note: If the destination with the coordinates you entered does not lie on the road system covered by the map, navigation will be performed as far as the nearest road point using the mode defined by the selected route profile. From this point on, the navigation system will automatically switch to **Offroad** mode. (Refer to "Navigation in Offroad mode" on page 70.)

6.2.5 Points of interest

Points of Interest, called POIs for short, are useful addresses that are catalogued according to particular criteria.

POIs include ports, airports, restaurants, hotels, petrol stations, public buildings, doctor's surgeries, hospitals, shopping centres, etc.

Points of interest can be displayed on the map by means of a symbol. In the **NAVIGATION** window tap on [Options](#) > [Settings](#) > [Map Display](#) > [Categories Shown](#) in order to select the categories you want to appear on the map.



Note: If you have created your own POIs, they will be available under the **MyPOIs** category. For more details about creating your own POIs refer to chapter "MyPOIs" on page 76.

POI nearby

POIs nearby are POIs located within a certain radius of your current location. This means you can always find the nearest petrol station for example, no matter where you are.

Note: GPS reception must be good enough for determining your

position. Check the  (GPS Ready) symbol to see whether GPS reception is good enough.



If GPS reception is not good enough, the system will look for POIs near the last known position. If there is no last known position, the **POI Nearby** function will not be available.

For more details refer to the chapter "Initialising the GPS receiver" on page 30.



Note: The Direct Access section offers 3 categories of POI from the current vicinity which can be searched for quickly and without additional entry.

For more details refer to the chapter "Direct access to POI" on page 39.

1. In the **NAVIGATION** window tap on [New Destination](#) > [Search for POI](#) > [Nearby](#).
The **POI NEARBY** window opens.
2. Select a category from which you would like to find a POI. Categories in which no destinations are available nearby cannot be selected.
If sub-categories exist for the category you have selected, the [Sub Category](#) list opens.
3. Select the sub-category from which you would like to select a POI.

The Destination list opens. It contains the nearest POIs in the specified category, sorted by distance.

- If the list is very long:

- ▶ Tap on  (Close List).

The keyboard appears.

- ▶ Enter a number of letters from the destination.

- ▶ Tap on  (Open List).

The list now contains only those destinations which begin with the letters entered.

- Tap on the name of the destination.

The **DETAILED INFORMATION ABOUT THE DESTINATION** window opens.

Indicated on the Activate MyRoutes button is whether several route suggestions are to be calculated (Yes) or not (No).

- ▶ Tap on Activate MyRoutes in order to change the setting.

- Tap on Start Navigation.

-or-

Tap on Parking in order to search for and navigate to a car park near your destination.

The map opens in **Preview** mode. The destination is indicated on the map.



For detailed information on how to start navigation, please refer to chapter "Route preview" on page 44. Please read on there.

POI of nationwide significance

POIs of nationwide significance are airports, sights, national monuments, large ports etc. This way you can find well-known places of interest even if you don't know the name of their location.

- In the **NAVIGATION** window tap on New Destination > Search for POI > Nationwide.

The **POI NATIONWIDE** window opens.

- Select a category from which you would like to find a POI.

The Destination list opens. It contains the POI from the selected category, sorted alphabetically.

- If the list is very long:

- ▶ Tap on  (Close List).

The keyboard appears.

- ▶ Enter a number of letters from the destination.

- ▶ Tap on  (Open List).

The list now contains only those destinations which begin with or contain the letters entered.

4. Tap on the name of the destination.

The **DETAILED INFORMATION ABOUT THE DESTINATION** window opens. Indicated on the Activate MyRoutes button is whether several route suggestions are to be calculated (Yes) or not (No).

- ▶ Tap on Activate MyRoutes in order to change the setting.

5. Tap on Start Navigation.

-or-

Tap on Parking in order to search for and navigate to a car park near your destination.

The map opens in **Preview** mode. The destination is indicated on the map.



For detailed information on how to start navigation, please refer to chapter "Route preview" on page 44. Please read on there.

POI in a particular location

POIs in a particular location can be useful when navigating in an unfamiliar town.

1. In the **NAVIGATION** window tap on New Destination > Search for POI > in a City.

The **POI IN A CITY** window opens.

2. Enter the name or the postal code of the destination town.
3. Select a category from which you would like to find a POI. Categories in which no destinations are available in the selected town cannot be entered.

If sub-categories exist for the category you have selected, the Sub Category list opens.

4. Select the sub-category from which you would like to select a POI.

The Destination list opens. It contains POI from the specified category, sorted alphabetically.

5. If the list is very long:

- ▶ Tap on  (Close List).

The keyboard appears.

- ▶ Enter a number of letters from the destination.

- ▶ Tap on  (Open List).

The list now contains only those destinations which begin with or contain the letters entered.

6. Tap on the name of the destination.

The **DETAILED INFORMATION ABOUT THE DESTINATION** window opens.

Indicated on the Activate MyRoutes button is whether several route suggestions are to be calculated (**Yes**) or not (**No**).

- ▶ Tap on Activate MyRoutes in order to change the setting.

Sometimes the destination cannot be found exactly because, for example, several restaurants with the same name exist in the town in question.

In this case a window opens with all the destinations matching your entry plus additional information.

- ▶ Tap on the destination to which you want to navigate.

7. Tap on Start Navigation.

-or-

Tap on Parking in order to search for and navigate to a car park near your destination.

The map opens in **Preview** mode. The destination is indicated on the map.



For detailed information on how to start navigation, please refer to chapter "Route preview" on page 44. Please read on there.

Direct access to POI

The direct access area contains 3 categories of POI. Destinations in your vicinity that correspond to one of these categories can be viewed here quickly and without further entry.

- ▶ In the **NAVIGATION** window tap on Options > Settings > General in order to select which categories or sub-categories are to be available for direct access.

Note: GPS reception must be good enough for determining your

position. Check the  (GPS Ready) symbol to see whether GPS reception is good enough.



If GPS reception is not good enough, the system will look for POIs near the last known position. If there is no last known position, the **Direct Access** function will not be available.

For more details refer to the chapter "Initialising the GPS receiver" on page 30.

1. In the **NAVIGATION** window tap on New Destination.
The **NEW DESTINATION** menu opens.
In the Direct Access area you are shown the symbols of those POI categories that are available by direct access.
2. Tap on the category from which you would like to select a POI.
A list opens. It contains the nearest POIs in the specified category, sorted by distance.
3. Tap on the name of the destination in order to start navigation to it.
The map opens in **Preview** mode. The destination is indicated on the map.



For detailed information on how to start navigation, please refer to chapter "Route preview" on page 44. Please read on there.

6.2.6 Information about the destination

For many destinations that you specify, there will be further information available, stored in the navigation system's database.

There is, for example, a telephone number available for many restaurants. You can then call the restaurant to reserve a table, for example.

One of the destination entry windows described above is open.

- ▶ Tap on Options > Info.

The **DESTINATION INFO** window opens. It contains all the information about the specified destination that is stored in the navigation system's database.

- ▶ Tap on Close in order to close the **DESTINATION INFO** window again.

- ▶ Tap on  (Show on Map) in order to see the destination on the map.

- ▶ Tap on  (Save Destination) in order to save the destination in the **FAVOURITES** list.

6.2.7 Favourites

Destinations to which you want to travel often can be saved in the **FAVOURITES** list.

In the **FAVOURITES** list you can save up to 500 destinations.



Information on how to save a destination can be found in chapter "Saving destinations" on page 46.

1. In the **NAVIGATION** window, tap on [My Destinations](#) > [Favourites](#).
2. Tap on the destination to which you want to navigate.
The **DETAILED INFORMATION ABOUT THE DESTINATION** window opens. Indicated on the [Activate MyRoutes](#) button is whether several route suggestions are to be calculated (**Yes**) or not (**No**).
▶ Tap on [Activate MyRoutes](#) in order to change the setting.
3. Tap on [Start Navigation](#).
-or-
Tap on [Parking](#) in order to search for and navigate to a car park near your destination.
The map opens in **Preview** mode. The destination is indicated on the map.



For detailed information on how to start navigation, please refer to chapter "Route preview" on page 44. Please read on there.



Note: Favourites are indicated on the map by a small flag with their name.

6.2.8 Last Destinations

The last 12 destinations to which you have navigated are saved by the navigation system in the **LAST DESTINATIONS** list.

1. In the **NAVIGATION** window, tap on [My Destinations](#) > [Last Destinations](#).
2. Tap on the destination to which you want to navigate.
The **DETAILED INFORMATION ABOUT THE DESTINATION** window opens. Indicated on the [Activate MyRoutes](#) button is whether several route suggestions are to be calculated (**Yes**) or not (**No**).
▶ Tap on [Activate MyRoutes](#) in order to change the setting.
3. Tap on [Start Navigation](#).
-or-
Tap on [Parking](#) in order to search for and navigate to a car park near your destination.
The map opens in **Preview** mode. The destination is indicated on the map.



For detailed information on how to start navigation, please refer to chapter "Route preview" on page 44. Please read on there.

6.2.9 Imported Addresses: Outlook / Internet

You can use the **NAVIGON Sync** software to export to your navigation system the contact addresses which you have saved in Microsoft Outlook on your computer.

From many route planners on the Internet it is also possible to copy the entered destination address directly onto your navigation system. This function is clearly indicated on those websites which offer it.



Note: You can download **NAVIGON Sync** free of charge from our website www.navigon.com.

Contacts which have been saved with several addresses will appear once with each address in the **IMPORTED ADDRESSES** list.

1. In the **NAVIGATION** window tap on My Destinations > Imported Addresses > Outlook / Internet.
2. Tap on the address to which you want to navigate.
The **DETAILED INFORMATION ABOUT THE DESTINATION** window opens. Indicated on the Activate MyRoutes button is whether several route suggestions are to be calculated (**Yes**) or not (**No**).
 - ▶ Tap on Activate MyRoutes in order to change the setting.
3. Tap on Start Navigation.

-or-

Tap on Parking in order to search for and navigate to a car park near your destination.

The map opens in **Preview** mode. The destination is indicated on the map.



For detailed information on how to start navigation, please refer to chapter "Route preview" on page 44. Please read on there.

6.2.10 Imported Addresses from the phone book



This section is relevant for you only if your navigation device is one of the following devices:

- ▶ **NAVIGON 70 Premium**
- ▶ **NAVIGON 70 Premium Live**

The phone book of a mobile phone with which you are connected can be imported into the navigation device. Addresses from the phone book are then found in the **IMPORTED ADDRESSES FROM THE PHONE BOOK** list.

1. In the **NAVIGATION** window tap on My Destinations > Imported Addresses > From the phone book.
2. Select the contact you want from the phone book.

3. Tap on the address to which you want to navigate.
The **DETAILED INFORMATION ABOUT THE DESTINATION** window opens. Indicated on the Activate MyRoutes button is whether several route suggestions are to be calculated (Yes) or not (No).
 - ▶ Tap on Activate MyRoutes in order to change the setting.
4. Tap on Start Navigation.
-or-
Tap on Parking in order to search for a car park near your destination.
The map opens in **Preview** mode. The destination is indicated on the map.



For detailed information on how to start navigation, please refer to chapter "Route preview" on page 44. Please read on there.

6.2.11 Navigating home

You can save an address as your home address. You can navigate to your home address at any time by pressing a single button.



More information about entering your home address can be found in the chapter "Defining the home address" on page 47.

- ▶ In the **NAVIGATION** window tap on Take Me Home.
If you have not yet entered your home address, a dialog box will notify you of this.

Navigation starts. The route profile used for the previous navigation will be applied.

6.2.12 Selecting destinations on the map

You may select a destination directly on the map. This is a quick way to select towns, streets and POIs.

1. In the **NAVIGATION** window tap on Show Map.
-or-
If the voice commands function is available on your navigation device and for your language:
 - ▶ In the **NAVIGATION** window tap on Options > Show Map.
2. Tap on  (Destination search).
The map opens in **Destination search** mode.
3. Tap on the point to which you want to navigate.



Note: For details of how to change the map view so that your destination is easily seen refer to the chapter "Map in Destination search mode" on page 71.

The destination that you have selected appears under the cross hairs.

The geographical coordinates of the destination and the corresponding address are shown in the bottom third of the screen.

4. Tap on  (OK).

The **DESTINATION ON MAP** window opens. The detailed address data of the selected destination is displayed in the upper left-hand corner.

5. Tap on Take Me There.

The map opens in **Preview** mode. The destination is indicated on the map.



For detailed information on how to start navigation, please refer to chapter "Route preview" on page 44. Please read on there.

6.2.13 Route preview

The map is open in **Preview** mode.

The navigation destination is depicted by a small flag.



For detailed information refer to the chapter "Map in Preview mode" on page 61.

Route Profile

The route is calculated on the basis of a route profile. The current route profile is indicated at the top right edge of the map.

Route profiles take account of the characteristics and special aspects of the different modes of transport. For example a route profile for bicycles will exclude motorways from the route calculation but will include roads which other vehicles are not allowed to use. And a bicycle profile will calculate different arrival times than a motorcycle profile.



Note: If you select a pedestrian profile, a type of navigation specially developed for pedestrians will be started. (Refer to "Navigation in Pedestrian mode" on page 68.)

- ▶ Tap on the Route Profile button if you want to select a different route profile.



For details of how to create and select route profiles refer to chapter "Route profiles" on page 73.

Turn-by-Turn List

- ▶ If you want to see detailed directions for the route, tap on Options > Turn-by-Turn List.



For details of the functions in the **TURN-BY-TURN LIST** window refer to chapter "Turn-by-Turn List" on page 89.

MyRoutes

When the **MyRoutes** function is activated, the navigation system calculates up to three routes on the basis of the currently selected route profile and shows them on the map in different colours (orange, green, blue) and with a number. For each route there is a button with the same number and a symbol in the same colour.

When calculating the time of arrival or the trip time, the navigation system takes account of additional factors such as day of the week, time of day and particularly your previous driving profile.

The route which corresponds best to the selected route profile is marked with "MyRoute".



Note: Even when the **MyRoutes** function is activated, sometimes only one additional route or no additional routes at all can be calculated for a particular route. No further suggestion is then shown on the button in question.

Start Navigation

- ▶ Tap on the button of the route which you want to use for the navigation.

If you select a route for which traffic obstructions have been announced, the **PREVIEW TMC** window may open before navigation starts. (Refer to "Preview TMC" on page 91.)

- ▶ Select whether you want to use the original route (Current Route) or a detour (Alternative route).

No GPS reception

If GPS signal reception is not good enough, the following message will appear: "Waiting for GPS-Signal..."

You have the following options:

- ▶ Wait. As soon as GPS reception is good enough for determining your position, the route will be recalculated and navigation will begin.
 - ▶ Tap on Cancel. The window in which you entered your destination will open again. Your destination is saved in the **LAST DESTINATIONS** list.
 - ▶ Tap on Demo. The route will be calculated using the centre of the destination location as starting point. Navigation will then be simulated on this route.
- Tap on  (Back) in order to terminate the demonstration.



Note: If you selected the destination on the map, then the Demo button is not available.

6.3 Managing destinations

Every destination you enter and destinations from the **LAST DESTINATIONS** and **IMPORTED ADDRESSES** lists can be saved in the **FAVOURITES** list. This makes sense if you frequently navigate to this particular destination.



Note: Favourites are indicated on the map by a small flag with their name.

6.3.1 Saving destinations

1. Enter a destination. (Refer to "Entering a destination address" on page 33 or "Points of interest" on page 36). Do not tap on the Start Navigation button!
2. Tap on Options > Save Destination.
-or-
 1. Select a destination from the **LAST DESTINATIONS** list or from the **IMPORTED ADDRESSES** list. (Refer to "Last Destinations" on page 41 or "Imported Addresses: Outlook / Internet" on page 42). Do not tap on the Start Navigation button!
 2. Tap on Options > Save as Favourite.
 3. Enter a name for the destination.
 4. Tap on Save.

6.3.2 Deleting a destination from the Favourites list

1. In the **NAVIGATION** window, tap on My Destinations > Favourites.
The **FAVOURITES** list opens.

2. Select the destination you want to delete.
The **DETAILED INFORMATION ABOUT THE DESTINATION** window opens.
3. Tap on Options > Delete Destination.

6.3.3 Defining the home address

You can always start navigation to your home address very quickly by tapping in the **NAVIGATION** window on Take Me Home.



You can define exactly one destination as your home address. You can enter the address manually or select a destination from the **FAVOURITES** list.

Your home address is saved in the **FAVOURITES** list where it is marked by a house symbol.



Note: The home address is also indicated on the map by a house symbol.

Entering the home address

1. In the **NAVIGATION** window tap on Take Me Home.
A window with the following message opens:
"Would you like to enter the address now?"
If you have already saved favourites, the message will be as follows:
"Do you want to enter the address, or do you want to select it from the Favourites?"
The currently valid value is highlighted (in white).
▶ If Enter an Address is NOT highlighted, tap on  (Toggle).
2. Tap on OK.
The **ADDRESS** window opens.
3. Enter your home address (refer also to "Entering a destination address " on page 33).
4. Tap on  (Home Address) to save the specified address as the home address.



Selecting the home address from your favourites

1. In the **NAVIGATION** window tap on Take Me Home.
A window with the following message opens:
"Do you want to enter the address, or do you want to select it from the Favourites?"

If you have not yet saved any favourites, the message will be as follows:

"Would you like to enter the address now?"

In this case you must enter the home address manually (refer to "Entering the home address" on page 47).

- ▶ If Favourites is NOT highlighted, tap on  (Toggle).
2. Tap on OK.
The **FAVOURITES** list opens.
3. Select the destination which you want to define as your new home address (refer also to "Favourites" on page 40).
The **DETAILED INFORMATION ABOUT THE DESTINATION** window opens.
4. Tap on  (Home Address) to save the specified address as the home address.

6.3.4 Changing the home address

You can define a different address as the home address at any time.

Proceed as follows:

1. Delete your home address from the **FAVOURITES** list (refer to "Deleting a destination from the Favourites list" on page 46).
2. Enter the new home address (refer to "Defining the home address" on page 47).

6.4 Tracks and multi-leg routes

It is possible to plan routes without GPS reception, for example in the comfort of your home. Planned routes can be saved for later use. This allows you to plan as many routes as you like, for example for your holidays.

1. In the **NAVIGATION** window tap on Options.
The options list opens.
2. Tap on the Routes and Tracks option.
The **ROUTES AND TRACKS** window opens.

6.4.1 Entering the starting point

The starting point of a route is the point at which you want to begin your trip. This is not necessarily the current location. If you are planning a route for your holidays at home, you could, for example, enter your hotel as the starting point.

The starting point is only important if you want to see a planned route on the map but currently have no GPS reception, or if you are not

currently at the planned starting point. This is why your selected starting point has the flow number "0".

As soon as you start navigation, your current location will be used as the starting point for the route calculation.

The first leg of the route is therefore the journey to the route point with flow number "1".

1. Tap on the Specify Starting Point box.
The **STARTING POINT** menu opens.

If you want to enter your current location as the starting point:

2. Tap on the Current Position menu item.

If you want to enter a different starting point:

2. Tap on the corresponding button.
3. Enter the starting point. (Refer to the corresponding section of the chapter "Specifying a destination" on page 31.)

4. Tap on  (Set Starting Point).
The selected starting point will now be shown next to the 0 (Starting Point) button.

Changing the starting point

- ▶ Tap on the starting point (button 0).

The **STARTING POINT** menu opens. You can now enter a different starting point. Proceed as described above.

6.4.2 Entering route points

The route points of a route are the destinations that you want to navigate to.

The flow number for each route point is indicated on a button in front of it.

1. Tap on the Add Route Point box.
The **ROUTE POINT** menu opens.
2. Tap on the button for how you want to enter the destination.
3. Enter the route point. (Refer to the corresponding section of the chapter "Specifying a destination" on page 31.)

4. Tap on  (Add).
The selected route point is now shown next to its flow number.

Repeat these steps for each destination that you want to add to your route.

6.4.3 Editing route points

Route points can be deleted from a route. The order of the route points can be changed as you wish.



Note: The starting point (flow number "0") can be neither moved nor deleted. However you can make another route point into the starting point provided the Current Position setting was not selected for the starting point.

- ▶ Tap on the route point that you want to edit.
The context menu contains the following buttons:



Route Point Up: Moves the selected route point further to the front.
(Example: route point 2 becomes route point 1)



Route Point Down: Moves the selected route point further to the back.
(Example: route point 2 becomes route point 3)



Delete: Deletes the selected route point. A dialog window prompts you to confirm deletion.

6.4.4 Managing routes

You can save each planned route under a particular name.



Note: Only the start point and route points will be saved, not the calculated route. When you load a saved route, it must be recalculated before navigation can start.

You can load, rename or delete stored routes.

Saving routes

The **ROUTES AND TRACKS** window is open. You have entered the starting point and at least one route point.



1. Tap on Options > Save Route.
2. Enter a name for the route.
3. Tap on  (Save).

The destination is now saved to the **SAVED ROUTES AND TRACKS** list.
The dialog window closes.

6.4.5 Loading routes or tracks

1. Tap on Options > Saved Routes and Tracks.

The **SAVED ROUTES AND TRACKS** list opens. It shows all the saved routes and tracks in alphabetical order.

A symbol in front of the name indicates whether it is a route () or a track ().

If you want to load a route:

2. Tap on the route that you want to load.

3. Tap on  (Load Route).

The **ROUTES AND TRACKS** window opens. The starting point and the route points of the loaded route have been entered. For the route calculation the starting point is replaced by the current position. You will now be guided to the first route point.

If you want to load a track:

2. Tap on the track that you want to load.
3. Tap on Load Track.

The **ROUTES AND TRACKS** window opens. The current location is entered as the starting point. The loaded track is entered as route point 1. Navigation then leads first to the starting point of the track.



For details about navigating along recorded tracks refer to chapter "Navigation in Track mode" on page 69.

6.4.6 Calculating and displaying routes

It is possible to calculate and display a planned route on the map even without GPS reception in order to get an impression of the journey.

The **ROUTES AND TRACKS** window is open. The starting point and at least one route point have been entered.

- ▶ Tap on Show Route.

The map opens in **Preview** mode.

The starting point and the route points are marked by flags. The distance and the estimated trip time is given for each leg of the route.

6.4.7 Simulating routes

It is also possible simply to simulate navigation on a planned route.



Note: GPS reception is not necessary for simulation.

If you have planned a multi-leg route, only the first leg will be simulated.

You have calculated and displayed a route.

1. Tap on Options > Simulation.

- ▶ If you have planned a route with only one route point and the **MyRoutes** function is activated, you will be prompted to select a route for the simulation.

The route will be recalculated for simulation purposes.

2. Tap on the button of the route on which you want to simulate the navigation.



For more details about the **MyRoutes** function refer to the chapter "MyRoutes" on page 45.

Stopping simulation

You can stop simulation at any time.

- ▶ Tap on  (Back).

The **ROUTES AND TRACKS** window opens.

6.4.8 Route preview

You have calculated and displayed a route. The map is open in **Preview** mode.

Route Profile

Route profiles take account of the characteristics and special aspects of the different modes of transport. For example a route profile for bicycles will exclude motorways from the route calculation but will include roads which other vehicles are not allowed to use. And a bicycle profile will calculate different arrival times than a motorcycle profile.



Note: If you select a pedestrian profile, a type of navigation specially developed for pedestrians will be started. (Refer to "Navigation in Pedestrian mode" on page 68.)

- ▶ Tap on the Route Profile button if you want to select a different route profile.



For details of how to create and select route profiles refer to chapter "Route profiles" on page 73.



Note: When you load routes which originate from a different provider than NAVIGON, it may be impossible for you to change the route profile of this route.

Turn-by-Turn List

If you want to see detailed directions for the route, tap on Options > Turn-by-Turn List.



For details of the functions in the **TURN-BY-TURN LIST** window refer to chapter "Turn-by-Turn List" on page 89.

MyRoutes

When the **MyRoutes** function is activated, the navigation system calculates up to three routes on the basis of the currently selected route profile and shows them on the map in different colours (orange, green, blue) and with a number. For each route there is a button with the same number and a symbol in the same colour.

When calculating the time of arrival or the trip time, the navigation system takes account of additional factors such as day of the week, time of day and particularly your previous driving profile.

The route which corresponds best to the selected route profile is marked with "MyRoute".



Note: The **MyRoutes** function can be used only for routes with only one route point. For routes with two or more route points only one route is calculated and displayed, regardless of whether you have activated the function or not.



Note: Even when the **MyRoutes** function is activated, sometimes only one additional route or no additional routes at all can be calculated for a particular route. No further suggestion is then shown on the button in question.

Start Navigation

- ▶ Tap on the button of the route which you want to use for the navigation.

If you select a route for which traffic obstructions have been announced, the **PREVIEW TMC** window may open before navigation starts. (Refer to "Preview TMC" on page 91.)

- ▶ Select whether you want to use the original route (Current Route) or a detour (Alternative route).

No GPS reception

If GPS signal reception is not good enough, the following message will appear: "Waiting for GPS-Signal..."

You have the following options:

- ▶ Wait. As soon as GPS reception is good enough for determining your position, the route will be recalculated and navigation will begin.
- ▶ Tap on Cancel. The map opens in **Preview** mode.

7 Options

Some windows offer options that lead to more functions.

- ▶ Open the Options menu (refer to "Button bar" on page 57).
- ▶ Tap on the option you would like to use.
- ▶ If you would like to quit the options list without selecting an option, tap on the Options button again.

2D/3D: Changes between 2D and 3D mode. The symbol indicates the current mode.

Add to Route: Opens the route planning. The address specified will be added as a route point. (Refer to "Tracks and multi-leg routes" on page 48.)

Block: Opens a window in which you can block a section of the route lying ahead in order to calculate a route which avoids this section, e.g. if you have heard on the radio of a traffic jam relating to this section. (Refer to "Block" on page 89.)

Day/Night: Changes between "Day" and "Night" screen modes. The symbol indicates the current mode.

Delete All: Deletes all destinations in the list (**LAST DESTINATIONS** list or **FAVOURITES** list, depending on where you opened the options). The list is then empty. A dialog window prompts you to confirm deletion.

Delete Destination: Deletes the selected destination from the list (**LAST DESTINATIONS** or **FAVOURITES**, depending on where you opened the options). A dialog box prompts you to confirm deletion.

Direct Help: Opens a window in which you can find in quick and uncomplicated manner the addresses and phone numbers of offices in your direct vicinity that can be useful in emergencies. (Refer to "Direct Help" on page 88.)

Factory Settings: Resets all settings to the as-delivered state. Routes and saved destinations are deleted. The software is re-started and behaves as if started for the first time after being purchased (refer to "Switching on the navigation device" on page 17).

GPS Status: Opens the **GPS STATUS** window. Here you can see details regarding GPS reception. You can also save the data of your current location. (Refer to "GPS Status, saving the current location" on page 88.)

Home Address: Saves the selected destination as your home address. You can then always start navigation to this destination very quickly by tapping in the **NAVIGATION** window on [Take Me Home](#).

Interim Destination: Sets the selected point as interim destination. The navigation system will first guide you to this interim destination. Afterwards you can continue navigation to your original destination.

Manual: Opens the manual on the navigation device. (Refer to "Manual" on page 19.)

MyReport: Opens the **MYREPORT** window. Here you can notify NAVIGON about any changes to traffic monitoring systems and routing.

MyRoutes: Opens the map in **Preview** mode. You are provided with up to three different suggestions as to how you can continue your journey. Select one of the routes offered.

New Route: Deletes the starting point and all route points from the **ROUTES AND TRACKS** window so that you can plan a new route.
If necessary, save the previously planned route!

Parking: Starts the search for car parks near the destination. Once you have decided in favour of a car park, you can navigate there directly.

POI on Your Route: Opens a list with POIs lying on your route. A destination shown here can be selected as an interim destination and can be navigated to (refer to "POI on Your Route" on page 82).

Product Information: Here you are shown the version numbers and copyright details of the hardware and software.

Rename: Opens a window in which you can change the name for the selected destination or route.

Route Profile: Opens the **ROUTE PROFILE** window. Here you can view the options for route planning and, if necessary, change them.

Routes and Tracks: Opens the **ROUTES AND TRACKS** window. Here you can plan routes, manage planned routes and start navigation on a planned route. (Refer to "Tracks and multi-leg routes" on page 48.)

Save as Favourite: Saves the selected destination to the **FAVOURITES** list. (Refer to "Saving destinations" on page 46.)

Save Destination: Saves the selected address in the **FAVOURITES** list. (Refer to "Saving destinations" on page 46.)

Save Position: Opens the **SAVE DESTINATION AS** window. Here you can save your current position under a certain name in the **FAVOURITES** list.

Save Route: Opens a window in which you can save the planned route under a specific name. (Refer to "Saving routes" on page 50.)

Saved Routes and Tracks: Opens a window in which you can load a saved route or a track.

Settings: Opens the **SETTINGS** window. Here you can configure the navigation system. (Refer to "Configuring the navigation system" on page 122.)

Show Map: Opens the map in **Standard** mode. (Refer to "Map in Standard mode" on page 60.)

Show on Map: Shows the selected address on the map.

Sightseeing Tours: Opens the **SIGHTSEEING TOURS** window. There you can select a sightseeing tour and start the navigation on a tour. (Refer to "Sightseeing Tours" on page 86.)

Simulation: Simulates a navigation on the route indicated. This simulation can be performed without GPS reception. On multi-leg routes, only the first leg is simulated.

Skip next destination: Tap on this button to omit the next route point. This button is active only when at least 2 route points still lie ahead of you. (Refer to "Tracks and multi-leg routes" on page 48.)

Start Recording, Stop Recording: Starts or ends the recording of a track. (Refer to "Tracks" on page 79.)

Traffic: Opens the **TRAFFIC INFORMATION** window in which pending reports are listed. (Refer to "TMC (Traffic Information)" on page 91.)

Turn-by-Turn List: Shows detailed directions for the route, including all points at which you must turn. (Refer to "Turn-by-Turn List" on page 89.)

8 Working with the map

8.1 Selecting the navigation map

Each country has its own navigation map. Seamless navigation over several maps on one continent is possible however if a continuous route can be calculated with the maps saved on the device.

Even if maps of countries in other continents are available on the navigation device, it can only ever work with the maps of a single continent.

Tap in the **NAVIGATION** window on [Options](#) > [Settings](#) > [Map Display](#) in order to see which maps are currently in use. Here you can also select a different continent if the navigation device contains any maps of countries on other continents.

8.2 Button bar

A bar with buttons provides access to all the functions available for operating the map.

8.2.1 Static button bar

The static button bar is available on the map in **Preview** mode and **Destination search** mode.

The static button bar can be seen at the bottom edge of the screen.

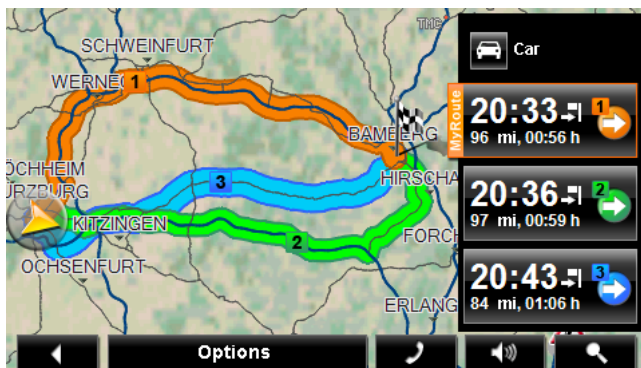

Back: Closes the navigation. (Refer to "Quitting navigation" on page 71)

Options: You can use this button during navigation to access many more functions. (Refer to "Map options in Navigation mode" on page 70)



Phone: Opens the hands-free module (only **NAVIGON 70 Premium** | **70 Premium Live**). (Refer to "Handsfree Module" on page 96)



Volume: Opens the volume control function. (Refer to "Volume" on page 67)



Destination search: Opens the map in **Destination search** mode. (Refer to "Map in Destination search mode" on page 71)

8.2.2 Dynamic button bar

The bar with the buttons is hidden on the map in **Standard** mode and **Navigation** mode. The screen looks tidier and more clearly arranged.



Proximity sensor active:

- ▶ Place your hand near the screen.

Proximity sensor inactive:

- ▶ Tap on any point on the map.



For more information on the proximity sensor refer to "Motion Sensor", page 59.

The dynamic button bar appears at the bottom edge of the screen instead of the street names.

If navigation is in progress, the **POI on Your Route** bar will appear at the top edge. (Refer to "POI on Your Route" on page 82.)



Back: Closes the navigation. (Refer to "Quitting navigation" on page 71.)



Options: You can use this button during navigation to access many more functions. (Refer to "Map options in Navigation mode" on page 70.)



Phone: Opens the hands-free module (only **NAVIGON 70 Premium** | **70 Premium Live**). (Refer to "Handsfree Module" on page 96.)



Volume: Opens the volume control function. (Refer to "Volume" on page 67.)



Destination search: Opens the map in **Destination search** mode. (Refer to "Map in Destination search mode" on page 71.)

8.3 Motion Sensor

The built-in motion sensor enables more easy and more comfortable operation of the navigation device: The button bar displays only when you place your hand near the navigation device. When you take your hand away, the bar will disappear again automatically after a few seconds.

If your navigation device is a **NAVIGON 70 Premium** you may activate the Voice Command function in the **NAVIGATION** window, on the map

and in the **HANDSFREE MODULE** window by simply touching its case frame.

8.3.1 Configuring the proximity sensor

You can configure the response characteristic of the proximity sensor.

- ▶ In the **NAVIGATION** window tap on Options > Settings > General > Use Motion Sensor. Set the value to Yes.
- ▶ In the **NAVIGATION** window tap on Options > Settings > General > Reaction Radius in order to define the radius within which the sensor responds to movements.
- ▶ In the **NAVIGATION** window tap on Options > Settings > General > Reaction Speed in order to define how quickly or slowly the proximity sensor is to respond to movements within its response radius.



For information about problems with the proximity sensor and their possible causes refer to "Troubleshooting" on page 129.

8.4 Map in Standard mode

The map is always in **Standard** mode when you are not navigating, have not calculated a route and are not searching for a destination on the map.

Under the following circumstances the map switches automatically to **Standard** mode:

- ▶ You begin a trip while the **NAVIGATION** window is open. The switch takes place after only a short while.
- ▶ You reach the destination of a navigation in **Vehicle** mode.

To open the map:

- ▶ In the **NAVIGATION** window tap on Show Map.



Note: If GPS reception is not good enough to establish your location, the map will be opened in **Destination search** mode.



The following features are typical for this view:

- ▶ Indicated in the middle of the lower third is your current position (orange arrow). The map view follows your movements so that your position is always visible on the screen.
- ▶ The scale of the map changes according to your speed.

Map options in Standard mode

1. Open the button bar. (Refer to "Dynamic button bar", page 58)



2. Tap on  (Options).

A window with several buttons opens.

The most important functions for navigation can be reached via buttons with symbols.

Other functions are found by tapping on one of the buttons Destination, Route, Services or General.



A description of all available options can be found in the chapter "Options" on page 54.

8.5 Map in Preview mode

You have entered a destination and tapped on Start Navigation.

-or-

You have planned or loaded a route and tapped on Show Route.

The map opens in **Preview** mode.

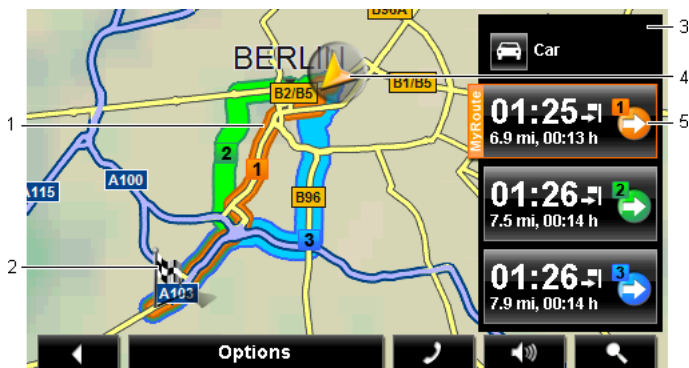

- 1 When the **MyRoutes** function is activated, up to three numbered routes are indicated on the map in different colours (orange, green, blue).

In the following cases only one route is shown:

- ▶ The **MyRoutes** function is deactivated.
- ▶ You have planned a route with more than one route point.
- ▶ A route profile with the Pedestrian speed profile is active.
- ▶ The route includes a track.

- 2 The destination is marked with a little flag.

If you display a planned or loaded route, the starting point and each route point will be marked with a little flag.

In the case of a multi-leg route, the distance and the estimated driving time for each leg are displayed.

- 3 The current route profile is indicated on the  (Route Profile) button. The symbol illustrates the mode of transport on which the profile is based. (Refer to "Route profiles" on page 73.)

- ▶ Tap on the symbol to select a different route profile.

- 4 The current position is indicated (orange arrow).



If you display a planned or loaded route and the specified starting point is not your current location, then it is possible that your current position will not be shown on the preview.

- 5 For each route (orange, green, blue) there is a button with the same number and a symbol in the same colour. Indicated on each button are the estimated time of arrival, the total distance and the estimated duration of the particular route.

If traffic messages exist for a route, the number of messages is indicated in a small traffic sign on the button. The reported obstructions are also indicated on the route.

The route which corresponds best to the selected route profile is marked with "MyRoute".

If the **MyRoutes** function is not activated, only one route is presented. As soon as you tap on a button, navigation along the route in question will start.

- ▶ Tap on the  (**Route Profile**) button (refer to the figure, point 3) in order to select a different route profile.
- ▶ To start the navigation, tap on the button for the route (see figure, point 5) you want to use for the navigation.
If you display a planned or loaded route, the route may be recalculated. The starting point for the calculation will now be your current location. You will first be guided to the first route point entered.
- ▶ Tap on **Options** > **Turn-by-Turn List** to view detailed directions for the route. (Refer to "Turn-by-Turn List" on page 89.)
- ▶ Tap on  (**Destination search**) in order to view the map in **Destination search** mode. (Refer to "Map in Destination search mode" on page 71.)

8.6 Map in Navigation mode

How you are guided to your destination depends on various factors (the route profile selected, your current location, the type of route planning, traffic information along the route, etc.). Your navigation system automatically selects the optimum method.

8.6.1 Navigation in Vehicle mode

After the route was shown in **Preview** mode, navigation was started. The map opens in **Navigation** mode.

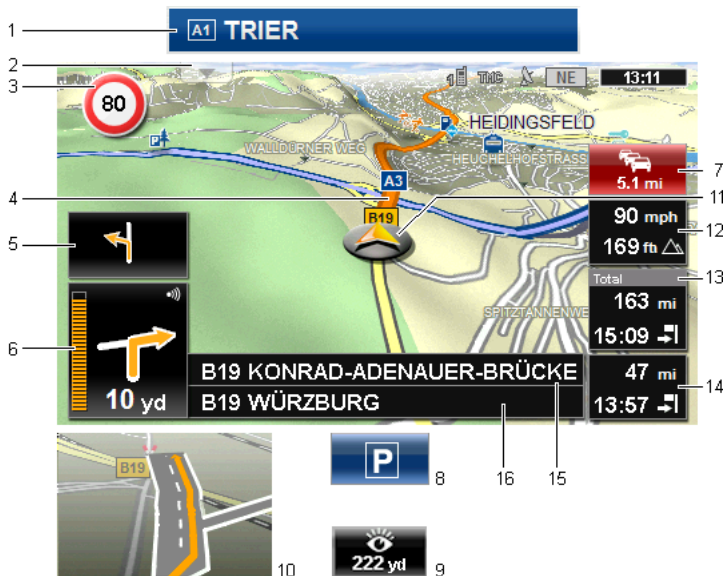

- 1 If any information is available about the sign which you should follow, it will be shown at the top edge of the screen.
 - ▶ Tap on the display to hide the sign.
- 2 The **POI on Your Route** bar will open (refer to "POI on Your Route" on page 82). This button is not visible when a sign is being shown (see point 1).



For a description of the **POI on Your Route** function refer to chapter "POI on Your Route" on page 82.

- 3 Possible speed limits may be shown here.
- 4 The route is highlighted in orange.
- 5 When two manoeuvres need to be executed in quick succession, the small arrow box indicates the second manoeuvre to be executed.
- 6 The large arrow box shows a diagram of the next junction which you should turn on to. The distance remaining to this junction is indicated underneath.

As you get closer to the junction you will see a spot diagram in addition to the distance:

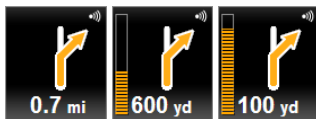

The nearer you get to the junction, the more yellow spots are displayed. If you don't have to change direction for a long time, you will see only a straight arrow. The distance you must continue straight on is indicated underneath the arrow.

- ▶ Tap on the large arrow box to hear current route instructions.

- 7 The **Traffic Information** box opens if a reported traffic obstruction affects your route.

If a distance is indicated in the **Traffic Information** box, no detour route was calculated yet for the traffic obstruction in question.

- ▶ Tap on the **Traffic Information** box in order to open the **PREVIEW TMC** window. It shows a map view with the route section affected by the message and a possible detour.

If no distance is indicated, all the obstructions which are reported for your route and would lead to a loss of time will be avoided.

- ▶ Tap on the **Traffic Information** box in order to open the **TRAFFIC INFORMATION** window. (Refer to "Displaying traffic information" on page 93.)



Note: The calculation of detour routes to avoid reported traffic obstructions can be performed automatically. (Refer to "TMC Settings" on page 94.)

- 8 When you get close to your destination, the Parking button will appear.

If you tap on the Parking box you will be given two options:

- ▶ You can select a car park from where you can then continue on foot.
- ▶ When you have parked your vehicle, you can save the current position and continue the navigation on foot.



For a description of the Parking function refer to chapter "Parking near the destination" on page 80.

- 9 When you get close to a **NAVIGON Sightseeing** sight, the NAVIGON Sightseeing button will appear instead of the height above sea level and the speed (point 12). The distance indicated on the button tells you how far away the sight is (beeline).

If you tap on the NAVIGON Sightseeing button, the **DESTINATION INFO** window will open (refer to "Displaying information about a NAVIGON Sightseeing sight" on page 85).



For a description of the [NAVIGON Sightseeing](#) function refer to chapter "NAVIGON Sightseeing" on page 84.

- 10 Ahead of many junctions the information from points 12 and 13 is hidden. Instead you are shown which lanes lead to your destination.
 - ▶ Tap on the box in order to hide the lane information.
- 11 Your current position is indicated on the map (orange arrow). The section of the map displayed changes continually so that your current position is always in view on the map.
- 12 The height above sea level and the current speed are shown here.
- 13 In the **Total** box you can see the distance remaining to the destination, the estimated duration of the trip and the estimated time of arrival.
 - ▶ Tap on the arrival time if you want to see the estimated driving time instead.
 - ▶ Tap once again on the info box if you want to see the estimated time of arrival.
- 14 If you are navigating a multi-leg route, you will see the remaining distance to the next interim destination and the estimated time of arrival in the **Next** box.
 - ▶ Tap on the arrival time if you want to see the estimated driving time instead.
 - ▶ Tap once again on the info box if you want to see the estimated time of arrival.
- 15 The name of the route section that you need to drive onto next is shown in the upper road box.
- 16 The name of the section you are currently driving on is shown in the lower road box.



Note: The displays of many of the above mentioned areas can be configured in [Options](#) > [Settings](#) > [Navigation](#). Some displays will only function if the required information is available on the map.



Note: If you tap on the large arrow box, the current route instruction will be repeated.



Note: If you leave the road system covered by the map, the navigation will switch to **Offroad** mode. (Refer to "Navigation in Offroad mode" on page 70.)

- ▶ Tap on [Options](#) > [Route](#) > [Turn-by-Turn List](#) in order to view a turn-by-turn list. (Refer to "Turn-by-Turn List" on page 89.)
- ▶ Tap on  ([Destination search](#)) in order to view the map in **Destination search** mode. (Refer to "Map in Destination search mode" on page 71.)

Volume

The volume of the spoken driving instructions can be adjusted during navigation.

1. Tap on  (**Volume**).

The volume bar opens. It contains three buttons for adjusting the volume:



2. Tap on  (**Volume**) again or wait a few seconds.
The volume bar closes.

Reality View

The map switches to **Reality View** mode when you approach one of the following points while driving on the motorway:

- ▶ a motorway junction
- ▶ a three-leg motorway junction
- ▶ the exit you must take to leave the motorway



The **Reality View** mode shows with greater clarity the signposting and lanes you must follow.

This display does not change until you have passed the spot indicated. The map will then change back to **Navigation** mode.

- ▶ If you want to change to **Navigation** mode before then, just tap on any point on the map.



Note: The **Reality View** mode is not available for all motorway junctions and three-leg motorway junctions. Availability depends on the map material used.

8.6.2 Navigation in Pedestrian mode

This mode is active if you have selected a pedestrian route profile for the navigation. These profiles can be identified by the  (Pedestrian) symbol.

After the route was shown in **Preview** mode, navigation was started.

You receive a route proposal which is calculated on the basis of the digitalised road system. You are also shown in which direction your destination lies. If you leave the proposed route, for example in order to take a more pleasant route through a park, you will still see at all times the direction in which your destination lies.

Please note:

- ▶ You will receive no navigation instructions. Instead you will receive a message when you are getting close to the destination.
- ▶ The map view follows your movements so that your position is always visible on the screen.
- ▶ If you leave the calculated route, the route will not be recalculated automatically.
- ▶ If you are navigating on a route and more route points are still to follow, navigation to the next route point will be started immediately after the message.
- ▶ Traffic messages are not taken into account.



Note: In pedestrian mode you must take care to hold the device without covering it at the top. The GPS receiver is located there and its reception could be impaired.



- 1 The scale of the map section shown is indicated here. The length of the ruler corresponds to the distance indicated.
- 2 The route which was calculated using the digitalised road system is marked in orange.

- 3 The current position is indicated (orange arrow). You can see in which direction you are moving.
- 4 The part of the route which you have already covered is marked in green.
- 5 The compass indicates where north is.
- 6 The direction in which your destination lies is indicated (red triangle).
- 7 In this box you are shown the distance remaining to the destination (beeline).

Operating the map



Zoom Out: The map section shown becomes larger, but you will see fewer details.



Zoom In: The map section becomes smaller, but you will see more details.



Centre the position: During pedestrian navigation you can shift the visible map section in order to view the surrounding area on the map. This may mean that your current position can no longer be seen on the visible section of the map.

- ▶ Tap on the **Centre the position** button if your current position can no longer be seen on the visible section of the map.

Your current position will be shown again on the map.



Recalculate route: Recalculates the route. Use this function if you have wandered far from the calculated route and would like a new route proposal.

8.6.3 Navigation in Track mode

This mode becomes active if you have planned a route with a track for the navigation. (Refer to "Tracks and multi-leg routes" on page 48.)

After the route was shown in **Preview** mode, navigation was started.

First the navigation guides you from your current location to the beginning of the loaded track. This navigation corresponds to the navigation of the selected route profile. (Refer to "Navigation in Vehicle mode" on page 63 and to "Navigation in Pedestrian mode" on page 68)

As soon as the first recorded point of the track is reached, the navigation switches to **Track** mode.

Navigation in **Track** mode works like navigation in **Pedestrian** mode. (Refer to "Navigation in Pedestrian mode" on page 68.)

There are only a few differences:

- ▶ The Recalculate route function is not available.
- ▶ If more route points follow after the track, the navigation will switch back to the originally selected mode.

8.6.4 Navigation in Offroad mode



Note: This mode does not become active if you have selected a pedestrian route profile for the navigation. These profiles can be

identified by the  (Pedestrian) symbol.

Nor does it become active if you are navigating along a track. (Refer to "Navigation in Track mode" on page 69.)

If you enter a destination which lies off the digitalised road system, the navigation will guide you first in **Vehicle** mode to the point of the digitalised road system that lies nearest to the destination. From here the navigation then continues in **Offroad** mode.

If the current position at the beginning of navigation lies off the digitalised road system, the navigation will guide you first in **Offroad** mode to the nearest point of the digitalised road system. From here the navigation then continues in **Vehicle** mode.

Navigation in **Offroad** mode works like navigation in **Pedestrian** mode. (Refer to "Navigation in Pedestrian mode" on page 68.)

There are only a few differences:

- ▶ The part of the route already covered is not shown.
- ▶ The Recalculate route function is not available.

8.6.5 Map options in Navigation mode

1. Open the button bar. (Refer to "Dynamic button bar", page 58)



2. Tap on  (Options).

A window with several buttons opens.

The most important functions for navigation can be reached via buttons with symbols.

Other functions are found by tapping on one of the buttons Destination, Route, Services or General.



A description of all available options can be found in the chapter "Options" on page 54.

8.6.6 Quitting navigation

You quit the navigation in the same way in all modes:

- ▶ Tap on  (**Back**) in order to quit navigation. A dialog box will prompt you to confirm.

8.7 Map in Destination search mode

The map is always in **Destination search** mode, when a pair of cross hairs are to be seen. Indicated in the address box are the coordinates and, where applicable, the name of the street under the cross hairs.

When you are driving, the map does not change. It is always orientated with north at the top.

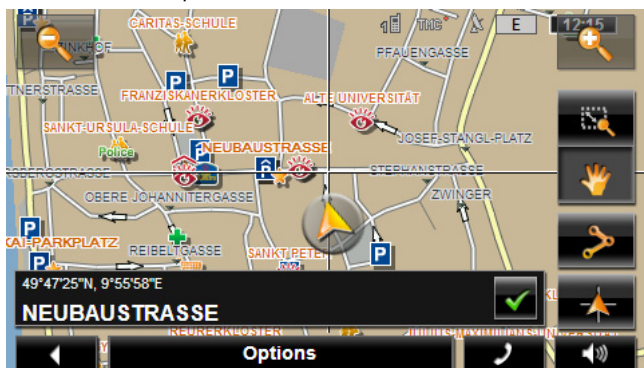

Zoom Out: The map section shown becomes larger, but you will see fewer details.



Zoom In: The map section becomes smaller, but you will see more details.



Zoom Mode: When this button is active you can mark out a section of the map with your finger.

Mark out the section from upper left to bottom right to zoom in until the section fills the screen.

Mark out the map section from bottom right to top left to zoom out.



Pan Mode: When this button is active you can change the section of map shown with your finger. Simply drag the map in the desired direction.



Entire Route: Zooms the map so that the entire route is visible.



Current Position: Selects the section of map displayed so that the current location is at the centre.

8.7.1 Operating in Destination search mode

1. Tap on the point to which you want to navigate.
The destination that you have selected appears under the cross hairs.
The geographical coordinates of the destination and the corresponding address are shown in the bottom third of the screen.
2. Tap on  (OK).
Buttons with various functions will be displayed.

Take Me There: Starts navigation to the selected point. If you are currently navigating, this route navigation will be cancelled.

MyReport: Opens the **MYREPORT** window. Here you can notify NAVIGON about any changes to traffic monitoring systems and routing.

Interim Destination: Sets the selected point as interim destination. The navigation system will first guide you to this interim destination. Afterwards you can continue navigation to your original destination.
This function is only active during navigation.

Add to Route: Adds the selected point to the route planning as the last point. Navigation will then continue to this point after you have reached the original destination or the other route points.

Save: Opens the **SAVE DESTINATION AS** window. You can enter a name under which the selected point will be saved in the **FAVOURITES** list. (Refer to "Saving destinations" on page 46.)

Search Nearby: Opens the **POI NEARBY** window. Here you can search for destinations near the selected point. (Refer to "POI nearby" on page 36.)

- ▶ Tap on  (Back) in order to quit **Destination search** mode. You will be returned to the window from which you started this mode.

9 Useful functions

9.1 Route profiles

Route profiles define the characteristics and special aspects of the different modes of transport which are to be taken into account when calculating routes. For example a route profile for bicycles will exclude motorways from the route calculation but will include roads which other vehicles are not allowed to use. And different arrival times will be calculated for a bicycle than for a motorcycle for example.

9.1.1 Route profile settings

A route profile is made up of several settings:

- ▶ **Speed Profile:** Defines the mode of transport (e.g. Bicycle, Pedestrian, Car, ...).
- ▶ **Type of Route:** Defines the type of route which is to be calculated (e.g. Short Route, Fast Route, ...).
- ▶ **Consider Traffic Information:** Defines whether traffic messages are to be considered when calculating the route.
- ▶ **Motorways, Ferries, Restricted Areas:** Defines whether these types of road are allowed to be used.
- ▶ **Use of Toll Roads:** Defines whether toll roads are allowed to be used when calculating the route.
 - ▶ Tap on the  (Edit) button.
The **USE OF TOLL ROADS** window opens.
 - ▶ Adapt the individual settings to your requirements (Yes, No, Ask before). (Refer also to Configuring the navigation system on page 122.)
If you activate the Ask before setting, every time your route can take a toll road you will be prompted to make the corresponding setting(s).

For each setting there is a  (Help) button. When you tap on it you will see an exact definition of the setting in question.

The number of possible settings depends on the selected speed profile. For example, for the Pedestrian speed profile there are no Motorways and Use of Toll Roads settings.

9.1.2 NAVIGON basic profiles

A basic profile is already defined for each speed profile.



Bicycle



Pedestrian



Lorry



Motorbike



Car

The speed profile of a basic profile cannot be changed. You can adapt the other settings to your requirements.

Basic profiles cannot be renamed or deleted.

To have a choice of different profiles for example for several cars, you can create your own route profiles.

9.1.3 Creating a new route profile

You can create your own route profiles. This makes sense for example if you own two cars and only one has a prepaid toll disc for Austrian motorways.



1. Tap on Options > Settings.

If the map is open in **Standard** mode, tap on Options > General > Settings.

2. Tap on the  (Current Route Profile) button. This button can also show a different symbol.
3. Tap on the name of the route profile which you want to take as basis for the new profile.
4. Tap on Options > Copy.
5. Enter a name for the route profile.
6. Tap on Save.
7. Adapt the route profile to your requirements.
8. Tap on OK.

The new route profile is shown in the **ROUTE PROFILES** list.



9.1.4 Selecting a route profile

1. Tap on Options > Settings >  (Current Route Profile).
If the map is open in **Standard** mode, tap on Options > Route > Current Route Profile.
2. Tap on the name of the route profile which you want to use.
3. Tap on  (Back).

9.1.5 Managing route profiles

User-defined route profiles can be edited, renamed and deleted.

Editing a route profile

1. Tap on Options > Settings.
If the map is open in **Standard** mode, tap on Options > General > Settings.
2. Tap on the  (Current Route Profile) button. This button can also show a different symbol.
3. Tap on the  (Edit) button alongside the route profile that you want to edit.
4. Make the required settings.
5. Tap on OK.

The Use of Toll Roads setting is comprised of several individual settings. For example for each country with toll motorways you can select whether you want to use these roads for the navigation.

1. Tap on the  (Edit) button alongside the Use of Toll Roads setting.
The **USE OF TOLL ROADS** window opens.
2. Adapt the individual settings to your requirements (Yes, No, Ask before).
If you activate the Ask before setting, each time the route preview wants to calculate a route with a toll road you will be asked whether you want to use the type of toll roads in question. You can then lay down this setting for future journeys as well.

Renaming a route profile

1. Tap on Options > Settings.
If the map is open in **Standard** mode, tap on Options > General > Settings.

2. Tap on the  (Current Route Profile) button. This button can also show a different symbol.
3. Tap on the name of the route profile which you want to rename.
4. Tap on Options > Rename.
5. Enter the new name for the route profile.
6. Tap on Save.



Note: Basic profiles cannot be renamed.

Deleting a route profile

1. Tap on Options > Settings.
If the map is open in **Standard** mode, tap on Options > General > Settings.
2. Tap on the  (Current Route Profile) button. This button can also show a different symbol.
3. Tap on the name of the route profile which you want to delete.
4. Tap on Options > Delete.
5. A dialog window prompts you to confirm deletion.
6. Tap on Yes.



Note: Basic profiles cannot be deleted.

9.2 MyPOIs

You can create files with your own POIs. These files have to be made available to your navigation system in a specific folder.

If you want to choose from your own POIs, you will find them under the **MyPOIs** category of POIs. Each file with your own POIs is listed as a sub-category. Each sub-category can have a personally created symbol for representing your destinations on the map.

NAVIGON 70 Premium, NAVIGON 70 Premium Live:

Note: The navigation device can import a maximum of 10,000 POIs. These destinations are allowed to be shared among a maximum of 40 sub-categories.

NAVIGON 70 Plus:

Note: The navigation device can import a maximum of 1,000 POIs. These destinations are allowed to be shared among a maximum of 40 sub-categories.

9.2.1 Creating your own destinations

1. Open an empty document in an editor which can save the files in UTF8 code (e.g. MS Notepad, Microsoft Word).



Note: The following description is based on the use of MS Notepad as editor. If a different editor is used, the saving of the file and its UTF-8 coding (point 4-9) may differ from this description.

1. Open an empty document in an editor of your choice (Notepad, Microsoft Word, Microsoft Excel).
2. For each destination create a data record (one line) with the following form:
 - ▶ Longitude. Begin the entry with a minus sign if you want to enter a western degree of longitude. The longitude must be entered as a decimal number with a dot as the decimal sign.
 - ▶ Comma (as list separator)
 - ▶ Latitude. Begin the entry with a minus sign if you want to enter a southern degree of latitude. The latitude must be entered as a decimal number with a dot as the decimal sign.
 - ▶ Comma (as list separator)
 - ▶ Name of the destination. Any name is possible, but no commas are allowed. If the use of a comma is indispensable, precede it with a backslash ("\").
 - ▶ Comma (as list separator)
 - ▶ PHONENUMBER=
 - ▶ A phone number. This entry can remain empty.
 - ▶ Tilde ('~')
 - ▶ Additional information. This entry can remain empty.
 - ▶ Enter (in order to begin a new data record)

The address does not have to be included in the data record. It is shown automatically when you select this POI for navigation.

Example:

9.94302,49.79906,NAVIGON AG,PHONENUMBER=+49 931~Best Navigation Devices

3. Repeat step 2 for each destination you want to save in this file.
4. Click on File > Save.
5. Select a folder in which you want to save the data.
6. In the File type box select the All Files option.
7. In the file name box enter a name of your choice followed by '.csv', e.g. 'XYZ.csv'. Please note that the file name will appear in the navigation system as a sub-category! This means that if you save a

file under the name 'XYZ.csv', the destinations of this file will appear in the sub-category **XYZ**.

8. In the Encoding box select the UTF-8 option.
9. Tap on Save.

9.2.2 Symbols for your own POIs

For each sub-category of your own POIs you can create a symbol which is used to represent the destinations of this sub-category on the map.

These symbols must be graphic files with the following characteristics:

- ▶ File format **bmp** (Bitmap) or **png** (Portable Network Graphic)
- ▶ Size max. 40x25 pixels

The graphic files must be saved in the same folder as the files with the POIs.

The file name must be the same as the name of the category.

Example:

Destinations of the **XYZ** sub-category are saved in the 'XYZ.csv' file. They are represented on the map by the 'XYZ.bmp'symbol.

9.2.3 POI-Import: Importing your own POIs onto the navigation device

The files you have created with your own POIs and the related symbols must still be transferred to the navigation device. This is very easy to do with the **NAVIGON Fresh** software which can be downloaded free of charge from our website www.navigon.com/fresh.

9.3 Screenshots

You can create and save screenshots of the content currently shown on the screen at any moment.

9.3.1 Enabling screenshots

1. In the **NAVIGATION** window tap on Options > Settings > General > Enable Screenshots.
2. Select whether you want to enable screenshots (Yes) or not (No).

The  (Screenshots) button appears at the bottom right edge of the screen.

9.3.2 Creating a screenshot

- ▶ Tap on the  (Screenshots) button.

The screen is saved as a graphic. The  ([Screenshots](#)) button is not shown in the figure.

The screenshots are saved in the **\ScreenShots** folder. This folder can be found either in the internal memory of the navigation device, on the inserted memory card or in both memories.

9.4 Tracks

You can record any section of a route you take, even if it lies off the digitalised road system.

You can record for example a bicycle tour and follow the same route again some time later.

Tracks are saved in KML data format. KML is a widely used data format. You can also play back your tracks for example in Google Earth on your PC.

Recording a track

You can record a track when the map is open in **Navigation** mode or in **Standard** mode.

1. Tap on [Options](#) > [Services](#) > [Start Recording](#).

The **START RECORDING** window opens.

2. Enter a name for the planned recording.



Note: Only Latin characters are available for naming tracks.

3. Tap on [Start Recording](#).

Starting from your current position, the navigation device will record the entire route you now take.

The  (**Record Track**) symbol appears at the top right edge of the screen throughout the recording.

The recorded route is saved in the **SAVED ROUTES AND TRACKS** list in KML data format. It can be loaded again from there at any time.

Stopping the recording

1. Tap on [Options](#) > [Services](#) > [Stop Recording](#).

The recording is stopped. The recorded route is saved in the **SAVED ROUTES AND TRACKS** list in KML data format. It can be loaded again from there at any time.



Note: Switching off the navigation device will only interrupt the track recording. If you want to stop the recording, you must proceed as described above.

Using a track for navigation

You can load saved tracks as part of planning a route. (Refer to "Loading routes or tracks" on page 50.)



Note: All tracks that have been saved in KML data format are suitable for route planning. Use **NAVIGON Fresh** in order to load tracks from other suppliers onto your navigation system.



Note: When you are navigating along a recorded track, any incoming TMC messages will not be checked to see if they concern the track in question.

9.5 Parking near the destination

When you get close to your destination, the  (Parking) button will appear on the screen. This button also remains visible after you have reached your destination as long as you stay close to the destination and the map is not closed.

The following scenarios are imaginable:

Continuing on foot

You see a car park, park your vehicle and want to continue to the destination on foot.

1. Tap on the  (Parking) button.
2. Tap on Pedestrian mode.

The following message appears: "Your current position has been saved. You will find it in the 'Favourites' list as 'My Vehicle'. This enables you to easily find the way back to your vehicle."

3. Tap on OK.

The position of your vehicle is marked on the map by a flag with a star.

The navigation continues to guide you to the destination in **Pedestrian mode**.

Searching for a car park

You want to be guided to a car park near the destination. From there you want to walk to the destination.

1. Tap on the  (Parking) button.
2. Tap on Parking Close to Destination.

A list opens. You are shown possible car parks in order of distance from your destination.

3. Tap on the car park where you want to park your vehicle. You are shown more information about this car park.
4. Tap on Add.
5. The navigation now guides to the selected car park in the mode corresponding to the selected route profile. When you arrive there, the following message appears: "Your current position has been saved. You will find it in the 'Favourites' list as 'My Vehicle'. This enables you to easily find the way back to your vehicle."
6. Tap on OK.
The position of your vehicle is marked on the map by a flag with a star.

The navigation continues to guide you to the destination in **Pedestrian** mode.

Back to the destination

You have reached your destination. Navigation has ended. For some reason, however, you carry on driving, perhaps because you were unable to find a place to stop. Now you want to be guided back to the destination.

1. Tap on the  (Parking) button.
2. Tap on Last Destination.

The navigation now guides you back to the original destination in the mode corresponding to the selected route profile.

NAVIGON Clever Parking: Current information about parking options

Some parking options are marked by a small asterisk (e.g. ). There is more information available for these parking options, e.g. opening times or the number of parking spaces for women or the number of parking spaces for the handicapped.

This information is becoming available for more and more parking options. Regular updates of this information can easily be obtained via the **NAVIGON Fresh** software. **NAVIGON Fresh** can be downloaded free of charge from the website www.navigon.com/fresh.

9.6 Nearby

During the navigation, or after having opened the map using the Show Map button, you can have POIs, Favourites and traffic information of the current map view shown in a clearly arranged list.



Note: This function is not available if the map was opened in one of the modes **Destination search**, **Preview** or **Reality View**.

1. Tap on the map on a symbol which represents a POI, a favourite or a traffic message.
The **NEARBY** list opens. It contains all the POIs, favourites or traffic messages to be found in a small radius around the position on which you have tapped.
2. Tap on an entry in the list in order to receive detailed information about it.

You have the following options:

- ▶ Tap on **Interim Destination** in order to set the selected point as an interim destination. The navigation system will first guide you to this interim destination. Afterwards you can continue navigation to your original destination. The **Interim Destination** button is available in navigation mode only.
- ▶ Tap on **Start Navigation** in order to navigate to the selected point.
- ▶ Tap on **Cancel** in order to close the list again.

9.7 POI on Your Route



Note: This function is available only during navigation in **Vehicle** mode (refer to "Navigation in Vehicle mode" on page 63).



You can stipulate 3 categories of POIs for the **POI on Your Route** function. POIs which lie along your route and match one of these categories can be quickly displayed and selected as an interim destination during the navigation.

9.7.1 Displaying POIs along the route

1. Tap on the  (**POI on Your Route**) button which appears at the top left of the map (refer to point 2 in "Navigation in Vehicle mode" on page 63).



The **POI on Your Route** bar opens.



It shows symbols of the 3 stipulated categories of POI. The distance to the nearest POI in each category is indicated. The marking along the route also indicates whether the POI lies on the right () or left () in driving direction.

Note: The **POI on Your Route** bar closes after a few seconds.



If you want the bar to remain open, tap on the  (**Fix**) button. The button changes to  (**Fixed**).

2. Tap on one of the categories in order to show a list with more POIs in this category.

The **POI ON YOUR ROUTE** list opens.

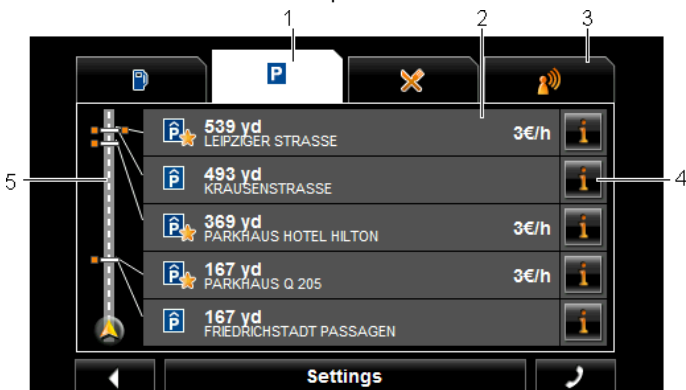



- 1 Symbols of those categories in which POIs are available are shown at the top edge of the screen. The symbol of the currently selected category is highlighted.
 - ▶ Tap on the symbol of the category whose POIs you want to have displayed.
- 2 The list contains the next 5 POIs, sorted by distance in descending order, which lie along your route and are in the stipulated category. The nearest POI is therefore the lowest entry in the list.
- 3 **Voice Command:** Opens the **VOICE COMMAND** window in which you can initiate the search for POIs by voice commands (refer also to "Voice Command" on page 26).



Note: If the voice commands function is not available for the language of the user interface, the **Voice Command** button will be deactivated.

- 4 Additional information about each POI in the list can be displayed.
 - ▶ Tap on the  (**Info**) button on the right alongside the corresponding POI (refer also to "Information about the destination" on page 40).

- 5 The route and your current position are shown schematically on the left edge of the screen. The markings along the route indicate the distance of the listed destinations from your position. The orange-coloured markings indicate whether the respective destination is on the right () or on the left () in driving direction.



9.7.2 Navigating to one of the destinations

- ▶ Tap in the list on the destination to which you want to navigate. The selected destination will be inserted as an interim destination. The system recalculates the route. Navigation to the original destination will be continued after reaching the interim destination.

9.7.3 Selecting categories

You can stipulate which 3 categories or sub-categories are to be available for the POIs along the route.

1. Tap in the **POI ON YOUR ROUTE** list on Settings. The **SETTINGS: POI ON YOUR ROUTE** window opens.
2. Tap on the  (List) button alongside the category you want. The list of POI categories will open.

If any sub-categories exist for a category, the  (List) button will be shown again alongside it. Tap on this button to show the sub-categories.
3. Select a category.
4. Tap on OK. The **SETTINGS: POI ON YOUR ROUTE** window opens.
5. Tap on OK.
6. The **POI ON YOUR ROUTE** list opens. If there are POIs of the newly selected category along the route, they will already appear in the list.
7. Tap on  (Back) in order to close the list. The map opens.

9.8 NAVIGON Sightseeing



NAVIGON Sightseeing sights are a special category of POIs. You can be pointed to these sights when you get close to them.



Note: Pointers are possible only during navigation or when the map is opened in **Standard** mode.

Activating pointers to NAVIGON Sightseeing sights

You can select whether or how you want to be pointed to **NAVIGON Sightseeing** sights.

1. In the **NAVIGATION** window tap on Options > Settings > Navigation > Info about 'NAVIGON Sightseeing' Destinations.
2. Select one of the following settings:
 - ▶ **No:** You will not be pointed to **NAVIGON Sightseeing** sights.
 - ▶ **Only on the Screen:** When you get close to a **NAVIGON Sightseeing** sight, the  (**NAVIGON Sightseeing**) button will appear on the map and can be used to open the **DESTINATION INFO** window.
 - ▶ **Audio Info for Important Destinations:** For nationally known sights, a description will be read out as soon as the  (**NAVIGON Sightseeing**) button appears.
 - ▶ **Audio Info for All Destinations:** For all sights in the category, a description will be read out as soon as the  (**NAVIGON Sightseeing**) button appears.



Note: Particularly detailed information about each **NAVIGON Sightseeing** sight can easily be purchased via the **NAVIGON Fresh** software. **NAVIGON Fresh** can be downloaded free of charge from the website www.navigon.com/fresh.



Note: Descriptions cannot be read out in every language. In this case the two settings Audio Info for Important Destinations and Audio Info for All Destinations are not available.



Note: During navigation in **Pedestrian** mode you will receive a pointer only when your destination is a **NAVIGON Sightseeing** destination and you are getting close to your destination.

Displaying information about a NAVIGON Sightseeing sight

- ▶ You have chosen to be informed about **NAVIGON Sightseeing** sights (refer to "Activating pointers to NAVIGON Sightseeing sights" on page 85).
- ▶ The map is open in **Navigation** or **Standard** mode.

When you get close to a **NAVIGON Sightseeing** sight, the



(**NAVIGON Sightseeing**) button will appear on the map. The distance indicated on the button tells you how far away the destination is (beeline). Depending on your settings, a description of the destination will be read out in addition.

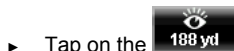

- ▶ Tap on the **NAVIGON Sightseeing** button.

The **DESTINATION INFO** window opens. In addition to a description it contains information such as the address, phone number or opening hours.

You have the following options:

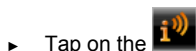

- ▶ Tap on the **Audio Info** button in order to start or stop the description being read out.



- ▶ Tap on the **Show on Map** button in order to show the sight on the map.



- ▶ Tap on the **Save Destination** button in order to save the sight in the **FAVOURITES** list.

- ▶ Tap on the picture of the sight to show it in full screen mode.
Tap on the picture again in order to close full screen mode.

- ▶ During navigation: Tap on **Interim Destination** in order to insert the sight as an interim destination.

- ▶ If there is no navigation in progress: Tap on **Start Navigation** in order to start the navigation to this sight.

- ▶ Tap on **Close** in order to close the **DESTINATION INFO** window again and return to the map view.

9.9 Sightseeing Tours

Sightseeing Tours are predefined routes with destinations of scenic, cultural or touristic interest which are sorted according to various categories.



Note: The navigation software contains only a limited number of sightseeing tours. An update with more than 100 sightseeing tours can be purchased via **NAVIGON Fresh**. The **NAVIGON Fresh** software can be downloaded free of charge from the website www.navigon.com/fresh.

1. In the **NAVIGATION** window, tap on **Options** > **Sightseeing Tours**.
The **SIGHTSEEING TOURS** window opens.

2. Enter the country in which you want to search for sightseeing tours (refer to "Specifying the country in which the destination is situated" on page 31).
3. Select a category from which you would like to find a route.
The **NAME** list opens. It contains routes from the specified category, sorted alphabetically.
4. Tap on the name of the route.
The **DETAILS OF THE ROUTE** window opens.
It shows the name of the route, the length of the route, the estimated driving time and a short description of the route.
 - ▶ Tap on Info to receive a detailed description of the route.
 - ▶ Tap on Close to reopen the **DETAILS OF THE ROUTE** window.
 On the Begin at... button you are told at which route point the route starts:
 - ▶ First: You are guided from your current position to the advised starting point of the sightseeing tour. Navigation on the selected tour then begins.
 - ▶ Nearest: You are guided from your current position to the most favourable starting point for the selected tour. Navigation on the selected tour then begins.
The most favourable starting point is
 - ▶ for a round trip: the nearest point on the route.
 - ▶ for any other trip: the nearest end point (start or destination) of the route.
5. Tap on Begin at... in order to select the alternative setting.
6. Tap on Plan route.
The **ROUTES AND TRACKS** window will open (refer to "Tracks and multi-leg routes" on page 48).
Here you can obtain an overview of the various legs of the selected tour and of the order the legs will follow.



Note: The list of route points in the **ROUTES AND TRACKS** window is for orientation purposes only. It is impossible in this list to change the order of the route points, delete route points or add new route points.

- ▶ Tap on Show Route.
The map opens in **Preview** mode and you can start the navigation on the route.



Note: Detailed information about starting the navigation and about the map in **Preview** mode can be found in the chapter "Map in Preview mode" on page 61.

9.10 Direct Help

If you arrive at the scene of an accident or have an accident yourself, it may be necessary to call for emergency aid and to give the answering office your current location.

- ▶ In the **NAVIGATION** window tap on Options > Direct Help.

If you are currently in a navigation:

- ▶ Tap on Options > Services > Direct Help.

The **DIRECT HELP** window opens.

If GPS reception is good enough, the address and the geographic coordinates of your current location will be indicated.



- ▶ Tap on  (Show on Map) if you want to view your current location on the map.

In the bottom half of the window you will find the buttons for 4 categories: Petrol Station, Police Station, Hospital, Pharmacy.

- ▶ Tap on the corresponding button.

The nearest help point in the selected category will be indicated. You are shown the name, address, phone number (if known) and distance of the help point from your current location.

You have the following options:

- ▶ Tap on the Map button in order to see your location and the help point on the map. This gives you an overview of the route to the help point.
- ▶ Tap on Start Navigation. You will then be guided directly to the displayed help point.
- ▶ You can use the  (Up) and  (Down) buttons to select other help points in the selected category.
The help points are sorted by distance from your current position.
- ▶ Use the  (Back) button to return to the **DIRECT HELP** window.



Note: Only those help points are displayed which are situated no further than 30 mi from your position.

9.11 GPS Status, saving the current location

In the **GPS STATUS** window you will find an overview of the data the navigation system calculates from the GPS signals it receives.

The GPS status can be accessed from the options button in many windows.

- ▶ Tap on Options > GPS Status.

The current location can be saved in the **FAVOURITES** list.

1. Tap on Save Position.
The **SAVE DESTINATION AS** dialog box opens.
2. Enter a name for the destination.
3. Tap on Save.

9.12 Block

You can block a leg of the route at any time during a navigation, i.e. to re-calculate the route in order to avoid the leg, e.g. if you have heard on the radio of a traffic jam affecting this section.



Note: The block is valid only for the current navigation. It no longer exists on a new navigation.

You are currently in a navigation. The map is open in **Navigation** mode.

1. Tap on Options.
Buttons with various functions will be displayed.
2. Tap on Block.
The **BLOCK** menu opens. It contains buttons with different distance values.
3. Select the distance you want to block.



Note: If you are currently driving on a motorway, the alternative route will begin at the next exit. Indicated on the buttons is the junction up to which the block extends.

The system recalculates the route. The blocked route section will be avoided. It is marked on the map in red.

Unblocking a route section

- ▶ Tap on Options > Unblock.
The block will be lifted. The system recalculates the route. The unblocked route section can now be integrated into the calculation.

9.13 Turn-by-Turn List

You can display detailed directions of the calculated route before starting navigation or at any time during navigation. This list displays all of the driving instructions in table form.

The map is open in **Preview** mode:

- ▶ Tap on Options > Turn-by-Turn List.

The map is open in **Navigation** mode or in **Reality View** mode:

- ▶ Tap on [Options](#) > [Route](#) > [Turn-by-Turn List](#).

The **TURN-BY-TURN LIST** window opens.

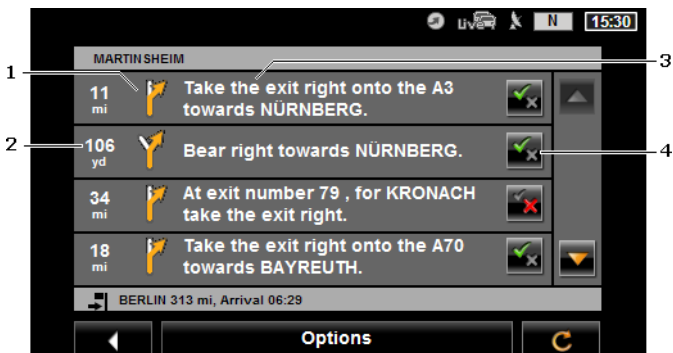

- 1 Schematic depiction of the next junction where you must make a turn.
- 2 Distance to this junction.
- 3 Route instruction and if available the name of the street into which you must turn.
- 4 Indicates whether you want to drive on the route section in question or not.



(Allow): The section in question is allowed on the route.



(Forbid): The section in question is not allowed on the route.

Blocking route sections

1. Tap on the route sections that you do not want to travel on so that the (Forbid) symbol appears next to them.
2. Tap on (Modify Route).
The navigation system calculates an alternative route avoiding the route sections selected. The new driving instructions are displayed in the **TURN-BY-TURN LIST** window.
3. Tap on (Back) in order to close the **TURN-BY-TURN LIST** window again.

Removing blocks and using original routes

Section blocks can be removed at any time.

- ▶ In the **TURN-BY-TURN LIST** window, tap on [Options](#) > [Calculate Original Route](#).

9.14 TMC (Traffic Information)

The integrated TMC receiver enables the navigation system to make use of current traffic messaging. If necessary it can change your route dynamically, for example in order to avoid a traffic jam.



Note: TMC is available free of charge in many European countries. PremiumTMC, promising a faster and more up-to-date service, is offered (exclusively or in addition) in some countries at a charge.

You can subscribe to PremiumTMC services on our website www.navigon.com.

9.14.1 Preview TMC

If a new traffic message concerning your route arises while navigation is in progress, the Traffic Information button will appear at the right edge of the screen.

Recalculate Route: Automatically

If you have selected Automatically for the Recalculate Route setting, the button will not show a distance. The traffic obstruction will be avoided automatically if this can justifiably shorten the trip. If not, the traffic information will be ignored.

Recalculate Route: On Request

If you have selected On Request, then the distance to the reported traffic obstruction will be indicated on the button. The button will turn red if the distance is less than 30 mi.

- ▶ Tap on the  (Traffic Information) button.

The **PREVIEW TMC** window opens. It shows a map view with the route section affected by the message. If the reported obstruction is likely to involve a considerable loss of time, a possible detour will also be shown.

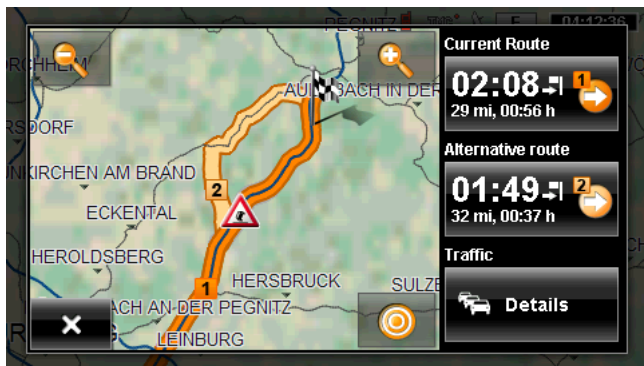

Zoom Out: The map section shown becomes larger, but you will see fewer details.



Zoom In: The map section becomes smaller, but you will see more details.



Original map section: The original map section is shown again.

- ▶ Tap on the button of the route you want to follow.

-or-

- ▶ Tap on the Details button.

The **TRAFFIC INFORMATION** window opens. (Refer to "Displaying traffic information" on page 93.)



Note: If you tap on a traffic symbol (in the display: ) in the map view of the **PREVIEW TMC**, a window with detailed information about this message will open. (Refer to "Showing a single message in detail" on page 94.)

Recalculate Route: On Request

If you have selected On Request, the button may also appear in green. In this case there is no longer a traffic obstruction requiring a detour.

- ▶ Tap on the  (Traffic Information) button.

The **PREVIEW TMC** window opens (see above). You can now have yourself guided back to the original route or continue on the detour.

9.14.2 Displaying traffic information

Current traffic information is available via the options button in many windows.

- ▶ In the **NAVIGATION** window, tap on Options > Traffic.

The **TRAFFIC INFORMATION** window opens.

You can use the  (Up) and  (Down) buttons to scroll in the list of messages.

- ▶ Tap on  (Back) in order to close the **TRAFFIC INFORMATION** window again.

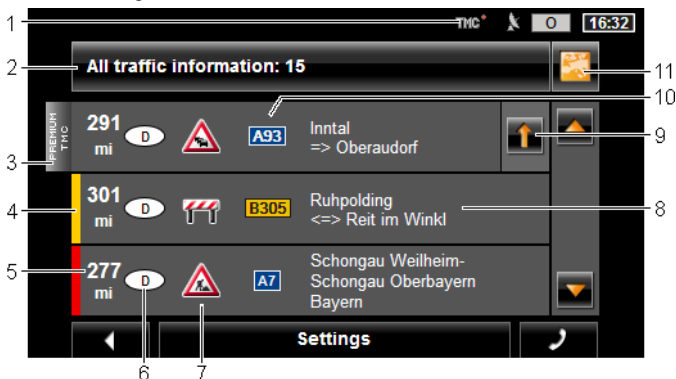

- 1 The **TMC** symbol tells you that the listed messages come from radio stations. If you receive the traffic information from the **NAVIGON Live** services, the **Traffic Live** symbol will appear here (refer to "Traffic Information" on page 22).
- 2 The Traffic Information button shows the type of traffic messaging listed and how many messages of this type are in the list.
 - ▶ Tap on Traffic Information in order to select the messages you want displayed.
- 3 This mark indicates that the message in question comes from a PremiumTMC provider.
A similar mark also appears when the particular message comes from the **NAVIGON Live** services.
- 4 Here you can see how serious the obstruction is:

Red: The affected section of the route is fully blocked by the obstruction or involves a considerable loss of time (more than 30 minutes) to pass through. This can be the case for example when several lanes are blocked due to an accident.



Yellow: The section is not fully blocked by the obstruction but there is a threat of delays (10-30 minutes). This can be the case for example with slow-moving traffic.

No colour: The obstruction is not classified as serious. This can be the case for example when slow-moving traffic is reported on a very short section, when SOS telephones are not working or when parking areas are blocked off.

- 5 Here you can see how far you are from this obstruction. If the obstruction does not lie on your route or if a detour route was already calculated for this obstruction, then the distance as the crow flies will be shown.
- 6 Here you can see in which state the obstruction lies.



Note: Most radio stations report only traffic obstructions in their own state.

- 7 Here the reported obstruction is displayed as a traffic sign.
- 8 Here the affected road is indicated.
- 9 Here you can see on which section of the road the obstruction lies.
- 10 The navigation system can **Detour** () or **Ignore** () obstructions on the route. The button indicates the particular status. Tap on the button to select the other setting.

9.14.3 Showing a single message in detail

- ▶ Tap on a message to display this information in detail.



The navigation system announces the traffic message in question if the detail view is open. The announcement of traffic messages is not possible in every language however.



Note: You can configure the reading out function. Tap on **Options > Settings > General > Reading out traffic information** and select whether you want TMC messages to be read out or not (**Yes** or **No**).

- ▶ Tap on the  (**Show on Map**) button in order to view the section concerned on the map.

9.14.4 TMC Settings

- ▶ In the **TRAFFIC INFORMATION** window tap on **Settings**.

In the **TMC SETTINGS** window you can set the TMC traffic station and configure whether the reception of a traffic message concerning your route should affect your route planning and if so how.

Tuning Mode

Tap on Tuning Mode and select a method for selecting the TMC radio station.

- ▶ Automatic: You can use the arrow keys in the station area to select another station. The system will search for another station if reception becomes poor.
- ▶ Hold station: You can use the arrow keys in the station area to select another station. The system will search for the same station on a different frequency if the signal becomes poor.
- ▶ Hold frequency: You can use the arrow keys in the station area to select another frequency. The system will not search for another station if reception becomes poor.

Recalculate Route

Tap on Recalculate Route and select how new traffic messages concerning your route are to be used.

- ▶ Automatically: An alternative route will be calculated automatically. The system will inform you on the recalculation.
- ▶ On Request: An announcement from the navigation device tells you that a traffic message concerns your route. On the screen the Traffic Information box indicates the distance to the reported traffic obstruction.

Tap on the Traffic Information box. You can then decide whether an alternative route is to be calculated or not.

9.15 Logbook

You can use your navigation device to record a logbook. The logbook is recorded in the "Logbook.xls" file. You can open the file with Microsoft Excel. Each recorded trip is added at the bottom of the table as a new entry.

The first time a trip is recorded, the "Logbook.xls" file will be created in the "NAVIGON\Logbook" folder. If you delete or move this file, a new file will be created when you next record a trip.

Recording trips

You can have all trips recorded automatically.

1. In the **NAVIGATION** window tap on Options > Settings > Navigation.
2. Set Logbook to Yes.
3. Tap on OK.

Every trip from now on will be recorded until you reset Logbook to No. It is possible, however, to exclude individual trips from the recording.



The navigation system also records trips when you are not navigating. Of course this requires the navigation system to be switched on and receiving GPS signals.

Before a trip

If your trips are recorded in the logbook, a window for entering the trip's key data is opened before the trip begins. You can also decide, however, not to record the trip in question.

- ▶ If you don't want to record the trip in question, tap on



-or-

1. In the Reason for the Trip box tap on one of the possible reasons for the trip.
2. Enter a name for this entry, e.g. "Trip to customer X", in the Logbook Entry box.
3. Tap on Mileage
4. Enter the mileage of your vehicle.
5. Tap on Start.
Navigation starts.

10 Handsfree Module



This chapter is relevant for you only if your navigation device is one of the following devices:

- ▶ **NAVIGON 70 Premium**
- ▶ **NAVIGON 70 Premium Live**

The navigation device has a hands-free module which supports Bluetooth connections to Bluetooth-capable mobile phones and headsets. It can be connected simultaneously to up to two mobile phones or to a headset.

If you have set up a connection to a mobile phone, you can use the navigation device as a hands-free module for it.

If you have set up a connection to a Bluetooth headset, you will hear the voice instructions from the navigation software via the headset. This is useful for example when travelling on a motorcycle. All other functions described in this chapter are not available when connected to a headset.



A compatibility list of all supported mobile phones can be found on our website www.navigon.com.

Opening the hands-free module

- ▶ Tap in the navigation application on  (Phone).

The **HANDSFREE MODULE** window opens.

When you start the hands-free module for the first time, a window will open in which you can start a search for Bluetooth-capable devices.

- ▶ Tap on Yes if you want to start the search now and set up a connection to a headset or a mobile phone. As soon as the navigation device has found your Bluetooth device you can initiate the pairing (refer to "Pairing with a device" on page 99).
- ▶ Tap on No if you want to initiate the connection later. (Refer to chapter "Searching for and pairing Bluetooth devices" on page 98)

Elements of the hands-free module

All functions can be reached from the **HANDSFREE MODULE** window.

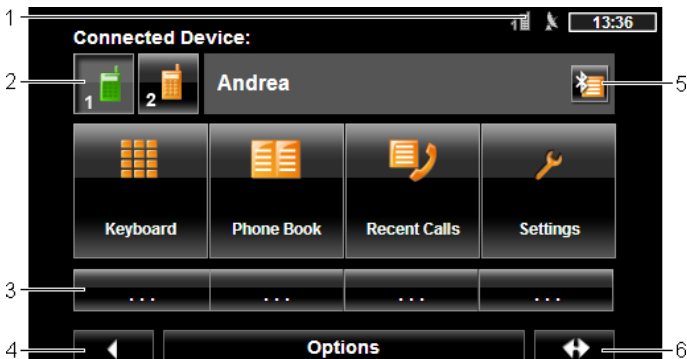

- 1 Status display of the hands-free module. This status display can also be seen in the navigation software. (Refer to "Bluetooth / Phone" on page 23.)
- 2 The Phone 1 and Phone 2 buttons are used to select the active phone. (Refer to "Activating a mobile phone" on page 102.)

The button of the currently active phone has a "pressed" look (here: Phone 1). The name of the active phone appears alongside the buttons.

These buttons can have various colours:

- ▶ Green, if a mobile phone is connected as "Phone 1" or as "Phone 2".
- ▶ Orange, if no mobile phone is connected.

If the hands-free module is connected to a headset, the

 (Headset) button will appear.

- 3 Speed call buttons (refer to "Preset" on page 110).
- 4 Back to the previously opened window. If you press this button, you will be returned to the navigation application.
- 5 Opens the **TRUSTED DEVICES** window. Here you can enter which devices are connected to the hands-free module. (Refer to "Connecting to a device" on page 100)
- 6 Moves the navigation application to the foreground.

The following labelled buttons are also visible:

Keyboard: Opens the keypad on which you can dial phone numbers. (Refer to "Dialling a telephone number" on page 106.)

Phone Book: Opens the phone book of the active telephone. (Refer to "Calling a contact from the phone book" on page 107 and "Navigating to a contact from the phone book" on page 109)

Recent Calls: Opens the recent calls of the active telephone. (Refer to "Calling most recently dialled, received or missed numbers" on page 107.)

Voice Command: Opens the **VOICE COMMAND** window in which you can initiate a call by voice commands. (Refer to "Making a call with the voice commands function" on page 105.)



Note: If there is no connection to a mobile phone or if the voice commands function is not available for the language of the user interface, the Settings button will be shown instead of the Voice Command button.

10.1 Connection with Mobile Phone

To be able to use the hands-free module of the navigation device, it must be connected to at least one Bluetooth device.



Note: Both the navigation device and the mobile phone must be configured accordingly in order for a Bluetooth connection to be set up between the two devices. Headsets are suitably configured at the factory.

For details of how to configure the navigation device refer to the chapter "Settings" on page 111.

For details of how to configure the mobile phone or headset refer to the related manual issued by the manufacturer.

10.1.1 Searching for and pairing Bluetooth devices

Pairing is the term used for setting up a coded connection between two Bluetooth devices. This requires each of the two devices to send the same password to respectively the other device. The password and the connection data are saved on both devices, which means that pairing is

necessary once only when the connection is set up for the first time. Paired devices are saved in the **TRUSTED DEVICES** list.

The navigation device can connect automatically to the last connected device as soon as it is within range.

The hands-free module of the navigation device can save and manage the connection data of up to 4 paired mobile phones and one headset. From each paired mobile phone it is possible to import the phone book and recent calls and to save this information with the connection data.



Note: In this case the phone book and recent calls are only available when the phone in question is connected. For details of how to import the phone book and recent calls refer to the chapters "Import Phone Book" on page 103 and "Import recent calls" on page 104.

Searching for devices

1. Make sure that the Bluetooth function is activated on both the mobile phone and the navigation device. If you want to set up a connection to a headset, the headset must be switched on. Additional information can be found in the manual issued for the headset.
2. In the **HANDSFREE MODULE** window tap on  (Trusted Devices). The **TRUSTED DEVICES** window opens.
3. Tap on Options > Search for Devices.
The navigation device starts the search for Bluetooth devices and lists all the devices it recognises in the **DISCOVERED DEVICES** window. The symbol to the left of the device name indicates whether the device is a mobile phone or a headset.

Pairing with a device

4. Tap in the **DISCOVERED DEVICES** window on the name of the device you want to connect to.
 - ▶ If pairings already exist with 4 mobile phones or a headset, you will now be prompted to delete a device from the **TRUSTED DEVICES** list. (Refer to "Deleting a device" on page 102.)
5. The navigation device prompts you to enter a password.
 - ▶ If you are setting up a connection to a mobile phone, enter a password (1-16 digits) in the Key box and tap on (OK). Then enter the same password on the mobile phone.
 - ▶ If you are setting up a connection to a headset, enter the headset password. This password and additional information about pairing can be found in the manual issued for the headset.

The pairing is performed and a connection is set up between the two devices. The connected device is indicated in the **TRUSTED DEVICES** list. (Green symbol)

10.1.2 Pairing from the mobile phone



Note: Please consult the mobile phone's manual if you are uncertain about how to carry out the following steps on the mobile phone.

1. Make sure that the Bluetooth function is activated on both the mobile phone and the navigation device. To perform the pairing from the mobile phone, the functions Discoverable by Others and Others May Connect must also be activated on the navigation device.

(Refer to "Configuring the hands-free function" on page 110.)

2. Using your mobile phone, search for other Bluetooth devices.
The navigation device is detected as **NAVIGON**.
3. Initiate a connection to the detected **NAVIGON** device.
The mobile phone prompts you to enter a password.
4. Enter a password (1-16 digits).
The navigation device prompts you to enter a password.
5. Enter the same password in the Key box as on the mobile phone and tap on (OK).

The pairing is performed and a connection is set up between the two devices. The connected device is indicated in the **TRUSTED DEVICES** list.

- ▶ If the new device is a headset, the symbol will appear to the right of its name in green colour. The connection to any mobile phones will be disconnected if applicable.
- ▶ If the new device is a mobile phone, one of the two symbols will appear to the right of its name in green colour depending on whether it is connected as Phone 1 or as Phone 2.

10.1.3 Connecting to a device

In this case "connection" refers to any subsequent connections between Bluetooth devices which have already been paired. No further password entry is necessary when connecting.

1. Make sure that Bluetooth is activated on your navigation device.
- ▶ If you want to connect to a mobile phone, make sure that Bluetooth is activated on the mobile phone and that the Discoverable by Others and Others May Connect settings are activated.







Note: The exact designation of these settings may vary from manufacturer to manufacturer. For more details refer to your mobile phone manual.

- ▶ If you want to connect to a headset, make sure that the headset is switched on.

Connecting manually

If a Bluetooth connection to a device is active, you must disconnect this connection first before you can connect to a different device. The existing connection is disconnected automatically as soon as the connection to a different device is initiated.

2. In the **HANDSFREE MODULE** window tap on  (**Trusted Devices**).
The **TRUSTED DEVICES** window opens. Currently connected devices are marked with a green symbol to the right of their name. Devices which are not connected have orange symbols.
3. Please ensure that the Bluetooth connection is working properly:
 - ▶ Tap on the  (**Connect**) symbol in order to initiate a connection to the corresponding headset. All active connections to other devices will then be disconnected.
 - ▶ Tap on the  (**Connect**) symbol in order to connect the corresponding mobile phone as "Phone 1". The connection to a headset or to a device which is already connected as "Phone 1" will be disconnected.
 - ▶ Tap on the  (**Connect**) symbol in order to connect the corresponding mobile phone as "Phone 2". The connection to a headset or to a device which is already connected as "Phone 2" will be disconnected.

The corresponding symbol will turn green. The navigation device connects to the selected device.

4. Tap on  (**Back**) in order to return to the **HANDSFREE MODULE** window.

If the telephone to which you want to connect the hands-free module is not in the list, you can start a search for Bluetooth devices. (Refer to "Searching for and pairing Bluetooth devices" on page 98.)

Connecting automatically



Note: For automatic connection to be possible, the navigation device must be saved in the Bluetooth settings on your mobile phone as "authorised" or "authorised device" (the exact wording can vary from manufacturer to manufacturer). For details please refer to the manual issued for your mobile phone.

If the device you want to connect to was either of the two last connected devices and the Reconnect Automatically setting is activated, the connection will be set up automatically as soon as the device is within range.



10.1.4 Activating a mobile phone

If the hands-free module is connected to two mobile phones, you can select in the **HANDSFREE MODULE** window which is to be the active telephone.

If you want to call someone, the call will be made via the active phone. Incoming calls and text messages on the inactive telephone will be announced however and can be taken.

Recent calls and the phone book of the inactive telephone are not available.

You can activate only one connected telephone.

- ▶ Tap on the  (Phone 1) or  (Phone 2) button to activate the corresponding mobile phone.

The button of the active phone has a "pressed" look. The name of the active phone is shown to the right of the buttons.

If no mobile phone is connected yet as "Phone 1" or as "Phone 2", the symbol on the corresponding button will appear in orange. If you tap on the symbol, the **TRUSTED DEVICES** window will open. There you can connect a mobile phone to the hands-free module. (Refer to "Connecting to a device" on page 100.)

10.1.5 Deleting a device

You can delete the connection data of paired devices. The device is then no longer shown in the **TRUSTED DEVICES** list. If you imported the phone book or recent calls from this device, these data will be deleted from the navigation device.

1. In the **HANDSFREE MODULE** window tap on  (Trusted Devices).
The **TRUSTED DEVICES** window opens.
2. Tap on Options > Delete Device.
The **DELETE DEVICE** window opens.

3. Tap on the  (Delete Device) button to the right of the device you want to delete.
You will be requested to confirm deletion.
4. Tap on Delete.
The device is deleted from the **TRUSTED DEVICES** list.

10.1.6 Import Phone Book

For each paired mobile phone in the **TRUSTED DEVICES** list it is also possible to import its phone book and save it together with the connection data. Access to the phone book of a mobile phone is then only possible when the navigation device is connected to the mobile phone from which the phone book was imported. As soon as you connect to a different phone or disconnect the connection, the phone book will no longer be available on the hands-free module.

1. In the **HANDSFREE MODULE** window activate the mobile phone whose phone book you want to import. (Refer to "Activating a mobile phone" on page 102.)
2. Tap in the **HANDSFREE MODULE** window on the Phone Book button.
The phone book import is started. Depending on the size of the phone book this can take some time. When the import is completed, the phone book is opened.



Note: The number of phone book entries that can be imported from the mobile phone is limited to 1000.



Note: It can take some time to import a phone book depending on its size. During the import you can move the Bluetooth application into the background in order e.g. to show the map during navigation. Tap in the window opened during the import on the To background button in order to move the navigation application into the foreground.

Editing and updating a phone book

The phone book cannot be edited in the hands-free module. If you want to change or delete an entry in the phone book, you must make the changes on your mobile phone and then update the phone book on the hands-free module. The phone book is re-imported for the update.

1. In the **HANDSFREE MODULE** window activate the mobile phone whose phone book you want to update. (Refer to "Activating a mobile phone" on page 102.)
2. Tap in the **HANDSFREE MODULE** window on the Phone Book button.
The phone book of the active phone is opened.
3. Tap on Options > Refresh.

The phone book import is started.



Note: Deleting the complete phone book is possible only by deleting the mobile phone from the **TRUSTED DEVICES** list (refer to "Deleting a device" on page 102). In this case the connection data, phone book and recent calls will all be deleted, which means that you will have to repeat the pairing routine in order to set up a connection with the device again.



For more details about the phone book refer to the chapter "Calling a contact from the phone book" on page 107.

10.1.7 Import recent calls

For each paired mobile phone in the **TRUSTED DEVICES** list it is also possible to import its recent calls and save them together with the connection data. Access to the recent calls of a mobile phone is then only possible when the navigation device is connected to the mobile phone from which the phone book was imported. As soon as you connect to a different phone or disconnect the connection, the recent calls will no longer be available on the hands-free module.



Note: The number of recent calls that can be imported from the mobile phone is limited to 20.

1. In the **HANDSFREE MODULE** window activate the mobile phone whose recent calls you want to import. (Refer to "Activating a mobile phone" on page 102.)
2. Tap in the **HANDSFREE MODULE** window on the Recent Calls button. The recent calls import is started. When the import is completed, the recent calls are shown.

10.2 Taking a call

When you receive a call, a ring tone will sound and the **INCOMING CALL** window will open. The header line shows which connected phone is receiving the call.

The name and the number of the caller will be displayed if this information is available. (If the caller's number is displayed but does not exist in the phone book, **Unknown caller** will be displayed instead of the name. If the number is suppressed, **Phone number hidden** will be displayed.)

- ▶ Tap on Accept if you want to take the call. The **CALL IN PROGRESS** window opens.
- ▶ Tap on Reject if you do not want to take the call.



Note: Navigation instructions are muted during a call.

10.3 Receiving a text message

The hands-free module can show incoming text messages (SMS).

When you receive a text message, a signal tone will sound and the **INCOMING TEXT MESSAGE** window will open. The header line shows which connected telephone received the text message.

The name and the number of the sender will be displayed if this information is available. (If the sender's number is displayed but does not exist in the phone book, **Unknown caller** will be displayed instead of the name. If the number is suppressed, **Phone number hidden** will be displayed.)

- ▶ Tap on Read if you want to read the text message now.
The **TEXT MESSAGE** window opens. You can then read the text message.



Note: The navigation system will also read out the text to you when the window is opened. Reading out text messages is not possible in all languages however.

- ▶ Tap on Cancel if you want to read the message later.



Note: You can also choose not to have incoming text messages announced immediately. (Refer to "Settings" on page 111.)

You can however open the list of received text messages at any time to check whether you have received any new text messages. (Refer to "Opening the mailbox" on page 110.)

10.4 Making a call

With the hands-free module you can make a call in various ways:

10.4.1 Making a call with the voice commands function

It is particularly convenient to make a call with the voice commands function.

1. In the **HANDSFREE MODULE** window activate the mobile phone which you want to use to make the call. (Refer to "Activating a mobile phone" on page 102.)
2. In the **HANDSFREE MODULE** window tap on Voice Command.

-or-

In the **NAVIGATION** window, in the map and if applicable in the **HANDSFREE MODULE** window move your hand briefly near to the

screen of the navigation device. As soon as you take your hand away from the screen again you will hear a single acknowledgement tone.

- ▶ Then say "Call".

The **VOICE COMMAND** window opens.

Specifying a phone number

3. Say "Telephone Number".

Say the number that you want to call.



Note: You have to say each number separately but you can say the numbers in blocks. For example, say "nine-four-three-three" for the number block 9433.

4. Wait for the numbers you said to appear.

Repeat steps 3 to 4 until the complete phone number is shown on the display. Say "Correction" if the last number you said was not understood correctly.

5. Say "Call".

The phone number will be dialled.

Calling a contact from the phone book

3. Say "Phone Book".

4. Say the name of the contact you want to call.

If several entries are recognised as matching this name, a list with these entries will appear.

- ▶ Say the number in front of the contact that you want to call.

If several phone numbers are saved for this contact, a list with these numbers will appear.

- ▶ Say the number in front of the phone number that you want to call.

The connection will be established.



Note: The **Voice Command** function is not available for every language. If it is not available, the **HANDSFREE MODULE** window will not show the Voice Command button but the Settings buttons.

10.4.2 Dialling a telephone number

1. In the **HANDSFREE MODULE** window activate the mobile phone which you want to use to make the call. (Refer to "Activating a mobile phone" on page 102.)

2. Tap in the **HANDSFREE MODULE** window on the Keyboard button.

The **TELEPHONE NUMBER** window opens.

3. Enter the desired telephone number.
4. Tap on the Call button.

10.4.3 Dialling a Speed Call number

A total of 4 speed call buttons are available. These buttons can be configured separately for each paired mobile phone.

1. In the **HANDSFREE MODULE** window activate the mobile phone which you want to use to make the call. (Refer to "Activating a mobile phone" on page 102.)
2. Tap in the **HANDSFREE MODULE** window on the corresponding Speed Call button.



Note: If the selected speed call button has not been configured yet, it will be labelled with just three dots (...). If you tap on the symbol, the **MODIFY PRESET** window will open. (Refer to "Preset" on page 110.)

10.4.4 Calling a contact from the phone book

You can select numbers from the phone book of the active telephone.

1. In the **HANDSFREE MODULE** window activate the mobile phone which you want to use to make the call. (Refer to "Activating a mobile phone" on page 102.)
2. In the **HANDSFREE MODULE** window tap on Phone Book.
 - ▶ If the phone book of the active phone was not yet imported, the import will be started now. (Refer to "Import Phone Book" on page 103.)
3. Select from the phone book the contact you want to call.

The **SELECTED PHONE BOOK ENTRY** window opens. It shows all the phone numbers and addresses which have been saved for the selected contact.

4. Tap on the  (Call) button alongside the phone number you want to dial.

10.4.5 Calling most recently dialled, received or missed numbers

The **RECENT CALLS** list contains outgoing, received and unanswered calls on the active telephone.



Note: Incoming and unanswered calls can be dialled only if the caller's number was transmitted.

1. In the **HANDSFREE MODULE** window tap on Recent Calls.

- ▶ If the recent calls on the active phone were not yet imported, the import will be started now; refer to "Import recent calls" on page 104.

The **RECENT CALLS** list opens. The entries are sorted chronologically; the symbols to the right of the entry indicate the type of call:



(Missed calls) (orange)



(Incoming calls) (white)



(Outgoing calls)

2. Tap on the entry you want.



Note: The **RECENT CALLS** list is available to the hands-free module only for as long as the hands-free module is connected to the mobile phone. It is updated automatically each time it is opened.

10.4.6 Transferring a call from your mobile telephone

The navigation device takes calls automatically from the mobile phone as soon as a Bluetooth connection is established between the two devices.

10.5 During a call

You are calling using the hands-free module. The **CALL IN PROGRESS** window is open.

10.5.1 Moving the navigation application to the foreground

You can move the navigation application to the foreground at any time. In this way you can have the map with the navigation instructions in the foreground during a call when the navigation device is in the process of navigating.

- ▶ Tap on  (Navigation).

While a call is in progress, the  (Call in Progress) symbol is visible in the top right corner of the display. The number indicates which of the connected phones is being used to make the call (here: "Phone 1").

- ▶ Tap on  (Phone) in order to open the **CALL IN PROGRESS** window.



10.5.2 Entering numbers

You can enter numbers during a call. This may be the case, for example, if a further connection via a telephone system is necessary.

1. Tap on Keyboard.
2. Enter the desired numbers.
3. Tap on  (Back) in order to open the **CALL IN PROGRESS** window.

10.5.3 Muting the microphone

During the call, you can mute the microphone so that you can talk to someone without the interlocutor hearing.

- ▶ In the **CALL IN PROGRESS** window, tap on  (Muting) to switch off the microphone.
The person on the other end of the line can no longer hear you. The modified symbol on the button indicates this.
- ▶ Tap on  (Muting) to switch the microphone on again.

10.5.4 Transferring a call to the mobile phone

- ▶ In the **CALL IN PROGRESS** window, tap on Options > Use Mobile Phone.
You can now continue the call from your mobile phone.

10.5.5 Ending the call

- ▶ Tap in the **CALL IN PROGRESS** window on the Hang up button in order to end the call.

10.6 Useful functions

10.6.1 Navigating to a contact from the phone book

You can also use the address of a contact in the phone book of the active telephone as a destination for the navigation system.

1. In the **HANDSFREE MODULE** window tap on Phone Book.
2. Select from the phone book the contact you want to navigate to.
The **SELECTED PHONE BOOK ENTRY** window opens. It shows up to two addresses and up to four phone numbers which have been saved for the selected contact.
3. Tap on Start Navigation.
If more than one address is available for the selected contact, all the addresses will be shown.

- ▶ Tap on the address to which you want to navigate.



You can also select addresses from the phone book in the navigation software to act as destinations. For more details refer to the chapter "Imported Addresses from the phone book" on page 42.

10.6.2 Opening the mailbox

You can read text messages from the mailbox of the active telephone.



Note: The number of SMS that can be imported from the mobile phone is limited to 15.

1. In the **HANDSFREE MODULE** window, tap on Options > SMS inbox.
The **SMS INBOX** list opens. The entries are sorted in chronological order. The symbol to the right of each entry indicates whether the text message has been opened at least once:



(Unopened text message)



(Opened text message)

2. Tap on the entry you want.



Note: The **SMS INBOX** list is available to the hands-free module only for as long as the hands-free module is connected to the mobile phone. It is updated automatically each time it is opened.

10.7 Configuring the hands-free function

The hands-free module contains a number of settings that can be individually configured.

10.7.1 Preset

The hands-free module of the navigation device contains four Speed Call buttons that can be individually configured.

1. In the **HANDSFREE MODULE** window, tap on Options > Modify Preset.
The **PRESET** window opens.
2. Tap on the  (Edit) button to the right of the Speed Call you want to define.
The **MODIFY PRESET** window opens.

Entering a new Speed Call number or editing an existing Speed Call number

3. Tap on the  (Edit) button.
4. Enter the name and the number for the selected Speed Call button or edit the existing name and number.
5. Tap on OK.

Adopting a number from the phone book of the mobile phone

3. Tap on the  (From the phone book) button. This button is deactivated when there is no connection to a mobile phone.
4. Select the contact which you want to adopt for the Speed Call. The **SELECT PHONE NUMBER** window opens. It shows all the phone numbers saved for the selected contact.
5. Tap on the phone number you want to use for the Speed Call.

Deleting a Speed Call number

3. Tap on the  (Delete) button.
4. Confirm that you want to delete the Speed Call number. The **PRESET** window opens again. No phone numbers and no name exist any longer for the selected Speed Call button.

10.7.2 Settings

In the **SETTINGS** window you can configure the settings for the phone functions of the hands-free module.

- ▶ In the **HANDSFREE MODULE** window, tap on Options > Settings. The **SETTINGS** window opens.

Volume of the Phone Call: The volume of the phone call can be controlled independently of the volume of the navigation application.

Volume of the Ring Tone: The volume of the ring tone can be controlled independently of the volume of the navigation application.

Info about new text messages: Select whether you want incoming text messages to be announced (Yes or No).

Bluetooth Function: Select whether you want to activate the Bluetooth function (Yes or No).

The hands-free module cannot connect to a mobile phone or headset if the Bluetooth function is deactivated.

Others May Connect: Select whether other devices should be able to initiate a connection (Yes or No).

Discoverable by Others: Select whether other Bluetooth-capable devices (in particular mobile phones) should be able to detect the navigation device (Yes or No).

Reconnect Automatically: Select whether the connection to the last connected phone is to be restored automatically (Yes or No) as soon it comes within range again.

Sort phone book by: Select the column to be used for sorting the phone book (First Names or Last Names). This setting applies only to the phone book display in the navigation device.



For information about configuring the settings in this window refer to "Configuring the navigation system" on page 122.



Note: In order for the last connection to be restored without further questioning, the navigation device must be saved in your mobile phone as "authorised" or "authorised device" (the exact wording can vary from manufacturer to manufacturer).



Note: The Discoverable by Others and Others May Connect settings are effective only when the Bluetooth function is activated.

A Bluetooth connection can be initiated from the mobile phone only when Yes is selected for both settings.

11 Navigon Live

With the **NAVIGON Live** module you can access up-to-date online services of **NAVIGON Live Services** at any time:

- ▶ **Weather Live:** You are informed about the current weather situation for every point of the road network on the navigation maps available. A weather forecast for the next few days is also provided.
- ▶ **CleverParking Live:** If for example you want to navigate to a car park, you can find out before starting the navigation whether there are any free parking spaces still there. You are also provided with a forecast as to whether the car park is likely to get fuller or emptier at the present time.

The information you receive depends on the information which the car park operator makes available.

- ▶ **Fuel Live:** If you need petrol, you will be shown a list of petrol stations nearby. You can read how much the grade of petrol used by you vehicle costs at the particular petrol station and whether it is a relatively expensive or inexpensive petrol station.

Whether prices are available and how up to date the information is depends on the petrol station operator.

- ▶ **Events Live:** If you want to go to a concert, a trade fair or some other event, here you will find not only the address of the venue but also information about the event itself. You can phone the venue in order to book tickets and you can navigate there of course.
Whether an event is listed and which information is available depends on the organiser or the venue operator.
- ▶ **Google Local Search:** If you are searching for a particular category of destination, e.g. a Thai restaurant, you can use Google Local Search. You then have access to the recommendations and ratings of millions of people world-wide.
- ▶ **Traffic Live:** You can now receive traffic information from the **NAVIGON Live** server. One of the server's functions is to evaluate anonymously collected floating car data from the many users of **NAVIGON Live** services. As the result, traffic jams can be detected and avoided more quickly and more reliably. The evaluation of floating car data also helps to calculate the estimated time of arrival more exactly.

The data connection is set up by mobile radio. The SIM card needed for this is inserted in the navigation device (refer to "SIM card" on page 12). It can be used only for the **NAVIGON Live** services and is blocked for all other services (telephone, SMS, MMS etc.).

11.1.1 Costs

Use of the **NAVIGON Live** services is free for a certain period from the day of initial activation. No mobile radio charges or data traffic charges are incurred. After this period you can continue to use the services by extending the subscription. For details go to our website www.navigon.com/live.

No additional charges arise for using the **NAVIGON Live** services in European countries other than your home country. Please note however that e.g. information about parking space, prices and availability does not exist in every country on a nation-wide basis.



For more details about the availability and scope of the **NAVIGON Live** services in various countries and about subscriptions go to www.navigon.com/live.

11.2 Using the NAVIGON Live services

The **NAVIGON Live** services are seamlessly integrated in the navigation software. Many services are used automatically without any change to the operation of the navigation device compared to the version without **NAVIGON Live** services. For example, there is no change to the program flow when a traffic jam is reported. The only change is that the traffic information from the **NAVIGON Live** services is more up to date and more precise than the traffic information from the radio stations.

11.2.1 Weather Service

The **Weather Live** service provides up-to-date weather data for every point of the road network on the navigation maps available. A weather forecast for the next few days is also available.

Weather data for your current position

This function is interesting above all when you want a weather forecast for the next few days.

- ▶ in the **NAVIGATION** window tap on  (**NAVIGON Live**) > Weather Service.

The **WEATHER SERVICE** window opens. You are shown a map view containing your position. Alongside are the current weather data and a forecast for the next two days.

Weather data for your destination

You can call up weather data for your destination at any time during navigation.

- ▶ Tap on Options > Services > Weather Service.

The **WEATHER SERVICE** window opens. You are shown a map view containing the destination selected for the navigation. Alongside are the current weather data and a forecast for the next two days.



Note: If you have planned a multi-leg route, the weather data for the ultimate destination will be shown and not the data for the next intermediate destination.

Weather data for a different location

You can call up weather data for every point on the map which can be entered as a destination for the navigation system.

Except for [Take Me Home](#) and [Show Map > Destination search](#) you can use any possible type of entry, e.g. [Enter an Address](#), [Last Destinations](#) or [Search for POI](#).

If you enter an address, it suffices to enter the town. However, you may also enter the street and the house number.



Information about entering navigation destinations can be found in chapter "Specifying a destination" on page 31.

1. Enter the town for which you want to receive weather data in the same way as you enter destinations for the navigation system. Do not tap on [\(Start Navigation\)](#)!
 - ▶ If navigation is in progress, then tap on [Options > Destination > Add interim destination](#) and then enter the town for which you want receive weather data. Do not tap on [\(Start Navigation\)](#)!
2. Tap on [Options > Weather Service](#).

The **WEATHER SERVICE** window opens. You are shown a map view containing the town you entered. Alongside are the current weather data and a forecast for the next two days.

11.2.2 Parking

The **CleverParking Live** service provides details about numerous parking options. These details cover e.g. prices, opening times, number of free parking spaces, trends in available capacity, availability of parking spaces for women, availability of parking spaces for the handicapped, type of payment, type of monitoring, ...



Note: The **CleverParking Live** service can only provide the information which is made available by the car park operator. This is not always the case where information about available capacity and prices is concerned.

1. In the **NAVIGATION** window tap on  (**NAVIGON Live**) > [Parking](#) if you are looking for a car park near your current position.
 - or-
 - ▶ Use one of the methods described in this manual to search for a car park near your destination.

A list opens. You are shown possible car parks in order of distance from your destination.

For some of the parking options you are shown online information such as e.g. the number of currently free parking spaces, the currently valid price or the trend in available capacity.

Some parking options are marked by a small asterisk (e.g. ). There is more information available for these parking options, e.g. opening times or the number of parking spaces for women or the number of parking spaces for the handicapped.

2. Select a parking option.

The **DESTINATION INFO** window opens. It contains address data and any other information which may be available.

3. Tap on Start Navigation in order to navigate to the selected parking option.

11.2.3 Fuel

The **Fuel Live** service looks for petrol stations near your current position and informs you about the prices for the grade of petrol you have selected in the settings.

Note: GPS reception must be good enough for determining your

position. Check the  (GPS Ready) symbol to see whether GPS reception is good enough.



If GPS reception is not good enough, the system will look for petrol stations near the last known position. If there is no last known position, the **Fuel** function will not be available.

For more details refer to the chapter "Initialising the GPS receiver" on page 30.

Note: The **Fuel Live** service can only provide the information which is made available by the petrol station operator. This is not always the case in particular where opening hours are concerned. Similarly, information about prices may not be up to date or may not be available at all.



For details of how to set the grade of petrol you want shown refer to "Configuring the NAVIGON Live services" on page 121.

1. Tap in the **NAVIGATION** window on  (**NAVIGON Live**) > **Fuel** if you are looking for a petrol station near your current position.

A list opens. It contains all the petrol stations near your current position whose operators have provided no online information. Similarly it contains the petrol stations near your current position whose operators have provided online information and sell the grade of petrol you have selected in the settings.

If online information is available you will see

- ▶ the price of the grade of petrol which you have selected in the settings. If the price information is too old it will not be shown.
 - ▶ a coloured symbol indicating whether this petrol station is relatively inexpensive or not (green, yellow, red).
 - ▶ the time when the price information was last updated.
2. Select a petrol station.
The **DESTINATION INFO** window opens. It contains address data and any other information which may be available.
 3. Tap on Start Navigation in order to navigate to the selected petrol station.

11.2.4 Google Local Search



When you search for POIs, the **Google Local Search** service provides you with the same results as when searching with Google Maps.

For many POIs in the hit list there are assessments which were written by Google Maps users and rankings which range from 1 star to 5 stars.

The average ranking is always shown. No star means that no rating was given yet.



Note: Google allows the use of the **Google Local Search** service only if you observe its conditions of use which can be viewed at www.google.com/accounts/TOS.

1. in the **NAVIGATION** window tap on  (NAVIGON Live) > Google Local Search.
-or-
In the **NAVIGATION** window tap on New Destination > Search for POI > Google Local Search.
The **GOOGLE LOCAL SEARCH** window opens.
2. Enter the name of the destination town.
You don't need to enter anything if you are looking for a POI near your current position.
If the destination is abroad you can also enter the name of the country, e.g. "Paris France".
Please note that every entry is possible. If you make a mistake, you might not receive the results you expected.
- ▶ Tap on  (Open List) in order to be able to select from the last 30 town entries.
3. Tap on  (OK).

4. Enter a search term.



You have an absolutely free choice of search term, but the number of hits depends greatly on you entering a suitable search term.

- ▶ Tap on  (Open List) in order to be able to select from the last 30 entered search terms.

5. Tap on  (OK).

The **RESULTS** list opens. It contains the POIs which were found. Shown alongside each POI is the average rating (1 star to 5 stars). No star means that no rating was given yet.

6. Tap on the name of the destination to which you want to navigate.
The **DESTINATION INFO** window opens. It contains the average rating, the telephone number and the address data for the selected destination.

- ▶ Tap on  (Info) if you want to read the assessments for this destination or want to see the destination on the map.
- ▶ Tap on  (Parking) if you want to navigate to a car park near the destination.
- ▶ Tap on  (Call) in order to dial the number indicated.



Note: The Call function is only available when the navigation device is connected via Bluetooth to a mobile phone.

Whether and how a Bluetooth connection can be established is described in chapter "Connection with Mobile Phone" on page 98.

7. Tap on Start Navigation.

-or-

Tap on Parking in order to search for and navigate to a car park near your destination.

The map opens in **Preview** mode. The destination is indicated on the map.



For detailed information on how to start navigation, please refer to chapter "Route preview" on page 44.

11.2.5 Events

When searching for events the **Events Live** service provides not only information about the venue (such as the address, phone number, ...) but also details of the event itself.



Note: Whether an event is listed and which information is available depends on the organiser or the venue operator.

You can search for events near your current position but also for events in a specific location.





Events Nearby

Note: GPS reception must be good enough for determining your position. Check the  (GPS Ready) symbol to see whether GPS reception is good enough.



If GPS reception is not good enough, the system will look for events near the last known position. If there is no last known position, the **Events Nearby** function will not be available.

For more details refer to the chapter "Initialising the GPS receiver" on page 30.

1. in the **NAVIGATION** window tap on  (**NAVIGON Live**) > **Events Nearby**.
The **EVENTS NEARBY** window opens.
2. Select a category from which you would like to find events. Categories in which no events are available nearby will not be available for selection.
If sub-categories exist for the category you have selected, the **Sub Category** list opens.
3. Select a sub-category from which you would like to find events.
The **Destination** list opens. It contains events of the selected category, sorted by distance from the venue.
4. Tap on the name of the event in which you are interested.
The **DESTINATION INFO** window opens. In addition to the name of the event it contains the phone number and the address of the venue.
 - ▶ Tap on  (**Info**) if you want to read details of the event or want to see the venue on the map.
 - ▶ Tap on  (**Parking**) if you want to navigate to a car park near the destination.
 - ▶ Tap on  (**Call**) in order to dial the number indicated.



Note: The Call function is only available when the navigation device is connected via Bluetooth to a mobile phone.

Whether and how a Bluetooth connection can be established is described in chapter "Connection with Mobile Phone" on page 98.





5. Tap on Start Navigation.

The map opens in **Preview** mode. The destination is indicated on the map.



For information on how to start navigation, please refer to chapter "Route preview" on page 44. Please read on there.

Events in a City

1. in the **NAVIGATION** window tap on  (NAVIGON Live) > Events in a City.
The **EVENTS IN A CITY** window opens.
2. Enter the name or the postal code of the destination town.
3. Select a category from which you would like to find events.
Categories in which no events are available in the specified location will not be available for selection.
If sub-categories exist for the category you have selected, the Sub Category list opens.
4. Select a sub-category from which you would like to find events.
The Destination list opens. It contains events of the selected category, sorted by distance from the venue.
5. Tap on the name of the event in which you are interested.
The **DESTINATION INFO** window opens. In addition to the name of the event it contains the phone number and the address of the venue.
 - ▶ Tap on  (Info) if you want to read details of the event or want to see the venue on the map.
 - ▶ Tap on  (Parking) if you want to navigate to a car park near the destination.
 - ▶ Tap on  (Call) in order to dial the number indicated.



Note: The Call function is only available when the navigation device is connected via Bluetooth to a mobile phone.

Whether and how a Bluetooth connection can be established is described in chapter "Connection with Mobile Phone" on page 98.

6. Tap on [Start Navigation](#).

The map opens in **Preview** mode. The destination is indicated on the map.



For information on how to start navigation, please refer to chapter "Route preview" on page 44. Please read on there.

11.2.6 Traffic Information

The **Traffic Live** service also analyses anonymously collected floating car data from the many users of the service. This offers for example the following advantages:

- ▶ Obstructions which cause traffic congestion can be detected and avoided more quickly and more reliably.
- ▶ The end of a traffic obstruction is detected more quickly and more reliably. Unnecessary detours can be avoided.
- ▶ Estimated times of arrival can be calculated more precisely.

The **Traffic Live** service does not change the way you operate the navigation device; the only difference is the source of reference for the traffic information.



For details of the TMC function refer to chapter "TMC (Traffic Information)" on page 91.

11.3 Configuring the NAVIGON Live services

In the **SETTINGS** window you can configure the settings for the **NAVIGON Live** services.

- ▶ In the **NAVIGATION** window tap on  (**NAVIGON Live**) > [Options](#) > [Settings](#).
The **SETTINGS** window opens.

Use NAVIGON Live Services: Select whether you want the **NAVIGON Live** services to be available ([Yes](#) or [No](#)).

Source of traffic information: Select the traffic information source you want to use ([NAVIGON Live services](#) or [radio stations](#)). The **NAVIGON Live** services -also include floating car data from numerous vehicles in its analysis of the traffic situation. As the result they often provide more information and sooner.

Fuel type: Select the grade of petrol for your vehicle. The **Fuel Live** service will indicate prices only for the grade of petrol selected here.

Optimise Traffic Recognition: The navigation device sends anonymised floating car data to the **NAVIGON Live** server. The more users that provide floating car data anonymously, the better the system can identify traffic jams and the more reliably it can avoid them. Estimated times of arrival can also be calculated more precisely. Select whether you want to send floating car data (**Yes** or **No**). Floating car data cannot be traced back in any way to you personally.



Details of how to operate the **SETTINGS** window can be found in chapter "Configuring the navigation system" on page 122.

11.4 Indicating the status

All key data concerning your **NAVIGON Live** module and the validity of the subscription to the **NAVIGON Live** services can be found in the **NAVIGON LIVE STATUS** window.

- ▶ In the **NAVIGATION** window tap on  (**NAVIGON Live**) > Options > NAVIGON Live Status.

The **NAVIGON LIVE STATUS** window opens. It contains the following information:

- ▶ the date up to which the subscription to the **NAVIGON Live** services is valid or since which the subscription has expired,
- ▶ the number of the SIM card in the **NAVIGON Live** module,
- ▶ the activation code last entered on the navigation device.

12 Configuring the navigation system

The **SETTINGS** window is the starting point for customising the navigation system to match your personal preferences.

Settings can be accessed via the options in the **NAVIGATION** window and via the options in many windows of the navigation application.

- ▶ Tap on Options > Settings.

The **SETTINGS** window of the navigation application has several buttons: Current Route Profile., Navigation, Map Display and General.

- ▶ Tap on a button to open the corresponding settings window.



For details of how to select and configure a route profile refer to the chapter "Route profiles" on page 73.

The settings of the individual windows are distributed over several screen pages. You can use the





(To the Left) and



(To the Right) buttons to toggle between these pages.

Some settings can have only one of two values. These settings can be recognised by the  (Toggle) button. All possible values are visible. The currently valid value is highlighted (in white).

- ▶ Tap on  (Toggle) in order to switch between the possible values.

Some settings can adopt many different values. These settings can be recognised by the  (List) button. The current value is visible.

1. Tap on  (List).

A list with all possible values opens. The currently valid value is marked.

2. Tap on the value you want. It is now marked.
3. Tap on OK.

The list will close. The new value is indicated.

For each setting there is a  (Help) button. When you tap on it you will see an exact definition of the setting in question.

You can close the settings windows in two ways:

- ▶ Tap on OK.
Any changes you have made will be adopted.
- ▶ Tap on Cancel.
Any changes you have made will not be adopted.

13 Appendix

13.1 Technical data of the navigation device

Dimensions	137 x 83 x 15,3 mm NAVIGON 70 Premium Live: 137 x 83 x 15.9 mm	
Weight	NAVIGON 70 Plus: 190 g NAVIGON 70 Premium: 190 g NAVIGON 70 Premium Live: 203 g	
Operating conditions	Operating temperature	-10°C to 70°C (14°F to 158°F)
	Storage temperature	-30°C to 80°C (-22°F to 176°F)
	Humidity	0% to 90%, non-precipitating
CPU	STM Cartesio 2064 (520MHz)	
Operating system	Microsoft Windows CE	
Display	5" LCD colour display with resistive touch-panel, 300 cd/m ² , 300:1 480 x 272 pixel (WQVGA)	
Memory	RAM	NAVIGON 70 Plus: 64 MB NAVIGON 70 Premium: 128 MB NAVIGON 70 Premium Live: 128 MB
	Flash	4 GB
GPS	Yes (STM STA5630, ST-AGPS) Built-in antenna	
TMC	Yes	
Proximity sensor	Yes	
Device keys	1 (<i>On/Off</i>)	
I/O	Keyboard	Software keyboard
	Loudspeaker	Yes
	Memory card	microSD
	USB	1 x USB 2.0
	Bluetooth	(Only NAVIGON 70 Premium and NAVIGON 70 Premium Live) Integrated With echo suppression
Power supply	Via USB socket	
Rechargeable battery	Type	LilonPo / Lilon, 1400 mAh
Charging	Electronic	Integrated
Car charger cable	Input	10-24V = (direct voltage, DC)
	Output	5V/1,5A = (direct voltage, DC)

13.2 NAVIGON Licensing Policy

§ 1 Scope of Regulations

This Agreement regulates the relations between the user and NAVIGON AG, Schottmuellerstrasse 20 A, 20251 Hamburg, developer and proprietor of the exclusive utilisation rights to the NAVIGON software ("Software") as specified in the order. The subject matter of this Agreement is copyright interests.

§ 2 Extent of Use

- (1) NAVIGON grants the user the non-exclusive right, unlimited by time and location, to utilise the Software at a utilisation volume as specified in the order. The licensing includes the right to install and use the Software in accordance with the documentation and pursuant to these regulations.
- (2) NAVIGON expressly informs the user that complete utilisation of the Software is not possible until after proper registration.
- (3) The user must ensure that the above mentioned restricted utilisation rights are complied with.
- (4) Any kind of use which goes beyond the framework as stipulated in the Agreement requires the written consent of NAVIGON. In the event that such utilisation should be exploited without NAVIGON's consent, NAVIGON shall charge the amount accruing for this extended utilisation in accordance with the valid price list at the time. NAVIGON shall reserve the right to assert further reaching claims for compensation of damages. The user shall have the right to prove lower damages.
- (5) All the above mentioned utilisation rights shall only be transferred to the user after full and final payment of the license fee.

§ 3 Copyright and Protection Rights

- (1) The user acknowledges the copyrights of NAVIGON and therewith its exclusive utilisation and exploitation rights to the Software. Exclusive utilisation and exploitation rights also exist with regard to extended development of the Software or amendments thereto, which NAVIGON has created for the user compliant with the order.

- (2) Any kind of non explicitly authorised copying of the Software in its entirety or partially, any kind of non expressly authorised passing on of the Software and development of similar Software or segments of such Software or utilisation of the contractual Software as a master template shall in particular be deemed to be judicially and contractually prohibited.
- (3) The user acknowledges the imprint, trademark, trade name and patent rights of NAVIGON to the Software and the relevant appending documentation. The user is forbidden to remove, change or in any other way camouflage the copyright notices and identifications pertaining to existing protection rights.

§ 4 Passing on the Software

- (1) The user is permitted to sell or give away the Software and the user manual or any other accompanying materials on a permanent basis to third parties, under the proviso that the acquiring third party agrees that the contractual terms and conditions at hand shall henceforth also be imposed on it.
- (2) In the event of passing on the Software, the user shall hand over to the new user all copies of the program, including possible back-up copies made, or destroy the copies not handed over. As a result of passing on the Software, the former user's utilisation rights to the program shall extinguish.
- (3) The user is permitted to sell or give away the Software and the user manual or any other accompanying materials to third parties on a temporary basis, if this is not done within the framework of leasing or renting out for gainful purposes, under the proviso that the acquiring third party agrees that the contractual terms and conditions at hand shall henceforth also be imposed on it. For the period of assignment of the Software to third parties, the assigning user shall have no right to any kind of utilization of the program. For the period of assignment of the Software to third parties, the assigning user shall have no right to any kind of utilisation of the program. Renting out or granting a lease for gainful purposes shall be prohibited.
- (4) The user may not assign the Software to third parties if there should be any justified suspicion that such third party could violate the contractual terms and conditions, especially by making unlawful copies.

§ 5 Reproduction Rights and Access Security

- (1) The user may reproduce the Software if the respective copying should be necessary for operation. Necessary reproduction shall be deemed to be the installation of the program from the original data carrier to the bulk memory of the hardware used as well as loading of the program into random access memory.
- (2) Furthermore, the user is permitted to make copies for back-up purposes. However, fundamentally, only one single back-up copy may be made for safekeeping. The back-up copy has to be identified as such.
- (3) If regular copying of the complete database, including computer programs, is indispensable for reasons of data security or to ensure speedy reactivation of the computer system after a total crash, then the user is allowed to make back-up copies in the number specifically required. The data carriers used in this case must be marked accordingly. The back-up copies may only be used for purely archive-related purposes.
- (4) Further reproductions, which also include release of the program code on a printer as well as photocopying of the manual, may not be made by the user. Any additional manuals required by employees have to be obtained from NAVIGON.

§ 6 Multiple Deployment and Network Integration

- (1) The user may use the Software on any hardware available to it. However, in the event that the user should replace the hardware, it is obliged to delete the Software from the hardware utilised up till then. Any isochronous storage, keeping in stock or operation on more than only one hardware unit is not permissible.
- (2) The deployment of the entrusted Software within a network or any other multiple workstation computer system is not permissible if thereby the possibility of simultaneous multiple usage should be facilitated. Should the user select to use the Software within network operations or any other multiple workstation computer system, the user is obliged to abstain from simultaneous multiple use by integration of access protection devices or to compensate NAVIGON by payment of special network license fees to an amount calculated on the basis of the number of users linked up with the computer system. The user shall be informed immediately by NAVIGON with regard to network license fees to be raised in each individual case as soon as the user has informed NAVIGON in writing of the intended network integration and the number of integrated users. The implementation into such kind of network or multiple workstation computer system shall only be permissible after full and final payment of the network licensing fees.

§ 7 Third Party Software

The Software contains third party software products which have been integrated into the contractual Software or supplied together with the contractual Software. NAVIGON fundamentally only awards such rights which are necessary for general use of the programs as components of the contractual Software and which NAVIGON is authorised to grant. No modification rights or further processing rights are incorporated therein.

§ 8 Decompiling and Amendment of Programs

The user is forbidden to retranslate the entrusted program code into other code configurations (decompiling) as well as any other kind of inverted development of the diverse manufacturing phases of the Software (reverse engineering) or to carry out program amendments of any kind unless such actions should serve purposes of eliminating serious defects, especially such defects which can not be avoided by organisational or any other reasonable measure of remedy. Copyright markings, serial numbers as well as other characteristics serving purposes of identification of the program may not be eliminated or changed. Any removal of copy protection or similar protective routine measures is prohibited without the knowledge and co-operation of NAVIGON.

§ 9 Final Clauses

- (1) In the event that any provision contained in this License Policy should be determined to be invalid or become invalid, the effectiveness of the other regulations shall not be affected thereby. The said invalid provision shall be replaced by a valid provision within the context of the remaining contractual interpretation, which comes as close as possible to the intended economical purpose of such invalid provision.
- (2) Amendments and supplements to these regulations have to be in the written form and have to be expressly identified as such. Verbal ancillary agreements shall be deemed to be ineffective. This requirement of written form may only be renounced by written agreement.
- (3) If legally permissible, the Parties agree that the laws of the Federal Republic of Germany shall apply to all legal relations arising from these contractual relations, under exclusion of UN Purchase Law.

- (4) If the user should be a businessman within the meaning of the Commercial Code, legal entity under public law or special assets under public law, all disputes which may arise in connection with the accomplishment of these contractual regulations shall fall under the jurisdiction of Hamburg.

13.3 Declaration of Conformity

NAVIGON AG declares herewith that the devices described in the manual are in conformance with the basic requirements and other relevant provisions of EU Directive 1999/5/EC and the R&TTE Directive.

The declaration of conformity can be viewed on the Internet at www.navigon.com/ce-erklaerung.

14 Troubleshooting

In this chapter you will find solutions to problems which may arise during use of the navigation system.

This list does not claim to be complete. Answers to many other questions can be found on the NAVIGON website. (Refer to "Questions about the product" on page 9.)

I have connected a charger to the navigation device. A connection to a computer is shown on the screen.

-or-

I have connected the navigation device to a computer but it is not detected as a removable disc.

The USB connector of the charger is not fully inserted in the case.

-or-

The USB connector is not connected correctly.

1. Unplug the connector.

The navigation device will carry out a new start. Wait for the navigation software to be reloaded.

2. Insert the USB connector from the charger into the corresponding socket of the navigation device swiftly as far as it will go. (Refer to "Description of the navigation device" on page 10.)

My navigation device makes no response any longer, the screen is frozen.

Perform a reset.

- ▶ Use a thin object to press the **Reset** key. (Refer to "Description of the navigation device" on page 10.)

The software will be restarted. Your settings and your saved destinations and routes will be retained.

It seems to me that the battery of my navigation device becomes flat relatively quickly when the device is not connected to an external power supply.

Some settings can be configured so that energy consumption is minimised.

1. In the **NAVIGATION** window tap on Options > Settings > General.
2. Set the values for Brightness Day and Brightness Night as low as possible.
3. Tap on OK.
4. Tap on  (Back).

The **NAVIGATION** window is now open again.

I have accidentally activated demo mode.

If you have accidentally activated demo mode when you start the navigation application for the first time, you can deactivate it again as follows:

1. In the **NAVIGATION** window, tap on Options > Settings.

The **SETTINGS** window is opened.

2. Tap on Options > Stop Demo Mode.

You will be prompted to confirm that you want the device reset to the as-delivered state.

3. Tap on the Yes button.

The software is re-started and behaves as if started for the first time after being purchased (refer to "Switching on the navigation device" on page 17).

Start the navigation software and set the Start in Demo Mode setting to No. (Refer to "Starting the navigation application" on page 29.)

The proximity sensor is very late in responding to my hand. I have to nearly touch the screen of the navigation device.

The reaction radius of the proximity sensor may be reduced under the following conditions:

- ▶ The navigation device is not connected to an external power supply.
- ▶ You are using a charging cable that is not recommended by NAVIGON expressly for your navigation system.
- ▶ You are holding the navigation device in your hand.
- ▶ You are using a cradle which is not the original cradle.
- ▶ The navigation device is not mounted on the windscreen but in a different place.
- ▶ You are using an accessory that is not recommended by NAVIGON expressly for your navigation system.



For details of how to install the navigation system correctly refer to the chapter "Installing the navigation system in the vehicle" on page 13.

The proximity sensor responds not only when I want to operate the navigation system but also when I move the steering wheel or use the gear lever.

The steering wheel and/or the gear lever are within the reaction radius of the proximity sensor.

- ▶ Mount the cradle further away from the steering wheel and/or the gear lever.
- or-
- ▶ In the **NAVIGATION** window tap on Options > Settings > General > Reaction Radius and reduce the size of the radius within which the sensor responds to movements.

The proximity sensor responds not only to my hand but also to the windscreen wipers when they are running.

Try the following:

1. In the **NAVIGATION** window tap on Options > Settings > General > Reaction Speed.
2. Reduce the value of the response speed until the sensor no longer responds to the windscreen wipers.

If this fails to solve the problem, reduce the reaction radius as well:

- ▶ In the **NAVIGATION** window tap on Options > Settings > General > Reaction Radius and reduce the radius within which the sensor responds to movements.

If the problem is still not solved, you can deactivate the proximity sensor.

- ▶ In the **NAVIGATION** window tap on Options > Settings > General > Use Motion Sensor. Set the value to No.

I can't use the NAVIGON Live services even though the SIM card is inserted.

This can be due to the following:

- ▶ You are not connected to the mobile telephone network at the moment.
Perhaps you are in a location which is not covered by any network.

- ▶ The cover over the SIM card is not inserted correctly.
Refit the cover. Make sure that all corners are correctly inserted!
(Refer to "SIM card" on page 12)
- ▶ You are using a charger cable that is not recommended by NAVIGON expressly for your navigation system.
Use only the charger cable supplied with your navigation device or an equivalent model from NAVIGON! (Refer to "Supplying power to the navigation device" on page 14)
- ▶ The SIM card is damaged or invalid.



Note: Use only accessories that are recommended by NAVIGON expressly for your navigation system. NAVIGON AG accepts no liability for errors or damages resulting from the use of other accessories.

For suitable accessories go to www.navigon.com or your authorised dealer.

15 Index

A

Activate..... 16, 102

B

Block..... 89, 90

Bluetooth

 Activate 102

 Connect 100

 Pairing 98

Bluetooth see Handsfree Module

C

Call

 Dial Number 106

 Phone Book 107

 Preset 107

 Recent Calls 107

 Voice Command 105

Call in Progress

 Enter numerals 109

 Hang up 109

 Muting 109

 Show Map 108

 Use handsfree 108

 Use Mobile Phone 109

CleverParking Live

 Parking 115

Compass 20

Configuration

 NAVIGON Live..... 121

Configuration 122

Connect..... 100

Connection with Mobile Phone..... 98

Conventions followed in this

 manual..... 8

Costs 113

Current Position

 Save..... 89

D

Data entry..... 25

Destination

 Direct Access..... 39

 Enter Coordinates..... 34

 Events..... 118

 in a City 120

 Nearby..... 119

 Favourites 40

 From Map 43

 From the phone book 109

 Google Local Search 117

 Home Address 43, 47

 Imported Addresses

 From the phone book 42, 109

 Outlook / Internet..... 42

 Last Destinations 41

 My Destinations 31

 New Destination 31

 POI 36

 Direct Access 39

 in a City 38

 Nationwide 37

 Nearby..... 36

 Save 46

 Start Navigation 44

 Take Me Home 43, 47

 Turn-by-Turn List 45

 Voice Command 32

Direct Help 88

E

Energy..... 14, 21, 130

Enter Coordinates 34

Entering data..... 25

Events

 in a City..... 120

 Nearby 119

F

Favourites 40, 46

Fuel 116

Fuel Live..... 116

G

Google Local Search..... 117
 GPS
 Faulty reception 29
 Initialise 30
 Signals 17
 Symbols 20
 GPS Status..... 88

H

Handsfree Module
 Activate 102
 Call 105
 Call in Progress 108
 Connect 100
 Connection with Mobile Phone 98
 Delete Device 102
 Dial Number 106
 Enter numerals 109
 Hang up 109
 Import Phone Book 103
 Import recent calls 104
 Incoming Call 104
 Incoming text message..... 105
 Muting 109
 Open 97
 Pairing 98
 Phone Book 107
 Preset 107, 110
 Recent Calls 107
 Settings 110, 111
 Show Map 108
 SMS inbox 110
 Symbols 23
 Use handsfree 108
 Use Mobile Phone 109
 Voice Command 105
 Home Address
 Edit..... 48
 Home Address..... 43, 47
 Hotline 9

I

Imported Addresses
 From the phone book 42
 Outlook / Internet 42

K

Keyboard..... 24

L

Last Destinations 41, 46
 Logbook 24, 95

M

Manual
 Conventions..... 8
 Symbols 8
 Manual 19
 Map
 Destination search..... 71
 Offroad..... 70
 Pedestrian 68
 Preview 61
 Reality View 67
 Standard 60
 Track 69
 Vehicle 63
 Memory card 15
 Menu 26
 Motion Sensor 57, 59
 Muting 23
 My Destinations..... 31
 My POIs 76
 MyPOIs 76
 MyRoutes 45, 53

N

Navigation
 Block 89, 90
 MyRoutes 45, 53
 No GPS 45, 53

