

Roland

VC-30HD VIDEO CONVERTER

Owner's Manual

Before using this unit, carefully read the sections entitled: "USING THE UNIT SAFELY"(p. 4) and "IMPORTANT NOTES" (p. 7). These sections provide important information concerning the proper operation of the unit. Additionally, in order to feel assured that you have gained a good grasp of every feature provided by your new unit, owner's manual should be read in its entirety. The manual should be saved and kept on hand as a convenient reference.



Copyright © 2011 ROLAND CORPORATION

All rights reserved. No part of this publication may be reproduced in any form without the written permission of ROLAND CORPORATION.

- * Roland is either registered trademark or trademark of Roland Corporation in the United States and/or other countries.
- * All product names mentioned in this document are trademarks or registered trademarks of their respective owners.

For the U.K.

IMPORTANT: THE WIRES IN THIS MAINS LEAD ARE COLOURED IN ACCORDANCE WITH THE FOLLOWING CODE.

BLUE: NEUTRAL
BROWN: LIVE

As the colours of the wires in the mains lead of this apparatus may not correspond with the coloured markings identifying the terminals in your plug, proceed as follows:
The wire which is coloured BLUE must be connected to the terminal which is marked with the letter N or coloured BLACK.
The wire which is coloured BROWN must be connected to the terminal which is marked with the letter L or coloured RED.
Under no circumstances must either of the above wires be connected to the earth terminal of a three pin plug.

Check the Included Items

The following items are included. Please make sure that all items are present. If anything is missing, please contact your dealer.

The VC-30HD itself



AC adaptor and power cord



Rubber foot



- * The rubber feet are arranged onto one pad. Remove each one from the pad if you wish to install them.
- * Attach the included rubber feet as needed. Refer to "About the Rubber Foot" (p. 10).

Owner's Manual (this document)



MMP (Moore Microprocessor Portfolio) refers to a patent portfolio concerned with microprocessor architecture, which was developed by Technology Properties Limited (TPL). Roland has licensed this technology from the TPL Group.

USING THE UNIT SAFELY

INSTRUCTIONS FOR THE PREVENTION OF FIRE, ELECTRIC SHOCK, OR INJURY TO PERSONS

About ⚠ WARNING and ⚠ CAUTION Notices

⚠ WARNING	Used for instructions intended to alert the user to the risk of death or severe injury should the unit be used improperly.
⚠ CAUTION	Used for instructions intended to alert the user to the risk of injury or material damage should the unit be used improperly. * Material damage refers to damage or other adverse effects caused with respect to the home and all its furnishings, as well to domestic animals or pets.

About the Symbols

	The ⚠ symbol alerts the user to important instructions or warnings. The specific meaning of the symbol is determined by the design contained within the triangle. In the case of the symbol at left, it is used for
	The ⚡ symbol alerts the user to items that must never be carried out (are forbidden). The specific thing that must not be done is indicated by the design contained within the circle. In the case of the symbol at left, it means that the unit must never be disassembled.
	The ⚡ symbol alerts the user to things that must be carried out. The specific thing that must be done is indicated by the design contained within the circle. In the case of the symbol at left, it means that the power-cord plug must be unplugged from the outlet.

ALWAYS OBSERVE THE FOLLOWING

⚠ WARNING

- Do not open (or modify in any way) the unit or its AC adaptor.

- Do not attempt to repair the unit, or replace parts within it (except when this manual provides specific instructions directing you to do so). Refer all servicing to your retailer, the nearest Roland Service Center, or an authorized Roland distributor, as listed on the "Information" sheet.

- Never install the unit in any of the following locations.

 - Subject to temperature extremes (e.g., direct sunlight in an enclosed vehicle, near a heating duct, on top of heat-generating equipment); or are
 - Damp (e.g., baths, washrooms, on wet floors); or are
 - Exposed to steam or smoke; or are
 - Subject to salt exposure; or are
 - Humid; or are
 - Exposed to rain; or are
 - Dusty or sandy; or are
 - Subject to high levels of vibration and shakiness.

- Make sure you always have the unit placed so it is level and sure to remain stable. Never place it on stands that could wobble, or on inclined surfaces.

⚠ WARNING



- Be sure to use only the AC adaptor supplied with the unit. Also, make sure the line voltage at the installation matches the input voltage specified on the AC adaptor's body. Other AC adaptors may use a different polarity, or be designed for a different voltage, so their use could result in damage, malfunction, or electric shock.

- Use only the attached power-supply cord. Also, the supplied power cord must not be used with any other device.

- Do not excessively twist or bend the power cord, nor place heavy objects on it. Doing so can damage the cord, producing severed elements and short circuits. Damaged cords are fire and shock hazards!

- In combination with an amplifier and headphones or speakers, this unit may be capable of producing sound levels that could cause permanent hearing loss. Do not operate for a long period of time at a high volume level, or at a level that is uncomfortable. If you experience any hearing loss or ringing in the ears, you should immediately stop using the unit, and consult an audiologist.



WARNING

- Do not allow any objects (e.g., flammable material, coins, pins); or liquids of any kind (water, soft drinks, etc.) to penetrate the unit.
 

- Immediately turn the power off, remove the AC adaptor from the outlet, disconnect all the cables and request servicing by your retailer, the nearest Roland Service Center, or an authorized Roland distributor, as listed on the "Information" sheet when:
 
 - The AC adaptor, the power-supply cord, or the plug has been damaged; or
 - If smoke or unusual odor occurs
 - Objects have fallen into, or liquid has been spilled onto the unit; or
 - The unit has been exposed to rain (or otherwise has become wet); or
 - The unit does not appear to operate normally or exhibits a marked change in performance.

- In households with small children, an adult should provide supervision until the child is capable of following all the rules essential for the safe operation of the unit.
 

- Protect the unit from strong impact. (Do not drop it!)
 

- Do not force the unit's power-supply cord to share an outlet with an unreasonable number of other devices. Be especially careful when using extension cords—the total power used by all devices you have connected to the extension cord's outlet must never exceed the power rating (watts/amperes) for the extension cord. Excessive loads can cause the insulation on the cord to heat up and eventually melt through.
 

- Before using the unit in a foreign country, consult with your retailer, the nearest Roland Service Center, or an authorized Roland distributor, as listed on the "Information" sheet.
 

 **CAUTION**

- The unit and the AC adaptor should be located so their location or position does not interfere with their proper ventilation. 

- Always grasp only the plug on the AC adaptor cord when plugging into, or unplugging from, an outlet or this unit. 

- At regular intervals, you should unplug the AC adaptor and clean it by using a dry cloth to wipe all dust and other accumulations away from its prongs. Also, disconnect the power plug from the power outlet whenever the unit is to remain unused for an extended period of time. Any accumulation of dust between the power plug and the power outlet can result in poor insulation and lead to fire. 

- Try to prevent cords and cables from becoming entangled. Also, all cords and cables should be placed so they are out of the reach of children. 

- Never climb on top of, nor place heavy objects on the unit. 

- Never handle the AC adaptor or its plugs with wet hands when plugging into, or unplugging from, an outlet or this unit. 

- Before moving the unit, disconnect the AC adaptor and all cords coming from external devices. 

- Before cleaning the unit, turn off the power and unplug the AC adaptor from the outlet (p. 11) and disconnect all the cables. 

- Whenever you suspect the possibility of lightning in your area, disconnect the AC adaptor from the outlet. 

- To prevent accidental ingestion of the parts listed below, always keep them out of the reach of small children. 
 - Included Parts
Rubber Foot (p. 10)
 - Removable Parts
Ground Terminal Screw (p. 12)

 **CAUTION**

- If you remove the screw from the ground terminal, be sure to replace it; don't leave it lying around where it could accidentally be swallowed by small children. When refastening the screw, make that it is firmly fastened, so it won't come loose. 

- The top panel may become hot, so take care to avoid burns. 

IMPORTANT NOTES

Power Supply

- Do not connect this unit to same electrical outlet that is being used by an electrical appliance that is controlled by an inverter (such as a refrigerator, washing machine, microwave oven, or air conditioner), or that contains a motor. Depending on the way in which the electrical appliance is used, power supply noise may cause this unit to malfunction or may produce audible noise. If it is not practical to use a separate electrical outlet, connect a power supply noise filter between this unit and the electrical outlet.
- The AC adaptor will begin to generate heat after long hours of consecutive use. This is normal, and is not a cause for concern.
- Before connecting this unit to other devices, turn off the power to all units. This will help prevent malfunctions and/or damage to speakers or other devices.
- With the factory settings, the VC-30HD's power will automatically be switched off four hours after the unit stops receiving input signals. If you don't want the power to turn off automatically, change the "AUTO OFF" setting to "OFF" as described on p. 13.

Placement

- Using the unit near power amplifiers (or other equipment containing large power transformers) may induce hum. To alleviate the problem, change the orientation of this unit; or move it farther away from the source of interference.
- This device may interfere with radio and television reception. Do not use this device in the vicinity of such receivers.
- Noise may be produced if wireless communications devices, such as cell phones, are operated in the vicinity of this unit. Such noise could occur when receiving or initiating a call, or while conversing. Should you experience such problems, you should relocate such wireless devices so they are at a greater distance from this unit, or switch them off.
- Do not expose the unit to direct sunlight, place it near devices that radiate heat, leave it inside an enclosed vehicle, or otherwise subject it to temperature extremes. Excessive heat can deform or discolor the unit.
- When moved from one location to another where the temperature and/or humidity is very different, water droplets (condensation) may form inside the unit. Damage or malfunction may result if you attempt to use the unit in this condition. Therefore, before using the unit, you must allow it to stand for several hours, until the condensation has completely evaporated.
- Depending on the material and temperature of the surface on which you place the unit, its rubber feet may discolor or mar the surface. You can place a piece of felt or cloth under the rubber feet to prevent this from happening. If you do so, please make sure that the unit will not slip or move accidentally.
- Do not put anything that contains water on this unit. Also, avoid the use of insecticides, perfumes, alcohol, nail polish, spray cans, etc., near the unit. Swiftly wipe away any liquid that spills on the unit using a dry, soft cloth.

Maintenance

- For everyday cleaning wipe the unit with a soft, dry cloth or one that has been slightly dampened with water. To remove stubborn dirt, use a cloth impregnated with a mild, non-abrasive detergent. Afterwards, be sure to wipe the unit thoroughly with a soft, dry cloth.
- Never use benzine, thinners, alcohol or solvents of any kind, to avoid the possibility of discoloration and/or deformation.

Repairs and Data

- Please be aware that all data contained in the unit's memory may be lost when the unit is sent for repairs. Important data should always be written down on paper (when possible). During repairs, due care is taken to avoid the loss of data. However, in certain cases (such as when circuitry related to memory itself is out of order), we regret that it may not be possible to restore the data, and Roland assumes no liability concerning such loss of data.

Additional Precautions

- Please be aware that the contents of memory can be irretrievably lost as a result of a malfunction, or the improper operation of the unit. To protect yourself against the risk of losing important data, we recommend that you periodically write down on paper.
- Unfortunately, it may be impossible to restore the contents of data that was stored on internal memory once it has been lost. Roland Corporation assumes no liability concerning such loss of data.
- Use a reasonable amount of care when using the unit's buttons, sliders, or other controls; and when using its jacks and connectors. Rough handling can lead to malfunctions.
- When connecting / disconnecting all cables, grasp the connector itself—never pull on the cable. This way you will avoid causing shorts, or damage to the cable's internal elements.
- To avoid disturbing your neighbors, try to keep the unit's volume at reasonable levels (especially when it is late at night).
- When you need to transport the unit, package it in the box (including padding) that it came in, if possible. Otherwise, you will need to use equivalent packaging materials.
- Some connection cables contain resistors. Do not use cables that incorporate resistors for connecting to this unit. The use of such cables can cause the sound level to be extremely low, or impossible to hear. For information on cable specifications, contact the manufacturer of the cable.
- When turning the unit upside-down, handle with care to avoid dropping it, or allowing it to fall or tip over. Prevent damage to the buttons and controls.

About Intellectual Property Rights

- This product can be used to record or duplicate audio or visual material without being limited by certain technological copy-protection measures. This is due to the fact that this product is intended to be used for the purpose of producing original music or video material, and is therefore designed so that material that does not infringe copyrights belonging to others (for example, your own original works) can be recorded or duplicated freely.

Contents

Before Using the VC-30HD	10
Supported Formats	10
About Rubber Feet	10
Turning the Power On and Off	11
Connecting the AC Adapter	11
Turning the Power On	12
Turning the power off	12
About AUTO OFF	13
Names of Things and What They Do	14
Front Panel	14
Rear Panel	16
About Button Operations	17
Connecting External Equipment	18
Connecting Video Sources	19
Making a Component Connection	19
Making a Composite/S-Video Connection	20
Making an HDMI Connection.....	21
Making an i.LINK Connection.....	21
Connecting Audio Sources.....	22
Making an Analog Connection	22
Making a Digital Connection	23
The PEAK/SIG Indicators and the SENS Dial	23
Connecting Output Equipment.....	24
Connecting an i.LINK Device.....	24
Connecting a USB device	24
Connecting a Timecode Source.....	25
Converting Signals	26
Converting Analog Input	26
Converting HDMI Input	27
i.LINK Thru-Out	27
Audio Source Settings.....	28
Appendices	29
Main Specifications	29
About Remote Control.....	31
Security slot.....	31
Dimensions	32
Troubleshooting.....	33

Before Using the VC-30HD

Supported Formats

The VC-30HD supports the following formats.

INPUT

Component/HDMI
1080/59.94i, 50i, 23.98PsF 720/59.94p, 50p 576/50p, 480/59.94p
576/50i, 480/59.94i
Composite/S-Video
576/50i, 480/59.94i
i.LINK (Front)
HDV, DV, MPEG-2

OUTPUT

i.LINK(Rear), USB
HDV, MPEG-2
DV, MPEG-2
i.LINK (Rear), USB
DV, MPEG-2
i.LINK (Rear), USB
Thru Output

* The output frame rate will be the same as the input frame rate.

NOTE

The VC-30HD does not support up/down scaling, interlace/progressive (I/P) conversion, or frame rate conversion. The [OUTPUT FORMAT] indicators flash when the input and output formats are not compatible, such as the scenarios shown below. No output is possible while the [OUTPUT FORMAT] indicators are flashing.

- When 1080i component input is selected as the source and DV is selected as the output format.
- When NTSC S-Video input is selected as the source and HDV is selected as the output format.

About Rubber Feet

Attach the included rubber feet to the bottom panel if necessary. Attach the rubber feet at the locations shown below. Affix so as to block the four holes on the bottom panel.

* When turning the unit upside down, handle with care to avoid dropping the unit, allowing it to fall or tip over, or damaging the controls.

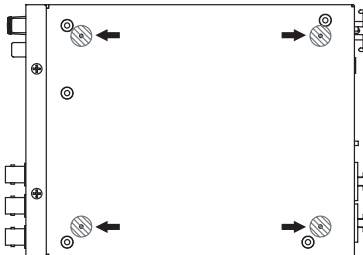

Turning the Power On and Off

Connecting the AC Adapter

Place the AC adaptor so the side with the indicator (see illustration) faces upwards and the side with textual information faces downwards.

* The indicator will light when you plug the AC adaptor into an AC outlet.

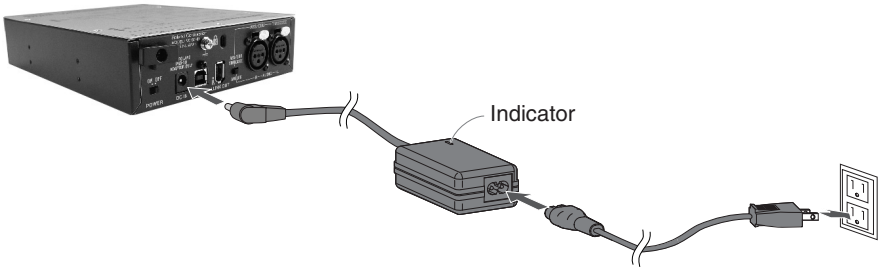

About Cord Hook

To prevent the inadvertent disruption of power to your unit (should the plug be pulled out accidentally), and to avoid applying undue stress to the AC adaptor jack, anchor the power cord using the cord hook, as shown in the illustration.

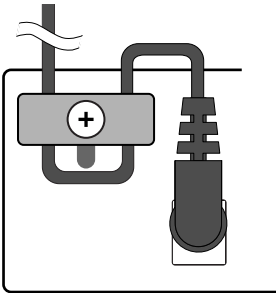

About Ground Terminal

Depending on the circumstances of a particular setup, you may experience a discomforting sensation, or perceive that the surface feels gritty to the touch when you touch this device, video equipment connected to it, or the metal portions of other objects. This is due to an infinitesimal electrical charge, which is absolutely harmless. However, if you are concerned about this, connect the ground terminal (see figure) with an external ground. When the unit is grounded, a slight hum may occur, depending on the particulars of your installation. If you are unsure of the connection method, contact the nearest Roland Service Center, or an authorized Roland distributor, as listed on the "Information" sheet.

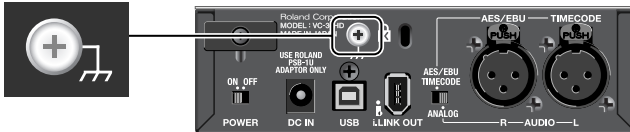

Unsuitable places for connection

- Water pipes (may result in shock or electrocution)
- Gas pipes (may result in fire or explosion)
- Telephone-line ground or lightning rod (may be dangerous in the event of lightning)

Turning the Power On

- * Once the connections have been completed (p. 11), turn on power to your various devices in the order specified. By turning on devices in the wrong order, you risk causing malfunction and/or damage to other devices.
- * This unit is equipped with a protection circuit. A brief interval (a few seconds) after power up is required before the unit will operate normally.
- * Always make sure to have the volume level of audio output devices turned down before switching on power. Even with the volume all the way down, you may still hear some sound when the power is switched on, but this is normal, and does not indicate a malfunction.

Make sure the power cable is securely inserted, then slide the [POWER] switch located on the rear panel to [ON]. The indicators on the front panel flash in sequence from left to right, and the VC-30HD starts up.

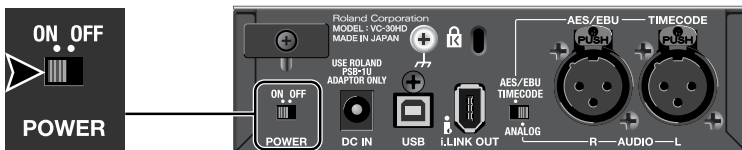

Turning the power off

Slide the [POWER] switch on the rear panel to [OFF]. The indicators on the front panel all go dark, and the power to the VC-30HD is switched off.

About AUTO OFF

The power to the VC-30HD is switched off automatically when four hours have elapsed with no input of video or audio signals (factory default). When this happens, the VC-30HD does not function even though the POWER switch is at [ON]. To turn on the power again, first slide the POWER switch back to [OFF], then slide it to [ON] again.

Deactivating AUTO OFF

If automatic power-off is not needed, use the procedure described below to deactivate the feature.

1. Press all buttons for 5 seconds.

Press and hold the [VIDEO INPUT], [OUTPUT FORMAT], and [AUDIO INPUT] buttons for five seconds.

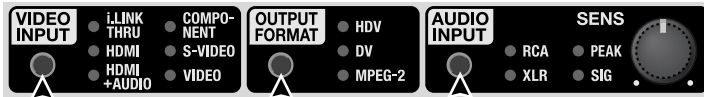

2. Make sure the feature has been deactivated.

When the AUTO OFF feature is deactivated, the [VIDEO INPUT] and [OUTPUT FORMAT] indicators all flash.

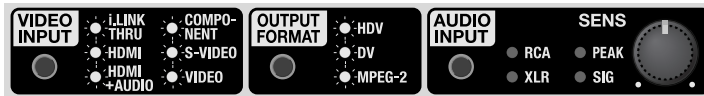

3. Enable the feature again.

In the same way as in step 1, press and hold all buttons for five seconds. When the feature is enabled, the [AUDIO INPUT] indicators all flash.

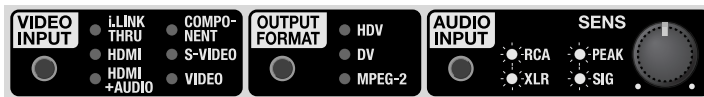

NOTE

The buttons are nonfunctional while the indicators are flashing (approximately five seconds). Wait for the indicators to stop flashing before attempting any operations.

Names of Things and What They Do

Front Panel

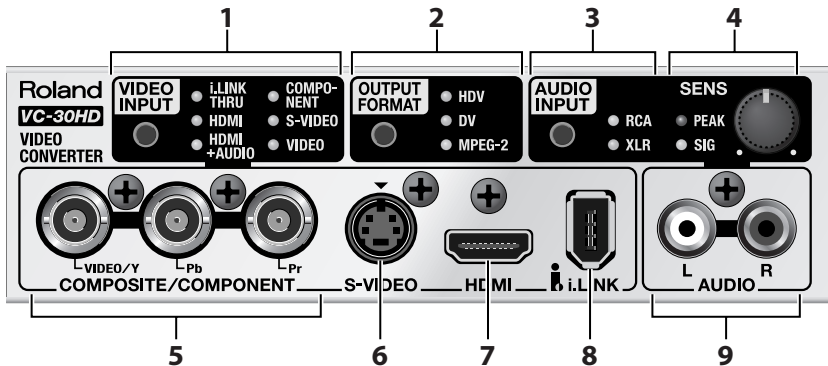

cf. →

For information on button operations, refer to “Button operations” (p. 17).

cf. →

For information on source and output-format settings, refer to “Converting Signals” (p. 26).

1. VIDEO INPUT indicators

These set and display the source. Use this button to switch the source.

2. OUTPUT FORMAT indicators

These set and display the output format. Use this button to switch the output format. The indicators flash when an output format incompatible with the source is selected. No output is possible while these are flashing.

* The output format being sent to i.LINK and USB will always be the same format. They cannot be two independent formats.

3. AUDIO INPUT indicators

These set and display the audio source. Use the button to switch the audio source.

4. PEAK/SIG indicators and SENS dial

These display and adjust the sensitivity of audio input. The PEAK and SIG indicators light up in the following cases.

- PEAK
This lights up when input to the connector selected as the audio source is too high.
- SIG
This lights up when audio signal is being received from your selected audio source.

5. COMPOSITE/COMPONENT connectors

Connect analog source devices to these. For composite connections, use only the [VIDEO/Y] connector. For component connections, use all three connectors.

6. S-VIDEO connector

Connect an S-Video source here.

7. HDMI connector

Connect an HDMI source here.

* Version 1.3, with Deep Color support

NOTE

HDCP (High-bandwidth Digital Content Protection) is not supported for HDMI input on the VC-30HD.

8. i.LINK input connector

Connect an i.LINK source here.

* If you plan on connecting a video deck or a computer to capture the output of the VC-30HD, use the rear i.LINK connector. The front i.LINK connector is reserved for i.LINK input sources only.

9. AUDIO (L/R) connectors

Connect consumer line-level audio sources (CD, DVD players, etc.) here.

* When connecting a professional audio mixer or other device having a high rated output level, make the connection to the [AUDIO IN] connectors on the rear panel.

* When connection cables with resistors are used, the volume level of equipment connected to the inputs may be low. If this happens, use connection cables that do not contain resistors.

Rear Panel

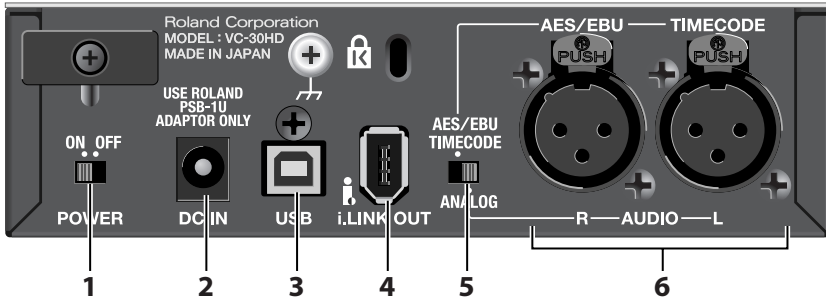

1. POWER switch

This turns the VC-30HD's power on and off.

2. DC IN connector

This is for connecting the included AC adapter.

3. USB connector

Connect a computer or other USB equipment as an output-destination device.

4. i.LINK OUT connector

Connect a video deck, computer, or other i.LINK equipment as an output-destination device.

5. AUDIO IN selector switch

This switches the mode of the AUDIO IN connectors.

- ANALOG
Both connectors (L and R) function, and the analog input mode is enabled.
- AES/EBU TIMECODE
The AES/EBU connector functions as audio input, and the digital input mode is enabled. You can also input an SMPTE 12M timecode (linear timecode, or LTC) via the TIMECODE connector.

6. AUDIO IN connectors

Connect an audio mixer or other audio source equipment.

- * When connecting a consumer audio mixer, CD/DVD player, or the like, make the connection to the [AUDIO (L/R)] connectors on the front panel.
- * When connection cables with resistors are used, the volume level of equipment connected to the inputs may be low. If this happens, use connection cables that do not contain resistors.

About Button Operations

The buttons switch the modes for [VIDEO INPUT], [OUTPUT FORMAT], and [AUDIO INPUT]. If the buttons are difficult to press, use a pen tip or the like to press them.

1. Check the current mode.

Check the [VIDEO INPUT], [OUTPUT FORMAT], and [AUDIO INPUT] indicators.

* The [OUTPUT FORMAT] indicators flash when an output format is incompatible with the input format. Selecting a supported output format makes the indicators light up steadily.



2. Select the mode you wish to use.

Press the button to choose the mode. Each one-second press makes the mode change. During the switching operation, the indicator for the newly selected mode flashes.

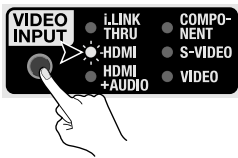

3. Make sure the mode has switched.

When the mode has switched completely, the indicator stops flashing and lights up steadily.

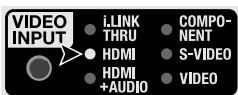

If the signal source you selected is not detected, the [VIDEO INPUT] and [AUDIO INPUT] indicators will do the following :

- [VIDEO INPUT]
These will flash when the selected video source is not detected.
- [AUDIO INPUT]
These will flash if you have selected [AES/EBU] as your audio source and no AES/EBU digital audio is detected. (When analog is selected, no input detection is performed.)

Connecting External Equipment

You can connect external equipment as shown below.

* To prevent malfunction and/or damage to other devices, always turn off the power on all devices before making any connections.

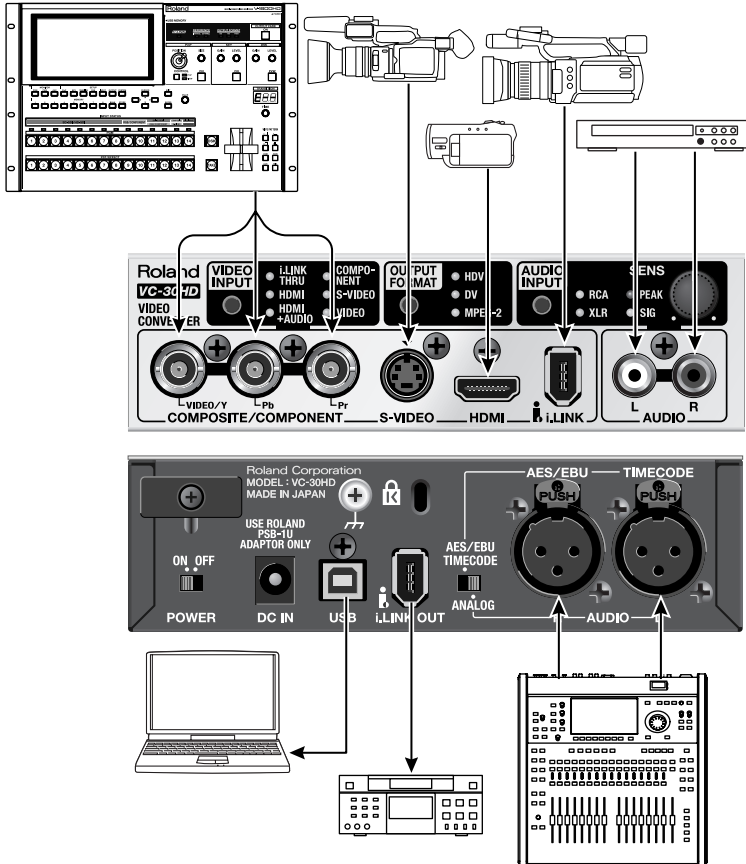

This unit is equipped with balanced XLR type jacks. Wiring diagrams for these jacks are shown below. Make connections after first checking the wiring diagrams of other equipment you intend to connect.

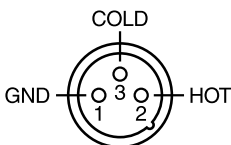

Connecting Video Sources

Use appropriate cables and plugs to connect your video sources. For information on source selection, refer to “Converting Analog Input” (p. 26).

Making a Component Connection

When making a component connection, use all three [COMPOSITE/COMPONENT] connectors.

Connecting a Video Camera

Connect the component output from a video camera to the [COMPOSITE/COMPONENT] connectors on the front panel.

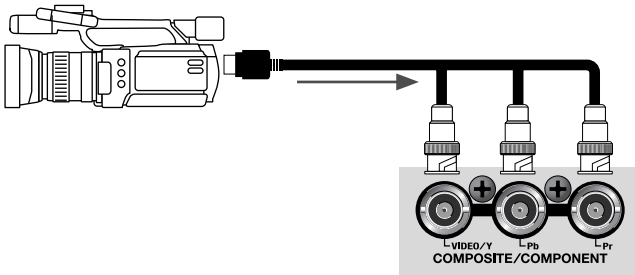

Connecting a Video Mixer

Connect component output from a video mixer such as the V-1600HD to the [COMPOSITE/COMPONENT] connectors on the front panel.

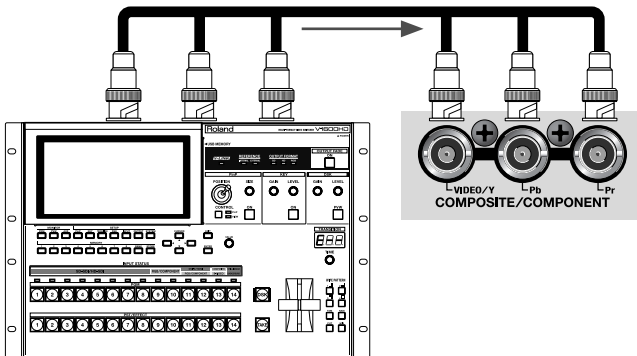

Making a Composite/S-Video Connection

Making a Composite Connection

Connect composite output from a video camera or video mixer to the [COMPOSITE/COMPONENT] connector on the front panel.

- * When making a composite connection, use only the [VIDEO/Y] connector.
- * When BNC/RCA conversion is needed, use an adapter plug. No adapter plug is included with this product.

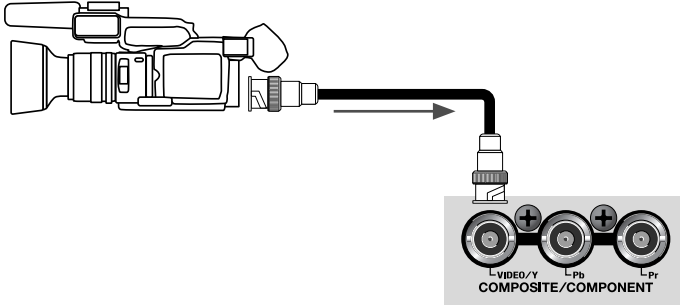

Making an S-Video Connection

Connect S-Video output from a video camera or video mixer to the [S-VIDEO] connector on the front panel.

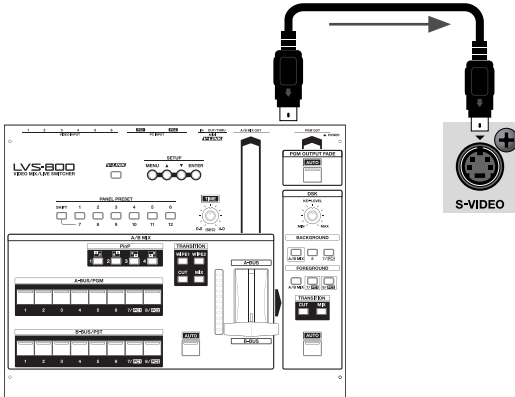

Making an HDMI Connection

Connect a video camera or other device provided with HDMI output to the [HDMI] connector on the front panel. For information on the source selection, refer to “Converting HDMI Input” (p. 27).

NOTE

HDCP (High-bandwidth Digital Content Protection) is not supported for HDMI input on the VC-30HD.

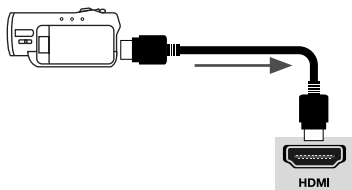

Making an i.LINK Connection

Connect a video camera or other device provided with i.LINK output to the [i.LINK] connector on the front panel. For information on the source selection, refer to “i.LINK Thru-Out” (p. 27).

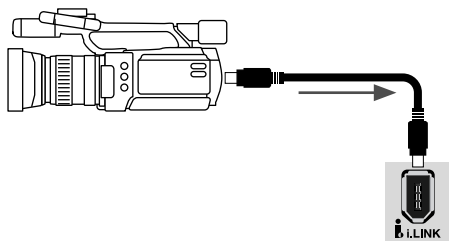

Connecting Audio Sources

Making an Analog Connection

Use analog connectors for the audio sources. For information on the source selection, refer to “Audio Source Settings” (p. 28).

* When connection cables with resistors are used, the volume level of equipment connected to the inputs may be low. If this happens, use connection cables that do not contain resistors.

Making a RCA Connection

Connect the audio output from a video camera or the like to the [AUDIO (L/R)] connectors on the front panel.

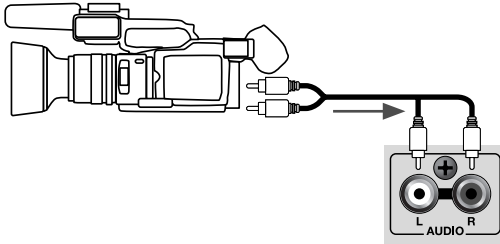

Making an XLR Connection

Connect analog output from an audio mixer such as the Roland V-Mixer to the [AUDIO IN] connectors on the rear panel.

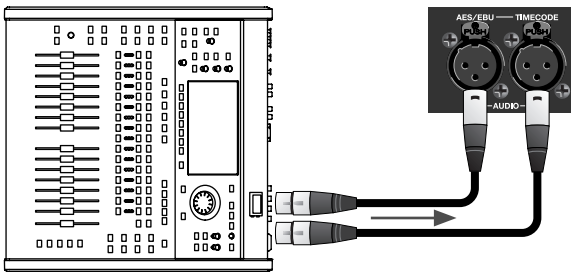

At this time, use the AUDIO IN selector switch to select [ANALOG].



Making a Digital Connection

Use [AES/EBU] connector on the rear panel for your digital audio source. For information on the source selection, refer to “Audio Source Settings” (p. 28).

* The standard supported by the VC-30HD is AES3 (16 to 24 bits, 32 to 48 kHz, 2 channels).

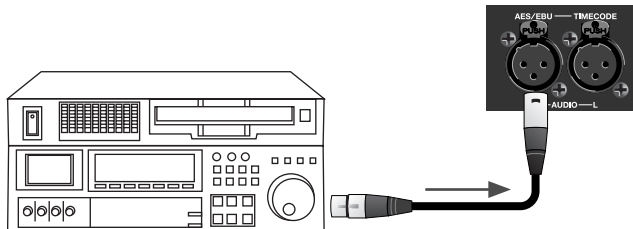

At this time, set the [AUDIO IN] selector switch to [AES/EBU TIMECODE].

* When this setting is in effect, you can input AES/EBU digital audio and a timecode simultaneously (p. 25).



The PEAK/SIG Indicators and the SENS Dial

PEAK indicator

This lights up when input from the audio source is too high. If it lights up, use the [SENS] dial to lower the input sensitivity.

SIG indicator

This lights up when input from the audio device is adequate.

SENS dial

This adjusts the audio input sensitivity of the VC-30HD. For information on input levels, refer to “Main Specifications” (p. 29).

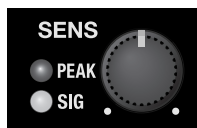

Connecting Output Equipment

NOTE

The format of i.LINK output and USB output cannot be set independently. The format set using [OUTPUT FORMAT] applies to both i.LINK and USB output.

Connecting an i.LINK Device

Connect a computer or video deck via i.LINK. Use an i.LINK cable to connect the computer or video deck to the [i.LINK OUT] connector on the rear panel.

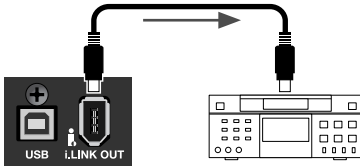

Connecting a USB device

Connect a computer via USB. Use a USB cable to connect the computer to the [USB] connector on the rear panel.

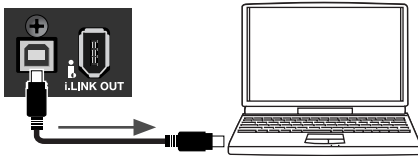

A short while after making the connection, communication between the VC-30HD and the computer starts, and the standard driver for the operating system is loaded. The VC-30HD is recognized as a USB video device or audio device.

Supported Operating System

You can make a connection to a computer running Windows 7.

* Connection and operation of the VC-30HD with standard-specification computers running Windows 7 have been verified, but connection and operation with all computers satisfying these conditions is not assured. Connection or operation may be impossible due to differences in setting specifications or the usage environment that are specific to the equipment.

Connecting a Timecode Source

You can input a timecode from a source device simultaneously with digital audio. Use an XLR cable to connect the source device to the [TIMECODE] connector on the rear panel.

* The standard supported by the VC-30HD is SMPTE 12M (LTC).

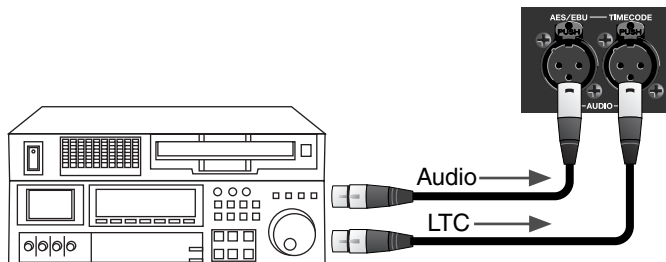

At this time, use the [AUDIO IN] selector switch to select [AES/EBU TIMECODE].



Converting Signals

Signals input to the VC-30HD are output from the i.LINK connector and USB connector on the rear panel. Use the button at [OUTPUT FORMAT] to select the output format.

NOTE

The VC-30HD does not support up/down scalling, interlace/progressive (I/P) conversion, or frame-rate conversion. The [OUTPUT FORMAT] indicators flash when the input and output formats are not compatible, such as the scenarios shown below. No output is possible while the [OUTPUT FORMAT] indicators are flashing.

- When 1080i component input is selected as the source and DV is selected as the output format.
- When NTSC S-Video input is selected as the source and HDV is input as the output format.

This section describes the source settings. For information on button operations, refer to “About Button Operations” (p. 17).

Converting Analog Input

When an analog video source has been selected, the audio source selected using [AUDIO INPUT] is embedded to the output. L and R cannot be exchanged.

Converting from Component

Use [VIDEO INPUT] to select [COMPONENT].

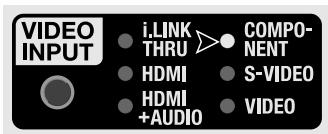

Converting from S-Video

Use [VIDEO INPUT] to select [S-VIDEO].

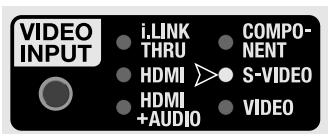

Converting from Composite

Use [VIDEO INPUT] to select [VIDEO].

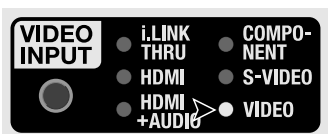

Converting HDMI Input

When HDMI has been selected for the source, you can select the settings described below for audio output.

- [HDMI]

Audio contained in the HDMI signal is output.

- [HDMI+AUDIO]

The audio signal contained in the HDMI signal is canceled, and the audio source selected using [AUDIO INPUT] is embedded to the output. L and R cannot be exchanged.

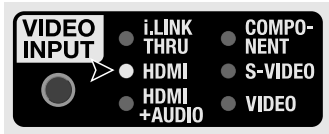

NOTE

HDCP (High-bandwidth Digital Content Protection) is not supported for HDMI input on the VC-30HD.

i.LINK Thru-Out

When two i.LINK devices cannot communicate (such as two computer i.LINK ports), you can connect them using the VC-30HD. In this case, you use [VIDEO INPUT] to select [i.LINK THRU].

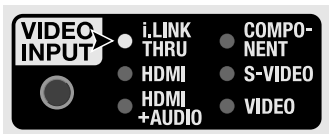

NOTE

Depending on the i.LINK device, in rare instances, the audio may contain noise, or the picture may experience drop out.

Audio Source Settings

Use the button in the [AUDIO INPUT] section on the front panel and the selector switch on the rear panel to select the audio source. Possible selections are shown below.

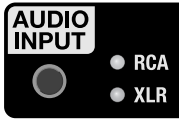

[RCA] + [ANALOG]

The [AUDIO (L/R)] connectors on the front panel are enabled.

[RCA] + [AES/EBU TIMECODE]

The [AUDIO (L/R)] connectors on the front panel are enabled. You can also input timecode from the [TIMECODE] connector on the rear panel.

[XLR] + [ANALOG]

The analog [AUDIO IN] connectors on the rear panel are enabled.

[XLR] + [AES/EBU TIMECODE]

The [AES/EBU] connector is enabled. You can also input timecode from the [TIMECODE] connector on the rear panel.

Main Specifications

Codec		
HDV	Video Format	MPEG-2 Video, 8 bits, 4:2:0 1440 x 1080/59.94i, 50i, 23.98p (25Mbps) 1280 x 720/59.94p, 50p (18.3Mbps) 720 x 480/59.94p, 720 x 576/50p (18Mbps)
	Audio Format	MPEG-1 Audio Layer 2, 16 bits/48kHz, 2ch (384Kbps)
DV	Video Format	720 x 480/59.94i (NTSC), 720 x 576/50p (PAL)
	Audio Format	Linear PCM, 16 bits/48kHz, 2ch
MPEG-2	Video Format (Default Setup)	MPEG-2 Video, 8 bits, 4:2:0 1920 x 1080/59.94i, 50i, 23.98p (35Mbps) 1280 x 720/59.94p, 50p (35Mbps) 720 x 480/59.94p, 720 x 576/50p (35Mbps) 720 x 480/59.94i, 720 x 576/50i (9Mbps)
	Audio Format	MPEG-1 Audio Layer 2, 16 bits/48kHz, 2ch (384Kbps)
Input Connectors and Signals		
HDMI	Connector	Type A (19 pins) x 1
	Video Format	1080/59.94i, 50i 720/59.94p, 50p 576/50p, 50i 480/59.94p, 59.94i
	Audio Format	Linear PCM, 16 - 24 bits/32 - 48kHz, 2ch
Component	Connector	BNC type x 1 group
	Video Format	1080/59.94i, 50i, 23.98PsF 720/59.94p, 50p 576/50p, 50i 480/59.94p, 59.94i
	Signal Level	Luminance Signal : 1.0 Vp-p, Chrominance Signal : 0.7 Vp-p
	Impedance	75 ohms
Composite	Connector	BNC type x 1 (combinations use with Y of component)
	Video Format	480/59.94i (NTSC), 576/50i (PAL)
	Signal Level	1.0 Vp-p
	Impedance	75 ohms
S-Video	Connector	4 pins mini DIN type x 1
	Video Format	480/59.94i (NTSC), 576/50i (PAL)
	Signal Level	Luminance Signal : 1.0 Vp-p Chrominance Signal : 0.286 Vp-p (NTSC), 0.3 Vp-p (PAL)
	Impedance	75 ohms

Input Connectors and Signals		
i.LINK (front)	Connector	6 pins type (S100) x 1
	Video Format	HDV, DV (IEC61883-2), MPEG-2 TS (IEC61883-4)
	Max Bit Rate	50 Mbps
Analog Audio (front)	Connector	RCA pin type x 1 pair (L/R)
	Signal Level	-20 to -6 dBu
	Impedance	35 k ohms
Analog Audio (rear)	Connector	XLR type (balanced) x 1 pair (L/R)
	Signal Level	-8 to +10 dBu
	Impedance	14 k ohms
Digital Audio	Connector	XLR type x 1 (switching use with audio R ch of rear panel)
	Audio Format	AES3, 16 - 24 bits, 32 - 48kHz, 2ch
	Impedance	110 ohms
Time- code	Connector	XLR type x 1 (switching use with audio L ch of rear panel)
	Signal Format	SMPTE 12M LTC
	Signal Level	0.5 Vp-p - 18 Vp-p
	Impedance	14 k ohms
Output Connectors and Signals		
i.LINK (rear)	Connector	6 pins type (S100) x 1
	Video Format	HDV, DV (IEC61883-2), MPEG-2 TS (IEC61883-4)
	Max Bit Rate	50 Mbps
USB	Connector	Type B (Hi-Speed USB) x 1
	Signal Format	USB Video (DV, MPEG-2 TS) USB Audio (Audio, MIDI)
	Max Bit Rate	25 Mbps
Others		
Power Supply	DC 9V (AC Adaptor)	
Power Consumption	10W	
Dimensions	146 (W) x 210 (D) x 42 (H) mm 5-3/4 (W) x 8-5/16 (D) x 1-3/4 inches	
Weight	900 g / 2 lbs (excluding AC Adaptor)	
Operation Temperature	0 to +40 degrees Celsius / +41 to +104 degrees Fahrenheit	
Accessories	AC Adaptor and Power Cord, Rubber Foot x 4, Owner's Manual	

* 0 dBu = 0.775 Vrms

* In the interest of product improvement, the specifications and/or appearance of this unit are subject to change without prior notice.

About Remote Control

Connecting a computer installed with the [VC-30HD RCS] dedicated remote-control software to the USB connector of the VC-30HD enables you remotely control the unit from your computer.

Download [VC-30HD RCS] from the following Roland website.

<http://www.rolandsystemsgroup.net/>

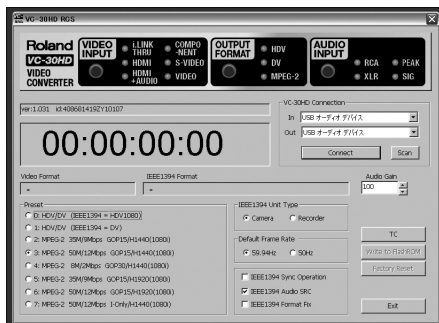

MEMO

USB output to the connected computer is possible even while receiving remote control from the computer.

MEMO

You can select the output bit rate of VC-30HD from your computer from below using this dedicated remote control software. By default, the output bit rate is set to 25 Mbps.

- 25 Mbps, 35 Mbps, 50 Mbps, 8 Mbps, 12 Mbps, 18 Mbps

* The USB output is cancelled if 35 Mbps or 50 Mbps is selected as the output bit rate.

Security slot

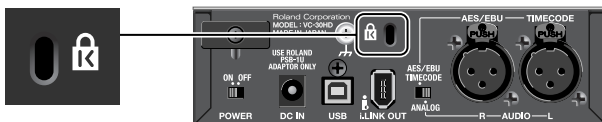

<http://www.kensington.com/>

Dimensions

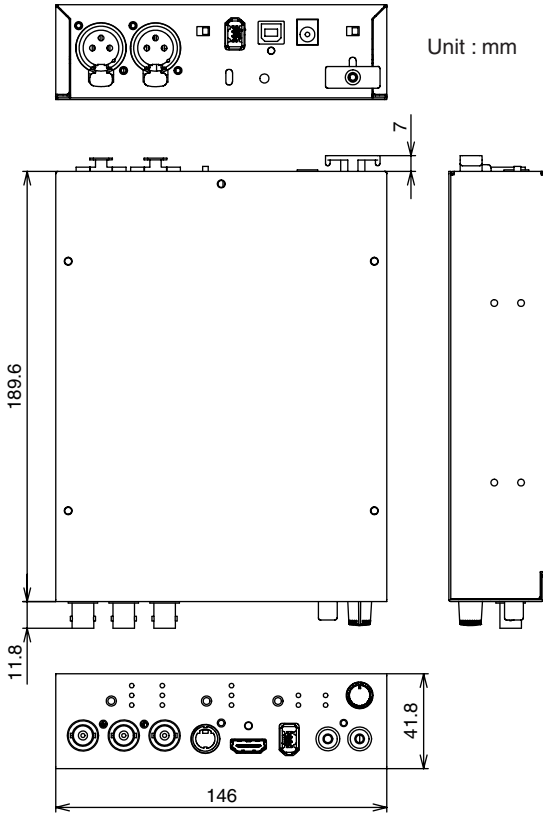

* When using the holes in the side panel to secure the unit in place, use screws measuring 3 mm in diameter and whose length is no more than 8 mm from the surface of the side panel.

Troubleshooting

Can't perform format conversion

Is a format supported by the VC-30HD being input?

The VC-30HD does not support up/down scalling, interlace/progressive (I/P) conversion, or frame rate conversion. The [OUTPUT FORMAT] indicators flash when the input and output formats are not compatible. No output is possible while the [OUTPUT FORMAT] indicators are flashing. For information on formats that can be input and output, refer to "Supported Formats" (p. 10).

The audio level is too high/too low

Does the signal level from the source equipment match the input signal level on the VC-30HD?

The RCA connectors on the front panel and the XLR connectors on the rear panel have different nominal input signal levels. Connect source equipment that is capable of output at the levels shown below.

- RCA (front panel) -20 - 6 dBu
- XLR (rear panel) -8 - +10 dBu

Also, when connection cables containing resistors are used, the signal level from the source equipment is lowered. Use a connection cable that does not contain a resistor.

Cannot input from an i.LINK device

Has communication been established between the VC-30HD and the i.LINK source device?

Input from i.LINK equipment is not possible unless communication has been established. If the [i.LINK] indicator in [VIDEO INPUT] section is flashing, communication has not been established. Wait until the indicator lights up steadily, then perform output.

HDMI audio is not converted

Is the [HDMI + AUDIO] [VIDEO INPUT] indicator illuminated?

HDMI audio input is canceled when this indicator is illuminated. When you want to convert HDMI audio, select [HDMI].



This product complies with the requirements of EMC Directive 2004/108/EC.

For EU Countries

FEDERAL COMMUNICATIONS COMMISSION RADIO FREQUENCY INTERFERENCE STATEMENT

For the USA

This equipment has been tested and found to comply with the limits for a Class B digital device, pursuant to Part 15 of the FCC Rules. These limits are designed to provide reasonable protection against harmful interference in a residential installation. This equipment generates, uses, and can radiate radio frequency energy and, if not installed and used in accordance with the instructions, may cause harmful interference to radio communications. However, there is no guarantee that interference will not occur in a particular installation. If this equipment does cause harmful interference to radio or television reception, which can be determined by turning the equipment off and on, the user is encouraged to try to correct the interference by one or more of the following measures:

- Reorient or relocate the receiving antenna.
- Increase the separation between the equipment and receiver.
- Connect the equipment into an outlet on a circuit different from that to which the receiver is connected.
- Consult the dealer or an experienced radio/TV technician for help.

This device complies with Part 15 of the FCC Rules. Operation is subject to the following two conditions:

- (1) this device may not cause harmful interference, and
- (2) this device must accept any interference received, including interference that may cause undesired operation.

This equipment requires shielded interface cables in order to meet FCC class B limit.

Any unauthorized changes or modifications not expressly approved by the party responsible for compliance could void the user's authority to operate the equipment.

For Canada

NOTICE

This Class B digital apparatus meets all requirements of the Canadian Interference-Causing Equipment Regulations.

AVIS

Cet appareil numérique de la classe B respecte toutes les exigences du Règlement sur le matériel brouilleur du Canada.

For C.A. US (Proposition 65)

WARNING

This product contains chemicals known to cause cancer, birth defects and other reproductive harm, including lead.

For the USA

DECLARATION OF CONFORMITY Compliance Information Statement

Model Name : VC-30HD
Type of Equipment : Video Converter
Responsible Party : Roland Systems Group U.S.
Address : 801 West Orchard Drive, Suite 3, Bellingham, WA 98225
Telephone : (360)594-4282

For EU Countries



- UK** This symbol indicates that in EU countries, this product must be collected separately from household waste, as defined in each region. Products bearing this symbol must not be discarded together with household waste.
- DE** Dieses Symbol bedeutet, dass dieses Produkt in EU-Ländern getrennt vom Hausmüll gesammelt werden muss gemäß den regionalen Bestimmungen. Mit diesem Symbol gekennzeichnete Produkte dürfen nicht zusammen mit dem Hausmüll entsorgt werden.
- FR** Ce symbole indique que dans les pays de l'Union européenne, ce produit doit être collecté séparément des ordures ménagères selon les directives en vigueur dans chacun de ces pays. Les produits portant ce symbole ne doivent pas être mis au rebut avec les ordures ménagères.
- IT** Questo simbolo indica che nei paesi della Comunità europea questo prodotto deve essere smaltito separatamente dai normali rifiuti domestici, secondo la legislazione in vigore in ciascun paese. I prodotti che riportano questo simbolo non devono essere smaltiti insieme ai rifiuti domestici. Ai sensi dell'art. 13 del D.Lgs. 25 luglio 2005 n. 151.
- ES** Este símbolo indica que en los países de la Unión Europea este producto debe recogerse aparte de los residuos domésticos, tal como está regulado en cada zona. Los productos con este símbolo no se deben depositar con los residuos domésticos.
- PT** Este símbolo indica que nos países da UE, a recolha deste produto deverá ser feita separadamente do lixo doméstico, de acordo com os regulamentos de cada região. Os produtos que apresentem este símbolo não deverão ser eliminados juntamente com o lixo doméstico.
- NL** Dit symbool geeft aan dat in landen van de EU dit product gescheiden fra huishoudelijk afval moet worden aangeboden, zoals bepaald per gemeente of regio. Producten die van dit symbool zijn voorzien, mogen niet samen met huishoudelijk afval worden verworpen.
- DK** Dette symbol angiver, at i EU-lande skal dette produkt opsamlles adskilt fra husholdningsaffald, som defineret i hver enkelt region. Produkter med dette symbol må ikke smides ud sammen med husholdningsaffald.
- NO** Dette symbolet indikerer at produktet må behandles som spesialavfall i EU-land, iht. til retningslinjer for den enkelte regionen, og ikke kastes sammen med vanlig husholdningsavfall. Produkter som er merket med dette symbolet, må ikke kastes sammen med vanlig husholdningsavfall.

- SE** Symbolen anger att i EU-länder måste den här produkten kasseras separat från hushållsavfall, i enlighet med varje regions bestämmelser. Produkter med den här symbolen får inte kasseras tillsammans med hushållsavfall.
- FI** Tämä merkintä ilmaisee, että tuote on EU-maissa kerättävä erillään kotitalousjätteistä kunkin alueen voimassa olevien määräysten mukaisesti. Tällä merkinnällä varustettuja tuotteita ei saa hävittää kotitalousjätteen mukana.
- HU** Ez a szimbólum azt jelenti, hogy az Európai Unióban ezt a terméket a háztartási hulladéktól elkülönítve, az adott régióban érvényes szabályozás szerint kell gyűjteni. Az ezzel a szimbólummal ellátott termékeket nem szabad a háztartási hulladék közé dobni.
- PL** Symbol oznacza, że zgodnie z regulacjami w odpowiednim regionie, w krajach UE produktu nie należy wyrzucać z odpadami domowymi. Produktów opatrzonych tym symbolem nie można utylizować razem z odpadami domowymi.
- CZ** Tento symbol udává, že v zemích EU musí být tento výrobek sbíráán odděleně od domácího odpadu, jak je určeno pro každý region. Výrobky nesoucí tento symbol se nesmí vyhadzovat spolu s domácím odpadem.
- SK** Tento symbol vyjadruje, že v krajinách EÚ sa musí zber tohto produktu vykonávať oddelene od domového odpadu, podľa nariadení platných v konkrétnej krajine. Produkty s týmto symbolom sa nesmú vyhazovať spolu s domovým odpadom.
- EE** See sümbol näitab, et EL-i maades tuleb see toode olemprügist eraldi koguda, nii nagu on igas piirkonnas määratud. Selle sümboliga märgitud tooteid ei tohi ära visata koos olmeprügiga.
- LT** Šis simbolis rodo, kad ES šalyse šis produktas turi būti surenkamas atskirai nuo buitinių atliekų, kaip nustatyta kiekviename regione. Šiuo simboliu paženklinoti produktai neturi būti išmetami kartu su buitiniems atliekoms.
- LV** Šis simbols norāda, ka ES valstīs šo produktu jāievāc atsevišķi no mājsaimniecības atkritumiem, kā noteikts katrā reģionā. Produkta ar šo simbolu nedrīkst izmest kopā ar mājsaimniecības atkritumiem.
- SI** Ta simbol označuje, da je treba proizvod v državah EU zbirati ločeno od gospodinskih odpadkov, tako kot je določeno v vsaki regiji. Proizvoda s tem znakom ni dovoljeno odlagati skupaj z gospodinskimi odpadki.
- GR** Το σύμβολο αυτό υποδηλώνει ότι στις χώρες της Ε.Ε. το συγκεκριμένο προϊόν πρέπει να συλλέγεται χωριστά από τα υπόλοιπα οικιακά απορρίμματα, σύμφωνα με όσα προβλέπονται σε κάθε περιοχή. Τα προϊόντα που φέρουν το συγκεκριμένο σύμβολο δεν πρέπει να απορρίπτονται μαζί με τα οικιακά απορρίμματα.

For China

有关产品中所含有害物质的说明

本资料就本公司产品中所含的特定有害物质及其安全性予以说明。
本资料适用于 2007 年 3 月 1 日以后本公司所制造的产品。

环保使用期限



此标志适用于在中国国内销售的电子信息产品，表示环保使用期限的年数。所谓环保使用期限是指在自制造日起的规定期限内，产品中所含的有害物质不致引起环境污染，不会对人身、财产造成严重的不良影响。环保使用期限仅在遵照产品使用说明书，正确使用产品的条件下才有效。不当的使用，将会导致有害物质泄漏的危险。

产品中有毒有害物质或元素的名称及含量

部件名称	有毒有害物质或元素					
	铅(Pb)	汞(Hg)	镉(Cd)	六价铬(Cr(VI))	多溴联苯(PBB)	多溴二苯醚(PBDE)
外壳(壳体)	×	○	○	○	○	○
电子部件(印刷电路板等)	×	○	×	○	○	○
附件(电源线、交流适配器等)	×	○	○	○	○	○

○：表示该有毒有害物质在该部件所有均质材料中的含量均在 SJ/T11363-2006 标准规定的限量要求以下。
×：表示该有毒有害物质至少在该部件的某一均质材料中的含量超出 SJ/T11363-2006 标准规定的限量要求。
因根据现有的技术水平，还没有什么物质能够代替它。



* 5 1 0 0 0 2 0 9 6 2 - 0 1 *