

YONGNUO
DIGITAL

SPEEDLITE TRANSMITTER

YN-E3-RT



User Manual
用户手册

Contents

Introduction	1
Nomenclature.	2-4
Preparation Before Use	5-6
Wireless Flash Shooting.	7
Wireless Settings	8-9
ETTL:Fully Automatic Wireless Flash Shooting	10-14
M: Wireless Multiple Flash Shooting with Manual Flash Output.	15-16
MULI: Stroboscopic Flash	17
Gr: Shooting with a Different Flash Mode for Each Group.	18-19
Remote Release from a Slave Unit/Linked Shooting	20-21
Transmitter Control from Camera's Menu Screen	22-23
C.Fn:Transmitter Custom Function Settings.	24-27
Reference	28-29
Troubleshooting Guide	30-31
Specifications.	32-33

Read this instruction manual while also referring to the instruction manuals of your camera and Speedlite.

Before using the transmitter, read this instruction manual and the instruction manuals of your camera and Speedlite to familiarize yourself with the operations.

Introduction

The YONGNUO Speedlite Transmitter YN-E3-RT is a transmitter for wireless flash shooting. It can control up to 5 groups (15 units) of Speedlites that have a wireless multiple flash shooting function using radio transmission. The transmitter also has dust and water resistance equivalent to EOS-1D series cameras.

- **Two-way 2.4G radio communication, fully compatible with ST-E3-RT/600EX-RT**

- 15 Physical Channels, 1 Auto Channel, Up to 10,000 customizable photographer ID

- **Transmission Range: 100M**

- Multi YN-E3-RT can share slave flashes

- Display group/charge status of slave flashes

- **Firmware can be upgraded via USB**

- High resolution Dot-Matrix LCD, Backlight for LCD/keys

- Fast lock mechanism

- **Built-in AF assist beam emitter**, buzzer

- Remote shutter release, Linked Shot (Need extra shutter cable for cameras released before 2012)

- **Flash Mode: E TTL/M/Multi/GR 4 flash modes**

- A/B/C/D/E 5 groups

- Supports 1st Curtain, **2nd Curtain (Only in M mode)**, High speed Sync

- Supports E TTL Ratio, Flash Exposure Compensation, Flash Exposure Lock, Flash Exposure Bracket, Modeling Flash

- 9 Custom Functions

- Settings saved automatically

Nomenclature

※The protective flim can be torn out.

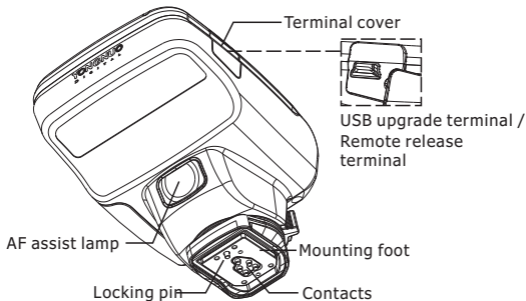
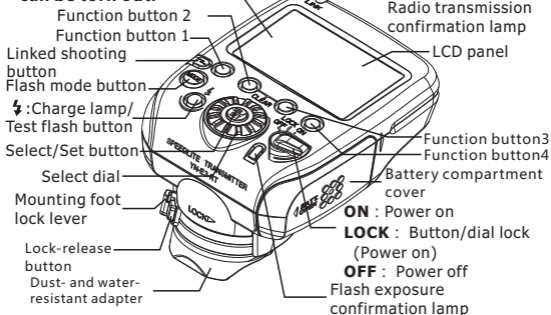

Nomenclature

E-TTL (II) Autoflash

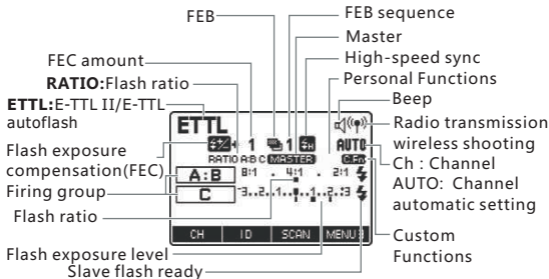

Manual flash

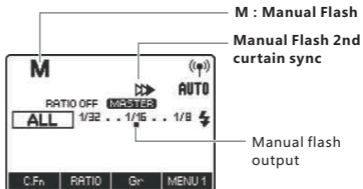

- The display will show only the settings currently applied.
- The functions displayed above function buttons 1 to 4, change according to the setting's status.
- When a button or dial is operated, the LCD panel illuminates.

Nomenclature

Multi(stroboscopic) flash

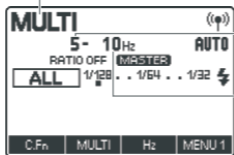

MULTI:

Multi flash

Number of flashes

Flash frequency

Group firing

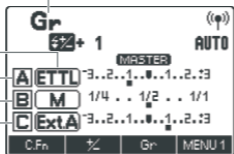

Gr : Group flash

Flash mode

Firing group

Linked shooting

LINKED SHOT:
Linked shooting

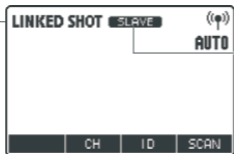

SLAVE

SLAVE

MASTER

MASTER

Preparation Before Use

1. Install two AA/LR6 batteries.

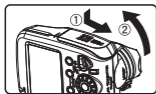

1. Open the cover: Slide the cover down as shown and open the battery compartment cover.

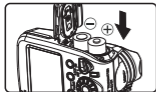

2. Install two AA batteries: Install two AA batteries according to the + and - marks, rechargeable batteries of 1.2V can be used.

3. Close the battery: Close the battery Compartment cover and slide it up.



- **Remove the batteries when the product is not used for long time. Please replace the both two batteries at the same time.**
- **When  is displayed, replace the batteries with new ones.**

2. Attaching and Detaching the Transmitter

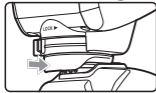

1. Attach the transmitter.

Slip the transmitter's mounting foot all the way into the camera's hot shoe.

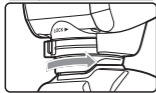

2. Secure the transmitter.

On the mounting foot, slide the lock lever to the right. When the lock lever clicks in place, it will be locked.

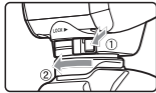

3. Detach the transmitter.

While pressing the lock-release button, slide the lock lever to the left and detach the transmitter.

- **Before attaching or detaching the transmitter, be sure to turn the transmitter power off.**

Preparation Before Use

3. Turning on the Power: Set the power switch to <ON>.

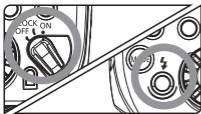

- The LCD panel illuminates.
- The charge lamp lights when the wireless shooting (slave) is ready.
- During wireless shooting, press the transmitter's charge lamp (test flash button) to fire a test flash.

About Auto Power Off

To save battery power, the power will turn off automatically after 5 min. of idle use. To turn on the transmitter again, press the camera's shutter button halfway, or press the test flash button (charge lamp).

About the Lock Function

By setting the power switch to <LOCK>, you can disable flash's button and dial operations. Use this to prevent the transmitter function settings from being accidentally changed after you set them.

If you operate a button or dial, <LOCKED> is displayed on the LCD panel .

About the LCD Panel Illumination

When a button or dial is operated, the LCD panel illuminates in green for 12 sec. When setting a function, the illumination continues until the setting is complete.

- **The transmitter settings are stored even when the power is turned off.**
- **You can fire a test flash even when the power switch is set to the <LOCK> position. Also, when a button or dial is operated, the LCD panel illuminates.**

Wireless Flash Shooting

Using a transmitter and a Speedlite compatible with radio transmission wireless shooting makes it easy to shoot with advanced wireless multiple flash lighting, in the same way as normal **E-TTL II/E-TTL** autoflash shooting.

The system is designed so that the settings of the transmitter attached to the camera (master) are automatically reflected on the Speedlite that is wirelessly controlled (slave). Therefore, you do not need to operate the slave unit while shooting.

The basic relative positions and operating range are as shown in the figure. You can then perform wireless **E-TTL II/E-TTL** autoflash shooting just by setting the master unit to **<ETTL>**.

Positioning and Operation Range

(Example of wireless flash shooting)

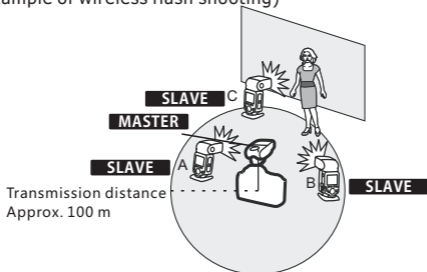

- Before shooting, perform a test flash (p.10) and test shooting.
- The transmission distance may be shorter depending on the conditions such as the positioning of slave units, the surrounding environment and weather conditions.

Wireless Settings

To avoid interference, Set the same channel and ID for both the master unit and slave unit.



Set a flash that is compatible with radio transmission wireless flash shooting as the slave unit. **For the slave unit settings, see the flash's instruction manual.**

Setting the Master Unit Transmission Channel / Wireless Radio ID.



1. Display < MENU3 >.

• Press function button 4 to display < MENU3 >.

2. Set a channel.

• Press function button 1 < CH >.
• Turn <  > to select "AUTO" or a channel from Ch. 1 to 15, and press the <  > button.

3. Set a wireless radio ID.

• Press function button 2 < ID >.
• Turn <  > to select the position(digit) or number to set, and press the <  > button.
• Press function button 4 <  > to return to the shooting-ready state.

➢ When transmission between the master unit and slave unit is established, the < LINK > lamp is lit in green. (Refer to page 26)

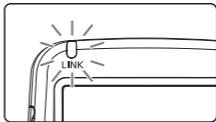
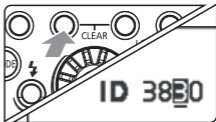
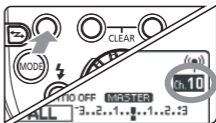

Wireless Settings

• Scanning the Master Unit Transmission Channels to Set

You can scan the radio reception status and set the master unit's transmission channel automatically or manually. When the channel is set to "AUTO", the channel with the best reception signal is automatically set. When setting the channel manually, you can set the transmission channel again while referring to the scan results.

Scanning while "AUTO" is set

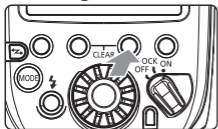

Run the scan.

- Press function button 4 to display < **MENU3** >.
- Press function button 3 < **SCAN** >.
- The channel is reset to one with a good reception signal.

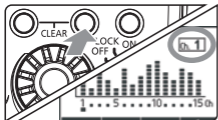

Scanning while Ch. 1 to 15 is set



1.Run the scan.

- Press function button 4 to display < **MENU3** >.
- Press function button 3 < **SCAN** >.
- The radio reception status is displayed in a graph.
- The higher the peak of the channel in the graph, the better the radio reception signal.

2.Set a channel.

- Turn <  > to select a channel from Ch1 to 15.
- Press the <  > button to set the channel and return to the shooting ready state.

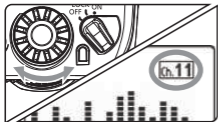

ETTL:Fully Automatic Wireless Flash Shooting

1. Set the flash as the slave unit A, B or C . The flash will not fire if it is set to D or E.

2. Set the same channel and ID of the master unit and slave unit .(p.8)

3. Position the camera and the flash.(p.7)

4. Press the <MODE> button on the master unit and set the flash mode to <ETTL>.

- The slave unit is set automatically to <ETTL> during shooting via the control from the master unit.

5. Check the transmission status and that the flash is ready.

- Check that the <LINK> lamp is lit in green.

- Check that the <⚡> slave flash-ready icon is lit on the master unit's LCD panel.

- When the recycling of all the flash units is completed, the master unit's charge lamp lights.

6. Check the operation.

- Press the master unit's test flash button (charge lamp). The slave unit flashes.

7. Take the picture.

- If a standard flash exposure was obtained, the flash exposure confirmation lamp lights for 3 sec.

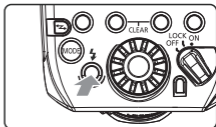
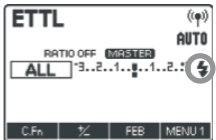
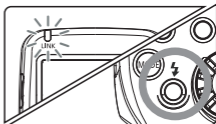
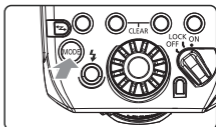
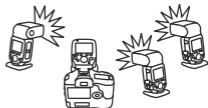

ETTL:Fully Automatic Wireless Flash Shooting

Support 1/3-stop increments to set FEC/FEB within ± 3 .

FEC (Flash Exposure Compensation)

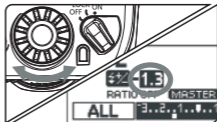
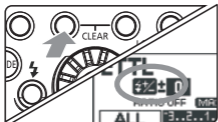

1. Press function button 4 to display **< MENU1 >**. Press function button 2 **< +/- >**. **< +/- >** is displayed and the FEC amount is highlighted.
 2. Turn **< [wheel] >** to set the flash exposure compensation amount, and press **< [wheel] >**. The FEC amount is set.
- **To cancel FEC, return the amount to "±0".**

FEB (Flash Exposure Bracketing)

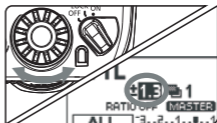
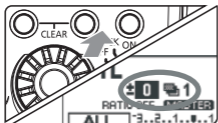

1. Press function button 4 to display **< MENU1 >**. Press function button 3 **< FEB >**. **< FEB >** is displayed and the FEB level display is highlighted.
 2. Turn **< [wheel] >** to set the FEB level, and press **< [wheel] >**. The FEB level is set.
- **When used together with flash exposure compensation, FEB shooting is performed based on the flash exposure compensation amount.**

ETTL:Fully Automatic Wireless Flash Shooting

High-speed Sync

With the high-speed sync function, the flash can synchronize with all shutter speeds. This is convenient when you want to use aperture-priority AE for fill-flash portraits of a subject.

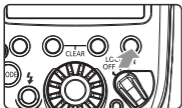

1.Display < MENU4 >.

Press function button 4 to display < MENU4 >.

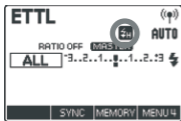

2.Display < ⚡H >.

- Press function button 2 < SYNC > to display < ⚡H >.
- Check that < ⚡H > is lit in the viewfinder.

FEL : FE Lock

FE (Flash Exposure) lock locks the correct flash exposure setting for any part of the scene.

Perform FE lock by operating the camera. For the operations, see the camera and flash's instruction manual.

About Master Units

You can use two or more master units (master units + slave units =maximum of 16 units). By preparing multiple cameras with master units attached, you can shoot by changing cameras while keeping the same lighting (slave units).

Note that when using two or more master units, the color of the <LINK> lamp varies depending on the order in which the power was turned on. The first master (main master) is green and the second and subsequent masters (sub-masters) are orange.

ETTL: Wireless Multiple Flash Shooting with Flash Ratio

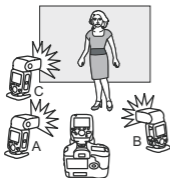

The exposure is controlled automatically so that the total flash output of firing groups results in the standard exposure.

1. Set the firing group of the slave units.

- Operate and set the slave units one by one.

2. Press the master unit's function button 4 to display



< **MENU2** >.

3. Press function button 2

< **RATIO** > and set to < **A:B** > or < **A:BC** >.

4. Set the flash ratio. Press function button 3 < **Gr** >.

- Press function button 3 < **A:B** > or < **C** >.

- Turn <  > to set the flash ratio or the flash exposure, and press the <  > button.

- Press function button 4 <  > to return to the shooting-ready state.

5. Take the picture.

The slave units flash at the set flash ratio.

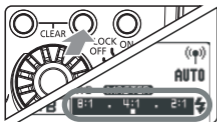
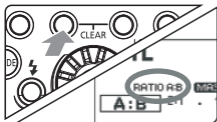
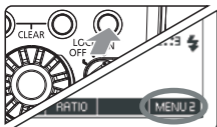

ETTL: Wireless Multiple Flash Shooting with Flash Ratio

Slave Group Control

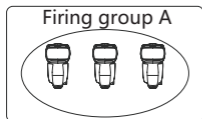

If you need more flash output or wish to perform more sophisticated lighting, you can increase the number of slave units.

Simply set an additional slave unit to the firing group (A, B or C) whose flash output you want to increase. You can increase the number of slave units up to 15 units in total.

For example, if you set a firing group with three slave units to <A>, the three units are controlled as a single firing group A with a large flash output.

- To fire the three firing groups A, B and C at the same time, set <A:B:C>. With the < A:B > setting, firing group C does not fire.
- If you shoot with firing group C pointing directly toward the main subject, overexposure may result.
- The flash ratio of 8:1 to 1:1 to 1:8 is equivalent to 3:1 to 1:1 to 1:3 (1/2-stop increments) when converted to number of stops.
- The details of the flash ratio settings are as follows.

8:1 ● 4:1 ● 2:1 ● 1:1 ● 1:2 ● 1:4 ● 1:8
 | | | | | | |
5.6:1 2.8:1 1.4:1 1:1.4 1:2.8 1:5.6

Modeling Flash

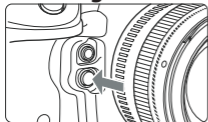

Modeling Flash from a Master Unit

- Press the depth-of-field preview button on the camera.
- The flash fires continuously for 1 sec.

M: Wireless Multiple Flash Shooting with Manual Flash Output

This describes wireless (multiple flash) shooting using manual flash. You can shoot with a different flash output setting for each slave unit (firing group). Set all parameters on the master unit.

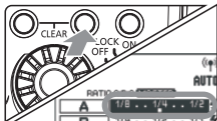
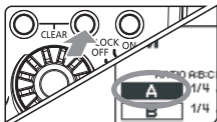
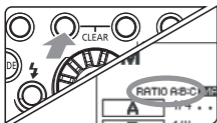

1. Set the flash mode to <M>.

2. Set the number of firing groups.

- While < **MENU1** > is displayed, press function button 2 < **RATIO** > and set the groups to fire.

- The setting changes as follows each time you press the button:

ALL (< **RATIO OFF** >) →

A/B (< **RATIO A:B** >) →

A/B/C (< **RATIO A:B:C** >)



3. Select a firing group.

- Press function button 3 < **Gr** > ,

- turn <  > and select the group for which you want to set the flash output.

4. Set the flash output.

- Press function button 3 <  > .

- Turn <  > to set the flash output, and press the <  > button.

- Repeat steps 3 and 4 to set the flash output of all groups.

5. Take the picture.

- Each group fires at the set flash output.

- When ALL < **RATIO OFF** > is set, set A, B or C as the firing group for the slave units. The flash will not fire if it is set to D or E.

- To fire multiple slave units with the same flash output, select ALL < **RATIO OFF** > in step 2.

M:The shutter sync of manual flash setting

You can use 1st curtain Sync, high-speed Sync, or 2nd curtain sync in manual flash.

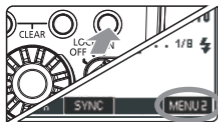

1. Display < MENU2 >.

Press function button 4 to display < MENU2 >.

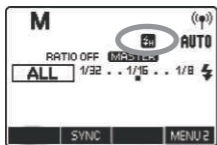

2. Shutter Sync setting

While < MENU2 > is displayed, press function button 2 < SYNC > and set the shutter sync.

• The setting changes as follows each time you press the button:

 : High-speed Sync

 : 2nd Curtain Sync

(no icon): 1st Curtain Sync

• The 2nd curtain sync can be used in manual flash only.

• When using the 2nd curtain sync, wireless settings and other parameters recommend using the speedlite transmitter settings.

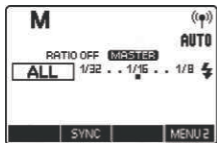
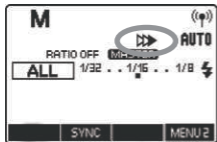

MULTI: Stroboscopic Flash

In stroboscopic flash, set the flash output, number of flashes, and flash frequency (number of flashes per second = Hz).

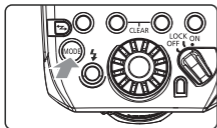

1. Set the flash mode to <MULTI>.

- Press the <MODE> button on the master unit and set to <MULTI>.

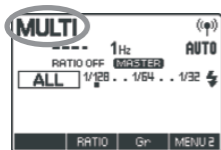



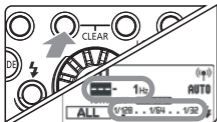

2. Set the firing groups and the flash output.

- Set the number of firing groups and the flash output for each group by referring to the manual flash on the preceding page.



3. Set the flash frequency and the number of flashes.

- While < MENU1 > is displayed, perform the following procedure.
- To set the number of flashes, press function button 2 < MULTI >, turn <  > and select <  >.
- To set the flash frequency, press function button 3 < Hz >, turn <  > and select <  >.

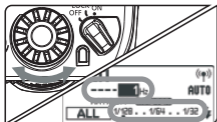

Gr: Shooting with a Different Flash Mode for Each Group

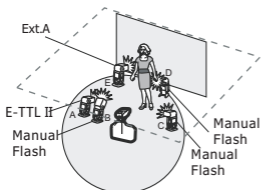

*** The flash mode settings are indicated only as an example.**

- You can shoot with a different flash mode set for each firing group, with up to 5 groups (A/B/C/D/E).
- The flash modes that can be set are E-TTL II/E-TTL autoflash, Manual flash and Auto external flash metering.
- This function is for advanced users who are very knowledgeable and experienced in lighting.

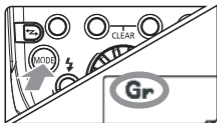

1. Set the flash mode to <Gr>.

- Press the <mode> button on the master unit and set the flash mode to <Gr>.

2. Set the firing group on the slave units.

- Operate and set the slave units one by one.
- Set a firing group (A/B/C/D/E) for all the slave units.

• When using the <Gr> flash mode of the camera released from 2007 to 2011, all the parameters should be set up through the speedlite transmitter.

Gr: Shooting with a Different Flash Mode for Each Group

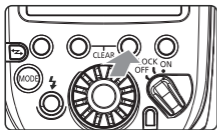

3. Set the flash mode of each firing group by operating the master unit.

- While **< MENU1 >** is displayed, press function button 3 **< Gr >** and turn **< [Globe Icon] >** to select the group.
- Press function button 2 **< *MODE >** and select the flash mode of the selected group from **< E-TTL >**, **< M >** and **< Ext.A >**.
- To turn the firing of the selected group off, press function button 1 **< ON/OFF >** to set it to **< OFF >**.

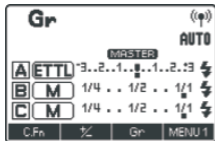

4. Set the flash output or flash exposure compensation amount.

- While a firing group is selected, press function button 3 **< *Fn >**.
- Turn **< [Globe Icon] >** to set the flash function corresponding to the flash mode, and press **< [Globe Icon] >**.
- When using the **< M >** mode, set the flash output. When using the **< E-TTL >** or **< Ext.A >** mode, set the flash exposure compensation amount as required.
- If you press function button 2 **< MENU1 >** when **< +/- >** is displayed, flash exposure compensation can be set for all the firing groups.

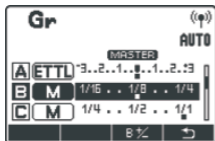
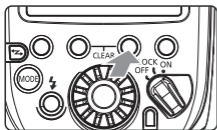

Remote Release from a Slave Unit/Linked Shooting

Remote Release from a Slave Unit*



You can perform remote release (remote control shooting) from a flash set as a slave unit. (see the flash's instruction manual).

Linked shooting*

Linked shooting is a function that automatically releases the shutter of a slave unit camera by linking it to a master unit camera. You can shoot with linked shooting for up to 16 units, including both master units and slave units. This is convenient when you want to shoot a subject from multiple angles at the same time.

To shoot with linked shooting, attach a flash that supports radio transmission wireless shooting or the Speedlite Transmitter YN-E3-RT to the camera.

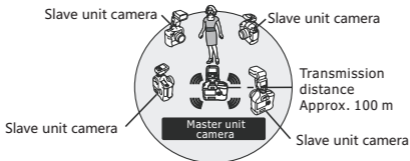

***When using the function with the cameras released until 2011, it needs the shutter release cable LS-MINIB/C3 or LS-MINIB/C1(sold separately). As for the EOS digital cameras(such as EOS-1D X) released after 2012, it does not need the shutter release cable.**

Linked Shooting

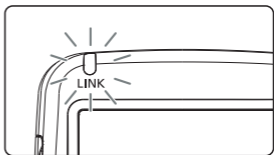

1. Set to linked shooting mode.

- Press the <LINK> button continuously until <LINKSHOT> is displayed on the LCD panel. Linked shooting mode's "Slave unit" is set.
- Press the <LINK> button again to set "Master unit" of the linked shooting mode.

2. Set the channel and ID.

3. Set the camera's shooting functions.

4. Set all the transmitters or flash.

- Repeat steps 1 to 3 and set all the transmitters or flashes to "Master unit" or "Slave unit" in the linked shooting mode.
- When pressing the <LINK> button to change the setting of a unit from "Slave unit" to "Master unit," the other transmitters (or Speedlites) that were set to "Master unit" until then automatically switch to "Slave unit" .

5. Set up the slave unit cameras.

- Check that the <LINK> lamp of the slave unit is lit in green.

6. Take the picture.

- Check that the <LINK> lamp of the master unit is lit in green and take the picture.
- The slave unit cameras are released in coordination with the master unit camera.
- After shooting with linked shooting, the <LINK> lamp of the slave unit is briefly lit in orange.

Transmitter Control from Camera's Menu Screen

When using EOS digital cameras released since 2007, you can set flash functions, transmitter functions or Custom Functions from the camera's menu screen. See the camera's instruction manual.

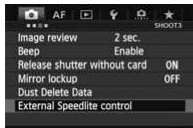

1. Select [External Speedlite control].

- Select [External Speedlite control] or [Flash control].

2. Select [Flash function settings].

- Select [Flash function settings] or [External flash func. setting].
- The screen changes to the (external) flash function settings screen.

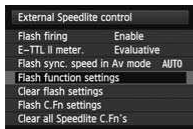

3. Set the function.

- The setting screen varies depending on the camera.
- Select an item and set the

Settings Available in [Flash function settings]

EOS digital cameras released since 2012

When using the transmitter with cameras such as EOS-1D X, you can set the functions for "Radio transmission wireless shooting" in the [Flash function settings] screen.

EOS digital cameras released from 2007 to 2011

When performing "Radio transmission wireless shooting", set the functions by operating the transmitter.

Transmitter Control from Camera's Menu Screen

E-TTL II flash metering

For normal exposures, set it to [Evaluative]. If [Average] is set, the flash exposure will be averaged for the entire scene metered by the camera. Flash exposure compensation may be necessary depending on the scene. This setting is for advanced users.

Flash synchronization speed in Av mode

You can set the flash sync speed when performing wireless flash shooting in aperture-priority AE (**AV**) mode.

Flash mode

You can select the flash mode from [E-TTL II], [Manual flash], [MULTI flash] and [Individual group control] to suit your desired flash shooting.

Shutter synchronization

You can select the flash firing timing/method from [1st curtain] and [High-speed synchronization]. To perform normal wireless flash shooting, set it to [1st curtain].

Flash exposure compensation

In the same way as normal exposure compensation, you can set exposure compensation for flash. The flash exposure compensation amount can be set up to ± 3 stops in 1/3-stop increments.

FEB

You can take three shots while automatically changing the flash output. The settable range is up to ± 3 stops in 1/3-stop increments.

Wireless flash functions (setting)

Radio transmission wireless flash shooting is set automatically.

Clear Speedlite (function) settings

You can return the transmitter settings to their default settings.

Transmitter Custom Function Settings

The displayed contents vary depending on the camera. If C.Fn-20 and 22 are not displayed, set them by operating the transmitter. For the Custom Functions, see pages 26 to 27.

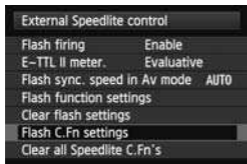

1. Select [Flash C.Fn settings].

- Select [Flash C.Fn settings] or [External flash C.Fn setting].
- You can now set the Custom Functions of the transmitter.

2. Set the Custom Function.

- Select the Custom Function number and set the function.
- To clear all the Custom Function settings, select [Clear all Speedlite C.Fn's] or [Clear ext. flash C.Fn set.] in step 1.

C.Fn: Setting Custom Functions

You can customize the transmitter features to suit your shooting preferences with Custom Functions and Personal Functions.

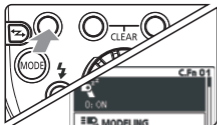





1. Display the Custom Functions screen.

- Press function button 1 < **C.Fn** > . The Custom Functions screen is displayed.









2. Select an item to set.

- Turn <  > to select an item (number) to set.

3. Change the setting.

- Press the <  > button. The setting is displayed. Turn <  > to select the setting that you want, and press the <  > button.
- Press function button 4 <  > to return to the shooting-ready state.

Custom Function List

Number	Icon	Custom Functions	Page
C.Fn-01		Auto power off	P.26
C.Fn-02	 MODELING	Modeling flash	
C.Fn-03	 AUTO CANCEL	FEB auto cancel	
C.Fn-04		FEB sequence	
C.Fn-07	 TEST	Test firing with autoflash	P.27
C.Fn-08	 AF	AF Assist Beam Emitter	
C.Fn-13		Flash exposure metering setting	
C.Fn-20		Beep	
C.Fn-22		LCD panel illumination	

C.Fn: Setting Custom Functions

C.Fn-01: (Auto power off)

When the transmitter is not operated for 5 min., the power turns off automatically to save energy. You can disable this function.

0: ON (Enabled)

1: OFF (Disabled)



C.Fn-02: MODELING (Modeling flash)

0:  (Enabled (Depth-of-field preview button))

Press the camera's depth-of-field preview button to fire the modeling flash.

1:  (Enabled (Test firing button))

Press the transmitter's test flash button to fire the modeling flash.

2:  /  (Enabled (with both buttons))

Press the camera's depth-of-field preview button or the transmitter's test flash button to fire the modeling flash.

3: OFF (Disabled)

Disables the modeling flash.

C.Fn-03: AUTO CANCEL (FEB auto cancel)

You can set whether or not to cancel FEB automatically after shooting three shots with FEB.

0: ON (Enabled)

1: OFF (Disabled)

C.Fn-04: (FEB sequence)

You can change the order of the FEB sequence, 0: Standard exposure, -: Decreased exposure (darker) and +: Increased exposure (brighter).

0: 0 → - → +

1: - → 0 → +

C.Fn: Setting Custom Functions

C.Fn-07: TEST (Test firing with autoflash)

You can change the flash output when firing the test flash in E-TTL II/E-TTL autoflash mode.

0: 1/32 (1/32)

1: 1/1 (Full output)

C.Fn-08: AF (AF-assist beam firing)



0: ON (Enabled)

1: OFF (Disabled) The AF-assist beam is not fired from the speedlite transmitter

C.Fn-13: (Flash exposure metering setting)

0:  +  (Speedlite button and dial)

1:  (Speedlite dial only)

You can perform flash exposure compensation by directly turning <  >, without pressing the <  > button.

C.Fn-20: (Beep)

You can enable a beep to sound when the slave units are fully charged.

0: OFF (Disabled)

1: ON (Enabled)

C.Fn-22: (LCD panel illumination)

When a button or dial is operated, the LCD panel illuminates. You can change this illumination setting.

0: 12sec (On for 12 sec.)

1: OFF (Disable panel illumination)

2: ON (Illumination always on)

Reference

About the <LINK> Lamp

The color of the <LINK> lamp changes depending on the transmission status of the master unit and the slave unit.

Color	Status	Description	Action
Green	Lit	Transmission OK	-
Red	Lit	Not connected	Check the channel and ID
	Blinking	Too many units	Master units + slave units = 16 units or less
		Error	Turn the power off and on again

- **If the transmission channels of the master unit and slave unit are**
- **different, the slave unit does not fire. Set both to the same number, or set both to "AUTO".**

Clearing Transmitter Settings

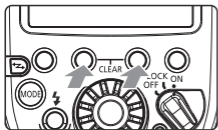

Press function buttons 2 and 3 simultaneously for 2 seconds or longer. The transmitter settings are cleared and the shooting mode returns to <ETTL> flash mode.

Reference

AF Assist Beam Emitter

When using AF under low-light, the built-in AF-assist beam emitter of the speedlite transmitter will be emitted automatically to make it easier to autofocus.

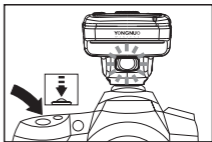

- **It needs using single autofocus for the lens.**
- **Enable or disable the AF assist Beam Emitter function through the camera menu custom function (P.24) or speedlite transmitter custom function (P. 25)(C.Fn8).**

Firmware Update

1. Log in the YONGNUO official website (www.hkyongnuo.com) to download the firmware update software and the latest firmware.
2. Power off, use USB-MINIB cable connect to PC.
3. Press the <MODE> button and set the power switch to <ON>, the screen will enter into firmware upgrade interface.
4. Complete the firmware upgrade operation according to the prompt of software.

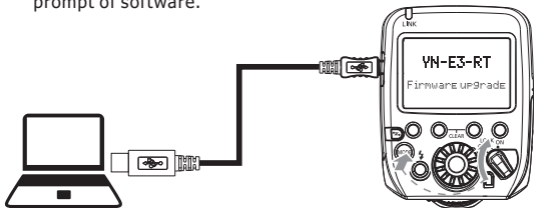

Troubleshooting Guide

Power does not turn on.

- Make sure that the batteries are installed in the correct orientation.
- Insert the mounting foot into the camera's hot shoe all the way, slide the lock lever to the right, and secure the transmitter to the camera .
- If the electrical contacts of the transmitter and camera are dirty, clean the contacts.
- The charge lamp lights when the wireless shooting (slave) is ready.

The power turns off by itself.

- The transmitter' s auto power off function has activated. Press the shutter button halfway, or press the test flash button .

The slave unit does not fire.

- Check that the slave unit supports radio transmission wireless flash shooting.
- Set the slave unit to < (☑) > < **SLAVE** >.
- Set the transmission channels and wireless radio IDs of the master unit and slave unit to the same numbers.
- Check that the slave unit is within the transmission range of the master unit.

Unable to use the AF assist beam emitter.

- Check the custom function C.Fn08.

Firmware update failed or the screen display the firmware upgrade interface all along.

- Disconnect, restart the equipment and try again.

The screen displays "ERROR: 2001"

- Try upgrade the firmware again.

Troubleshooting Guide

The picture is underexposed or overexposed.

- If there was a highly reflective object (glass window, etc.) in the picture, use FE lock).
- If the subject looks very dark or very bright, set flash exposure compensation.
- When high-speed sync is set, the effective flash range is shorter.

Position the slave unit closer to the subject.

- When using autoflash shooting with three firing groups A, B and C, do not fire with firing group C pointed toward the main subject.
- When shooting with a different flash mode setting for each firing group, do not fire with multiple firing groups set to <E-TTL> or <Ext.A> pointed toward the main subject .

The picture is very blurred.

- When the shooting mode is set to <AV> and the scene is dark, slow sync is enabled automatically (the shutter speed becomes slower). Use a tripod, or set the shooting mode to <P> or fully automatic mode. Note that you can also set the sync speed in [**Flash sync. speed in Av mode**]

Cannot release from a slave unit.

- When an EOS camera which was released up to 2011, has remote control terminal and is compatible with E-TTL II/E-TTL autoflash is used to perform remote release from a slave unit or when it has been set as the slave unit during linked shooting, the shutter release cable “LS-MINIB/C3 ” or “LS-MINIB/C1 ” (sold separately) is necessary.

Specifications

Type:	On-camera Speedlite transmitter
Compatible cameras:	EOS type-A camera compatible with E-TTL II/E-TTL autoflash
Exposure control system:	E-TTL II/E-TTL autoflash, manual flash, stroboscopic flash, auto external flash metering* *Only when the flash mode is set to <Gr>
Frequency:	2405 - 2475 MHz
Modulation system:	Primary modulation: OQPSK, secondary modulation: DS-SS
Channel:	Auto, Ch. 1 - 15
Wireless radio ID:	0000 - 9999
Slave unit control:	Up to 5 groups (A/B/C/D/E), up to 15 units
Transmission distance:	Approx. 100 m
Flash ratio control:	1:8 - 1:1 - 8:1, 1/2-stop increments
Flash exposure compensation:	±3 stops in 1/3- increments
FEB:	±3 stops in 1/3- increments (when used with flash exposure compensation)
FE lock:	Press the camera's <M-Fn>, <FEL> or <*> button
High-speed sync:	Provided
Manual flash:	1/1 - 1/128 power (1/3-stop increments)
Stroboscopic flash:	Provided (1 - 500 Hz)

Specifications

Slave flash battery check:	On the master unit's LCD panel, the < ⚡ > icon lights, the slave unit's AF-assist beam emitter blinks and the charge lamp lights.
Flash exposure confirmation:	Flash exposure confirmation lamp lights
Modeling flash:	Fired with camera's depth-of-field preview button
Linked shooting:	Provided
Custom Functions:	9
AF assist Beam Emitter :	Provided
Firmware update :	Provided
Power source:	2 AA/LR6 alkaline batteries Ni-MH batteries
Wireless flash shooting time	Approx. time:10 continuous hours* *When using AA/LR6 alkaline batteries
Power saving:	Power off after 5 min. of idle operation
Dimensions:	Approx. 67.7 (W) x 66.7 (H) x 81.3 (D) mm
Weight:	Approx. 110 g (transmitter only, excluding batteries)

The functions of this user manual are based on test conditions of our company. Further notice will not be given if the design and specifications change.

The YONGNUO logo in this manual includes the registered trademark or trademark of Shenzhen Yongnuo Photography Equipment Co., Ltd in China or/and other countries(regions). All other trademarks are the property of their respective owners.

YONGNUO
DIGITAL

产品保修卡
Warranty card

序列号

SN.

产品名称

Product Model

购买日期

Purchase Date

用户名称

Name

联系电话

Phone

地址

Address

邮编

Zip Code

故障说明

Failure Description

深圳市永诺摄影器材股份有限公司

地址:深圳市华强北路赛格科技园二栋西A511室

售后服务: 400-001-3888

TEL:(86) 755-837-62448

Website:www.hkyongnuo.com

Email:service@hkyongnuo.com