

USER'S MANUAL



Notice

The company reserves the right to revise this publication or to change its contents without notice. Information contained herein is for reference only and does not constitute a commitment on the part of the manufacturer or any subsequent vendor. They assume no responsibility or liability for any errors or inaccuracies that may appear in this publication nor are they in anyway responsible for any loss or damage resulting from the use (or misuse) of this publication.

This publication and any accompanying software may not, in whole or in part, be reproduced, translated, transmitted or reduced to any machine readable form without prior consent from the vendor, manufacturer or creators of this publication, except for copies kept by the user for backup purposes.

Brand and product names mentioned in this publication may or may not be copyrights and/or registered trademarks of their respective companies. They are mentioned for identification purposes only and are not intended as an endorsement of that product or its manufacturer.

©September 2010

Trademarks

Intel, **Celeron**, and **Intel Core** are trademarks/registered trademarks of Intel Corporation.

Preface

R&TTE Directive

This device is in compliance with the essential requirements and other relevant provisions of the R&TTE Directive 1999/5/EC.

This device will be sold in the following EEA countries: Austria, Italy, Belgium, Liechtenstein, Denmark, Luxembourg, Finland, Netherlands, France, Norway, Germany, Portugal, Greece, Spain, Iceland, Sweden, Ireland, United Kingdom, Cyprus, Czech Republic, Estonia, Hungary, Latvia, Lithuania, Malta, Slovakia, Poland, Slovenia.

CE Marking

This device has been tested to and conforms to the regulatory requirements of the European Union and has attained CE Marking. The CE Mark is a conformity marking consisting of the letters “CE”. The CE Mark applies to products regulated by certain European health, safety and environmental protection legislation. The CE Mark is obligatory for products it applies to: the manufacturer affixes the marking in order to be allowed to sell his product in the European market.

This product conforms to the essential requirements of the R&TTE directive 1999/5/EC in order to attain CE Marking. A notified body has determined that this device has properly demonstrated that the requirements of the directive have been met and has issued a favorable certificate of expert opinion. As such the device will bear the notified body number 0560 after the CE mark.

The CE Marking is not a quality mark. Foremost, it refers to the safety rather than to the quality of a product. Secondly, CE Marking is mandatory for the product it applies to, whereas most quality markings are voluntary.

FCC Statement (Federal Communications Commission)

You are cautioned that changes or modifications not expressly approved by the party responsible for compliance could void the user's authority to operate the equipment.

This equipment has been tested and found to comply with the limits for a Class B digital device, pursuant to Part 15 of the FCC Rules. These limits are designed to provide reasonable protection against harmful interference in a residential installation. This equipment generates, uses and can radiate radio frequency energy and, if not installed and used in accordance with the instructions, may cause harmful interference to radio communications. However, there is no guarantee that interference will not occur in a particular installation. If this equipment does cause harmful interference to radio or television reception, which can be determined by turning the equipment off and on, the user is encouraged to try to correct the interference by one or more of the following measures:

- Re orient or relocate the receiving antenna.
- Increase the separation between the equipment and receiver.
- Connect the equipment into an outlet on a circuit different from that to which the receiver is connected.
- Consult the service representative or an experienced radio/TV technician for help.

Operation is subject to the following two conditions:

1. This device may not cause interference.
And
2. This device must accept any interference, including interference that may cause undesired operation of the device.

FCC RF Radiation Exposure Statement:

1. This Transmitter must not be co-located or operating in conjunction with any other antenna or transmitter.
2. This equipment complies with FCC RF radiation exposure limits set forth for an uncontrolled environment. This equipment should be installed and operated with a minimum distance of 20 centimeters between the radiator and your body.



Warning

Use only shielded cables to connect I/O devices to this equipment. You are cautioned that changes or modifications not expressly approved by the manufacturer for compliance with the above standards could void your authority to operate the equipment.

IMPORTANT SAFETY INSTRUCTIONS

Follow basic safety precautions, including those listed below, to reduce the risk of fire, electric shock, and injury to persons when using any electrical equipment:

1. Do not use this product near water, for example near a bath tub, wash bowl, kitchen sink or laundry tub, in a wet basement or near a swimming pool.
2. Avoid using this equipment with a telephone line (other than a cordless type) during an electrical storm. There may be a remote risk of electrical shock from lightning.
3. Do not use the telephone to report a gas leak in the vicinity of the leak.
4. Use only the power cord and batteries indicated in this manual. Do not dispose of batteries in a fire. They may explode. Check with local codes for possible special disposal instructions.
5. This product is intended to be supplied by a Listed Power Unit (Full Range AC/DC Adapter – AC Input 100 - 240V, 50 - 60Hz, DC Output 19V, 4.74A).

This Computer's Optical Device is a Laser Class 1 Product

Instructions for Care and Operation



The computer is quite rugged, but it can be damaged. To prevent this, follow these suggestions:

1. **Don't drop it, or expose it to shock.** If the computer falls, the case and the components could be damaged.
2. **Keep it dry, and don't overheat it.** Keep the computer and power supply away from any kind of heating element. This is an electrical appliance. If water or any other liquid gets into it, the computer could be badly damaged.
3. **Avoid interference.** Keep the computer away from high capacity transformers, electric motors, and other strong magnetic fields. These can hinder proper performance and damage your data.
4. **Follow the proper working procedures for the computer.** Shut the computer down properly and don't forget to save your work. Remember to periodically save your data as data may be lost.
5. **Take care when using peripheral devices.**

Power Safety

The computer has specific power requirements:

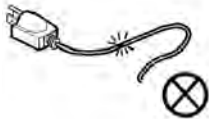
- When you want to unplug the power cord, be sure to disconnect it by the plug head, not by its wire.
- Make sure the socket and any extension cord(s) you use can support the total current load of all the connected devices.
- Before cleaning the computer, make sure it is disconnected from any external power supplies.

<p><i>Do not plug in the power cord if you are wet.</i></p> 	<p><i>Do not use the power cord if it is broken.</i></p> 	<p><i>Do not place heavy objects on the power cord.</i></p> 
---	--	--



Power Safety Warning

Before you undertake any upgrade procedures, make sure that you have turned off the power, and disconnected all peripherals and cables (including telephone lines).

Preface

Cleaning

Do not apply cleaner directly to the computer, use a soft clean cloth.

Do not use volatile (petroleum distillates) or abrasive cleaners on any part of the computer.

Servicing

Do not attempt to service the computer yourself. Doing so may violate your warranty and expose you and the computer to electric shock. Refer all servicing to authorized service personnel. Unplug the computer from the power supply. Then refer servicing to qualified service personnel under any of the following conditions:

- When the power cord is damaged or frayed.
- If the computer has been exposed to any liquids.
- If the computer does not work normally when you follow the operating instructions.
- If the computer has been dropped or damaged (do not touch the poisonous liquid if the LCD panel breaks).
- If there is an unusual odor, heat or smoke coming from your computer.



Removal Warning

When removing any cover(s) and screw(s) for the purposes of device upgrade, remember to replace the cover(s) and screw(s) before turning the computer on.

Ergonomics

We designed your Multimedia PC system to be functional as well as attractive. To get most out of it, here are some suggestions on how to position and use the computer:

- The top third of the LCD (screen) should be at eye-level or slightly below.
- The LCD should be at least 18"/45cm. directly in front of you.
- If the screen resolution makes you strain to read, then adjust the resolution to something more comfortable (see *“Video Features” on page 1 - 15*).
- Angle the LCD (see *“Tilting the LCD Screen” on page 1 - 6*) so that it doesn’t reflect any light into your eyes.
- Use a chair which offers good back support (especially lower-back). The seat should allow your feet to rest flat on the floor or on a footrest directly in front of you.
- If possible, illuminate your work area with natural daylight or use a steady-glowing (non-flickering) light source.
- Place the keyboard and mouse so that your arms are at your sides and your forearms are roughly parallel to the floor. Your wrists should flex slightly downward as you work. Your neck and shoulders should also be relaxed.
- Take a break from the computer. Get up, stretch, flex your wrists, walk about, and look at something else for about 10 minutes every hour.

Preface

Lighting

Proper lighting and comfortable display viewing angle can reduce eye strain and muscle fatigue in your neck and shoulders.

- Position the display to avoid glare or reflections from overhead lighting or outside sources of light.
- Keep the display screen clean and set the brightness and contrast to levels that allow you to see the screen clearly.
- Position the display directly in front of you at a comfortable viewing distance.
- Adjust the display-viewing angle to find the best position.

LCD Screen Care

To prevent **image persistence** on LCD monitors (caused by the continuous display of graphics on the screen for an extended period of time) take the following precautions:

- Set the *Windows* **Power Plans** to turn the screen off after a few minutes of screen idle time.
- Use a rotating, moving or blank screen saver (this prevents an image from being displayed too long).
- Rotate desktop background images every few days.
- Turn the monitor off when the system is not in use.



Carrying the Computer

We strongly recommend using both hands to move the computer (one hand gripping the handle area and the other gripping the computer) to avoid accidentally dropping it. Be careful that objects such as belt buckles etc. do not scratch the screen while it is being carried.

Wall Mounting Information

The computer may be mounted on a wall for display. The system meets VESA (FDMI) Standard (100mm * 100mm) for wall mounting. However if you intend to wall mount the system please contact your service center for information in order to avoid personal injury, or damage to the computer.

Contents

Notice	I	HDMI-In Port	1-11
FCC Statement	III	Mode Toggle	1-11
FCC RF Radiation Exposure Statement:	IV	System Map: Right View	1-12
Instructions for Care and Operation	VI	System Map: Rear View	1-13
Power Safety	VII	Windows 7 Start Menu & Control Panel	1-14
Cleaning	VIII	Video Features	1-15
Servicing	VIII	Power Options	1-17
Ergonomics	IX		
Wall Mounting Information	XI		
Quick Start Guide			
Overview	1-1		
Advanced Users	1-2		
Beginners and Not-So-Advanced Users	1-2		
Warning Boxes	1-2		
Not Included	1-3		
System Startup	1-4		
System Map: Front View	1-5		
Tilting the LCD Screen	1-6		
Keyboard Options	1-7		
LED Indicators & Buttons	1-8		
On Screen Display Indicators	1-9		
System Map: Left View	1-10		
		Features & Components	
		Overview	2-1
		Hard Disk Drive	2-2
		Optical (CD/DVD) Device	2-3
		Loading Discs	2-3
		Handling CDs or DVDs	2-4
		DVD Regional Codes	2-5
		Multi-in-1 Card Reader	2-6
		ExpressCard Slot	2-7
		Inserting and Removing ExpressCards	2-7
		Audio Features	2-8
		Adding a Printer	2-10
		USB Printer	2-10
		Parallel Printer	2-10

Power Management

Overview	3-1
Turning On the Computer	3-2
Power Plans	3-3
Power-Saving States	3-5
Sleep	3-5
Hibernate	3-6
Shut down	3-6
Configuring the Power Buttons	3-7
Resuming Operation	3-8

Drivers & Utilities

What to Install	4-1
Module Driver Installation	4-1
Driver Installation	4-2
Updating/Reinstalling Individual Drivers	4-4
User Account Control	4-4
Windows Security Message	4-4
New Hardware Found	4-5
Driver Installation Procedure	4-5
Chipset	4-5
Video	4-5
LAN	4-5
ExpressCard/Card Reader	4-6
On Screen Display	4-6

USB 3.0	4-6
Intel MEI Driver	4-6
Audio	4-6
Windows Experience Index	4-7
Optional Drivers	4-8
PC Camera Module	4-8
Wireless LAN Module	4-8
Bluetooth Module	4-8
Touch Screen Module	4-8

BIOS Utilities

Overview	5-1
The Power-On Self Test (POST)	5-2
Failing the POST	5-3
Fatal Errors	5-3
Non-Fatal Errors	5-3
The Setup Utility	5-4
Entering Setup	5-4
Setup Screens	5-5
Main Menu	5-6
System Time & Date (Main Menu)	5-6
SATA Port 1/2/3/4 (Main Menu)	5-7
System/Extended Memory (Main Menu)	5-7
BIOS Revision/KBC/	
EC Firmware Revision (Main Menu)	5-7

Advanced Menu	5-8
Advanced Chipset Control (Advanced Menu)	5-8
Total Graphics Memory (Advanced Menu > Advanced Chipset Control)	5-9
SATA Mode (Advanced Menu)	5-9
Legacy USB Support: (Advanced Menu)	5-9
Boot-time Diagnostic Screen (Advanced Menu)	5-9
Legacy OS Boot (Advanced Menu)	5-10
Power On Boot Beep (Advanced Menu)	5-10
Security Menu	5-11
Set Supervisor Password (Security Menu)	5-11
Set User Password (Security Menu)	5-12
Password on boot: (Security Menu)	5-12
Boot Menu	5-13
Exit Menu	5-14

Upgrading The Computer

Overview	6-1
When Not to Upgrade	6-2
Removing the Rear Top Cover	6-3
Wireless Keyboard & Mouse USB Transceiver	6-5
Upgrading the Hard Disk Drive	6-6
Upgrading the System Memory (RAM)	6-8
Upgrading the Processor	6-11

Modules & Options

Overview	7-1
PC Camera Module	7-2
PC Camera Driver Installation	7-2
PC Camera Audio Setup	7-3
Wireless LAN Module	7-9
802.11b/g/n Driver Installation	7-9
Connecting to a Wireless Network in Windows 7	7-10
Windows Mobility Center	7-13
Bluetooth & WLAN Combo Module	7-14
Bluetooth Combo Driver Installation	7-15
Bluetooth & WLAN Combo Settings	7-16
Bluetooth Networking Setup	7-19
Bluetooth & WLAN Combo Module Configuration ...	7-20
Touch Screen Module	7-23
Touch Screen Driver Installation	7-23
TV Tuner Module	7-28
TV Recording and Power Plans	7-30
Remote Control Unit	7-30

Troubleshooting

Overview	8-1
Basic Hints and Tips	8-2
Backup and General Maintenance	8-3
Viruses	8-4

Preface

Upgrading and Adding New Hardware/Software	8-5
Problems & Possible Solutions	8-7
Bluetooth Connection Problems	8-10
Wake On LAN Setup	8-14

Interface (Ports & Jacks)

Overview	A-1
Computer Ports and Jacks	A-2
Card Reader Port	A-2
COM/Serial Ports	A-2
DC-In Jack	A-2
e-SATA Port	A-2
External Monitor (VGA) Port	A-2
HDMI-In Port	A-3
Headphone-Out Jack	A-3
Line-In Jack	A-3
Microphone-In Jack	A-3
RJ-45 LAN Jack	A-3
Security Lock Slot	A-3
S/PDIF-Out Jack	A-4
USB 2.0/1.1 Ports	A-4
USB 3.0 Port	A-4

Intel Video Driver Controls

Intel Video Driver Installation	B-1
Video	B-1
Dynamic Video Memory Technology	B-1
Intel® Graphics & Media Control Panel	B-2
Attaching Other Displays	B-4
Configuring an External Display in Windows 7	B-6

Specifications

Processor	C-2
Processor	C-2
Processor	C-2
Core Logic	C-2
Display	C-2
Memory	C-3
Video Adapter	C-3
BIOS	C-3
Storage	C-3
Audio	C-3
Keyboard & Pointing Device	C-3
Interface	C-3
Card Reader	C-4
Slots	C-4
Communication	C-4

Communication	C-4
Power Management	C-4
Power	C-4
Security	C-4
Operating System	C-4
Environmental Spec	C-4
Physical Dimensions & Weight	C-5

Chapter 1: Quick Start Guide

Overview

This Quick Start Guide is a brief introduction to the basic features of your computer, to navigating around the computer and to getting your system started. The remainder of the manual covers the following:

- **Chapter 2** A guide to using some of the main features of the computer e.g. the **storage devices (hard disk, optical device, Multi-in-1 card reader, ExpressCard/34/54) Audio & Printer.**
- **Chapter 3** The computer's **power** saving options.
- **Chapter 4** The installation of the **drivers** and utilities essential to the operation or improvement of some of the computer's subsystems.
- **Chapter 5** An outline of the computer's built-in software or **BIOS** (Basic Input Output System).
- **Chapter 6** Instructions for **upgrading** your computer.
- **Chapter 7** A quick guide to the computer's **PC Camera, Wireless LAN, Bluetooth & WLAN Combo, Touch Screen** and **TV Tuner** modules (some of which may be **optional** depending on your purchase configuration).
- **Chapter 8** A **troubleshooting** guide.
- **Appendix A** Definitions of the **interface, ports/jacks** which allow your computer to communicate with external devices.
- **Appendix B** Information on the **Intel video** driver controls.
- **Appendix C** The computer's **specification.**

Advanced Users

If you are an advanced user you may skip over most of this Quick Start Guide. However you may find it useful to refer to *“What to Install” on page 4 - 1*, *“BIOS Utilities” on page 5 - 1* and *“Upgrading The Computer” on page 6 - 1* in the User’s Manual. You may also find the notes marked with a  of interest to you.



Notes

Check the light colored boxes with the mark above to find detailed information about the computer’s features.

Beginners and Not-So-Advanced Users

If you are new to computers (or do not have an advanced knowledge of them) then the information contained in this Quick Start Guide should be enough to get you up and running. Eventually you should try to look through all the documentation (more detailed descriptions of the functions, setup and system controls are covered in the remainder of the User’s Manual), but do not worry if you do not understand everything the first time. Keep this manual nearby and refer to it to learn as you go. You may find it useful to refer to the notes marked with a  as indicated in the margin. For a more detailed description of any of the interface ports and jacks see *“Interface (Ports & Jacks)” on page A - 1*.

Warning Boxes

No matter what your level please pay careful attention to the warning and safety information indicated by the  symbol. Also please note the safety and handling instructions as indicated in the *Preface*.

Not Included

Operating Systems (e.g. *Windows 7*) and applications (e.g. word processing, spreadsheet and database programs) have their own manuals, so please consult the appropriate manuals.



Drivers

If you are installing new system software, or are re-configuring your computer for a different system, you will need to install the drivers listed in **“Drivers & Utilities” on page 4 - 1**. Drivers are programs which act as an interface between the computer and a hardware component e.g. a wireless network module. It is very important that you install the drivers in the order listed in **Table 4 - 1, on page 4 - 3**. You will be unable to use most advanced controls until the necessary drivers and utilities are properly installed. If your system hasn't been properly configured (your service representative may have already done that for you), refer to **“What to Install” on page 4 - 1** for installation instructions.

Ports and Jacks

See **“Computer Ports and Jacks” on page A - 2** for a description of the interface (ports & jacks) which allow your computer to communicate with external devices, connect to the internet etc.

System Startup

1. Remove all packing materials, CDs/DVDs and floppy disks etc.
2. Securely attach any peripherals you want to use with the computer to their ports (e.g keyboard and mouse etc.)
3. Attach the AC/DC adapter to the DC-In jack located under the LCD, then plug the AC power cord into an outlet, and connect the AC power cord to the AC/DC adapter.
4. Push the power button at the front of the computer (under the LCD) to turn the computer “on”.



Power Button (located along the bottom of the LCD)



Shutdown

Note that you should always shut your computer down by choosing the **Shut Down** command from the bottom right of the **Start** menu in **Windows**. This will help prevent hard disk or system problems.

Figure 1 - 1 - AC/DC Adapter Plugged-In/Power Button

System Map: Front View

1. Optional Built-In PC Camera
2. LCD (With **Optional** Touch Panel - see page [7 - 23](#))
3. Power & System Activity LED Indicators
4. Function Buttons*
5. Power Button*
6. USB 2.0 Ports
7. Microphone-In Jack
8. Headphone/Speaker-Out Jack
9. RJ-45 LAN Jack
10. 2 * USB Ports
11. eSATA Port
12. External Monitor Port
13. 2 * COM Ports
14. DC-In Jack

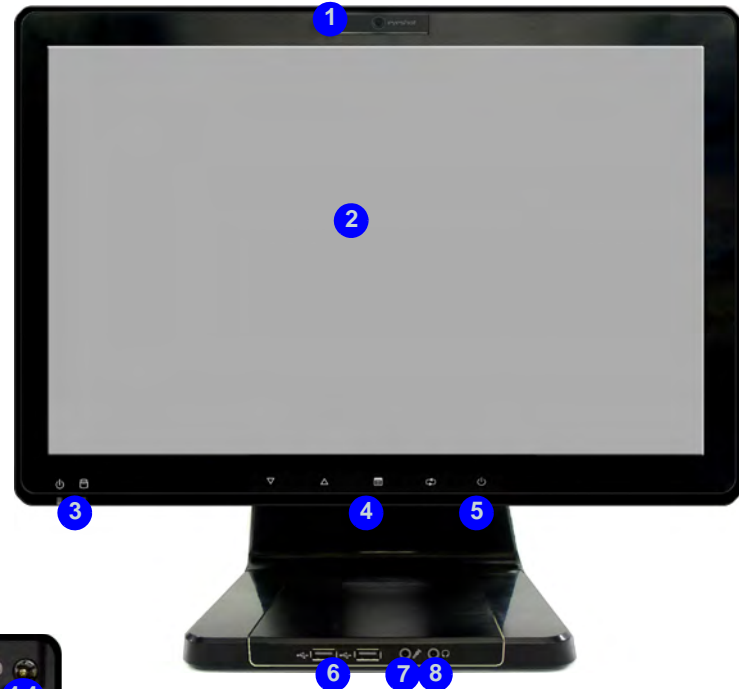
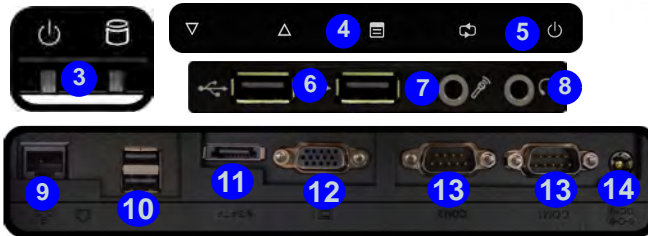

*Note the power and function buttons are located along the bottom of the LCD

Figure 1 - 2 - Front View

Tilting the LCD Screen

It is possible to tilt the LCD screen in order to get the best possible viewing angle of the screen without glare etc. Apply pressure with one hand at the base of the computer, while carefully pushing the LCD screen to tilt it to the appropriate viewing angle.



Figure 1 - 3 - LCD Screen Tilt



Moving the Computer

We strongly recommend using both hands to move the computer. You can use one hand to grip the computer by the stand, and the other to hold the top of the LCD screen.

It is recommended that you carry the computer with the LCD facing your body to avoid scratching the surface against other objects. However take care not to scratch the LCD with any personal items, belt fittings or jewelry etc.(one hand gripping the stand and the other gripping the top of the computer to avoid accidentally dropping it).

Keyboard Options

There are two keyboard **options** for this computer series. These keyboards may include embedded numerical keypads for easy numeric data input and/or function keys/hot keys to allow you to change operational features instantly. Some keyboards may require a driver to access all available functions etc.



Figure 1 - 4 - Optional Wireless Keyboard & Mouse Kit

A USB port located behind the rear top cover is designed to house the transceiver for the USB wireless Keyboard & Mouse Kit (or a USB transceiver for any Keyboard/Mouse). See **“Wireless Keyboard & Mouse USB Transceiver”** on page 6 - 5 for more information.



Dongle & USB Ports

A single USB dongle is provided with the keyboard, mouse and TV Tuner. This dongle acts as a transceiver for the keyboard and mouse, and as a RF transceiver for the TV Tuner. This dongle may be inserted into any of the USB ports, however if you have included the TV Tuner in your purchase option it is recommended that you do not plug the dongle into the USB port located behind the rear top cover (see **Figure 6 - 4 on page 6 - 5**) in order to prevent any interference.

LED Indicators & Buttons

The LED indicators on the computer display helpful information about the current status of the computer.



Icon	Color	Description
	Green	The computer is On
	Blinking Green	The computer is in Sleep Mode
	Orange	The AC/DC Adapter is Plugged in & the Computer is Powered Off
	Green	System Activity

Table 1 - 1 - LED Indicators

The buttons located under the front panel icons allow you to make screen and input adjustments.



Figure 1 - 5 - Front Icons







Icon	Description
	Decrease/Increase Buttons - Use the buttons to decrease/increase the brightness/volume
	Menu Toggle - Use this button to switch between the brightness or audio menus and use the buttons above to adjust
	Mode Toggle - Use this button to toggle between the computer and HDMI Input modes (see “Mode Toggle” on page 1 - 11)

Table 1 - 2 - Function Buttons

On Screen Display Indicators

Visual indicators for brightness and volume are available when the **OSD AP** is installed (see *“On Screen Display” on page 4 - 6*). When the driver is installed, an icon  will appear in the taskbar.

Note that these indicators illustrate the volume and brightness level changes when adjusted by the buttons   on the computer itself. Use the menu toggle button  to switch between the brightness or volume (some keyboards may provide their own indicators).



OSD Icon	Description
	Volume Decrease/Increase
	Brightness Decrease/Increase

Table 1 - 3 - On Screen Display Indicators

If your purchase configuration includes the **Multi-Touch Panel** you may use the stylus pen (or a finger) to slide along the bars under the on-screen symbols to adjust the volume and brightness and controls

Figure 1 - 6
Left View

1. Stand
2. Multi-in-1 Card Reader
3. ExpressCard Slot (see page 2 - 7)
4. 1 * USB 3.0 Port
5. HDMI-in Port
6. Line-In Jack
7. S/PDIF-Out Jack



ExpressCard Slot

The ExpressCard Slot accepts either **ExpressCard/34** or **ExpressCard/54** formats.

System Map: Left View



HDMI-In Port

Note that the HDMI-In Port supports video and audio signals from attached HDMI devices.

Multi-in-1 Card Reader

The card reader allows you to use the most popular digital storage card formats:

MMC (MultiMedia Card) / RSMHC
SD (Secure Digital) / Mini SD / SDHC /
SDXC Compatible
MS (Memory Stick) / MS Pro / MS Duo

USB 3.0 Port

The USB 3.0 port is denoted by its blue color; USB 2.0 ports are colored black. Note that **the USB 3.0 port requires a driver installation** (see **“USB 3.0” on page 4 - 7**), does not support wake on USB and is not operational under DOS.



HDMI-In Port

This computer features an **HDMI** (High-Definition Multimedia Interface) **input port** that allows you to display external sources such as Blu-ray players, DVDs, set top boxes and games consoles etc. on your computer screen.

The computer itself does not need to be powered on to display video and audio from external sources. As long as the computer is plugged-in to a power source through the AC/DC adapter (the LED indicator  will be orange if the computer is plugged-in but powered off), simply plug-in the HDMI cable from the external device to the computer's HDMI-In port and the computer will act as the display device. For resolutions supported see page [C - 3](#).

Mode Toggle

Press the mode toggle button  to switch between the computer and HDMI input modes. When the HDMI input source is displayed you can use any HDMI device plugged in to the computer's HDMI-In port.

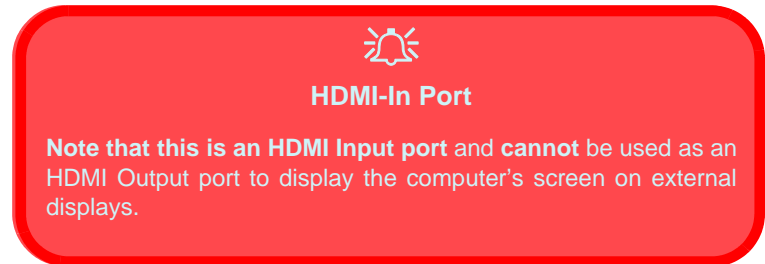
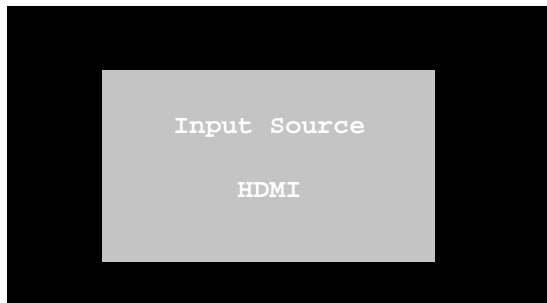

Figure 1 - 7 - HDMI Input

System Map: Right View

Figure 1 - 8 - Right View

1. Stand
2. Optical Device Drive Bay
(for CD/DVD Device - see page 2 - 3)
3. Security Lock Slot



CD Emergency Eject

If you need to manually eject a CD/DVD (e.g. due to an unexpected power interruption) you may push the end of a straightened paper clip into the emergency eject hole. Do not use a sharpened pencil or similar object that may break and become lodged in the hole.

Media Warning

Don't try to remove a floppy disk/CD/DVD while the system is accessing it. This may cause the system to "crash".



System Map: Rear View



CPU

The CPU is not a user serviceable part. Opening this compartment, or accessing the CPU in any way, may violate your warranty.

Overheating

To prevent your computer from overheating make sure nothing blocks the Vent/Fan Intake while the computer is in use.

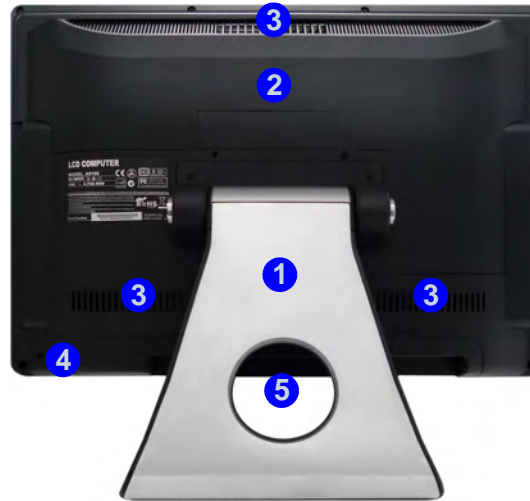

Figure 1 - 9
Rear View

1. Stand
2. Rear Component Cover
3. Vent/Fan Intake
4. Security Lock Slot
5. Carrying Handle Area



Carrying the Computer

We strongly recommend using both hands to move the computer (one hand gripping the handle area and the other gripping the computer) to avoid accidentally dropping it. Be careful that objects such as belt buckles etc. do not scratch the screen while it is being carried.

Windows 7 Start Menu & Control Panel

Most of the control panels, utilities and programs within *Windows 7* (and most other *Windows* versions) are accessed from the **Start** menu. When you install programs and utilities they will be installed on your hard disk drive, and a shortcut will usually be placed in the **Start** menu and/or the desktop. Right-click the **Start** menu icon , and then select **Properties** if you want to customize the appearance of the **Start** menu.

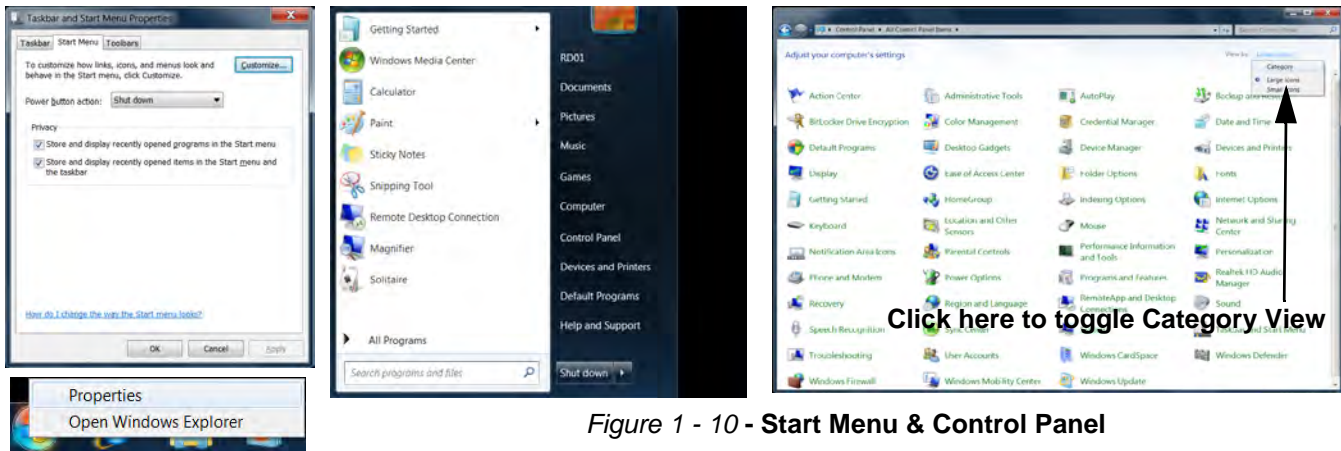

Figure 1 - 10 - Start Menu & Control Panel

In many instances throughout this manual you will see an instruction to open the **Control Panel**. The **Control Panel** is accessed from the **Start** menu, and it allows you to configure the settings for most of the key features in *Windows* (e.g. power, video, network, audio etc.). *Windows 7* provides basic controls for many of the features, however many new controls are added (or existing ones are enhanced) when you install the drivers. To see all controls it may be necessary to toggle off *Category View* to view the control panel icons.

Video Features

You can configure display options from the **Display (Control Panel)** and **Screen Resolution** in *Windows*. For more detailed video information see *Chapter B“Video Driver Controls” from page B - 1*.

To access **Display (Control Panel)** and **Screen Resolution** in *Windows*:

1. Click **Start** and click **Control Panel**.
2. Click **Display** (icon) - In the **Appearance and Personalization** category.
3. Click **Adjust Screen Resolution/Adjust resolution**.

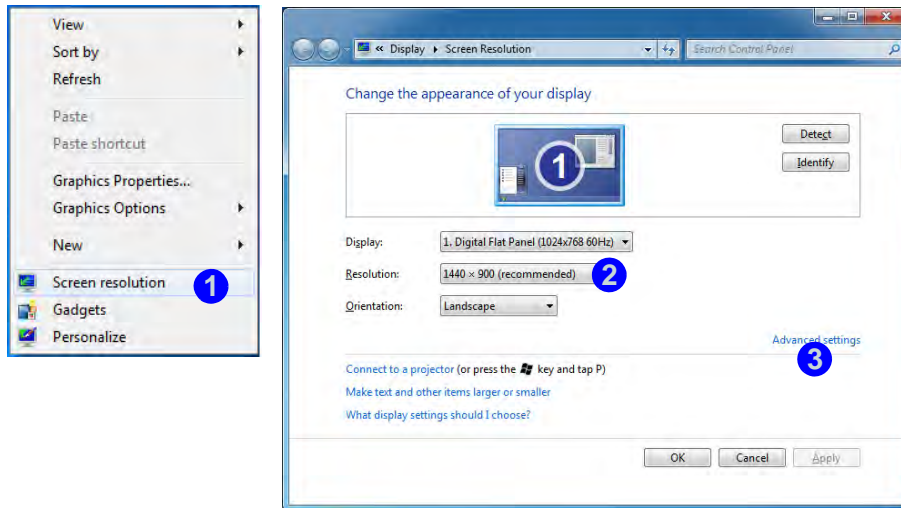



Figure 1 - 11 - Screen Resolution

Right-Click Desktop

1. You can right-click the desktop and select **Screen resolution** ① (*Figure 1 - 11*).
2. Use the dropdown to select the screen **Resolution** ② (*Figure 1 - 11*).
3. Click **Advanced settings** ③ (*Figure 1 - 11*) to bring up the **Advanced** properties tabs.

Quick Start Guide

To access the *Intel(R) Graphics Media Accelerator Driver for mobile* control panel:

1. Click **Advanced settings** ③ (*Figure 1 - 11 on page 1 - 15*) in the **Screen Resolution** control panel in **Windows**.
 2. Click the **Intel(R)...** tab and click **Graphics Properties** (button) ④ (*Figure 1 - 12 on page 1 - 16*).
- OR
3. Right-click the desktop and select **Graphics Properties** from the menu.
- OR
4. Click the icon  in the taskbar and select **Graphics Properties** from the menu.

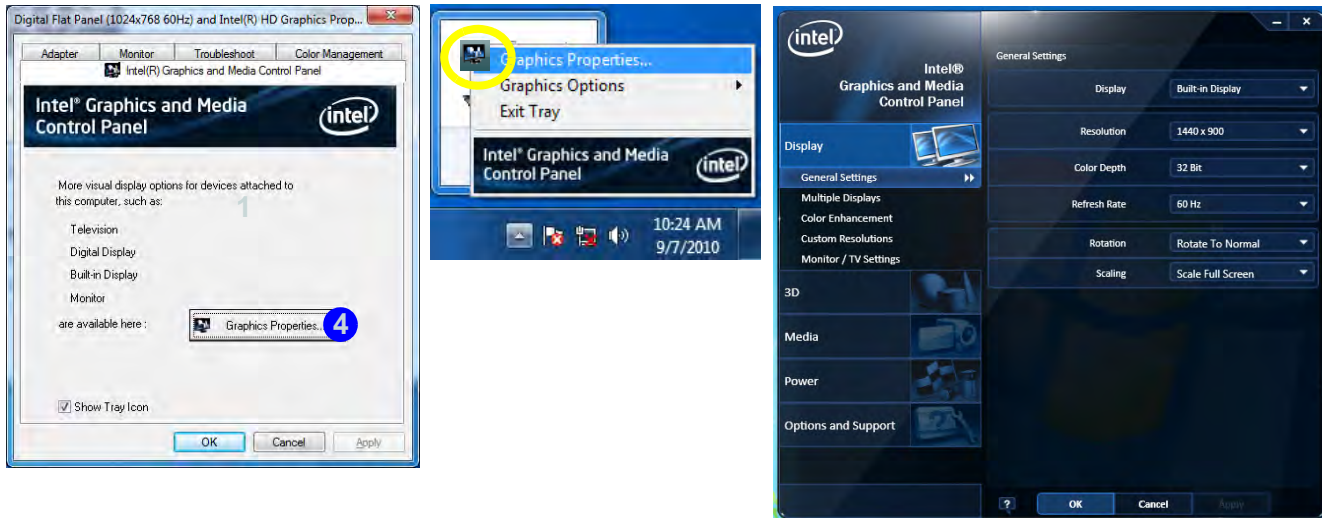

Figure 1 - 12 - Intel GMA Driver for Mobile Control Panel

Power Options

The **Power Options** (**Hardware and Sound** menu) control panel icon in *Windows* (see page *1 - 14*) allows you to configure power management features for your computer. You can conserve power by means of **power plans** and configure the options for the **power button**, **sleep button**, **display** and **sleep** mode from the left menu. Note that the **power saver** plan may have an affect on computer performance.

Click to select one of the existing plans, or click *Create a power plan* in the left menu and select the options to create a new plan. Click *Change plan settings* and click *Change advanced power settings* to access further configuration options.

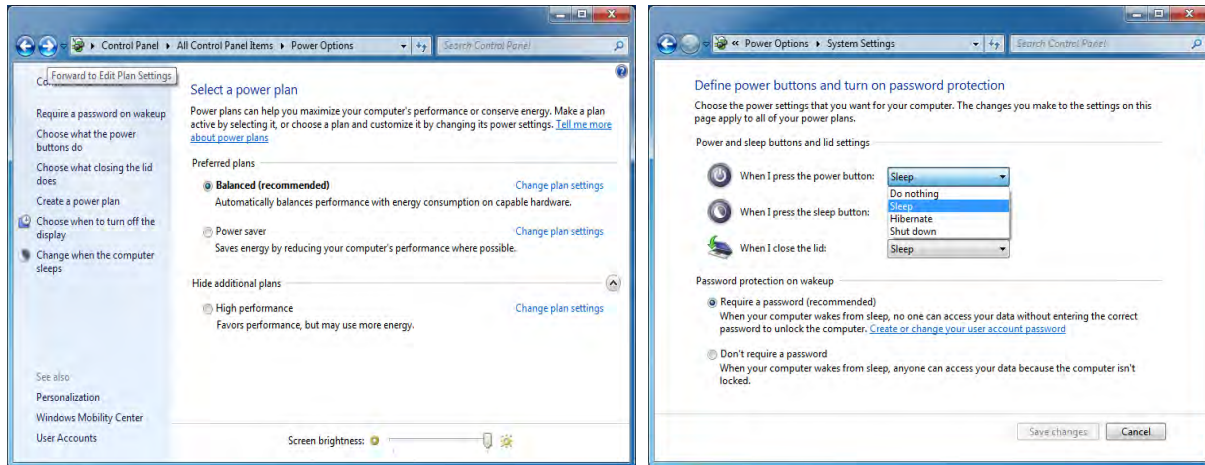

Figure 1 - 13 - Power Options

Chapter 2: Features & Components

Overview

Read this chapter to learn more about the following main features and components of the computer:

- Hard Disk Drive
- Optical (CD/DVD) Device
- Multi-in-1 Card Reader
- ExpressCard Slot
- Audio Features
- Adding a Printer



Power Safety

Before attempting to access any of the internal components of your computer please ensure that the machine is not connected to the AC power, and that the machine is turned off. Also ensure that all peripheral cables, including phone lines, are disconnected from the computer.

Hard Disk Drive

The hard disk drive is used to store your data in the computer. The hard disk can be taken out to accommodate other 2.5" serial (SATA) hard disk drives with a height of 9.5 mm.

The hard disk is accessible from the rear of your computer as seen below. For further details see [“Upgrading the Hard Disk Drive” on page 6 - 6.](#)

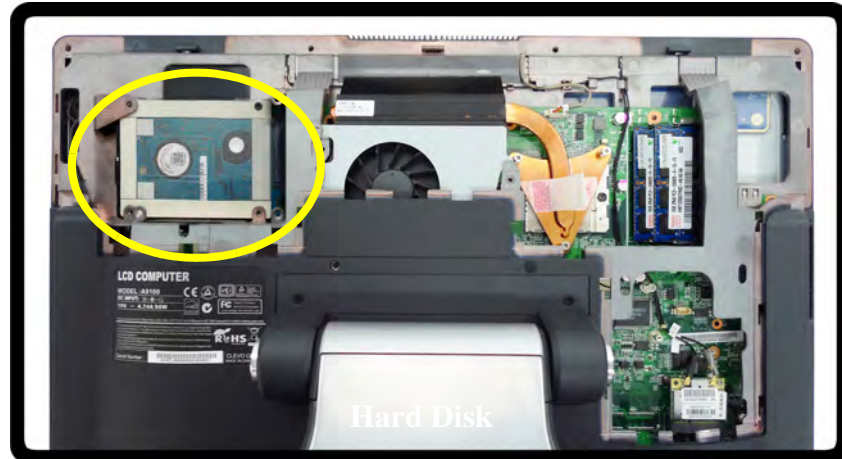

Figure 2 - 1

Hard Disk Location

Optical (CD/DVD) Device

There is a bay for a 5.25" optical (CD/DVD) device (12.7mm height). The actual device will depend on the module you purchased (see *“Storage” on page C - 3*). The optical device is usually labeled **“Drive D:”** and may be used as a boot device if properly set in the **BIOS** (see *“Boot Menu” on page 5 - 13*).

Loading Discs

To insert a CD/DVD, press the open button **1** and carefully place a CD/DVD onto the disc tray with label-side facing up (use just enough force for the disc to click onto the tray’s spindle). Gently push the CD/DVD tray in until its lock “clicks” and you are ready to start. The busy indicator **2** will light up while data is being accessed, or while an audio/video CD, or DVD, is playing. If power is unexpectedly interrupted, insert an object such as a straightened paper clip into the emergency eject hole **3** to open the tray.



Sound Volume Adjustment

How high the sound volume can be set depends on the setting of the volume control within **Windows**. Click the **Volume** icon on the taskbar to check the setting (see *“Audio Features” on page 2 - 8*).

Figure 2 - 2
Optical Device



CD Emergency Eject

If you need to manually eject a CD (e.g. due to an unexpected power interruption) you may push the end of a straightened paper clip into the emergency eject hole. However please do NOT use a sharpened pencil or similar object that may break and become lodged in the hole.

Disk Eject Warning

Don't try to remove a CD/DVD while the system is accessing it. This may cause the system to "crash".

Handling CDs or DVDs

Proper handling of your CDs/DVDs will prevent them from being damaged. Please follow the advice below to make sure that the data stored on your CDs/DVDs can be accessed.

Note the following:

- Hold the CD or DVD by the edges; do not touch the surface of the disc.
- Use a clean, soft, dry cloth to remove dust or fingerprints.
- Do not write on the surface with a pen.
- Do not attach paper or other materials to the surface of the disc.
- Do not store or place the CD or DVD in high-temperature areas.
- Do not use benzene, thinner, or other cleaners to clean the CD or DVD.
- Do not bend the CD or DVD.
- Do not drop or subject the CD or DVD to shock.

DVD Regional Codes

To change the DVD regional codes:

1. Go to the **Control Panel**
2. Double-click **Device Manager (Hardware and Sound)**, then click the **+** next to **DVD/CD-ROM drives**.
3. Double-click on the DVD-ROM device to bring up the **Properties** dialog box, and select the **DVD Region** (tab) to bring up the control panel to allow you to adjust the regional code.

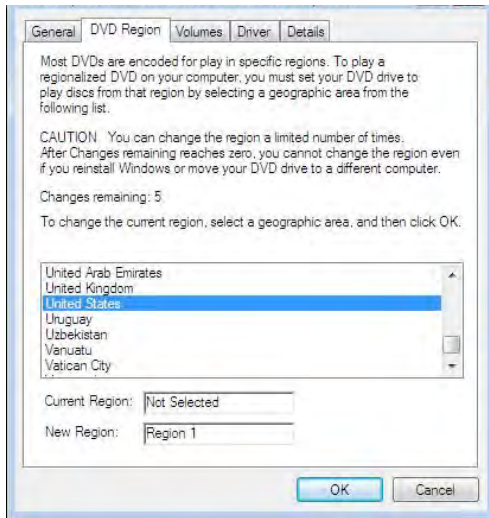

- **Region 1** - USA & Canada
- **Region 2** - Western Europe, Japan, South Africa, Middle East & Egypt
- **Region 3** - South-East Asia, Taiwan, South Korea, The Philippines, Indonesia, Hong Kong
- **Region 4** - South & Central America, Mexico, Australia, New Zealand
- **Region 5** - N Korea, Russia, Eastern Europe, India & Most of Africa
- **Region 6** - China



DVD Region Note

DVD region detection is device dependent, not OS-dependent. You can select your module's region code 5 times. The fifth selection is permanent. This cannot be altered even if you change your operating system or you use the module in another computer.

Figure 2 - 3
DVD Region Codes



Card Reader Cover

Make sure you keep the cover in the card reader when not in use. This will help prevent foreign objects and/or dust getting in to the card reader.

Multi-in-1 Card Reader

The card reader allows you to use some of the latest digital storage cards. Push the card into the slot and it will appear as a removable device, and can be accessed in the same way as your hard disk (s). Make sure you install the Card Reader driver (see *“ExpressCard/Card Reader” on page 4 - 6*).

- MMC (MultiMedia Card) / RSMMC
- SD (Secure Digital) / Mini SD / SDHC / *SDXC Compatible*
- MS (Memory Stick) / MS Pro / MS Duo

Figure 2 - 4
Front View

1. Card Reader



ExpressCard Slot

The computer is equipped with an **ExpressCard/34/54** slot that reads Express Card/34 and ExpressCard/54 formats. ExpressCards are the successors to PCMCIA (PC Cards).

ExpressCard/54 is used for applications which require a larger interface slot, e.g. CompactFlash card reader. The number denotes the card width; 54mm for the Express Card/54 and 34mm for the ExpressCard/34. Make sure you install the Card Reader driver (see *“ExpressCard/Card Reader” on page 4 - 6*).

Inserting and Removing Express-Cards

- Align the ExpressCard with the slot and push it in until it locks into place.
- To remove an ExpressCard, simply press the card to eject it.



ExpressCard Slot Cover

Make sure you keep the cover in the Express-Card slot when not in use. This will help prevent foreign objects and/or dust getting in to the ExpressCard Slot.

Figure 2 - 5
ExpressCard Slot

1. ExpressCard Slot

Sound Volume Adjustment

The sound volume level is set using the volume control within **Windows** (and the volume function keys on the computer). Click the volume icon in the taskbar to check the setting.

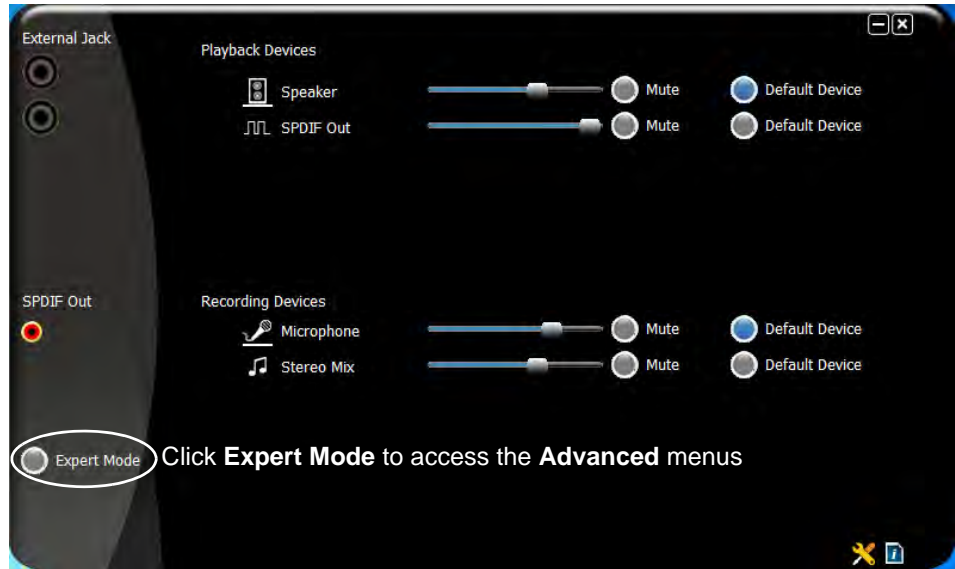

Figure 2 - 6
VIA HD Audio Deck

Audio Features

You can configure the audio options on your computer from the **Sound** control panel in **Windows**, from the **HD VDeck** icon on the desktop or **VIA HD Audio Deck** control panel  [VIA HD Audio Deck](#) .

The volume may also be adjusted by means of the function buttons located along the bottom of the LCD.



Expert Mode will allow you to access more advanced configuration menus.



Figure 2 - 7
VIA HD Audio Deck
(Expert Mode)



Parallel Printer

After setting up the printer attach the parallel cable to the printer.

Connect the printer's parallel cable to the Parallel to USB converter, and then plug the converter into the USB port.

Turn ON the printer, then turn ON the computer.

Windows will identify the printer and either load one of its own drivers or ask you to supply one. Follow the on-screen instructions.

Adding a Printer

The most commonly used peripheral is a printer. The following conventions will help you to add a printer, however it is always best to refer to the printer manual for specific instructions and configuration options.

USB Printer

Most current printers have a USB interface connection. You may use any one of the ports to connect the printer.

Install Instructions:

1. Set up the printer according to its instructions (unpacking, paper tray, toner/ink cartridge etc.).
2. Turn ON the computer.
3. Turn ON the printer.
4. Connect the printer's USB cable to one of the USB ports on the computer.
5. **Windows** will identify the printer and either load one of its own drivers or ask you to supply one. Follow the on-screen instructions.

Parallel Printer

This is still a very common type of printer. The install instructions are in the sidebar, however you will need to purchase a parallel to USB converter.

Chapter 3: Power Management

Overview

To conserve power, especially when using the battery, your computer power management conserves power by controlling individual components of the computer (the monitor and hard disk drive) or the whole system.

This chapter covers:

- Turning On the Computer
- Power Plans
- Power-Saving States
- Configuring the Power Buttons

The computer uses enhanced power saving techniques to give the operating system (OS) direct control over the power and thermal states of devices and processors. For example, this enables the OS to set devices into low-power states based on user settings and information from applications.

Using some form of power management greatly increases the life span of the LCD.



OS Note

Power management functions will vary slightly depending on your operating system. For more information it is best to refer to the user's manual of your operating system.

(**Note:** All pictures used on the following pages are from the *Windows 7* OS.)



Forced Off

If the system “hangs”, and the **Ctrl + Alt + Del** key combination doesn’t work, press the power button for **4 seconds**, or longer, to force the system to turn itself off.

Power Button as Stand by or Hibernate Button

You can use the OS’s “Power Options” control panel to set the power button to send the system into Stand by or Hibernate mode (see your OS’s documentation, or [“Configuring the Power Buttons” on page 3 - 7](#) for details).

Turning On the Computer

Now you are ready to begin using your computer. To turn it on simply press the power button on the front panel.

When the computer is on, you can use the power button as a Stand by/Hibernate/Shutdown hot-key button when it is pressed for less than **4 seconds** (pressing and holding the power button for longer than this will shut the computer down). Use **Power Options** in the *Windows* control panel to configure this feature.



Shut Down

Note that you should always shut your computer down by choosing the **Shut Down** command from the bottom right of the **Start** menu in *Windows*. This will help prevent hard disk or system problems.

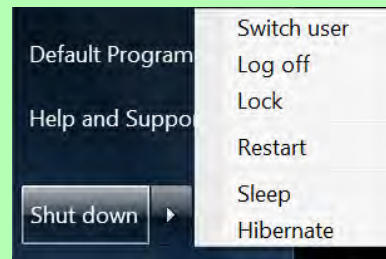



Power Plans

The computer can be configured to conserve power by means of **power plans**. You can use (or modify) an existing **power plan**, or create a new one.

The settings may be adjusted to set the **display** to turn off after a specified time, and to send the computer into **Sleep** after a period of inactivity.

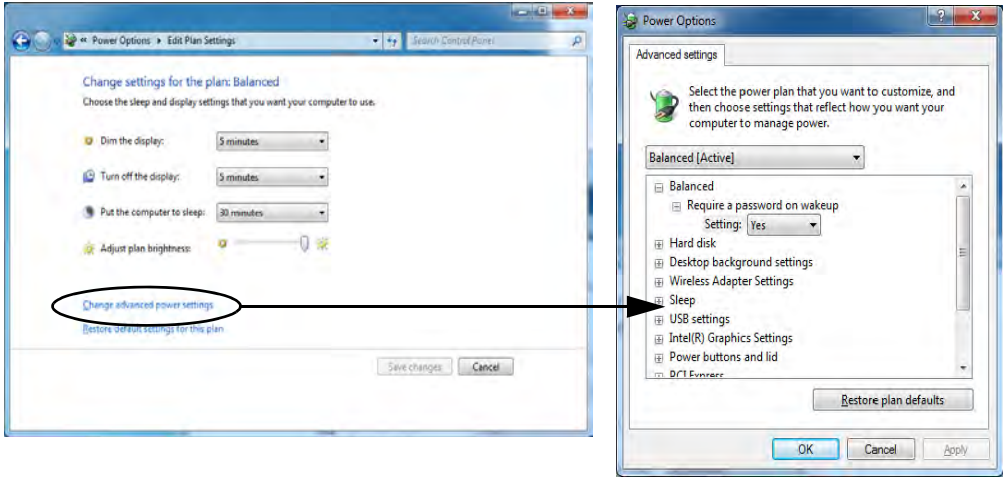
Click *Change plan settings* and then click *Change advanced power settings* to access further configuration options in **Advanced Settings**.





Resuming Operation

See *Table 3 - 1, on page 3 - 8* for information on how to resume from a power-saving state.

Password

It is recommended that you enable a password on system resume in order to protect your data.

Figure 3 - 1
Power Plan
Advanced Settings

Power Management

3

Each **Windows power plan** will also adjust the processor performance of your machine in order to save power. This is worth bearing in mind if you are experiencing any reduced performance (especially under DC/battery power).

Choose **High performance** (you may need to click **Show additional plans** to view the High performance plan) for maximum performance when the computer is powered from an AC power source. Choose the **Power saver** (bear in mind that this scheme may slow down the overall performance of the computer in order to save power) for maximum power saving when the computer is battery (DC power) powered.

Figure 3 - 2
Power Plans

Click to Show/Hide additional power plans

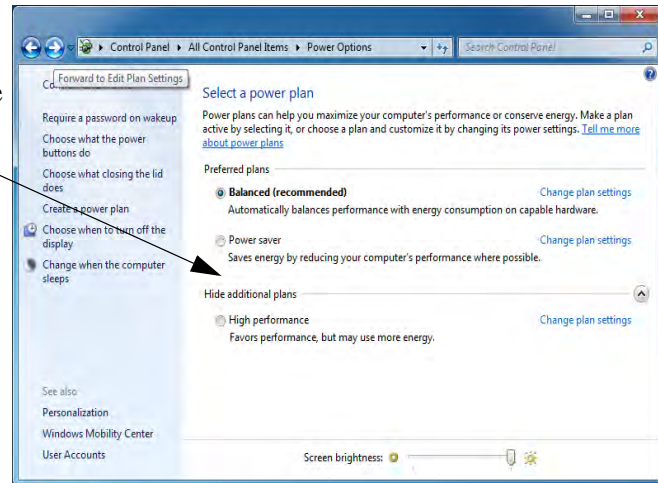

Power-Saving States

You can use power-saving states to stop the computer's operation and restart where you left off. *Win 7* uses the **Sleep**, **Hibernate** and **Shut Down** power-saving states.

Sleep

In **Sleep** all of your work, settings and preferences are saved to memory before the system sleeps. When you are not using your computer for a certain length of time, which you specify in the operating system, it will enter **Sleep** to save power.

The PC wakes from **Sleep within seconds** and will return you to where you last left off (what was on your desktop) without reopening the application(s) and file(s) you last used.



Sleep & Touch Screen

Note that touching the screen when the computer is in **Sleep** will cause the system to resume, and wake from the **Sleep** state.

Hibernate

Hibernate uses the least amount of power of all the power-saving states and saves all of your information on a part of the hard disk before it turns the system off. If a power failure occurs the system can restore your work from the hard disk; if a power failure occurs when work is saved only to memory, then the work will be lost. **Hibernate** will also return you to where you last left off within seconds.

Shut down

You should **Shut down** the computer if you plan to install new hardware, plan to be away from the computer for several days, or you do not need it to wake up and run a scheduled task. Returning to full operation from **Shut down** takes longer than from **Sleep** or **Hibernate**.

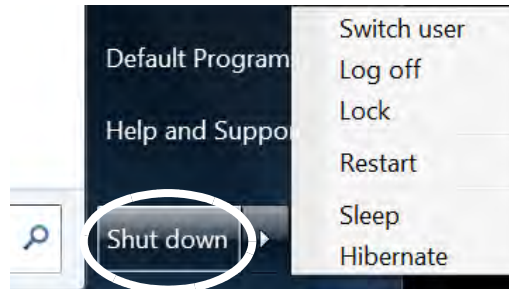

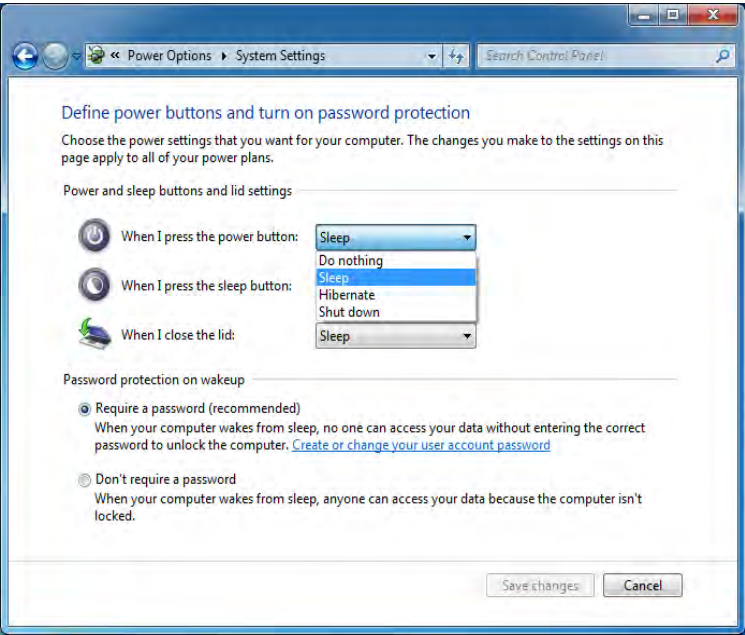



Figure 3 - 3
Start Menu Power

Configuring the Power Buttons

The power button may be set to send the computer in to either **Sleep** or **Hibernate**. In **Sleep**, the LED  will blink green. In **Hibernate** the LED will be orange. If only the display is turned off, the LED will remain green. Click **Choose what the power buttons do** on the left menu in **Power Options** to bring up the menu.





Password Protection

It is recommended that you enable a password on wake up in order to protect your data.

However you can disable this setting from the **Power Options** menu by clicking **Require a password on wakeup** in the left menu, and selecting the options (click **Change settings that are currently unavailable**).

Figure 3 - 4
Power Options
Define Power Buttons

Resuming Operation

You can resume operation from power-saving states by pressing the power button, or in some cases pressing the sleep button (see your keyboard documentation).

Table 3 - 1
Resuming Operation

Power Status	Icon Color 	To Resume
Power Off	Off	Press the Power Button
Sleep	Blinking Green	Press the Power Button Press the Sleep Button (on your keyboard)
Hibernate	Orange (AC/DC adapter)	Press the Power Button



Power Button

When the computer is on, you can use the power button as a Sleep/Hibernate hot-key button when it is pressed for less than **4 seconds** (pressing and holding the power button for longer than this will force shut the computer to shut down).

Chapter 4: Drivers & Utilities

This chapter deals with installing the drivers and utilities essential to the operation or improvement of some of the computer's subsystems. The system takes advantage of some newer hardware components for which the latest versions of most available operating systems haven't built in drivers and utilities. Thus, some of the system components won't be auto-configured with an appropriate driver or utility during operating system installation. Instead, you need to manually install some system-required drivers and utilities.

What to Install

The *Device Drivers & Utilities + User's Manual* disc contains the drivers and utilities necessary for the proper operation of the computer.

Table 4 - 1, on page 4 - 3 lists what you need to install and **it is very important that the drivers are installed in the order indicated.**

Module Driver Installation

The procedures for installing drivers for the **PC Camera, Wireless LAN, Bluetooth & WLAN Combo** and **Touchscreen** modules are provided in "*Modules & Options*" on page 7 - 1. Make sure that the drivers are installed in the order indicated in *Table 4 - 1, on page 4 - 3*. Only install drivers for modules included in your purchase option.

Driver Installation

Insert the *Device Drivers & Utilities + User's Manual* disc into the DVD drive and click **Install Drivers/Option Drivers** (button).

4

Follow the instructions to install the driver. Alternatively click **Start**, navigate (**Browse..**) to the executable file and then follow the manual setup instructions.



Figure 4 - 1 - Drivers Installer Screen 1

1. Check the driver installation order from **Table 4 - 1, on page 4 - 3** (the drivers must be installed in **this order**) which is the same as that listed in the **Drivers Installer** menu below.
2. Click to select the driver you wish to install, (you should note down the drivers as you install them).
3. Follow the instructions for each individual driver installation procedure as listed on the following pages.

Note: If you need to reinstall any driver, you should uninstall the driver first.



Figure 4 - 2 - Drivers Installer Screen 2

Driver for <i>Windows 7</i>	Page #
<i>Chipset</i>	<i>Page 4 - 5</i>
<i>Video</i>	<i>Page 4 - 5</i>
<i>LAN</i>	<i>Page 4 - 5</i>
<i>ExpressCard/Card Reader</i>	<i>Page 4 - 6</i>
<i>On Screen Display</i>	<i>Page 4 - 6</i>
<i>USB 3.0</i>	<i>Page 4 - 6</i>
<i>Intel MEI Driver</i>	<i>Page 4 - 6</i>
<i>Audio</i>	<i>Page 4 - 6</i>
<i>PC Camera Module</i>	<i>Page 7 - 2</i>
<i>Wireless LAN Module</i>	<i>Page 7 - 9</i>
<i>Bluetooth & WLAN Combo Module</i>	<i>Page 7 - 15</i>
<i>Touch Screen Module</i>	<i>Page 7 - 23</i>

Table 4 - 1 - Driver Installation

Manual Driver Installation

Click **Browse CD/DVD** (button) in the *Drivers Installer* application and browse to the executable file in the appropriate driver folder.

Windows Update

After installing all the drivers make sure you enable **Windows Update** in order to get all the latest security updates etc. (all updates will include the latest **hotfixes** from Microsoft). See “*Windows 7 Update*” on *page 4 - 7* for instructions.

Updating/Reinstalling Individual Drivers

If you wish to update/reinstall individual drivers it may be necessary to uninstall the original driver. To do this go to the **Control Panel** in the *Windows OS* and double-click the **Programs and Features** icon (**Programs > Uninstall a program**). Click to select the driver (if it is not listed see below) and click **Uninstall**, and then follow the on screen prompts (it may be necessary to restart the computer). Reinstall the driver as outlined in this chapter.

If the driver is not listed in the **Programs and Features** menu:

1. Click **Start**, and click **Control Panel** (or point to **Settings** and click **Control Panel**).
2. Double-click **Device Manager (Hardware and Sound > Device Manager)**.
3. Double-click the **device** you wish to update/reinstall the driver for (you may need to click “+” to expand the selection).
4. Click **Driver** (tab) and click the **Update Driver** or **Uninstall** button and follow the on screen prompts.

User Account Control

If a **User Account Control** prompt appears as part of the driver installation procedure, click **Continue** or **Allow**, and follow the installation procedure as directed.

Windows Security Message

If you receive a *Windows* security message as part of the driver installation process. Just click “*Install this driver software anyway*” or “*Install*” to continue the installation procedure.

You will receive this message in cases where the driver has been released after the version of *Windows* you are currently using. All the drivers provided will have already received certification for *Windows*.

New Hardware Found

If you see the message “**New Hardware Found**” during the installation procedure (**other than when outlined in the driver install procedure**), click **Cancel** to close the window, and follow the installation procedure.



Driver Installation General Guidelines

The driver installation procedure outlined in this Chapter (and in **Chapter 7 Options & Modules**), are accurate at the time of going to press.

Drivers are always subject to upgrade and revision so the exact procedure for certain drivers may differ slightly. As a general guide follow the default on screen instructions for each driver (e.g. **Next > Next > Finish**) unless you are an advanced user. In many cases a restart is required to install the driver.

Make sure any modules (e.g. PC Camera, WLAN or 3.75G/HSPA) are **ON** before installing the appropriate driver.

Driver Installation Procedure

Insert the *Device Drivers & Utilities + User's Manual* disc into your DVD drive and click **Install Drivers** (button).

Chipset

1. Click **1.Install Chipset Driver > Yes**.
2. Click **Next > Yes > Next > Next**.
3. Click **Finish** to restart the computer.

Video

1. Click **2.Install VGA Driver > Yes**.
2. Click **Next > Yes > Next > Next**.
3. Click **Finish** to restart the computer.

LAN

1. Click **3.Install LAN Driver > Yes**.
2. Click **Install > Finish**.
3. The network settings can now be configured.

ExpressCard/Card Reader

1. Click **4.Install Cardreader Driver > Yes.**
2. Click **Install > Finish.**

On Screen Display

1. Click **5.Install OSD AP > Yes.**
2. Click **Next > Next.**
3. Click **Finish > Finish** to restart the computer.

USB 3.0

1. Click **6.Install USB 3.0 Driver > Yes.**
2. Click **Next.**
3. Click the button to accept the license and then click **Next.**
4. Click **Next > Install.**
5. Click **Finish.**

Intel MEI Driver

1. Click **7.Install MEI Driver > Yes.**
2. Click **Next > Yes > Next > Next.**
3. Click **Finish.**

Audio

1. Click **8.Install Audio Driver > Yes.**
2. Click **Next.**
3. Click the button to agree to the license and click **Next.**
4. Click **Next > Next > Next.**
5. Click **Finish** to restart the computer.

Note that after installing the audio driver the system will not return to the **Drivers Installer** screen. To install any of the optional drivers listed overleaf, eject the *Device Drivers & Utilities + User's Manual* disc and then reinsert it (or double-click the disc icon in My Computer), and click **Option Drivers** (button) to access the optional driver menu.

(See Over)

Windows Experience Index

After the drivers are installed follow this procedure to ensure an accurate rating from the *Windows Experience Index*:

1. Click **Start**, and click **Control Panel**.
2. Click **Performance Information and Tools** (**System and Security** > **System** > **Check the Windows Experience Index**).
3. Click “**Rate this computer**”.
4. The computer will take a few minutes to assess the system performance.
5. Close the control panel.



Windows 7 Update

After installing all the drivers make sure you enable **Windows Update** in order to get all the latest security updates etc. (all updates will include the latest **hotfixes** from Microsoft).

To enable **Windows Update** make sure you are **connected to the internet**:

1. Click **Start**, and click **Control Panel** (or point to **Settings** and click **Control Panel**).
2. Click **Windows Update** (System and Security).
3. Click **Check for updates** (button).
4. The computer will now check for updates (you need to be connected to the internet).
5. Click **Install now** (button) to begin checking for the updates.
6. Click **Install updates** (button) to install the updates.

Optional Drivers

See the pages indicated for the driver installation procedures for any modules included in your purchase option. Insert the *Device Drivers & Utilities + User's Manual* disc and click **Option Drivers** (button) to access the optional driver menu.



Figure 4 - 3 - Optional Drivers

PC Camera Module

See the introduction in *“PC Camera Module”* on page 7 - 2, and check the installation procedure.

Wireless LAN Module

See the introduction in *“Wireless LAN Module”* on page 7 - 9, and check the installation procedure.

Bluetooth Module

See *“Bluetooth & WLAN Combo Module”* on page 7 - 14 for configuration instructions.

Touch Screen Module

See the introduction in *“Touch Screen Module”* on page 7 - 23, and check the installation procedure.

Chapter 5: BIOS Utilities

Overview

This chapter gives a brief introduction to the computer's built-in software:

Diagnostics: The **POST** (Power-On Self Test)

Configuration: The **Phoenix SecureCore Setup Utility**

If your computer has never been set up, or you are making important changes to the system (e.g. hard disk setup), then you should review this chapter first and note the original settings found in *Setup*. Even if you are a beginner, keep a record of the settings you find and any changes you make. This information could be useful if your system ever needs servicing.

There is one general rule: *Don't make any changes unless you are sure of what you are doing*. Many of the settings are required by the system, and changing them could cause it to become unstable or worse. If you have any doubts, consult your service representative.



BIOS Screens

Note that the BIOS screens pictured on these pages are intended for guidance in setting up your system's BIOS.

BIOS versions are subject to constant change and revision, therefore your computer's actual screens may appear slightly different from those pictured on these pages.



POST Screen

1. BIOS information
2. CPU type
3. Memory status
4. Enter **Setup** prompt appears only during **POST**

Note: The **POST** screen as pictured right is for guideline purposes only. The **POST** screen on your computer may appear slightly different. If you disable the **Boot-time Diagnostic Screen**, the **POST** screen will not appear.

Figure 5 - 1
POST Screen

The Power-On Self Test (POST)

Each time you turn on the computer, the system takes a few seconds to conduct a **POST**, including a quick test of the on-board RAM (memory).

As the **POST** proceeds, the computer will tell you if there is anything wrong. If there is a problem that prevents the system from booting, it will display a system summary and prompt you to run **Setup**.

If there are no problems, the **Setup** prompt will disappear and the system will load the operating system. Once that starts, you can't get into **Setup** without rebooting.

```

Phoenix SecureCore(tm) NB
Copyright 1985-2009 Phoenix Technologies Ltd.
All Rights Reserved
BIOS Revision ***** 1
KBC/EC Firmware Revision *****

CPU = 1 Processors Detected, Cores Per Processor - 2 2
Intel(R) Core(TM) i5CPU           M 540 @ 2.53GHz
1784M System RAM Passed
256 KB L2 Cache per Processor Core
3072K L3 Cache Detected 3
System BIOS shadowed
Video BIOS shadowed
Fixed Disk 0: FUJITSU MJA2500BH G2
ATAPI CD-ROM: HL-DT-STBDVDRW CT21IN
Mouse initialized

Press <F2> to enter SETUP 4
  
```

Failing the POST

Errors can be detected during the **POST**. There are two categories, “fatal” and “non-fatal”.

Fatal Errors

These stop the boot process and usually indicate there is something seriously wrong with your system. Take the computer to your service representative or authorized service center as soon as possible.

Non-Fatal Errors

This kind of error still allows you to boot. You will get a message identifying the problem (make a note of this message!) followed by the prompt:

- Press <F1> to resume
- <F2> to enter Setup

Press **F1** to see if the boot process can continue. It may work, without the correct configuration.

Press **F2** to run the **Setup** program and try to correct the problem. If you still get an error message after you change the setting, or if the “cure” seems even worse, call for help.



BIOS Settings Warning

Incorrect settings can cause your system to malfunction. To correct mistakes, return to *Setup* and restore the *Setup Defaults* with <F9>.

5

The Setup Utility

The **Phoenix SecureCore Setup Utility** tells the system how to configure itself and manage basic features and subsystems (e.g. port configuration).

Entering Setup

To enter *Setup*, turn on the computer and press **F2** during the **POST**. The prompt (*Press F2 to Enter Setup*) seen on page 5 - 2 is usually present for a few seconds after you turn on the system. If you get a “Keyboard Error”, (usually because you pressed **F2** too quickly) just press **F2** again.

If the computer is already on, reboot using the **Ctrl + Alt + Delete** combination and then hold down **F2** when prompted. The *Setup* main menu will appear.

Setup Screens

The following pages contain additional advice on **portions** of the *Setup*.

Along the top of the screen is a menu bar with menu headings. When you select a heading, a new screen appears. Scroll through the features listed on each screen to make changes to *Setup*.

Instructions on how to navigate each screen are in the box along the bottom of the screen. If these tools are confusing, press **F1** to call up a **General Help** screen, and then use the arrow keys to scroll up or down the page.

The **Item Specific Help** on the right side of each screen explains the highlighted item and has useful messages about its options.

If you see an arrow ► next to an item, press **Enter** to go to a sub-menu on that subject. The sub-menu screen that appears has a similar layout, but the **Enter** key may execute a command.



Setup Menus

The **Setup** menus shown in this section are for **reference** only. Your computer's menus will indicate the configuration appropriate for your model and options.

Main Menu

Figure 5 - 2
Main Menu

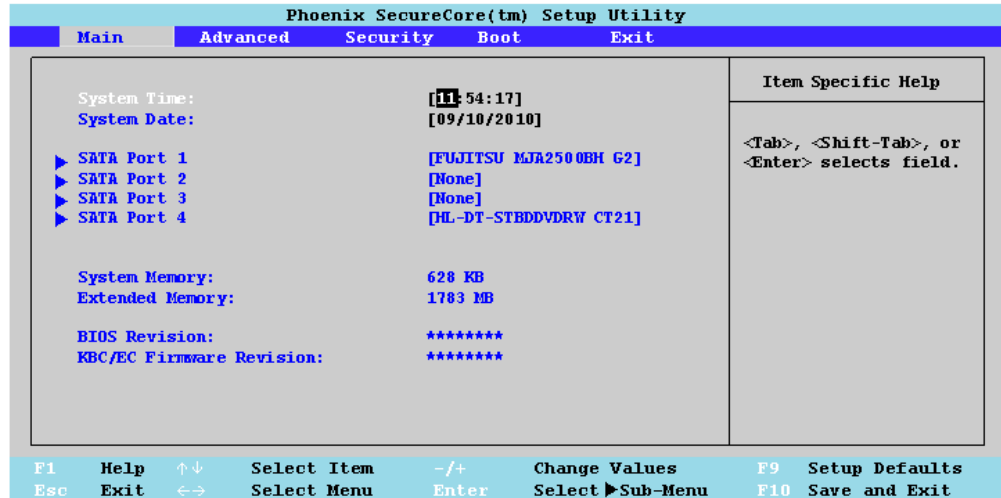

System Time & Date (Main Menu)

The hour setting uses the 24-hour system (i.e., 00 = midnight; 13 = 1 pm). If you can change the date and time settings in your operating system, you will also change these settings. Some applications may also alter data files to reflect these changes.

SATA Port 1/2/3/4 (Main Menu)

Pressing **Enter** opens the sub-menu to show the configuration of a optical Device/HDD on the computer's SATA Ports. Use the **Auto** (Type:) setting to have the items configured automatically for you.

System/Extended Memory (Main Menu)

This item contains information on the system memory, and is not user configurable. The system will auto detect the amount of memory installed.

BIOS Revision/KBC/EC Firmware Revision (Main Menu)

This item contains information on the current BIOS and firmware versions.

Advanced Menu

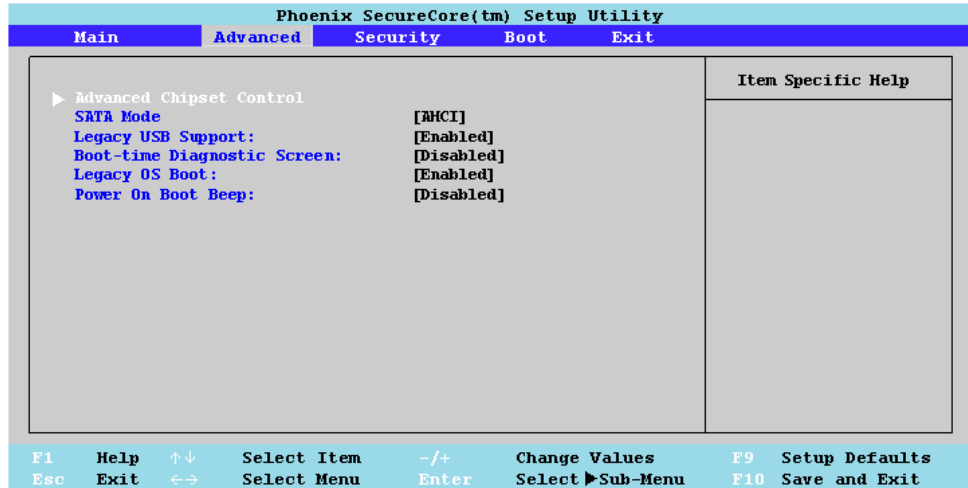

Figure 5 - 3
Advanced Menu

Advanced Chipset Control (Advanced Menu)

The sub-menu here allows you to enable/disable the **JMicron Power Saving** (as used by the card reader) control, and to adjust the amount of **Total Graphics Mem-**
ory used by the system.

Total Graphics Memory (Advanced Menu > Advanced Chipset Control)

Use this menu item to set the amount of system memory to be allocated for use by Intel® Dynamic Video Memory Technology for the graphics device. The default memory size allocated is **MaxDVMT** (up to **384MB**) and this may be adjusted to **128MB or 256MB** (by pressing the spacebar to adjust) if required (see *“Dynamic Video Memory Technology” on page B - 1*).

SATA Mode (Advanced Menu)

You can configure SATA (Serial ATA) control to operate in either **IDE** (native/compatible) or **AHCI** (Advanced Host Controller Interface) modes from this menu. The **SATA mode** should be set to **AHCI** mode for this system (unless you are sure your hard disk can only operate in **IDE** mode). If you are unsure of the mode your hard disk supports contact your service center.

Legacy USB Support: (Advanced Menu)

Choose **“Enabled”** if you intend to use **USB** devices in systems which do not normally support USB functionality (e.g. DOS). The default setting is **“Enabled”** and does not need to be changed if you intend to use your USB devices in **Windows**.

Boot-time Diagnostic Screen (Advanced Menu)

Use this menu item to enable/disable the Boot-time Diagnostic Screen (see *“The Power-On Self Test (POST)” on page 5 - 2*).



SATA Mode Selection

If you have installed the **Windows 7** operating system with **AHCI** mode enabled (default setting), **DO NOT** disable AHCI mode (if you wish to disable AHCI mode you will need to reinstall the **Windows 7 OS**).

Legacy OS Boot (Advanced Menu)

If “**Enabled**” the system will attempt to load the Legacy OS (e.g. **Windows 7**) first. If set to “**Disabled**” the system will attempt to **EFI** (Extensible Firmware Interface) boot before the Legacy OS.

Power On Boot Beep (Advanced Menu)

Use this menu item to enable/disable the beep as the computer starts up.

Security Menu

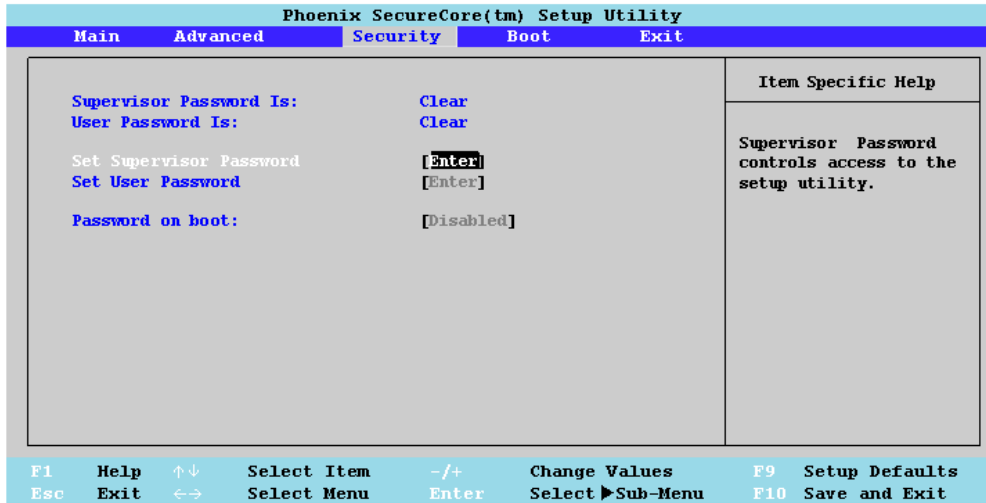



Security Menu

The changes you make here affect the access to the **Setup** utility itself, and also access to your machine as it boots up after you turn it on. These settings do not affect your machine or network passwords which will be set in your software OS.

5

Set Supervisor Password (Security Menu)

You can set a password for access to the **Phoenix SecureCore Setup Utility**. This will not affect access to the computer OS, (only the **Phoenix SecureCore Setup Utility**).

Figure 5 - 4 Security Menu



Password Warning

If you set a boot password (Password on boot is “Enabled”), **NEVER** forget your password.

The consequences of this could be serious. If you cannot remember your boot password you must contact your vendor and you may lose all of the information on your hard disk.

Set User Password (Security Menu)

You can set a password for user mode access to the **Phoenix SecureCore Setup Utility**. This will not affect access to the computer OS, (only the *Setup* utility) unless you choose to set a **Password on Boot** (see below). Many menu items in the **Phoenix SecureCore Setup Utility** cannot be modified in user mode. You can only set the user password after you have set the supervisor password.

Password on boot: (Security Menu)

Specify whether or not a password should be entered to boot the computer (**you may only set a password on boot if a supervisor password is enabled**). If “*Enabled*” is selected, only users who enter a correct password can boot the system (**see the warning in the sidebar**). The default setting is “*Disabled*”.

Note: To clear existing passwords press **Enter** and type the existing password, then press **Enter** for the new password (without typing any password entry) and **Enter** again to confirm the password clearance.

Boot Menu

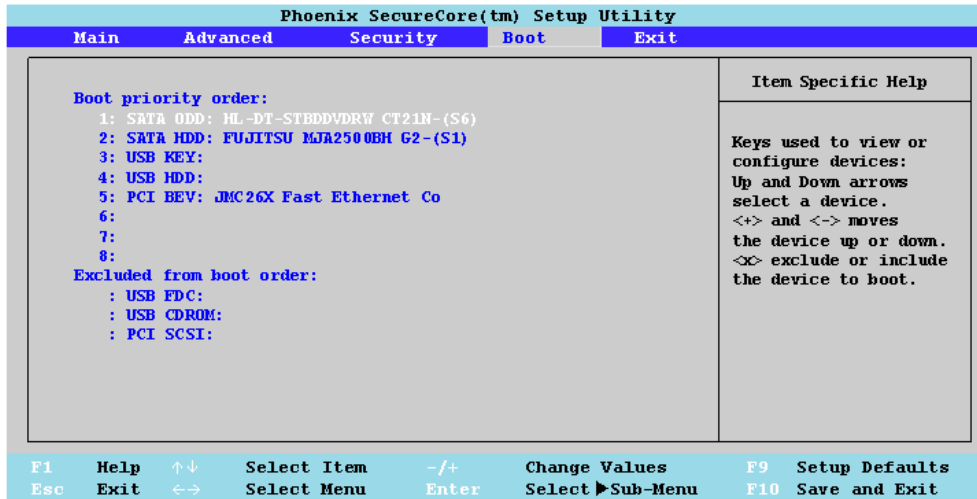

When you turn the computer on it will look for an operating system (e.g. *Windows 7*) from the devices listed in this menu, and **in this priority order**. If it cannot find the operating system on that device, it will try to load it from the next device in the order specified in the **Boot priority order**. Item specific help on the right is available to help you move devices up and down the order.



BIOS Screens

Note that the BIOS screens pictured on these pages are intended for guidance in setting up your system's BIOS.

BIOS versions are subject to constant change and revision, therefore your computer's actual screens may appear slightly different from those pictured on these pages.

Figure 5 - 5
Boot Menu

Exit Menu

Figure 5 - 6
Exit Menu

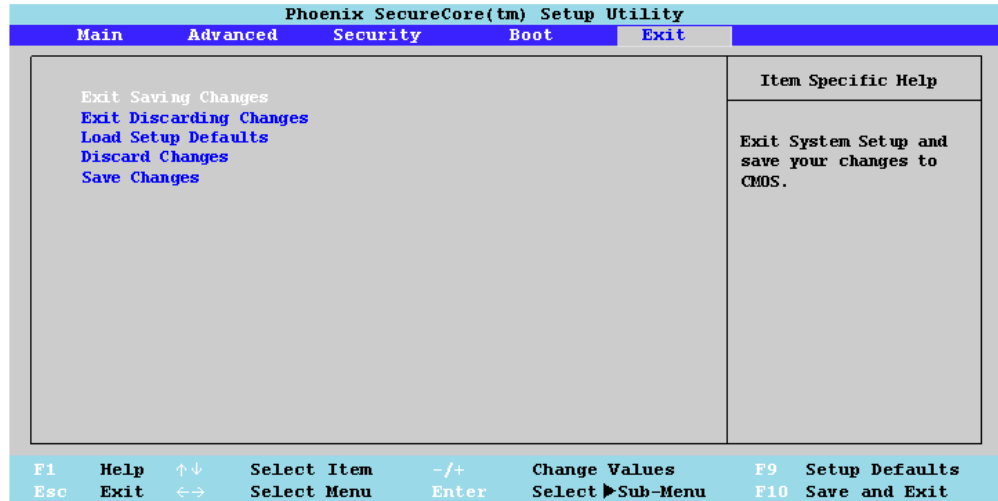

Choosing to *Discard Changes*, or *Exit Discarding Changes*, will wipe out any changes you have made to the *Setup*. You can also choose to restore the original *Setup* defaults that will return the *Setup* to its original state, and erase any previous changes you have made in a previous session.

Chapter 6: Upgrading The Computer

Overview

This chapter contains information on upgrading the computer. Follow the steps outlined to make the desired upgrades. If you have any trouble or problems you can contact your service representative for further help. Before you begin you will need:

- A small crosshead or Phillips screwdriver
- A small regular slotted (flathead) screwdriver
- An antistatic wrist strap

Before working with the internal components you will need to wear an antistatic wrist strap to ground yourself because static electricity may damage the components.

The chapter includes:

- Removing the Rear Top Cover
- Wireless Keyboard & Mouse USB Transceiver
- Upgrading the Hard Disk Drive
- Upgrading the System Memory (RAM)

Please make sure that you review each procedure before you perform it.



Warranty Warning

Please check with your service representative before undertaking any upgrade procedures to find out if this will VOID your warranty.



Power Safety Warning

Before you undertake any upgrade procedures, make sure that you have turned off the power, and disconnected all peripherals and cables (including telephone lines).

When Not to Upgrade

These procedures involve opening the system's case, adding and sometimes replacing parts.

You should **not** perform any of these upgrades if:

- Your system is still under warranty or a service contract
- You don't have all the necessary equipment
- You're not in the correct environment
- You doubt your abilities

Under any of these conditions, contact your service representative to purchase or replace the component(s).



Removal Warning

When removing any cover(s) and screw(s) for the purposes of device upgrade, remember to replace the cover(s) and screw(s) before turning the computer on.

Removing the Rear Top Cover

Before undertaking any upgrade procedure it is necessary to remove the rear top cover to access the components.

1. Turn **off** the computer and disconnect all cables and peripherals.
2. Carefully place the computer flat with the LCD facing down (make sure you cover the LCD to avoid scratches) so that you may access the rear cover.
3. Remove screws **1** - **4**.

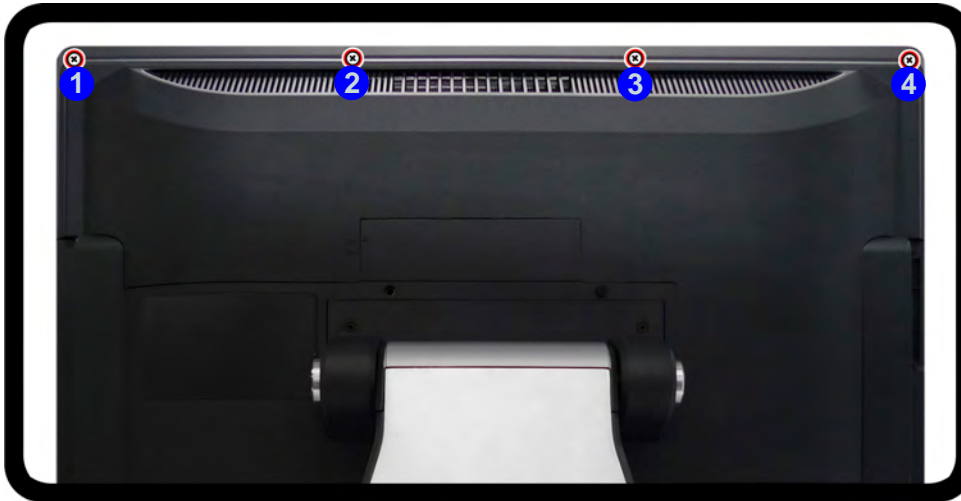

Figure 6 - 1
Rear Top Cover
Screws

Upgrading The Computer

- Slide the rear top cover until the arrow is aligned with the unlock icon **5**.

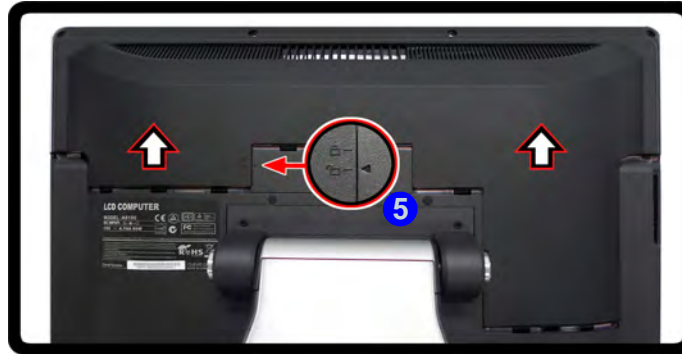

Figure 6 - 2
**Rear Top Cover
Unlock**

- When the arrow is aligned with the unlock icon you can remove the rear top cover **6**.

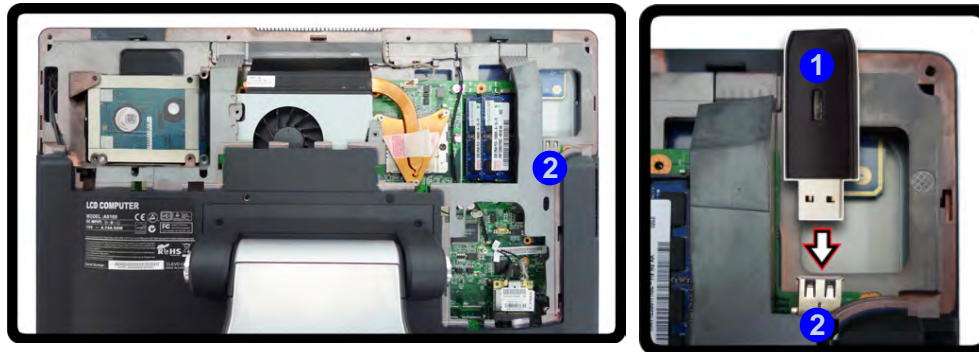

Figure 6 - 3
**Rear Top Cover
Removal**

Wireless Keyboard & Mouse USB Transceiver

If your purchase includes an optional Wireless Keyboard & Mouse Kit you can use the USB port located behind the rear top cover to house the USB transceiver.

1. Remove the rear cover (see *“Removing the Rear Top Cover”* on page 6 - 3).
2. Insert the USB transceiver **1** into the USB port **2**.
3. Replace the rear top cover and screws.



Dongle & USB Ports

A single USB dongle is provided with the keyboard, mouse and TV Tuner. This dongle acts as a transceiver for the keyboard and mouse, and as a RF transceiver for the TV Tuner. This dongle may be inserted into any of the USB ports, however if you have included the TV Tuner in your purchase option it is recommended that you do not plug the dongle into the USB port located behind the rear top cover in order to prevent any interference.

Figure 6 - 4
**USB Port for
 Wireless Keyboard
 & Mouse Kit**



HDD System Warning

New HDD's are blank. Before you begin make sure:
You have backed up any data you want to keep from your old HDD.
You have all the CD-ROMs and FDDs required to install your operating system and programs.
If you have access to the internet, download the latest application and hardware driver updates for the operating system you plan to install. Copy these to a removable medium.

Upgrading the Hard Disk Drive

The hard disk drive can be taken out to accommodate other 2.5" serial (SATA) hard disk drives with a height of 9.5mm (h) (see *"Storage" on page C - 3*). Follow your operating system's installation instructions, and install all necessary drivers and utilities (as outlined in *"Driver Installation Procedure" on page 4 - 5*), when setting up a new hard disk.

1. Remove the rear cover (see *"Removing the Rear Top Cover" on page 6 - 3*).
2. Remove screws ① - ③.

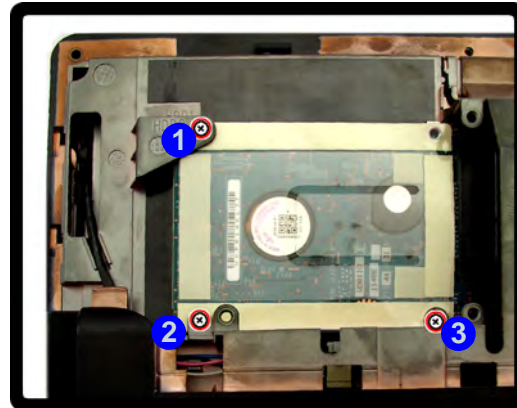
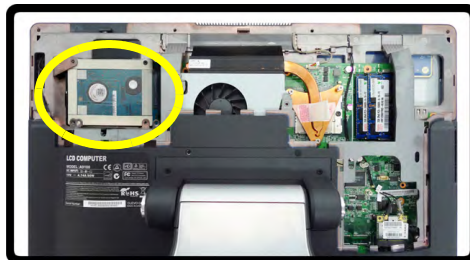

Hard Disk Slot

Make sure you install the hard disk into the lower slot on the mainboard.

Figure 6 - 5
Hard Disk Screws

- Slide the hard disk in the direction of arrow 4, and then slide it in the direction of arrow 5 to remove it.

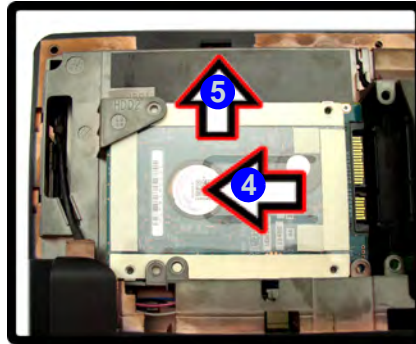

Figure 6 - 6
Hard Disk Assembly
Removal

- Remove the adhesive hard disk cover 6.



Figure 6 - 7
Hard Disk Cover
Removal

- Reverse the process to install a new hard disk.



Contact Warning

Be careful not to touch the metal pins on the module's connecting edge. Even the cleanest hands have oils which can attract particles, and degrade the module's performance.

Upgrading the System Memory (RAM)

The computer has **two** memory sockets for 204 pin Small Outline Dual In-line (SO-DIMM) **DDRIII (DDR3)** type memory modules (see *“Memory” on page C - 3* for details of supported module types).

The total memory size is automatically detected by the POST routine once you turn on your computer.

1. Remove the rear cover (see *“Removing the Rear Top Cover” on page 6 - 3*).
2. The RAM is located at point **1**.

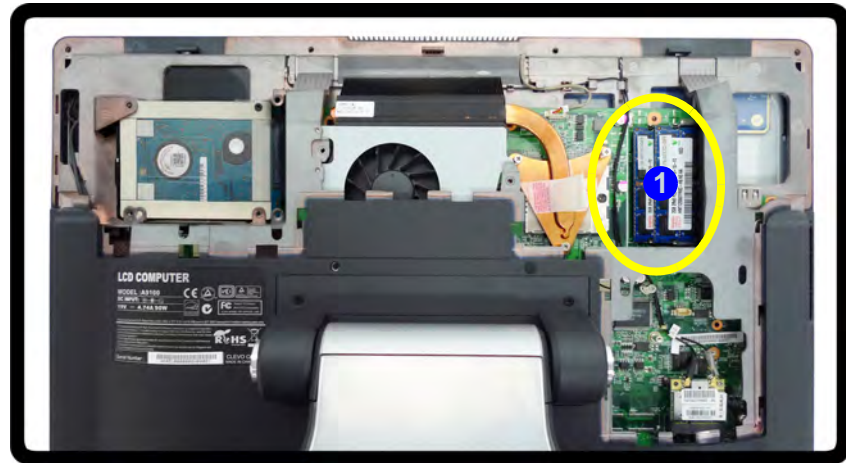

Figure 6 - 8
RAM Location

3. Gently pull the two release latches on the sides of the memory socket in the direction indicated by the arrows (2 & 3) in *Figure 6 - 9*.

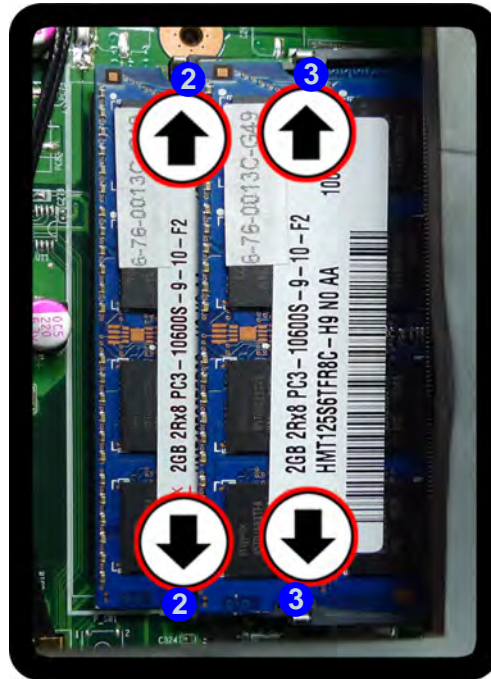

Figure 6 - 9
RAM Module
Release

4. The RAM module will pop-up, and you can remove it.
5. Pull the latches to release the second module if necessary.

Upgrading The Computer

6. Insert a new module holding it at about a 30° angle and fit the connectors firmly into the memory socket (see sidebar note if you are inserting a single module).

Figure 6 - 10
**RAM Module
Removal**



Single Memory Module Installation

If your computer has a single memory module, then insert the module into the **Channel 0 (JDIMM1)** socket. In this case this is the **upper memory socket** (the socket furthest from the mainboard).

7. The module's pin alignment will allow it to only fit one way. Make sure the module is seated as far into the slot as it will go. **DO NOT FORCE** the module; it should fit without much pressure.
8. Press the module in and down towards the mainboard until the slot levers click into place to secure the module.
9. Replace the module bay cover and screws.
10. Restart the computer to allow the BIOS to register the new memory configuration as it starts up.

Upgrading the Processor

If you want to upgrade your computer by replacing the existing processor with a faster/new one you will need to contact your customer service representative. We recommend that you do not do this yourself, since if it is done incorrectly you may damage the processor or mainboard.



Warranty

The CPU is not a user serviceable part. Accessing the CPU in any way, may violate your warranty.

Unauthorized tampering with the HDD may also violate your warranty.

Chapter 7: Modules & Options

Overview

This chapter contains information on the following modules, which may come with your computer, depending on the configuration purchased. If you are unsure please contact your service representative.

- PC Camera Module
- Wireless LAN Module
- Bluetooth & WLAN Combo Module
- Touch Screen Module
- TV Tuner Module



PC Camera Screen Refresh

The PC Camera module supports a frame rate of 12 fps. If you find that the screen refresh rate is subject to lag or stuttering, then **reduce the window size**, or adjust the **Output Size**.

To reduce **Output Size** run the **camera** application, click **Options** and select **Video Capture Pin**. Adjust the settings from the **Output Size** pull-down menu (see page **7-6**).

PC Camera Module

There are a number of different camera modules available with this computer model series. You will have the appropriate application installed for your camera. **Make sure you access the application via the desktop shortcut.** The PC Camera module uses the camera application to capture video files. Install the driver as per the instructions below.



Latest PC Camera Driver Information

Check the *Device Drivers & Utilities + User's Manual disc*, and any accompanying insert pages, for the latest updated information on the PC Camera driver, which may override the information provided here.

PC Camera Driver Installation

1. Insert the *Device Drivers & Utilities + User's Manual* disc into the CD/DVD drive.
2. Click **Option Drivers** (button).
3. Click **1.Install Webcam Driver > Yes**.
4. Click **Next > Install > Finish** to restart the computer.
5. Run the camera application program from the desktop shortcut.

PC Camera Audio Setup

If you wish to capture video & **audio** with your camera, it is necessary to connect a microphone to either of the microphone ports and then setup the audio recording options in *Windows* as follows.

1. Click **Start**, and click **Control Panel** (or point to **Settings** and click **Control Panel**).
2. Click **Sound**  (**Hardware and Sound**).
3. Click **Recording** (tab).
4. Right-click **Microphone** and make sure the item is not disabled.
5. Double-click **Microphone** (or select **Properties** from the right-click menu).
6. Click **Levels** (tab), and adjust the **Microphone** sliders to the level required.
7. Click **OK** and close the control panels.
8. Run the camera application from the desktop shortcut.
9. Go to the **Devices** menu heading and select **Microphone** (it should have a tick alongside it).
10. Go to the **Capture** menu heading and select **Capture Audio** (it should have a tick alongside it).

Modules & Options

Figure 7 - 1
Audio Setup for PC
Camera

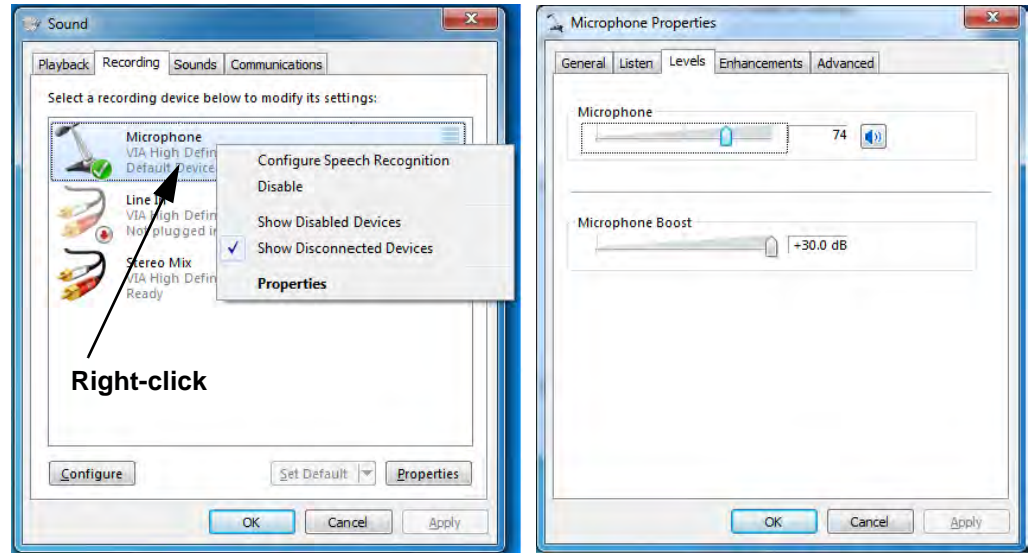

7

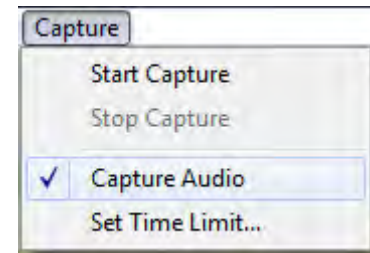
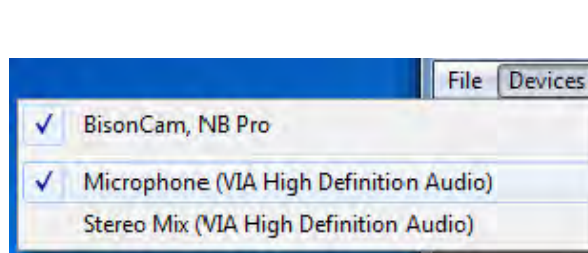

Camera Application

The camera application is a video viewer for general purpose video viewing and testing, and for capturing video files to .avi format.

1. Run the camera application from the desktop shortcut (it is recommended that you **set the capture file** before the capture process - **see Set Capture File below**).
2. Go to the **Capture** menu heading (if you wish to capture audio check **“PC Camera Audio Setup” on page 7 - 3**) and select **Start Capture**.
3. Click **OK** (the file location will be displayed in the pop-up box) to start capturing the video, and press **Esc** to stop the capture (you can view the file using the **Windows Media Player**).

Set Capture File

Prior to capturing video files you may select the **Set Capture File...** option in the **File** menu, and set the file name and location before capture (this will help avoid accidentally overwriting files). Set the name and location then click **Open**, then set the **“Capture file size:”** and click **OK**. You can then start the capture process as above.

Note the important information in **“Reducing Video File Size” on page 7 - 6** in order to save file space, and help prevent system problems.

Reducing Video File Size

Note that capturing high resolution video files requires a substantial amount of disk space for each file. After recording video, check the video file size (right-click the file and select **Properties**) and the remaining free space on your hard disk (go to **My Computer**, right-click the hard disk, and select **Properties**). If necessary you can remove the recorded video file to a removable medium e.g. CD, DVD or USB Flash drive.

Note that the *Windows* system requires a minimum of **15GB** of free space on the **C: drive** system partition. In order to prevent system problems it is recommended that you save the captured video file to a location other than the **C: drive** (see “*Set Capture File*” on page 7 - 5), limit the file size of the captured video or reduce video resolution (see below).

To Reduce Video Resolution Output Size:

1. Run the camera application program from the desktop shortcut.
2. Go to **Options** and scroll down to select **Video Capture Pin...**
3. Click the **Output Size** drop box and select a lower resolution size in order to reduce the captured file size.
4. Click **OK**.

Eliminating Screen Flicker

If you find that the video screen in the camera application is flickering, you can try to adjust the setting in the **Video Capture Filter** options.

1. Run the camera application program from the desktop shortcut.
2. Go to **Options** and scroll down to select **Video Capture Filter...**
3. Click either **50Hz** or **60Hz** under **Powerline Frequency (Anti Flicker)**.

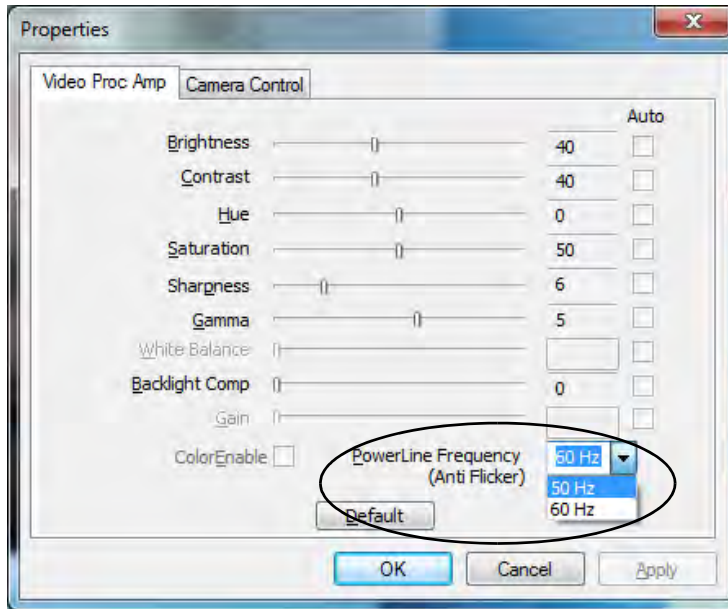

Figure 7 - 2
Video Capture Filter



Snapshot Folder

The Snapshot folder's default location is on the desktop. Do not move this folder or an error may appear when you try to take a still picture.

If you accidentally delete or move the folder, you can create a new Snapshot folder on the desktop in order to capture the files.

Taking Still Pictures

The camera application allows you to take still pictures.

1. Run the camera application from the desktop shortcut.
2. Go to **Options** and select **Take Picture**.
3. The picture (in JPEG format) will be placed in the **Snapshot** folder on the desktop.



on the desktop.

Wireless LAN Module

If you have included an **802.11b/g/n WLAN** module in your purchase option, install the driver as per the procedure overleaf.

Make sure you install the drivers in the order indicated in *Table 4 - 1, on page 4 - 3*.

802.11b/g/n Driver Installation

1. Insert the *Device Drivers & Utilities + User's Manual* disc into the CD/DVD drive.
2. Click **Option Drivers** (button).
3. Click **2.Install WLAN Driver > Yes**.
4. Choose the language you prefer and click **Next**.
5. Click **Next > Install**.
6. Click **Finish** to restart the computer.

Note: The operating system is the default setting for Wireless LAN control in *Windows* (see overleaf).



Network and Sharing Center

You can also use the **Network and Sharing Center** control panel in Windows (**Network and Internet**) to connect to any available wireless networks.

Connecting to a Wireless Network in Windows 7

Make sure the Wireless LAN module is turned on.

1. **Click** the taskbar wireless icon , and then double-click an access point to connect to or click to **Open Network and Sharing Center** if you do not see a network you want to connect to in the taskbar menu (a list of options will appear allowing setting changes, and creating a new network).

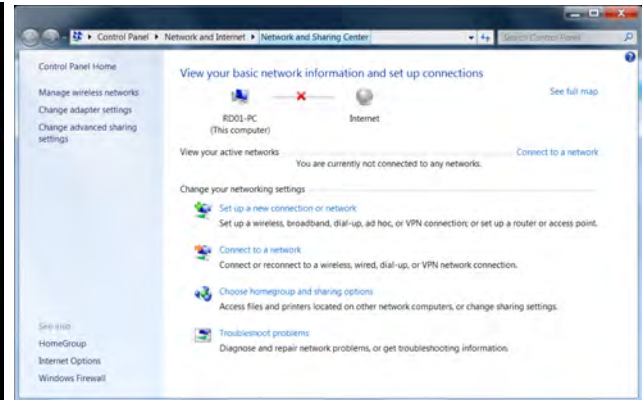

Figure 7 - 3

Click Taskbar Icon Menu & Network and Sharing Center

2. You may need to enter a security key for any access point to which you are trying to connect.
3. Click to select a network location (e.g. **Home, Work or Public**).
4. Click “**View or change settings in Network and Sharing Center**” to access further options for the connection.

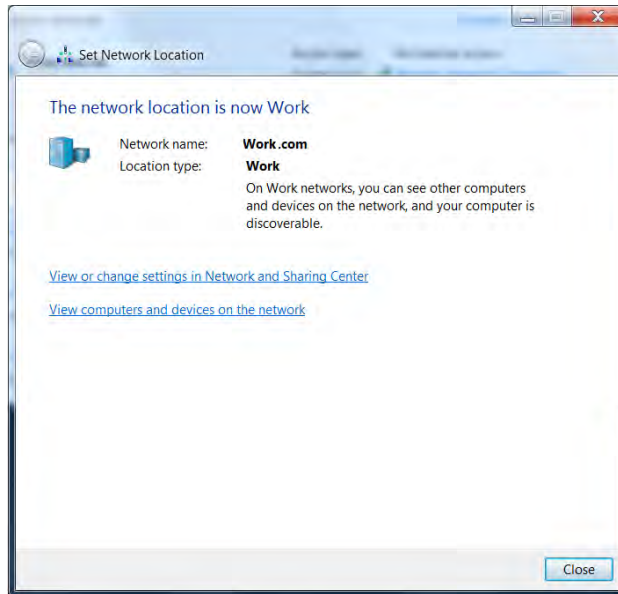

Figure 7 - 4
Network Location Set

Modules & Options



Security Enabled Networks

You should try to make sure that any network you are connecting to is a secure network.

Connecting to unsecure networks may allow unauthorized access to your computer, documents, websites and files etc.



5. Click the taskbar icon  to see any currently connected networks.
6. To disconnect from the wireless network you can click the taskbar wireless icon , click the active connection and then click **Disconnect** (button).



Figure 7 - 5

**Click Taskbar Icon
Menu - Disconnect**

Windows Mobility Center

The **Windows Mobility Center** control panel provides an easy point of access for information on display, audio, power plans used and wireless device status etc.

To access the Windows Mobility Center:

1. Click **Start**, and click **Control Panel** (or point to **Settings** and click **Control Panel**).
2. Double-click **Windows Mobility Center (Hardware and Sound)**.
3. Click the button to **Turn wireless off/on**, or click the icon  to access the network menu.

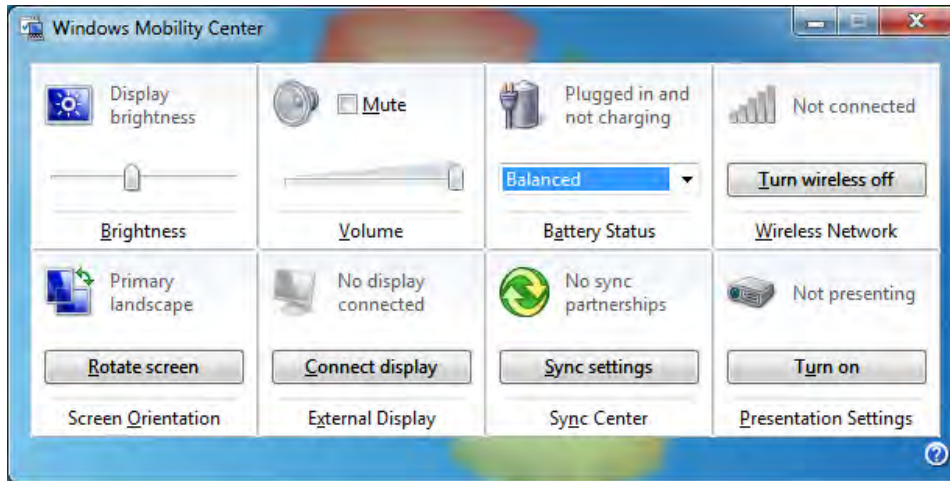

Figure 7 - 6
Windows Mobility Center

Bluetooth & WLAN Combo Module

If your purchase option includes the **Combination Wireless LAN & V3.0 Bluetooth module** then install the driver as instructed overleaf. Follow the instructions on page [7 - 20](#) to configure the Bluetooth settings.



Bluetooth Data Transfer

Note that the transfer of data between the computer and a Bluetooth enabled device is supported in **one direction only (simultaneous data transfer is not supported)**. Therefore if you are copying a file from your computer to a Bluetooth enabled device, you will not be able to copy a file from the Bluetooth enabled device to your computer until the file transfer process from the computer has been completed.

High Speed Bluetooth Data Transfer

The **Combination Wireless LAN & V3.0 Bluetooth module** supports high speed (V3.0) data transfer. However to achieve such transfer speeds, **both devices must support high speed data transfer**.

To obtain high speed (V3.0) data transfer make sure that the WLAN module is not turned off in the Windows Mobility Center (see page [7 - 13](#)).

Check your Bluetooth compatible device's documentation to confirm it supports high speed data transfer.

Bluetooth Combo Driver Installation

1. Insert the *Device Drivers & Utilities + User's Manual* disc into the CD/DVD drive.
2. Click **Option Drivers** (button).
3. Click **3.Install Combo BT Driver > Yes**.
4. Choose the language you prefer and click **OK**.
5. Click **Next**.
6. Click the button to accept the license and click **Next**.
7. Click **Next >** (*select if you want to create an icon to appear on the desktop*)
Next > Install.
8. Click **Finish**.
9. The **My Bluetooth** icon  will appear on the desktop and the **Bluetooth** item will be installed in the **Programs/All Programs** menu.
10. See *“Bluetooth Networking Setup” on page 7 - 19* for information on Bluetooth networking.

Bluetooth & WLAN Combo Settings

1. Double-click the **My Bluetooth** application on the desktop (or access it from the **Programs/All Programs** menu)
2. Click **My Bluetooth Settings** (menu heading).

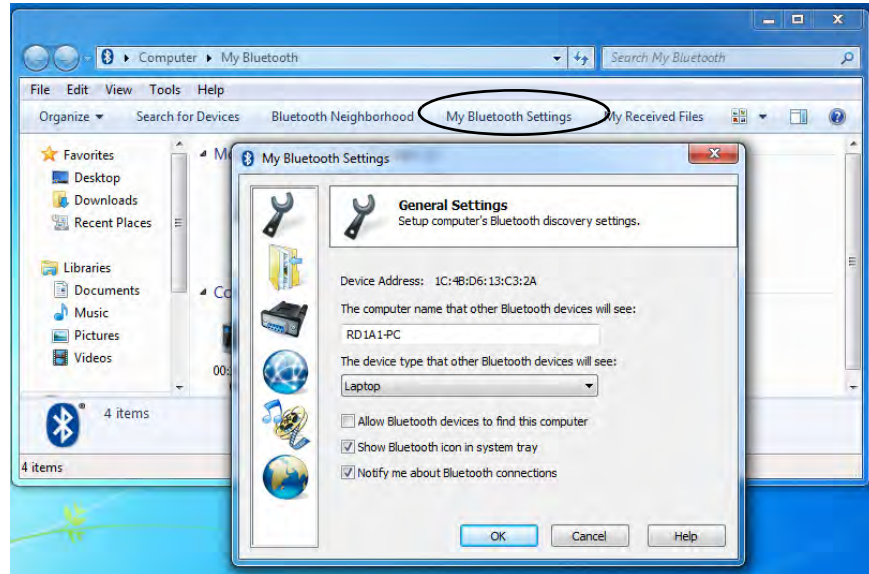

7
Figure 7 - 7
My Bluetooth Settings

3. Click **General Settings**  to change the computer **name that other Bluetooth devices will see**, and click the tickbox to **Allow Bluetooth devices to find this computer**
4. Click **OK** to confirm the settings.

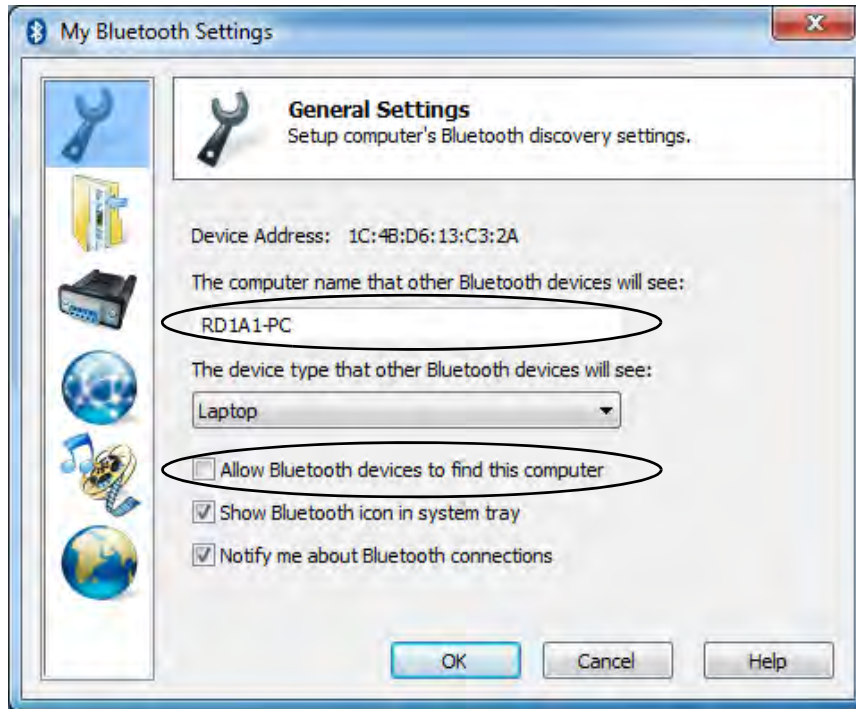
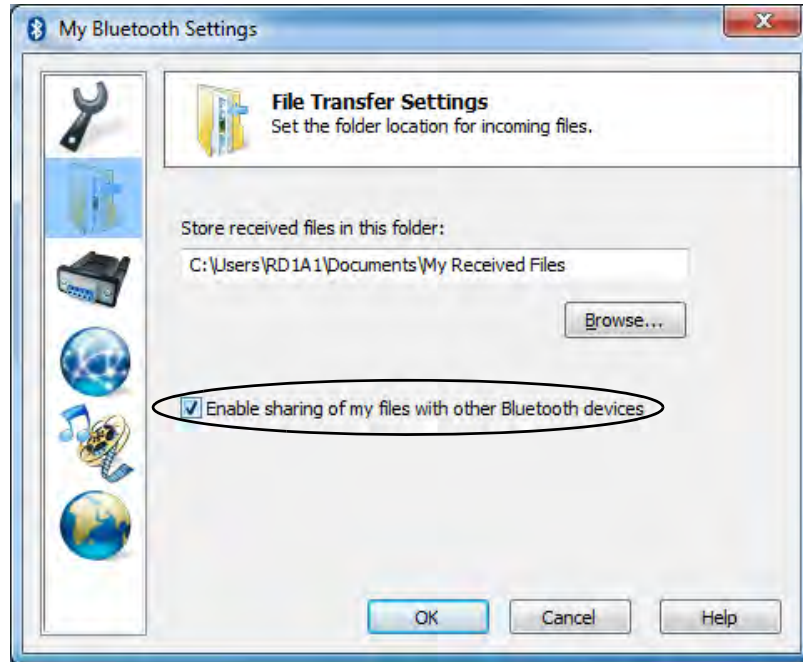

Figure 7 - 8
General Settings

Modules & Options

5. Click **File Transfer Settings**  to **Enable sharing of my files with other Bluetooth devices**.
6. Click **OK** to confirm the settings.



7

Figure 7 - 9
File Transfer Settings

Bluetooth Networking Setup

1. Double-click the **My Bluetooth** application on the desktop (or access it from the **Programs/All Programs** menu).
2. Click **My Bluetooth Settings** (see *Figure 7 - 7 on page 7 - 16*).

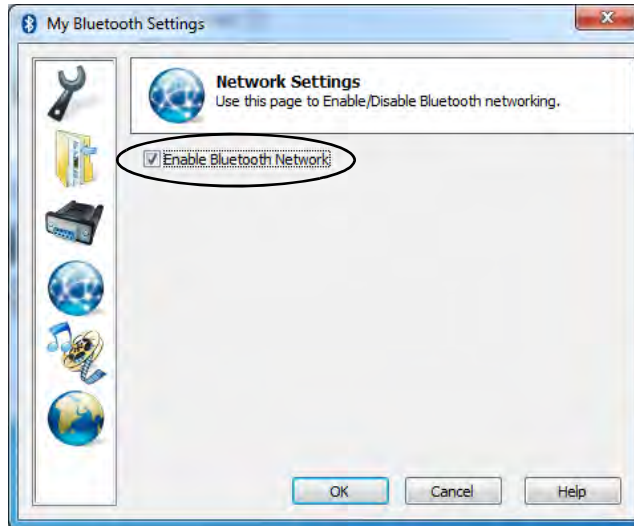

3. Click **Network Settings** (make sure the Bluetooth module is powered on).
4. Click **Enable Bluetooth Network** and click **OK**.
5. A message will appear in the taskbar to confirm that the network driver has been installed.

Figure 7 - 10
Network Settings

Bluetooth & WLAN Combo Module Configuration

Setup your Bluetooth Device so the Computer Can Find it

1. Turn your Bluetooth device (e.g. PDA, mobile phone etc.) on.
2. Make the device discoverable (to do this check your device documentation).

To Add a Bluetooth Device

1. Double-click the **My Bluetooth** application on the desktop (or access it from the **Programs/All Programs** menu).
2. Double-click the device you want to pair with the computer (if no devices appear press **F5** or click the **Refresh** button to search for devices).

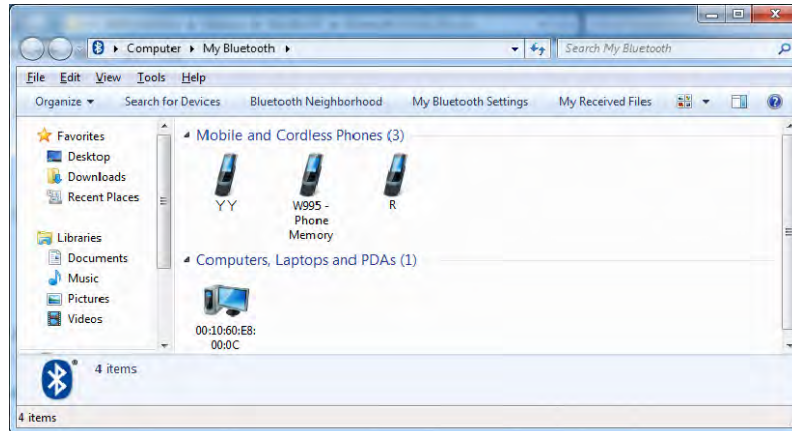

Figure 7 - 11
My Bluetooth
Devices

3. You will then be presented with a menu of options to select from.



4. Click the appropriate button to connect to the device.

Figure 7 - 12
Bluetooth Device
Options

Modules & Options

5. You may need to allow the connection from your device, and you will then need to provide a passcode from the device.
6. You can then enter the passcode on the computer and click **OK** to establish the connection.

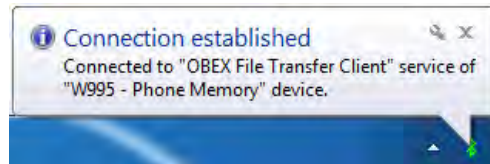
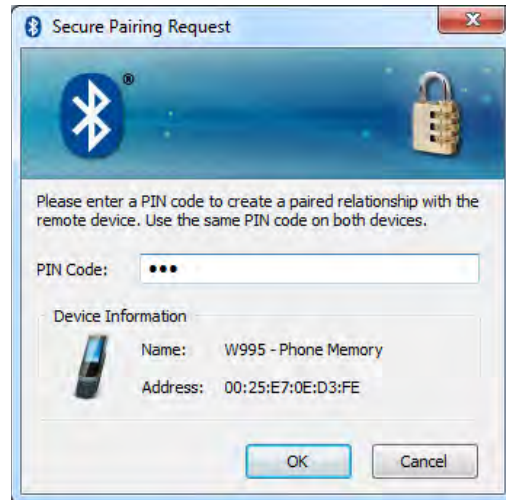

7

Figure 7 - 13
**Bluetooth Pairing
Code & Connection
Established**

Touch Screen Module

If you have included a Touch Screen module in your purchase option, you should obtain a stylus pen to interact with the computer in the same way you would use a mouse (use a stylus pen to tap/double-tap on-screen buttons etc.). Make sure you install the driver as indicated below.

Touch Screen Driver Installation

1. Insert the *Device Drivers & Utilities + User's Manual* disc into the CD/DVD drive.
2. Click **Option Drivers** (button).
3. Click **4.Install Touch Screen Driver > Yes**.
4. Click **Next > Next**.
5. Click **Finish** to restart the computer.



Touch Screen Input Device

Do not use any sharp or pointed objects as your input device e.g. the end of a pen or pencil. You should preferably only use a stylus pen (PDA type) as your input device.

Be very careful not to press too hard with the stylus pen when using it as the input device.

Tablet PC Options

Tablet PC settings (for touch screen input) may be customized from the **Tablet PC Settings** in *Windows 7*.

1. To access the control panel click **Start**, and then click **Control Panel**.
2. The **Tablet PC Settings** and **Pen and Touch** control panel are in the **Hardware and Sound** category.

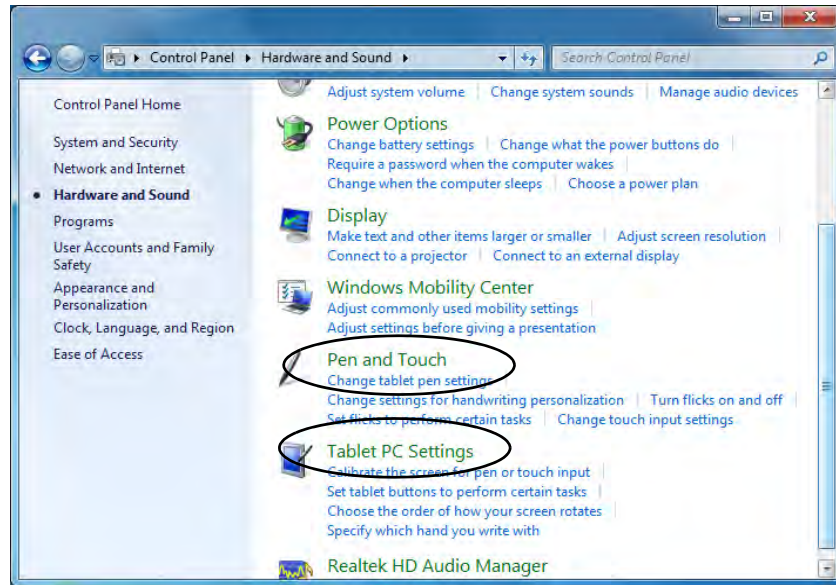

Figure 7 - 14
**Pen and Touch &
Tablet PC Settings
Control Panels**

3. Click **Tablet PC Settings** and click **Other**.
4. Click **Go to Input Panel Settings** (in **Tablet PC Input Panel Options**) to configure where and how the **Tablet PC Input Panel** appears.

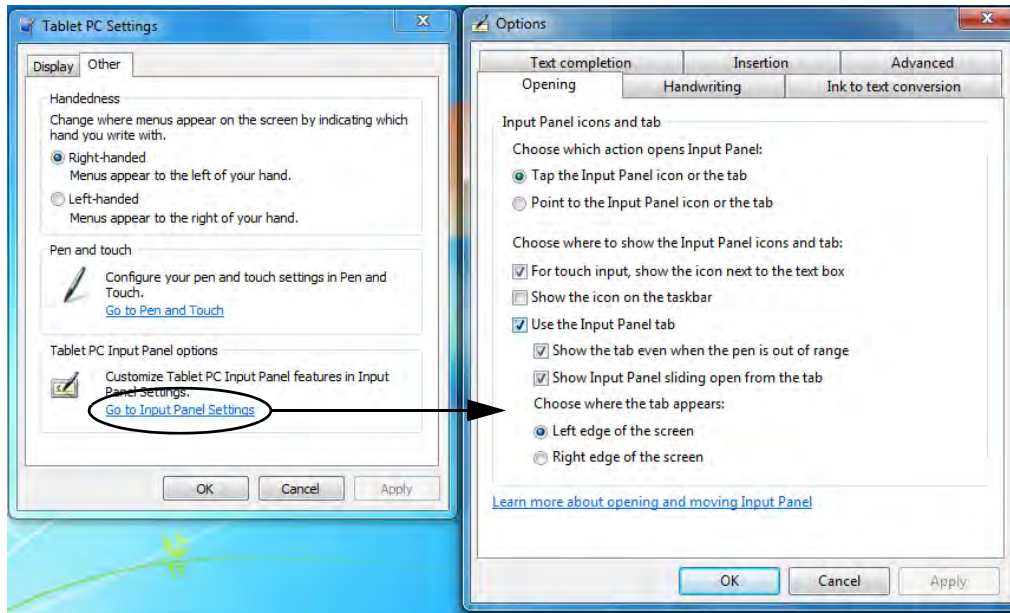
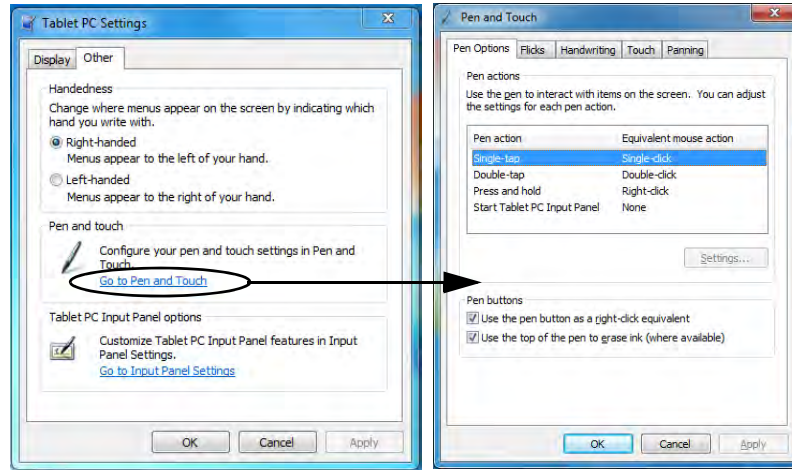

Figure 7 - 15
Input Panel Settings

5. Click **Go to Pen and Touch** (in **Tablet PC Input Panel Options**) to configure the **Pen Options**, **flicks** and **handwriting** etc.

Figure 7 - 16
Pen and Touch Settings



6. When not in use the **Tablet PC Input Panel** docks at the side of the screen (and may be docked at either side of the screen at any height) with just a small portion visible.

Figure 7 - 17
Tablet PC Input Panel



7. Move the pen over the TIC and then tap it to activate it. The input panel allows you to input text without the use of a keyboard.
8. You can use the writing pad (write continuously), character pad (write one character at a time) or touch keyboard to input text.
9. Use **Help topics** from the **Tools** menu for further information.

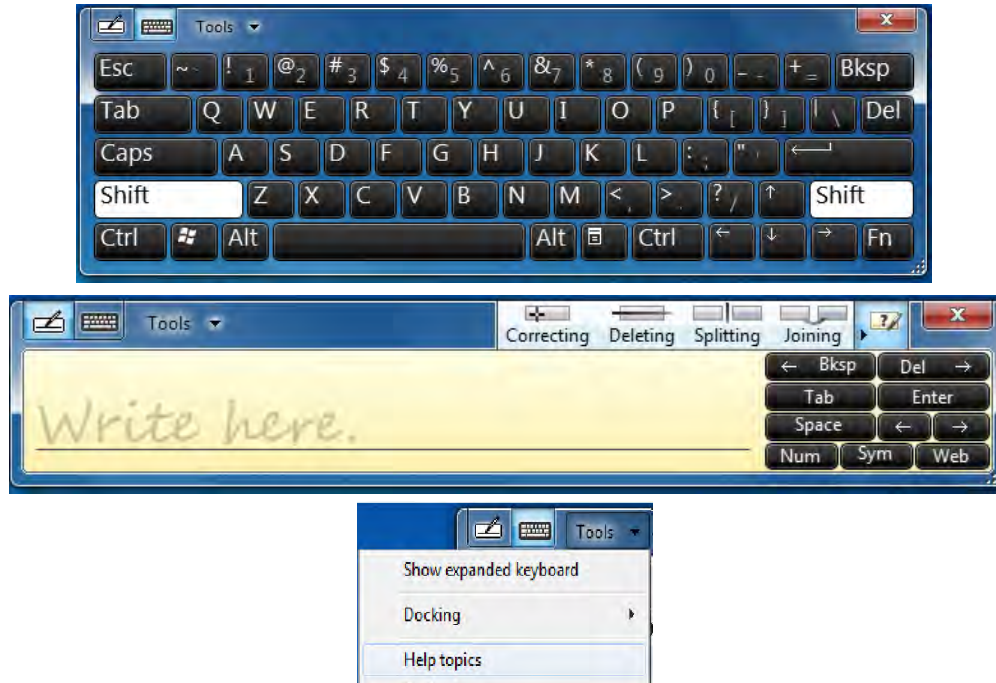

Figure 7 - 18
**Touch Keyboard,
 Writing Pad & Help
 Topics**



TV Antenna

The TV antenna supplied with any TV Tuner module is intended for indoor use only. Please do not use your TV Tuner module outdoors.

TV Tuner Module

The optional TV Tuner allows you to watch TV, play music CDs, video conference and capture still images and video on your PC.



If your purchase configuration includes the **optional Digital** TV Tuner module, you will be supplied with a remote control unit and USB transceiver dongle for the module. Software support for the TV Tuner module is provided by *Windows Media Center* in *Windows 7* (not included in *Starter* or *Home Basic* versions).

You can plug the USB transceiver dongle into any of the computer's USB ports, however **it is recommended that you do not plug the dongle into the USB port located behind the rear top cover** (see *Figure 6 - 4 on page 6 - 5*) in order to prevent any interference.



Figure 7 - 19
TV Tuner Remote

Windows Media Center

1. This TV Tuner module is fully supported by *Windows Media Center* in *Windows 7 (not included in Starter or Home Basic versions)*.
2. Run *Windows Media Center* directly from the **Start** menu (**Start > Programs > Windows Media Center**).
3. *Windows Help and Support* provides information on the **Windows Media Center** functions. Click **Start**  and select **Help and Support**, and then type “*Media Center*” in the **Search Help** box and click the magnifying glass icon  to bring up the results.



TV Tuner Module Support

Note that the TV Tuner module options in *Windows 7* is supported by the **Windows Media Center** software which comes built-in to all the *Windows 7 versions except Starter and Home Basic*.

If your purchase includes a TV Tuner option, and you are re-configuring your system for a different system, you should install any *Windows 7* version except *Starter* and *Home Basic*.

TV Recording and Power Plans

If you intend to use the **optional** TV Tuner to record live TV, then go to the **Power Options** control panel and create a power plan (see “*Power Plans*” on page 3 - 4) to prevent the power saving options from adjusting the computer’s performance level.

Remote Control Unit

The remote control unit allows you to remotely start and send the system into a power saving state, to run *Windows Media Center* and to navigate the *Media Center* menus etc. The remote control unit also gives full control over all TV and video functions.

Chapter 8: Troubleshooting

Overview

Should you have any problems with your computer, before consulting your service representative, you may want to try to solve the problem yourself. This chapter lists some common problems and their possible solutions. This can't anticipate every problem, but you should check here before you panic. If you don't find the answer in these pages, make sure you have followed the instructions carefully and observed the safety precautions in the preface. If all else fails, talk to your service representative. You should also make a record of what happened and what remedies you tried.

Of course, if something goes wrong, it will happen at the most inconvenient time possible, so you should preview this section just in case. If, after you've tried everything, and the system still won't cooperate, try turning it off for a few minutes and then rebooting. You will lose any unsaved data, but it may start working again. Then call your service representative.

Basic Hints and Tips

Many of the following may seem obvious but they are often the solution to a problem when your computer appears not to be working.

- **Power** - Is the computer actually plugged into a working electrical outlet? If plugged into a **power strip**, make sure it is actually working. Check the **LED Power & Communication Indicators** (see “*LED Indicators & Buttons*” on page 1 - 8) to see the computer’s power status.
- **Connections** - Check all the **cables** to make sure that there are no **loose connections** anywhere.
- **Power Savings** - Make sure that the system is not in **Hibernate** or **Sleep** mode by pressing the keys configured in your *Power Options*, or power button, to wake-up the system.
- **Brightness** - Check the brightness of the screen by pressing the brightness buttons to adjust the brightness.
- **Display Choice** - Make sure the system is not set to “external only” display if an external display is attached.
- **Boot Drive** - Make sure there are no **optical media and/or USB storage devices** in any connected drive when you start up your machine (this is a common cause of the message “*Invalid system disk - Replace the disk, and then press any key*” / “*Remove disks or other media. Press any key to restart*”).

Backup and General Maintenance

- Always **backup** your important data, and keep copies of your OS and programs safe, but close to hand. Don't forget to note the **serial numbers** if you are storing them out of their original cases, e.g. in a CD wallet.
- Run **maintenance programs** on your hard disk and OS as often as you can. You may schedule these programs to run at times when you are not using your computer. You can use those that are provided free with your OS, or buy the more powerful dedicated programs to do so.
- Write down your passwords and keep them safe (away from your computer). This is especially important if you choose to use a **Supervisor** password for the BIOS (see *“Security Menu” on page 5 - 11*).
- Keep copies of vital **settings files** such as network, dialup settings, mail settings etc.(even if just brief notes).



Warranty

The CPU is not a user serviceable part. Accessing the CPU in any way, may violate your warranty.

Viruses

- Install an **Anti-Virus** program and keep the **definitions file** (the file which tells your program which viruses to look for) up to date. New computer viruses are discovered daily, and some of them may seriously harm your computer and cause you to lose data. **Anti-Virus** programs are commercially available and the **definitions file updates** are usually downloadable directly from the internet.
- Be careful when opening e-mail from sources you don't know. **Viruses** are often triggered from within **e-mail attachments** so take care when opening any attached file. You can configure most **Anti-Virus** programs to check all **e-mail attachments**. **Note:** You should also beware of files from people you know as the virus may have infected an **address book** and been automatically forwarded without the person's knowledge.
- Keep a "**Bootable CD-ROM/DVD-ROM/USB storage device**" (this CD/DVD/USB device provides basic information which allows you to startup your computer) handy. You may refer to your OS's documentation for instructions on how to make one, and many **Anti-Virus** programs will also provide such a disk (or at least instructions on how to make one).

Upgrading and Adding New Hardware/Software

- Do not be tempted to make changes to your **Windows Registry** unless you are very sure of what you are doing, otherwise you will risk severely damaging your system.
- Don't open your computer or undertake any repair or upgrade work if you are not comfortable with what you are doing.
- Read the **documentation**. We can assume, since you are reading this that you are looking at the computer's manual, but what about any new peripheral devices you have just purchased? Many problems are caused by the installation of new hardware and/or software. Always refer to the documentation of any new hardware and/or software, and pay particular attention to files entitled "**READ ME**" or "**READ ME FIRST**".
- When installing a new device always make sure the device is powered on, and in many cases you will need to restart the computer. Always check that all the cables are correctly connected.
- Make sure you have installed the **drivers** for any new hardware you have installed (latest **driver files** are usually available to download from vendor's websites).

Troubleshooting

- Thoroughly check any **recent changes** you made to your system as these changes may affect one or more system components, or software programs. If possible, go back and undo the change you just made and see if the problem still occurs.
- Don't over complicate things. The less you have to deal with then the easier the source of the problem may be found; **Example** - if your computer has many devices plugged into its ports, and a number of programs running, then it will be difficult to determine the cause of a problem. Try disconnecting all of the devices and restarting the computer with all the peripheral devices unplugged. A process of elimination (adding and removing devices and restarting where necessary) will often find the source of a problem, although this may be time consuming.

Problems & Possible Solutions

Problem	Possible Cause - Solution
The computer feels too hot.	Make sure the computer is properly ventilated and the Vent/Fan intakes are not blocked. If this doesn't cool it down, put the system into Hibernate mode or turn it off for an hour. Make sure the computer isn't sitting on a thermal surface (see " Overheating " on page 1 - 13). Make sure you're using the correct adapter.
Nothing appears on screen.	<p><i>The system is in a power saving mode.</i> Press the power button or any configured sleep/resume key combination.</p> <p><i>The screen controls need to be adjusted.</i> Press the brightness buttons to adjust the settings. If you're connected to an external monitor, make sure it's plugged in and turned on. You should also check any attached monitor's own brightness and contrast controls.</p> <p><i>The screen saver is activated.</i> Press any key on the keyboard.</p>
No image appears on the external monitor I have plugged in and powered on.	<i>You haven't installed the video driver and configured it appropriately from the Control Panel.</i> See for instructions on installing and configuring the video driver.
The sound cannot be heard or the volume is very low.	<i>The volume might be set too low.</i> Check the volume control in the Volume Control Panel in the Windows taskbar, or use the volume buttons to adjust the setting (see " Audio Features " on page 2 - 8).
The compact disc cannot be read.	<i>The compact disc is dirty.</i> Clean it with a CD-ROM cleaner kit.

Troubleshooting

Problem	Possible Cause - Solution
The compact disc tray will not open when there is a disc in the tray.	<i>The compact disc is not correctly placed in the tray. Gently try to remove the disc using the eject hole (see “Loading Discs” on page 2 - 3).</i>
The DVD regional codes can no longer be changed.	<i>The code has been changed the maximum 5 times. See “DVD Regional Codes” on page 2 - 5.</i>
You forget the boot password.	<i>If you forget the password, you may have to discharge the battery of the CMOS. Contact your service representative for help.</i>
 <p>Password Warning</p> <p>If you choose to set a boot password, NEVER forget your password. The consequences of this could be serious. If you cannot remember your boot password you must contact your vendor and you may lose all of the information on your hard disk.</p>	
A file cannot be copied to/from a connected Bluetooth device.	<i>The transfer of data between the computer and a Bluetooth enabled device is supported in one direction only (simultaneous data transfer is not supported). If you are copying a file from your computer to a Bluetooth enabled device, you will not be able to copy a file from the Bluetooth enabled device to your computer until the file transfer process from the computer has been completed</i>

Problem	Possible Cause - Solution
<p>The Wireless LAN cannot connect to an access point.</p>	<p><i>The WLAN module is turned off in the Windows Mobility Center. Make sure that Wireless is ON in the Mobility Center to ensure proper function key behavior (see “Windows Mobility Center” on page 7 - 13).</i></p>
<p>My TV Tuner is experiencing interference.</p>	<p><i>The USB dongle is plugged into the USB port located behind the rear top cover (see Figure 6 - 4 on page 6 - 5) and this causes interference. A single USB dongle is provided with the keyboard, mouse and TV Tuner. This dongle acts as a transceiver for the keyboard and mouse, and as a RF transceiver for the TV Tuner. This dongle may be inserted into any of the USB ports, however if you have included the TV Tuner in your purchase option it is recommended that you do not plug the dongle into the USB port located behind the rear top cover in order to prevent any interference.</i></p>

Bluetooth Connection Problems

If you are experiencing problems connecting to some Bluetooth devices (in particular certain mobile phones and headsets) it may be necessary to download and install the **Windows Mobile Device Center** software (for *Windows Vista* and *Windows 7*). Go to the Microsoft website and search for the **Microsoft Windows Device Center Driver for Windows Vista (64-bit or 32-bit) and Windows 7 (64-bit or 32-bit)**, and then download the driver.

1. Install the **Microsoft Windows Device Center Driver** as appropriate for your operating system.
2. **Windows Vista** will automatically configure the driver for you, however **Windows 7** requires further configuration.
3. Make sure the Bluetooth device is powered on.
4. Go to the **Windows 7** control panel and double-click **Device Manager (Hardware and Sound > Devices and Printers)**.
5. **Bluetooth Peripheral Device(s)** will be listed under **Other Devices** (note this will only be listed if you have connected, or tried to connect to, a Bluetooth device previously).

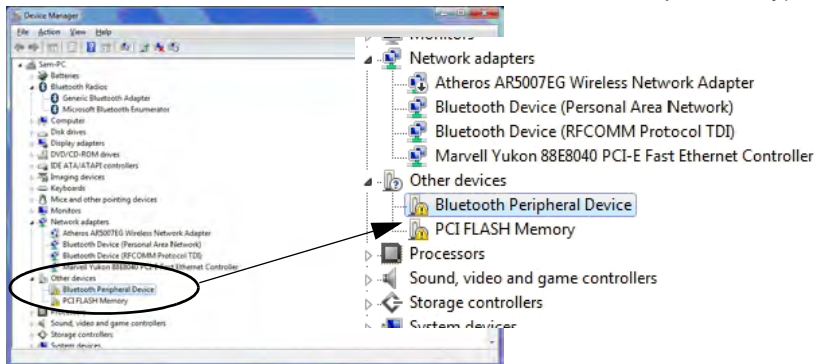

Figure 8 - 1 - Device Manager

Bluetooth Peripheral Devices

You will need to repeat the procedure listed here for all **Bluetooth Peripheral Devices** listed under **Other Devices** i.e. until there are no more **Bluetooth Peripheral Devices** listed under this menu heading.

6. Right-click **Bluetooth Peripheral Device** and click on **Update Driver Software**.
7. Click **Browse my computer for driver software**.
8. Click **Let Me pick from a list of device drivers on my computer**.

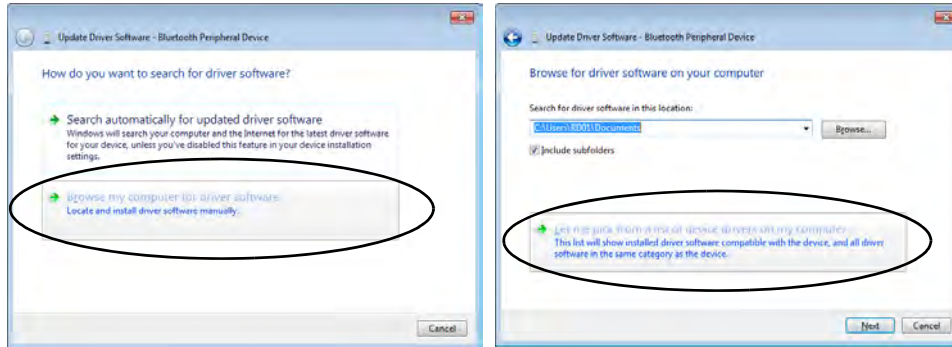

Figure 8 - 2 - Browse my computer.../Let me pick from...

9. Select **Bluetooth Radios** from the list.

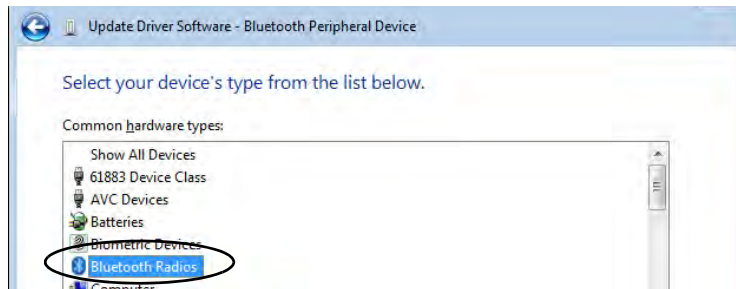

Figure 8 - 3 - Select Bluetooth Radios

Troubleshooting

10. A list of drivers will appear with **Manufacturer** on one side and **Model** in the other.
11. Choose **Microsoft Corporation** (make sure you choose the full name **Microsoft Corporation** and do not choose **Microsoft** - Note that you must have installed the **Microsoft Windows Device Center Driver for Microsoft Corporation** to appear in the list).
12. Select **Windows Mobile-based device support** from the **Model** list.

8

Make sure you select
Microsoft Corporation

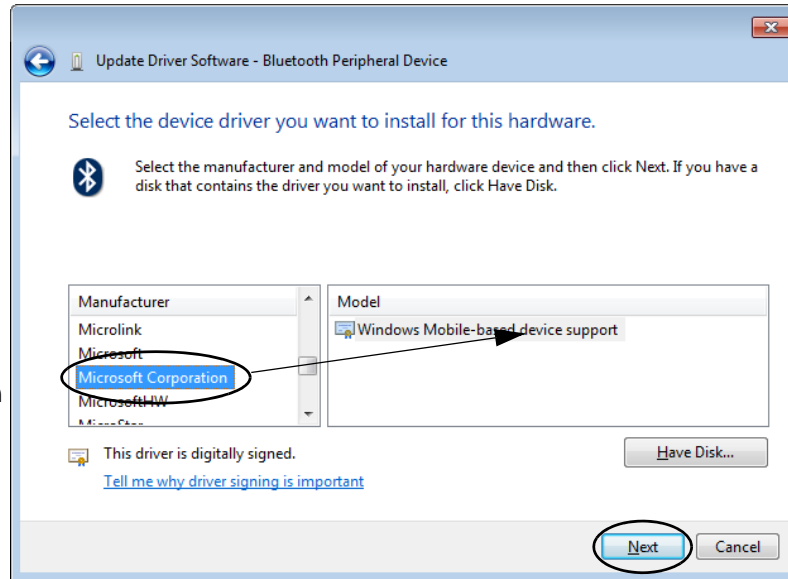

Figure 8 - 4 - Select Device Driver

13. Click **Next > Yes** and the driver will install.
14. Click **Close** to complete the installation.

15. The **Device Manager** should now display the **Windows Mobile-based device support** under **Bluetooth Radios**.
16. You will need to repeat the process for any other **Bluetooth Peripheral Devices** listed under **Other Devices**.

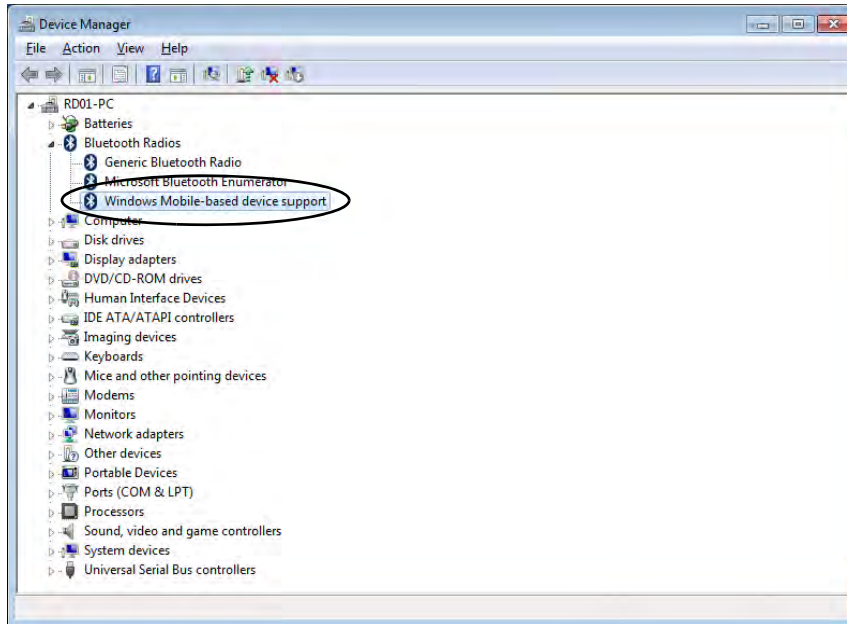

Figure 8 - 5 - Device Manager - Bluetooth Radio

Wake On LAN Setup

Wake On LAN is an Ethernet computer networking standard that allows a computer to be turned on or woken up by a network message. If you need to have your computer **Wake On LAN** you will need to enable **Computer Management** settings as follows.

1. Go the **Windows** control panel and double-click **Administrative Tools (System and Security)**.
2. Double-click **Computer Management**.
3. Click **Device Manager** under **System Tools**, and click the arrow to the left of **Network adapters**.
4. Double-click **jMicron PCI Express Gigabit Ethernet Adapter**, and click **Power Management** (tab).
5. Click to enable (place a check in the checkbox) "**Allow this device to wake the computer**".

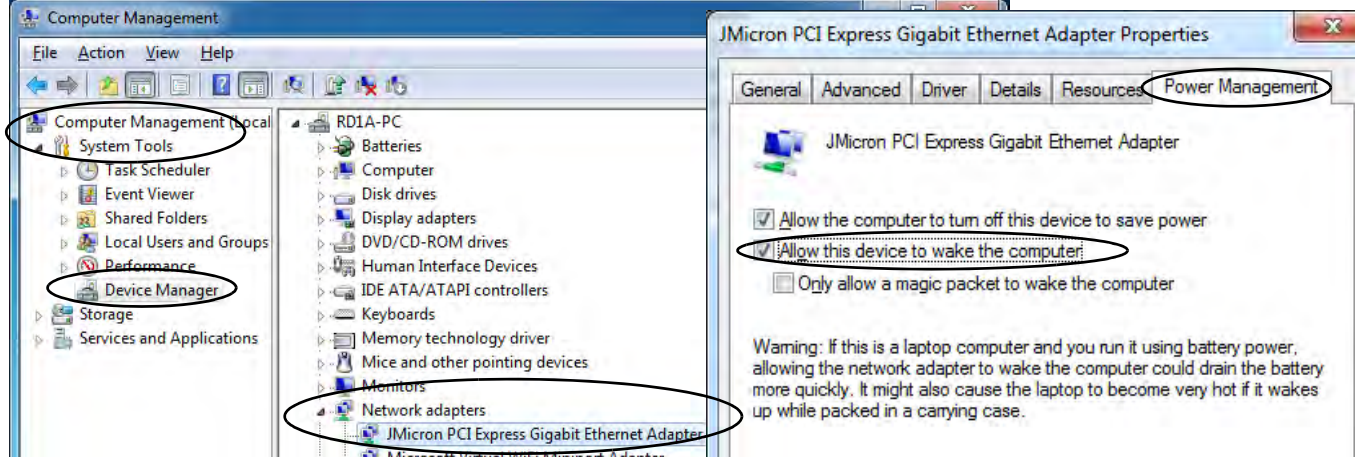



Figure 8 - 6- Network Adapter Wake On LAN (Power Management)

6. Click **Advanced** (tab).
7. Scroll down to the bottom of the **Property** menu and click to select each of the values listed below.



Property Item Settings for Wake On LAN

Set each of the following **Property** items to **Enabled**.

<u>Item:</u>	<u>Setting:</u>
• Wake on Connect	Enabled
• Wake on Link Raised	Enabled
• Wake on Magic Packet	Enabled
• Wake on Pattern Match	Enabled
• Wakeup from Shutdown	Enabled

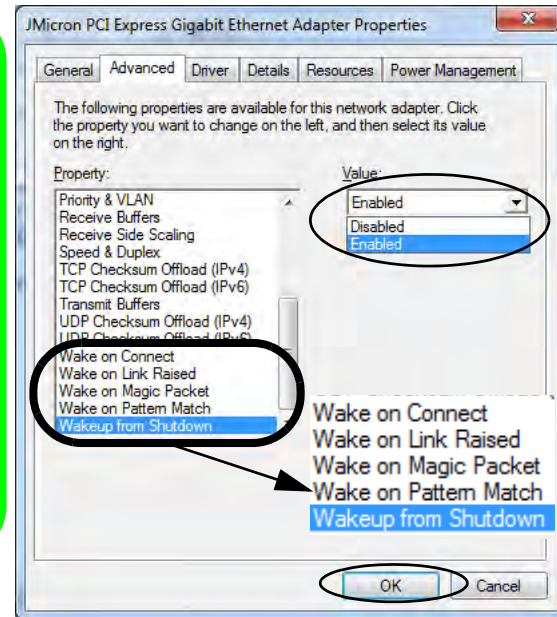

Figure 8 - 7- Network Adapter Wake On LAN (Advanced)



8. Click to select **Enabled** for each **Property** item from the drop-down **Value** menu.
9. Click **OK** to close the menu.
10. Close the **Computer Management** control panel.

Appendix A: Interface (Ports & Jacks)







Overview

The following chapter will give a quick description of the interface (ports & jacks) which allow your computer to communicate with external devices, connect to the internet etc.



Computer Ports and Jacks

Item	Description
Card Reader Port MMC/SD/MS	The card reader allows you to use some of the latest digital storage cards. Push the card into the slot and it will appear as a removable device.
COM/Serial Ports COM1 COM2	The COM/serial is a communication interface for data transfer, through which information transfers in or out one bit at a time. This port can be used to connect the computer to devices such as terminals and peripherals.
DC-In Jack  DC IN	Plug the supplied AC/DC adapter into this jack to power your computer.
e-SATA Port eSATA	This e-SATA (external Serial Advanced Technology Attachment) port allows you to plug-in external Serial ATA hard drives.
External Monitor (VGA) Port 	This port allows you to connect an external monitor, or Flat Panel Display, to get dual video or simultaneous display on the LCD and external monitor/FPD (see <i>“Attaching Other Displays”</i> on page B - 4).

A

Item	Description
HDMI-In Port 	The HDMI-In (High-Definition Multimedia Interface) port allows you to display external sources such as Blu-ray players, DVDs, set top boxes and games consoles etc. on your computer screen as long as the computer's AD/DC adapter is plugged in to a power source (see " HDMI-In Port " on page 1 - 11).
Headphone-Out Jack 	Headphones or speakers may be connected through this jack. Note: Set your system's volume to a reduced level before connecting to this jack.
Line-In Jack 	The Line-In jack allows you to play audio sources through the computer's speakers.
Microphone-In Jack 	Plug an external microphone in to this jack to record on your computer.
RJ-45 LAN Jack 	This port supports LAN (Network) functions. Note: Broadband (e.g. ADSL) modems usually connect to the LAN port.
Security Lock Slot 	To prevent possible theft, a Kensington-type lock can be attached to this slot. Locks can be purchased at any computer store.

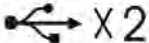
Interface (Ports & Jacks)

Item	Description
S/PDIF-Out Jack 	This S/PDIF (Sony/Philips Digital Interface Format) Out Jack allows you to connect your DVD-capable PC to a Dolby AC-3 compatible receiver for “5.1” or ‘dts’ surround sound.
USB 2.0/1.1 Ports  X 2 USB 3.0 Port 	<p>These USB (Universal Serial Bus) 2.0 compatible ports (USB 2.0 is fully USB 1.1 compliant) are for low-speed peripherals such as keyboards, mice or scanners, and for high-speed peripherals such as external HDDs, digital video cameras or high-speed scanners etc. Devices can be plugged into the computer, and unplugged from the computer, without the need to turn the system off (if the power rating of your USB device is 500mA or above, make sure you use the power supply which comes with the device).</p> <p>The USB 3.0 port is denoted by its blue color; USB 2.0 ports are colored black. USB 3.0 will transfer data much faster than USB 2.0, and is backwards-compatible with USB 2.0.</p> <p>Note that the USB 3.0 port requires a driver installation (see “USB 3.0” on page 4 - 6), does not support wake on USB and is not operational under DOS.</p>

A

Appendix B: Intel Video Driver Controls

The basic settings for configuring the LCD are outlined in “*Video Features*” on *page 1 - 15*.

Intel Video Driver Installation

Make sure you install all the drivers in the order indicated in *Table 4 - 1, on page 4 - 3*.

Video

1. Insert the *Device Drivers & Utilities + User’s Manual* disc into the CD/DVD drive.
1. Click **2.Install VGA Driver > Yes**.
2. Click **Next > Yes > Next > Next**.
3. Click **Finish** to restart the computer.

Dynamic Video Memory Technology

Intel® DVMT automatically and dynamically allocates as much system memory (RAM) as needed (up to **348MB**) to the video system (**the video driver must be installed**). DVMT returns whatever memory is no longer needed to the operating system (see “*Total Graphics Memory (Advanced Menu > Advanced Chipset Control)*” on *page 5 - 9*).



DVMT Notes

DVMT is not local video memory.

DVMT is not user-configurable.

DVMT will not function in MS-DOS. DOS uses the legacy memory indicated.



HDMI-In Port

This computer features an **HDMI** (High-Definition Multimedia Interface) **input port** that allows you to display external sources such as Blu-ray players, DVDs, set top boxes and games consoles etc. on your computer screen.

Note that this is an HDMI Input port and cannot be used as an HDMI Output port to display the computer's screen on external displays.

Intel® Graphics & Media Control Panel

Advanced video configuration options are provided by the **Intel® Graphics and Media Control Panel**. To access the control panel:

1. Click **Advanced settings** in the **Screen Resolution** control panel in **Windows**.
 2. Click the **Intel(R)...** tab and click **Graphics Properties** (button).
- OR
3. Right-click the desktop and select **Graphics Properties** from the menu.
- OR
4. Double-click the **Intel(R) G&M** control panel in the **Windows Control Panel**.



Figure B - 1
**Intel® G&M
Control Panel**

You may make changes to any of the graphics properties by clicking the appropriate menu tab on the left of the menu and adjusting the settings on the right.

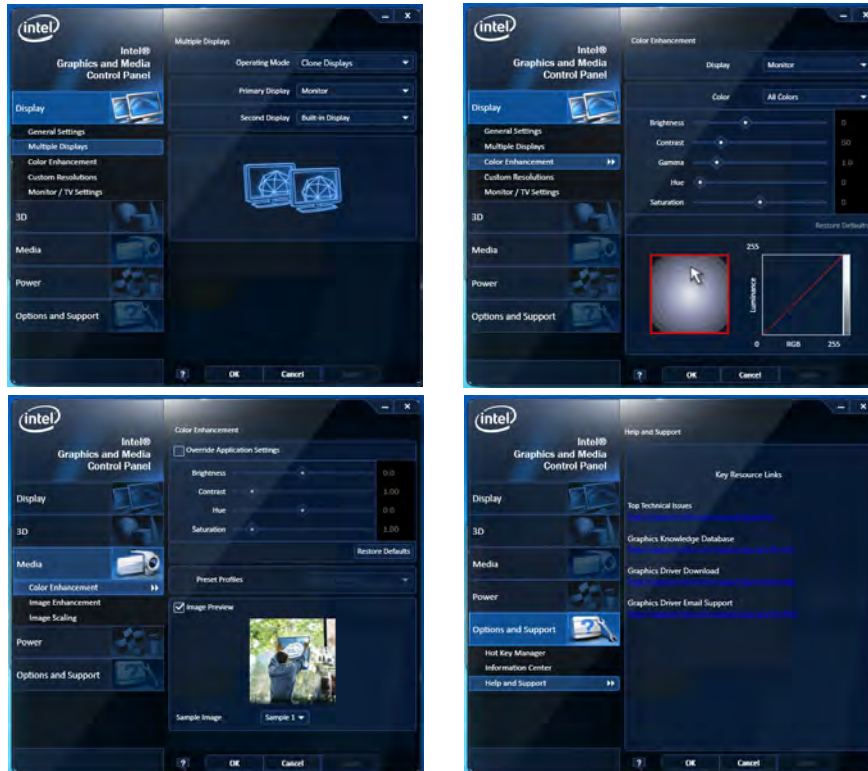

Options & Support

Click **Options & Support** and select an item from the sub-menu to bring up the help and support topics.

You will need to be connected to the Internet to access the key resource links.

Multiple Display

At least one other display must be attached in order to view multiple display selection options.

Figure B - 2

**Intel® G&M
Control Panel Tabs**



Multiple Display

At least one other display must be attached in order to view **Multiple Display** selection options.

General Settings

Click **General Settings** to access settings the options for any attached display.

Attaching Other Displays

If you prefer to use a monitor or flat panel display, connect it to the external monitor port.

To Clone Displays:

1. Attach your display to the external monitor port and turn it on.
2. Go to the **Intel(R) G&M** control panel and click **Display > Multiple Displays**.
3. Click **Operating Mode** and select **Clone Displays** from the menu.
4. Click **Apply**, and **OK** to confirm the settings change.
5. You can switch the **Primary/Secondary Display** from the menu.

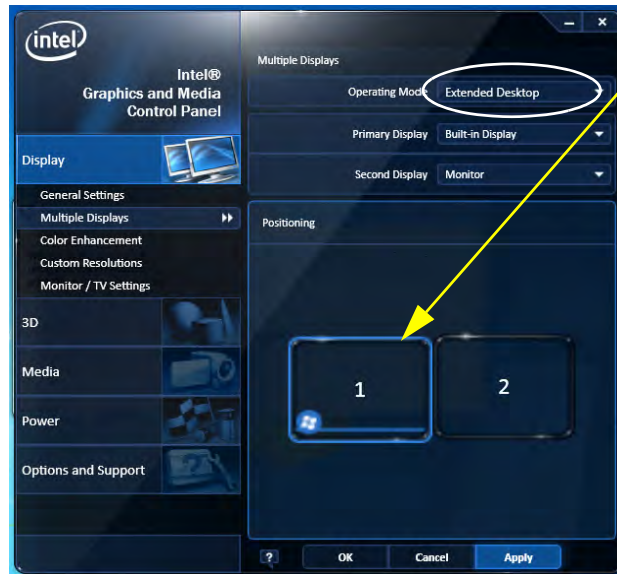

Figure B - 3

Display > Multiple Displays (Clone)

To Enable Extended Desktop:

1. Attach your display to the external monitor port and turn it on.
2. Go to the **Intel(R) G&M** control panel and click **Display > Multiple Displays**.
3. Click **Operating Mode** and select **Extended Desktop** from the menu.
4. Click **Apply**, and **OK** to confirm the settings change.



Click the appropriate monitor icon and drag it to match the physical arrangement you wish to use (e.g. the secondary display may be extended left/right/above/below the primary display).

Click General Settings to make any adjustments required.



Display Settings Extended Desktop

You can have different Colors, Screen Area and Monitor Refresh Rates for each display device **provided your monitor can support them**.

You can drag the monitor icons to match the physical layout of your displays. Icons and programs may also be dragged between the displays.

Figure B - 4
Display > Multiple
Displays (Extended)

Configuring an External Display in Windows 7

You can also use the **Screen Resolution** control panel in *Windows 7* to configure an external display.

1. Attach your display to the external monitor port and turn it on.
2. Go to the **Screen resolution** control panel (see *“Video Features - Win 7” on page 1 - 16*).
3. Click the **Detect** button.
4. The computer will then detect any attached displays.

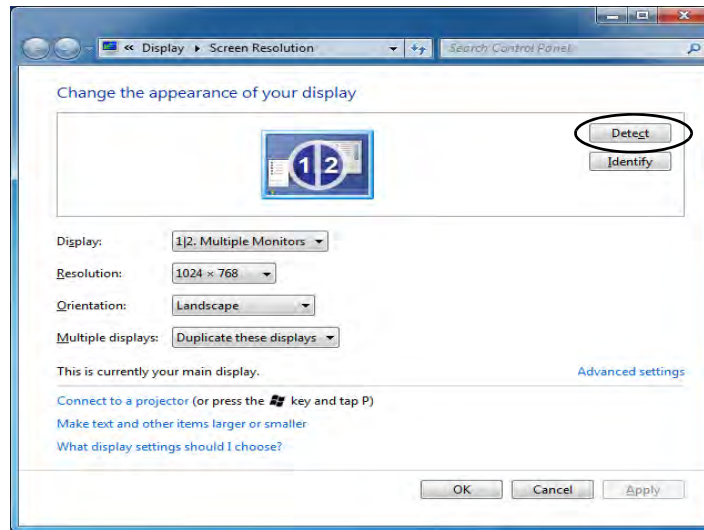

Figure B - 5
Screen Resolution
Multiple Displays
(Win 7)

5. You can configure the displays from the **Multiple Displays** menu.

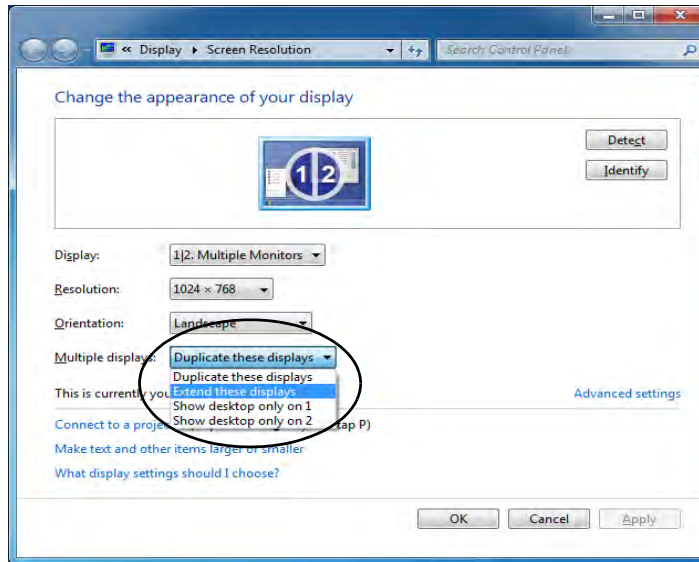



Figure B - 6
Screen Resolution
Multiple Display
Options
(Win 7)

- Duplicate these displays - Shows an exact copy of the main display desktop on the other display(s).
- Extend these displays - Treats both connected displays as **separate** devices.
- Show desktop only on 1/2 - Only one of your displays is used.

Intel Video Driver Controls

Using the Windows Logo Key + P Key Combination to Switch Displays

You can also use the  + **P** key combination to quickly change display configuration and modes (this is particularly useful when attaching a projector) in *Windows 7*.



1. Attach your display to the external monitor port and turn it on.
2. Press the  + **P** key combination.
3. An on-screen menu will pop up.
4. Use the cursor keys (or  + **P**) to select the appropriate configuration from the menu, and press Enter to confirm the selection.

Figure B - 7
 + P Display
Configuration
Selection
(Win 7)



Appendix C: Specifications



Latest Specification Information

The specifications listed in this Appendix are correct at the time of going to press. Certain items (particularly processor types/speeds and CD/DVD device types) may be changed or updated due to the manufacturer's release schedule. Check with your service center for details.

Specifications

Processor	Processor	Processor				
<p>Intel® Core i7 Mobile Processor:</p> <p>=====</p> <p>i7-640M (2.80GHz) 32nm (32 Nanometer) Process Technology, 4MB L3 Cache & FSB 1066MHz - TDP 35W rPGA988A Package</p> <p>i7-620M (2.66GHz) 32nm (32 Nanometer) Process Technology, 4MB L3 Cache & FSB 1066MHz - TDP 35W rPGA988A Package</p> <p>=====</p> <p>Intel® Core i5 Mobile Processor:</p> <p>=====</p> <p>i5-540M (2.53GHz) 32nm (32 Nanometer) Process Technology, 3MB L3 Cache & FSB 1066MHz - TDP 35W rPGA988A Package</p> <p>i5-520M (2.40GHz) 32nm (32 Nanometer) Process Technology, 3MB L3 Cache & FSB 1066MHz - TDP 35W rPGA988A Package</p>	<p>Intel® Core i5 Mobile Processor:</p> <p>=====</p> <p>i5-450M (2.40GHz) 32nm (32 Nanometer) Process Technology, 3MB L3 Cache & FSB 1066MHz - TDP 35W rPGA988A Package</p> <p>=====</p> <p>Intel® Core™ i3 Mobile Processor:</p> <p>=====</p> <p>i3-350M (2.26GHz) 32nm (32 Nanometer) Process Technology, 3MB L3 Cache & FSB 1066MHz - TDP 35W rPGA988A Package</p> <p>i3-330M (2.13GHz) 32nm (32 Nanometer) Process Technology, 3MB L3 Cache & FSB 1066MHz - TDP 35W rPGA988A Package</p> <p>=====</p>	<p>Intel® Celeron® Processor:</p> <p>P4500 (1.86GHz) 32nm (32 Nanometer) Process Technology, 2MB L3 Cache & FSB 1066MHz - TDP 35W rPGA988A Package</p> <p>=====</p> <p>Intel® Pentium® Processor:</p> <p>P6000 (1.86GHz) 32nm (32 Nanometer) Process Technology, 3MB L3 Cache & FSB 1066MHz - TDP 35W rPGA988A Package</p> <tr> <th data-bbox="1034 611 1481 661">Core Logic</th> <td data-bbox="1034 661 1481 712">Intel® HM55 Express Chipset</td> </tr> <tr> <th data-bbox="1034 712 1481 762">Display</th> <td data-bbox="1034 762 1481 902">19"(42.8cm) WXGA+ (1440*900) Flat Panel TFT Hard Glass (Factory Option) Multi-Touch Panel (Factory Option)</td> </tr>	Core Logic	Intel® HM55 Express Chipset	Display	19"(42.8cm) WXGA+ (1440*900) Flat Panel TFT Hard Glass (Factory Option) Multi-Touch Panel (Factory Option)
Core Logic	Intel® HM55 Express Chipset					
Display	19"(42.8cm) WXGA+ (1440*900) Flat Panel TFT Hard Glass (Factory Option) Multi-Touch Panel (Factory Option)					

Specifications

Memory	Storage	Interface
<p>Dual Channel DDRIII (DDR3)</p> <p>Two 204 Pin SO-DIMM Sockets Supporting DDRIII (DDR3) 1066MHz/1333MHz Memory Modules</p> <p>Memory Expandable up to 8GB Compatible with 1GB, 2GB or 4GB Modules</p>	<p>Up to Two Changeable 2.5" 9.5 mm (h) SATA (Serial) Hard Disk Drives</p> <p>One 12.7 mm Super Multi/Blu-ray Combo SATA Optical Device Drive (Factory Option)</p>	<p>Four USB 2.0 Ports</p> <p>One USB 3.0 Port</p> <p>One eSATA Port</p> <p>Two (Serial) COM Ports</p> <p>One External Monitor Port</p> <p>One Headphone-Out Jack (On Stand)</p> <p>One Microphone-In Jack (On Stand)</p> <p>One S/PDIF Output Jack</p> <p>One Line-In Jack</p> <p>One RJ-45 LAN Jack</p> <p>One DC-in Jack</p> <p>One HDMI-In (High-Definition Multimedia Interface) Port - Resolutions Supported:</p> <ul style="list-style-type: none"> - 1440 * 900 - 1280 * 800 - 1280 * 720 - 1024 * 768 - 800 * 600
Video Adapter	Audio	
<p>Intel® GMA HD</p> <p>Intel® Dynamic Video Memory Technology Supporting Shared Memory of up to 348MB</p> <p>Supports Microsoft DirectX 10 Enhanced Video and 3D Engine Hardware Accelerator Decoder for Blu-ray</p>	<p>High Definition Audio</p> <p>UAA (Universal Audio Architecture)</p> <p>2 Built-In Speakers</p>	
	Keyboard & Pointing Device	
	<p>Standard USB Keyboard (Option)</p> <p>RF USB Keyboard/Mouse with Transceiver (Factory Option)</p> <p>RF USB Remote Controller with Transceiver (Factory Option)</p>	
BIOS		
<p>One 16Mb SPI Flash ROM</p> <p>Phoenix™ BIOS</p>		

Specifications

Card Reader	Communication	Power
<p>Embedded Multi-In-1 Card Reader</p> <ul style="list-style-type: none"> - MMC / RSMHC - SD / Mini SD / SDHC / SDXC Compatible - MS / MS Pro / MS Duo <p>Note: Some of these cards require PC adapters that are usually supplied with the cards.</p>	<p>Built-In 10/100/100 Mb Base-TX Ethernet LAN</p> <p>3rd Party 802.11b/g/n Wireless LAN Half Mini-Card Module with PCIe & USB Interface (Factory Option)</p> <p>Combo WLAN (802.11b/g/n) and Bluetooth v3.0 Half Mini-Card Module with PCIe Interface (Factory Option)</p>	<p>Full Range AC/DC Adapter – AC in 100 - 240V, 50 - 60Hz DC Output 19V, 4.74A (90 Watts)</p>
Slots	Communication	Security
<p>ExpressCard/34/54 Slot</p> <p>Two Mini Card Slots:</p> <p>Slot 1: for WLAN Half Mini-Card Module with PCIe Interface</p> <p>OR for Combo WLAN and Bluetooth v3.0 Half Mini-Card Module with PCIe & USB Interface</p> <p>Slot 2: for TV Tuner Module with PCIe Interface</p>	<p>TV Tuner Module (Factory Option)</p> <p>RF for TV Tuner Remote Controller (Factory Option)</p> <p>2.0M Pixel PC Video Camera Module with USB Interface (Factory Option)</p>	<p>Security (Kensington® Type) Lock Slot</p> <p>BIOS Password</p> <p>Fingerprint Reader Module</p>
	Power Management	Operating System
	<p>Supports Wake on LAN</p> <p>Supports Wake on USB</p>	<p>Windows® 7</p> <p>Note that the TV Tuner module (factory) option is supported by the Windows Media Center software. Windows Media Center is not included in Starter or Home Basic versions of Windows 7.</p>
		Environmental Spec
		<p>Temperature</p> <p>Operating: 5°C - 35°C</p> <p>Non-Operating: -20°C - 60°C</p> <p>Relative Humidity</p> <p>Operating: 20% - 80%</p> <p>Non-Operating: 10% - 90%</p>

Physical Dimensions & Weight

450mm (w) * 312mm (d) * 66.5mm (h)

11kg with ODD

Specifications

C