

LCD MONITOR Embedded Stand-Alone DVR  
Sleek Design - Easy Operation

# BUILT-IN MPEG-4 DVR

## 9CH/16CH User Guide



# Contents

Before you install .....	4
Notice for Installation .....	5
Notice .....	6
SPECIFICATION .....	11
Package Contents .....	13
System Configuration .....	14
Remote Controller .....	16
HDD .....	17
USB MEMORY .....	18
<b>1. DVR Setup .....</b>	<b>19</b>
1-1. Setup .....	19
1-2. Live Mode Setup .....	21
1-3. Recording Setup .....	22
1-3-1. Motion Detection Setup .....	23
1-3-2. Schedule Setup .....	23
1-4. Device Setup .....	25
1-4-1. Alarm Output .....	26
1-4-2. Camera Control .....	27
1-4-3. PTZF Control .....	27
1-4-4. SPOT Output .....	29
1-5. System Setup .....	30
1-6. Security Setup .....	32
1-7. Network Setup .....	33
1-7-1. Port .....	34
1-7-2. Network .....	35
1-8. Recording Device Setup .....	37
1-9. Save Setup .....	38
<b>2. Live Search .....</b>	<b>39</b>
2-1. Live Mode .....	39
2-2. Search Mode .....	40
2-3. Playback Mode .....	42

<b>3. Archiving Video Into USB Memory Stick</b> .....	<b>43</b>
3-1. Still Image& Video Recording .....	43
3-2. <b>Video &amp; Still Image Back-up through USB</b> .....	44
<b>4. Firmware Upgrade</b> .....	<b>46</b>
<b>5. Network Client</b> .....	<b>47</b>
5-1. Setup .....	47
5-2. Minimum PC requirements for Net Client software .....	48
5-3. Installation Program .....	48
5-4. Live Mode .....	48
5-4-1. Main Screen .....	49
5-4-2. Main Control Buttons .....	49
5-4-3. Search Mode .....	52
5-4-4. Search Control Buttons .....	52
5-5. System Setup .....	55
5-5-1. General .....	55
5-5-2. Site .....	56
5-5-3. Event .....	56
5-5-4. Record .....	57
5-5-5. Video .....	59
5-5-6. About .....	59

## Before you install

This Manual is for DVR System users.

It is mainly composed of DVR System Design, Name, Connection with Related equipment such as Pan/Tilt Control, System Program configuration.

- ☞ Note: We do not take any responsibility of damages resulted from the non-standardized goods and failures to follow the manual instructions.
- ☞ Please ask for help to your last seller before disassembling the system for repair and add particular functions.

### FCC Verification

Caution : Any changes or modifications in construction of this device which are not expressly approved by the party responsible for compliance could void the user's authority to operate the equipment.

Note : This equipment has been tested and found to comply with the limits for a Class A digital device, pursuant to part 15 of the FCC Rules.

These limits are designed to provide reasonable protection against harmful interference when the equipment is operated in a frequency energy and, if not installed and used in accordance with the instruction manual, may cause harmful interference to radio communications.

Operation of this equipment in a residential area is likely to cause harmful interference in which case the user will be required to correct the interference at his own expense.

### CE DoC (Declaration Of Conformity)

Warning : This is a class A product.

In a domestic environment this product may cause radio interference in which case the user may be required to take adequate measures.

## Notice for installation



**All of below notices should be verified before installation and operation.**

- ☞ Do not install DVR at moist, dusty and black dirt place.
- ☞ Do not expose the system to Heaters and a direct ray of light
- ☞ This system should not be located with magnetic materials and vibrating equipment.
- ☞ Do not install the system in Hot and Cold place. (Operating Temp 5 °C ~ 40 °C)
- ☞ Please be careful not to fall a electric conductor into the hole for well-ventilation!
- ☞ Ensure the power switch is in the OFF position prior to installation.
- ☞ Make enough space for cable connection.
- ☞ Install and operate the system in well-ventilated place without vibration.
- ☞ Note that some malfunction can be happened by Radio or Television
- ☞ Do not disassemble System.
- ☞ If the system is connected with power directly, check the ground connection!

## Warning/Caution

The following describes safety warnings and cautions to protect users and prevent Property losses. Please thoroughly read the bellow before operating the system.

## Warnings and Cautions

 <p><b>Warnings</b> If the user is not aware of this warning, the user can be killed seriously injured.</p>	 <p><b>Cautions</b> If the user is not aware of this caution, the user can be injured or a property loss may be caused.</p>
--	--



## Warning

Turn off the system before installing the system. Do not plug in several electric devices to the same outlet.

- This may cause heating, a fire, or an electric shock.

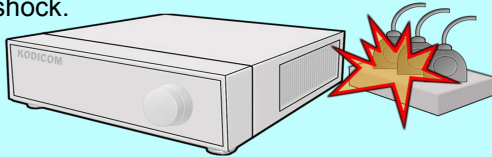

Do not put a liquid container such as water, coffee, or beverage.

- If liquid is poured into the system, it can cause a system breakdown or a fire.

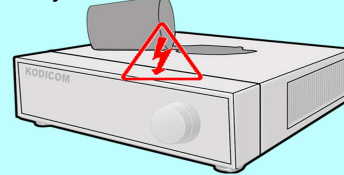

Do not bend the power cable and do not put a heavy object on the power cable causing a damage.

- This may cause a fire.

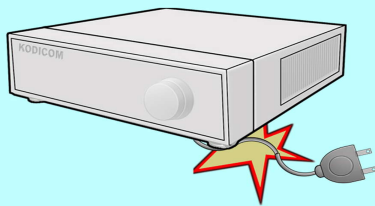

Keep the place where the system is installed always clean after installation. Use dry clothes to clean the system, but do not use water, thinner, or other organic solvents.

- This may damage the surface of the system as well as causing a system breakdown or an electric shock.



Do not install the system in a humid, dusty, or soot-covered place.

- This can cause a fire or an electric shock

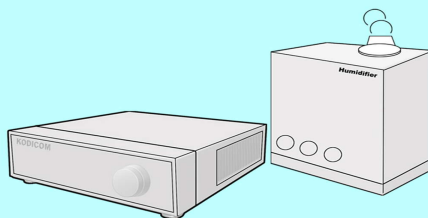

Do not forcefully pull the power cable or touch the plug with wet hands. Do not plug in if the holes on the outlet is too loose.

- This may cause a fire or an electric shock.

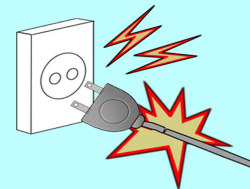



## Warning

Do not disassemble, repair, or remodel the system by yourself because a high voltage is running in the system.

- This may cause a fire, an electric shock, and injuries.



Install the system in a cool place without direct sunlight, and keep the temperature properly. Avoid candle light and heat-generating devices like a heater. Keep devices and tools away from a place where a lot of people pass.

- This may cause a fire.

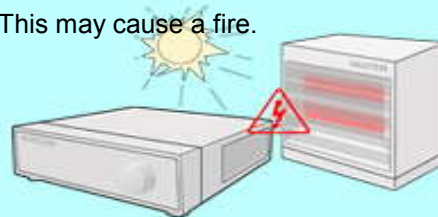

Check if any danger such as a humid floor, an ungrounded power extension cable, a torn power cable, or lack of safety grounding. If anything dangerous is found, ask an assistance to your dealer or an engineer.

- This may cause a fire or an electric shock.

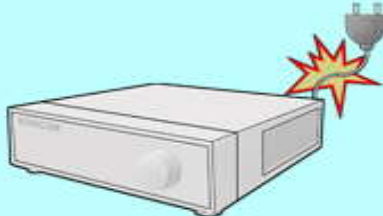

Install the system in a flat place that is not sealed. Do not stand the system vertically or lean the system.

- When the system falls down, this may result in injuries.



Keep at least 15cm of the distance between the rear part of the system and the wall. Since the power cable connection port, image signal input/output ports, the serial port, the LAN cable port and external input/output ports are installed on the rear part of the system, allowing only a short distance between the wall and the rear part of the system may have cables bent, damaged, or cut.

- This may cause a fire, an electric shock or an injury.

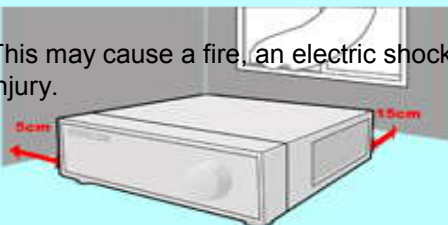

The power outlet must be grounded, and the voltage range must be within 10% of the rated voltage. Do not use the same outlet with a hair dryer, an iron, a refrigerator, or a heating apparatus.

- This may cause a fire, heating, or an electric shock.





## Warning

When the system battery is dead, replace the battery with the same type battery or an equivalent one specified by the manufacturer.

A dead battery should be disposed according to the manufacturer's instructions.

- This may cause an explosion.

If the HDD passes its service life, image data stored in the HDD may not be recoverable. If broken images are displayed while playing data stored in the HDD, it means the HDD passed its service life. When this happens, contact your dealer or the service center to have it replaced with a new HDD.

- We are not responsible for deleted data by user's carelessness.





## Caution

Do not install the system in a place with strong magnetism, frequencies, or impact, nor near electric devices such as radios and TV sets.

- Install the system in a place without magnetic objects, frequencies, or severe vibration.

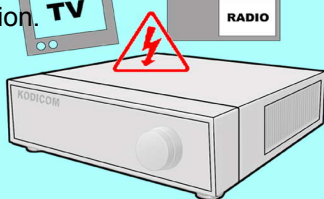

Install the system in a place with an appropriate moisture level and the temperature.

- Install the system in a place with an appropriate moisture level and the temperature.

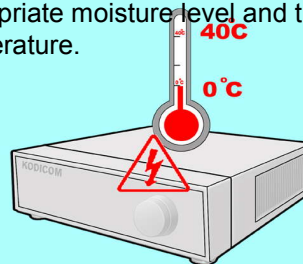

Prevent substances from entering into the system.

- This may cause a system breakdown.

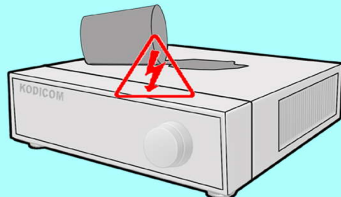

Do not put a heavy object on top of the system.

- This may cause a system breakdown.

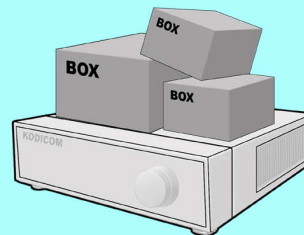

Install the system in a well-ventilated place.

- Keep at least 15 cm of the distance between the rear part of the system and the wall, and 5 cm of the distance between the side part of the system and the wall.

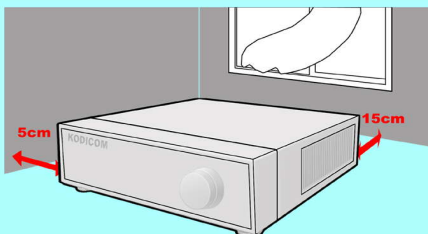

Install the system on a stable flat place.

- The system may not properly operate.

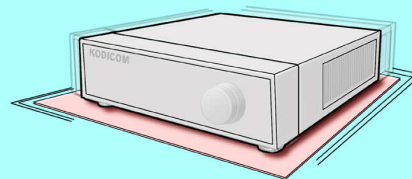



## Caution

Strong impact or vibration may cause a system breakdown.

- Install the system in a place without severe vibration.

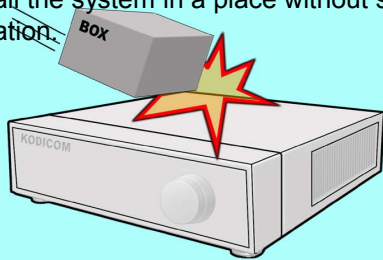

The outlet must be grounded.

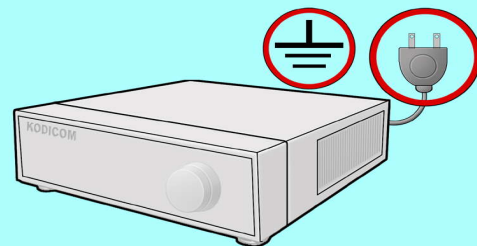

Avoid direct sunlight or an heating apparatus.

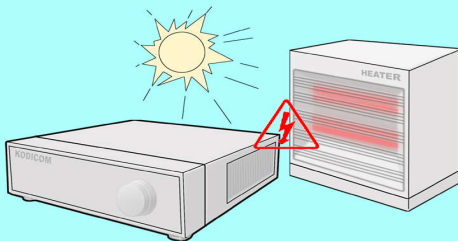

If there is strange sound or smell, unplug the power cord immediately and contact the service center.

- This may cause a fire or an electric shock.

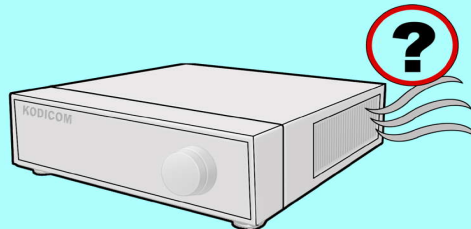

Ventilate the air in the system operation room, and firmly fix the system cover.

- A system breakdown might be resulted in by inappropriate environments.

It is recommended to use the Automatic Voltage Regulator (AVR) for stable power supply.

It is recommended to coil the core-ferrite around the connector of the system to avoid electromagnetic interference.

- This is not mandatory, but recommended.

In order to keep the system performance, have your system regularly checked by the service center.

- We are not responsible for the system breakdown due to user's carelessness.

## SPECIFICATION

ITEM			FZ09/FZ16	
Video	Input	Channel Input Level	9ch/16ch composite 1.0Vp-p, 75 Ohm	
		Signal Format	NTSC/PAL	
		Video Loss Check	YES	
	Output	Monitor Output	1ch VGA	
		Signal Format	VGA	
Audio	Input & Output		4ch Line Input & 1ch Line Output	
	Audio Algorithm		G711	
Alarm	Sensor Input		4ch (NC/NO Selectable)	
	Alarm Output		4ch	
	Alarm Output		By Alarm, Motion, HDD Error, Temperature, FAN & POWER Failure, Video Loss, And ABCD (A Blind Camera Detection)	
Recording	Compression		MPEG-4	
	Multi-operation		TRIPLEX (Playback/Record/Network)	
	Frame	NTSC		MAX. 120fps @ 352x240
				MAX. 30fps @ 704x480
		PAL		MAX. 100fps @ 352x288
				MAX. 25fps @ 704x576
	Recording quality grade		10 grades	
	Recording Option		Continuous / Schedule / Motion / Manual Recording	
	Motion Recording Setup		Motion Detection Setup by Grid	
	Pre & Pos Recording		Yes	
Display				
Frame Rate ( /Sec)		NTSC : 30fps/channel, 60 field    PAL : 25fps/channel, 50field		
Playback	Multi-Decoding		1, 4, 9, 16 & PIP	
	Playback Speed	Fast Forward Reverse	X 2, 4, 8, 16, 32 MAX	
	Search Mode		Time, Event, Channels	

ITEM		FZ09/FZ16	
Network	Internal HDD	Interface Type	EIDE/ATA133
		Max Capacity of 1HDD	250GB
		Max HDD Number	2
	File system		NaFS : Own developed & Designed for never broken by any Power failure
	Backup	USB 2.0 Memory stick & CD-RW	Still Image & AVI
		Network	Moving picture & Still Image
User I/F	Menu Display		GUI
	Input Method		Front keypad, Remote controller
Serial port	Console & External Modem		1 RS-232C (9pin D-SUB connector)
	Camera control		1 RS-485/422 (4 Terminal Block)
Network	Dynamic IP support		Yes
	Network Interface		10/100 base-T Ethernet (RJ-45)
Network Client S/W	Functions		Live, Search, Backup, PTZF Camera Control
	Central Monitoring System		Yes
Additional Functions	DLS( Day Light Saving)		Yes
	Multi-Language		Yes
	S/W Upgrade		USB memory stick, Network
ELECTRONICAL SPECIFICATION	ADAPTOR		Input: AC100-240V, 50/60Hz, 1.5A Output : DC12V 5A
	CONSUMPTION		About 25W
ENVIRONMENTAL SPECIFICATION SIZE	TEMPERATURE		5°C ~ 40°C
	DIMENSION		388(W) X 170(D) X 430(H)mm

## Package Contents

Please check the below listed contents prior to installation!  
If there is missing content, Please contact your original seller!

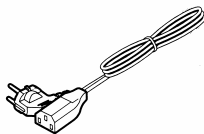

Power Cable



DC 12V ADAPTOR



CLIENT SOFTWARE CD

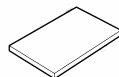

MANUAL



Video Cable

# Configuration

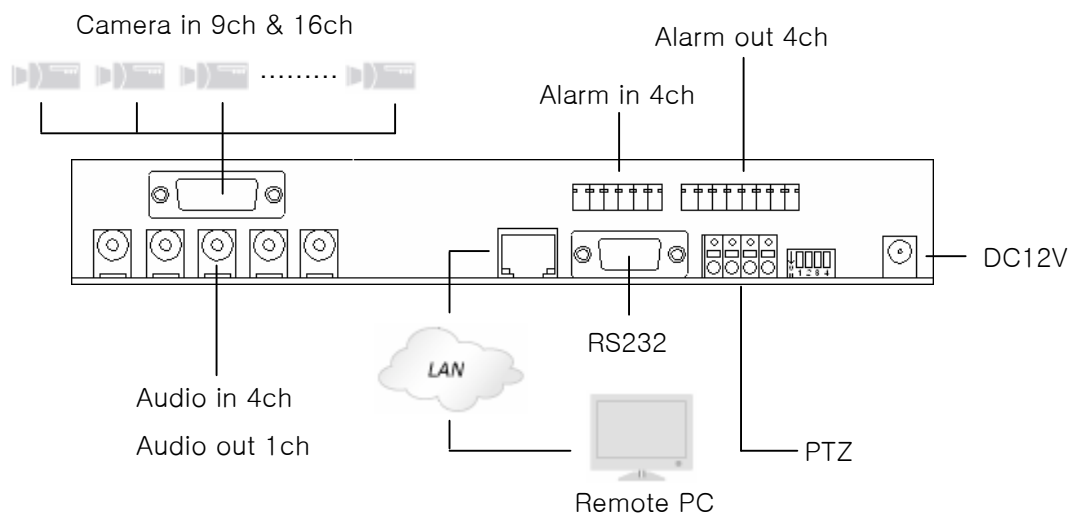
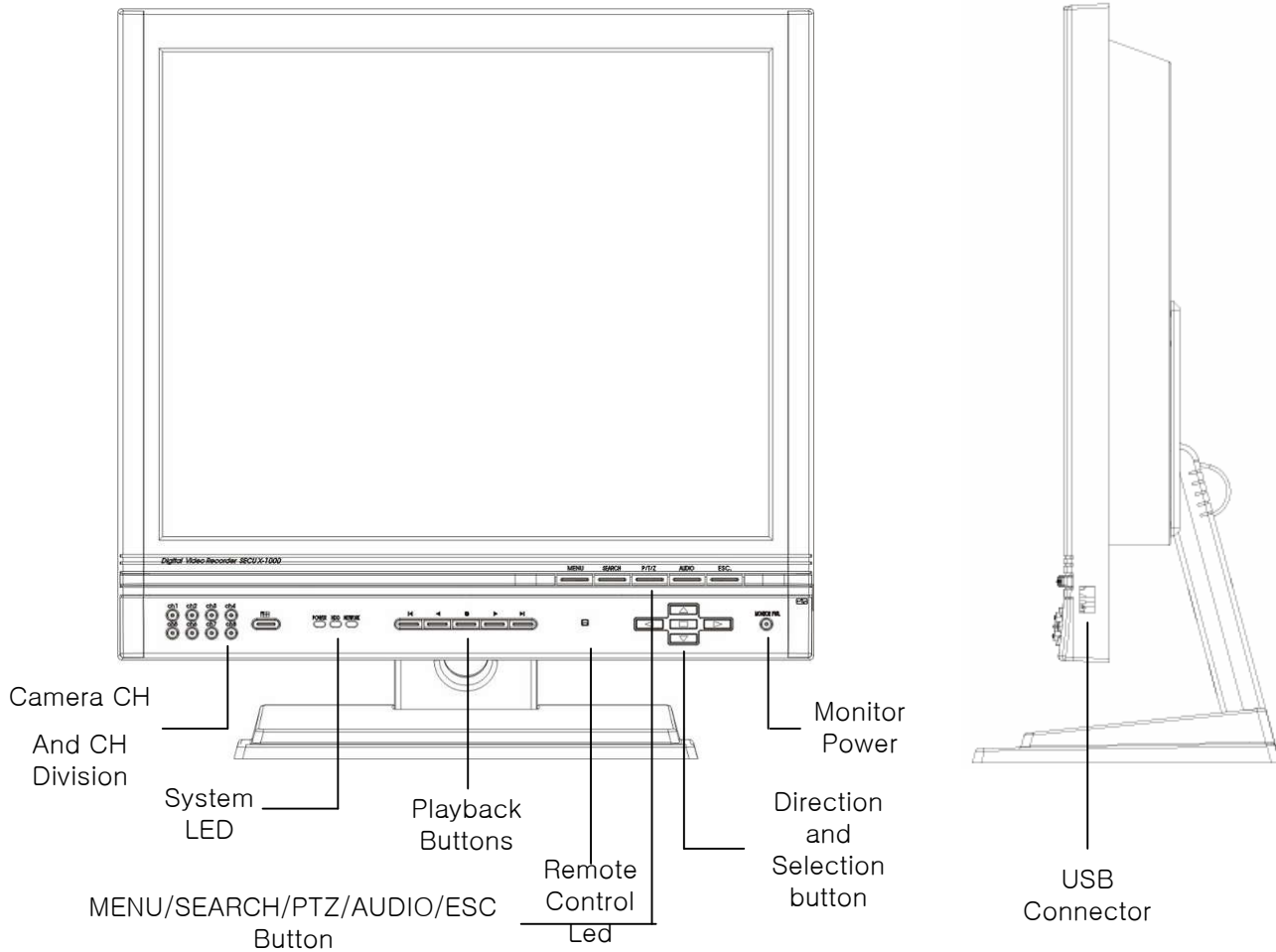

PTZ Diagram

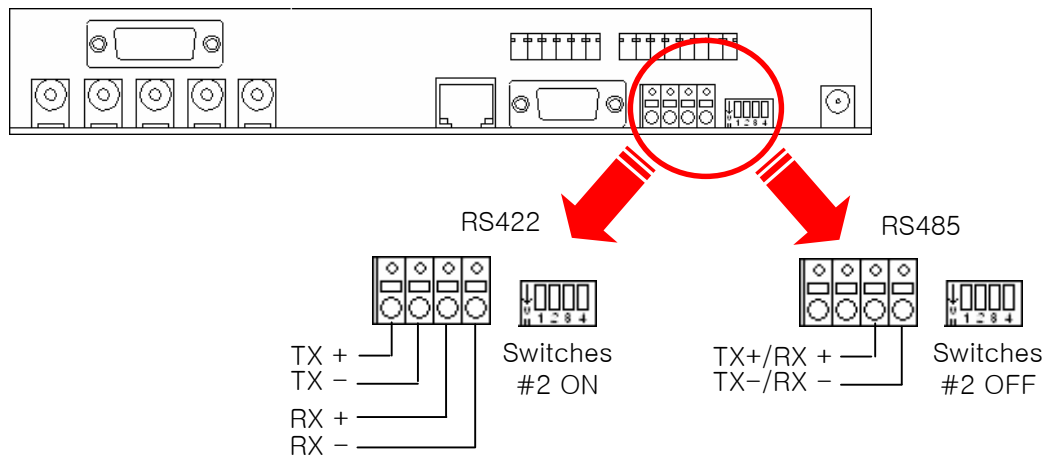

Sensor Diagram

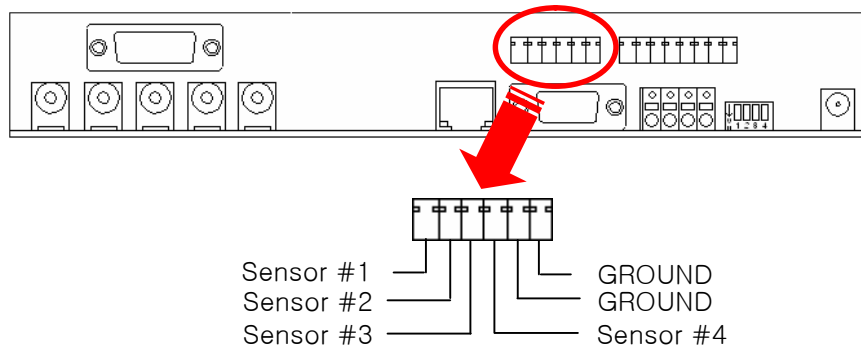

Alarm Connection

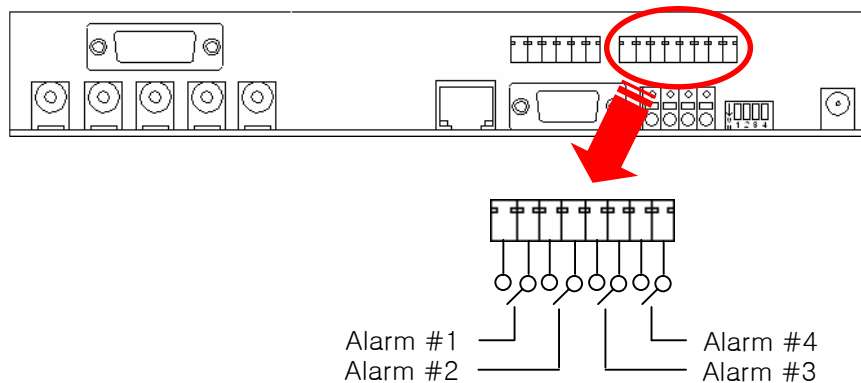

## Remote Controller



Button	Functions
POWER	Power On/Off
DISPLAY	Display Mode
F/REW	Play Backward by 60 Sec
PLAY	Playback
F/ADV	Play Forward by 60 Sec
FREEZE/CAP	Freeze and Still Image Recording
FF	Play Forward up to 32 Times
ALARM	Alarm Setup
SETUP	Main Menu
ARCHIVE	Recording List
AUDIO	Select Audio
LOCK	Lock
SEQ	Sequence
RECORD	Manual Recording
SEARCH	Recording Data Search
Arrow Button	Change Menu and Channel No
ID	DVR ID Input (ID Button+2 Digit Number)
ESC	ESC
PTZ	PTZ Camera Control
NUMBER	Channel 1 to 9
+10	Channel 10 and channel 11 to 16 10CH→press + 10 and number 0 11CH→press + 10 and number 1 12CH→press + 10 and number 2 13CH→press + 10 and number 3 14CH→press + 10 and number 4 15CH→press + 10 and number 5 16CH→press + 10 and number 6



## HDD

BRAND	CAPACITY	RPM	BUFFER	INTEERFACE
Hitachi	80GB	7200RPM	2M	E-IDE
	160GB	7200RPM	8M	E-IDE
	250GB	7200RPM	8M	E-IDE
Maxtor	80GB	7200RPM	2M	E-IDE
	160GB	7200RPM	8M	E-IDE
	250GB	7200RPM	8M	E-IDE
Samsung	80GB	7200RPM	2M	E-IDE
	160GB	7200RPM	2M	E-IDE
Western Digital	80GB	7200RPM	2M	E-IDE
	160GB	7200RPM	8M	E-IDE
	250GB	7200RPM	8M	E-DIE
Seagate	40GB	7200RPM	2M	E-IDE
	80GB	7200RPM	2M	E-IDE
	160GB	7200RPM	2M	E-IDE
	250GB	7200RPM	2M	E-IDE

## USB MEMORY

Maker	Model Name	Speed	Capacity	Note
TRANSCEND	JF Series	1.0/2.0	Up to 4GB	
PRETEC	Tiny Series	1.0/2.0	Up to 4GB	
Absolline	Zibn2.0 Series	1.0/2.0	Up to 4GB	
LG	Xtick Series	1.0/2.0	Up to 4GB	
SANDISK	Cruzer Micro Series	1.0/2.0	Up to 4GB	
IOCELL	CELLDISK2.0 Series	1.0/2.0	Up to 4GB	Uninstall shielding Software
Samsung Electronics	SUB Series	1.0/2.0	Up to 4GB	
Imation	Iflash-ex Series	1.0/2.0	Up to 4GB	
HP S100	S100 Series	1.0/2.0	Up to 4GB	
Sony	Micro Vault Series	1.0/2.0	Up to 4GB	

- DVR may be not compatible with a unlisted USB Memory Stick.
- So, above listed USB Memory Sticks are recommended

## 1. DVR Setup

Change the default setup for your application.

### 1-1. Setup

Press “1111” (Default Password) with pushing “CH1” Button four times to enter into Main Menu.

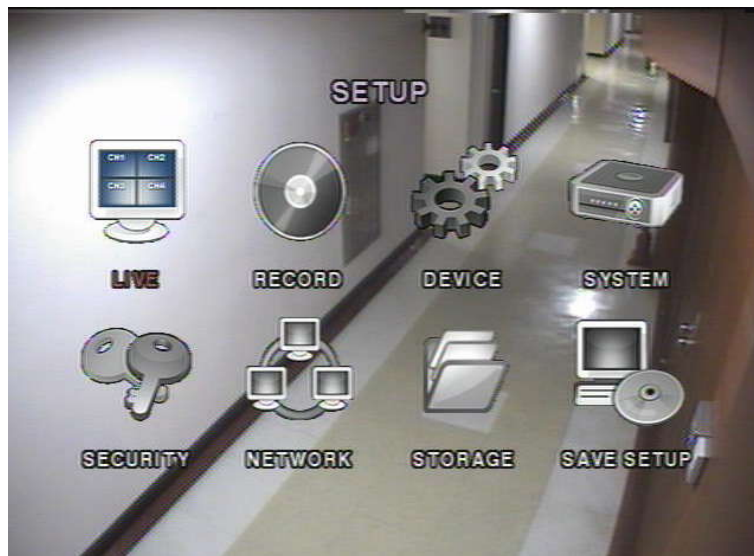

[Picture 1-1] Configuration Menu

#### [Reference]

This Manual is written mainly for the Remote Controller.

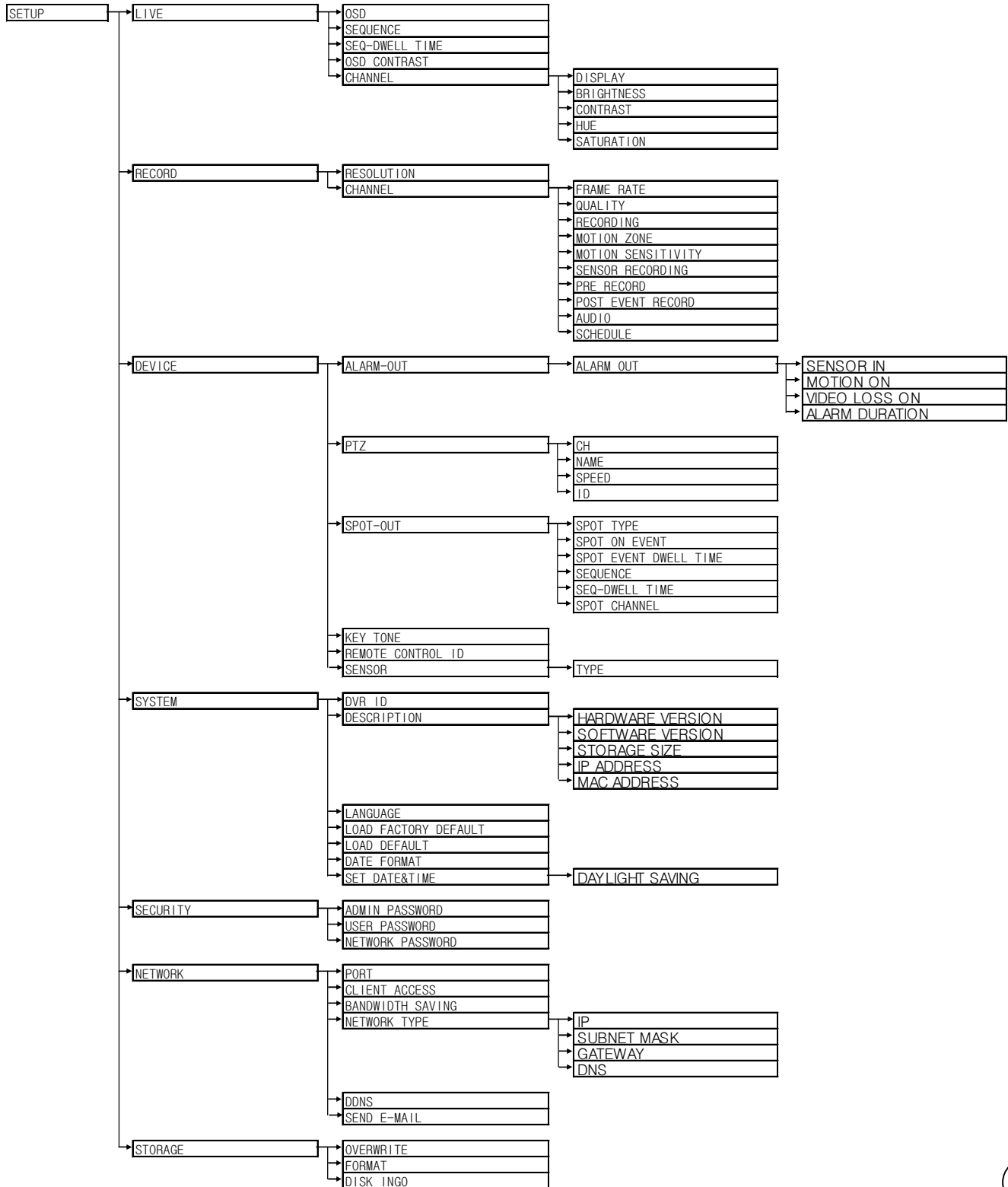

## 1-2. Live Mode Setup

Set the values for live display. Navigate through the menu items with pressing the UP or DOWN buttons. The values of the menu item may be changed with pressing the LEFT or RIGHT buttons.



[Picture1-2] Live Mode Setup Screen

Item	Description
OSD	Enable/disable on-screen-display.
SEQUENCE	Enable/disable SEQ button
SEQ-DWELL TIME	Set the dwell time for each, 4 or 9 channels display in sequential display mode.
OSD CONTRAST	Set the visibility level of the On Screen Display (OSD)
CHANNEL	Select the channel for applying the following settings. Press SELECT to change channel name.
DISPLAY	Enable/disable display of the video channel in live display mode
BRIGHTNESS	Change the brightness value for the specified channel
CONTRAST	Change the contrast value for the specified channel
HUE	Change the hue value for the specified channel
SATURATION	Change the saturation value for the specified channel

[Table1-2] Live Mode Setup

### 1-3. Recording Setup

Set the values for recording video. Navigate through menu items by pressing the UP or DOWN buttons. User can change the value of the menu item by pressing the LEFT or RIGHT buttons.



[Picture1-3] Recording setup screen

Item	Description
RESOLUTION	Set the resolution to 704x480, 704x240, or 352x240(NTSC).
CHANNEL	Select a channel for applying the following settings.
FRAME RATE	Set a recording Frame rate channel by channel. Max 120fps Recording at 352x240, Max 30fps Recording at 704x480
QUALITY	Select a recording quality for the specified channel from Network, Standard, High, Super or Ultra
RECORDING	Set a recording mode for each channel. Select one of Continuous, By Motion, By Sensor, By Schedule or Disable.
MOTIONZONE	Select Full Zone or Partial Zone for motion sensing.
MOTION SENSITIVITY	Set the motion sensitivity for the specified channel. Control the motion sensitivity from 1 to 9.
SENSOR RECORDING	Record a video when Sensor trigger.
PRE RECORD	5 Sec of Pre-event Recording from Event is triggered (Motion, Sensor)
POST EVENT RECORD	Set post event recording time duration for the specified channel
AUDIO	Audio ON/OFF for each channel.
SCHEDULE	Enable/disable audio for the specified channel

[Table1-3] Recording setup menu

### 1-3-1. Motion Detection Setup



By selecting Partial Zone in the Motion Zone menu, user can set-up the motion sensing zones in the screen. Move around each rectangular zone using 4 direction key buttons and press SEL button to include the rectangular region as part of the motion sensing zone. The rectangular blocks included as part of the motion zone are indicated by changing the color of the blocks.





[Picture1-3-1] Motion Zone selection screen

### 1-3-2. Schedule Recording

You can select your type of recording (Motion, Sensor, or Continuous) at one hour intervals for the week.

Buttons	Description
REW	Use to set Continuous recording mode. → C
F/REW	Use to Disable recording setting.
PLAY/PAUSE	Use to enable Motion detection triggered recording. → M
FF	Use to enable Sensor triggered recording → S
	Go Up
	Go Right

Buttons	Description
	Go Down
	Go Left
	Exit from the Schedule Menu

[Table1-3-2] Buttons for schedule Recording

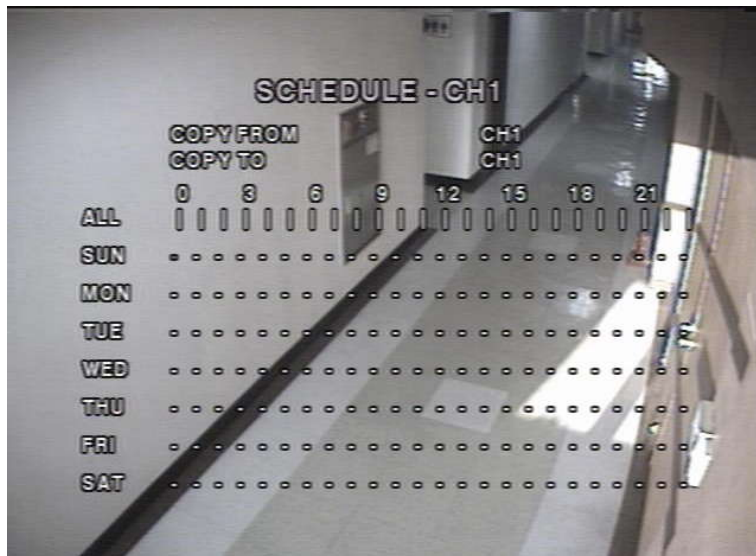

[Picture1-3-2] Schedule recording setup



#### 1-4. Device Setup

Set the values for device setting. Navigate through menu items by pressing the UP or DOWN buttons. User can change the value of the menu item by pressing the LEFT or RIGHT buttons.



[Picture1-4] Device setup screen

Menu	Description
ALARM-OUT	Set the sensor, motion, and video loss for each alarm.
PTZ	Set the camera speed, number, type and ID
SPOT-OUT	Select channel for spot monitoring
KEYTONE	Enable/disable key tone
REMOTE CONTROL ID	Select a remote controller ID (No. 0~99 Selectable)
SENSOR	Select a sensor number and type

[Table1-4] Menu in Device Setup

## 1-4-1. Alarm Output

Item	Description
ALARM OUT	Select an alarm output number (No.1~4 Selectable)
SENSOR IN	Select a sensor input (No.1~4)
MOTION ON	Select a motion sensor (No.1~4)
VIDEO LOSS ON	Select a video loss channel (No.1~4)
ALARM DURATION	Setup a alarm duration. (1~60Sec)

[Table1-4-1] Device Setup

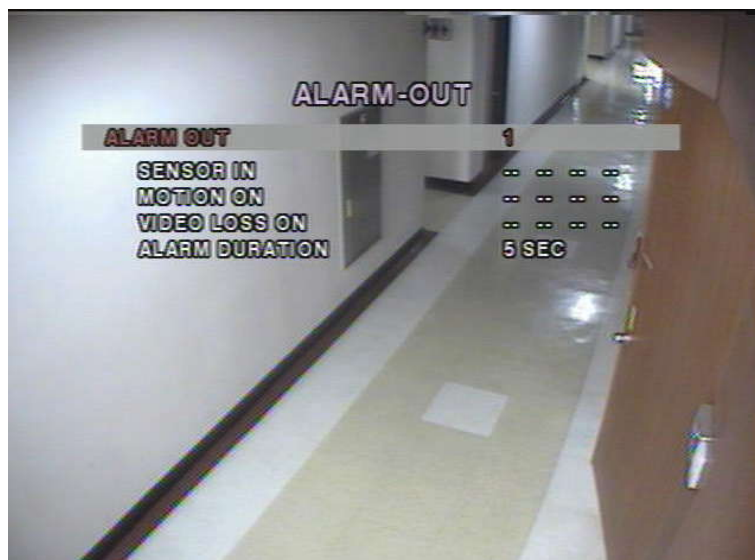

[Picture1-4-1] Device Setup

### 1-4-2. Camera Control

This is to control a camera through RS-485 Port.

Select channel No for camera control.

Select a type of camera and setup speed and camera ID



[Picture1-4-2] Camera Control

### 1-4-3. PTZ Control

Select "PTZ" button on front panel of DVR after completion of Camera Setup.

Setup menu for your application.



[Picture1-4-3] PTZ Control

Item	Description
PAN/TILT	Up and Down button for Tilt and Left/Right button for Pan
ZOOM/FOCUS	Up and Down button for Zoom and Left/Right button for Focus
INITIALIZE	To initialize the camera setting

[Table 1-4-3] PTZ Control Button

#### 1-4-4. SPOT Output

This page explains functions of SPOT output.



[Picture 1-4-4] SPOT Output

Item	Description
SPOT TYPE	Select type of SPOT (Full or 4Screen)
SPOT ON EVENT	Setup spot on Event
SPOT EVENT DWELL TIME	Setup SPOT Event Dwell Time
SEQUENCE	Setup sequence mode
SEQ-DWELL TIME	Setup SEQ-DWELL TIME
SPOT CHANNEL	Select channel of SPOT Output

[表1-4-4] SPOT Output Menu

## 1-5. System Setup

Setup Name, Information, Date of System.

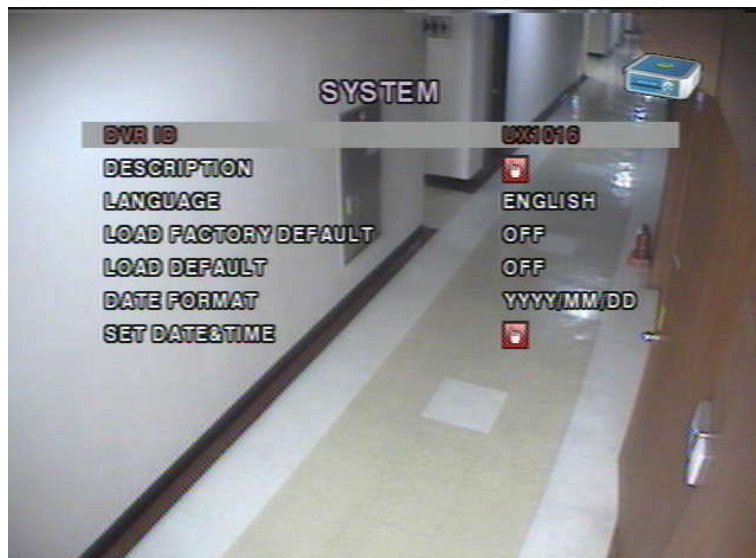

[Picture1-5] System Setup

Item	Description
DVR ID	Make a name of DVR with UP/DOWN/LEFT/RIGHT Buttons
DESCRIPTION	System Information (Version, HDD Capacity, IP Address, MAC Address)
LANGUAGE	Select a language
LOAD FACTORY DEFAULT	Initialize all of the Settings
LOAD DEFALT	Go to factory default (Except for Password, Date Format, DLS, Network Setup, HDD Overwrite )
DATE FORMAT	Year/Month/Date format setup
SET DATE&TIME	Date and time of auto rebooting setup Summer time Setup

[Table1-5] System Menu



[Picture1-5-1] ID Setup

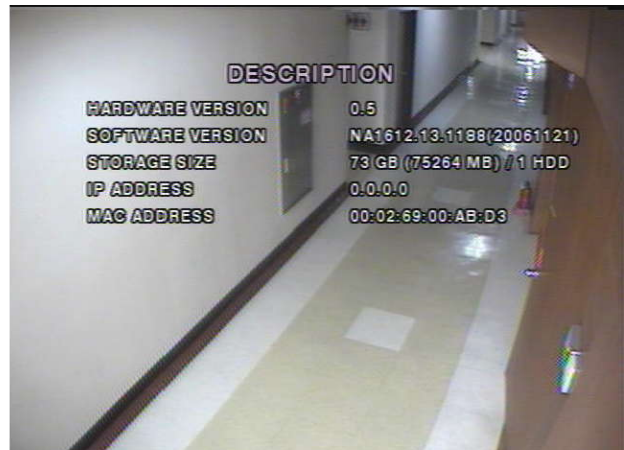

[Picture1-5-2] System Information



[Picture1-5-3] Summer Time Setup



[Picture1-5-4] Date/Time Setup



## 1-6. Security Setup

In this menu, password and security parameters can be inputted. Navigate through the menu items by pressing the UP or DOWN buttons. User can change the value of the menu items by pressing the LEFT or RIGHT buttons.



[Picture 1-6] Security Setup

Item	Description
ADMIN PASSWORD	Authorize all menu settings. Default P/W:1111
USER PASSWORD	Authorize the specified menu settings by Administrator
NETWORK PASSWORD	Password for DVR monitoring through network. Default P/W "1111"

[Table1-6] Security Menu



## 1-7. Network Setup

Network parameters can be inputted in this screen. These parameters are used for remote clients who are connected to the DVR over the network.

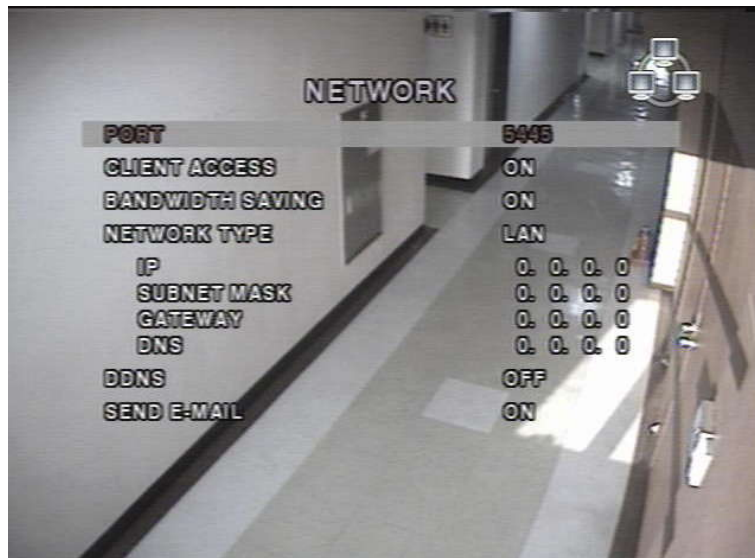

[Picture1-7] Network Setup

Item	Description
Port	Port Number (Default : 5445)
Client Access	Authorize Client Access through Network Select "ON" for Access from Remote Area
BANDWIDTH SAVING	Select "OFF" for data transmission under Low Bandwidth
Network Type	Select one of the network types (LAN, ADSL, DHCP)
DHCP	DHCP Select "DHCP" for Dynamic IP connection
ADSL	ID : Register "ID" for ADSL Connection Password : Register "ID" for ADSL Connection
LAN	IP : Register "IP Address for your application. GATEWAY : Register gateway number for your application. SUBNET MASK : Register subnet mask number for your application.

Item	Description
DDNS	DDNS Setup is used to get Domain Address after DDNS Server registration. When "DDNS" is turned on, DDNS Server Name is displayed for Domain Registration. DDNS Sever Name : "dns.umbddns.com → Factory Default Domain Name is used for Network Connection . (IP Address Available) And, Bar Code number on the back side of system must be registered. Ex) xxxx.umbddns.com is created and "umbddns.com" is uneditable. But, "xxxx" is editable .

[Table1-7] Network Menu

**[Note]**

MAC Address (System → System Information) should be registered on our company's server. If not registered, DDNS cannot be used.

Call if you need to register with our server and we will walk you through it.

**1-7-1. Port**

When connecting 1 or more DVRs to a network through an IP sharing device, each device must have a unique RTSP port number for access to each unit from outside the LAN. Also, the IP sharing device must be configured for port forwarding, so that each port, when accessed on the IP sharing device, will forward to the appropriate DVR. This port number is listed next to the Port menu option in the NETWORK menu. If the user plans to only access the units from within the same local area network, the RTSP port does not have to be changed.

**IP Router**

When DMZ Setup or Port forwarding is used, three port numbers must be set for port forwarding. Example) if 5445 is selected as a port number, Both 5446 and 5447 must be registered.

Please refer to the manual of your router because each router has a different way to port forwarding!

## 1-7-2. Network Type

Select a type of Network

### LAN

This is used for Network Connection through Static IP, DMZ configuration of Router or Port Forwarding.

Network Configuration

1. Static IP (Refer to Network Manager)
2. ADSL Connection through Router

With setting up "DMZ" or "Port Forwarding", Router itself grants Internal Static IP Address. Every router is different and if you have any questions on how to do this you will need to call the provider of your internet service or your router manufacturer, and tell them you need to port forward ports 5445-5447 in the TCP direction, to the IP address of your DVR.

Item	Description
IP	The fixed IP address of the DVR
GATEWAY	The IP address of the gateway
SUBNET MASK	The subnet mask for the LAN
DNS	Set the DNS IP.

[Picture1-7-2] LAN Menu

### DHCP

This setup is used with dynamic IP not static IP.

Every IP address is granted automatically under the dynamic IP network.

(This is not a permanent IP but a granted IP whenever network connects, which means DHCP)

### ADSL

ADSL line supplied by Network Service Company is used.

(PPPoE Network)

(ID, P/W necessary for connection)

Item	Description
ID	The user ID for ADSL connection
PASSWORD	The password for ADSL connection

[Table1-7-3] ADSL

### DDNS

MAC Address granted to each system (12 digit number or Mac address in system information) must be registered to DDNS Server to get a domain address.

Regardless any change of Network IP, You can connect a network with a registered domain name.

(Example : domain name is like "xxxx.umbddns.com" and "umbddns.com" is uneditable)

DDNS Server Name : ns.umbddns.com. This is unchangable

## 1-8. Recording Device

User can set recording mode in the hard disk drive or initiate format of the hard disk driver.



[Picture1-8] Recording Device

Item	Description
OVERWRITE	Overwrite existing material when hard disk drive is full.
FORMAT	Format all of stored data in HDD
DISK INFO	Information such as capacity, usage, recording times, and others of all HDD installed in DVR.
LOAD SETUP FROM A USB	Load the settings to DVR from USB
SAVE SETUP TO A USB	Save the settings in DVR through USB
RECORD LIMIT	Select a period of recording
RECORD LIMIT DAYS	Setup Recording Period

[Table1-8] Recording Device Menu

### 1-9. Save Setup

Save the changed Setup Menu

If Save Setup is not selected, the changed setup doesn't record after system rebooting



[Picture1-8] Save Setup

## Live Search

### 2. Live Search

- 2-1. **Live Screen**  
 Show Live Images by Cameras and information of each channel, HDD Capacity and Recording



[Picture2-1] Live Screen

Icon	Description
	Continuous recording in progress
	Manual recording in progress
	Motion recording in progress
	Sensor Recording in progress
	Event Recording for each channel in progress
	Indicates that alarm output is activated.
	Indicates that a network client is connected to the DVR.
	Indicates that sequencing mode is enabled.

[Table2-1] Live Screen Icon

Button	Description
SETUP	Launch the SETUP menu.
SEQ	Enable/disable the automatic sequential display in full or quad mode. The channel display in quad mode is followed by the settings in the setup menu.
PLAY/PAUSE	Launch the SEARCH window.
	Direction buttons (UP/DOWN/LEFT/RIGHT)
SEL	Switch between full screen and current display mode.
ESC	Cancel Setup Menu
REC	Select for manual recording for all channels.

[Table 2-1-1] Live Screen Button

## 2-2. Search Screen

If User pushes the PLAY/PAUSE button on live mode, below picture(2-2) shows.

Red Color of Date indicates recorded data.

Select a red colored date and channel # and recording type (A : All, M : Motion, S : Schedule, R : Pre-Recording, C : Continuous).



[Picture2-2] Search Picture



### Event Search

1. Select PLAY/PAUSE button and a date for search.
2. Push "SEL" Button
3. Below search menu shows
4. Recording type (A : All of Recording Data Search, M : Motion Recording Data Search, S : Sensor Recording Data Search, R : Manual Recording Data Search, C : Continuous Recording Data Search)
5. Recording type shows on search bar, Go to your selected channel # or all for search.
6. If "ESC" button is selected during playback, it returns to the search menu.
7. Keep pushing "ESC" button to go back to live mode

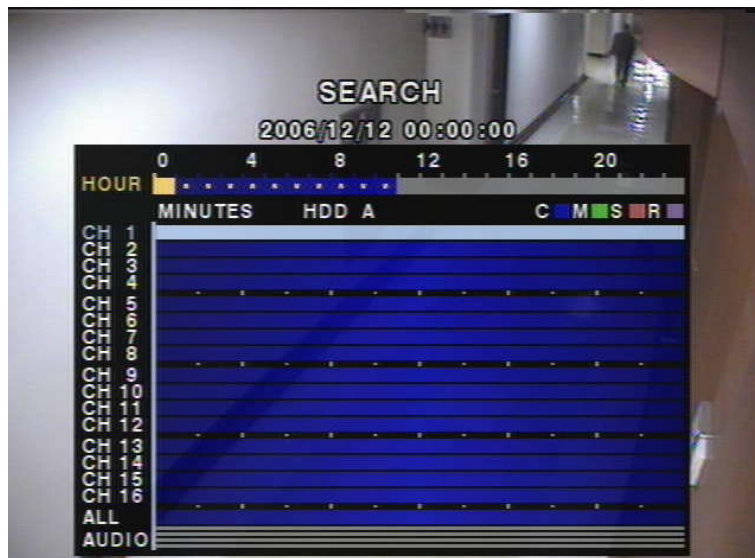

[Picture2-2-1] Search List

### 2-3. Playback

Picture [2-3] shows all channels of playback images.

“ESC” Button goes back to the previous screen.



[Picture2-3] Live Picture

Button	Description
ESC	Return to the previous menu screen or exit from the setup menu
REW	Press to rewind video at 1x, 2x, 4x, 8x speed. Press “PLAY” button to go back to normal speed playback.
F/REW	Jump/Step backward. The playback position moves 60 seconds backward.
PLAY/PAUSE	Press to play or pause recorded video.
F/ADV	Jump/Step forward. Playback position moves 60 seconds forward.
FF	Press to fast forward video at 1x, 2x, 4x, 8x speed. Press “PLAY” button to go back to normal speed playback.
	Use to select channel 1 to 4 in full screen mode or to change the quad display by using the LEFT or RIGHT button. The channel display in quad mode is followed by the settings in the setup menu.
SEL	Switch between full screen and current display mode.
FREEZE/CAPTURE	Press “FREEZE/CAPTURE “ to record Video & still image through USB

[Picture2-3] Live Picture Icon

## Archiving Video Into USB Memory Stick

### 3. Archiving Video Into USB Memory Stick

To archive a still image or video to a USB storage device, user must first capture a still image or video to a hard disk drive.

#### 3-1. Video & Still Image Recording

Still Image Recording can be archived on both Live Mode and Playback Mode.

Press “FREEZE/CAPTURE” button to finish a recording.

Refer to [Picture 3-1]



[Picture 3-1] Still Image Recording

#### Still image archive

Still image can be captured and stored into the hard disk drive during live mode or while playing back recorded video.

During live mode and playback mode, press FREEZE/CAPTURE button twice to capture and store the still image. Once you press the FREEZE/CAPTURE button twice, the screen shown in Picture 5.1.1 will be displayed.

The still image will be stored into the hard disk drive and can be transferred to the USB storage device later.

#### Video archive

Video can be archived and stored into the hard disk drive during playing back recorded video.

During playback mode, press the FREEZE/CAPTURE button to launch the archiving function.

The system will ask whether to store still image or video.

If the user selects still image, it will store captured image into the hard disk drive.

If the user selects video, it will store video into the hard disk drive. When a USB storage device is plugged in and archiving to the USB is requested, the system will convert the corresponding portion of the video into an AVI file and store it on the USB storage device.

### 3-2. Video & Still Image Back-up through USB

Connect USB memory stick to USB port

Press "ARCHIVE" button to select a date on the calendar.

Select a red colored date including recorded data with "SEL" button.

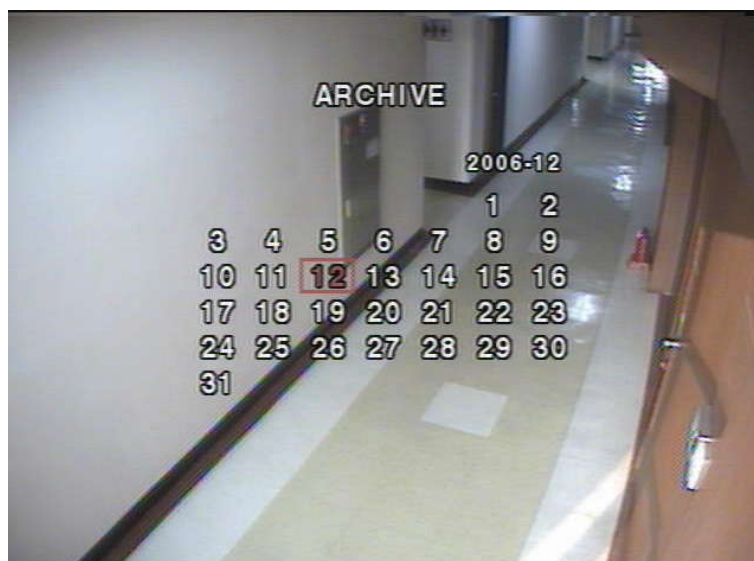

[Picture3-2] Still Image Search

After selecting data for USB Backup, Year/Month/Date/Time shows on the screen.

Select "FREEZE/CAPTURE" button and choose "USB Memory" or "CD-RW" for backup.

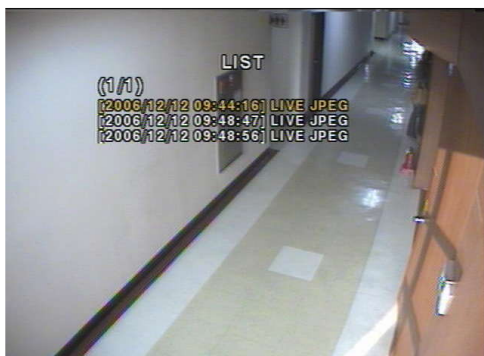

List for Backup



Still Image File



USB Recording



CD-RW Recording

Video for backup is recorded as AVI File.

If your PC fails to play backup data, please install a codec program.

<http://www.divx.com/divx/download/>

## Upgrading Firmware

### 4. Upgrading Firmware

It is possible to upgrade Firmware through USB.

Make “upgrade” folder in Memory stick and put a new firmware.

(app9.bin(9CH Firmware), app16.bin(16CH Firmware))

1. Press [SETUP] button and input a password. (Default P/W “1111”.)
2. Go to the SECURITY and select the ADMIN PASSWORD.
3. Enter the password as 12341234, and press the SEL button.
4. After auto rebooting, Test Program is activated.
5. Select USB UPGRADE and then the upgrading will start automatically.
6. After the upgrade is completed, select BOOT APPLICATION to reboot DVR.



USB Upgrade

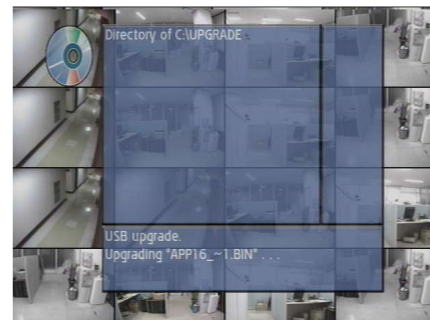

Upgrade in progress

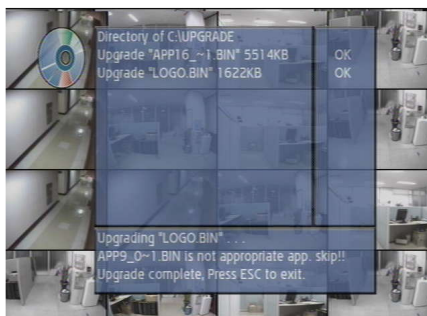

Upgrade Complete



System Return

[Picture 4-1] USB Upgrade



## Network Client

### 5. Network Client

The DVR provides a live remote monitoring feature. Remote monitoring requires installation of a software client program on your PC. A LAN connection using the RJ45 connector on the rear panel is mandatory for remote connection.

For the local operation purposes, the frame rate is limited to 1 frame/sec when there is no recording operation in the DVR. When recording is under progress, video frame rate for the live monitoring will follow the recording frame rate.

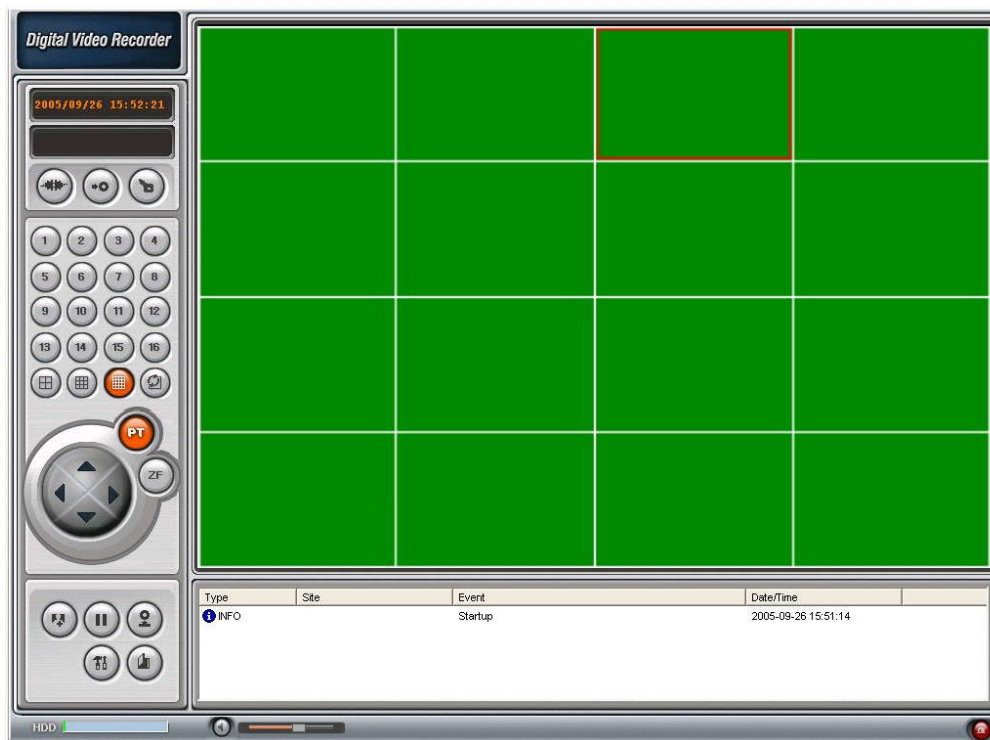

[Picture5-1] Main user interface

#### 5-1. Overview

The remote software supports remote live viewing, search, playback and system configurations.

By installing the 9/16CH remote software on a Windows based PC, you can monitor real-time and recorded images via optional Ethernet network. This includes the ability to monitor video, playback recorded video and change operating parameters.

## 5-2. Minimum PC requirements

	Minimum	Recommended
CPU	Intel Pentium III	Intel Pentium IV
	500Mhz	2Ghz
Memory	128MB	256MB
VGA	16MB	64MB
Resolution	1024x768	1024x768
Disk space	10MB	10MB
OS	Windows 2000	Windows 2000, Professional, XP
Network	10/100Base T	10/100Base T
Others	Direct X 8.1	Direct X 8.1 or Higher

## 5-3. Installing the program

1. Insert the provided CD into the CD-ROM drive of your PC.

2. Run  to start the installation process.

3. Double click the  icon to start the program

## 5-4. Live viewer





When installation is complete, double click the  icon on your desktop to start the program.

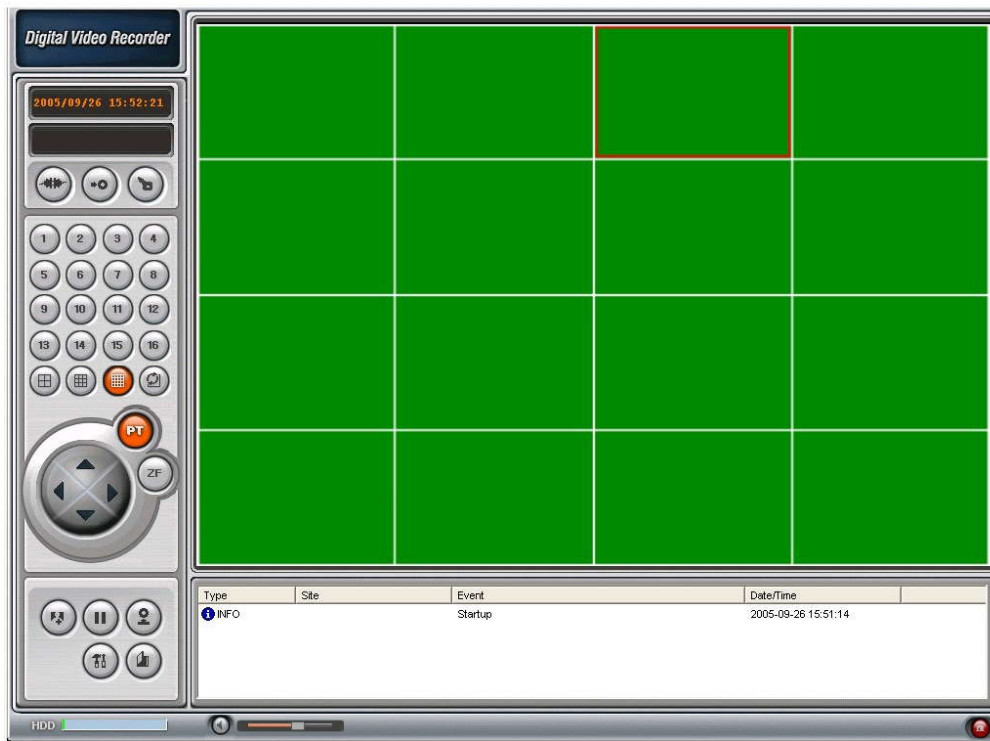



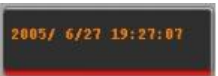

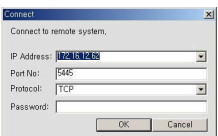













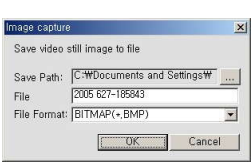



## 5-4-1. Main Screen



## 5-4-2. Main Control Button

Button	Description
	Displays the current date and time.
	Click this icon to connect to the DVR
	Menu Screen IP Address : Input DVR IP address or domain address Port No : Input port # – default is 5445 Protocol : Select a normal TCP protocol Password : Input DVR P/W – default is 1111
	Click this icon to disconnect from the DVR

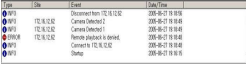
	Click this icon to search for recorded videos.
	Click this icon to see live video.
	Press this button to lock the program
	Press this button to disarm the security.
	Once you click the lock or unlock icon, this pop up window appears. You need to remember the pass word and enter the pass word again when you try to operate the client software. (There is no default to this password. Please write down what you use because we will not be able to help you restore it.)
	This button is used to control PAN/TILT & ZOOM/FOCUS of PTZ cameras.
	Click this icon to play live video.
	Click this icon to pause live video.
	This button is to record Live Image to your computer. The recorded data is stored in "Storage" Folder as date format.
	This button is to record a still image to the appointed folder by USER. (One channel capture available)
	This window pops up on still image recording. Save Path : Appoint the folder for saving File : Appoint a name of file for saving. File Format : Appoint a file format for saving. BMP or JPG selectable





	Click this icon to enter setup configuration of client software.
	Click this icon to exit from the operations of client software.
	Alarm indicators for each channel.
	Full screen
	Quad screen
	9 Split screen
	16 Split screen
	Click this icon for Sequential display of each channel in full screen mode.
	Adjust audio volume
	HDD storage Indicator of DVR.
	It shows the client connection information.
	Max/Min/Exit of the client viewer

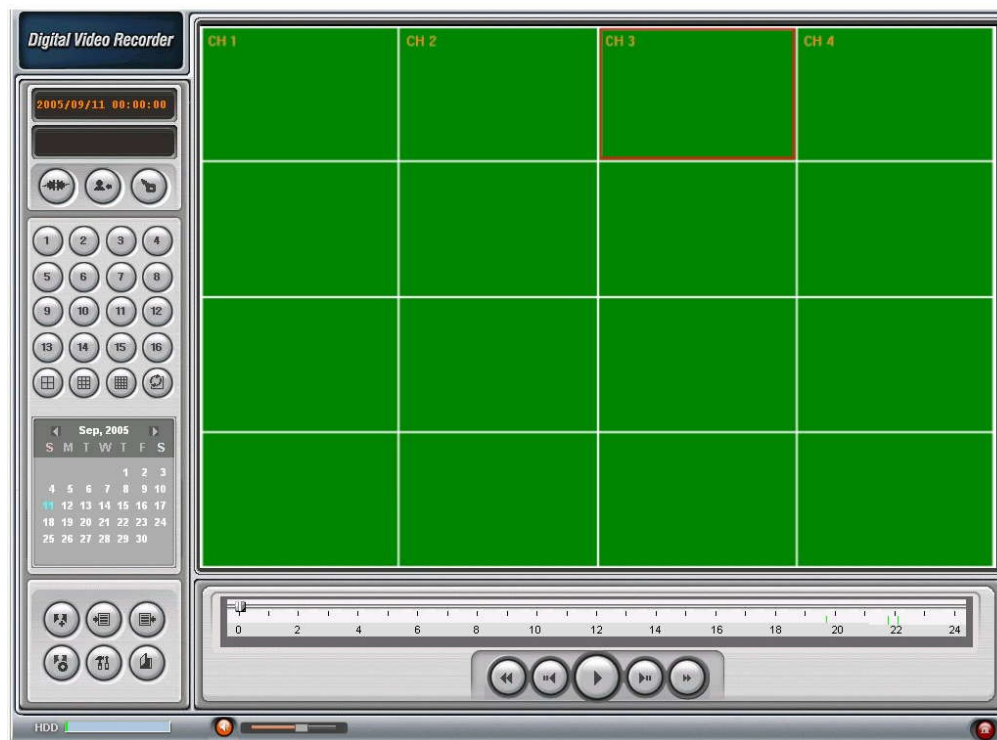



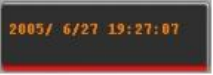



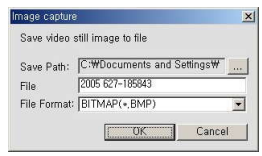

### 5-4-3. Search Mode



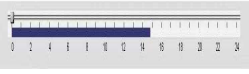



Press Search Button to show below window.



### 5-4-4. Search Control Button

Button	Description
	Displays the recording time of the selected data by adjusting of scale in the middle of the bottom of the main user interface.
	Click this icon to see live videos.
	Click this icon to exit from the operations of client software
	Click this icon to capture a still image of recorded video.

	<p>Save Path : Appoint the folder for saving  File : Appoint a name of file for saving.  File Format : Appoint a file format for saving.  (BMP or JPG selectable)</p>
	<p>Click this icon to set the beginning time for backup of the recorded video in AVI format – Do this after you have selected your beginning time on the timeline.</p>
	<p>Click this icon to set the ending time for backup of the recorded video in AVI format – Do this after you have selected your beginning time on the timeline.</p>
	<p>Click this icon to backup the recorded video in AVI format.</p>
	<p>The calendar shows dates with recorded video in a light blue and the selected date in dark blue.</p>
	<p>The timeline shows recorded data in dark blue on the bar. You can adjust the time line scale and move it to the time you wish to playback. Then click the play icon to display the recorded video.</p>
	<p>Click to play the recorded video.</p>
	<p>Click to pause the displayed video.</p>
	<p>Click to fast forward the video at 2x and 4x speeds in playback mode.</p>
	<p>Click to rewind the video at 2x and 4x speeds in playback mode.</p>
	<p>Click to reverse 1 frame.</p>

	Click to advance 1 frame.
	Quad screen
	9 Split screen
	16 Split screen
	Left/Right Button is to search every 1 hour data. Middle of button is to change the selected one hour to 60 minutes.
	Shows the capacity and fullness of HDD.

## 5-5. System Setup

Press  to enter into Setup Menu.

### 5-5-1. General

#### Security Option

This option is to protect any unauthorized approach with P/W Setup.

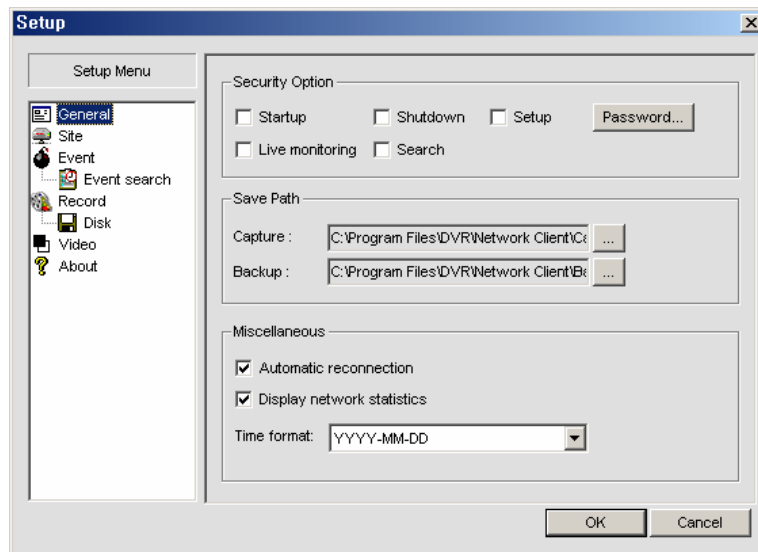

#### Password Setup Menu

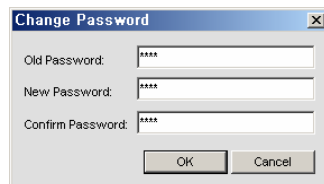

#### Save Path

Select a folder to save each setting.

#### Miscellaneous

##### Automatic reconnection Menu

This option connects with network automatically on Network delay or disconnection.

##### Display Network statistics

This is to show a network speed.

### 5-5-2. Site

User can change a name of each site.

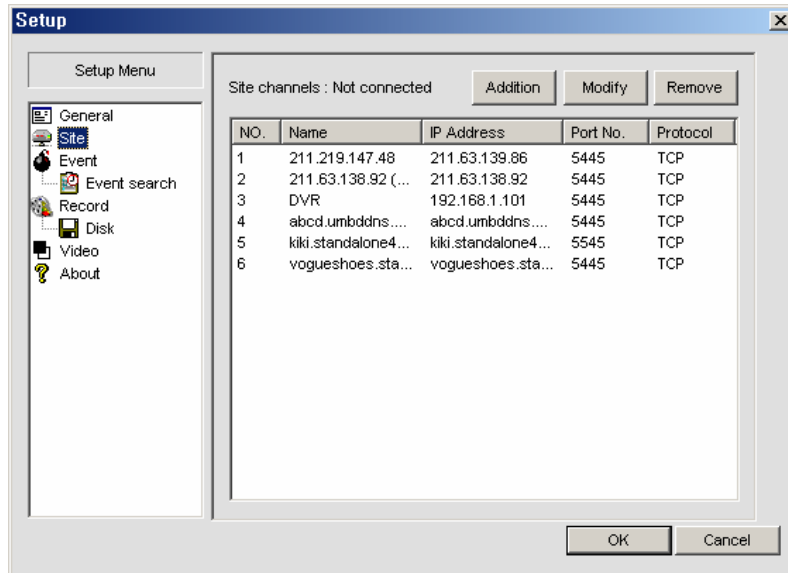

### 5-5-3. Event

This saves each event to the appointed file.

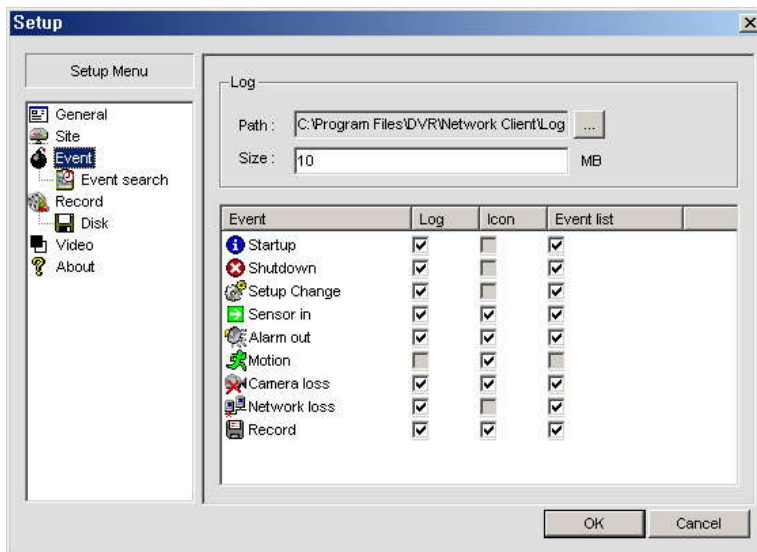



## Event search

This shows a log history of a specified date and time.

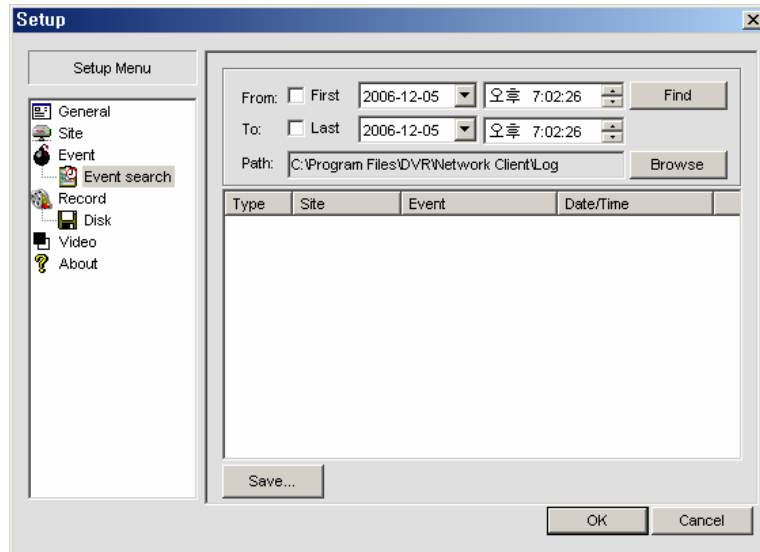

### 5-5-4. Record

This is to set a record option of each channel.

(This is not DVR recording option but client program recording option.)

Always → Continuous Recording, Event → Motion or Sensor Recording, Auto Record  
→ Auto Recording on program start

Recording time setup is available with "Motion" or "Alarm" Setup on Event Recording Setup.

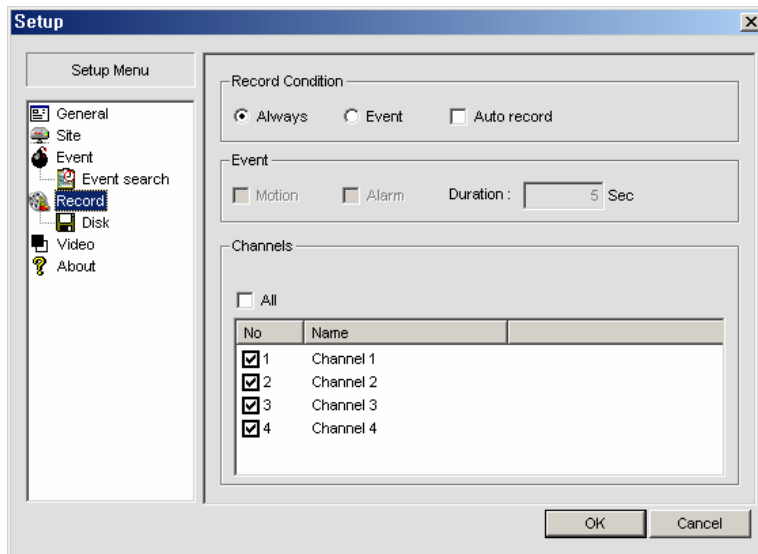

This recording option indicates a current status of recording setup of DVR.

## Disk

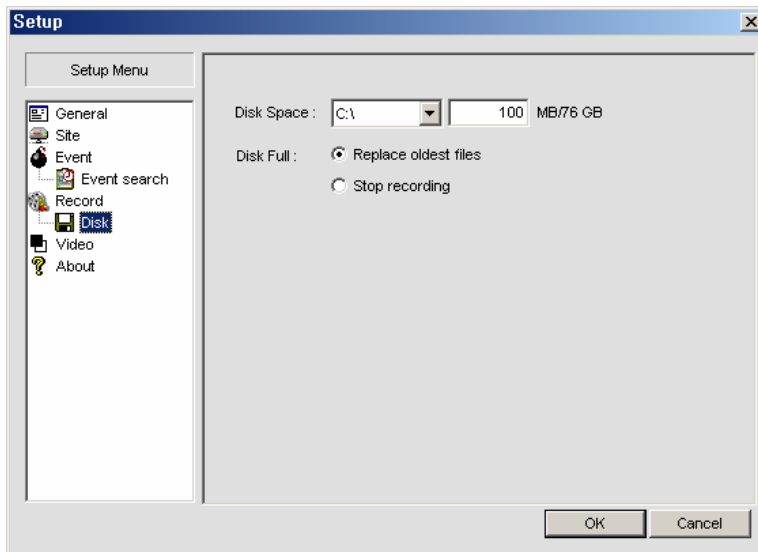

You can select the local disk to use and the amount of disk space you want to allow the program to use for recording. You can also select the option to overwrite data or stop recording when the maximum amount of disk space is full.

### 5-5-5. Video

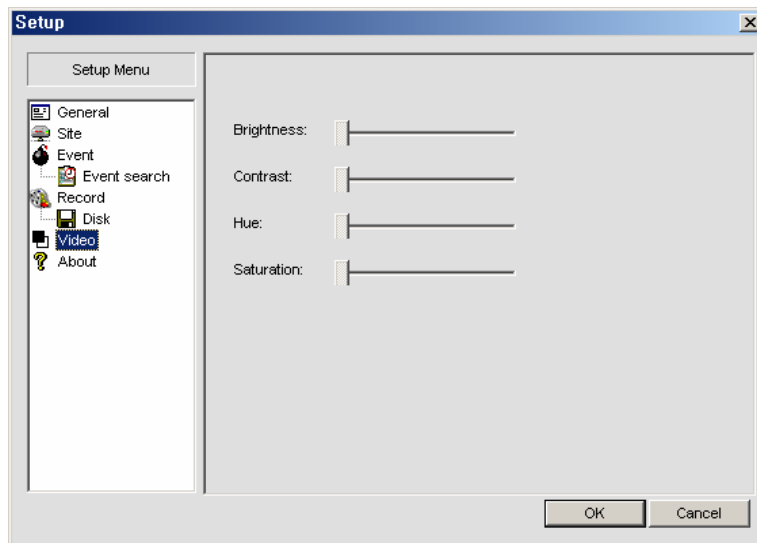

This page is to match colors of client program.

(This is supported depending on an installed video card in personal computer.)

### 5-5-6. About

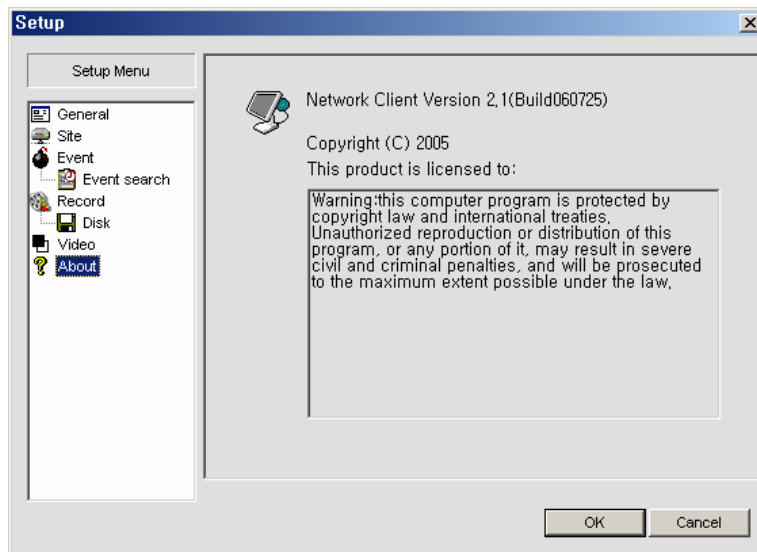

“About” provides network client version information.

