

FOR THE LATEST IN GAMING VISIT

D2D Direct2Drive.com

10% OFF

on your next purchase when you sign up using coupon code*:

“FLASHBACK2D”

Now that you've stepped back into the past, flash forward and sign up with Direct2Drive.com and discover the latest titles in gaming! We have over one thousand titles to choose from ranging from classic titles to new releases! So sign up today and use your coupon code above on your first purchase!

*Coupon good for one purchase only per account on Direct2Drive.com. Some restrictions may apply. Coupon code valid in North America only. Offer expires 12/31/2017. ©2015 AtGames Cloud Holdings Ltd. All rights reserved.

AtGAMES

© 2015 AtGames Digital Media Inc.

www.atgames.us

All rights reserved.

Made in China.

Game Software© SEGA. All rights reserved. SEGA, the SEGA logo and GENESIS are either registered trademarks or trademarks of SEGA Corporation.

Distributed by AtGames under license from SEGA Corporation.

The content of this document is subject to change without notice.

Find Accessories for Portable Game Player at www.atgames.us



ULTIMATE PORTABLE GAME PLAYER

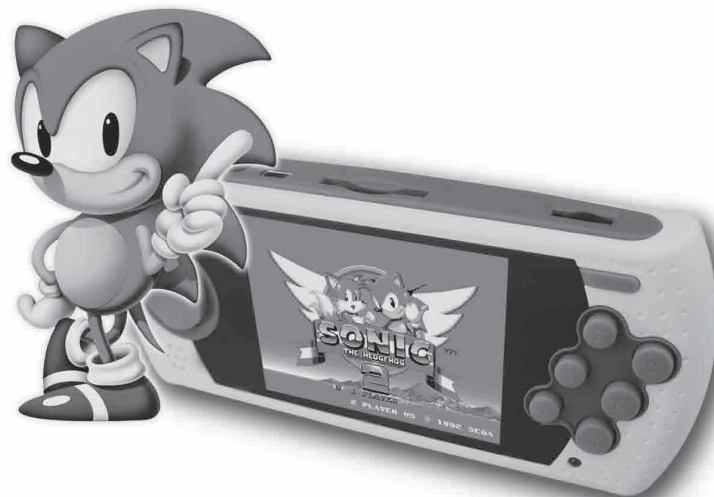

AtGAMES

AtGames Digital Media Inc. www.atgames.us

INSTRUCTION MANUAL

(MODEL NO: GP2632)

Game Player Appearance and Key List

The image below shows the location and function of each jack and key. (The illustration is for reference only.)

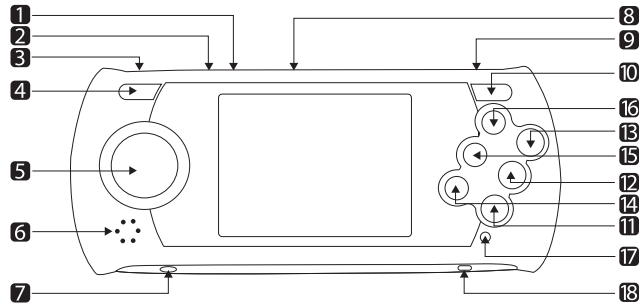

- 1 Mini USB port**
Mini USB port for charging
- 2 AV Out**
Audio/Video output
- 3 Charger Indicator**
It is red light during charging and shows yellow light when it is fully charged
- 4 Menu**
Player's menu
- 5 Directional Pad (D-Pad)**
Directional Pad for game playing
- 6 Speaker**
Audio Speaker
- 7 Earphone Jack**
Earphone input
- 8 SD Card Slot**
SD Card slot
- 9 Volume Control Switch**
Rotate dial to the up/down to increase/decrease volume

- 10 START/PAUSE**
Press to start the game and Press again to pause
- 11 A Key**
Game Key A
- 12 B Key**
Game Key B
- 13 C Key**
Game Key C
- 14 X Key**
Game Key X
- 15 Y Key**
Game Key Y
- 16 Z Key**
Game Key Z
- 17 Low Battery Indicator**
When it is lit, charge your battery promptly to avoid a sudden shutdown
- 18 Power On/Off**
Power on/off the player

How do I play the game?

1. Slide the ON/OFF switch to ON to turn on the game player.
Slide the ON/OFF switch to OFF to turn off the game player.
2. Press Up or Down on the D-Pad to select one of your favorite games, then press the START /PAUSE or A key to enter the selected game.
3. Press the START/PAUSE key to start playing game.



How do I switch back to game menu while playing a game?

Press MENU key, and the screen will go back to the game menu page.

How to play on TV?

Connect the game player to TV by using AV cable. (AV cable is not included). Configure the TV input source to AV in, then press the MENU key to display game menu on TV. The player will detect the presence of a TV and display the game video on TV screen automatically when you press MENU.



NOTE: For Plasma & LCD TV of over 32", please adjust your TV to the following setting for the best display result.

Back-Lighted: 100	Brightness: 36	Contrast: 70
Color: 60	Sharpness: 60	Aspect Ratio: 16:9

How to play the games on my SD card?

1. Turn off the game player.
2. Insert the SD card into the SD slot.
3. Turn on the game player.
4. Select SD CARD on the last page of menu, press start.
You will then enter a menu page of the games in the SD card.
5. Select a game and press START/PAUSE.

How to add games to SD?

1. Insert SD card to PC (SD card is not included).
2. Create a folder with the name of GAME or Game (if the SD doesn't have a GAME or Game folder already.)
3. Place games in the GAME or Game folder.

NOTE: Please do not insert/remove the SD card while the power is on. It may damage the game player.

How to charge my player?

1. Connect the player to a computer using the USB cable (included) or a USB charger (not included).
2. You may also use a USB switching power adapter (not included) to connect with the USB charging cable and the household AC outlet to charge the player.
3. USB adapter specification:
Input Voltage: 100 - 240V AC
Output Voltage: 5.0V DC/ Output Current: 500mA
Your battery should be fully charged after 11 hours for the first time, and subsequent charging will take about 3 hours each time. After each full charge, the battery can provide you about 4-6 hours of game playing.

Safety Notice:

Do not submerge the game player in water or expose it to extreme heat or to strong magnetic fields. Doing so may cause permanent damage to your game player.

* Batteries are only to be charged by adults or by children at least 8 years old.

Warning: Changes or modifications not expressly APP by the party responsible for compliance could void the user's authority to operate the equipment.

NOTE: This equipment has been tested and found to comply with the limits for a Class B digital device, pursuant to Part 15 of the FCC Rules. These limits are designed to provide reasonable protection against harmful interference in a residential installation. This equipment generates, uses and can radiate radio frequency energy and, if not installed and used in accordance with the instructions, may cause harmful interference to radio communications. However, there is no guarantee that interference will not occur in a particular installation. If this equipment does cause harmful interference to radio or television reception, which can be determined by turning the equipment off and on, the user is encouraged to try to correct the interference by one or more of the following measures:

- Reorient or relocate the receiving antenna.
- Increase the separation between the equipment and receiver.
- Connect the equipment into an outlet on a circuit different from that to which the receiver is connected.
- Consult the dealer or an experienced radio/TV technician for help

Repair and Exchange Service

If the unit is damaged due to its improper use or simply wear and tear, and if the place where the product was originally purchased can't do exchange of this product, a standard repair and exchange program can be offered to help. Please visit http://www.atgames.us/Repair_c2.htm to find out more details and purchase the Repair and Exchange program.

How do I turn off the game player?

Slide the ON/OFF switch to OFF to turn off the game player.

Additional Battery Safety Messages

To prevent possible battery leakage, overheating or explosion, please pay attention to the following measures.

Safety

- ▶ Should not be put into water. should be placed in a dry and shady environment when not used.
- ▶ Should not be used or stored near sources of heat such as fire or heater.
- ▶ When charging, please use included charger only.
- ▶ Should not be thrown into the fire or heater.
- ▶ Should not be connected as short circuit.
- ▶ Should not be struck, thrown, or stepped on.
- ▶ Should not be welded directly.
- ▶ Do not use nail or other sharp tools to pierce the battery.

Caution

- ▶ Do not use or store the battery where it is exposed to extreme heat, such as beneath the window of a car in direct sunlight in a hot day. Otherwise, the battery may be overheated. This can reduce the battery performance and shorten its life.
- ▶ Do not place the battery under strong electric field or magnetic field.
- ▶ Doing so may damage the battery safety protection devices, thus bringing latent risks.
- ▶ Do not use the battery if it gives off an odor, generates heat, becomes discolored or deformed, or appears abnormal in any way. If the battery is in use or being recharged, remove it from the device or charger immediately.

How to remove battery before disposal of product?

1. Open the battery compartment cover by using screwdriver (not included).
2. Remove the battery before disposal the product.

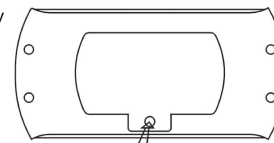

open the battery compartment cover by unscrewing the screw, then push the clip in the direction indicated by arrow.

1. Alex Kidd in the Enchanted Castle



Alex Kidd's father's life is in danger! Fortunately, facing danger is what Alex does best! To save his father, he must win round after exciting round of "Paper, Rock and Scissors". Winning rounds not only moves Alex that much closer to his father, but winning also provides gifts that Alex can utilize for special powers. These will be necessary as the opponents get harder and harder and the danger increases! If Alex can win the ultimate level, he can save his father and win amazing prizes as well! There is not time to lose!

Directional Pad (D-Pad): Control the direction.

Start Key (Start): Start the game.

Select the tool in tool menu.

A Key: Jump up and kick.

B Key: Attack by fist.

C Key: Jump up and kick.

2. Alien Storm



Strange and deadly aliens have invaded the earth and it is up to you to stop them! Your battle will take you through numerous environments as you fight your way to the mother-ship to face off with the "mother of all aliens". Each character has unique attacks and special abilities that will add strategic variety to your game play. Additionally, mission objectives provide opportunities for exciting power-ups. It will take all your skills to save the Earth!

Directional Pad (D-Pad): Control the direction.

Press the Right Key twice to make hero run.

Start Key (Start): Start the game.

Pause and un-pause game.

A Key: Powerful attack in wide area which takes a lot of energy.

B Key: Attack in medium power.

Press to attack while in sprint status.

C Key: Toss forward.

Press to jump while in sprint status.

3. Altered Beast



In a time of legend, warriors and supernatural foes, Zeus, God of Thunder, summons you from the dead as his champion in the fight of good versus evil. Athena, daughter of Zeus, has been imprisoned by the evil Neff, God of the Underworld, and it is your charge to free her from his clutches. To do so, you must battle Neff's henchmen until you reach the ultimate challenge. Zeus has given you one advantage: the ability to capture spirit balls which you can use to transmute into various beast forms. If you succeed, Zeus will be your ally for all time. If you fail, only Neff knows what pain will be your fate!

Directional Pad (D-Pad): Control the direction.

Start Key (Start): Start the game.

Pause and un-pause game.

A Key: Powerful attack in wide area which takes a lot of energy.

B Key: Attack in medium power.

C Key: Jump.

Press UP and C Key to jump higher.

4. Arrow Flash



Things are grim. An evil dragon from another galaxy is rapidly approaching Earth and as a space pilot you realize that it is up to you to stop this threat cold. If you fail, your home will be burnt to a cinder. Your ship provides two distinct modes, each known as an Arrow Flash. Using blast weapons and defensive shield capabilities, your challenge is formidable. Hit the thrusters; you have a date with a dragon in outer space!

Directional Pad (D-Pad): Control the direction.

Start Key (Start): Start the game.

Pause and un-pause game.

A Key: Transform into Planet or Robot mode.

B Key: Shoot.

C Key: Attack enemies with laser while transforming into planet.

Attack enemies with speeding bump while transforms into robot.

5. Bonanza Bros.(Bonanza Brothers)



Mobo and Robo Bonanza are enjoying their favorite television show when the picture crackles and a shadowy figure of a mysterious stranger appears on screen. This figure asks them to collect certain items that he has placed inside various buildings to test his security force. If they return the items successfully, Mobo and Robo will be rewarded. The two of them state that they will get the job done in just three minutes. However, little do they know that each building is packed with security guards who will raise the alarm if they are caught red-handed. Fortunately both Mobo and Robo are equipped with bullets that can knock the guards unconscious for a few seconds. A huge reward will be given out if Mobo and Robo are apprehended. Help the infamous Bonanza Bros. infiltrate a number of different locations ranging from banks to mansions to casinos and don't get caught!

Directional Pad (D-Pad): Control the direction.

Start Key (Start): Start game.

Pause and un-pause game.

A Key: Jump.

B Key: Shoot.

C Key: Jump.

6. Chakan: The Forever Man



Chakan is a demon hunter who had a mission: defeat the Angel of Death in single combat. What he did not realize was that in doing so he would lose his soul! Cursed with life eternal, Chakan realizes that the only way to regain it and rest in peace is to eradicate the Earth of all evil. Fighting through many levels of platform-style action, Chakan will not rest until he has cleansed the Earth and his soul has been regained! Your soul calls out to you; heed its call!

Directional Pad (D-Pad): Control the direction.

Start Key (Start): Start the game.

Pause and un-pause game.

A Key: Negative.

B Key: Attack by Knife.

Long Press this key with D-pad to control knife waving.

C Key: Jump.

Press twice to jump again while jumping.

7. Columns



Addictive and ancient, Columns is the game of a bygone era, originating with Phoenician merchants. Align puzzle pieces to build columns and bring them down. Easy to play, yet challenging to master, this is a game to keep you amused for hours on end. You will quickly understand why this simple puzzler has stood the test of time. Prepare to lose yourself in this game of the ancients.

Directional Pad (D-Pad): Control the direction.

Start Key (Start): Start the game.

Pause and un-pause game.

A Key: Arrange the item.

B Key: Arrange the item.

C Key: Arrange the item.

8. Columns III



Columns III is the final game in the series of fast-moving puzzle classics. As in the other games in the series, match colors of dropping objects in order to remove them from the play field; if they rise to high, the game is over. Columns III adds multiple versions for strategic additions to keep the game fresh and exciting. This is the puzzle game that started it all!

Directional Pad (D-Pad): Control the direction.

Start Key (Start): Start the game.

Pause and un-pause game.

A Key: Attack the competitor for shortening the space.

B Key: Arrange the item.

C Key: Attack the competitor for shortening the space.

9. Comix Zone



In this action thriller, you play the part of Sketch, a highly-respected comic book artist who, by a strange twist of fate, gets sucked into his own comic book creation. Stuck in a familiar world, you must become the hero, fighting against the very villains of your own imagination! If Sketch can first stop one of his evil characters from taking over the world, surely he will be able to find a way out of the real world!

Directional Pad (D-Pad): Control the direction.

Start Key (Start): Start the game.

Pause and un-pause game.

A Key: Attack.

B Key: Jump.

C Key: Defense.

X Key: Use the tool from the left icon in the above.

Y Key: Use the tool from the middle icon in the above.

Z Key: Use the tool from the right icon in the above.

10. Crack Down



When many bombs are discovered throughout a large laboratory, Ben and Andy are called in to dismantle them before the building explodes all around them! Racing from spot to spot, each bomb must be neutralized with smaller charges before time runs out. Defenses have been placed to make it more dangerous, but Ben and Andy have an array of weapons to help them achieve their goals. Better call the bomb squad! Time is short!

Directional Pad (D-Pad): Control the direction.

Start Key (Start): Start the game.

Pause and un-pause game.

A Key: Change bullets.

B Key: Shoot.

Attack with fist if the bullets are ran out.

C Key: Bomb in wide area.

11. Decap Attack



In an odd and colorful world, anything can happen. Max D. Cap, an evil boss, has taken control of this unusual planet and must be stopped. Chuck D. Head, a headless mummy, rises up as the best hope of this strange world and he will stop at nothing to defeat Max and free the planet. Brightly colored lands, unusual foes and powerful and exotic weapons await you as you guide Chuck in his heroic battle in this side scrolling spectacular!

Directional Pad (D-Pad): Control the direction.

Start Key (Start): Start the game.

Pause and un-pause game.

A Key: Open tool items menu.

B Key: Attack.

C Key: Jump.

Press twice while jumping on the air to make hero fly.

12. Ecco



A whirlpool controlled by the evil vortex queen has sucked your entire dolphin pod to imprisonment in the ocean depths. Only you remain to save them. To do so, you must travel through time and space with the help of the Atlantean time machine in order to find your friends. Ecco is a freeform journey, allowing for adventure, exploration, puzzles and combat all along the way. The play style is up to you!

Directional Pad (D-Pad): Control the direction.

Start Key (Start): Start the game.

A Key: Attack by sonar.

B Key: Speeding swim.

C Key: Constantly press to speed swimming.

13. Ecco Jr.



In a somewhat unique experience in the Ecco series, Ecco Jr. provides you with an opportunity to explore the vastness of the ocean and time as Ecco the dolphin's speedy son, Ecco Jr. The young Ecco Jr. enjoys all of the wonders that the sea has to offer until the Vortex Queen returns and kidnaps his father. There is no time to lose when Ecco needs to be saved! Adventure through a lush and beautiful ocean world and explore time itself as you complete fun puzzles and engage in underwater combat to save Ecco. Ecco Jr. may be small, but he packs a punch. Not only that, but he is super fast! Look out Vortex Queen; here comes Jr.!

Directional Pad (D-Pad): Control the direction.

Start Key (Start): Start the game.

A Key: Attack by sonar.

B Key: Attack by sonar.

C Key: Constantly press to speed swimming.

14. ESWAT: City Under Siege



Liberty is a dark, crime ridden metropolis, teaming with criminals who are looking to take advantage of the innocent and the weak. ESWAT places you in the game as a member of the Cyber Police force where it is your job to protect the citizens and stop the criminals. As you advance through this action-shooter, you will gain rank which will open up new weapons and defensive capabilities. If you can arrest the criminal masterminds behind the city's trouble, Liberty may even promote you to chief of the famed ESWAT squad! Look out criminals; ESWAT is on patrol!

Directional Pad (D-Pad): Control the direction.

Start Key (Start): Start the game.

Pause and un-pause game.

A Key: Jump.

B Key: Shoot.

C Key: Jump.

15. Fatal Labyrinth



Many hours of danger and excitement await you in this dungeon crawling favorite! When the Holy Goblet is stolen and taken to Dragonia, the castle of doom, it appears that all hope is lost for the world. As Trykaar, you represent the last hope for mankind against Dragonia's evil inhabitants. Your quest is to search Dragonia's randomly generated levels, battle its minions and retrieve the Holy Goblet. With success comes the eradication of this threat as you acquire the Holy Goblet and return it to its rightful place. Dragonia's victory spells the end of all that is good and holy. You cannot let Dragonia's minions succeed!

Directional Pad (D-Pad): Control the direction.

Start Key (Start): Start the game.

Pause and un-pause game.

A Key: Fasten the game round.

B Key: Cancel the select tool items.

C Key: Open the tool item menu Choose the tool items.

16. Flicky



When the babies wander off, there is only one thing to do: lead them back to the safety of their nest. Flicky the mother blue jay has just such a task. It won't be easy to get the baby chicks back though! Hungry cats are on the prowl and many surprising hazards waiting to be found. Puzzle your way through level after level of cat fighting fun in this family favorite!

Directional Pad (D-Pad): Control the direction.

Start Key (Start): Start the game.

Pause and un-pause game.

A Key: Jump.

B Key: Jump.

C Key: Jump.

17. Gain Ground



Gain Ground is a game of arcade style action and game changing strategy at its finest. Your mission is to save captives and get them to safety, and as the leader of a group of mercenaries, it is up to you to decide which ones to use in each challenge. Every fighter possesses unique abilities that could be the difference life and death. You might even pick up a new fighter along the way, adding to the strategic possibilities and fun!

Directional Pad (D-Pad): Control the direction.

Start Key (Start): Start the game.

Pause and un-pause game.

A Key: Attack.

B Key: Attack.

C Key: Attack.

18. Golden Axe



It is a dark time in the Land of Yuria as the evil Death Adder has invaded, kidnapped the princess and seized the Golden Axe. Devastation alone lays in his wake. Three powerful heroes, each with distinct fighting styles, have emerged in a desperate bid to bring justice to Yuria and free the princess. It will take all of the brawn and magic they can muster just to stand a chance of defeating Death Adder! They vow to save the princess or die trying! The rest is up to you.

Directional Pad (D-Pad): Control the direction.

Start Key (Start): Start game.

Pause and un-pause game.

A Key: Use magic.

B Key: Attack.

C Key: Jump.

***2 player mode is not supported using Ultimate Portable game player (GP2632).**

19. Golden Axe II



Vanquished in Golden Axe I, the Death Adder has been defeated by our heroes. Unfortunately, another evil force, known as the 'Dark Guild', has risen to take his place. With the Golden Axe now in the Dark Guild's possession, our three heroes are once again called in to action to retrieve the Golden Axe for mankind. To meet this new challenge, they must use all of their unique fighting skills and spells to save the land from chaos. Fighting has never been so much fun!

Directional Pad (D-Pad): Control the direction.

Start Key (Start): Start game.

Pause and un-pause game.

A Key: Use magic.

B Key: Attack.

C Key: Jump.

20. Golden Axe III



After a stinging defeat in Golden Axe II, the evil lord Dark Guld has regrouped and has come for revenge! Stealing the powerful Golden Axe, a symbol of peace and prosperity, the Dark Guld wants to see the world revert to chaos. Once again, three warriors including a fierce barbarian, a ferocious Amazon and a fearless dwarf are willing to risk their lives to put a stop to the terror. It's time to start the long journey through enemy-infested territory. Fight onward until you reach the final showdown, a battle with Dark Guld himself!

Directional Pad (D-Pad): Control the direction.

Start Key (Start): Start game.

Pause and un-pause game.

A Key: Use magic.

B Key: Attack.

C Key: Jump.

***2 player mode is not supported using Ultimate Portable game player (GP2632).**

21. Jewel Master

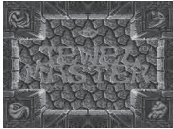

The peaceful kingdom of Mythgard seemed blessed for all time. Then the Demon King, Jardine the Mad, came to power and it seemed that all good was gone forever. Jewel Master, weaver of the Elements, was summoned to possess magical rings of great power and to use these rings to conjure spells with which to defeat the legions of Evil. As the Jewel Master, you must seek out the remaining rings, reclaim the Elemental Blade, and strike down Jardine the Mad. Only by wielding the Elemental Blade can Mythgard be restored to its former glory!

Directional Pad (D-Pad): Control the direction.

Long Press the Up Key for attack upward.

Start Key (Start): Start game.

Pause and un-pause game.

A Key: Select the ring options in the left side.

B Key: Select the ring options in the right side.

C Key: Negative.

22. Kid Chameleon



When his friends get sucked into a virtual reality game and can't escape, it is up to Kid Chameleon to enter the game himself and save the day! Using his ability to change his shape into various other forms, Kid Chameleon must do battle against his foes. Each form adds a special ability which must be used to pass each of the game's stages. With over 100 levels of gameplay, you will find plenty of challenges on your quest. Your friends are depending on you, so it's time to get in the game!

Directional Pad (D-Pad): Control the direction.

Upward key is negative.

Start Key (Start): Start game.

Pause and un-pause game.

A Key: Negative.

B Key: Jump.

C Key: Use accouterment.

23. Mean Bean Machine (Dr. Robotnik's Mean Bean Machine)



The evil Dr. Robotnik has always loved to turn people and other objects into robots. In this Tetris style game he is menacing the unsuspecting citizens of Beanville and threatening to make them his next victims of robot transformation! Create matching color groups to save the Bean's, but watch out for the robots. They will try to stop you dead in your tracks. If you fail to make the match into the Mean Bean Machine you go, and Beanville will surely become robot central!

Directional Pad (D-Pad): Control the direction.

Start Key (Start): Start the game.

Pause and un-pause game.

A Key: Press to arrange the item to right side.

B Key: Press to arrange the item to left side.

C Key: Press to arrange the item to right side.

24. Ristar



Greedy, an evil tyrant, has one goal in mind: control all the planets of the solar system. With only one planet left, Greedy believes he is near the end of his quest. The only holdout from Greedy's relentless onslaught was guarded by a mighty hero. When Greedy managed to capture this protector, Greedy thought his work was done. That was when Ristar, the son of the hero, emerged to stop Greedy, rescue his father and save the solar system. Action and puzzles await in this inter-stellar adventure!

Directional Pad (D-Pad): Control the direction.

Long Press the Up Key for attack upward.

Start Key (Start): Start game.

Pause and un-pause game.

A Key: Jump.

B Key: Grab. Attack.

C Key: Jump.

25. Shadow Dancer



Union Lizard, a vast crime empire, has taken over New York. As Shadow Dancer, a master of martial arts, you must do battle in the name of justice. Using all of your kung-fu skills and the help of your faithful dog, it is up to you to stop the evil Ninja's of Union Lizard once and for all and regain the honor of a slain friend. Once New York is safe, you must fight the mighty Lizard King himself to achieve ultimate victory!

Directional Pad (D-Pad): Control the direction.

Start Key (Start): Start game.

Pause and un-pause game.

A Key: Use the master skill.

B Key: Attack.

Long Press to send dog fighting with competitor.

C Key: Jump.

26. Shinobi III: Return of the Ninja Master



After their utter annihilation in Shinobi II, the Neo Zeed leaders are secretly rebuilding their evil organization. Shinobi senses their powers growing and he knows that it is up to him to stop them again. Neo Zeed's minions have been ordered to stop Shinobi at all costs. The stakes are the high, and as Joe Musashi – Shinobi – you know that unless you succeed, the world will fall into the clutches of Neo Zeed! You must not fail!

Directional Pad (D-Pad): Control the direction.

Start Key (Start): Start game.

Pause and un-pause game.

A Key: Use the master skill.

B Key: Attack.

C Key: Jump.

27. Sonic and Knuckles



Dr. Robotnik is back and he is after the Master Emerald. If he can get his hands on it, he knows that he can fuel his ultimate weapon, the Death Egg, forever. With this power, Dr. Robotnik can destroy the floating island and with it his enemies, Sonic and Knuckles. In order to save the island and themselves, Sonic and Knuckles must find the Master Emerald before Robotnik and his henchmen. Spinning action awaits on the fast paced arcade style adventure!

Directional Pad (D-Pad): Control the direction.

Long Press the Up Key for attack upward.

Start Key (Start): Start game.

Pause and un-pause game.

A Key: Jump.

B Key: Jump.

C Key: Jump.

28. Sonic Spinball



Dr. Eggman (AKA Dr. Robotnik) has taken over Mt. Mobius and turned it into a mechanical base. He is using energy from the magma flowing under the volcano to power his Veg-O-Fortress. He has the power to transform helpless animals into robot slaves. Sonic the Hedgehog and Tails must take down this fortress to free the enslaved animals. The only way to make that happen is to trigger an eruption in the volcano it's built on. Sonic knows this can be done by removing the Chaos Emeralds that keep the volcano stable. Dr. Eggman, however, is also aware of the fragile relationship that exists between the Emeralds and the mountain, and he's set up an elaborate Pinball Defense System to make sure the precious jewels don't go anywhere.

Directional Pad (D-Pad): Control the direction.

Start Key (Start): Start game.

Pause and un-pause game.

A Key: Left Flipper.

B Key: Right Flipper.

C Key: All Flipper.

29. Sonic the Hedgehog



Sonic the Hedgehog is a side scrolling race to save Sonic's animal friends, who have been captured by the evil Dr. Robotnik. Using great speed and a spin attack, Sonic brings plenty of attitude and looping, jumping, super-speed fun. Sonic the Hedgehog is on of the fastest and most entertaining games you can find! Save Sonics friends and special 3-D levels provide an amazing bonus!

Directional Pad (D-Pad): Control the direction.

Start Key (Start): Start game.

Pause and un-pause game.

A Key: Jump.

B Key: Jump.

C Key: Jump.

30. Sonic the Hedgehog 2



Sonic is back and once again he must face the evil Dr. Robotnik and stop his attempt to conquer the world. In order to achieve his goal, Dr. Robotnik captures all of the animals he can find and transforms them into robots to do his bidding. Sonic must defeat Dr. Robotnik and save his friends. The action has never been more fast or furious than this!

Directional Pad (D-Pad): Control the direction.

Start Key (Start): Start game.

Pause and un-pause game.

A Key: Jump.

B Key: Jump.

C Key: Jump.

31. Streets of Rage



This city was once a happy, peaceful place... until one day, a powerful secret criminal organization took over. This vicious syndicate soon had control of the government and even the police force. The city has become a centre of violence and crime where no-one is safe. Amid this turmoil, a group of determined young police officers has sworn to clean up the city. Among them are Adam Hunter, Axel Stone and Blaze Fielding. They decided to put their lives on the line and take back their city through their special hand-to-hand combat abilities. They are willing to risk anything, even their lives, on the Streets of Rage.

Directional Pad (D-Pad): Control the direction.

Start Key (Start): Start game.

Pause and un-pause game.

A Key: Special Attack.

B Key: Attack.

C Key: Jump.

B+C Key: Special Attack.

32. Streets of Rage 2



Just having one peaceful year, the city was returned to its nightmarish state and criminals were once again running rampant. Blaze and Axel found the house of Adam was wrecked and a picture of Adam chained to the wall at the feet of Mr. X. Axel and Blaze team up with Adam's younger brother Eddie 'Skate' Hunter and Axel's friend, professional wrestler Max Thunder to free the city and rescue Adam from the Syndicate.

This time, their weapons were improved, and each of them was given special ability to fight with their best. However, the enemies were also improved with enhanced ability, and more enemies were appearing.

Directional Pad (D-Pad): Control the direction.

Start Key (Start): Start game.

Pause and un-pause game.

A Key: Special Attack.

B Key: Attack.

C Key: Jump.

B+C Key: Special Attack.

D-Pad '←' or '→'+ **A Key:** Special Attack.

33. Streets of Rage 3



The crime boss Mr. X's hires a world-leading robotic researcher at his company RoboCy Corporation to create robots to replace city officials. In the plan Mr. X will run the city using a remote control. His crime company the Syndicates has placed bombs around the city.

Cyborg Gilbert Zan contacts Blaze Fielding with the details of The Syndicate's plan. Blaze forms a task force with Axel Stone and Eddie "Skate" Hunter to bring down The Syndicate once and for all.

Directional Pad (D-Pad): Control the direction.

Start Key (Start): Start game.

Pause and un-pause game.

A Key: Special Attack.

B Key: Attack.

C Key: Jump.

B+C Key : Special Attack.

34. The Ooze



As a scientist you deal with chemicals all day long, but one day, the worst sort of thing happens: your boss creates a compound that turns you into a puddle of thick green goop and you get flushed down the drain! Thankfully you have some newfound abilities that come with your transformation which will help you make your way back to the lab so that you can be restored to humanity. Solve puzzles and fight enemies along the way to prevent your boss from taking over the world!

Directional Pad (D-Pad): Control the direction.

Start Key (Start): Start game.

Pause and un-pause game.

A Key: Attack. Move the body.

B Key: Attack with green balls.

C Key: Negative.

35. Vectorman



In the distant future, all of mans chores are done by thankless robots. When the leader of the robots accidentally has his head replaced with a bomb, he decides that now is the time for the robots to rise up and take control! All the robots are ordered to stop their work and immediately start making weapons for the take-over. The only robot unaffected is the barge pilot Vectorman who was out of range during the switch. Now this pilot is the sole hope of humanity and he sets out to destroy the evil leader known as Warhead! The fate of the planet is at stake!

Directional Pad (D-Pad): Control the direction.

Start Key (Start): Start game.

Pause and un-pause game.

A Key: Attack.

B Key: Attack.

C Key: Jump.

36. Vectorman 2



After the apparent end of the evil plans of Warhead, Vectorman discovers that many of the weapons and the newly built robot army remain. Hidden is dark and secretive locations, they are bent on destruction and will stop at nothing to fulfill their fallen leaders mission. As Vectorman, it is your job to protect humanity! Various robot types and cutting edge weapons stand in your way as you stand between the robots and the fate of the planet itself! This is fast and furious action at its finest!

Directional Pad (D-Pad): Control the direction.

Start Key (Start): Start game.

Pause and un-pause game.

A Key: Attack.

B Key: Attack.

C Key: Jump.

37. Virtua Fighter 2



The call for the greatest fighters in the world has once again been issued! The World Fighting Tournament is back with greater fighters, more special moves and greater numbers of spectacular locations in which to do battle. The champions of the first tournament are back with some new faces as well. You must use all of your skills to survive the challenges that await!

Directional Pad (D-Pad): Control the direction.

Start Key (Start): Start your engine.

Pause and un-pause game.

A Key: Defense.

B Key: Fist.

C Key: Kick.

MORTAL KOMBAT I - III

FATALITY...the hit arcade classics are now available! Scorpion, Sub-Zero and the rest of the legendary Kombat Warriors are ready to FIGHT! Execute bone shattering combos and excruciating finishing moves! Then defeat Goro and Shang Tsung to become the ultimate Mortal Kombat champion.

Mortal Kombat I



Up: Jump

Up Left/Right: Flip forward/back

Left/Right: Walk forward/back

Down: Crouch

A: Low Punch

C: Low Kick

X: High Punch

Z: High Kick

B/Y: Block

Mortal Kombat II



Up: Jump Up

Left/Right: Flip forward/back

Left/Right: Walk forward/back

Down: Crouch

A: Low Punch

B: Low Kick

C: High Kick

X/Y/Z: No function

Mortal Kombat III



Up: Jump Up

Left/Right: Flip forward/back

Left/Right: Walk forward/back

Down: Crouch

A: Low Punch

C: Low Kick

X: High Punch

Z: High Kick

B: Block

Y: No function

MORTAL KOMBAT © 1992-2015 Warner Bros. Entertainment Inc. All other trademarks and copyrights are the property of their respective owners. All rights reserved.



Mortal Kombat, the dragon logo, and all related characters and elements are trademarks of and © Warner Bros. Entertainment Inc. (s15)

MORTAL KOMBAT II © 1993-2015 Warner Bros. Entertainment Inc. All other trademarks and copyrights are the property of their respective owners. All rights reserved.



Mortal Kombat, the dragon logo, and all related characters and elements are trademarks of and © Warner Bros. Entertainment Inc. (s15)

MORTAL KOMBAT 3 © 1995-2015 Warner Bros. Entertainment Inc. All other trademarks and copyrights are the property of their respective owners. All rights reserved.



Mortal Kombat, the dragon logo, and all related characters and elements are trademarks of and © Warner Bros. Entertainment Inc. (s15)

ARCADE GAMES

1. Air Hockey



Use the directional pad to strike the puck toward the goal or to defend your table's side. You can play against the computer using the 1-Player Mode or challenge a friend using 2-Player Mode. Whoever achieves seven goals first is the winner!

Directional Pad (D-Pad): Control the direction up, down, right or left.

A Key: Select the game and game mode.

2. Black Sheep



Take a look at the sheeps; focus on the sheep in the center and by using the direction pad lead the sheep to the direction it is turned to.

Directional Pad (D-Pad): Control the direction

A Key: Play game

B Key: Exit game/back to the game menu

3. Bomber



Blow up your enemies!

But be careful to not explode the items or yourself. Collect cool bomb upgrades that can allow you to drop more than one bomb at a time, or give you a bigger explosion thus allowing you to destroy more blocks and enemies.

Directional Pad (D-Pad):

Control the bomber to move up, down, left or right.

Start Key (Start): Pause the game, press it again to resume.

A Key: Place bombs.

4. Bottle Taps Race



Use your skill to move your little tap through the sand track. On the track selection menu you can see the number of turns and the track length. Use the directional pad to change the direction and press A to confirm.

Press A once again to select the power.

On each round the taps are moved in sequence. Be careful not to run out the track, or your tap will be returned to the spot where it was moved from. The one to complete all the laps first will be the winner.

5. Brain Switch



Use control direction button to indicate if the combination of vowel and even number is correctly shown.

Directional Pad (D-Pad): Control the direction

A Key: Play game

B Key: Exit game/back to the game menu

6. Bulls And Cows



Try to determine the hidden combination. There are no repeat digits. A represents the number of digits that are present and in the right position B represents the number of digits that are present but not in the right position.

Guess the correct combination according to the hints given.

Directional Pad (D-Pad): Control the direction

A Key: Play game/Select

B Key: Exit game/back to the game menu

7. Cannon



Press the A, B or C button to select the angle. Press again to select the power and fire the bullet.

The arrow in the middle of the screen indicates the direction and strength of the wind, pay attention to it because it can influence the trajectory. If you are lucky, maybe there will be no wind to worry about!

You can play against the computer or challenge a friend.

***2 player mode is not supported using Ultimate Portable game player (GP2632).**

8. Checker



The checker game is composed of 1 board and 32 pieces. It is for only one player, and the goal is to leave just one piece on the center of the board.

There are several initial positions for the pieces; the most common one is the one which has all holes occupied except the one in the center. The capture is made by having one piece jump over another. Each time one piece jumps over another; the one that is jumped over is removed from the board. Pieces can only be captures in a straight line, which means, it is not allowed to jump diagonally. The game proceeds until it gets impossible to capture another piece.

To select the piece to be moved or to cancel the selected piece, press A, B or C.

9. Chess



Chess is a game played between two opponents on opposite sides of a board containing 64 squares of alternating colors. Each player has 16 pieces: 1 king, 1 queen, 2 rooks, 2 bishops, 2 knights, and 8 pawns. The goal of the game is to checkmate the other king. Checkmate happens when the king is in a position to be captured (in check) and cannot escape from capture.

Movement of the Pieces

Pawn

The pawn moves differently depending on whether it moves to an empty square or whether it takes a piece of the opponent. When a pawn does not take, it moves one square straight forward. When this pawn has not moved at all, i.e., the pawn is still at the second row (from the owning players view), the pawn may make a double step straight forward. For instance, a white pawn on d2 can be moved to d4. When taking, the pawn goes one square diagonally forward.

Rook

The rook moves in a straight line, horizontally or vertically. The rook may not jump over other pieces, That is: all squares between the square where the rook starts its move and where the rook ends its move must be empty. As for all pieces, when the square where the rook ends his move contains a piece of the opponent, then this piece is taken. The square where the rook ends his move may not contain a piece of the player owning this rook.

Bishop

The bishop moves in a straight diagonal line. Like the rooks, the bishop also may not jump over other pieces.

Knight

The knight makes a move that consists of first one step in a horizontal or vertical direction, and then one step diagonally in an outward direction. The knight jumps: it is allowed that the first square that the knight passes over is occupied by an arbitrary piece.

Queen

The queen has the combined moves of the rook and the bishop, i.e., the queen may move in any straight line, horizontal, vertical, or diagonal.

King

The king moves one square in any direction, horizontally, vertically, or diagonally.

Directional Pad (D-Pad):

Control the direction of the pointing cursor to selected tile.

Start Key (Start): Start the game.

A Key: Take or put a piece.

B Key: Repeat.

C Key: Back to the menu.

10. Color Puzzle



Use control direction button to indicate if the color is matching the meaning.

Directional Pad (D-Pad): Control the direction

A Key: Play game

B Key: Exit game/back to the game menu

11. Cross the Road



In this game, the player needs to control the dogs at the bottom of the screen to cross the busy street within a limited time and arrive at the cabins on the opposite side of the street without being run over. Dogs can jump onto roof of the cars and move with it. Whenever all 3 dogs have arrived in cabins, one level (out of 10) is passed. Each time you pass a level, the speed and quantity of cars is increased. Dog loses a life if it is hit by a car or enters non-vacant cabin. When all of the 4 lives are lost, the game is over.

Directional Pad (D-Pad): Control dog to move left or right.

Start Key (Start): Pause the game, press it again to resume.

A Key: Control dog to jump a step forward.

B Key: Control dog to jump onto the roof of a car.

12. Curling 2010



The player and the computer are positioned at the opposite sides of the table with 5 balls each. Whoever throws all of the 10 balls to the other end first or has fewer balls left when the time is up wins the game, and enters the next round. The player must avoid the balls thrown from the other side. If struck by a ball, he/she will be dazed for a while.

Directional Pad (D-Pad): Move left or right.

Start Key (Start): Pause the game, press it again to resume.

A Key: Throw out a ball.

13. Dominant Color



Within given time, select with direction control button "UP" or "DOWN" to indicate which color more dominates in the given square.

14. Fight or Lose



In this game, the player controls the knight and needs to capture all the pawns. The movement follows the chess rules. The knight moves 2 squares in one direction and 1 square in the other. Every time the horse moves, the pawns move one step forward. If one of the pawns manages to reach the end of the board, the player loses. If all the pawns are captured, the player receives one point and goes to the next level!

15. Firefly Glow



Use the direction buttons select and repeat action showed with wand before. Select with A Key.

Directional Pad (D-Pad): Control the direction
A Key: Play game/Select
B Key: Exit game/back to the game menu

16. Flash Memory



When the numbers are shown, remember their location. Using direction button, indicate the sequence in growing order.

Directional Pad (D-Pad): Control the direction
A Key: Play game/ Select
B Key: Exit game/back to the game menu

17. Formula Challenge

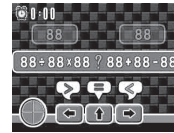

Using direction control button indicate if two given numbers have the same (=), bigger (>) or smaller (<) value. Press A Key to select

Directional Pad (D-Pad): Control the direction
A Key: Play game/Select
B Key: Exit game/back to the game menu

18. Hexagonos



Use the directional pad to move the arrow and A to select the piece you want to move. Use A to select and confirm the movement. Use B or C to cancel the movement. There are 2 things you can do, one is to jump and one is to duplicate. The stone is duplicated when it is moved to a neighboring hexagon. Move your piece next the opponent to make his piece become yours. Whoever has more stones when there is no more possible moves wins.

19. Jack's Pea



Two green platforms are floating in the air (one higher and one lower) and moving from one side to another. The player is always on the lower one and has to jump onto the upper platform when the two platforms are almost overlapping in the vertical direction. When certain amount of jumps is reached, the player enters the next level. Each time a level is passed, the platforms move faster. If the player does not land on any platform, he/she will fall into the abyss and lose a life. When all 3 lives are lost, the game is over.

Directional Pad (D-Pad): Move left or right.
Start Key (Start): Pause the game, press it again to resume.
A Key: Jump up.

20. Jewel Magic



This game is similar to Tetris Worlds. When the game starts, 3 vertical jewels appear on the screen and drop down vertically. The player can control the jewels to land on the appropriate places, and if there are three or more jewels that have the same color and pattern in the horizontal, vertical or diagonal direction, these jewels will blow up and disappear, and the player will be rewarded with the score points. When the score reaches a certain value, the level is passed, and the jewels will start to drop faster. If the piled up jewels reach the top of the screen, the game is over.

Directional Pad (D-Pad): Move the dropping jewels to the left or right.

Start Key (Start): Pause the game, press it again to resume.

Down Key: Make the jewels drop faster.

A Key: Change the stack sequence of the dropping jewels.

21. Logic Dial



Click A Key to rotate the squares and place the number in the right order. Press C Key to retry.

Directional Pad (D-Pad): Control the direction

A Key: Play game/Select

B Key: Exit game/back to the game menu

C Key: Retry

22. Mahjong Solitaire

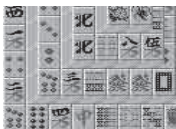

The object of the game is to clear the playing area of tiles by matching pairs of tiles. The player can remove only those matching pairs of tiles where each tile has at least one side (left or right) free and no other tiles placed on top. Matching tile pairs can be removed by clicking on each tile in the pair.

Directional Pad (D-Pad): Move the cursor up, down, left or right.

Start Key (Start): Start the game.

A Key: Select the tile.

C Key: Give up the current game play.

23. Match Eleven



Within given time, select cards of total amount 11. Use control direction button to navigate and choose A Key to select.

Directional Pad (D-Pad): Control the direction

A Key: Play game/Select

B Key: Exit game/back to the game menu

24. Mega Brain Switch

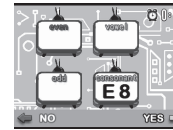

Use control direction button to indicate if the combination of vowel/consonant and even/odd number and is correctly shown.

Directional Pad (D-Pad): Control the direction

A Key: Play game

B Key: Exit game/back to the game menu

25. Memory

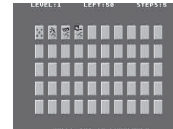

Move the pointing cursor to a face-down tile, and press A key to flip it over. When 2 identical tiles are opened they will be removed from the board. The game is finished when all pairs of tiles have been removed from the board.

4 levels can be selected at the beginning. 4, 6 or 8 tiles can be opened at one time in different levels. Fewer tiles can be opened in higher levels.

Sample screenshot:

LEVEL: 1 (LEVEL 1)

LEFT: 50 (Total tiles to be cleared)

STEPS: 5 (moves made already)

Directional Pad (D-Pad):

Control the direction of the pointing cursor to the tiles up, down, left or right.

A Key: Press to start the game.

Press to confirm the tile selection.

C Key: Give up the current game play

26. Memory Match



Pay attention to the figure shown in the middle, remember it and use the direction "Right" and "Left" buttons to indicate "Match" or "Not Match" of the figure shown in the middle before.

Directional Pad (D-Pad): Control the direction

A Key: Play game

B Key: Exit game/back to the game menu

27. Mirror Mirror



Indicate the hidden letters into the square using direction button and comparing the square besides. Press A to select the pane.

Figure out where letters are turned inverse (green rows) and find the right requested match.

Directional Pad (D-Pad): Control the direction

A Key: Play game/Select

B Key: Exit game/back to the game menu

28. Mr. Balls



Mr. Balls and his brothers got caught in a mysterious machine! Your mission is to free all of them. The problem is that the machine has a strange rule. When you release or lock one of them, those which are at the left, right, above and below switch their state; that is; if they were unlocked they become locked, if they were locked they become unlocked.

There are many levels to be solved, including one which is random. To lock or unlock just press A, B or C when the cursor is on the chosen cell.

29. Naval Power



Command your squad in a life or death battle! Use the directional pad to select your target and press A, B or C to fire. Sink all of the opponent's ships to win.

30. Panic Lift



Help the customers to get to the right floor by selecting A Key when the correct floor is reached.

Directional Pad (D-Pad): Control the direction

A Key: Play game/Select

B Key: Exit game/back to the game menu

31. Reaction Match



Pay attention to the image shown and use the direction "Right" and "Left" buttons to indicate "Match" or "Not Match" of the image shown previously.

Directional Pad (D-Pad): Control the direction

A Key: Play game

B Key: Exit game/back to the game menu

32. Snake



Score points and pass levels by having the snake eat magic berries in the playing area while avoiding snakes tale and the walls. Each time the snake eats a piece of food, its tail grows longer. The level is completed when all the items are collected.

Directional Pad (D-Pad): Control the direction of the snake's head up, down, left, or right.
Select the level of the game.

A Key: Press to start the game.

33. Space Hunter



Pay attention to show UFO ships and remember numbers on the screen. Use direction pad to move arrow and indicate UFO ships shown before and use the calculation skills to complete the formula on the screen shown afterwards. To select use A Key.

Directional Pad (D-Pad): Control the direction

A Key: Play game/Select

B Key: Exit game/back to the game menu

34. Sparkling Truffle



Use the direction buttons to repeat action shown before.

Directional Pad (D-Pad): Control the direction

A Key: Play game

B Key: Exit game/back to the game menu

35. Spider

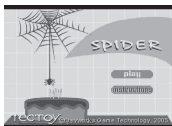

You must protect your cake from the arachnid invasion! You have a pesticide which will help you keep the spiders away from the cake. Aim by using the directional pad and fire with A or B or C.

36. Sudoku Quiz

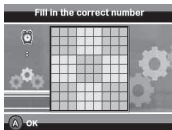

Save the puzzle by filling all the blank squares in a game with the correct numbers:

Every row of 9 numbers must include all digits 1 through 9 in any order. Every column of 9 numbers must include all digits 1 through 9 in any order. Every 3 by 3 subsection of the 9 by 9 square must include all digits 1 through 9.

Directional Pad (D-Pad): Control the direction

A Key: Play game/Select

B Key: Exit game/back to the game menu

37. Table Magic



Follow the treasure boxes and find the hidden gold by using direction button and select with A Key.

Directional Pad (D-Pad): Control the direction

A Key: Play game/ Select

B Key: Exit game/back to the game menu

38. Treasure Hunt



Use the direction buttons to navigate the ship to the treasures.

Directional Pad (D-Pad): Control the direction

A Key: Play game

B Key: Exit game/back to the game menu

39. Warehouse Keeper



The goal of this game is to place all boxes with goods onto their designated spots in a warehouse. The player should push boxes to the spots marked with crosses. Only one box at a time can be moved and it cannot be pulled. Push boxes to right places to win a stage.

Directional Pad (D-Pad): Control the moving direction and push boxes up, down, left or right.

Start Key (Start): Start the game.

A Key: Enter the game.

Press to mark current stage as completed.

Press again to enter next stage.

B Key: Press to mark current stage as failed.

Press again to restart current stage.

40. Whack A Wolf



Use direction pad to Hit the wolf.

Directional Pad (D-Pad): Control the direction

A Key: Play game

B Key: Exit game/back to the game menu