

PHONIC

AM440 AM440D Compact Mixers

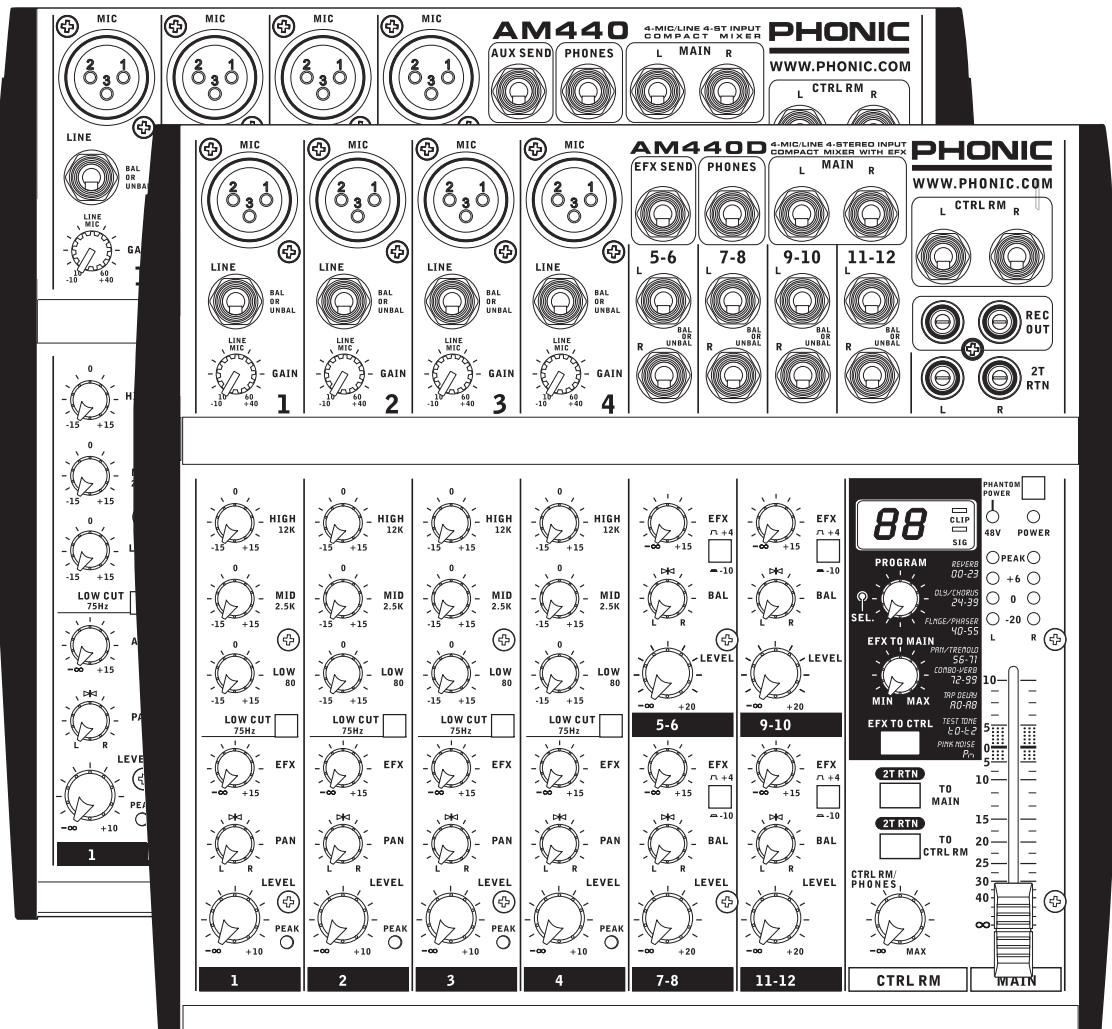

ENGLISH

User's Manual



IMPORTANT SAFETY INSTRUCTIONS

The apparatus shall not be exposed to dripping or splashing and that no objects filled with liquids, such as vases, shall be placed on the apparatus. The MAINS plug is used as the disconnect device, the disconnect device shall remain readily operable.

Warning: the user shall not place this apparatus in the confined area during the operation so that the mains switch can be easily accessible.

1. Read these instructions before operating this apparatus.
2. Keep these instructions for future reference.
3. Heed all warnings to ensure safe operation.
4. Follow all instructions provided in this document.
5. Do not use this apparatus near water or in locations where condensation may occur.
6. Clean only with dry cloth. Do not use aerosol or liquid cleaners. Unplug this apparatus before cleaning.
7. Do not block any of the ventilation openings. Install in accordance with the manufacturer's instructions.
8. Do not install near any heat sources such as radiators, heat registers, stoves, or other apparatus (including amplifiers) that produce heat.
9. Do not defeat the safety purpose of the polarized or grounding-type plug. A polarized plug has two blades with one wider than the other. A grounding type plug has two blades and a third grounding prong. The wide blade or the third prong is provided for your safety. If the provided plug does not fit into your outlet, consult an electrician for replacement of the obsolete outlet.
10. Protect the power cord from being walked on or pinched particularly at plug, convenience receptacles, and the point where they exit from the apparatus.
11. Only use attachments/accessories specified by the manufacturer.
12. Use only with a cart, stand, tripod, bracket, or table specified by the manufacturer, or sold with the apparatus. When a cart is used, use caution when moving the cart/apparatus combination to avoid injury from tip-over.
13. Unplug this apparatus during lightning storms or when unused for long periods of time.
14. Refer all servicing to qualified service personnel. Servicing is required when the apparatus has been damaged in any way, such as power-supply cord or plug is damaged, liquid has been spilled or objects have fallen into the apparatus, the apparatus has been exposed to rain or moisture, does not operate normally, or has been dropped.



	CAUTION RISK OF ELECTRIC SHOCK DO NOT OPEN	
CAUTION: TO REDUCE THE RISK OF ELECTRIC SHOCK, DO NOT REMOVE COVER (OR BACK) NO USER SERVICEABLE PARTS INSIDE REFER SERVICING TO QUALIFIED PERSONNEL		



The lightning flash with arrowhead symbol, within an equilateral triangle, is intended to alert the user to the presence of uninsulated "dangerous voltage" within the product's enclosure that may be of sufficient magnitude to constitute a risk of electric shock to persons.



The exclamation point within an equilateral triangle is intended to alert the user to the presence of important operating and maintenance (servicing) instructions in the literature accompanying the appliance.

WARNING: To reduce the risk of fire or electric shock, do not expose this apparatus to rain or moisture.

CAUTION: Use of controls or adjustments or performance of procedures other than those specified may result in hazardous radiation exposure.

AM440/440D

Compact Mixers

USER'S MANUAL

CONTENTS

INTRODUCTION	4
FEATURES.....	4
GETTING STARTED	5
CHANNEL SETUP	5
MAKING CONNECTIONS.....	6
CONTROLS AND SETTINGS	8
APPLICATION	12
DIMENSIONS.....	13
DIGITAL EFFECT TABLE.....	14
SPECIFICATIONS.....	15
BLOCK DIAGRAMS	17

INTRODUCTION

Thank you for choosing one of Phonic's many quality compact mixers. The AM440 and AM440D Compact Mixers – designed by the ingenious engineers that have created a variety of mixers fantastic in style and performance in the past – displays similar proficiency that previous Phonic products have shown; with more than a few refinements, of course. The AM series features full gain ranges, amazingly low distortion levels, and incredibly wide dynamic ranges, just showing the dominance these small machines will have in the mixing World.

We know how eager you are to get started – wanting to get the mixer out and hook it all up is probably your number one priority right now – but before you do, we strongly urge you to take a look through this manual. Inside, you will find important facts and figures on the set up, use and applications of your brand new mixer. If you do happen to be one of the many people who flatly refuse to read user manuals, then we just urge you to at least glance at the Instant Setup section. After glancing at or reading through the manual (we applaud you if you do read the entire manual), please store it in a place that is easy for you to find, because chances are there's something you missed the first time around.

FEATURES

Common Features :

- Audiophile-Quality & ultra low noise
- 4 mono mic/line channels
- 4 stereo channels
- AUX/EFX sends on each channel
- 75Hz low-cut filter on mono channel
- 3-band EQ on each channel
- +48V phantom power on mic channels
- Control room/Phones source matrix for maximum monitor flexibility
- EFX/AUX send cue for monitoring individual channel
- Balanced TRS outputs
- Optional rack-mounting kit

AM440D plus :

- 32/40-bit DSP with 100 EFX + tap-delay and test tones
- Separate EFX route control

GETTING STARTED

1. Ensure all power is turned off on your mixer. To totally ensure this, the power supply should not be connected to the unit.
2. All faders and level controls should be set at the lowest level and all channels switched off to ensure no sound is inadvertently sent through the outputs when the device is switched on. All levels can be altered to acceptable degrees after the device is turned on using the channel setup instructions.
3. Plug any necessary equipment into the device's various outputs. This could include amplifiers and speakers, monitors, signal processors, and/or recording devices.
4. Plug the supplied power cable into the inlet on the back of the device and then into a power outlet of a suitable voltage.
5. Turn the power switch on and follow the channel setup instructions to get the most out of your equipment.

CHANNEL SETUP

1. To ensure the correct audio level of the input channel is selected, each of the level input controls of the Mixer should be turned counterclockwise or down as far as they will go.
2. No input other than the one being set should have any device plugged in. This will ensure the purest signal is used when setting channels.
3. Set the level control of the channel you are setting to the 0 dB mark.
4. Ensure the channel has a signal sent to it similar to the signal that will be sent when in common use. For example, if the channel is using a microphone, then you should speak or sing at the same level the performer normally would during a performance; if a guitar is plugged into the channel, then the guitar should also be strummed as it normally would be (and so on). This ensures levels are completely accurate and avoids having to reset them later.
5. Set the gain so the Level Meter indicates the audio level is around 0 dB.
6. This channel is now ready to be used; you can stop making the audio signal.
7. You can repeat the same process for other channels. Or not, it's your call.

MAKING CONNECTIONS

Inputs and Outputs

1. XLR Microphone Jacks

These jacks accept typical 3-pin XLR inputs for balanced and unbalanced signals. They can be used in conjunction with microphones – such as professional condenser, dynamic or ribbon microphones – with standard XLR male connectors, and feature low noise preamplifiers, serving for crystal clear sound replication. The AM440 and AM440D mixers feature four standard XLR microphone inputs for your convenience.

NB. When these inputs are used with condenser microphones, the Phantom Power should be activated. However, when Phantom Power button is engaged, single ended (unbalanced) microphones and instruments should not be used on the Mic inputs.

2. Line Inputs

This input accepts typical 1/4" TRS or TS inputs, for balanced or unbalanced signals. There are various numbers of these inputs depending which mixer you are using. They can be used in conjunction with various line level devices, such as keyboards, drum machines, electric guitars, and a variety of other electric instruments.

3. Stereo Channels

The AM440 and AM440D mixer feature a few stereo channels, thrown in for maximum flexibility. Each of these stereo channels features two 1/4" TRS phone jacks, for the addition of various line level input devices, such as electronic keyboards, guitars and external signal processors or mixers. These Stereo Channels can also be used as Mono channels, where the signal from any 1/4" phone jack plugged into the Left stereo input will cause the signal to be duplicated to the Right input due to the miracle of jack normalizing. This does not work in reverse, however.

4. AUX / Effects Send

These 1/4" TS outputs may be used to connect to an external digital effect processor, or even to an amplifier and speakers (depending on your desired settings), to the mixer. The signal sent from these outputs is fed from the AUX send control on the AM440 and the Digital Effect Processor on the AM440D.

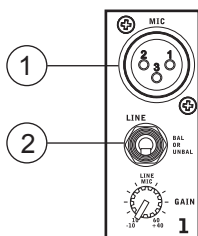

5. Phones

This stereo output port is suited for use with headphones, allowing monitoring of the mix. The audio level of this output is controlled using the Phones / Submix control.

6. Main L and R Outputs

These two ports will output the final stereo balanced line level signal sent from the main mixing bus. The primary purpose of these jacks is to send the main output to external devices, which may include power amplifiers (and in-turn, a pair of speakers), other mixers, as well as a wide range of other possible signal processors (Equalizers, Crossovers, etcetera).

7. Control Room Outputs

These two 1/4" Phone Jack outputs feed the signal altered by the Control Room/Phones level control on the face of the mixer. This output has extensive use, as it can be used to feed the signal from the mixer to an active monitor, for the monitoring of the audio signal from within a booth, among other possible uses.

8. Record Out

These outputs will accommodate RCA cables, able to be fed to a variety of recording devices. such as MD players, and even laptop computers, ensuring total control over recording quality.

9. 2T Return

These RCA stereo inputs are used to connect the mixer with external devices, such as tape and CD players, or even Laptop computers, receiving a signal from another source and feeding it to the Main L-R mixing bus.

Rear Panel

10. Power Connector

This port is for the addition of a power cable and supply, allowing power to be supplied to the mixer. Please use the power adaptor that is included with this mixer only.

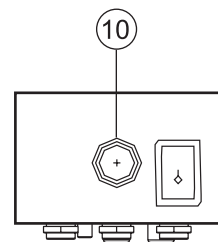
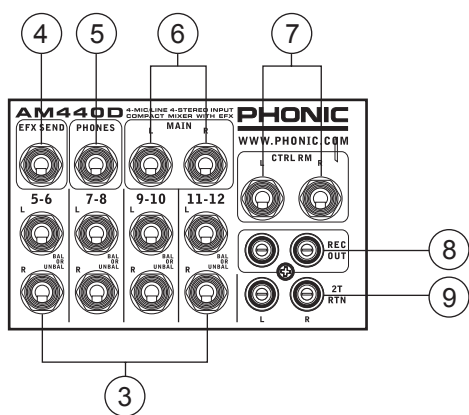

CONTROLS AND SETTINGS

Rear Panel

11 Power Switch

This switch is used to turn the mixer on and off. Ensure you turn all level controls down before activating.

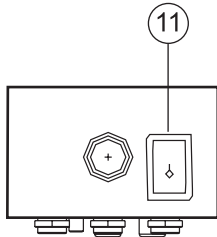

Channel Controls

12. Line/Mic Gain Control

This controls the sensitivity of the input signal of the Line/Microphone input. The gain should be adjusted to a level that allows the maximum use of the audio, while still maintaining the quality of the feed. This can be accomplished by adjusting it to a level that will allow the peak indicator occasionally illuminate. All 4 mono channels feature this control.

13. High Frequency Control

This control is used to give a shelving boost or cut of ± 15 dB to high frequency (12 kHz) sounds. This will adjust the amount of treble included in the audio of the channel, adding strength and crispness to sounds such as guitars, cymbals, and synthesizers.

14. Middle Frequency Control

This control is used to provide a peaking style of boost and cut to the level of middle frequency (2.5 kHz) sounds at a range of ± 15 dB. Changing middle frequencies of an audio feed can be rather difficult when used in a professional audio mix, as it is usually more desirable to cut middle frequency sounds rather than boost them, thereby soothing overly harsh vocal and instrument sounds in the audio.

15. Low Frequency Control

This control is used to give a shelving boost or cut of ± 15 dB to low frequency (80 Hz) sounds. This will adjust the amount of bass included in the audio of the channel, and bring more warmth and punch to drums and bass guitars.

16. Low Cut Filter (75 Hz)

This button, located on channels 1 through to 4, will activate a low-cut / high-pass filter that reduces all frequencies below 75 Hz at 18 dB per Octave, helping to remove any unwanted ground noise or stage rumble.

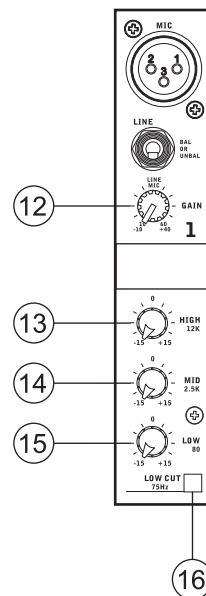

17. AUX / EFX Control

The AUX control on the AM440 allows the user to send the corresponding signal to the AUX mixing bus, the final level of which is controlled by the AUX Send control on the main mixing panel. This signal is then sent to the AUX Send output, which can be used in conjunction with an amplifier and studio or stage monitors, or simply as an auxiliary output for any means required. The EFX control on the AM440D alters the signal level that is sent to the EFX mixing bus, which makes its way to the built-in Digital Effects Processor and is in-turn sent through the EFX send output. These controls are pre-fader, therefore any changes made to the corresponding channel level control are not applied to the AUX or EFX signals.

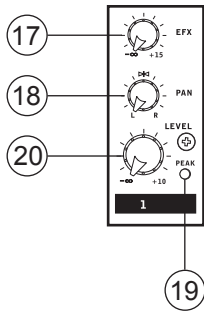

18. Pan / Balance Controls

This alternates the degree or level of audio that the left and right side of the main mix should receive. On mono channels, this control will adjust the level that the left and right should receive (pan), where as on a stereo channel, adjusting the BAL control will increase the left or right audio signals accordingly (balance).

19. Peak Indicator

This LED indicator will illuminate when the device hits high peaks, 6 dB before overload occurs. It is best to adjust the gain of the channel so that the PEAK indicator lights up on intervals only, if at all. This will ensure a greater dynamic range of audio.

20. Level Control

This rotary control will alter the signal level that is sent from the corresponding channel to the main mixing bus.

21. +4 / -10 Switch

This button, located on all stereo channels, is used adjust the input sensitivity of the corresponding channels, which will adapt the AM440 or AM440D to external devices which may use different operating levels. If the input source is -10 dBV (consumer audio level), it is best to engage the switch, allowing the signal to be heard. The +4 dBu level is suitable for Professional Audio signals, which are considerably higher than the consumer level. However, if you are unsure of the source's operating level, we suggest leaving the switch disengaged until you test the source's signal. You can then engage if necessary (if the level of the input signal is obviously too low).

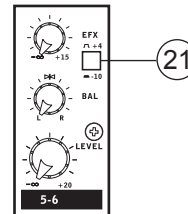

Digital Effect Section (AM440D only)

22. Digital Effect Display

This 2-digit numeric display shows the program number that is currently applied to your EFX audio signal. When you rotate the Program control, you can scroll through different program numbers; however the display will revert back to the original program if a new program is not selected within a few seconds. For a list of available effects, please observe the Digital Effect Table.

23. Sig and Clip Indicators

Located within the Digital Effect Display are Clip and Sig LEDs. The Sig LED will light up when any signal is received by the effect processor, and the Clip LED will light up shortly before excessive signals are dynamically clipped. If the Clip LED lights up too often, it may be advisable to turn down one or all EFX controls on input channels to ensure the signal level is not too high.

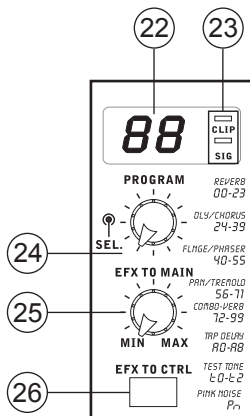

24. Program Control

This control is used to scroll through the various effects. Turning the control clockwise will allow users to ascend into higher program numbers, and turning it counter-clockwise will allow users to descend into lower program numbers. Pushing this control will apply the new effect. When a tap-delay effect is selected, pressing this control will allow users to select the tap-delay time.

By pushing the button several times, the effect processor interprets the time between last two pushes and remembers this as the delay time, until the button is pushed again (this is kept, even after the power is turned off). When the tap delay effect is selected, a small LED will flash within the digital effect display window at the selected intervals.

25. EFX "to Main" Control

This will adjust the level of the Digital Effect signal that will be sent to the Main left and right mixing bus to be applied to your main feed.

26. EFX "to Ctrl" Button

This button is pushed to allow the signal from the Digital Effect processor to be sent to the Control Room outputs for monitoring purposes.

Master Section

27. Phantom Power Switch

When this switch is in the on position, it activates +48V of phantom power for all microphone inputs, allowing condenser microphones (well, the ones that don't use batteries) to be used on these channels. Activating Phantom Power will be accompanied by an illuminated LED above the left channel Level Meter. Before turning Phantom Power on, turn all level controls to a minimum to avoid the possibility of a ghastly popping sound from the speakers.

NB. Phantom Power should be used in conjunction with balanced microphones. When Phantom Power is engaged, single ended (unbalanced) microphones and instruments should not be used on the Mic inputs. Phantom Power will not cause damage to most dynamic microphones, however if unsure, the microphone's user manual should be consulted.

28. AUX Send Control (AM440 only)

This control adjusts the final level of the AUX mixing bus (as taken from the AUX controls on each channel strip), the audio of which is sent to the AUX Send output (and sent to the Control Room/Phones output when the AUX to Ctrl button is engaged).

29. 2T Return Routing Buttons

These two buttons allow users to decide the destination of the signal received by the RCA 2T Return inputs. The "to Main" button sends the signal to the main mix, whereas the "to Ctrl Rm" sends the signal to the Control Room mixing bus for monitoring.

30. AUX "to Ctrl" Button (AM440 only)

When this button is activated, the AUX send signal (the level of which is decided by the AUX send control) will be sent to the Control Room mixing bus for monitoring purposes.

31. Ctrl Rm / Phones Control

This control is used to adjust the audio level of the Control Room feed, which is sent to both the Control Room outputs (for monitoring, acting as side fill or other purposes) and Phones outputs (to be used in conjunction with headphones for monitoring).

32. Main L-R Control

This 60mm fader is final level control for the main left and right audio feed, sent to the Main L and R outputs.

33. Level Meter

The AM's stereo 4-segment level meter gives an accurate indication of when audio levels of the MAIN L/R output reach certain levels. It is suggested for the maximum use of audio to set the various levels controls to a level slightly below that which would cause the Peak LED to light up. This will help you get the most out of your audio without causing any distortion.

34. +48 Indicator

The +48 Indicator illuminates whenever the Phantom Power is activated.

35. Power Indicator

The Power Indicator will light up when the power of the mixer is on.

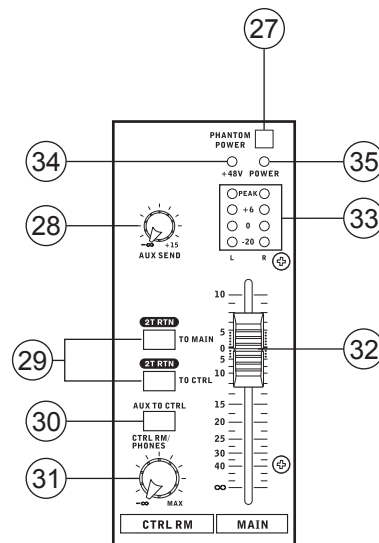

APPLICATION

There are potentially hundreds of ways to connect instruments and devices to the AM Mixers. It is advisable that you explore the functions and find the best setup possible for your needs, which may depend on what instruments you wish to connect, as well as how many external devices you wish to connect and your required monitoring applications. Combining the use of different instruments with the mixer's special functions (such as digital effect processing, in the case of the AM440D) will ensure that your audio sounds exactly the way you want it.

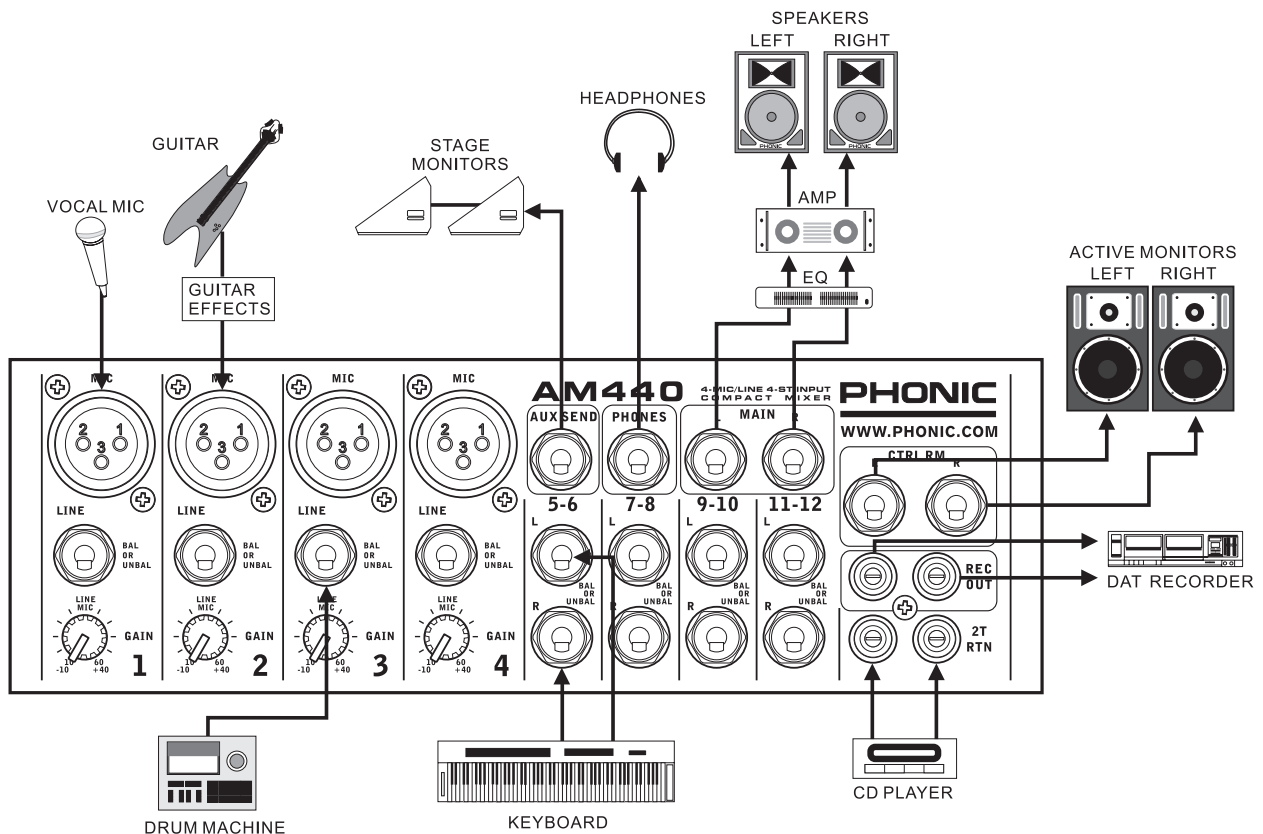

DIMENSIONS

Both the AM440 and AM440D share the same dimensions.

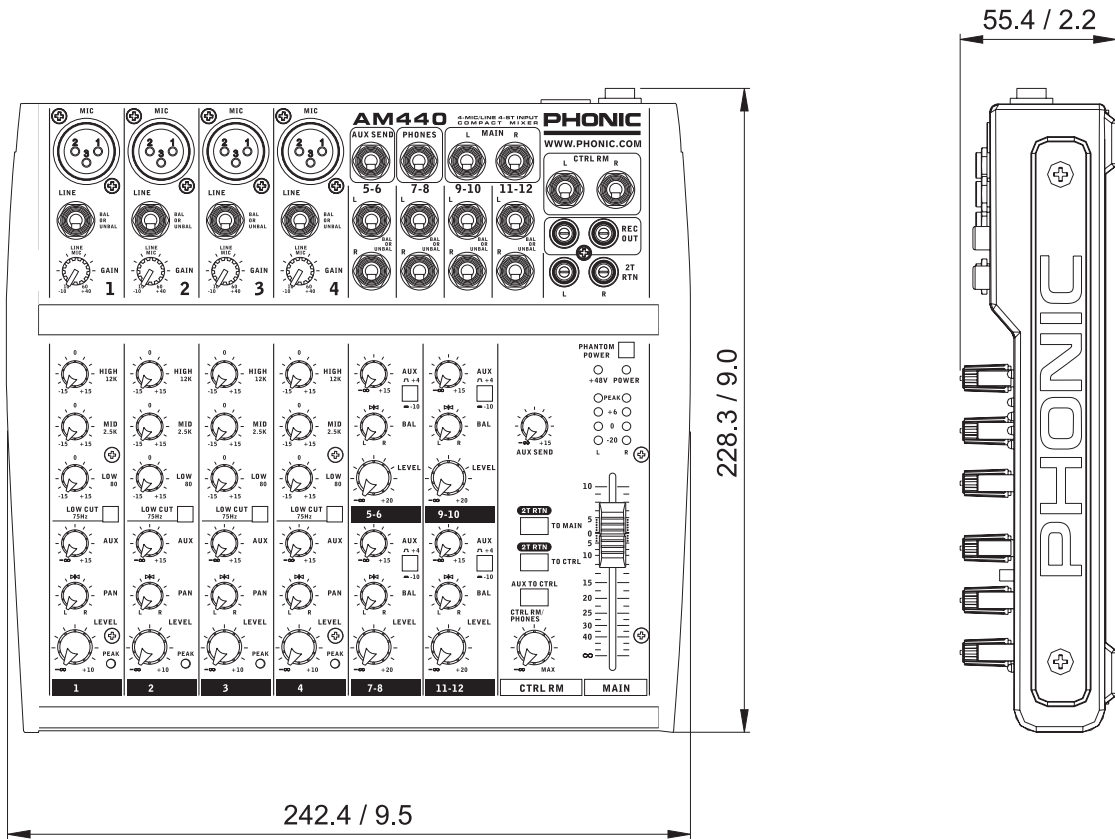
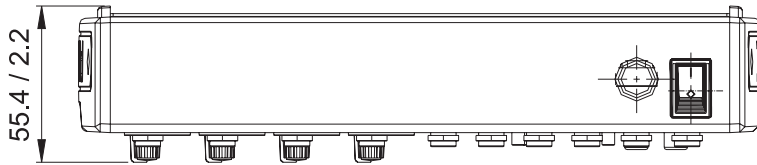

* All measurements are shown in mm/inches.

DIGITAL EFFECT TABLE

NO	PROGRAM NAME	PARAMETER SETTING	
	ROOM	REV-TIME	EARLY LEVEL
01	COMPACT ROOM 1	0.05	100
02	COMPACT ROOM 2	0.4	0
03	SMALL ROOM 1	0.45	100
04	SMALL ROOM 2	0.6	90
05	MID ROOM 1	0.9	100
06	MID ROOM 2	1	50
07	BIG ROOM 1	1.2	100
08	TUNNEL	3.85	100
	HALL	REV-TIME	EARLY LEVEL
09	JAZZ CLUB	0.9	90
10	SMALL HALL 1	1.5	72
11	SMALL HALL 2	1.75	85
12	SPRING HALL	1.9	98
13	MID HALL 1	2.3	100
14	MID HALL 2	2.45	80
15	RECITAL HALL	2.7	96
16	BIG HALL 2	3.3	88
	PLATE	REV-TIME	HPF
17	SMALL PLATE	0.9	0
18	TAIL PLATE	1.2	20
19	MID PLATE 1	1.3	0
20	MID PLATE 2	2.2	0
21	REVERSE PLATE	2.25	42
22	LONG PLATE 1	2.6	80
23	LONG PLATE 2	3	625
24	LONG PLATE 3	4.2	0
	DELAY-1(stereo)	DELAY AVERG.	R-LEVEL
25	SHORT DELAY 1	0.07	60
26	SHORT DELAY 2	0.14	60
27	PING PONG DELAY	0.11	55
28	MID DELAY 1	0.15	55
29	MID DELAY 1	0.3	60
30	SHORT DELAY 1 (MONO)	0.06	100
31	MID DELAY 1 (MONO)	0.13	100
32	LONG DELAY 1 (MONO)	0.18	100
	CHORUS	LFO	DEPTH
33	SOFT CHORUS	0.2	56
34	SOFT CHORUS 2	0.5	70
35	SOFT CHORUS 3	0.8	75
36	WARM CHORUS	1.8	85
37	WARMER CHORUS 1	3.2	80
38	WARMER CHORUS 2	5.2	45
39	WARMER CHORUS 3	7.8	52
40	HEAVY CHORUS	9.6	48
	FLANGER	LFO	DEPTH
41	CLASSIC FLANGER 1	0.1	44
42	CLASSIC FLANGER 2	0.3	63
43	GENTLE FLANGER	0.6	45
44	WARM FLANGER	1.6	60
45	MODERN FALANGER 1	2	85
46	MODERN FALANGER 2	2.8	80
47	DEEP FALANGER 1	4.6	75
48	DEEP FALANGER 2	10	60
	PHASER	LFO	DELAY
49	CLASSIC PHASER 1	0.1	3.6
50	CLASSIC PHASER 2	0.4	2.6
51	COOL PHASER	1.4	0.7
52	WARM PHASER	3.2	0.3
53	HEAVY PHASER 1	5	1.2
54	HEAVY PHASER 2	6	2.8
55	WILD PHASER 1	7.4	0.8
56	WILD PHASER 2	9.6	4.8

NO	PROGRAM NAME	PARAMETER SETTING	
	PAN	SPEED	TYPE
57	SLOW PAN	0.1	R->L
58	SLOW PAN 1	0.1	R<->L
59	SLOW PAN 2	0.4	R->L
60	MID SHIFT	0.8	R<->L
61	MID SHIFT 1	1.2	L->R
62	MID SHIFT 2	1.8	L->R
63	MID SHIFT 3	1.8	R->L
64	FAST MOVE	3.4	R<->L
	TREMOLO	SPEED	MODE-TYPE
65	LAZY TREMOLO	0.8	TRG
66	VINTAGE TREMOLO	1.5	TRG
67	WARM TREMOLO	2.8	TRG
68	WARM TREMOLO 1	4.6	TRG
69	HOT TREMOLO	6.8	TRG
70	HOT TREMOLO 1	9.6	TRG
71	CRAZY TREMOLO 1	15	TRG
72	CRAZY TREMOLO 2	20	TRG
	DELAY+REV	REV	DELAY-1
73	DELAY+REV 1	1	1
74	DELAY+REV 2	2	2
75	DELAY+REV 3	3	3
76	DELAY+REV 4	4	4
77	DELAY+REV 5	5	5
78	DELAY+REV 6	6	6
79	DELAY+REV 7	7	7
80	DELAY+REV 8	8	8
	CHORUS+REV	REV	CHORUS
81	CHORUS+REV 1	1	1
82	CHORUS+REV 2	2	2
83	CHORUS+REV 3	3	3
84	CHORUS+REV 4	4	4
85	CHORUS+REV 5	5	5
86	CHORUS+REV 6	6	6
87	CHORUS+REV 7	7	7
88	CHORUS+REV 8	8	8
	FLANGER+REV	REV	FLANGER
89	FLANGER+REV 1	1	1
90	FLANGER+REV 2	2	2
91	FLANGER+REV 3	3	3
92	FLANGER+REV 4	4	4
93	FLANGER+REV 5	5	5
94	FLANGER+REV 6	6	6
95	FLANGER+REV 7	7	7
96	FLANGER+REV 8	8	8
	GATED-REV	RELEASE	REV
97	GATED-REV-1 9	0.02	TAIL PLATE
98	GATED-REV-2 10	0.2	TAIL PLATE
99	GATED-REV-1 9	0.02	REVERSE PLATE
100	GATED-REV-2 10	0.5	REVERSE PLATE
	TAP DELAY	FB LEVEL	RANGE
A0	TAP DELAY	0	100mS - 2.7S
A1	TAP DELAY	10	100mS - 2.7S
A2	TAP DELAY	20	100mS - 2.7S
A3	TAP DELAY	30	100mS - 2.7S
A4	TAP DELAY	40	100mS - 2.7S
A5	TAP DELAY	50	100mS - 2.7S
A6	TAP DELAY	60	100mS - 2.7S
A7	TAP DELAY	70	100mS - 2.7S
A8	TAP DELAY	80	100mS - 2.7S
	TEST TONE	FREQUENCY	SHAPE
T0	LOW FREQUENCY	100Hz	SINEWAVE
T1	MID FREQUENCY	1kHz	SINEWAVE
T2	HIGH FREQUENCY	10kHz	SINEWAVE
PN	PINK NOISE	20Hz~20kHz	

SPECIFICATIONS

Model Name	AM 440	AM 440D
Inputs		
Total Channels	8	8
Balanced Mono Mic / Line Channel	4	4
Balanced Stereo Line Channel	4	4
2T Input	Stereo RCA	Stereo RCA
Outputs		
Main L/R Stereo	2 x 1/4" TRS, Bal.	2 x 1/4" TRS, Bal.
Alt 3-4	N/A	2 x 1/4" TRS, Bal.
Rec Out	Stereo RCA	Stereo RCA
CTRL RM L/R	2 x 1/4" TS	2 x 1/4" TS
Phones	1	1
Channel Strips		
Efx Send	1	2
Pan/Balance Control	Yes	Yes
Volume Controls	Rotary	Rotary
Inserts	N/A	4
Master Section		
Phones Level Control	Yes	Yes
Main L/R Level Control	Main L/R, 60mm fader	Main L/R, 60mm fader
Level Meter	2 x 4-segment	2 x 4-segment
Phantom Power Supply		
	+48VDC	+48VDC
Frequency Response (Mic input to any output)		
20Hz ~ 60KHz	+0/-1 dB	+0/-1 dB
20Hz ~ 100KHz	+0/-3 dB	+0/-3 dB
Crosstalk (1KHz @ 0dBu, 20Hz to 20KHz bandwidth, channel in to main L/R outputs)		
Channel fader down, other channels at unity	<-90 dB	<-90 dB
Noise (20Hz~20KHz; measured at main output, Channels 1-4 unit gain; EQ flat; all channels on main mix; channels 1/3 as far left as possible, channels 2/4 as far right as possible. Reference=+6dBu)		
Master @ unity, channel fader down	-86.5 dBu	-86.5 dBu
Master @ unity, channel fader @ unity	-84 dBu	-84 dBu
S/N ratio, ref to +4	>90 dB	>90 dB

Model Name	AM 440	AM 440D
Microphone Preamp E.I.N. (150 ohms terminated, max gain)	<-129.5 dBm	<-129.5 dBm
THD (Any output, 1KHz @ +14dBu, 20Hz to 20KHz, channel inputs)	<0.005%	<0.005%
CMRR (1 KHz @ -60dBu, Gain at maximum)	80 dB	80 dB
Maximum Level		
Mic Preamp Input	+10 dBu	+10 dBu
All Other Input	+22 dBu	+22 dBu
Balanced Output	+28 dBu	+28 dBu
Impedance		
Mic Preamp Input	2 K ohms	2 K ohms
All Other Input (except insert)	10 K ohms	10 K ohms
RCA 2T Output	1.1 K ohms	1.1 K ohms
Equalization	3-band, +/-15 dB	3-band, +/-15 dB
Low EQ	80 Hz	80 Hz
Mid EQ	2.5 KHz	2.5 KHz
Hi EQ	12 KHz	12 KHz
Low Cut Filter	75Hz (-18dB/oct)	75Hz (-18dB/oct)
Effect Processor	N/A	100 effects with tap delay control
Power Requirement (external power supply, depends on region)	100VAC, 120VAC, 220~240VAC, 50/60Hz	100VAC, 120VAC, 220~240VAC, 50/60Hz
Weight	1.7kg (3.75 lbs)	1.72 kg (3.78 lbs)
Dimensions (WxHxD)	242 x 55 x 225mm (9.5" x 2.16" x 8.86")	242 x 55 x 225mm (9.5" x 2.16" x 8.86")

AM440 BLOCK DIAGRAM

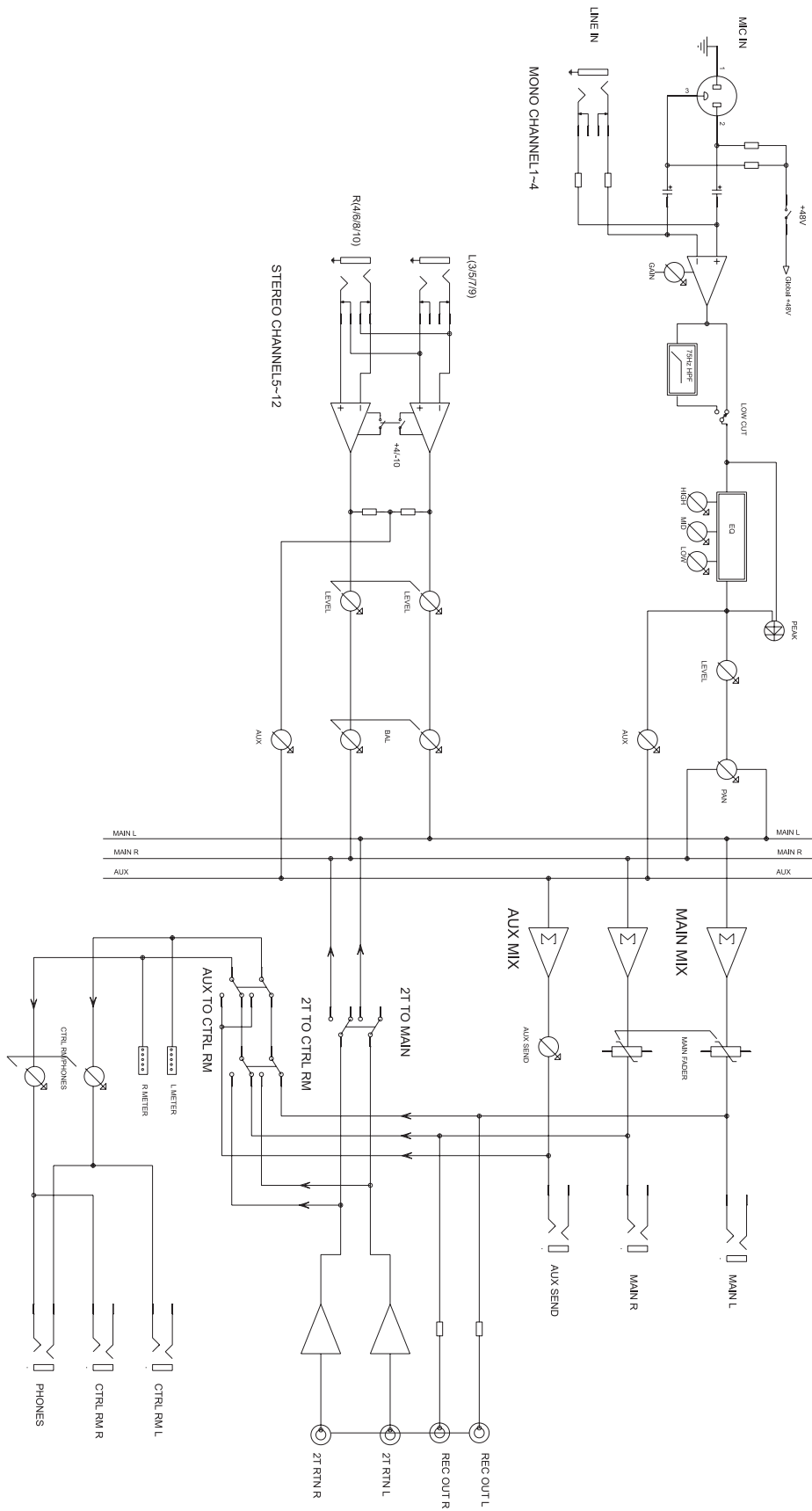

AM440D BLOCK DIAGRAM

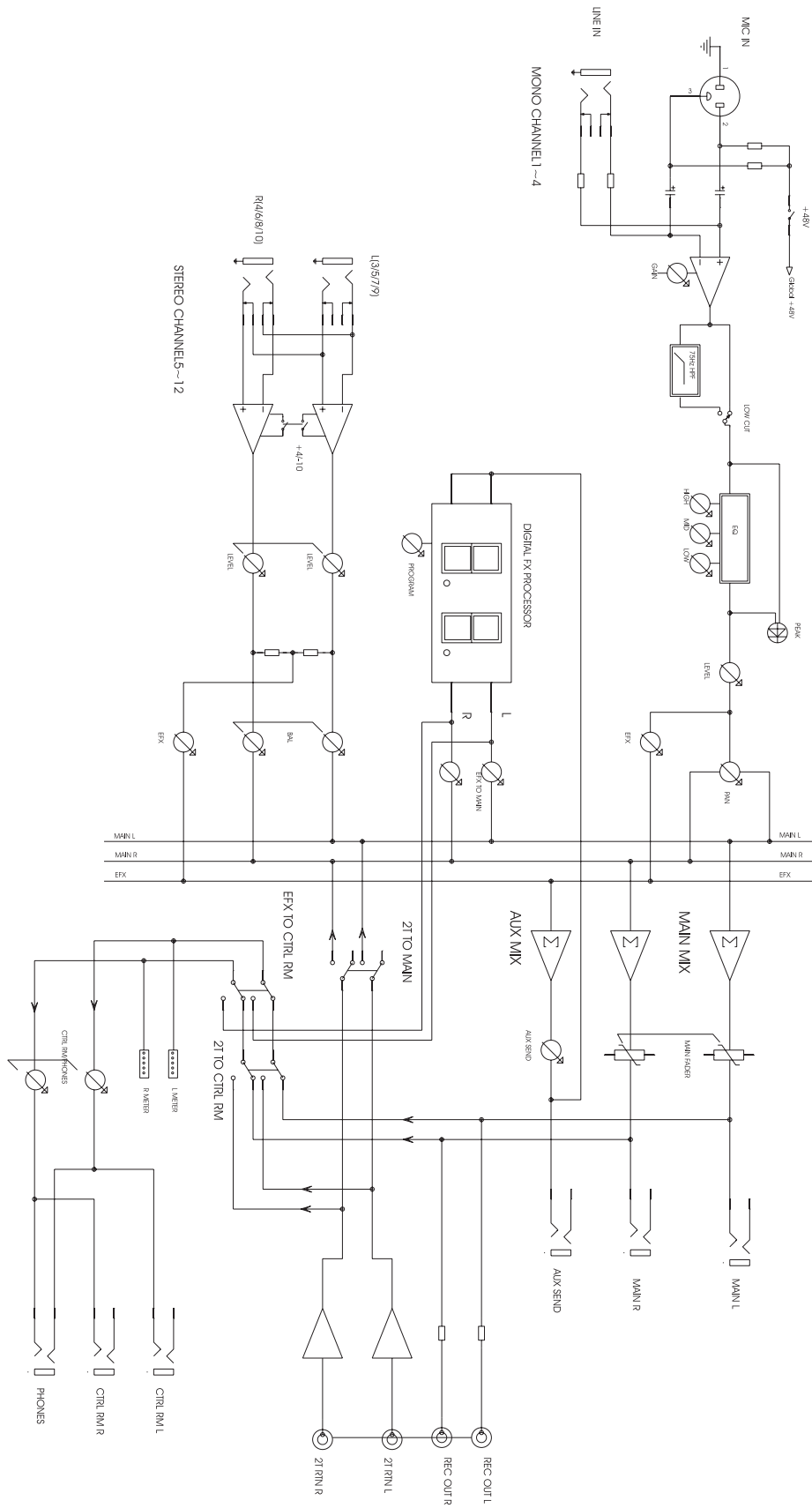

TO PURCHASE ADDITIONAL PHONIC GEAR AND ACCESSORIES

To purchase Phonic gear and optional accessories, contact any authorized Phonic distributor. For a list of Phonic distributors please visit our website at www.phonic.com and click on Get Gear. You may also contact Phonic directly and we will assist you in locating a distributor near you.

SERVICE AND REPAIR

Phonic has over 100 service centers worldwide. For replacement parts, service and repairs please contact the Phonic distributor in your country. Phonic does not release service manuals to consumers, and advice users to not attempt any self repairs, as doing so voids all warranties. You can locate a dealer near you at www.phonic.com.

WARRANTY INFORMATION

Phonic stands behind every product we make with a no-hassles warranty. Warranty coverage may be extended, depending on your region. Phonic Corporation warrants this product for a minimum of one year from the original date of purchase against defects in material and workmanship under use as instructed by the user's manual. Phonic, at its option, shall repair or replace the defective unit covered by this warranty. Please retain the dated sales receipt as evidence of the date of purchase. You will need it for any warranty service. No returns or repairs will be accepted without a proper RMA number (return merchandise authorization). In order to keep this warranty in effect, the product must have been handled and used as prescribed in the instructions accompanying this warranty. Any tempering of the product or attempts of self repair voids all warranty. This warranty does not cover any damage due to accident, misuse, abuse, or negligence. This warranty is valid only if the product was purchased new from an authorized Phonic dealer/distributor. For complete warranty policy information, please visit <http://www.phonic.com>.

CUSTOMER SERVICE AND TECHNICAL SUPPORT

We encourage you to visit our online help at <http://www.phonic.com/help/>. There you can find answers to frequently asked questions, tech tips, driver downloads, returns instruction and other helpful information. We make every effort to answer your questions within one business day.

Phonic America Corporation
5411 Johns Road, #605
Tampa, FL 33634
(813) 890-8872
support@phonic.com
<http://www.phonic.com>

PHONIC

PHONIC
WWW.PHONIC.COM