



Dear Valued Customer,

Thank you for choosing Listen! All of us at Listen are dedicated to providing you with the highest quality products available. We take great pride in their outstanding performance because we care that you are completely satisfied. That's why we independently certify them to the highest quality standards and back them with a limited lifetime guarantee. We stand ready to answer any questions you might have during installation or in the operation of our products. Should you experience any problems whatsoever with your Listen products, we are ready to help you in any way we can with prompt, efficient customer care. Because at Listen, it's all about you! And should you have any comments on how we might improve our products or our service, we're here to listen.

Here's how to reach us:

801.233.8992

800.330.0891 North America

801.233.8995 fax

support@listentech.com

www.listentech.com

Thank you and enjoy your listening experience!

Best regards,

Russell Gentner and the Listen Team

- In the few instances where repairs were needed, 99% of all clients indicated that they were happy with repair turn-around-times and 85% of the time, clients were without their product for less than 10 days!
- Overall client satisfaction of working with Listen was rated 4.8 out of 5.
- "Please continue with your excellent attitude toward customer satisfaction. You guys are great!"
- "I've never had such good service from any company. Keep up the good work!"
- "You stand behind your product wonderfully."

Assistive Listening • Language Interpretation • Soundfield • Tour Group • Conferencing



LR-600 Table of Contents

Package Contents	3
Specifications	4
Architectural Specifications	4
Specifications	4
Block Diagram	5
Quick Reference	6
Setup/Programming Instructions	7
Operation	7
Power/Battery Options	9
Battery Charging	11
Antenna Options	12
Setup & Programming	13
Equalization Adjustment	16
Squelch Adjustment	17
Auxiliary Input & Output	18
Mounting/Carrying Options	19
Maximizing RF Reception Strategies	20
Listen SQ™ (Super Quiet)	21
Coaxial Cable	22
Channel Selection	23
Compatibility Charts	24
72 MHz Frequency Compatibility Chart	24
216 MHz Frequency Compatibility Chart	25
Supplementary Information	26
Troubleshooting	26
Compliance Notice	28
FCC Statement	28
Warranty	29
Contacting Listen	29
Optional Accessories	30



LR-600 Package Contents

LR-600 Contents

- LR-600 Wireless Speaker / Receiver (72 MHz or 216 MHz)
- Adjustable/removable handle/mounting bracket with leatherette cover
- LA-201 Power Supply
- (2) .18 x 1.38 in. (4.5 x 35 mm) screws with hollow wall anchors
- (1) 16 mm nut for mounting the LR-600 on a microphone stand
- Warranty Card
- User Manual

Listen Part Number

LR-600-072 (72 MHz)
LR-600-216 (216 MHz)

Optional Accessories

See page 30



LR-600 Specifications

Architectural Specifications

The FM speaker/receiver shall be capable of receiving on 57 wide and narrow band channels. The speaker/receiver shall have 10 watts output power and have a frequency response of 50 Hz to 15K Hz, ± 3 dB at 72 MHz, or of 50 Hz to 10 kHz, ± 3 dB at 216 MHz. The signal to noise ratio shall be 80 dB or greater. The device shall have an adjustable squelch and three-band equalizer. The device will incorporate a backlit LCD Display that indicates channel and RF signal strength, as well as be used for channel selection programming. The unit shall be programmable to display only used channels. It shall also incorporate an electronically lockable volume and channel controls. Controls should be found on the top and rear of the unit. The device shall incorporate a power supply (120 VAC, 60 Hz, 43 Watts), with output DC 12V 2500 mA tip negative. It will alternately use an internal battery pack using eight AA alkaline or NiMH Rechargeable batteries and include recharging components for said NiMH batteries. The speaker should have a minimum SPL of 110dB (± 3 dB). An included bracket will be able to be used as a handle for carrying, or be adjustable up to 360 degrees around the unit for mounting. The Listen LR-600 is specified.

Specification

Specifications		LR-600-072	LR-600-216
RF	RF Frequency Range	72.025 - 75.950 MHz	216.025 - 216.975 MHz
	Number of Channels	57 (17 wide, 40 narrow)	57 (19 wide, 38 narrow)
	Frequency Accuracy	+/- .005% stability 0 to 50C	
	Antenna (Internal)	Comes with Internal Antenna	
	Antenna (External)	Several available. See www.ListenTech.com for details	
	Antenna Connector (External)	BNC	
	Compliance	FCC Part 15, Industry Canada	
Audio	** All system specifications are wireless end-to-end		
	System Frequency Response	63Hz - 15kHz (± 3 dB)	63Hz - 10kHz (± 3 dB)
	System Signal to Noise Ratio (Aweighted)	SQ enabled: 80dB; SQ disabled: 60dB	SQ enabled: 80dB; SQ disabled 50dB
	System Distortion	<2% total harmonic distortion (THD) at 80% deviation	
Controls	Set Up Controls	Programmable channel selection and squelch. Batteries (alkaline/NiMH), SQ (enable/disable), Antenna (internal/external), Equalization POT's (Low/Mid/High)	
	User Controls	Volume, channel up/down/seek.	
	Programming	Can be programmed so that only desired channels are selectable by user. Squelch can also be adjusted. Channel selection can be locked by holding the SEEK button for 5 seconds.	
Indicators	LCD Display	Indicates channel, battery power level, lock status, RF signal strength and channel programming.	
Power	Battery Type	Eight AA batteries, alkaline or NiMH	
	Power Supply Connector	15VAC, 1000mA; .02 in (5.0mm) OD x .01 in (2.5mm) ID, barrel	
	Compliance	UL Listed	
Physical	Dimensions	11 in. x 9.5 in. x 6 in.	
	Unit Weight	6 lbs.	
	Unit Weight with batteries	6.5 lbs.	
	Shipping Weight	10 lbs. (includes power supply)	
	Battery Compartment	On rear of unit behind access door.	



LR-600 Block Diagram

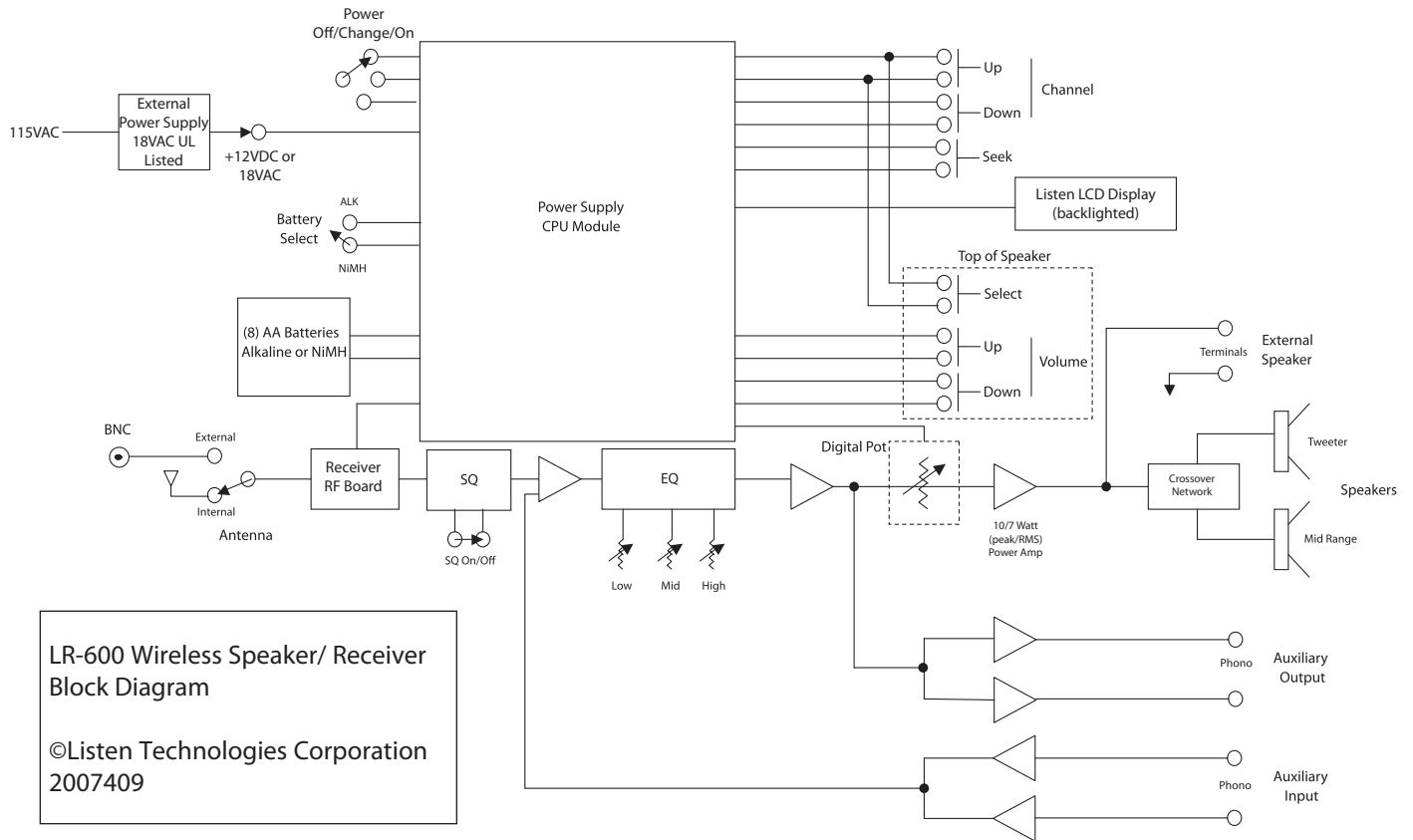

LR-600 Rear Panel: Connections and Controls

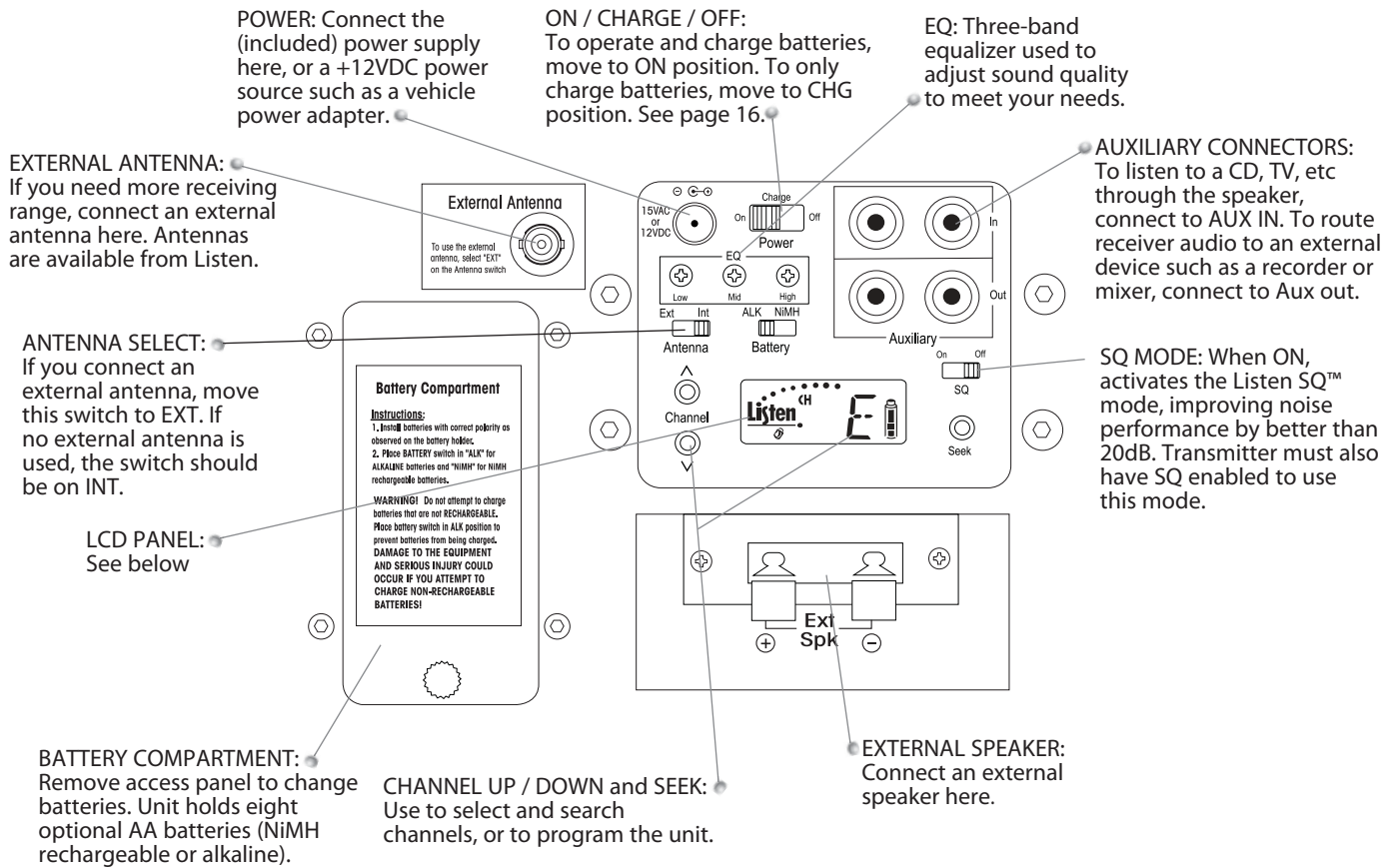

LR-600 LCD Panel Details

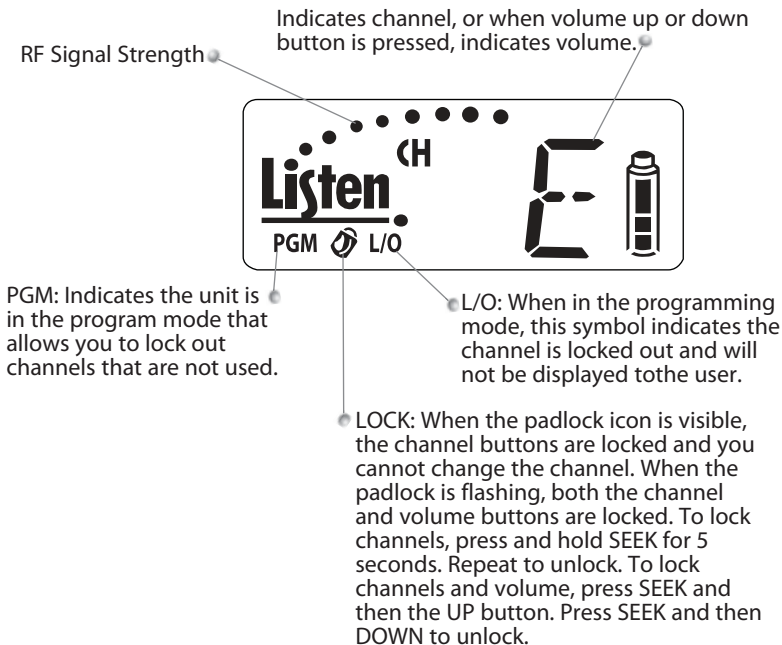

LR-600 Top Panel Details

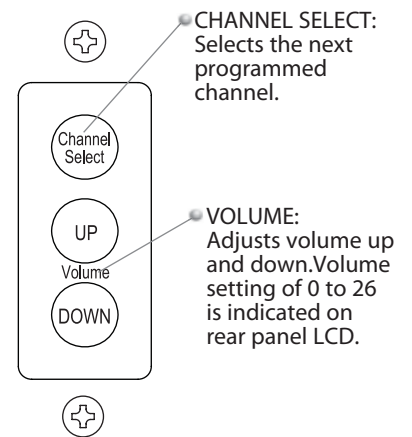

LR-600 Operation

Power the unit ON

Turn the unit on by sliding the power switch on the rear of the unit to the On position. The LCD will activate; if using the LR-600 on the power supply, the LCD backlight will activate and remain on. If you are using the unit on batteries, the LCD backlight will operate for 12 seconds after any button is pressed, and then dim to conserve battery life.

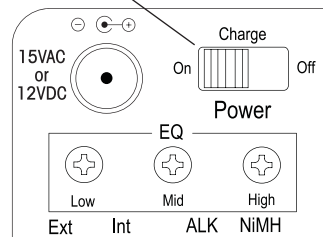

LCD Display

Once the unit is on, the LCD display will illuminate. Notice that when the unit is in operation on the power supply, the LCD backlight will remain lit continuously. When on battery power, the backlight will remain lit for 10 seconds after any button is pushed. This is designed to save battery life.



Volume Control

Adjust the volume setting for a comfortable level by pressing the VOLUME UP and DOWN buttons on the top of the unit. The volume setting (a number between 0 and 26) will be shown on the display. To lock the volume setting see page 14.



Control panel (rear of unit)

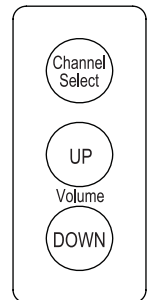

Control panel (top of unit)

Channel Selection

To select a program channel, press the Channel Select button on the top of the unit. To program this function see page 13. If channels have not been programmed, the unit will step through all available channels as you repeatedly press the CHANNEL SELECT button. If channels have been programmed, you may wish to use the Seek button on the rear panel instead. Pressing Seek will cause the LR-600 to search for an available transmission. You may also use the Channel UP and DOWN buttons on the rear panel to step through the channels available to the LR-600.

Battery Icon

The battery icon shows the amount of battery life remaining in full, $\frac{1}{2}$, $\frac{1}{4}$ and flashing increments (indicating low battery). When charging, the battery icon changes through all of these states to show it is charging. See page 11 for complete battery information.

Signal Strength

Just as on your cellular telephone, the dots above the Listen logo show the RF signal strength coming from the transmitter.

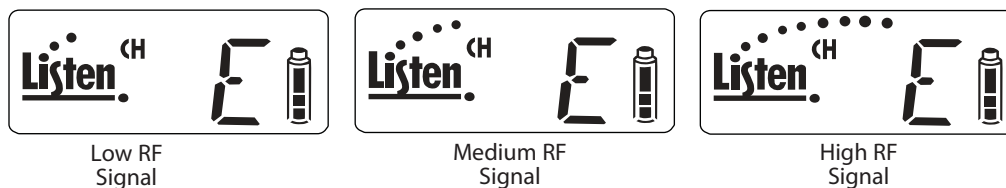

Program Icon PGM

When lit the Program icon indicates the unit is in the program mode that allows you to lock out channels that are not used.

Padlock Icon

If illuminated, indicates the channel selection function is locked. If flashing, indicates the channel selection and volume control functions are locked. See page 14 for more information.

Lock Icon L/O

When the padlock icon is visible, the channel buttons are locked and you cannot change the channel. When the padlock is flashing, both the channel and volume buttons are locked. To lock channels, press and hold SEEK for 5 seconds. Repeat to unlock. To lock channels and volume, press SEEK and then the UP button. Press SEEK and then DOWN to unlock.

LR-600 Power/Battery Options

Power Supply (included with unit)

If you are using the LR-600 with the external power supply, connect the power supply to the LR-600 and plug the power supply into a 115VAC/60 Hz outlet.

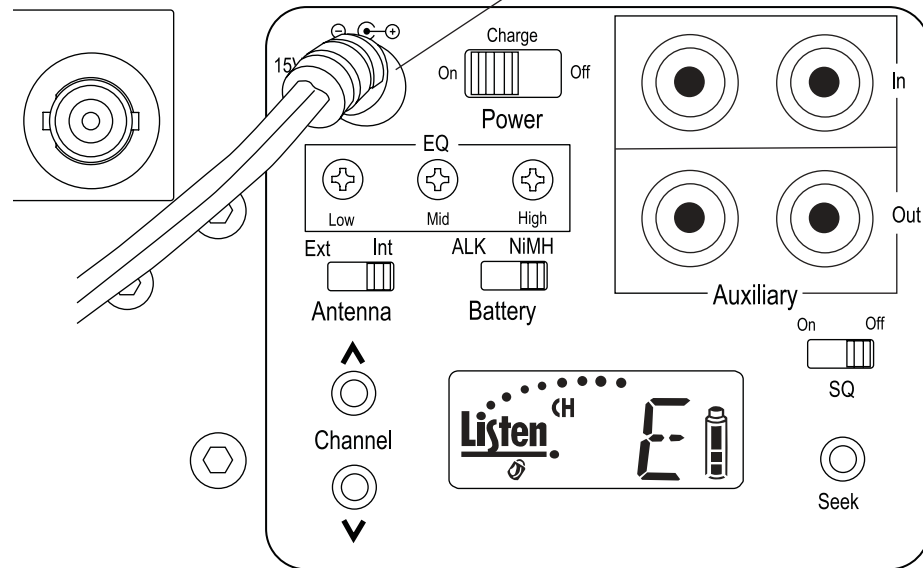

External +12VDC Source

If you are using the LR-600 with an external +12VDC battery or power supply, obtain a power connector with following dimensions:

- 0.098 in. (2.5 mm) inside diameter
- 0.217 in. (5.5 mm) outside diameter
- 0.374 in. (9.5 mm) length

Wire the connector so the tip is positive. Connect to a 12VDC battery or +12VDC output of a power supply.

LR-600 Power/Battery Options (cont.)

Internal Batteries

If you are using the LR-600 with internal batteries, do the following:

- Open the battery compartment by removing the thumbscrew and then removing the cover.
- Slide the battery holder out of the battery compartment.
- Install eight AA alkaline or NiMH batteries with polarity noted on the battery holder.
- Replace the battery holder and secure the battery compartment cover.

IMPORTANT: Slide the battery switch to the alkaline or NiMH battery position depending on the battery type you are using.

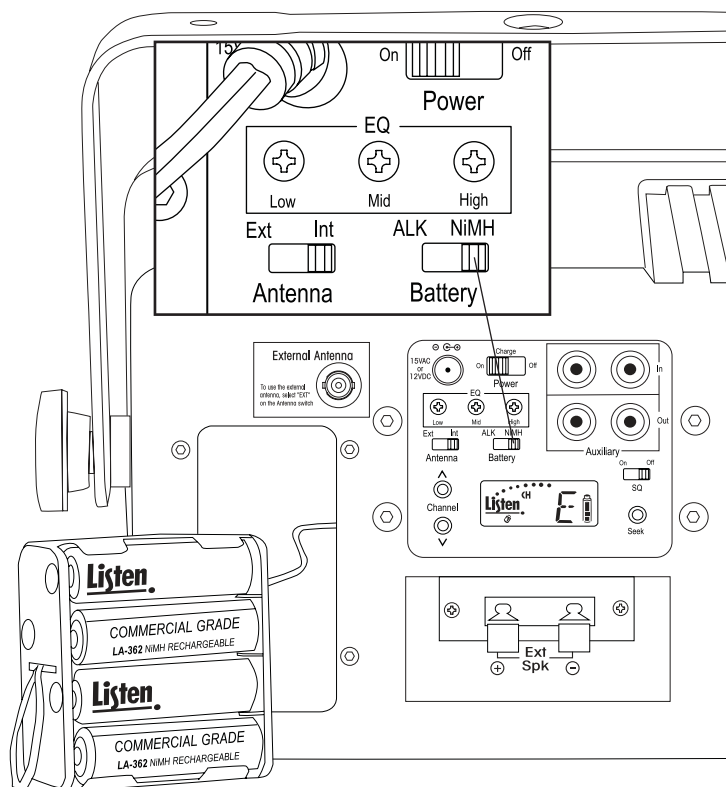
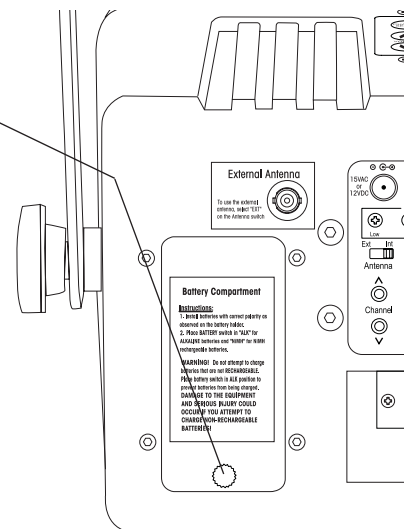

IMPORTANT: You must place the Battery switch in the appropriate position for the type of batteries you will be using. If you are using alkaline batteries and the switch is in the NiMH position, the unit will attempt to charge the batteries when connected to a power supply or external battery. Attempting to charge alkaline batteries can result in permanent damage to the unit, and the batteries may explode. Damage resulting from attempting to charge alkaline batteries will void the warranty.

LR-600 Battery Charging

Battery Charging

For NiMH battery operation, you must charge the batteries for 13 hours before use. To charge the batteries, plug the unit into the power supply or external +12VDC supply and move the power switch to either CHG or ON. The batteries will charge in either position.

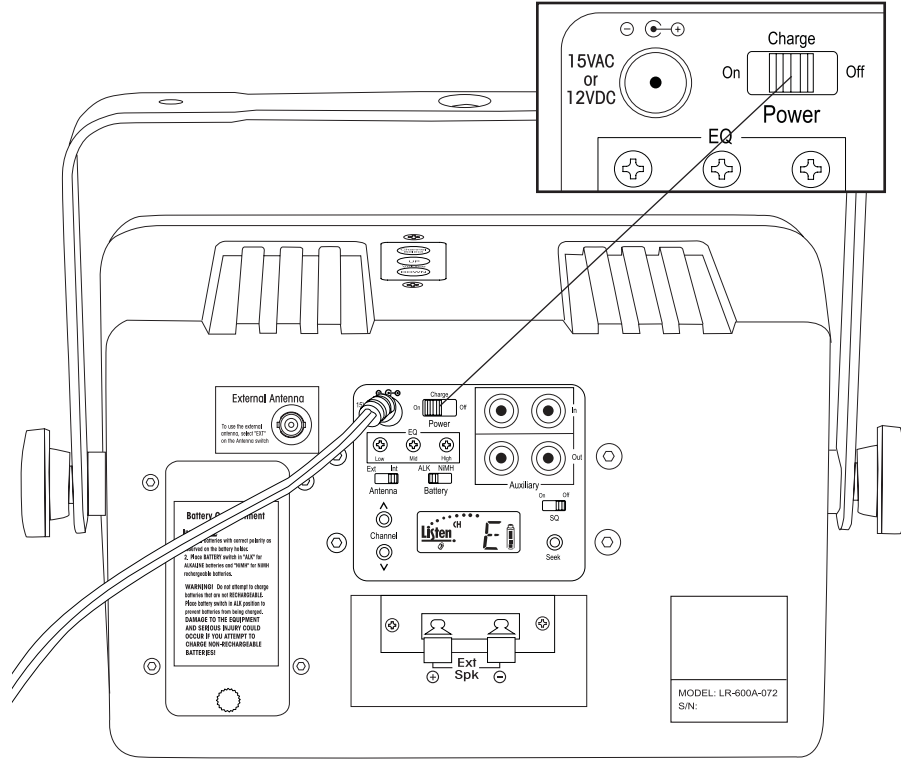

When the batteries are charging, the battery icon changes from $\frac{1}{4}$ to $\frac{1}{2}$ to full and then repeats to indicate charging.

When not using the unit, it is advisable to leave the unit connected to the power supply to keep the batteries fully charged. This will not damage the batteries.

When the batteries are fully charged, the unit will automatically shut off. To reactivate the unit, turn the unit OFF and then back ON.

NOTE: During battery operation, if the battery icon begins flashing on the Low level (one bar showing), your batteries are almost exhausted and shutdown is imminent. Connect to a power supply or replace the batteries.

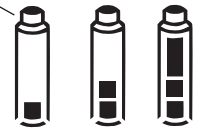

In Charge mode, the battery symbol will cycle between low, mid and full.

LR-600 Antenna Options

The LR-600 has two antenna options: internal or external. On 72 MHz units, connecting a helical external antenna (LA-123) will double your range (approximately). 216 MHz units have a much more efficient internal antenna so range is minimally increased by adding a helical external antenna (LA-124). To use the internal antenna, move the antenna switch to Int. To use the external antenna, move the switch to Ext.

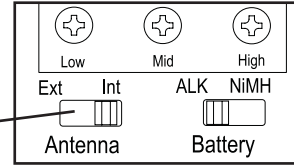

Internal antenna

As shipped, your LR-600 is set up for use with its internal antenna. The internal antenna will work well for a large number of uses, but it cannot be positioned for best coverage. When using the LR-600's internal antenna, make sure the antenna switch is in the Int position. If your receive signal is noisy or weak, you may need to use an external antenna.

External antennas

To use an external antenna with the LR-600 the Antenna switch on the rear of the unit must be set to Ext (see illustration below).

There are four options for the external antenna:

1 LA-123 (72 MHz) or LA-124 (216 MHz) 90 Degree Helical Antenna

This antenna mounts directly to the back of the LR-600. (Shown below)

2 LA-122 Universal Antenna Kit (72 and 216 MHz)

This remote antenna contains both 72MHz and 216MHz antennas in monopole and dipole options. Includes all hardware to mount on a wall, electrical box or on a horizontal surface as well as, 25 feet (7.6 m) of RG-58 coaxial cable.

3 LA-107 Ground Plane Remote Antenna (216 MHz)

¼ wave antenna designed for outside mast or conduit mounting. Includes 50 feet (15.25 m) RG-58 coaxial cable.

4 LA-116 (72 MHz) or LA-117 (216 MHz) Coaxial Dipole Remote Antenna

Flexible coaxial cable antenna that can be mounted on a wall or placed in a drop ceiling. Includes 25 feet (7.6 m) RG-58 coaxial cable.

NOTE: See page 30 for complete descriptions and illustrations of antenna options.

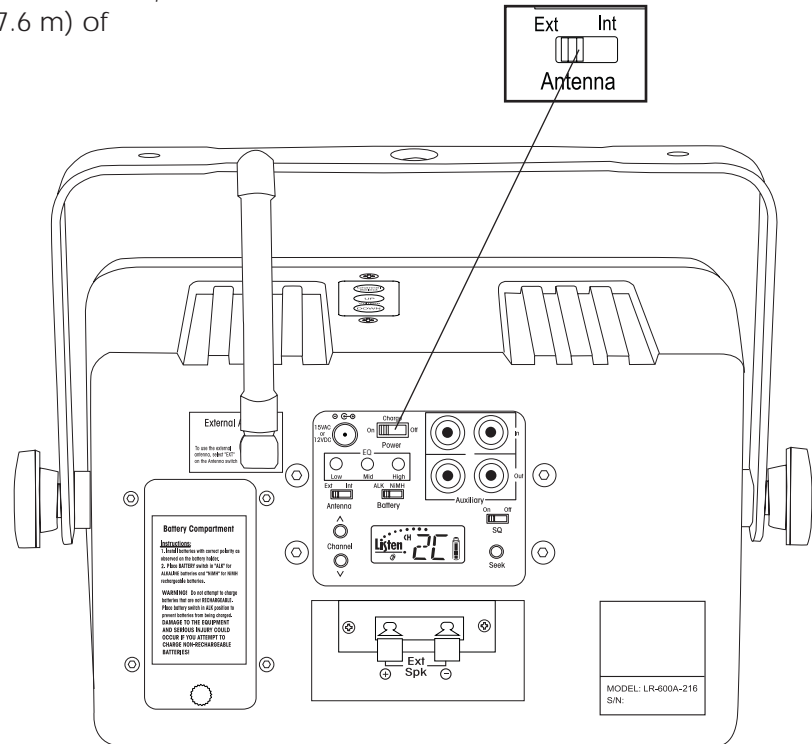

LR-600-216 shown with LA-124 (216 MHz) antenna

Setup/Programming

LR-600 Setup and Programming

Power the unit ON

Turn the unit on by sliding the power switch on the rear of the unit to the On position.

Channel Selection

Using the channel select buttons (UP and DOWN buttons on the rear panel) or the SEEK button, select the desired receive channel. For more information, see Channel Selection on page 23.

Locking Channel Selection

If you don't want the user to have the ability to change the channel, it is highly recommended that you lock the channel select function. This is accomplished as follows:

- Press and hold the SEEK button for 5 seconds.
- The padlock icon will appear in the display.
- To unlock the channel selection function, press and hold the SEEK button until the padlock icon goes out.

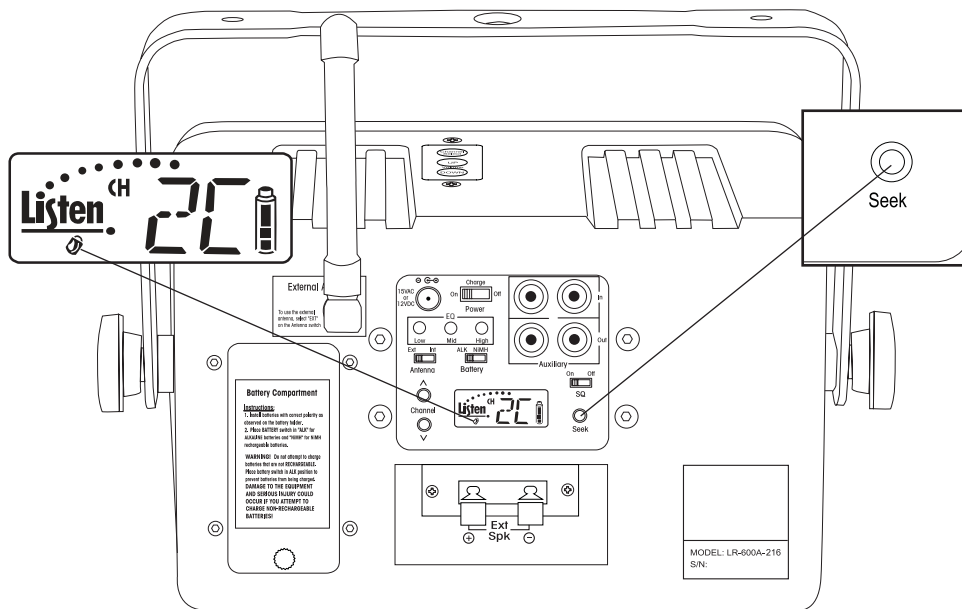

Locking the Unit on a Channel

Once the desired channel has been selected, you can lock the channel select buttons as follows:

- Press and hold the seek button for 5 seconds
- The padlock icon will illuminate solid on the rear panel LCD display
- To unlock, press and hold the seek button for 5 seconds.

Locking both Volume and Channel

Once the desired channel and volume has been set, both functions can be locked as follows:

- Press the seek and channel up button simultaneously
- The padlock icon will flash on the LCD display
- To unlock, press the seek and channel down button simultaneously

Setting the SQ Switch

For more information on SQ, see Listen SQ™ on page 21.

The SQ function improves the noise performance of the LR-600 by at least 20dB. To use this function, the transmitter must also be a Listen brand transmitter with SQ.

To use the SQ function, do the following:

- Verify the transmitter has SQ and the SQ function is turned on.
- Move the SQ switch on the back of the unit to the ON position.
- If you are using the LR-600 with another brand transmitter or if you don't want to use the SQ function, move the SQ switch to the OFF position.

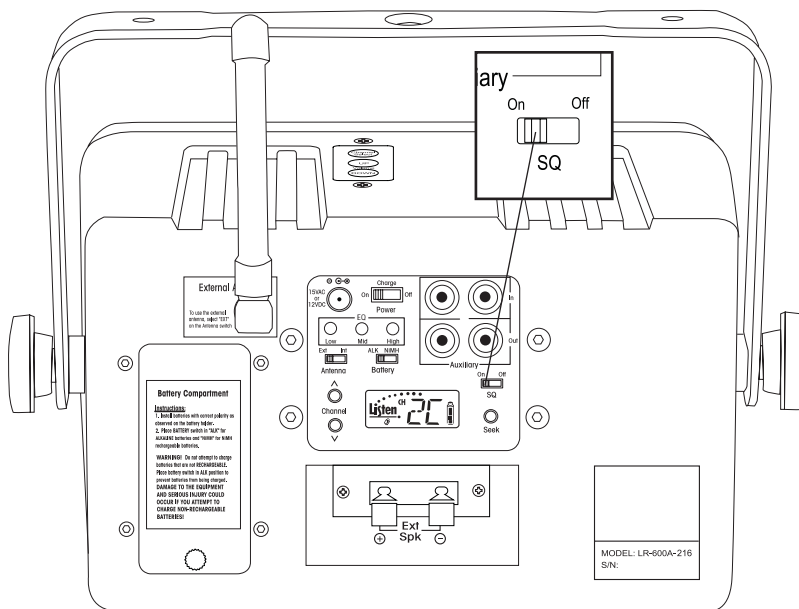

Programming the Channel Select Button

The channel select button on the top of the unit is designed to give users the ability to choose between different channels. If you don't want to give users this function, it is recommended that you lock this feature as described on page 13.

If you want to use this function, you must program the unit for the channels you are using. For example, you are using 72 MHz channels A, E and I. You would only want the LR-600 to receive on channels A, E, and I. When the Channel Select button has been programmed, the unit will select A the first time the user presses the button; when the user presses the button successively, E will be selected, then I, then A again.

Note: The UP button on the rear panel and Channel Select button on the top of the unit perform the same function for end users.

To program the unit so that it only receives on certain channels, do the following:

- Press the UP and DOWN buttons together and release. The PGM icon is displayed.
- Press the UP or DOWN button to select channels.
- When you get to a channel that you don't want displayed, press the SEEK button.
- The L/O icon will be displayed indicating the channel is locked out and will not be displayed.
- Repeat for all channels that you want locked out.

When done, don't press a button for 10 seconds and the unit will return to normal operation.

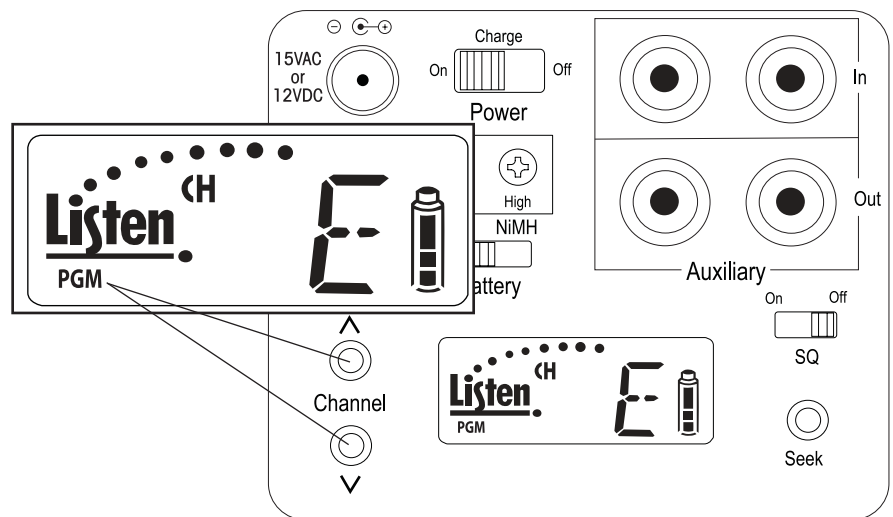

Press the Channel UP and DOWN buttons at the same time to enter Program mode (shown by the PGM icon).

While in Program mode, press SEEK to lock out a channel that you do not want available to the end user. L/O will show on the display.

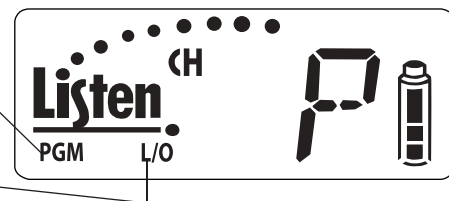

LR-600 Equalization Adjustment

The purpose of the equalizer is to adjust the sound quality to your specific needs and taste. Use a small screwdriver to adjust the LOW, MID and HI positions. These correspond to the following center frequencies: 250 Hz, 1 kHz and 4 kHz.

Adjust to the center position to make the frequency response flat.

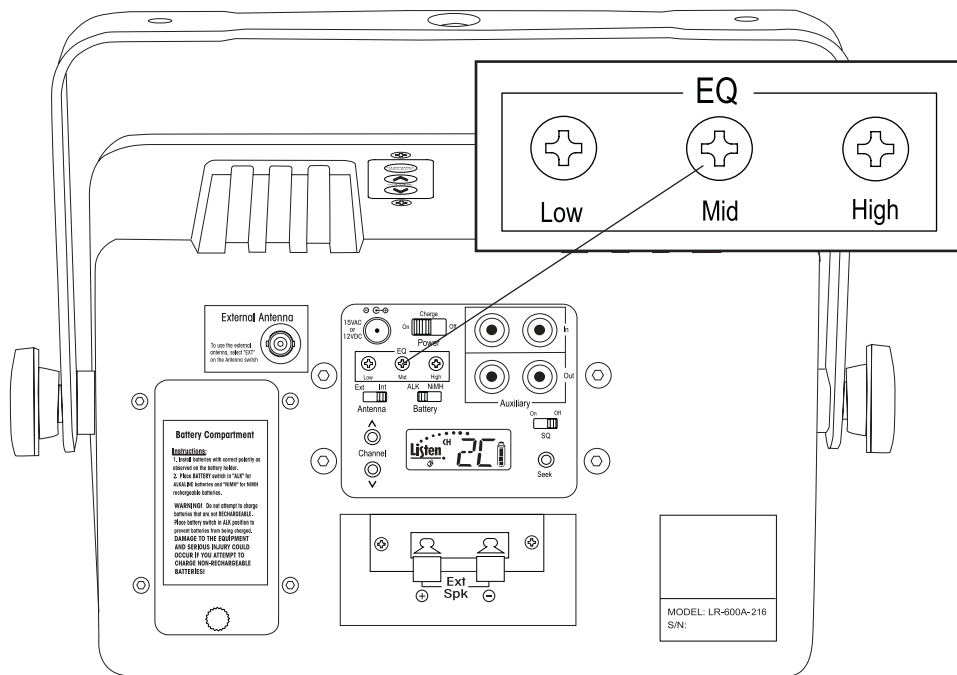

LR-600 Squelch Adjustment

When the transmitter is not turned on, the squelch function mutes the audio so that random noise is not heard through the speaker.

The squelch function can be programmed for more or less sensitivity. When the squelch function is programmed for more sensitivity, you sacrifice transmission range in exchange for more reliability of the squelch function. When the squelch function is programmed for less sensitivity, you achieve greater transmission range in exchange for less reliability of the squelch function. This means that even if the transmitter is off, you may hear noise in the speaker. You can try different squelch settings for your application.

Examples for setting the squelch sensitivity high

- You absolutely don't want the unit to have noise when the transmitter is off.
- The transmitter is close to the LR-600.

Examples for setting the squelch sensitivity low

- It doesn't matter if the user hears the noise if the transmitter is turned off.
- The transmitter is located a long distance from the LR-600.

The adjustable squelch can be programmed from 0 (no squelch) to a maximum of 20 (highest sensitivity). The default setting is 3.

To program the squelch setting, do the following

- Turn the unit off.
- Press and hold the SEEK button.
- Turn the unit on.
- Release the SEEK button.
- The squelch setting is shown on the display. Default is 3.
- Use the UP and DOWN buttons on the rear panel to select the setting you want.
Note the RF meter still operates, giving you relative RF power from the transmitter.
- When you are done, press SEEK to store the new squelch setting.

While in Squelch programming mode, channel UP / DOWN buttons are used to change squelch sensitivity. 03 is the factory default.

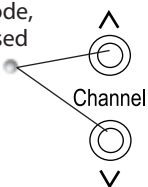

Use Seek to enter Squelch programming mode and to save settings (see instructions above).



LR-600 Auxiliary Input and Output

Additional audio can be mixed with the received audio from the transmitter and sent to the speaker. This can be accomplished by using the auxiliary input connections. Take the audio output of your device (such as a CD player, TV or computer) and connect it to the two input phono connectors of the LR-600.

The auxiliary output phono connectors can be used to take the received audio from the LR-600 to send to a mixer, recorder or other device. The audio being output on these connectors is the received audio only. The audio from the auxiliary input is not present at the auxiliary output. This is done to allow cross-feeding of multiple LR-600's, as described below.

Cross-Connecting LR-600's

Multiple LR-600's can be cross connected to allow audio from multiple transmissions to be heard on all connected LR-600's. For example: You have (2) transmitters operating simultaneously on different channels and (2) LR-600's picking up each transmission channel separately. If you wish to be able to hear both transmissions on both LR-600's, this can be done by cross connecting the units as show below.

The audio being input to an LR-600 will not be present on the audio output. Only the received audio from the transmitter will be output on the LR-600. This is done to allow cross connecting without creating an audio loop. If units are cross connected and auxiliary audio from another device such as a CD player or computer is input, that audio will only be heard on that LR-600.

LR-600 External Speaker (optional)

You can connect an external speaker to the LR-600. Make sure that the speaker is 4 ohms or greater. The Listen LA-316 speaker provides the same look as the LR-600.

Connect auxiliary phono cables here.

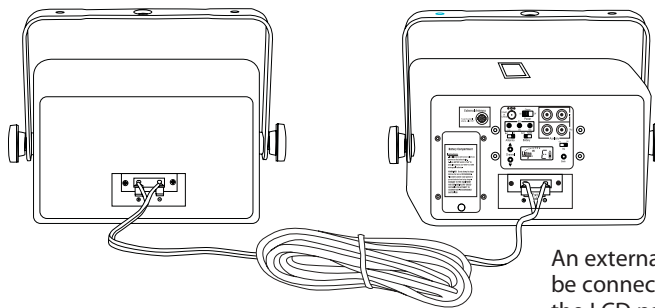
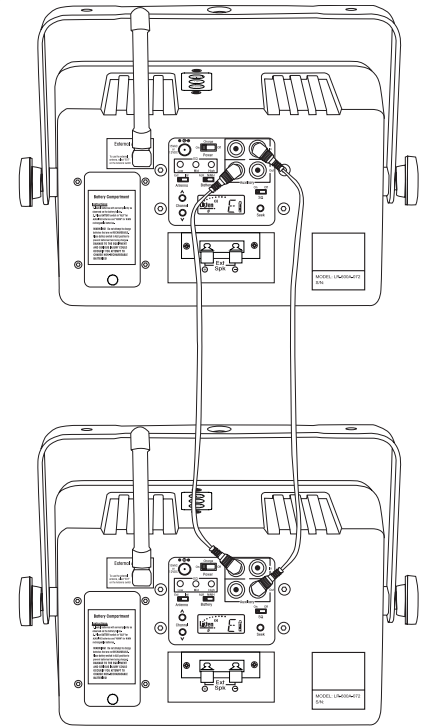
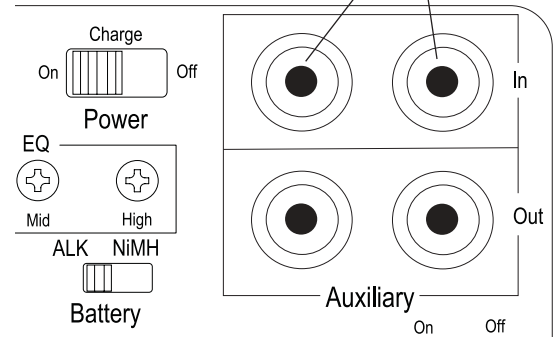

An external speaker (4 ohms or greater) may be connected to the speaker terminals below the LCD panel.

LR-600 Mounting/Carrying Options

Carrying Options

The U bracket that comes standard with the LR-600 can be used to permanently mount the unit, set the unit at an angle on a desktop, or be used as a carrying handle.

To change the position of the U bracket:

- Loosen the two screws (the large knobs) on both sides of the LR-600. Note that you have to loosen the screws considerably to allow the bracket to swivel.
- Rotate the bracket to the desired position.
- Re-tighten the two screws.

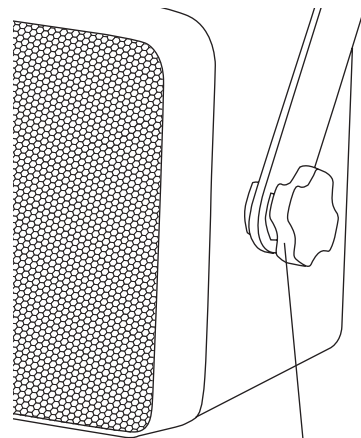

Loosen knobs to rotate handle/bracket.

Mounting Options

You can mount the LR-600 to a microphone stand, or you can use the U bracket to directly mount it to any vertical or horizontal surface.

Microphone Stand Mounting

- Locate the microphone stand nut in the included poly bag, or use the nut that comes with the microphone stand.
- Remove the leatherette handle cover.
- Position the U bracket so that it will hold the LR-600 upright on the microphone stand.
- Screw the nut onto the stand and tighten with a wrench.

Vertical / Horizontal Permanent Mounting

- Remove the U bracket by loosening the two screws on both sides of the LR-600. Be careful not to lose the washers.
- Using the two self-tapping screws and (if necessary) hollow wall anchors, mount the bracket to any surface.
- Position the LR-600 into the bracket and tighten the two screws.

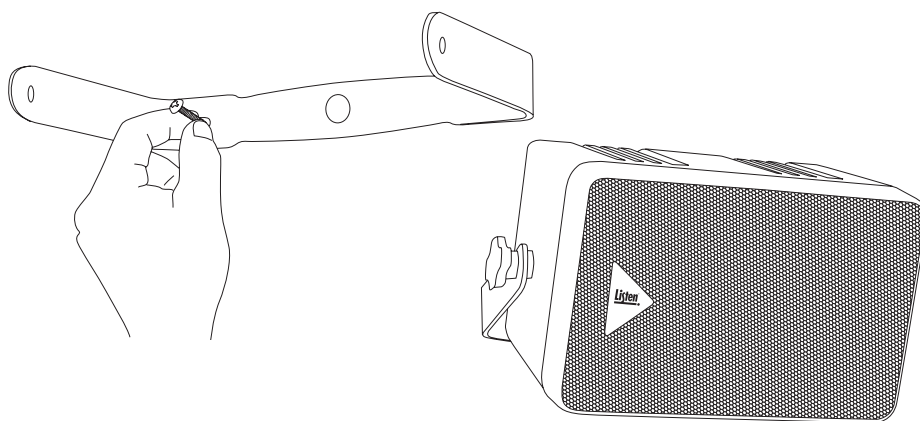

LR-600 Maximizing RF Reception Strategies

For proper and dependable operation, the LR-600 should receive a strong and consistent signal from the originating transmitter. The following strategies should be used to maximize this signal:

- 1 When designing and installing your system, keep in mind that the location of both the transmitting and receiving antennas is critical to maximizing signal strength.
- 2 Eliminate or minimize obstructions between the transmitting antenna and the receiving antenna.
- 3 Minimize the distance between the transmitting and receiving antennas.
- 4 Move transmitting and receiving antennas away from metal objects.
- 5 Consider using a remote antenna instead of the internal antenna. This will allow you to place the antenna at a location with improved line of sight to the transmitting antenna. (You will need to be careful about the type and length of coaxial cable; see the note above.)
- 6 Place the transmitting antenna as high as possible.
- 7 Orient both transmitting and receiving antennas vertically.
- 8 Consider using a gain antenna such as a Yagi type antenna (216 MHz only).

CAUTION: When installing antennas, ensure the antenna is clear of power lines.

NOTES: If the RF signal to the LR-600 is too high, the audio will be distorted. This may happen if you are within 40 feet of the LT-800 transmitter. Consider reducing the output power of the transmitter or optionally removing the antenna on the LR-600 (there is sufficient internal antenna inside the LR-600 to receive an adequate signal from the transmitter).

Coaxial cable, connectors, and optional antenna mounting kits are available from Listen. Visit our website for details, www.listentech.com.

We are accustomed to listening to low noise, high fidelity audio (delivered via CD, DVD, etc.). FM radio systems, such as those made by Listen, have more inherent noise compared to most sound systems. To reduce noise of our systems, Listen uses a noise reduction technology called ListenSQ™. Both the transmitter and receiver must have the SQ feature enabled to achieve the desired results. SQ is available on new Listen systems, including the system you received in this shipment. If you are planning to use this product with older Listen systems that do not have Listen SQ or equipment not manufactured by Listen, you should disable Listen SQ.

Your Listen equipment has been shipped to you with the SQ feature enabled. You may need to disable the SQ function for one or more of the following reasons:

- 1 You are using your new Listen system with older version Listen equipment that does not have the SQ function.
- 2 You are using your new Listen system with equipment supplied by other manufacturers.
- 3 You expect that end users may bring and use their own receivers that don't have the SQ function.

SQ Summary

- SQ is NOT squelch. Improves noise performance by at least 20dB
- SQ is NOT compatible with older version Listen products
- SQ is NOT compatible with other manufacturers' products
- To work properly, SQ must be enabled for both the transmitter and receivers
- SQ can be disabled to permit operation with older Listen products or other manufacturers' products



Coaxial Cable

The antenna for the LT-800 can be mounted directly on the unit if desired. However, you may find that the unit will provide better performance when the antenna is located elsewhere. If you plan to mount the antenna in a different location other than the top of the unit, you must use cable and connectors rated at 50 ohms. Although cable used for cable TV installations looks similar to this cable, it will not work with your Listen system.

If you need to run cable over a length greater than 50 feet for 216 MHz applications or greater than 100 feet for 72 MHz applications or to maximize broadcast range, Listen recommends that you use RG-8 cable rather than RG-58. RG-8 is a lower loss cable, meaning that more of your signal will reach the antenna.

Long cable runs can result in signal degradation due to the "loss" characteristics of the cable. When using RG-58 with a 72 MHz transmitter, there is an average* loss of 4 dB per 100 feet of cable and at 216 MHz using RG-58 an average* loss of 8 dB per 100 feet of cable. (A 3dB loss means half of your power has been lost.) However, it is better to suffer coaxial power loss than to try to shoot your signal through obstacles! Obstacles, especially metal, can create drop-outs or reflections of your signal that will result in poor listening conditions.

****NOTE: There are many varieties of 50 ohm, RG-58 and RG-8 cables. You may purchase a cable that is better or worse than this value. Please check with the cable vendor or manufacturer for exact specifications.***



It is important to choose channels that are free from interference to achieve proper operation of your Listen equipment. This process is trial and error. Before turning on the transmitter, listen to the wide band channels on the receivers (lettered channels at 72 MHz and channels that start with a "2" for 216 MHz when using a Listen receiver). Listen to the audio through the headphone or via the speaker and choose a channel with the least amount of interference. Unless you are interfacing with an existing narrowband transmission system, always use a wide band channel.

If you are using multiple channels follow this process:

- 1 Same Space** If you are using multiple transmitters in the same space, the highest number of channels that will work simultaneously is six at 72 MHz and three at 216 MHz. With all of the transmitters off, listen for interference on all the wide band channels with a Listen receiver. Using the frequency compatibility tables on pages 24-25, eliminate any channels that have noticeable interference. Now choose the channels with the widest channel spacing. It is recommended that adjacent channels be spaced at least 300k Hz apart. If there is no interference the following channels are recommended. For a 72 MHz system, use channels A, C, E, I, J and H. For a 216 MHz system, use channels 2A, 2K and 2V.
- 2 Distributed Spacing** If you are using transmitters that are distributed over a large area, you can achieve more simultaneous broadcast channels. However, it is critical that your receiver(s) be located as close to its transmitter as possible. You can use adjacent channels (see frequency compatibility tables on pages 24-25) in this case as long as the adjacent channel transmitter is at least 50% further away from the receiver than the original transmitter. Example: The transmitter for the receiver on channel E is 100 feet from the receiver. The adjacent channel transmitter on channel D should be at least 150 feet away.

It is highly recommended that after channel selection has been achieved, you lock the channel so that it cannot be changed by the user. To accomplish LOCK on the LT-800, press the "UP" button for 3 seconds. Repeat the process to unlock.

Notes in regard to using 72 MHz and 216 MHz systems:

- 1** 72 MHz is a secondary frequency band. This means that other transmitters are licensed to use these frequencies. Thus, you may experience interference from paging transmitters and other types of transmissions. You will need to find a clear channel by listening to all the wide band channels.
- 2** 216 MHz is a primary frequency band and no other types of transmissions are authorized to use it. Thus, you will find the highest probability of clear channels in this band. However, you may experience intermodulation of the TV Channel 13 aural carrier if there is a channel 13 transmitter in your area and you are close to the transmitter. If you cannot find a clear channel in 216 MHz band due to channel 13, it is recommended that you switch to a 72 MHz system.

Wide Band Recommendation

Listen recommends that you always use a wide band channel unless you need to be compatible with existing narrow band receivers from other manufacturers. Wide band channels have lower noise than their narrow band counterparts.

At 72 MHz

The LT-800 at 72 MHz operates on 17 wide band channels and 40 narrow band channels.

- Letters= Wide Band Channels (Example: E)
- Numbers= Narrow Band Channels (Example: 32)

At 216 MHz

The LT-800 at 216 MHz operates on 19 wide band channels and 38 narrow band channels.

- "2" as left digit= Wide Band Channel (Example: 2C)
- "1" and "3" as left digits= Narrow Band Channels (Examples: 1A; 3R)

72 MHz Compatibility Chart

Frequency MHz	Phonic							Drake
	Listen	Ear	Comtek	Phonak	Williams*	Gentner	Telex	
72.0250	1	1	1	A1	(11, 1)			
72.0500					(2)	1		
72.0750	2	2	2	A2	(12, 3)			
72.1000	A	A	A	A	A, (13, 4)	2	A	72.1
72.1250	3	3	3	A3	(14, 5)			
72.1500					(6)	3		
72.1750	4	4	4	A4	(15, 7)			
72.2000	K	K	K	K	K, (8)	4	B	72.2
72.2250	5	5	5	K5	(16, 9)			
72.2500					(10)	5		
72.2750	6	6	6	K6	(17, 11)			
72.3000	B	B	B	B	B, (18, 12)	6	C	72.3
72.3250	7	7	7	B7	(19, 13)			
72.3500					(14)	7		
72.3750	8	8	8	B8	(20, 15)			
72.4000	N	N	N	N	N, (16)	8	D	72.4
72.4250	9	9	9	N9	(21, 17)			
72.4500					(18)	9		
72.4750	10	10	10	N0	(22, 19)			
72.5000	C	C	C	C	C, (23, 20)	10	E	72.5
72.5250	11	11	11	C1	(24, 21)			
72.5500					(22)	11		
72.5750	12	12	12	C2	(25, 33)			
72.6000	O	O	O	O	O, (24)	12	F	72.6
72.6250	13	13	13	O2	(26, 25)			
72.6500					(26)	13		
72.6750	14	14	14	4	(27)			
72.7000	D	D	D	D	D, (28)	14	G	72.7
72.7250	15	15	15	D5	(29)			
72.7500					(30)	15		
72.7750	16	16	16	D6	(30, 31)			
72.8000	P	P	P	P	P, (32)	16	H	72.8
72.8250	17	17	17	P7	(31, 33)			
72.8500					(34)	17		
72.8750	18	18	18	P8	(32, 35)			
72.9000	E	E	E	E	E, (33, 36)	18	I	72.9
72.9250	19	19	19	E9	(34, 37)			
72.9500					(38)	19		
72.9750	20	20	20	E0	(35, 39)			
74.6250	33	33	33	E3	(36, 40)			
74.6500					(41)	20		
74.6750	34	34	34	E4	(37, 42)			
74.7000	I	I	I	I	I, (38, 43)	21	O	
74.7250	35	35	35	I5	(39, 44)			
74.7500					(45)	22		
74.7750	36	36	36	I6	(40, 46)			
75.2250	37	37	37	I7	(41, 47)			
75.2500					(48)	23		
75.2750	38	38	38	I8	(42, 49)			
75.3000	J	J	J	J	J, (43, 50)	24	P	
75.3250	39	39	39	J9	(55, 51)			
75.3500					(52)	25		
75.3750	40	40	40	J0	(45, 53)			
75.4000	R	R	R	R	R, (54)	26	Q	
75.4250	21	21	21	R1	(46, 55)			
75.4500					(56)	27		
75.4750	22	22	22	R2	(47, 57)			
75.5000	F	F	F	F	F, (48, 58)	28	J	75.5
75.5250	23	23	23	F3	(49, 59)			
75.5500					(60)	29		
75.5750	24	24	24	F4	(50, 61)			
75.6000	S	S	S	S	S, (62)	30	K	75.6
75.6250	25	25	25	S5	(51, 63)			
75.6500					(64)	31		
75.6750	26	26	26	S6	(52, 65)			
75.7000	G	G	G	G	G, (53, 66)	32	L	75.7
75.7250	27	27	27	G7	(54, 67)			
75.7500					(68)	33		
75.7750	28	28	28	G8	(55, 69)			
75.8000	T	T	T	T	T, (70)	34	M	75.8
75.8250	29	29	29	T9	(56, 71)			
75.8500					(72)	35		
75.8750	30	30	30	T0	(57, 73)			
75.9000	H	H	H	H	H, (58, 74)	36	N	75.9
75.9250	31	31	31	H1	(59, 75)			
75.9500					(76)	37		
75.9750	32	32	32	H2	(60, 77)			

*Parenthesis indicate T35 and T20 narrowband.

Wideband frequencies are indicated in highlighted rows. The highlighted channels also indicated those channels available in the "basic" mode (default). All channels can be accessed when in the "expanded" channel mode (see page 9 for more information).

216 MHz Compatibility Chart

Frequency MHz	Listen	Phonic Ear	Comtek	Phonak	Williams	Gentner	CSI	AVR	Light Speed
216.0125	1A		1	1				C01	N01
216.0250	2A	41	41	41		1	1		
216.0375	3A		2	2					
216.0625	1B		3	21					
216.0750	2B	42	42	42		2	10		
216.0875	3B		4	4					
216.1125	1C		5	5				C05	
216.1250	2C	43	43	43	A	3	6		
216.1375	3C		6	22					
216.1625	1D		7	23					
216.1750	2D	44	44	44	B	4	14		
216.1875	3D		8	8					
216.2125	1E		9	9				C09	N09
216.2250	2E	45	45	45	C	5	2		
216.2375	3E		10	24					
216.2625	1F		11	25					
216.2750	2F	46	46	46	D	6	11		
216.2875	3F		12	12				C12	N12
216.3125	1G		13	13					
216.3250	2G	47	47	47	E	7	7		
216.3375	3G		14	26					
216.3625	1H		15	27					
216.3750	2H	48	48	48	F	8	15		
216.3875	3H		16	16				C18	N18
216.4125	1J		17	17				C21	
216.4250	2J	49	49	49	G	9	18		
216.4375	3J		18	18					
216.5125	1K		21	61					
216.5250	2K	51	51	29	H	10	3		
216.5375	3K		22	62					
216.5625	1L		23	28					
216.5750	2L	52	52	52	I	11	12		
216.5875	3L		24	64				C24	N64
216.6125	1M		25	65				C25	
216.6250	2M	53	53	53	J	12	8		
216.6375	3M		26	81					
216.6625	1N		27	82					
216.6750	2N	54	54	54	K	13	16		
216.6875	3N		28	68					
216.7125	1P		29	69				C29	
216.7250	2P	55	55	55	L	14	19		
216.7375	3P		30	83					
216.7625	1R		31	84					
216.7750	2R	56	56	56		15	4		
216.7875	3R		32	72				C32	N72
216.8125	1S		33	73				C33	
216.8250	2S	57	57	57			13		
216.8375	3S		34	76					
216.8625	1T		35	85					
216.8750	2T	58	58	58			9		
216.8875	3T		36	86					
216.9125	1U		37	77				C37	N77
216.9250	2U	59	59	59			17		
216.9375	3U		38	88					
216.9625	1V		39	79				C39	
216.9750	2V	60	60	60			5		
216.9875	3V		40	80				C40	N80

Wideband frequencies in highlighted rows.

Wideband frequencies are indicated in highlighted rows. The highlighted channels also indicated those channels available in the "basic" mode (default). All channels can be accessed when in the "expanded" channel mode (see page 9 for more information).

Troubleshooting

The unit does not power up, or it has stopped operating.

- Ensure the power supply is connected properly.
- Your batteries may be dead. Replace or recharge the batteries.

The audio is muted occasionally.

- The unit's squelch sensitivity may be too high. Either improve the RF signal path (a remote antenna may help) or adjust the squelch setting for less squelch sensitivity.

I hear noise coming from the receiver.

- You may have inadequate RF signal strength. Adjust the positioning of the antennas. Make sure the transmitter is on high power.
- You may be experiencing interference, try a different channel.
- Make sure the transmitter and receiver are on the same channel.
- The squelch sensitivity may be too low. Try setting it higher. See page 17.

The channel is often accidentally changed.

- Lock the unit on channel by pressing and holding the SEEK button for five seconds. The padlock symbol is illuminated on the LCD.

There is no audio.

- Make sure the transmitter and receiver are on the same channel.
- Make sure the volume is turned up.
- Make sure the squelch adjustment is set correctly.

The audio is distorted.

- Make sure the transmitter and receiver are on the same channel.
- Make sure that the SQ switch is ON or OFF for both the transmitter and receiver.
- Make sure the audio level is not set too high.
- Make sure you are not too close to the transmitter.

The level of my Auxiliary device (CD player, etc.) is low.

- Adjust the output volume at the auxiliary device you are using.

I cannot change channels.

- The unit is locked on channel. Press and hold the SEEK button for five seconds.

I cannot change the unit's volume.

- The volume control is locked (the flashing padlock icon indicates this). Press the SEEK and CHANNEL down button simultaneously to unlock.

I cannot pick up the transmitter.

- Make sure the antenna switch is in the correct position.
- Make sure the transmitter is on and is operating on the same channel.
- You may need to use an external remote antenna.

I can see that I am receiving a channel on RF signal meter, but I cannot hear any audio.

- The adjustable squelch may be set too high. See page 17.

When the transmitter is off, I hear noise.

- The adjustable squelch may be set too low. See page 17.

Troubleshooting

I'm trying to find a channel that does not show up on the display.

- The channel may be "locked" out. See page 13.

Will the unit charge the batteries when the power supply is plugged into the unit?

- Yes, as long as the power switch is in the ON or CHG position.

Can I use this product in a motor vehicle?

- Yes, the LR-600 is designed to work with +12VDC from any vehicle. See page 9 for more information.

The unit does not sound good.

- Make sure SQ is on or off on both the transmitter and the LR-600.
- Verify the equalizer has been adjusted properly. Set to flat (center position) to start with. See page 16 for more information.
- Make sure the transmitter and LR-600 are on exactly the same channel.
- Make sure the LR-600 is not too close to the transmitter.

The rechargeable batteries don't last very long.

- They may need to be replaced if they have been used for over 18 months.
- Make sure the charger stays on for the full 13 hours to fully charge the batteries.
- At high volume levels, the batteries will not last very long.
- Make sure you are using quality, long life NiMH batteries.

I have rechargeable batteries in the unit, but they aren't recharging.

- Make sure the Battery switch is set to NiMH. The unit will not charge batteries when the switch is in the ALK position.

The unit won't work on batteries.

- Make sure you are using charged batteries.
- Check the battery polarity of the batteries in the battery holder.
- Make sure the battery holder connector is secure.

If you are still having problems after checking the above items, call Listen for help. We are available from 8 AM to 5 PM Mountain time, Monday through Friday, at 1.800.330.0891 or 801.233.8992, or you can e-mail us at support@listentech.com.

Compliance Notice

This device complies with part 15 of the FCC Rules. Operation is subject to the following two conditions: (1) These devices may not cause harmful interference, and (2) these devices must accept any interference received, including interference that may cause undesirable operation.

Listen's LT-800 Transmitter (216 MHz only)

Listen's LT-800 transmitter is authorized by rule under the Low Power Radio Service (47 C.F.R. Part 95) and must not cause harmful interference to TV reception or United States Navy SPASUR installations. You do not need an FCC license to operate these transmitters. These transmitters may only be used to provide: auditory assistance to persons with disabilities, persons who require language translation, or persons in educational settings; health care services to the ill; law enforcement tracking services under agreement with a law enforcement agency; or automated maritime telecommunications system (AMTS) network control communications. Two-way voice communications and all other types of uses not mentioned above are expressly prohibited.

This device must be installed by a trained audio professional or certified dealer of Listen. The user can't make any modifications to the unit without expressed written consent of Listen Technologies Corporation. Any modifications made will void the FCC compliance, Listen warranty and the users authority to operate Listen's equipment.

FCC Statement

This equipment has been tested and found to comply with the limits for a class B digital device, pursuant to part 15 of the FCC Rules. These limits are designed to provide reasonable protection against harmful interference in a residential installation. This equipment generates, uses and can radiate radio frequency energy and if not installed and used in accordance with the instructions, may cause harmful interference to radio communications. However, there is no guarantee that interference will not occur in a particular installation. If this equipment does cause harmful interference to radio or television reception, which can be determined by turning the equipment off and on, the user is encouraged to try to correct the interference by one or more of the following measures:

- Reorient or relocate the receiving antenna.
- Increase the separation between the equipment and receiver.
- Connect the equipment into an outlet on a circuit different from that to which the receiver is connected.
- Consult the dealer or an experienced radio/TV technician for help.

This equipment has been certified to comply with the limits for a class B computing device, pursuant to FCC and IC Rules. In order to maintain compliance with FCC and IC regulations, shielded cables must be used with this equipment. Operation with non-approved equipment or unshielded cables is likely to result in interference to radio and TV reception. The user is cautioned that changes and modifications made to the equipment without the approval of manufacturer could void the user's authority to operate this equipment.

Warranty

Listen Technologies Corporation (Listen) warrants its transmitters and receivers (LT-82, LT-700, LT-800, LR-100, LR-42, LR-44, LR-300, LR-400, LR-500, LR-600) to be free from defects in workmanship and material under normal use and conditions for the useful lifetime of the product from date of purchase.

Listen warrants its Stationary IR Radiators (LA-140) to be free from defects in workmanship and material under normal use and conditions for three years from the date of purchase.

Listen warrants its Noise Canceling Microphone (LA-270) to be free from defects in workmanship and material under normal use and conditions for one year from date of purchase.

All other products and accessories are warranted for 90 days from date of purchase.

This warranty is only available to the original end purchaser of the product and cannot be transferred. Warranty is only valid if warranty card has been returned within 90 days of purchase. This warranty is void if damage occurred because of misuse or if the product has been repaired or modified by anyone other than a factory authorized service technician. Warranty does not cover normal wear and tear on the product or any other physical damage unless the damage was the result of a manufacturing defect. Listen is not liable for consequential damages due to any failure of equipment to perform as intended. Listen shall bear no responsibility or obligation with respect to the manner of use of any equipment sold by it. Listen specifically disclaims and negates any warranty of merchantability or fitness of use of such equipment including, without limitation, any warranty that the use of such equipment for any purpose will comply with applicable laws and regulations. The terms of the warranty are governed by the laws of the state of Utah.

In the first ninety days after purchase, any defective product will be replaced with a new unit. After 90 days, Listen will, at its own discretion either repair or replace transmitters and receivers with a new unit or a unit of similar type and condition. Product that is not covered under warranty shall be repaired or replaced with a unit of similar type and condition based on a flat fee. Contact Listen for details.

This limited warranty, prices and the specifications of products are subject to change without notice.

Contacting Listen

If technical service is needed, please contact Listen. Pre-authorization is required before returning Listen products. If products were damaged in shipment, please contact the carrier, then contact Listen for replacement or repair requirements payable by the carrier.

Listen's corporate headquarters are located in Salt Lake City, Utah U.S.A. and are open Monday through Friday, 8am to 5pm Mountain Time.

14912 Heritagecrest Way
Salt Lake City, Utah 84065-4818
801.233.8992
800.330.0891 North America
801.233.8995 fax

support@listentech.com
www.listentech.com

LR-600 Optional Accessories

Antenna Accessories



LA-116
Coaxial Dipole Remote Antenna
(72 MHz)



LA-117
Coaxial Dipole Remote Antenna
(216 MHz)



LA-107
Ground Plane Remote Antenna
(216 MHz)



LA-122
Universal Antenna Kit

The single solution for all of your indoor remote antenna needs. Includes: 72 and 216 MHz components; flexible and rigid dipoles and monopole radials; hardware for multiple mounting configurations; and 25 feet (7.6m) of RG-58 coax cable.



LA-123
90-Degree Helical Antenna
(72 MHz)



LA-124
90-Degree Helical Antenna
(216 MHz)

Batteries/Expansion Speaker Accessories



LA-316
Expansion Speaker for LR-600 and LR-100



LA-361
High Capacity AA Alkaline Batteries (2)



LA-362
Rechargeable AA NiMH Batteries (2)





Listen Technologies Corporation
14912 Heritagecrest Way
Salt Lake City, Utah 84065-4818, U.S.A.
801.233.8992
800.330.0891 North America
801.233.8995 fax

www.listentech.com

Printed in the United States of America

© 2007 Listen Technologies Corporation® All Rights Reserved 40907