

4Ch Real time / Triplex / Mux

CCT716 DVR



**4 Channel Stand Alone DVR
USB Backup available**

CD-WRITER

NETWORKABLE

VGA MONITOR CONNECTION

PTZ CONTROL

User's Manual VER 1.2

The most stable and reliable real stand alone Digital Video Multiplex Recorder

INSTALLATION & SAFEGUARDS

All the safety and operating instructions should be read before the unit is operated.

Installation

1. To prevent electric shock or other hazards, do not expose units to rain, moisture or dust.
2. Place this unit in a well-ventilated place and do not place heat-generating objects on the unit.
3. This unit should not be located in an area where it is likely to be subjected to vibration.

Before You Start



1. Ensure the power switch is in the OFF position prior to starting.
2. Do not attempt to open or remove the covers. This may expose you to dangerous voltage or other hazards.
3. Installation should be performed by a qualified service person only.
4. This unit should be operated only from the type of power source indicated on the manufacturer's label and with the power supply included with the unit.

Notice



1. If you need to change the TIME/DATE always clear the HDD. If you don't follow this step first, it may cause non recording on the HDD or inhibit the use of menu settings . Even though it may appear to be recording, you may find you cannot search recorded data.
2. When it comes to HDD capacity, you can use large capacity HDDs.
3. The jumper setting for the CD-RW must be master.
4. When you set the record setup, you have to set the Record Configuration and also Schedule Setup. This unit records as per the Record type & Schedule setup. The default setting value for Schedule setup is Continuous mode.

Contents

| | | | |
|----------------|--|-------|-----------|
| CHAP. 1 | Features & Package Contents | ----- | 4 |
| 1-1. | Features | ----- | 4 |
| 1-2. | Package Contents | ----- | 5 |
| CHAP. 2 | Function of Each Button | ----- | 6 |
| 2-1. | Front | ----- | 6 |
| 2-2. | Rear | ----- | 7 |
| CHAP. 3 | Installation | ----- | 8 |
| 3-1. | Installation Configuration | ----- | 8 |
| 3-2. | Detailed Installation | ----- | 9 |
| 1) | HDD(Hard Disk Drive) | ----- | 9 |
| 2) | Camera | ----- | 9 |
| 3) | Monitor | ----- | 10 |
| 4) | Power | ----- | 10 |
| 5) | Other External Device | ----- | 11 |
| 6) | RS-232 ASCII-Code | ----- | 11 |
| CHAP. 4 | Operation | ----- | 12 |
| 4-1. | System Log In | ----- | 12 |
| 4-2. | Factory Default | ----- | 12 |
| 4-3. | Display Configuration | ----- | 13 |
| 4-4. | Live View Setup | ----- | 14 |
| 1) | Full / Multiple View | ----- | 14 |
| 2) | SEQ | ----- | 14 |
| 3) | PIP View | ----- | 14 |
| 4) | ZOOM View | ----- | 14 |
| 4-5. | Record | ----- | 15 |
| 4-6. | Playback | ----- | 15 |
| 4-7. | Search | ----- | 16 |
| 4-8. | PTZ Camera Operation | ----- | 17 |
| 4-9. | Data Back-up | ----- | 17 |

| | | | |
|----------------|-------------------------|--------------|-----------|
| CHAP. 5 | Set up | ----- | 18 |
| 5-1. | General Operation | ----- | 18 |
| 5-2. | Display Setup | ----- | 19 |
| 1) | VGA Setup | ----- | 19 |
| 2) | Screen Display Setup | ----- | 19 |
| 3) | OSD Setup | ----- | 20 |
| 5-3. | Record | ----- | 21 |
| 1) | Record Setup | ----- | 21 |
| 2) | Schedule Setup | ----- | 22 |
| 5-4. | Configuration | ----- | 23 |
| 1) | HDD Management | ----- | 23 |
| 2) | Time/Date Setup | ----- | 24 |
| 3) | Camera Setup | ----- | 24 |
| 4) | Motion Setup | ----- | 25 |
| 5) | Interval Setup | ----- | 26 |
| 6) | Alarm Setup | ----- | 26 |
| 7) | Password Setup | ----- | 26 |
| 5-5. | External Device Setup | ----- | 27 |
| 1) | TCP/IP Setup | ----- | 27 |
| 2) | Pan Tilt Zoom Setup | ----- | 28 |
| 3) | Spot Setup | ----- | 28 |
| 5-6. | Back up | ----- | 29 |
| 1) | CDR Setup | ----- | 29 |
| 2) | USB Setup | ----- | 29 |
| 5-7. | Firmware Upgrade | ----- | 30 |
| CHAP. 6 | Network Setup | ----- | 31 |
| 6-1. | Network Configuration | ----- | 31 |
| 6-2. | Remote Viewer Program | ----- | 32 |
| 6-3. | Backup CD Player | ----- | 37 |
| CHAP. 7 | Web Viewer Setup | ----- | 39 |
| 7-1. | Web Viewer | ----- | 39 |
| 7-2. | Web Backup Player | ----- | 40 |
| CHAP. 8 | Specifications | ----- | 42 |
| 8.1. | Specifications | ----- | 42 |
| 8.2 | Record Timetable | ----- | 43 |

CHAP 1. Features & Package Contents

1-1. Features

Live Display

Real time display per camera
Auto Sequence
PIP (Picture in picture)
Digital Zoom
Simple playback mode
Simple PTZ camera control

Record

Variable Record resolution (For higher picture quality or higher recording speed)
Efficient Image Quality setting in 5 steps
Schedule recording
Event Record by alarm and motion detection

Network

Monitoring and Search using Remote Viewer via network

Playback

Search and playback by recorded data size and date/time

Various steps in forward playback speed (X2, X4, X8, X16, X32 fast playback. 1/16, 1/8, 1/4, 1/2 slow playback)

Various steps in backward playback speed (X2, X4, X8, X16, X32 fast playback. 1/16, 1/8, 1/4, 1/2 slow playback)

Data backup

Simple backup using CD-RW
Remote viewer backup in AVI and JPEG file formats
Supports large capacity Hard Drives
USB Back-Up Device

Others

Supports UNI-CODE
Supports SPOT Monitor
PAL/NTSC Auto detection

1-2. Package Contents

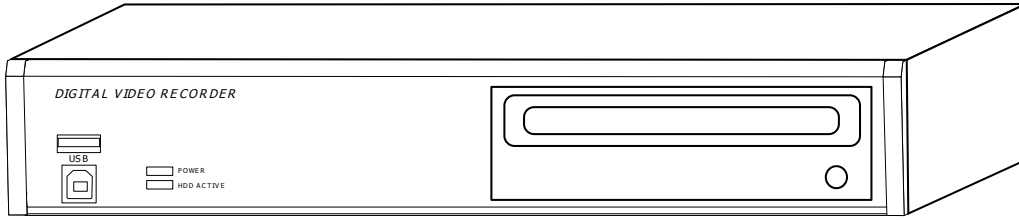

1. DVR Main Unit

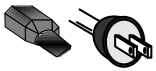

2. Power Cable

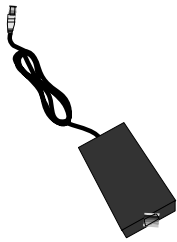

3. Power Adapter

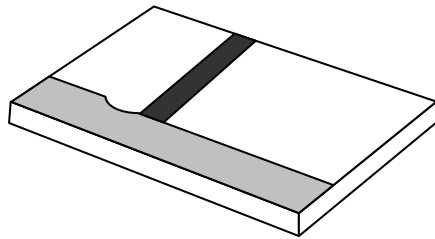

4. User's Manual



5. Software CD

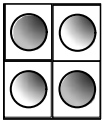

6. Rubber Pad

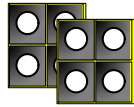

7. HDD absorber



8. Bolts



9. Mouse

| Package Contents | Description |
|------------------|---|
| 1. DVR Main Unit | Stand-Alone Digital Video Recorder |
| 2. Power Cable | AC power supply to adapters for 12V DC power |
| 3. Power Adapter | DC power supply |
| 4. User's Manual | User's Manual |
| 5. Software CD | Remote Viewer Software & Backup CD Player |
| 6. Rubber Pad | Prevent DVR from slipping. Attach it to the bottom of main unit |
| 7. HDD absorber | Absorbing the mechanical shock of HDD against the case bottom |
| 8. Bolts | Bolts for fixing HDD |
| 9. Mouse | A mouse controlling all functions of DVR |

CHAP 2. Function of Each Button

2-1. Front

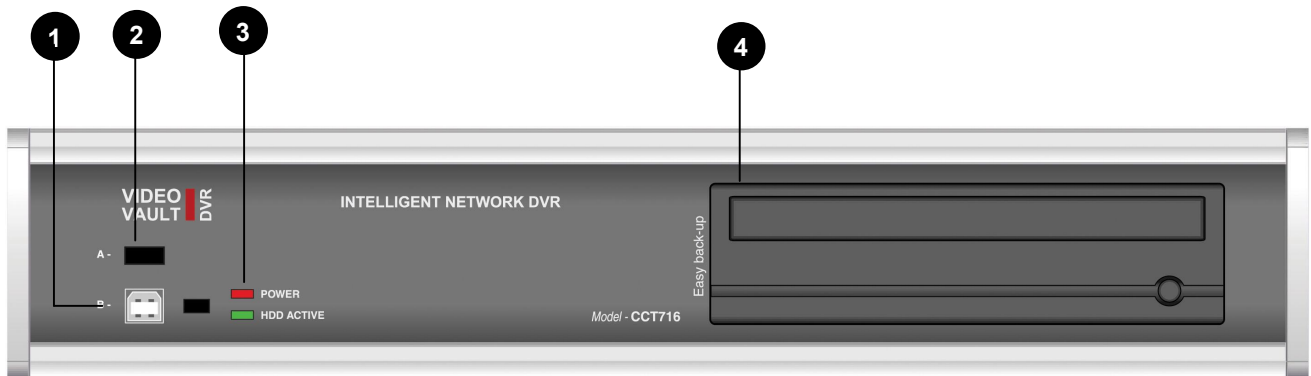

| Name | Function |
|---------------|---|
| 1. USB Device | Used for updating Firmware |
| 2. USB HOST | Used for Data Backup |
| 3. LED Lamps | Shows status of operation |
| 4. CD – RW | Used for Data Backup and Firmware upgrade |

2-2. Rear

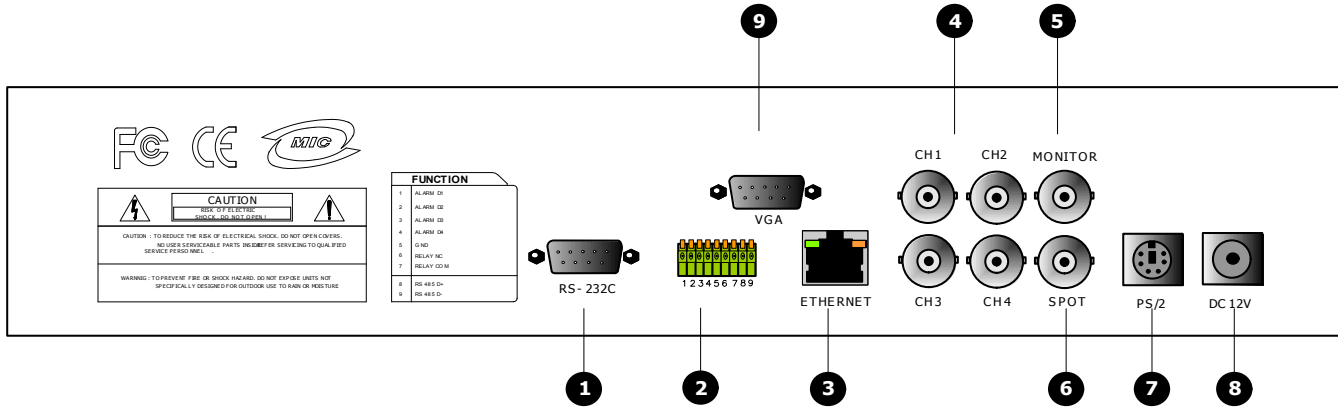

| | Name | Function |
|---|---------------------|--|
| 1 | RS 485 | Connection with PTZ camera or other external device using RS 485 interface |
| | RELAY Output | Relay out terminal |
| | SENSOR Input | Sensor input terminal |
| 2 | RS-232C | Connection to allow control by PC (Not supported) |
| 3 | ETHERNET | Connection to ETHERNET device |
| 4 | CAMERA Input | Connection with camera (NTSC / PAL) |
| 5 | MONITOR Output | Connection with Composite Monitor (NTSC / PAL) |
| 6 | SPOT Monitor Output | Connection with Composite Monitor (NTSC / PAL) |
| 7 | PS/2 | Connection with PS/2 MOUSE |
| 8 | DC Power | DC over 12V adapter |
| 9 | VGA | Connection to VGA Monitor (CRT type or TFT LCD monitor) |

CHAP.3 Installation

3-1. Installation Configuration

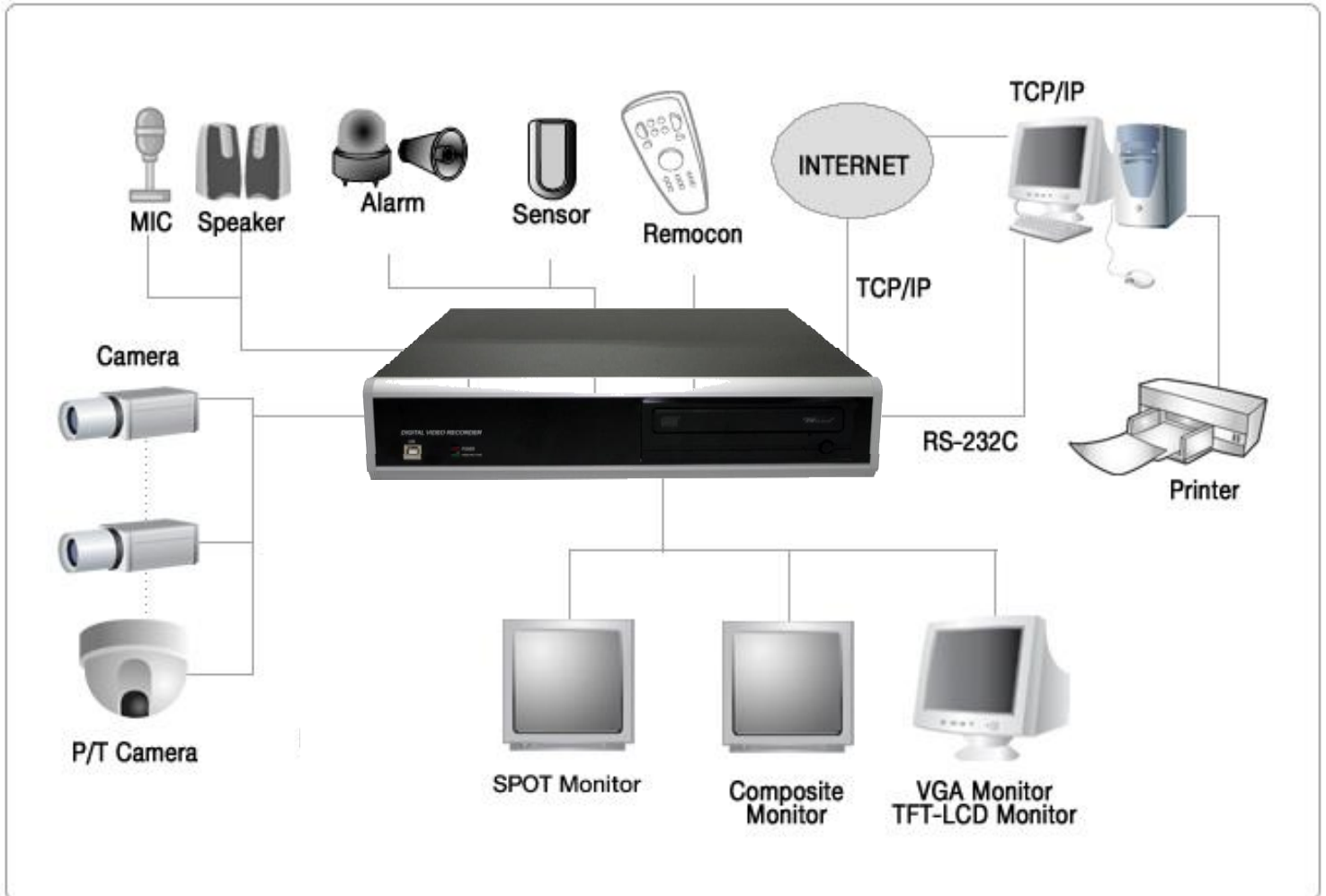

3-2. Detailed Installation

1) HDD

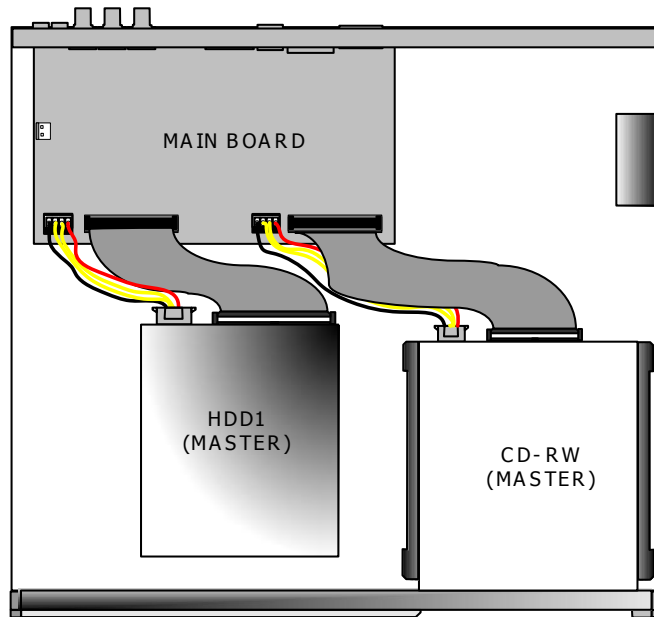

1. Connect Main Board and HDD1 using IDE cable and HDD power cable.
2. The jumper setting of HDD should be on Master when you install HDD.
3. Stick the HDD absorber (included in package) on the bottom of case and then install the HDD on top of them by using the bolts (included in package).
4. Screws must be inserted from outside of the case bottom.

2) Camera

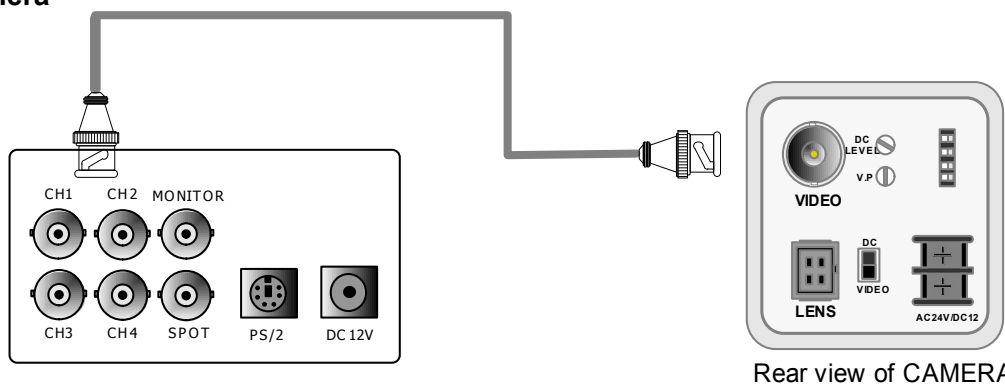

Connect camera to the camera input on rear panel of DVR marked CAMERA IN.

3) Monitor

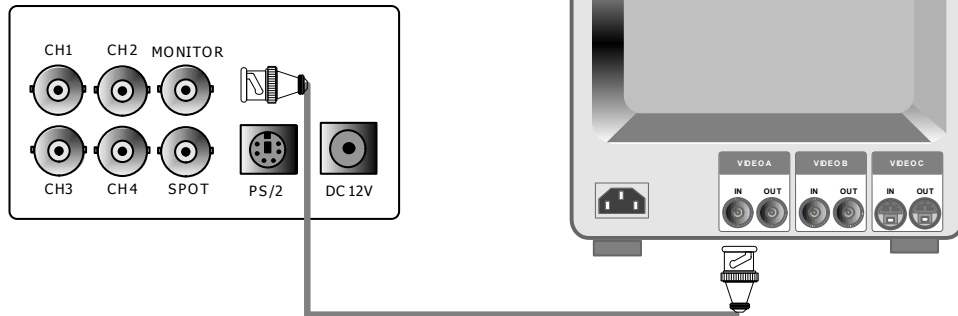

Connect the video output marked MONITOR to Video-In of Main monitor.

4) Power

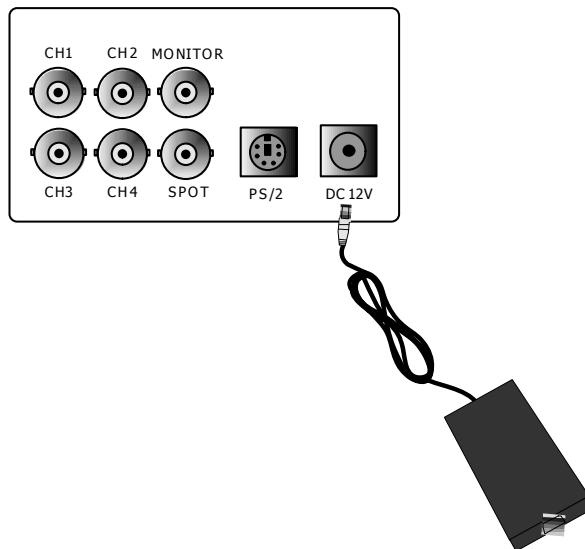

12V DC power adapter

5) Other External Device

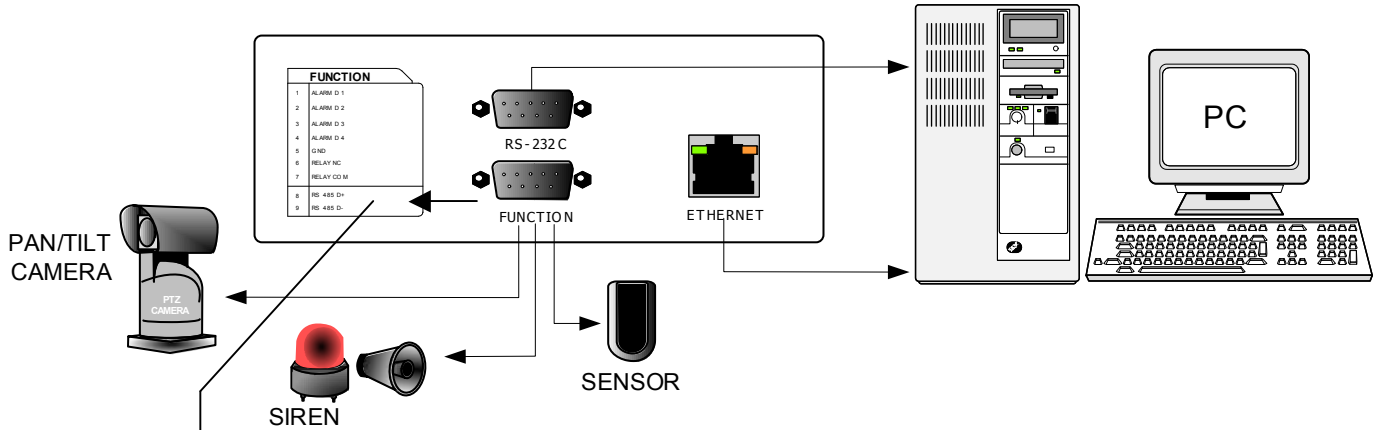

RS-485 : Control external device like PTZ camera.
(Pin No.8 & No.9 at D-SUB).

RELAY Output : Relay Output (Pin No.6 & No.7 at D-SUB).

SENSOR Input : Sensor Input – Alarm Input (Pin No.1 ~ No.4 at D-SUB).

ETHERNET : Connection to LAN, WAN t.

| | | | |
|----|----------|----|-----------|
| 1. | ALARM 01 | 7. | RELAY COM |
| 2. | ALARM 02 | 8. | RS485D + |
| 3. | ALARM 03 | 9. | RS485D - |
| 4. | ALARM 04 | | |
| 5. | GROUND | | |
| 6. | RELAY NC | | |

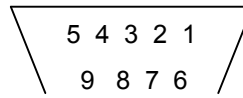

6) RS-232C ASCII-code

Following ASCII-Codes (Hexa-Code) are for programmers who want to control DVR unit via the RS232C Port using keyboard of PC. ASCII-Code is 1 Byte.

| | | | | | | | |
|-------|-----|-------|------|------|-----|-----|-----|
| 녹화 | 'R' | DOWN | 'J' | PTZ | 'T' | CH1 | '1' |
| STOP | 'S' | LEFT | 'H' | ZOOM | 'Z' | CH2 | '2' |
| 재생 | 'P' | RIGHT | 'K' | FRZ | 'F' | CH3 | '3' |
| Pause | 'A' | NEXT | 'N' | MODE | 'D' | CH4 | '4' |
| SERCH | 'E' | ENTER | 0x0d | PIP | 'I' | | |
| MENU | 'M' | - | '<' | SEQ | 'Q' | | |
| UP | 'U' | + | '>' | | | | |

NOTE: Whilst RS-232C is available this is not supported for technical advice.

4-1. System Log-In

- 1) Move a cursor to lower right hand corner of display by using a mouse, then you will see 'Menu' Icon. Click the 'Menu' Icon to log in.
- 2) Then, you will see 'DVR Log-In' message shown right.
- 3) You may log in as a ADMIN, MANAGER, or USER1 ~ USER8.
- 4) Input your password (Max. 8 digits are available for password)
- 5) To exit, click 'EXIT' button.

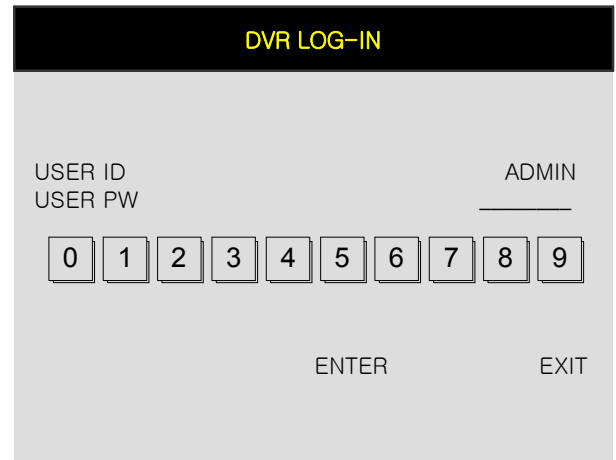

If the password entered matches previously set password, you can log into 'MAIN MENU'. If an incorrect password is entered, you will see "PW IS NOT CORRECT" message on display. The factory default password is none. Just click [ENTER] for first time initial log in.

-Factory default password
ADMIN : (Blank)

For security reasons, be sure to make note of your own password.

4-2. Factory Default

Before first operation, you must check out each channel is displaying properly and log in 'Main Menu' and set Time/Date and set HDD clear.

1. HDD Management

HDD MANAGEMENT
CAMERA SETUP
MOTION SETUP
ALARM SETUP
INTERVAL SETUP
TIME/DATE SETUP
PASSWORD SETUP

MODEL
SERIAL
BLOCKS
SIZE
SPEED

OVERWRITE

CLEAR ESC

4-3. Display Configuration

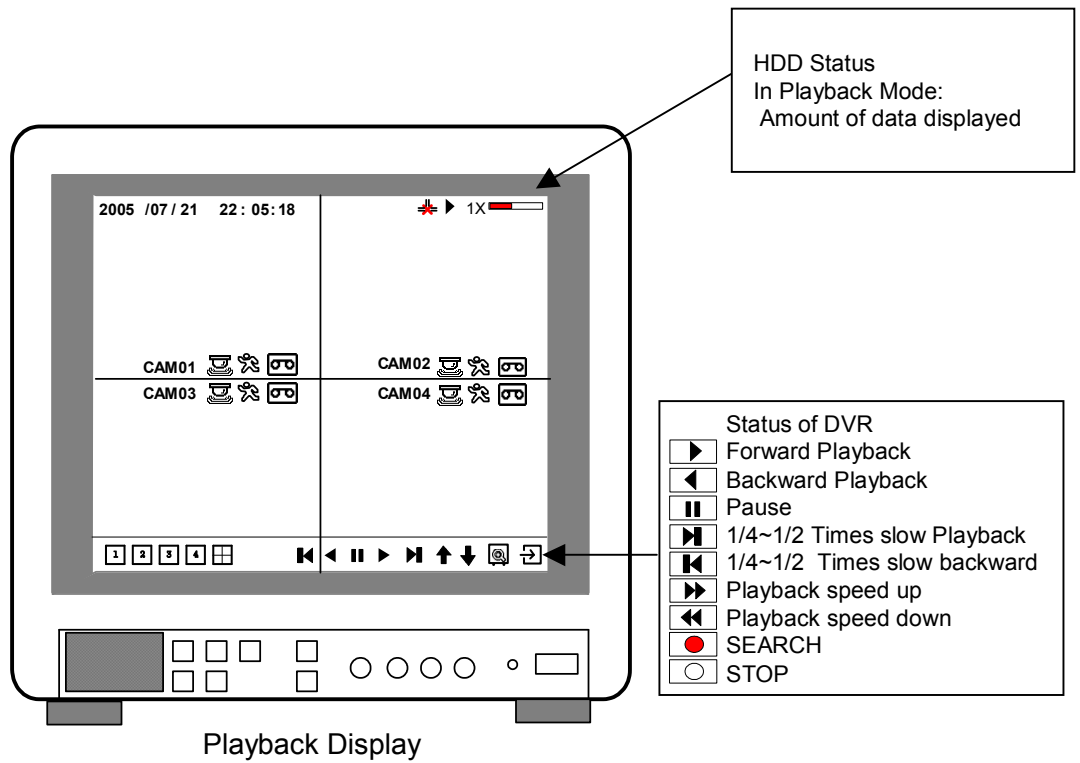
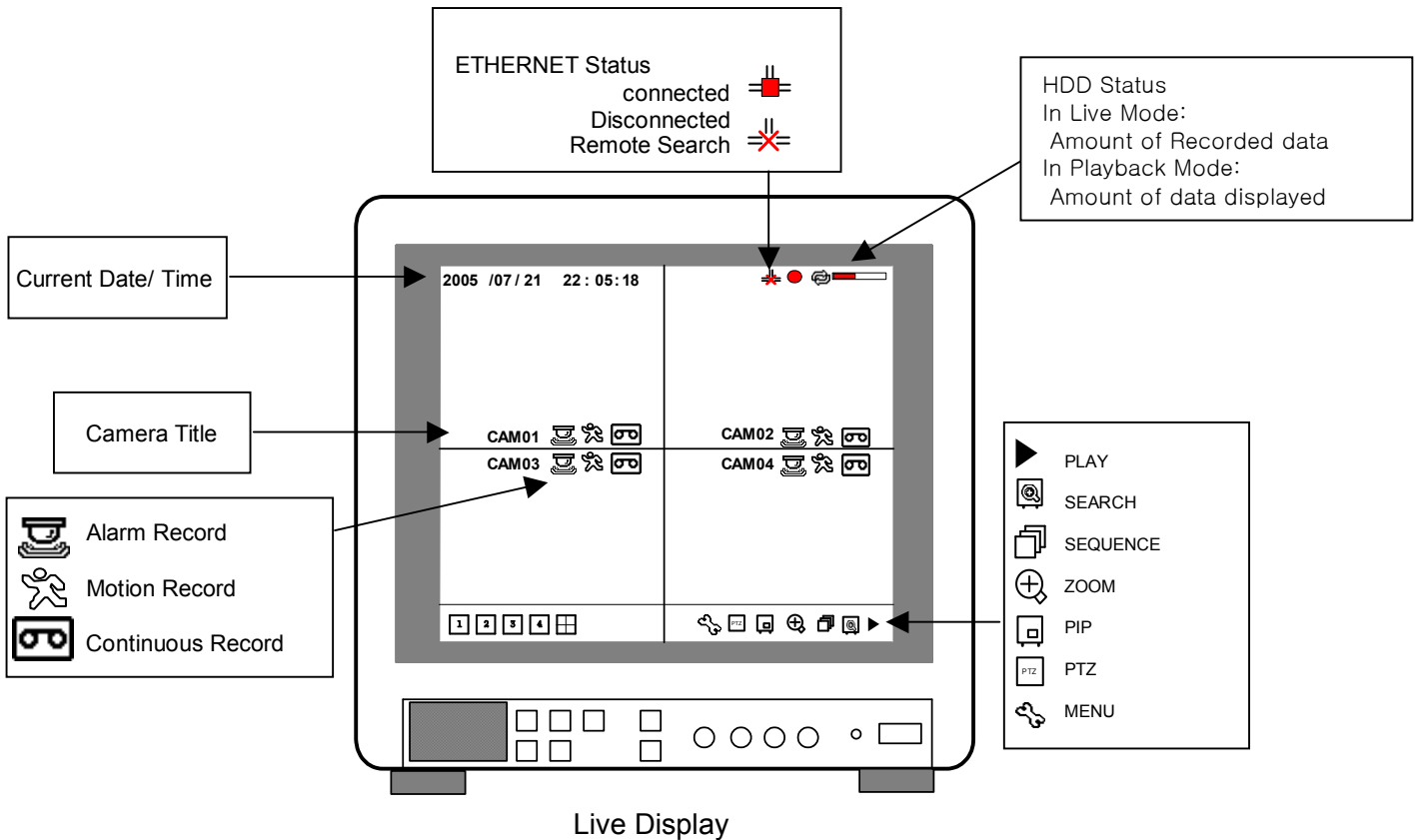

4-4. Live View Setup

1) Full / Multiple View

Move cursor to 'split icon' on the lower left corner of display and click it to view quad mode. To enlarge each channel, click 1,2,3,4 Icon. Then, you will see channel in full screen mode.



2) SEQ

Click 'SEQ' icon. It automatically displays full screen images in sequence. You can setup SEQ time interval on setup menu. (SCREEN SETUP – SEQUENCE INTERVAL)

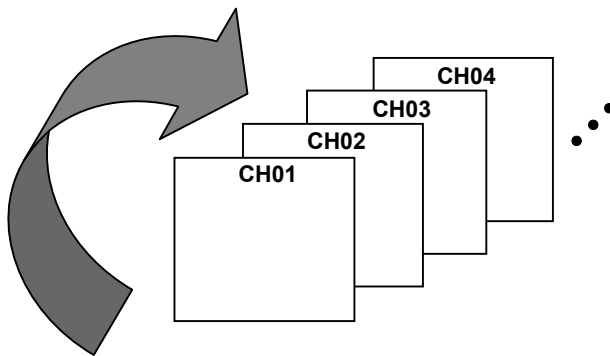

3) Picture in Picture (PIP View)

When it is in full screen display mode, you can see other camera in a small window by clicking [PIP] icon, The other camera in small window is rotating in sequence to next number of camera and you can set the rotating time interval as per the procedure in Main Menu – SCREEN SETUP – PIP INTERVAL.

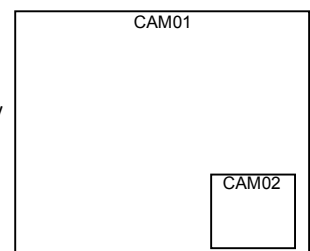

4) ZOOM View



In live mode, if you click [ZOOM] icon, images are displayed twice normal size. While using [ZOOM] mode, you can move the enlargement area by using a mouse. To exit ZOOM mode, click [ZOOM] icon again.

4-5. Record

It records as a setting made by a user in Schedule Mode.

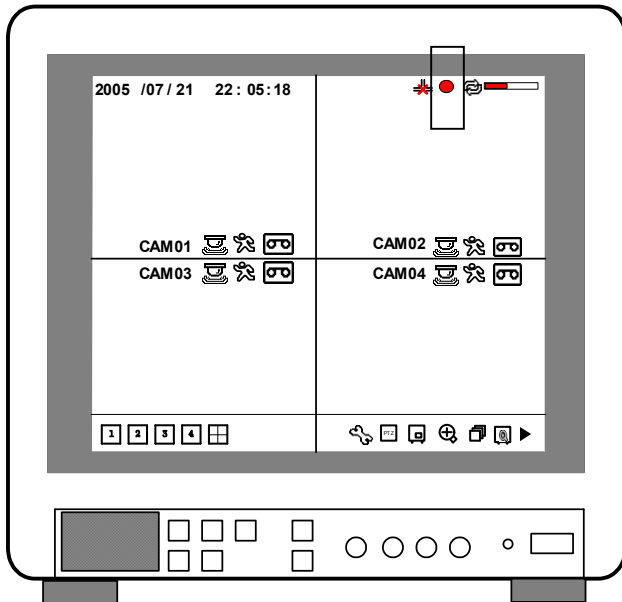
- Schedule Record
Go to MAIN MENU-SCHEDULE SETUP and setup schedule as you want. It records as a setting.
- Record Icon in Red indicates Schedule Record, Motion record, and alarm record.



-  Record [RED]
-  Stop recording [WHITE]

- This DVR unit does not record in following conditions ;
When Overwrite function is off and the HDD is full
When you backup recorded images during CDRW burning.
When you update the firmware
When you are in HDD Management menu mode

4-6. Playback

1. In record mode or stop mode, click [click] to play the recorded data in 1x speed.
2. How to use a mouse
Left button mouse is used for all commands in the menu.
You can adjust playback speed by moving the mouse wheel button up and down.

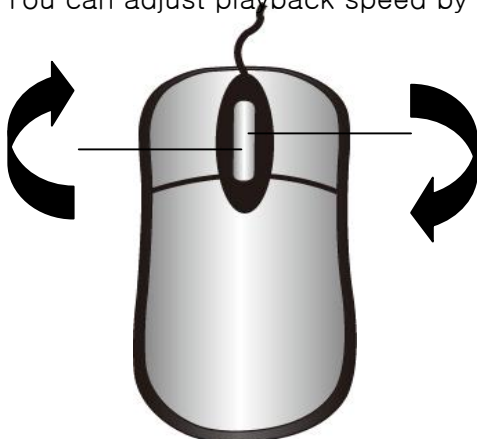

- 1/16x:16 times slower than normal playback speed.
- 1/8x : 8 times slower than normal playback speed.
- 1/4x : 4 times slower than normal playback speed.
- 1/2x : 2 times slower than normal playback speed.
- 1x : Normal playback speed
- 2x : 2 times faster than normal playback speed..
- 4x : 4 times faster than normal playback speed.
- 8x : 8 times faster than normal playback speed.
- 16x :16 times faster than normal playback speed.
- 32x :32 times faster than normal playback speed.

4-7. SEARCH

There are three search methods controlled by the mouse wheel control or left and right mouse button.

When you click the [SEARCH] icon, you see a window shown below.

Select target data by selecting one of the search modes.

In PERCENT SEARCH Mode, you can select data by clicking on the bar.

To move to the previous mode, click 'ESC'.

1. PERCENT SEARCH

Search by percentage of total recorded data. It starts from image corresponding to set % of data

on the search bar.

2. TIME/DATE SEARCH

Search by time & date. Playback starts from the time & date selected.

3. EVENT SEARCH

Search by event list (Motion, Alarm, Video Loss)

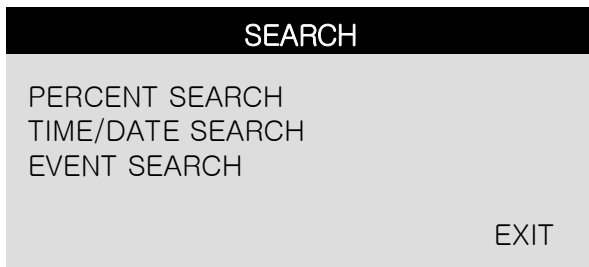

SEARCH MAIN MENU

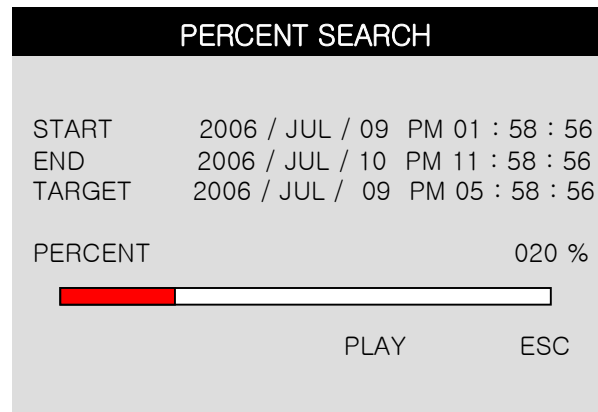

PERCENT SEARCH



TIME/DATE SEARCH

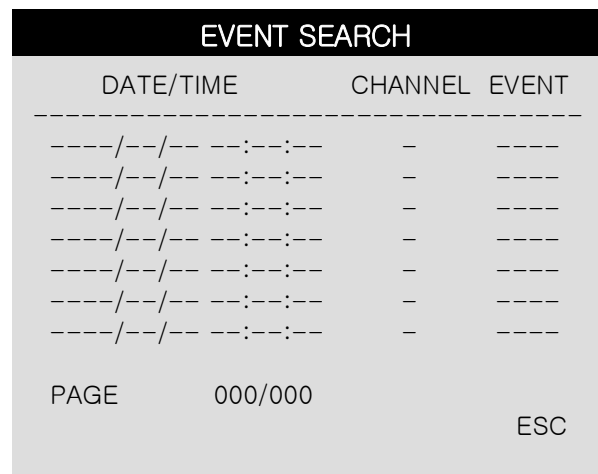

EVENT SEARCH

4-8. PAN/TILT/ZOOM Camera Operation

Click [PTZ] icon to control a PTZ camera. PAN/TILT is controlled by Left & Right buttons and Zoom In & Out is controlled by the mouse wheel. You can control a PTZ camera in 8 different directions as shown below.

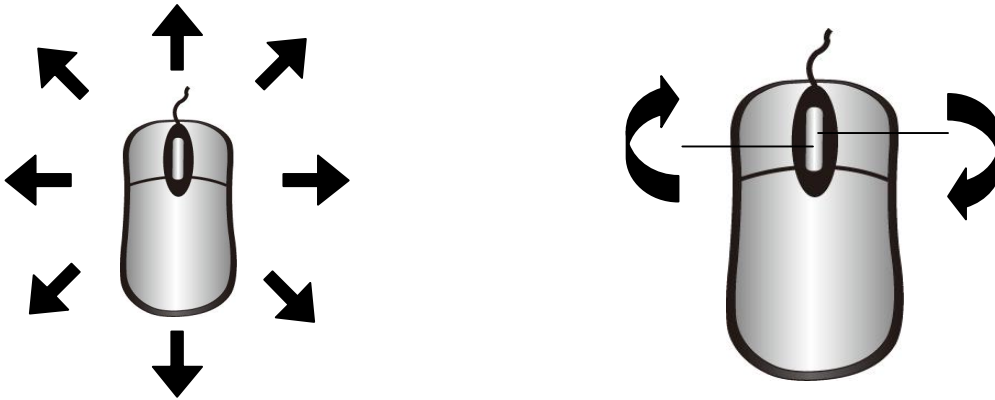

4-9. Data Backup

Click [MENU] icon first.

1. Insert empty CD-R media into CD writer and select the start time & date from which you want to back up.
The START & END time / date in HDD sub-menu shows start and end range of recordings. This is not selectable or editable.
2. To set start time of back-up and back-up data size of CD-R media inserted, use a mouse. End of back-up time will be calculated automatically as per start time & date and the back-up data size you set. You can select the back-up data size (size of back-up data from start of back-up), but END of back-up time is automatically determined by DVR itself.
3. Click 'BURN' to commence burning a CD.
4. When burning is complete, CD-R media will eject automatically. For a continuing backup, the next CD back-up should specify the end time of the previous backup as the start time of the subsequent backup.
If you need another back-up, repeat the above procedure. To stop backup, click 'ESC'.
While you are burning a CD, it is impossible to cancel the burning process.
During burning process, DVR does not record.
5. You can verify the back-up CD and install the Backup CD Player on your PC to view the backup data.

| BACK-UP | |
|---------------------------|------------------------|
| HDD | |
| START | 2006/JUL/08 AM10:10:23 |
| END | 2006/JUL/09 AM08:12:23 |
| CD-R | |
| START | 2006/JUL/08 PM12:04:12 |
| END | 2006/JUL/08 PM08:12:23 |
| SIZE | 700MB -> 0MB |
| BURN ESC | |

| BACK-UP | |
|--|-------------------------|
| HDD | |
| START | 2006/JUL/08 PM 12:04:12 |
| END | 2006/JUL/08 PM 08:12:23 |
| CD-R | |
| START | 2005/AUG/07 AM04:04:12 |
| END | 2005/AUG/08 PM08:12:23 |
| SIZE | 700 MB -> 700MB |
|  | |
| BURN ESC | |

CHAP. 5 Set up

5-1. General Operation

Click [MENU] icon and input user password to log in.

| Mouse buttons | Functions |
|---------------|---|
| Mouse Wheel | Up and down for selecting menu Menu mode options Up and down for selecting Playback speed Zoom in and out in PAN/TILT/ZOOM mode |
| Right | Decrease the value in Menu option |
| Left | Increase the value in Menu option Execute functions by clicking icons |

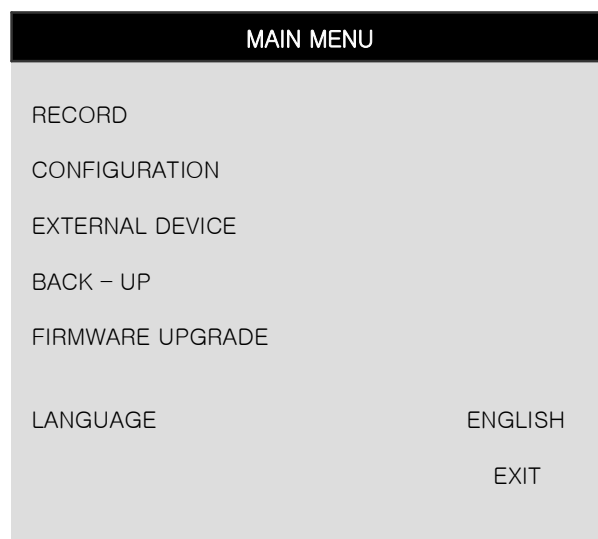

MAIN MENU

5-2. DISPLAY SETUP

This is setup menu for the screen display.

If you click 'DISPLAY SETUP' you can change display values as shown below.

| DISPLAY SETUP | |
|----------------|-----|
| VGA SETUP | |
| SCREEN DISPLAY | |
| OSD SETUP | |
| | ESC |

1) VGA SETUP

| VGA SETUP | |
|------------|------------------|
| RESOLUTION | 800 X 600 / 75Hz |
| | DEFAULT ESC |

VGA SETUP : Connection to a VGA monitor (CRT/TFT LCD), if optional VGA board is fixed on the main board.

You can set 'RESOLUTION' for VGA as shown below.

*If there is no VGA option board fixed on the main board or not detected correctly, it displays "No VGA BOARD"

| | |
|------------------|------------------|
| 640X480 / 60Hz | 640X480 / 75Hz |
| 800X600 / 60Hz | 800X600 / 75Hz |
| 1024X768 / 60Hz | 1024X768 / 75Hz |
| 1280X1224 / 60Hz | 1280X1024 / 75Hz |

2) SCREEN DISPLAY

| SCREEN DISPLAY | |
|---------------------|-------------|
| VERTICAL POSITION | 24 |
| HORIZONTAL POSITION | 00 |
| BOARDER ENABLE | ON |
| BOARDER WIDTH | 01 |
| BOARDER COLOR | GRAY |
| | DEFAULT ESC |

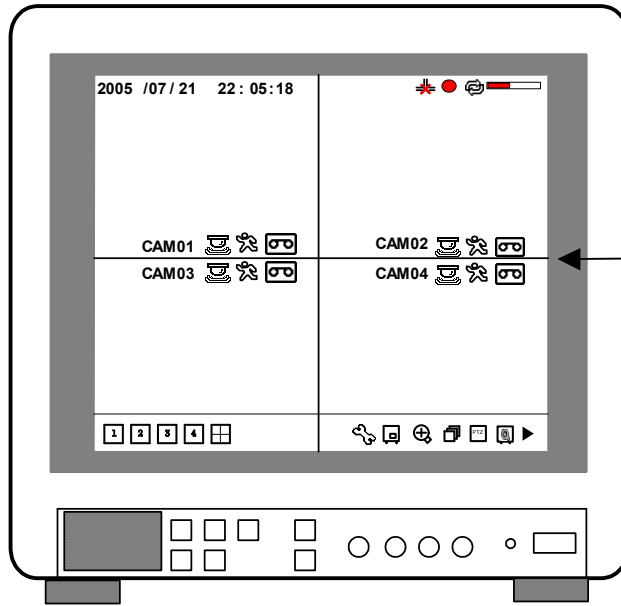

VERTICAL POSITION : 0 ~ 63
 HORIZONTAL POSITION : 0 ~ 63
 BORDER ENABLE : ON/OFF
 BORDER WIDTH : 1 ~ 10
 BORDER COLOR : COLOR SELECT

3) OSD SETUP

| OSD SETUP | |
|-------------------|-----|
| TOP OSD OFFSET | 0 |
| BOTTOM OSD OFFSET | 0 |
| DEFAULT | ESC |

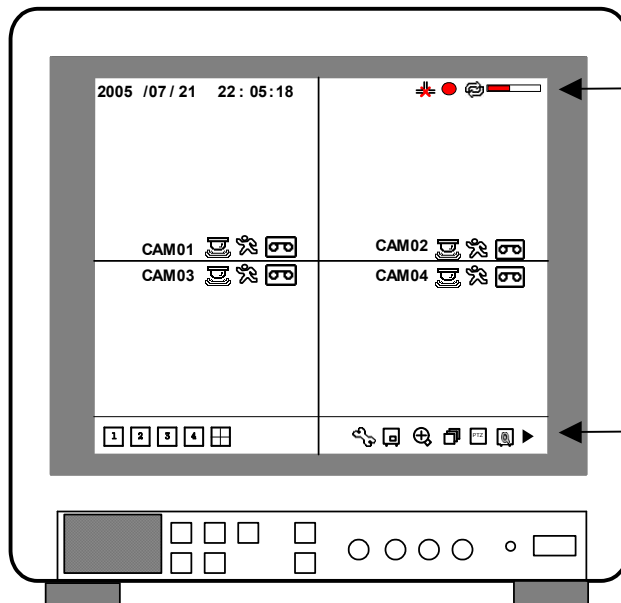

TOP OSD OFFSET : -10 ~ 9

BOTTOM OSD OFFSET : -10 ~ 9

5-3. RECORD

This is the most important configuration in the DVR. When you select 'RECORD SETUP' in the main menu, you can see the window as shown on the right.

1) RECORD SETUP

You can change setup values using a mouse.

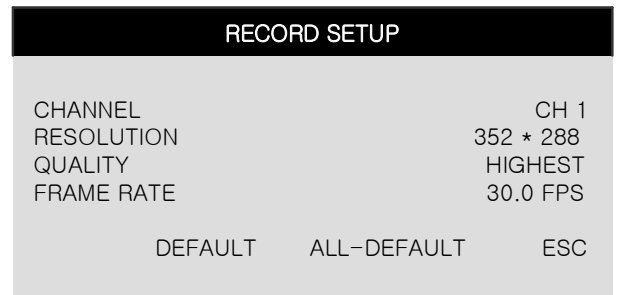
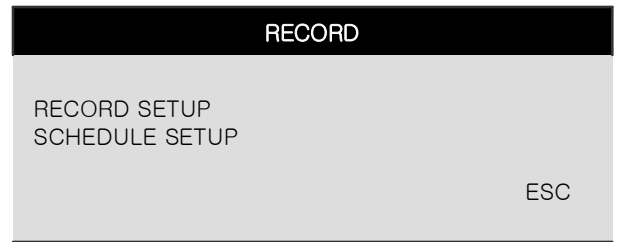

(1) CHANNEL : CHANNEL select

(2) RESOLUTION : Set recording resolution
 - 704x240(NTSC) , 704x288(PAL)
 - 352x240(NTSC) , 352x288(PAL) [DEFAULT]

(3) QUALITY : Set recording picture quality.
 (There are five quality steps)

- LOWEST
- LOW
- NORMAL [DEFAULT]
- HIGH
- HIGHEST

To send more images via IP network and longer recording time, set Quality at 'LOW' or 'NORMAL' and record at 352x288.

Data size of image in PAL system is a little bigger than NTSC system, but the total recording time is same as in NTSC system.

(4) FRAME RATE : Set FRAME
 1 ~ 30 FPS(NTSC) [DEFAULT 7.5 FPS]
 1 ~ 25 FPS(PAL) [DEFAULT 7.5 FPS]

2) SCHEDULE SETUP

Unless you selected other recording mode, DVR system records in Schedule Recording mode. In Schedule Recording mode, you set type of recording by 1 hour time interval. Default frame rate for continuous recording speed is 30 FPS.

Set Recording time interval for a day of the week and recording type (1 hour time interval)

The screenshot shows a window titled "SCHEDULE SETUP". At the top right, it says "CH 1 CONTINUE". Below this is a grid with days of the week (SUN, MON, TUE, WED, THU, FRI, SAT) on the vertical axis and hours (0-23) on the horizontal axis. Below the grid are four recording type options: C (with a checkbox), M (with a checkbox), A (with a checkbox), and M&A (with a checkbox). Below these are the labels "DEFAULT", "ALL - DEFAULT", and "ESC". At the bottom, there are labels for "DATE", "RED", "BLUE", "GREEN", and "YELLOW". An arrow points from the "ALL" button to the text "Click 'ALL' to set the same setting value 24 hours a day and 7 days a week." Another arrow points from the "CH 1 CONTINUE" area to the text "1 hour interval".

- TYPE : Set up Recording type
- CONTINUE: 24 hour recording
- ALARM: Alarm recording
- MOTION : motion recording
- MOTION & ALARM : Motion & Alarm recording

Each type is indicated in different coloured boxes. You can set up schedule by dragging a mouse and all blocks can be activated or deactivated by using 'ALL' button.

Default setting is continuous recording.

5-4. CONFIGURATION

When you click 'CONFIGURATION' on the main menu, you can go to 'CONFIGURATION' menu as shown on the right.

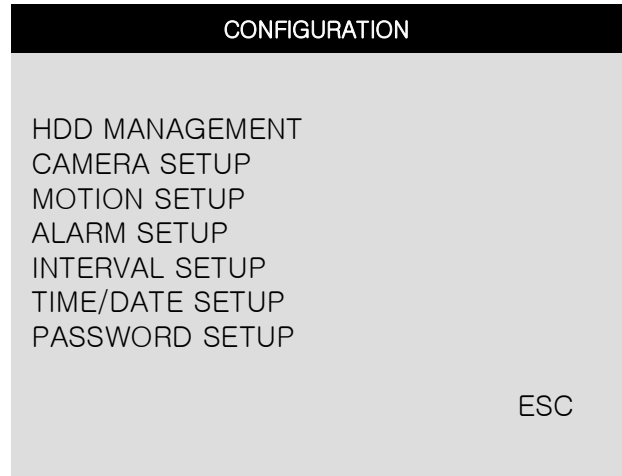

1) HDD MANAGEMENT

You can see HDD Model name, serial number, number of blocks and size of HDD. You can also clear HDD. (While you are in this HDD MANAGEMENT Mode, DVR does NOT record.)

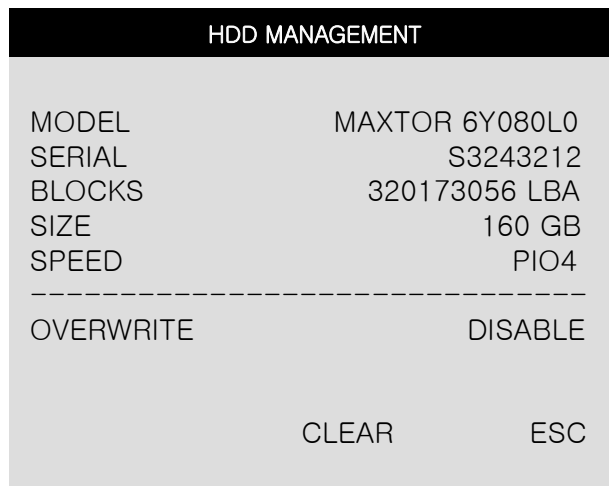

MODEL : HDD MODEL NAME
 SERIAL : HDD SERIAL No.
 BLOCKS : HDD LBA BLOCK Number
 SIZE : HDD TOTAL SIZE
 SPEED : HDD MODE
 OVERWRITE : ENABLE, DISABLE

2) TIME/DATE SETUP

In this setup, you can select date/time of DVR system and display format.

You can adjust values by using a mouse wheel or left/right button of the mouse.
For the first time installation, date/time setup must be completed first.

DATE FORMAT : DATE(ASIAN/EUROPEAN /AMERICAN)
HOUR FORMAT : (12H/24H)
MONTH FORMAT : (ENGLISH,NUMERIC)

| TIME/DATE SETUP | |
|----------------------|-------------|
| DATE | 2007/JUL/08 |
| TIME | 15:41 :45 |
| DATE FORMAT | |
| EUROPEAN HOUR FORMAT | |
| 24HOUR | |
| MONTH FORMAT | ENGLISH |
| | DEFAULT ESC |

3) CAMERA SETUP

You can setup values for each camera.

| CAMERA SETUP | |
|--------------|-----------------|
| CHANNEL | CH1 |
| TITLE | |
| CAM01__ | |
| BRIGHTNESS | 0 |
| CONTRAST | |
| 0 | |
| SATURATION | 0 |
| HUE | |
| 0 | |
| DEFAULT | ALL-DEFAULT ESC |

(1) CHANNEL : You can select a channel which you want to change values.

(2) TITLE : You can name each camera with an 8 digit field (numbers or letters combination).

Move a cursor onto a location that you want and choose numbers or letters by using mouse wheel or left/right button of mouse. To exit to the previous menu mode, click 'ESC'.

DEFAULT = CAM01__ ~ CAM03__

(3) COLOUR : You can adjust colour of image display of each camera by the mouse.

BRIGHTNESS : Adjusting brightness (-32 ~ + 31) [DEFAULT = 0]

CONTRAST : Adjusting contrast (-32 ~ + 31) [DEFAULT = 0]

SATURATION : Adjusting saturation (-32 ~ + 31) [DEFAULT = 0]

HUE : Adjusting hue (-32 ~ + 31) [DEFAULT = 0]

(4) Executing Buttons

ALL : Initialising all values for all channels as a default setting value.(CH1 ~ CH4)

DEFAULT : Initializing all values for the applied channel only as a default setting value.

ESC : Used to exit

4) MOTION SETUP

MOTION SETUP

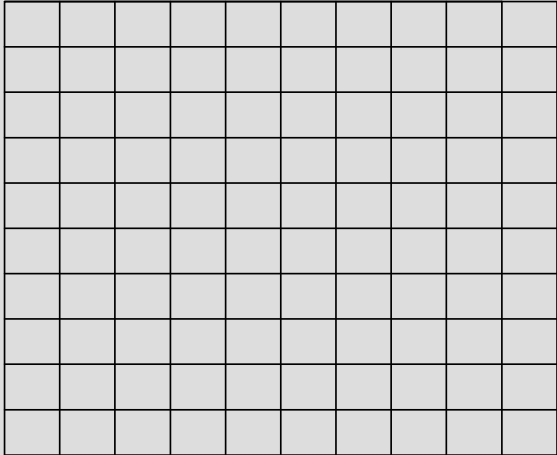
| | | |
|---|--------------------------|--|
| CHANNEL SENSITIVITY DURATION DETECT CELL NUM. | CH1 5 05 01 |  |
| DEFAULT | ALL-DEFAULT | ESC |

MOTION SETUP : You can change values using mouse wheel and left/right buttons of mouse.

- SENSITIVITY : Adjusting sensitivity of a movement. You can adjust level 1 ~ level 5. [DEFAULT : 1]
- DURATION : Whenever motion is detected and it is set in Motion Recording mode, the DVR records for a certain time being from the point of time when motion is detected. (1 sec.~99 sec.) [DEFAULT : 1 sec.]
- DETECT CELL NUM. : Select the minimum number of CELLS for MOTION EVENT to be activated.
- ALL-DEFAULT: Default setup for all channels

MOTION MASK SETUP : Set motion detection area.

- CELL : Move to the location which you don't want to detect and then click it by using left button. Motion is detected, when the cell is activated. Motion is not detected on non-activated cells.
- BLOCK ON : Select non detection area by block. (The blocked cells are non-activated area)
 By clicking left button and dragging a mouse, you can block the cells.
 The right button is used to delete the blocked cells.
 To save the setting value and exit, click 'ESC'.
- BLOCK OFF : Select detection area by using the right button of a mouse.
 The right button is used to delete the blocked cells.
 To save the setting value and exit, click 'ESC'.

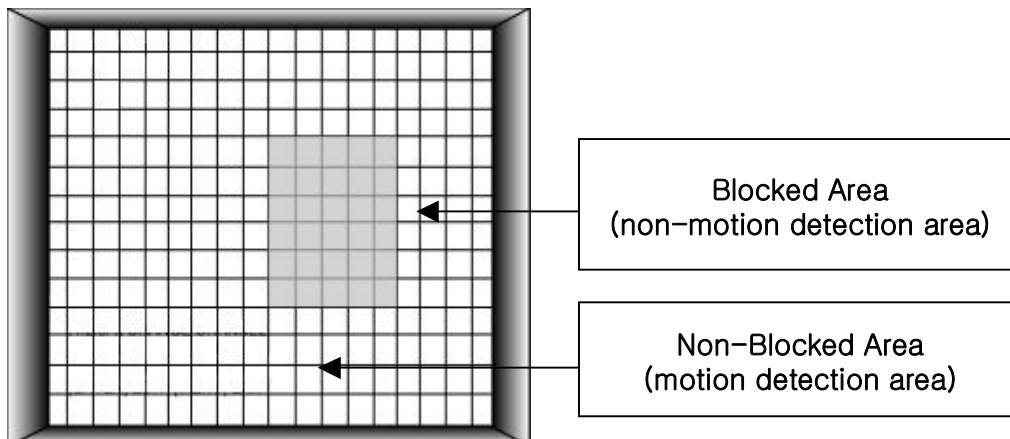

5) INTERVAL SETUP

See the switching time interval for SEQ or PIP function.
(1 sec. ~99 sec.)

SEQUENCE SCREEN :Set the sequencing time interval in live full screen mode

PIP SCREEN : Set the sequencing time interval of PIP window.

EVENT UPDATE : Set the minimum time interval of event to be listed on EVENT LIST.

If EVENT UPDATE time is set at 5 sec, only events lasting longer than 5 seconds are listed.

| INTERVAL SETUP | |
|-----------------|---------|
| SEQUENCE SCREEN | 01 SEC |
| PIP SCREEN | 01 SEC |
| EVENT UPDATE | 600 SEC |
| DEFAULT | ESC |

6) ALARM SETUP

Set type of alarm sensors connected to DVR unit.
N.O represents Normally Open type and N.C Normally Close type.

INPUT : Select NORMAL OPEN, NORMAL CLOSE, or DISABLE.
DISABLE represents not to use alarm sensor connected to DVR.

DURATION : Set the duration of alarm when an ALARM is activated. (0 sec. ~ 300 sec.)

| ALARM SETUP | |
|-------------|-------------|
| CHANNEL | CH1 |
| INPUT | DISABLE |
| DURATION | 01 SEC |
| ALL-DEFAULT | DEFAULT ESC |

7) PASSWORD SETUP

Set user ID and Password.
You can make up to an 8 digit number combination for a password by clicking number '0' ~ '9' in password setup menu.

To change password, you need to click 'USER PW' first to activate the menu.

You must input current password and then input new password.
And input again new password to confirm.

| PASSWORD SETUP | | | | | | | | | | | |
|--|-------|---|---|---|---|---|---|---|---|---|---|
| USER ID | ADMIN | | | | | | | | | | |
| USER PW | ----- | | | | | | | | | | |
| NEW PW | ----- | | | | | | | | | | |
| CONFIRM | ----- | | | | | | | | | | |
| <table border="1" style="width: 100%; text-align: center;"> <tr> <td>0</td><td>1</td><td>2</td><td>3</td><td>4</td><td>5</td><td>6</td><td>7</td><td>8</td><td>9</td> </tr> </table> | | 0 | 1 | 2 | 3 | 4 | 5 | 6 | 7 | 8 | 9 |
| 0 | 1 | 2 | 3 | 4 | 5 | 6 | 7 | 8 | 9 | | |
| ENTER ESC | | | | | | | | | | | |

Number selection for password

Changing the user Password is recommended for security purposes.

5-5. EXTERNAL DEVICE

Set parameters of external devices connected to DVR like Ethernet, PTZ camera, Spot monitor etc. If you click ETERNAL DEVICE on the main menu, then you will see the window shown on the right.

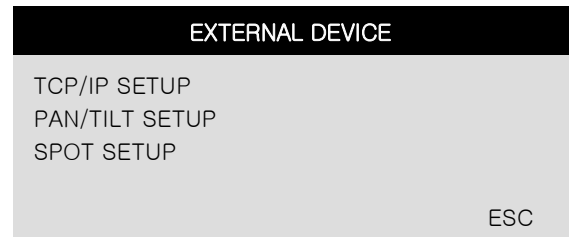

1) TCP/IP SETUP

TCP/IP function enables you to see live pictures and recorded pictures via internet.



(1) IP SETUP :

Shows the network information assigned to the DVR unit. If the DHCP setup status is AUTOMATIC, you can set the IP port only and if the DHCP setup status is MANUAL, you must set all parameters. If IP port number is blocked, a network specialist's advice is needed.

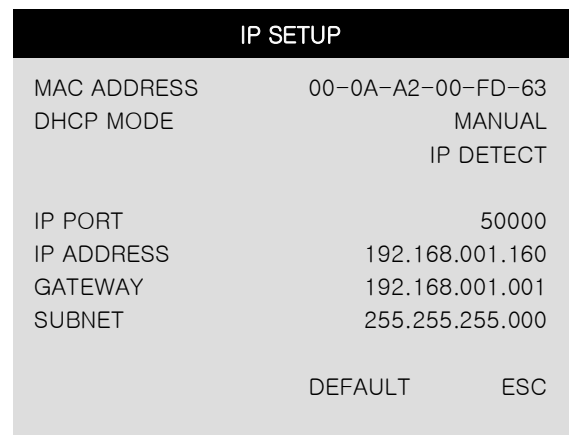

2) PAN/TILT SETUP

| PAN/TILT SETUP | |
|----------------|--------------------|
| COMMAND SETUP | ← PTZ Camera setup |
| SPEED SETUP | ← PTZ Speed setup |
| ESC | |

| COMMAND SETUP | |
|---------------|-----------------|
| CHANNEL | 01 |
| MODEL | PELCO-D |
| PTZ ID | 000 |
| BAUDRATE | 2400 BPS |
| CMD DELAY | 1 MSEC |
| COMMAND | PAN/TILT STOP |
| LENGTH | 16 |
| CODE | 00 00 00 00 |
| | 00 00 00 00 |
| | 00 00 00 00 |
| | 00 00 00 00 |
| DEFAULT | ALL-DEFAULT ESC |

| PAN/TILT SETUP | |
|----------------|---|
| PAN SPEED | 7 |
| TILT SPEED | 7 |
| ZOOM SPEED | 7 |
| FOCUS SPEED | 7 |
| DEFAULT ESC | |

- 1) CHANNEL : Select channel
- 2) MODEL : Select camera model (protocol type) per each channel
- 3) PTZ ID : Select PTZ ID (per each channel)
- 4) BAUDRATE : Select data transmission speed
- 5) CMD DELAY : Select command delay time

3) SPOT SETUP

| SPOT SETUP | |
|-----------------------|--------|
| SWITCH INTERVAL | 03 SEC |
| ALARM POP UP | ON |
| MOTION POP UP | ON |
| EVENT POP UP DURATION | 05 SEC |
| DEFAULT ESC | |

- (1) SWITCHING INTERVAL
Channel switching time (01 sec. ~ 99 sec.)
- (2) ALARM POP-UP
When ALARM is detected, the image of channel connected with Alarm sensor pops up.
Set ALARM detection pop-up (ON/OFF)
- (3) MOTION POP-UP
Set MOTION detection pop-up (ON/OFF)

EVENT POP-UP DURATION
Set EVENT POP-UP DURATION

If events (MOTION or ALARM) happen on several channels at the same time, channel No. 1 has the first priority to pop up. For example, if events happen on channel No. 1, channel No. 2, and channel No. 4 at the same time, channel No. 1 pops up. If the motion disappears on channel No. 1, then channel No. 2 pops up for the duration that you set. However, even though motion happens on channel No. 1 again within the duration, channel No. 2 still displays. If motion on channel No.1 keeps on going even after the duration, channel No. 1 pops up again.

5-6. BACK-UP

1) CDR SETUP

You can back up the recorded data to CD using CD writer installed in DVR. Refer to [START] and [END] of data on HDD and set copy from time, [START], and size of data copied, [SIZE], and move to BURN and click it to start copy.

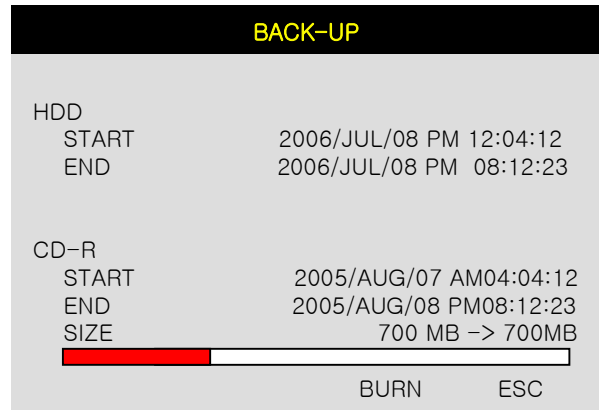
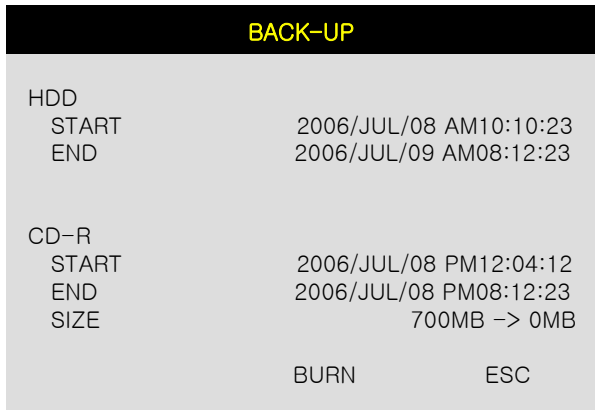

System Status Messages :

1. INPUT BLANK CD : CD writer has no blank CD.
2. CD-R MEDIA IS DETECTED : A blank CD-R media has been inserted and detected.
 CD-RW BURNING START
 CD-RW BURNING LEAD-IN
 CD-RW BURNING IMAGE DATA
 CD-RW BURNING CLOSE TRACK
 CD-RW BURNING COMPLETE
3. When burning is completed, CD-R media will be ejected automatically.
4. To copy more images, repeat above process. In the next back-up process, [START] time in CD-R sub-menu shall be [END] time in previous back-up, and you can copy images in series to as many CDs as many as you want.

2) USB SETUP

User can back up the recorded data to USB Media using USB (HOST) port on front panel of DVR. Refer to [START] and [END] of data on HDD and set start and end time of data to USB Media (Memory Stick or USB HDD). Select backup file size, and move to BACKUP and press [ENTER] Button to start copy.

USB HDD control only : Partition can be selectable by Ch button 1~4.

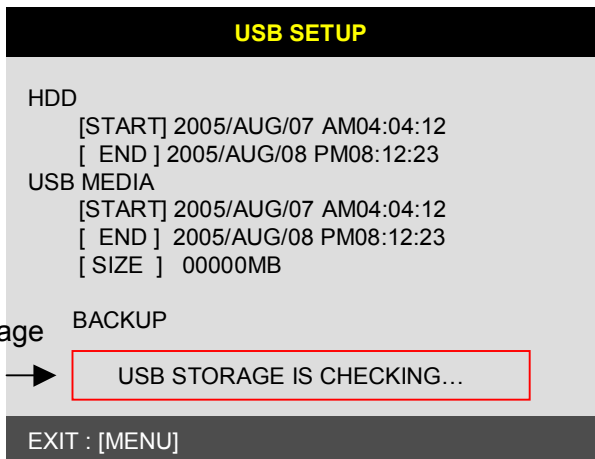

Status message

USB STORAGE IS CHECKING...

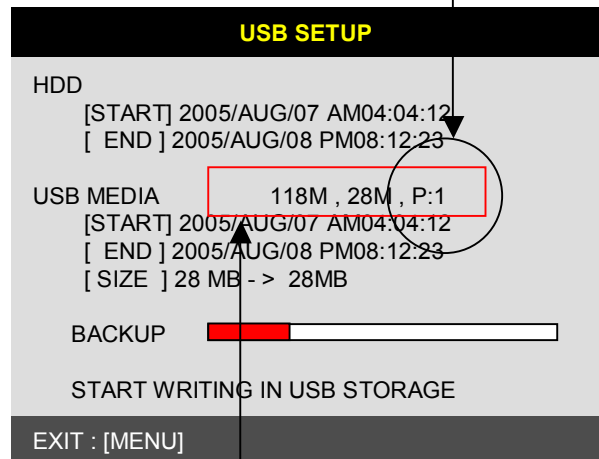

SIZE , FREE SPACE, PARTITION

System Status Messages

- (1) If MEMORY STICK is not inserted :
 - USB STORAGE IS CHECKING...
 - USB STORAGE IS NOT AVAILABLE
 - RE-CONNECT THE USB STORAGE
 - CONECT THE OTHER USB STORAGE
- (2) When MEMORY STICK or USB HDD is recognized
 - USB STORAGE IS CHECKING ...
 - THERE IS A FREE SPACE ON STORAGE
 - USB STORAGE IS AVAILABLE
- (3) During Back-Up
 - CHANGE WRITE PROTECT MODE
 - START WRITING IN USB STORAGE
 - FINISH WRITING IN USB STORAGE
- (4) Error Message
 - THERE IS A PROBLEM ON USB PORT (If USB PORT fails to work properly)
 - USB STORAGE IS FULL (When USB is full)
 - FILE SYSTEM IS NOT SUPPORTED (If File System is not supported)
 - SIZE IS LARGER THAN FREE SIZE (If back-up size is larger than free space)

Back-Up procedure is the same as CDR Back-Up.

If Back-Up size is larger than 2GB, it creates several files. (It saves in 2GB size files).

5-7. FIRMWARE UPGRADE

You can upgrade your DVR with new firmware by using the CD-RW.

Go to FIRMWARE UPGRADE menu and insert a CD containing new firmware.

First, you click 'CD-CHECK'. After finishing 'CD-CHECK', click 'UPGRADE'. After you see the message 'POWER OFF AND POWER ON' at the bottom, turn off and on your DVR unit to finish upgrading and restart the system.

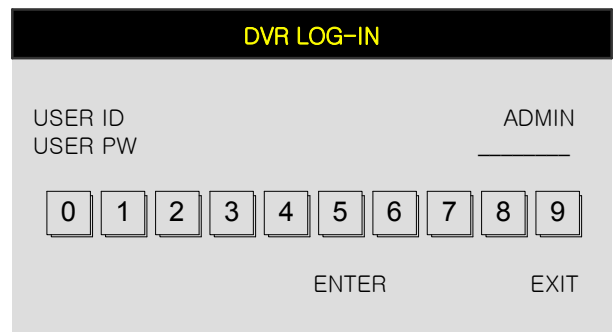
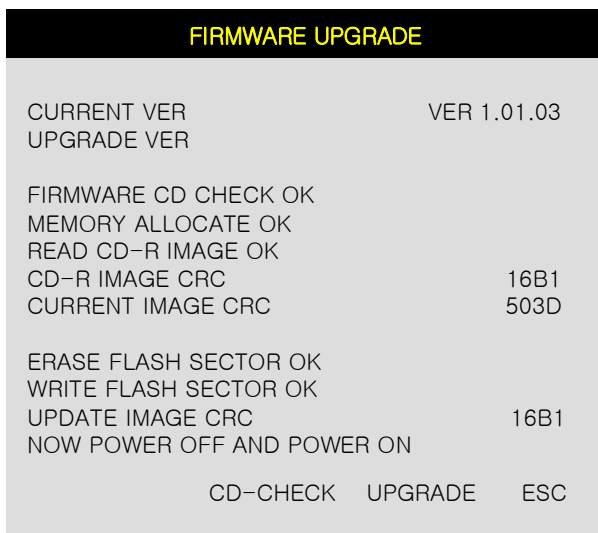

CHAP. 6 Network Setup

6-1. Network Configuration

Modem/Router

1. The first step is to establish the local IP address in the modem/router. Typically this may be 192.168.000.001 or 192.168.001.001 Refer to the instructions supplied with the modem/router. The local IP address for the NET800 ADSL modem/router is 192.168.001.001
Note that it is not necessary to enter leading zeros.

PC Setup

2. Now setup the IP address settings in the PC. The settings must be in the same range as the modem/router. The Subnet Mask defines the network range so if this is set at 255.255.255.000 in the router it means that for all units to be seen in this network, the first three levels of the IP address must be the same and the last level must be unique. Go into the Control Panel, Network Connections, LAN connections, properties and then highlight TCP/IP and click properties again. Now click "Set the following IP address."

| | |
|---|------------------------|
| IP Address | 192.168.001.100 |
| Subnet Mask | 255.255.255.000 |
| Gateway (The modem/router local IP address) | 192.168.001.001 |

Now exit.

DVR Setup

3. Now setup the IP address settings in the DVR. Again the settings must be in the same range as the modem/router. The Subnet Mask defines the network range so if this is set at 255.255.255.000 it means that for all units to be seen in this network, the first three levels of the IP address must be the same and the last level must be unique.

| | |
|---|------------------------|
| IP Address | 192.168.001.160 |
| Subnet Mask | 255.255.255.000 |
| Gateway (The modem/router local IP address) | 192.168.001.001 |

Exit & Reboot.

PC Remote Viewer Software Setup (Local Connection)

4. Load the Remote Viewer program to your PC. Press the Power button followed by the Setting button and ensure internal IP address of the DVR (e.g 192.168.001.160) is entered and the port number. Refer to IP/PORT Setting Screen. Press OK and then press CONNECT. If you can get the local connection to work you can then go to next step.

Modem/Router LAN/Internet Setup (STEPS 5 ~ 8 ARE FOR INTERNET CONNECTIVITY)

5. If you are using the NET800 ADSL modem/router then refer to the instruction booklet regarding configuring the modem/router. You will need to acquire a static IP address, username and password from your Internet Service Provider. When you have setup the WAN configuration and tested the Internet connection is working okay then proceed to the next step. If you are not using the NET800 product range then you must use refer to the instruction manual supplied with your modem/router.

Modem/Router Port Forwarding

6. Follow the instructions for the modem/router for setting client and firewall rules. This is to setup the firewall rule for external connectivity via the Internet. Ensure you save the modem/router settings correctly.

PC Remote Viewer Software Setup (External Connection)

7. Load the Remote Viewer program to your remote PC. Press the Power button followed by the Setting button and ensure **STATIC** IP address of the DVR is entered and the port number. Refer to IP/PORT Setting Screen. Press OK and then press CONNECT. You must

6-2. Remote Viewer program

MAIN INTERFACE

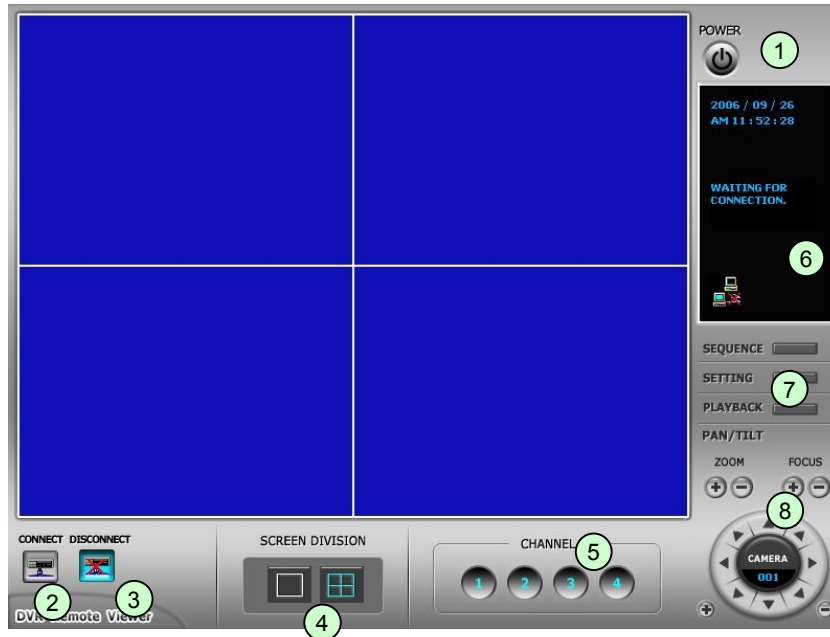

1. **Power button** : Press the Power switch to exit the program. Please press Disconnect before pressing the Power switch.
2. **Connect button** : Press the Connect button to view the live images from the DVR. These are the same images being displayed on the monitor of the DVR, with a delay depending on your Internet connection at both the DVR location and from where you're currently accessing.
3. **Disconnect button** : Press this button to disconnect from the DVR unit. Then you may power off the software.
4. **Screen Division button** : Select how many channels to view simultaneously (single, 4-split).
When you select a view you will see the Channel Numbers highlighted which determine what channels are currently being viewed.
5. **Channel number button** : Select the channel that you want to view based on what Screen Division view is enabled.
6. **Status window** : Displays the current time and date. The date is in the format : Year/Month/Day.
You will also see the status of your connection.
7. **Setting, Playback, and Sequence buttons** ; a. Setting : Enables the software configuration screen.
b. Playback : Enables the remote playback screen.
c. Sequence : When in single channel view, hitting the sequence button will sequence through all active channels at a speed specified in the settings menu.
8. **PTZ control** : You can control a PTZ camera via the software with these controls.
 - a. First, you must input or configure the specific PTZ protocol in the software in order to communicate with the PTZ device.
 - b. When you press any of the controls for the PTZ, please press and hold the button for 1-2 seconds per instance to compensate for the data transmission rate. If you do not and instead simply click the PTZ buttons, you may get undesired results such as repeated operations.
 - c. The plus and minus buttons send the PTZ commands to the corresponding PTZ camera ID.

IP/PORT Setting Screen

RemoteViewer Setup

IP/PORT | DDNS | SAVE

NAME: INTRANET MANUAL DDNS

ADDRESS: 218.146.23.250 PORT: 247

USER ID: admin PASSWORD:

| NAME | IP | PORT |
|----------|---------------|-------|
| INTERNET | 192.168.1.160 | 50000 |

Save Delete

OK Cancel

→ IP List

**MANUAL
DDNS**

Input IP address and PORT manually

Receive IP address and PORT from DDNS Server.

For further information of DDNS, please contact your vendor.

NOTE: We do not support DDNS.

Name

Name of IP address on the list.

Address

Input IP address which is set in DVR

PORT

Input PORT which is set in DVR

USER ID

Input ID which is set in DVR. (Please input 'admin'.)

Password

Input password which is set in DVR

IP List

It shows IP list which users input manually.

Select Button Select IP and PORT on the list.

Save Button Save IP and PORT on the list.

Delete Button Delete IP and PORT on the list.

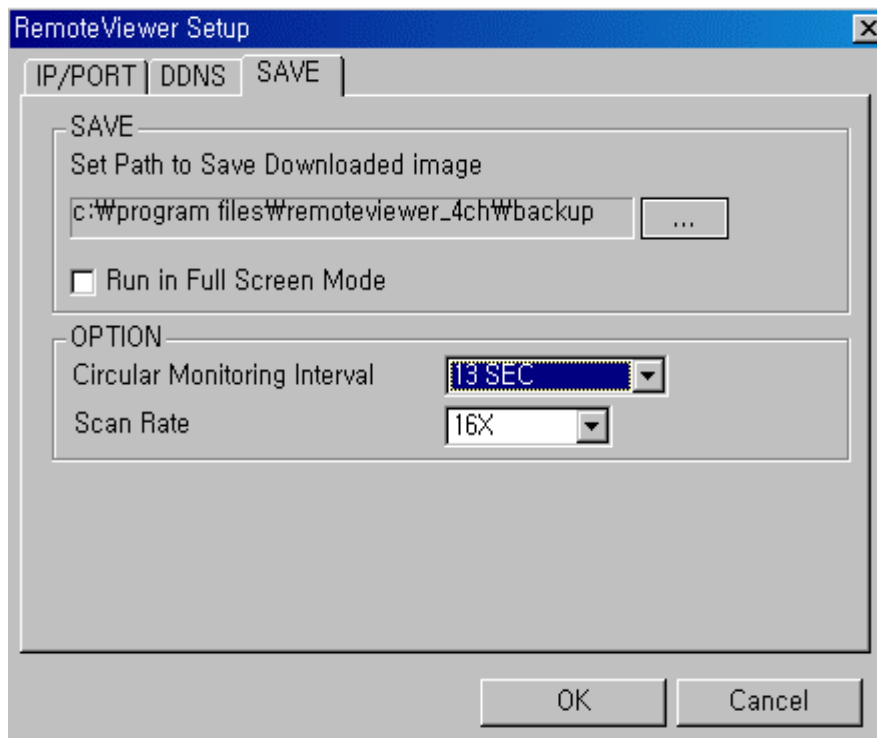
SAVE Setting Screen

Circular Monitoring Interval : This indicates the speed of the channel sequence when the SEQUENCE button is used from the main interface.

Scan Rate : Set speed of playback.

Set Path to Save Downloaded image : Determines the location and folder on your PC where the downloaded video clips are stored.

Run in full screen mode : When checked, this will enable the program to re-adjust the interface to completely fill your computer screen.

PLAYBACK interface through Remote Viewer

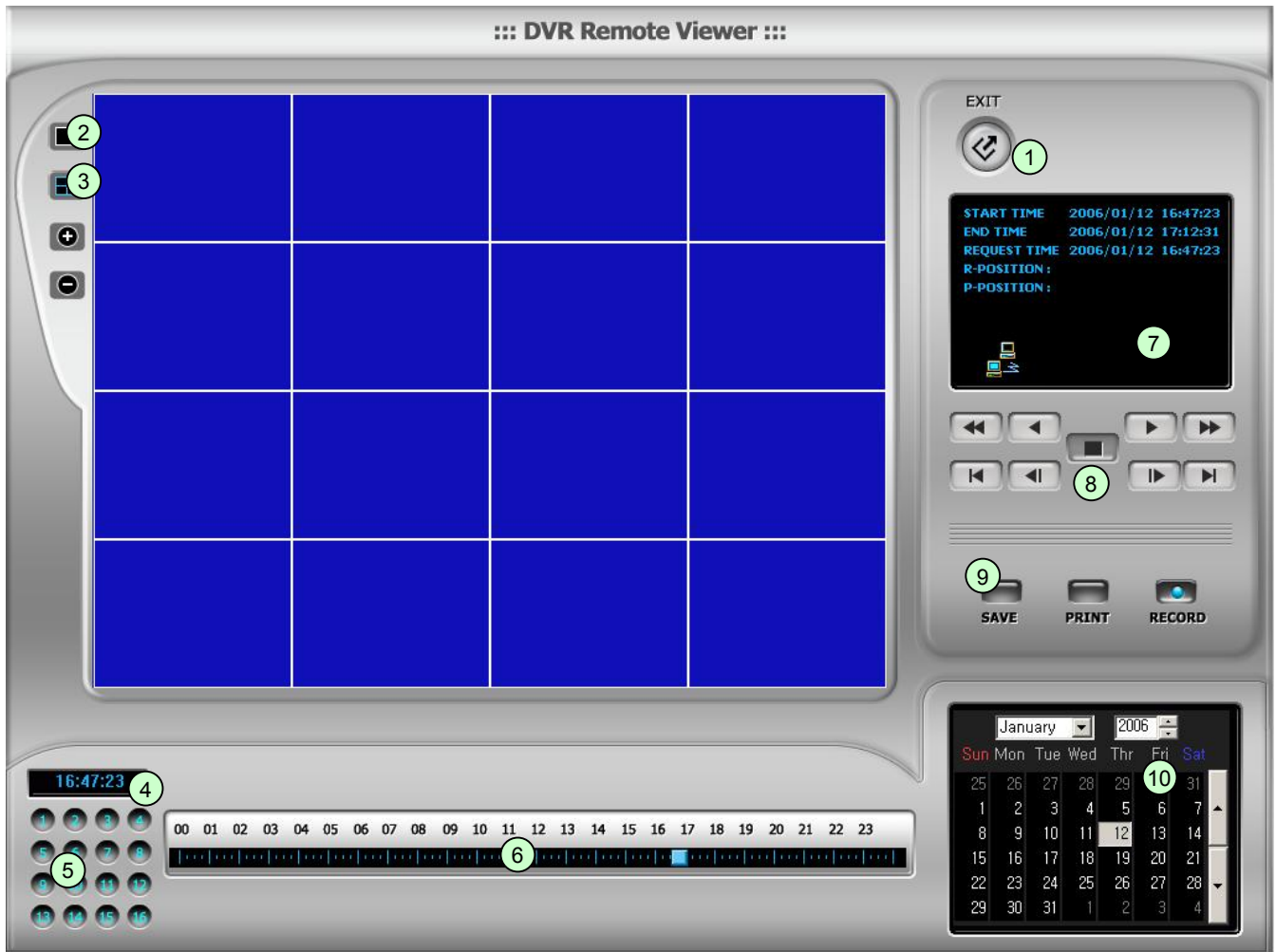



Function of each button in Search window.

1. **Exit** : Exit to live window.
2. **Full screen** : Select a certain camera to view in full screen.
3. **Quad** : To view quad mode (4 channels at the same time)
4. **Time** : The recording time & date information of the pictures which are being played.
5. **Channel selection** : Select each camera.
6. **Time selection** : Select a time from which user wants playback. The playback will be started from this point (drag the pointer using mouse)
7. **Start and end time** : Indicate record starting time and end time of images on HDD
8. **Other operating button** : Refer to the next page description.

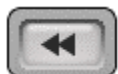



 : Play fast backward

 : Play backward(1X)

 : Play forward(1X)

 : Play fast forward

 : Stop playback

 : Move to the start of recording

 : Move to the previous hour

 : Move to the next hour

 : Move to the end of recording

9. Command button.

- a) **SAVE** : After pressing the Stop button, click SAVE button to save the currently viewed image in jpg format.
- b) **PRINT** : After pressing the Stop button, click PRINT button to print the currently viewed image.
- c) **RECORD** : Press this button to download playback images transmitted from DVR unit into your PC. User can see saved images using Windows Media Player.

10. Calendar

Use this to select the date you wish to search. The filled in square outlines the date that is at the beginning of the hard drives. The outlined square indicates the data at the end of the hard drives. Select the date you wish to view. Verify a filled in square for that particular date. If an invalid date is selected it will default to the beginning of the hard drive(s).

6-3. Back-up CD Player

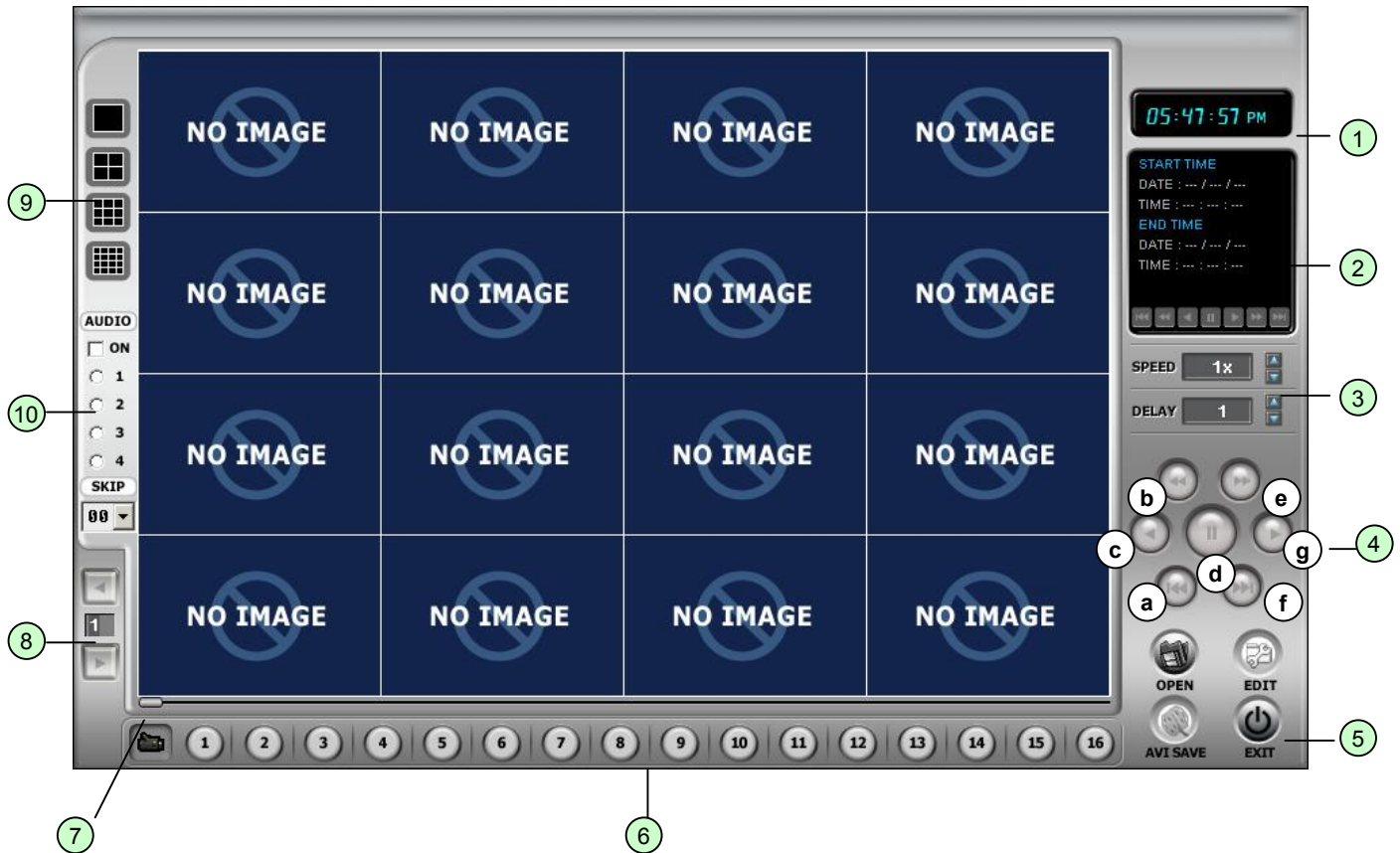

DVR units have a built-in CD-RW, and user can copy images to CD.

Using back-up CD player, user can see images on back-up CD, and function of each button in Back-up CD player is as below.

1. **Time** : Current time.
2. **Status Window** : Start & End of time & date, Status of operating button.
When user play forward/backward, recorded time will appear.
3. **Play Speed button** : User can adjust play speed by pressing up/down button.
Speed (1/4X, 1/2X, 1X, 2X, 4X, 8X, 16X) Delay : (1, 2, 4, 8, 16, 32)
4. **Operation button** : User can search recorded data using these buttons.
 - a) Move the slide bar to start position
 - b) Play fast backward in preset speed
 - c) Play backward at 1x speed
 - d) Pause
 - e) Play forward at 1x speed
 - f) Play fast forward in preset speed
 - g) Move the slide bar to end position
5. **Function button**
 - a) OPEN : Open the Back-up CD Player.
 - b) EDIT : User can edit, save and print recorded images in Edit mode. This edit button will work when you select one of 16 cameras.
 - c) EXIT : Exit from Back-up CD Player.
6. **Channel button** : Select channel to see pictures in full screen.
7. **Slide Bar** : Move to a point from where playback is required.
8. **Page button** : This button only works when screen-division is 4-split in an 8 ch DVR, or 4-split or 8-split in a 16 ch DVR. Moves to next page.
9. **Screen division** : 1/4

When you open the file, the audio menu OSD will come up automatically.

- on : check to output recorded sound, then choose the audio channel 1,2,3 or 4
- skip : skip images forward.

* During playback, you can control  only.

* During playback, only one channel is displayed and cannot be changed to multi or full screen.

Image EDIT

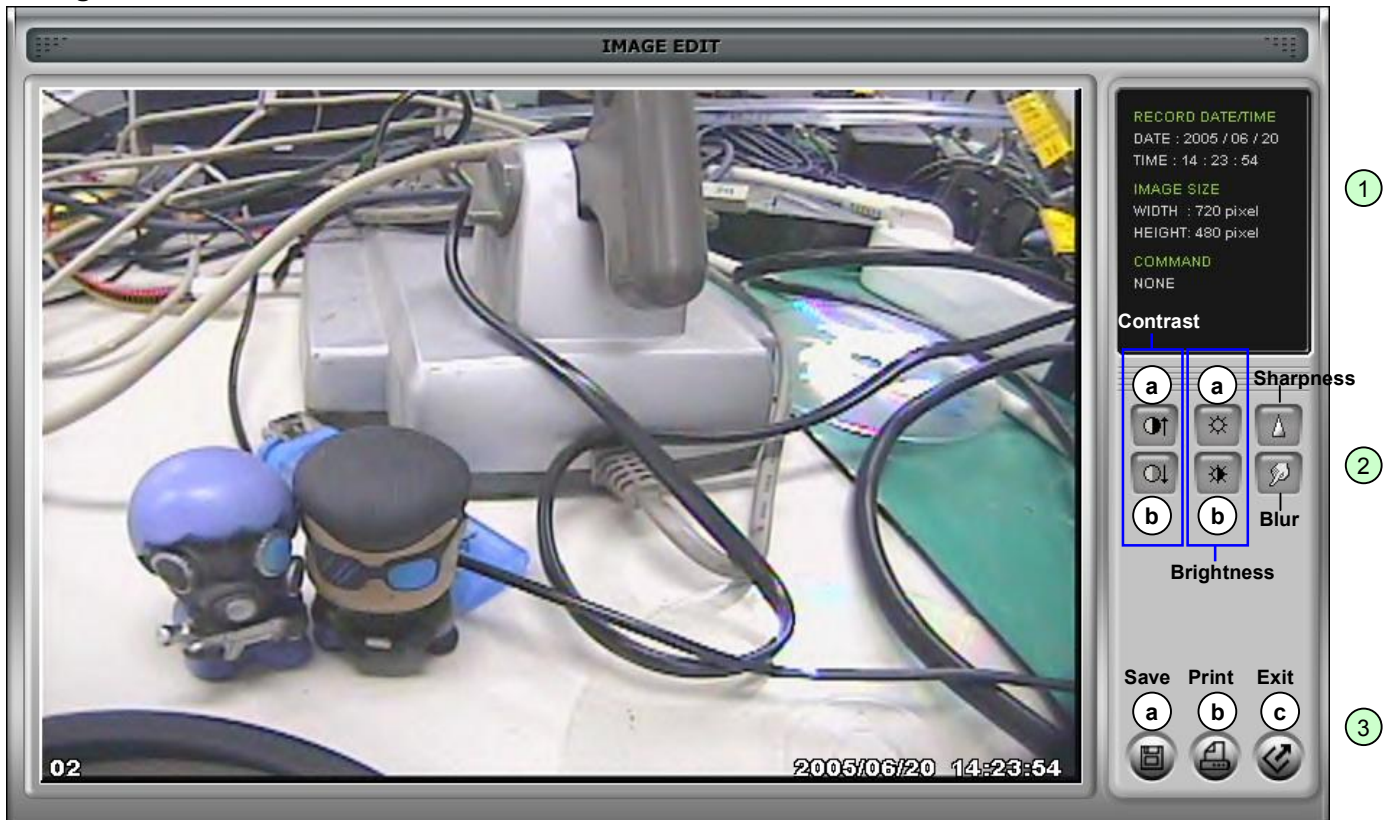

1. **Image Edit Status Window** : Shows record time & date, Image size, Command status.

2. **Edit Button** : User can adjust colour tone of copied images using this button.

- Contrast :
 - a) make bright part of image brighter and dark part of image darker
 - b) To reduce light and shade, lower contrast a little
- Brightness
 - a) make an image brighter
 - b) make an image darker
- Sharpness : give sharp-edge effect
- Blur : make an image soft

3. **Function button**

- a) Save : User can save an image in JPEG format. It is saved in the folder where you installed back-up CD player.
- b) Print : User can print the current image selected
- c) EXIT : Return to Back-up CD Player mode.

7-1. Web Viewer

1) Please click the following icon to execute Web-Viewer.

*If ActiveX control installation is required for the first time access, please click 'Yes'.



Click

2) The following Web-Viewer will pop up. Press 'connect' button to see the Live image.

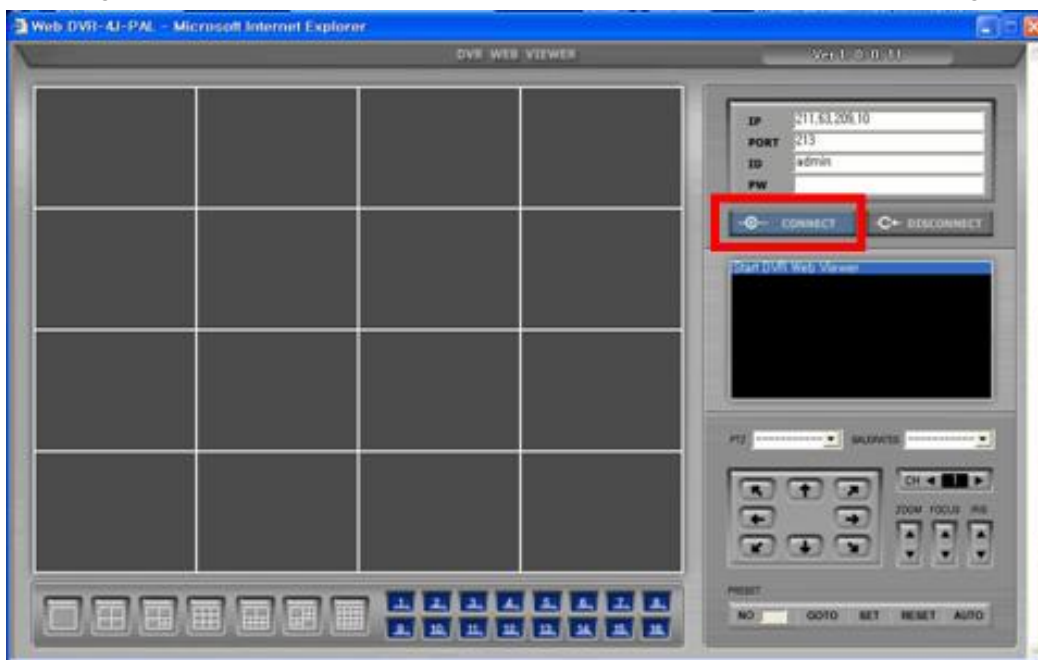

3) You can see the Live image as shown below.



7-2. Web Backup Player

- 1) To execute Web Backup Player, click web viewer icon on the right.
 * *If ActiveX control installation is required for the first time access, please click 'Yes'.
- 2) The following Web-Viewer will pop up. Press 'open' button to open the backup image file.



- 3) Choose one backup data file and click 'open' button on window.

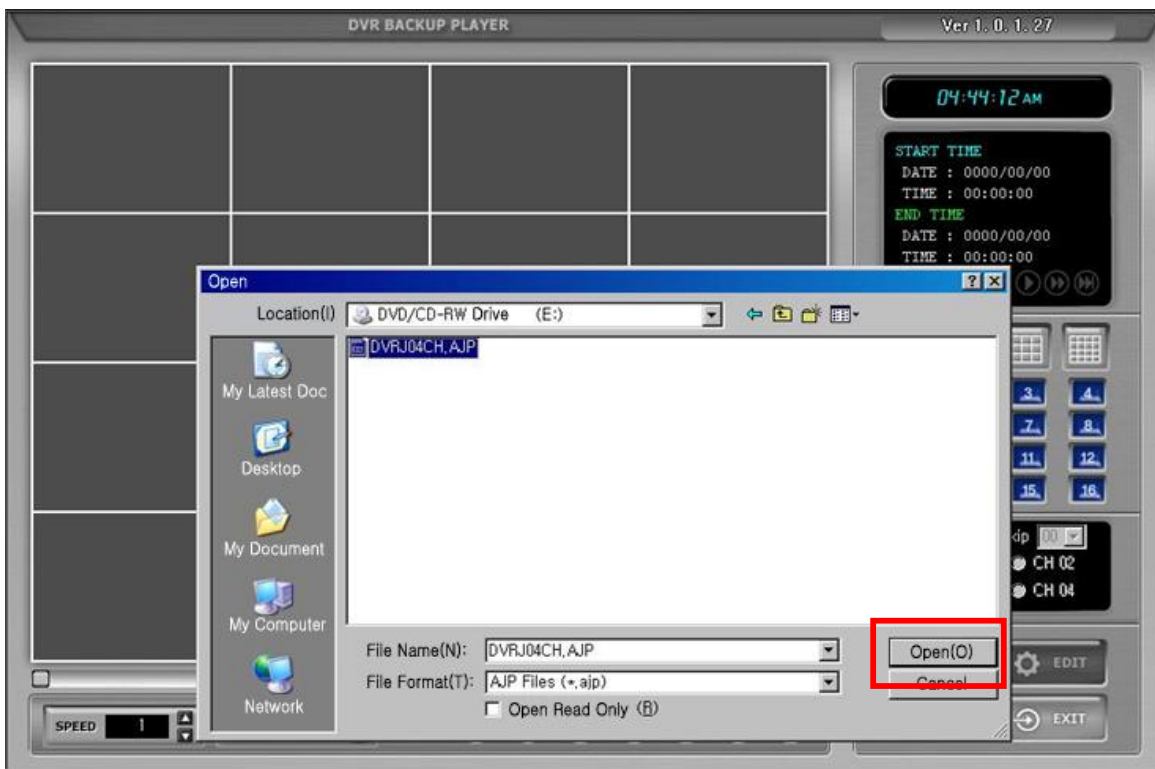

4) You can see Backup images shown as below.



CHAP. 8 Specifications

- MJPEG Compression Algorithm
- Real time live display in all channels
- Triplex (Playback/Recording/Ethernet)
- Web monitoring and download through network
- Easy control by Mouse
- USB (Device) port for firmware upgrade
- Easy PTZ Camera (MOUSE)
- Password protection
- Web control

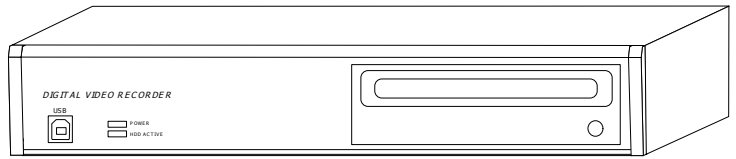

| | | | |
|----------------------|---------------------------------|---|--|
| Multiplex function | | Triplex (Playback/Recording/Ethernet) | |
| Storage | Internal | HDD | High capacity HDD support |
| Capacity | | CD-RW | For Backup |
| Video | Inputs | Composite | 4Ch |
| | Outputs | Composite | 2Ch (Monitor / SPOT) |
| | Compression | | MJPEG |
| | Compression Rate | | LOWEST |
| | | | LOW |
| | | | NORMAL |
| | | | HIGH |
| | | | HIGHEST |
| | Live Display Speed | | Real Time Live Display |
| | Recording Mode | | Time, Motion, Schedule, Alarm |
| | Search | | Event Search, Date/time Search, Percent Search |
| | Recording Speed (NTSC/PAL) | | Max. 120IPS(NTSC) 100IPS(PAL) |
| | Recording Resolution (NTSC/PAL) | | Half D1 (704x240/704x288), CIF (352x240/352x288) |
| Switching Interval | | 1~99 Sec selectable | |
| Live Division Screen | | 1 / 4 Split | |
| | | Digital Zoom, PIP in live mode | |
| Alarm | Inputs | 4 Alarm (NO/NC Selectable) | |
| | Outputs | 1 (NO/NC) | |
| | Post Alarm | Alarm output duration : 1 ~ 99 Sec selectable | |
| Network | | Ethernet (TCP/IP), Web viewer included | |
| Backup | | CD-RW Back up, Download via IP Network | |
| PTZ Control | | RS-485, MOUSE(PAN/TILT/ZOOM) | |
| Firmware upgrade | | USB Port for firmware upgrade, CD-R | |
| Serial I/F | | RS-485 | For PTZ Camera Control |
| | | RS-232C | For operation using keyboard of PC (not supported) |
| Power Requirements | | | |
| Weight | | | |
| Dimensions (WXHxD)mm | | | |
| Packing | | | |

Design and specifications are subjected to changes without notice.

4Ch Real time/Triplex/Mux - Stand Alone DVR

RECORDING TIMETABLE 704 x 288 LOWEST RESOLUTION AVERAGE IMAGE CONTENT

| FRAME RATE | 80Gb | 160Gb | 250Gb | 300Gb | 500Gb | 600G | 750Gb |
|------------|----------|----------|----------|----------|----------|----------|----------|
| 25 | 14.6 HR | 1.2 DYS | 1.9 DYS | 2.2 DYS | 3.8 DYS | 4.5 DYS | 5.6 DYS |
| 12.5 | 1.2 DYS | 2.4 DYS | 3.8 DYS | 4.4 DYS | 7.6 DYS | 9.0 DYS | 11.2 DYS |
| 8.3 | 1.8 DYS | 3.6 DYS | 5.7 DYS | 6.6 DYS | 11.4 DYS | 13.5 DYS | 16.8 DYS |
| 6.2 | 2.4 DYS | 4.8 DYS | 7.6 DYS | 8.8 DYS | 15.2 DYS | 17.0 DYS | 22.4 DYS |
| 5.0 | 3.0 DYS | 6.0 DYS | 9.5 DYS | 11.0 DYS | 19.0 DYS | 22.5 DYS | 28 DYS |
| 4.1 | 3.6 DYS | 7.2 DYS | 11.4 DYS | 13.2 DYS | 22.8 DYS | 27.0 DYS | 1 MTH |
| 3.5 | 4.2 DYS | 8.4 DYS | 13.3 DYS | 15.4 DYS | 26.6 DYS | 1 MTH | 1.2 MTHS |
| 2.0 | 7.6 DYS | 15.0 DYS | 23.7 DYS | 27.5 DYS | 1.5 MTHS | 1.8 MTHS | 2.2 MTHS |
| 1.0 | 15.2 DYS | 30.0 DYS | 1.5 MTHS | 1.7 MTHS | 3.0 MTHS | 3.6 MTHS | 4.5 MTHS |

RECORDING TIMETABLE 704 x 288 LOW RESOLUTION AVERAGE IMAGE CONTENT

| FRAME RATE | 80Gb | 160Gb | 250Gb | 300Gb | 500Gb | 600G | 750Gb |
|------------|----------|----------|----------|----------|----------|----------|----------|
| 25 | 13.3 HR | 1.1 DYS | 1.7 DYS | 2.0 DYS | 3.4 DYS | 4.1 DYS | 5.1 DYS |
| 12.5 | 1.1 DYS | 2.2 DYS | 3.4 DYS | 4.0 DYS | 6.8 DYS | 8.2 DYS | 10.2 DYS |
| 8.3 | 1.6 DYS | 3.3 DYS | 5.1 DYS | 6.0 DYS | 10.2 DYS | 12.3 DYS | 15.3 DYS |
| 6.2 | 2.2 DYS | 4.4 DYS | 6.8 DYS | 8.0 DYS | 13.6 DYS | 16.4 DYS | 20.4 DYS |
| 5.0 | 2.7 DYS | 5.5 DYS | 8.5 DYS | 10.0 DYS | 17.0 DYS | 20.5 DYS | 25.5 DYS |
| 4.1 | 3.3 DYS | 6.6 DYS | 10.2 DYS | 12.0 DYS | 20.4 DYS | 24.6 DYS | 30.6 DYS |
| 3.5 | 3.8 DYS | 7.7 DYS | 11.9 DYS | 14.0 DYS | 23.8 DYS | 28.7 DYS | 1.1 MTHS |
| 2.0 | 6.9 DYS | 13.7 DYS | 21.2 DYS | 25.0 DYS | 1.3 MTHS | 1.6 MTHS | 2.0 MTHS |
| 1.0 | 13.8 DYS | 27.4 DYS | 1.3 MTHS | 1.6 MTHS | 2.7 MTHS | 3.3 MTHS | 4.1 MTHS |

RECORDING TIMETABLE 704 x 288 NORMAL RESOLUTION AVERAGE IMAGE CONTENT

| FRAME RATE | 80Gb | 160Gb | 250Gb | 300Gb | 500Gb | 600G | 750Gb |
|------------|----------|----------|----------|----------|----------|----------|----------|
| 25 | 11.9 HRS | 23.9 HRS | 1.5 DYS | 1.8 DYS | 3.1 DYS | 3.7 DYS | 4.6 DYS |
| 12.5 | 23.8 HRS | 1.9 DYS | 3.0 DYS | 3.6 DYS | 6.2 DYS | 7.4 DYS | 9.2 DYS |
| 8.3 | 1.4 DYS | 2.9 DYS | 4.5 DYS | 5.4 DYS | 9.3 DYS | 11.1 DYS | 13.8 DYS |
| 6.2 | 1.9 DYS | 3.9 DYS | 6.0 DYS | 7.2 DYS | 12.4 DYS | 14.8 DYS | 18.4 DYS |
| 5.0 | 2.4 DYS | 4.9 DYS | 7.5 DYS | 9.0 DYS | 15.5 DYS | 18.5 DYS | 23.0 DYS |
| 4.1 | 2.9 DYS | 5.9 DYS | 9.0 DYS | 10.8 DYS | 18.6 DYS | 22.2 DYS | 27.6 DYS |
| 3.5 | 3.4 DYS | 6.9 DYS | 10.5 DYS | 12.6 DYS | 21.7 DYS | 25.9 DYS | 1.0 MTH |
| 2.0 | 6.1 DYS | 12.4 DYS | 18.7 DYS | 22.5 DYS | 1.2 MTHS | 1.4 MTHS | 1.8 MTHS |
| 1.0 | 12.3 DYS | 24.8 DYS | 1.2 MTHS | 1.4 MTHS | 2.5 MTHS | 2.9 MTHS | 3.7 MTHS |

4Ch Real time/Triplex/Mux - Stand Alone DVR

RECORDING TIMETABLE 704 x 288 HIGH RESOLUTION AVERAGE IMAGE CONTENT

| FRAME RATE | 80Gb | 160Gb | 250Gb | 300Gb | 500Gb | 600G | 750Gb |
|------------|----------|----------|----------|----------|----------|----------|----------|
| 25 | 10.3 HRS | 20.7 HRS | 1.3 DYS | 1.6 DYS | 2.6 DYS | 3.2 DYS | 4.0 DYS |
| 12.5 | 20.6 HRS | 1.7 DYS | 2.6 DYS | 3.2 DYS | 5.2 DYS | 6.4 DYS | 8.0 DYS |
| 8.3 | 1.2 DYS | 2.5 DYS | 3.9 DYS | 4.8 DYS | 7.8 DYS | 9.6 DYS | 12.0 DYS |
| 6.2 | 1.7 DYS | 3.4 DYS | 5.2 DYS | 6.4 DYS | 10.4 DYS | 12.8 DYS | 16.0 DYS |
| 5.0 | 2.1 DYS | 4.3 DYS | 6.5 DYS | 8.0 DYS | 13.0 DYS | 16.0 DYS | 20.0 DYS |
| 4.1 | 2.5 DYS | 5.1 DYS | 7.8 DYS | 9.6 DYS | 15.6 DYS | 19.2 DYS | 24.0 DYS |
| 3.5 | 3.0 DYS | 6.0 DYS | 9.1 DYS | 11.2 DYS | 18.2 DYS | 22.4 DYS | 28.0 DYS |
| 2.0 | 5.3 DYS | 10.7 DYS | 16.2 DYS | 20.0 DYS | 1.0 MTH | 1.2 MTHS | 1.6 MTHS |
| 1.0 | 10.7 DYS | 21.5 DYS | 1.0 MTH | 1.2 MTHS | 2.0 MTHS | 2.5 MTHS | 3.2 MTHS |

RECORDING TIMETABLE 704 x 288 HIGHEST RESOLUTION AVERAGE IMAGE CONTENT

| FRAME RATE | 80Gb | 160Gb | 250Gb | 300Gb | 500Gb | 600G | 750Gb |
|------------|----------|----------|----------|----------|----------|----------|----------|
| 25 | 8.7 HRS | 17.5 HRS | 1.1 DAY | 1.3 DYS | 2.2 DYS | 2.7 DYS | 3.4 DYS |
| 12.5 | 17.4 HRS | 1.4 DYS | 2.2 DYS | 2.6 DYS | 4.4 DYS | 5.4 DYS | 6.8 DYS |
| 8.3 | 1.0 DAY | 2.1 DYS | 3.3 DYS | 3.9 DYS | 6.6 DYS | 8.1 DYS | 10.2 DYS |
| 6.2 | 1.4 DYS | 2.9 DYS | 4.4 DYS | 5.2 DYS | 8.8 DYS | 10.8 DYS | 13.6 DYS |
| 5.0 | 1.8 DYS | 3.6 DYS | 5.5 DYS | 6.5 DYS | 11.0 DYS | 13.5 DYS | 17.0 DYS |
| 4.1 | 2.1 DYS | 4.3 DYS | 6.6 DYS | 7.8 DYS | 13.2 DYS | 16.2 DYS | 20.4 DYS |
| 3.5 | 2.5 DYS | 5.1 DYS | 7.7 DYS | 9.1 DYS | 15.4 DYS | 18.9 DYS | 23.8 DYS |
| 2.0 | 4.5 DYS | 9.1 DYS | 13.7 DYS | 16.2 DYS | 27.5 DYS | 1.0 MTH | 1.3 MTHS |
| 1.0 | 9.1 DYS | 18.2 DYS | 27.5 DYS | 1.0 MTH | 1.7 MTHS | 2.1 MTHS | 2.7 MTHS |

SPECIAL NOTE:

The timings shown for the various hard drives are based on 704 x 288 resolution and average image content. Average image content can vary considerably as images are in MJPEG compression.

Example A: Large area of same colour and image content such as a ceiling could provide up to 50% reduction in total disk space but a component PCB board could increase disk requirements by 100%.

The timings given are therefore only a guide.

To calculate timings using the lower resolution setting of 352 x 288 multiply the record time by 1.8