



# ***FuzeT50*** and ***FuzeT20***

Patent Pending



Patent Pending

## Owner's Operation and Maintenance Manual

**DEALER:** THIS MANUAL MUST BE GIVEN TO THE USER OF THE WHEELCHAIR

**USER:** BEFORE USING THIS WHEELCHAIR, READ THIS ENTIRE  
MANUAL AND SAVE FOR FUTURE REFERENCE

*For more information regarding PDG products,  
parts and services please visit [www.PDGmobility.com](http://www.PDGmobility.com)*



Class 1 Medical Device  
Registration CA 004986

# TABLE OF CONTENTS

<b>1. NOTICE:</b>	
<b>READ BEFORE USING .....</b>	<b>p. 3</b>
A. Warnings .....	p. 3
B. Special Notes .....	p. 3
C. Unpacking .....	p. 3
D. Out of the Box Assembly Instructions .....	p. 6
E. Inspection .....	p. 6
F. Storage .....	p. 6
G. Contacting A Qualified Service Agent To Obtain Service .....	p. 6
H. Specifications .....	p. 7
<b>2.0 GENERAL GUIDELINES .....</b>	<b>p. 8</b>
<b>2.1 INDICATIONS FOR USE .....</b>	<b>p. 8</b>
<b>2.2 CONTRAINDICATIONS     FOR USE .....</b>	<b>p. 8</b>
A. Information for Health Care Professionals or Assistants .....	p. 8
B. Operating Information .....	p. 8
C. Weight Training .....	p. 10
D. Weight Limitation .....	p. 10
E. Stability and Balance .....	p. 10
F. Safety and Handling of Wheelchairs .....	p. 10
G. Note To Wheelchair Assistants .....	p. 11
H. Tilting the Wheelchair .....	p. 11
I. Curbs and Steps .....	p. 11
J. Stairs .....	p. 12
K. Transferring To and From Other Seats .....	p. 13
L. Reaching, Leaning and Bending Forwards .....	p. 13
M. Reaching and Leaning Backwards .....	p. 13
N. Motor Vehicle Use .....	p. 14
<b>3.0 TROUBLESHOOTING .....</b>	<b>p. 16</b>
<b>4.0 MAINTENANCE .....</b>	<b>p. 13</b>
A. Maintenance Safety Precautions .....	p. 16
B. Tools Required .....	p. 17
C. Cleaning .....	p. 17
D. Recommended Maintenance Schedule .....	p. 17
<b>5.0 SET-UP AND ADJUSTMENT .....</b>	<b>p. 18</b>
A. Footrests - Swing-away (70° and 90°) .....	p. 18
B. Locking Flip-up Arms .....	p. 19
C. T-Style Arms .....	p. 20
D. Back Angle .....	p. 20
E. Adjustable Angle Stroller Handle .....	p. 22
F. Quick Release Axles .....	p. 23
G. Wheel Locks - Front or Rear .....	p. 24
H. Anti-Tip Tubes .....	p. 25
I. Adjustable Seat Tilt .....	p. 26
J. Seat Height .....	p. 26
K. Seat Depth .....	p. 27
L. Seat Width .....	p. 28
<b>6.0 SETUP GUIDELINES .....</b>	<b>p. 28</b>
<b>7.0 TESTING .....</b>	<b>p. 28</b>
<b>8.0 LIMITED WARRANTY .....</b>	<b>p. 28</b>
<b>Appendix</b>	
Table 1 - Seat Height Adjustments .....	p. 29
Table 2 .....	p. 30
Table 3 - Seat Pan Sizes .....	p. 31
Table 4 - Seat Pan Size Options .....	p. 31
Table 5 - Seat Pan Size Overlap .....	p. 32
Table 6 - Adjustments .....	p. 33
Table 7 - Fuze T50 Set-up Guide .....	p. 34

# 1. NOTICE: READ BEFORE USING

## A. Warnings

Warning/Caution notices as used in this manual apply to hazards or unsafe practices, which could result in personal injury or property damage.

1. DO NOT OPERATE THIS EQUIPMENT WITHOUT FIRST READING AND UNDERSTANDING THIS MANUAL.
2. IF YOU ARE UNABLE TO UNDERSTAND THE WARNINGS, CAUTIONS AND INSTRUCTIONS, CONTACT A HEALTH CARE PROFESSIONAL, DEALER OR A QUALIFIED TECHNICIAN BEFORE ATTEMPTING TO USE THIS EQUIPMENT - OTHERWISE INJURY OR DAMAGE MAY RESULT.
3. THE INITIAL SET UP OF THIS WHEELCHAIR MUST BE PERFORMED BY A QUALIFIED TECHNICIAN. PROCEDURES OTHER THAN THOSE DESCRIBED IN THIS MANUAL MUST BE PERFORMED BY A QUALIFIED TECHNICIAN.

## B. Special Notes

1. The information contained in this document is subject to change without notice. As a manufacturer of wheelchairs, PDG endeavors to supply a wide variety of wheelchairs to meet many needs of the end user. However, final selection of the type of wheelchair to be used by an individual rests solely with the user and his/her health care professional capable of making such a selection.
2. Tie-down restraints and seat positioning straps. PDG recommends that wheelchair users NOT be transported in vehicles of any kind while in wheelchairs unless equipped with a manufacturer installed transport kit.
3. Restraints – seat & chest positioning straps. It is the obligation of the DME dealer, therapists and other health care professionals to determine if a seat/chest positioning strap is required to ensure the safe operation of this equipment by the user. Serious injury can occur in the event of a fall from a wheelchair.

## C. Unpacking

1. Check for any obvious damage to the carton or its contents. If damage is evident, notify your Dealer/Carrier immediately.
2. Remove all loose packing from the carton.
3. Carefully remove all components from the carton.

**Note:** Unless the PDG wheelchair is to be assembled immediately, retain cartons and packing materials for use in storing the wheelchair until assembly is required.

# FuzeT20

- |                 |                             |                         |
|-----------------|-----------------------------|-------------------------|
| 1. Seat Pan     | 6. Arm Rest Release Trigger | 11. Front Casters       |
| 2. Arm Rest     | 7. Gas Strut                | 12. Lower Frame         |
| 3. Push Handle  | 8. Cross Bar                | 13. Front Pivot Bracket |
| 4. Foot Rest    | 9. Caster Cap               | 14. Axle Plate          |
| 5. Tilt Trigger | 10. Caster Journal          | 15. Anti-Tip System     |
|                 |                             | 16. Rear Wheel          |

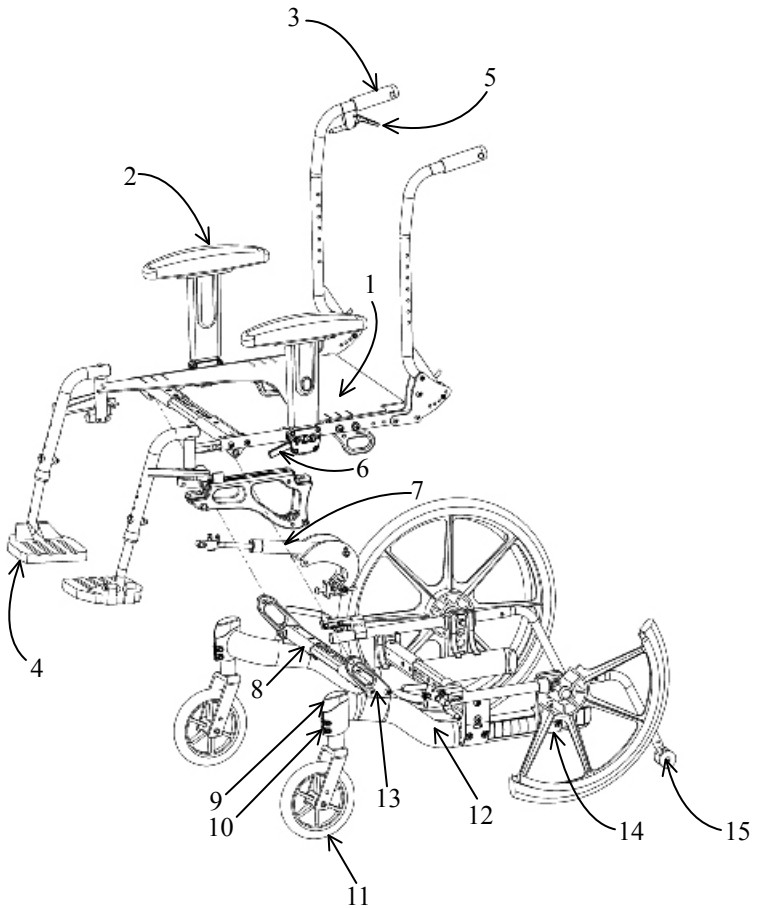

# FuzeT50

- |                             |                        |                     |
|-----------------------------|------------------------|---------------------|
| 1. Seat Pan                 | 7. Tilt Locking System | 12. Lower Frame     |
| 2. Arm Rest                 | 8. Cross Bar           | 13. Pivot Point Arm |
| 3. Push Handle              | 9. Caster Cap          | 14. Axle Plate      |
| 4. Foot Rest                | 10. Caster Journal     | 15. Anti-tip System |
| 5. Tilt Trigger             | 11. Front Casters      | 16. Rear Wheel      |
| 6. Arm Rest Release Trigger |                        | 17. Wheel Lock      |

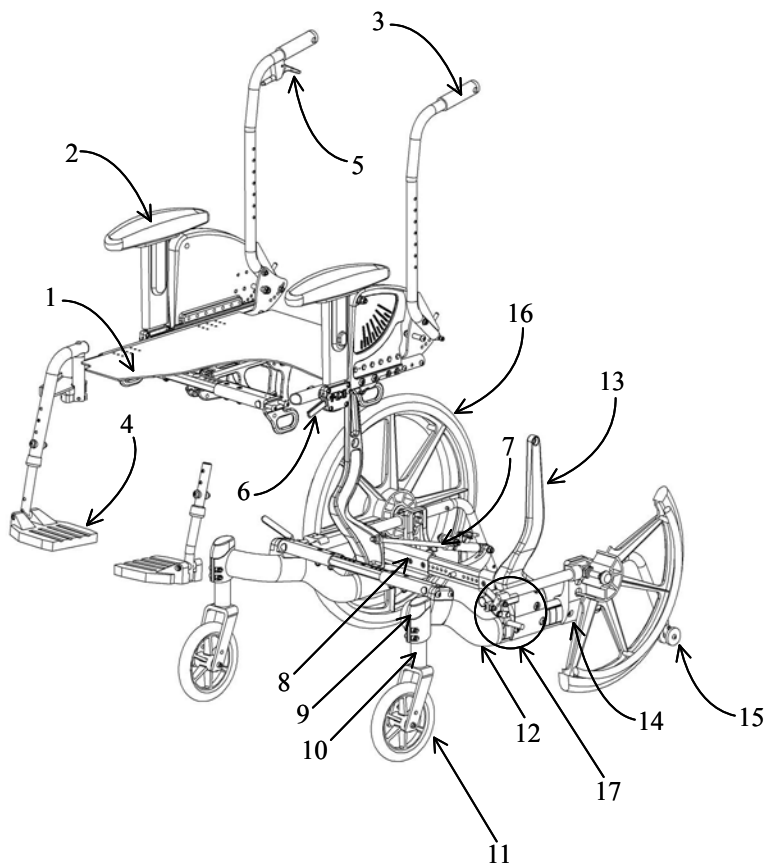

## **D. Out of the Box Assembly Instructions**

When unpacking a new Fuze wheelchair, you will need to assemble the armrests (T-style version only) and front rigging to complete the setup.

1. Install the T-style arm assemblies by inserting the metal locking tab into the arm receivers on the chair (see Section 5-D for detailed instructions).
2. Install the swing-away front rigging by inserting the front rigging assembly at 90° to the chair, into the front rigging mount and swiveling the front rigging forward to an in-line position with the wheelchair (see Section 5-A for detailed instructions).

## **E. Inspection**

1. Examine the exterior of the PDG wheelchair for nicks, dents, scratches, or other damages. Inspect all components. If damage is evident, notify your Dealer/Carrier immediately.

## **F. Storage**

1. Store the repackaged PDG wheelchair in a dry area.
2. DO NOT place other objects on top of the repackaged wheelchair.

## **G. Contacting a Qualified Service Agent to Obtain Service**

PDG has Qualified Service Agents in many locations. To find your nearest Qualified Service Agent, visit our web site at [www.pdgmobility.com](http://www.pdgmobility.com) and click on CONTACTS. If you are uncertain as to which CONTACT is most appropriate for your need, contact PDG directly by telephone, fax, or e-mail to obtain the necessary information. You will be asked by the Qualified Service Agent for the serial number that is affixed to the wheelchair. This information will allow PDG to serve you better.

In some circumstances, it may be necessary to return your wheelchair to a Qualified Service Agent for repairs. If any of the following conditions are observed, the wheelchair must be serviced by a Qualified Service Agent:

1. Any part of the frame is cracked or broken
2. Any weld is cracked or broken

Always contact your Service Agent prior to sending a wheelchair for repairs. For safe and secure shipping, the wheelchair must be placed in a suitable carton, or fastened to a pallet, to ensure it does not sustain damage during shipping. The Qualified Service Agent will provide specific instructions for packaging and shipping your wheelchair. Alternatively, the Qualified Service Agent may arrange for pick-up.

## **H. Specifications**

Overall Width - seat width + 8"

Overall Depth - without front rigging - 35 ½ "

Overall Height - 24" back height - 42"

Shipping Weight - 45 lbs

Anti-tippers - standard

Footrests - Swing-away footrests - standard

- Elevating leg rests - optional

Back Angle Adjustment - 90 degrees to 120 degrees

Rear Wheels - 12", 16", 20", 22" or 24"

- Urethane or pneumatic

Casters - 6" or 8"

- Urethane or pneumatic

Seat Width - 15", 16", 17", 18", 19", 20"

Seat Depth - 15", 16", 17", 18", 19", 20"

Seat Height<sup>1</sup> - 13", 14", 15", 16", 17", 18", 19", 20"

Back Height - 20" or 24"

Wheel Locks - Push to lock

Tilt-in-Space - Fuze T50 - 50 degrees of tilt

- Fuze T20 - 20 degrees of tilt

Weight Limitation - 250 pounds

<sup>1</sup> The seat-to-floor heights are based on urethane tires. These heights can vary ¼ inch due to tire wear.

## **I. Additional Information**

Additional information is available upon request. Please contact PDG at [info@pdgmobility.com](mailto:info@pdgmobility.com).

## 2.0 GENERAL GUIDELINES

### 2.1 INDICATIONS FOR USE

The intended use of this wheelchair is as a manually operated, attendant or user propelled, manual mechanical wheelchair.

### 2.2 CONTRAINDICATIONS FOR USE

#### A. Information for Health Care Professionals or Assistants



1. The Fuze wheelchair must be operated by a health care professional or assistant when in ANY tilt position only when client is unable to propel in a tilted position.
2. To maintain maximum stability, position the rear wheels in the most rearward position in the axle mounting plate. Moving the rear wheels to any of the other mounting positions causes the wheelchair to decrease in stability.
3. If moving the rear wheels to ANY forward position, ensure the wheelchair is stable BEFORE using.
4. ALWAYS ensure stability BEFORE using maximum amount of tilt-in-space or moving the rear wheels forward. TEST wheelchair BEFORE it is occupied by the end user to ensure safety.

#### B. Operating Information



1. Unless otherwise noted, all service and adjustments should be performed while the wheelchair is unoccupied.
2. To determine and establish your particular safety limits, practice bending, reaching and transferring activities in the presence of a qualified health care professional BEFORE attempting active use of the wheelchair.
3. ALWAYS wear your SEAT/CHEST POSITIONING STRAP when applicable. Inasmuch as the SEAT/CHEST POSITIONING STRAP is an option on this wheelchair (you may order with or without the Seat /Chest Positioning Strap), PDG strongly recommends ordering the Seat/Chest Positioning Strap as an additional safeguard for the wheelchair user.
4. ALWAYS check foam grips for looseness BEFORE using the wheelchair. If loose, contact a qualified technician for instructions.
5. The necessary back angle MUST be selected BEFORE repositioning the rear wheels forward.



6. DO NOT operate the tilt-in-space if the trigger release levers and cables are not properly adjusted to ensure that the tilt-in-space is locked in place when engaged.
7. DO NOT TRAVERSE, CLIMB or GO DOWN ramps or slopes GREATER than 9°.
8. NEVER leave the occupied wheelchair unattended at any time, especially on an incline.
9. DO NOT attempt to reach objects if you have to move forward in the seat.
10. DO NOT attempt to reach objects if you have to pick them up from the floor by reaching down between your knees.
11. DO NOT lean over the top of the back upholstery/seating system. This will change your center of gravity and may cause you to tip over.
12. DO NOT shift your weight or sitting position toward direction you are reaching as wheelchair may tip over.
13. WHEEL LOCKS ARE NOT BRAKES. DO NOT attempt to stop a moving wheelchair with the wheel locks.
14. DO NOT tip the wheelchair onto the rear wheels without assistance.
15. DO NOT use an escalator to move a wheelchair between floors. Serious bodily injury may occur.
16. Before attempting to transfer in or out of the wheelchair, every precaution should be taken to reduce the gap distance. Turn both casters parallel to the object you are transferring onto. When transferring to and from the wheelchair, ALWAYS ENGAGE BOTH WHEEL LOCKS.
17. If equipped with pneumatic tires DO NOT use wheelchair unless the tires have the proper tire pressure. DO NOT over inflate the tires. Failure to follow these suggestions may cause the tire to explode and cause bodily harm. Recommended tire pressure is listed on the side wall of the tire.
18. DO NOT use ANY parts, accessories, or adapters other than those authorized by PDG. Otherwise, the warranty is void.
19. DO NOT attempt to lift a wheelchair by lifting on any removable (detachable) parts. Lifting by means of any removable (detachable) parts of a wheelchair may result in injury to the user or damage to the wheelchair.
20. DO NOT use the folding links or spreader bar for lifting or transporting the wheelchair.
21. DO NOT use the folding links spreader bar as a weight bearing support.
22. DO NOT stand on the frame of the wheelchair. PDG recommends that anti-tippers BE attached at all times.

23. DO NOT use the footplates as a platform. When getting in or out of the wheelchair, make sure that the footplates are in the upward position.

### **C. Weight Training**



PDG DOES NOT recommend the use of its wheelchairs as a weight training apparatus. PDG wheelchairs have NOT been designed or tested as a seat for any kind of weight training. If occupant uses said wheelchair as a weight training apparatus, PDG shall NOT be liable for bodily injury and the warranty is void.

### **D. Weight Limitation**



The Fuze wheelchair has a weight limitation of 250 lbs

### **E. Stability and Balance**



1. Anti-tippers MUST be attached at all times.
2. To assure stability and proper operation of your wheelchair, you must at all times maintain proper balance. Your wheelchair has been designed to remain upright and stable during normal daily activities as long as you do not move beyond the center of gravity.
3. Virtually all activities which involve movement in the wheelchair have an effect on the center of gravity. PDG recommends using seat/chest positioning straps for additional safety while involved in activities that shift your weight.
4. DO NOT lean forward out of the wheelchair any further than the length of the armrests. Make sure the casters are pointing in the forward position whenever you lean forward. This can be achieved by advancing the wheelchair and then reversing it in a straight line.
5. The PDG Fuze wheelchair should be operated by an assistant when the wheelchair is in any tilted position.

### **F. Safety and Handling of Wheelchairs**

Safety and handling of the wheelchair requires the close attention of the wheelchair user as well as the assistant. This manual points out the most common procedures and techniques involved in the safe operation and maintenance of the wheelchair. It is important to practice and master these safe techniques until you are comfortable in maneuvering around the frequently encountered architectural barriers.

Use this information only as a basic guide. The techniques that are discussed on the following pages have been used successfully by many.

Individual wheelchair users often develop skills to deal with daily living activities that may differ from those described in this manual. PDG recognizes and encourages each individual to try what works best for him/her in overcoming architectural obstacles that they may encounter, however ALL WARNINGS and CAUTIONS given in this manual MUST be followed. Techniques in this manual are a starting point for the new wheelchair user and assistant with “safety” as the most important consideration for all.

## **G. Note to Wheelchair Assistants**



1. When assistance to the wheelchair user is required, remember to use good body mechanics. Keep your back straight and bend your knees whenever tipping the wheelchair or traversing curbs, or other impediments.
2. DO NOT attempt to lift the wheelchair by any removable (detachable) parts. Lifting by means of any removable (detachable) parts of a wheelchair may result in injury to the user or damage to the wheelchair.
3. DO NOT use the spreader bar for lifting or transporting the wheelchair.
4. DO NOT use the spreader bar as a weight bearing support. When learning a new assistance technique, have an experienced assistant help you before attempting it alone.

## **H. Tilting the Wheelchair**



1. DO NOT tilt the wheelchair without assistance
2. When tilting the wheelchair, an assistant should grasp the back of the wheelchair on a non-removable (non-detachable) part. Inform the wheelchair occupant before tilting the wheelchair and remind him/her to lean back. Be sure the occupant's feet and hands are clear of all wheels.
3. After mastering the techniques of tilting the wheelchair, use this procedure to tackle shallow curbs, short stairs, etc.

## **I. Curbs and Steps**



1. Each person who helps you should read the “Notes to Wheelchair Assistants” (Section G above).

## 2. Wheelchairs with Step Tubes

- a. Apply a continuous downward motion until the balance point is achieved and the front casters clear the curb. At this point, the assistant will feel a difference in the weight distribution.
- b. Roll the wheelchair forward and slowly lower the wheelchair in one continuous movement. Do not let the wheelchair drop the last few inches to the ground. This could result in injury to the occupant. Push the wheelchair forward until the rear wheels roll up and over the curb.

## 3. Wheelchairs Without Step Tubes

- a. Unless the first assistant has exceptional upper body strength, it is recommended that METHOD 2 use two (2) assistants. The second assistant should be positioned at the front of the wheelchair lifting upward on a non-removable (non-detachable) part of the wheelchair frame when lifting the wheelchair and stabilizing the wheelchair when the wheelchair is being lowered to the ground.
- b. The first assistant should stand on the sidewalk and turn the wheelchair so that the rear wheels are against the curb. The wheelchair should be tilted back to the balance point and, in one continuous downward movement, the rear wheels should be pulled up and over the curb. DO NOT return the front casters to the ground until the wheelchair has been pulled backward far enough for the front casters to clear the edge of the curb.

## J. Stairs



1. Extreme caution is advised when it is necessary to move an occupied wheelchair up or down the stairs. PDG recommends using two (2) assistants and making thorough preparations. Make sure to use ONLY secure, non-detachable parts for hand-held supports. Lifting by means of any removable (detachable) parts of a wheelchair may result in injury to the user or damage to the wheelchair.
2. After the wheelchair has been tilted back to the balance point, one assistant (in the rear) backs the wheelchair up against the first step, while securely grasping a non-removable (non-detachable) part of the wheelchair for leverage.
3. The second assistant, with a firm hold on a non-detachable part of the framework, lifts the wheelchair up and over the stair and steadies the wheelchair as the first assistant places one (1) foot on the next stair and repeats STEP 2.
4. The wheelchair should be kept tilted on its back wheels until the last stair has been negotiated and the wheelchair has been rolled away from the stairway.

## K. Transferring To and From Other Seats



1. **BEFORE** attempting to transfer in or out of the wheelchair, every precaution should be taken to reduce gap distance. Turn both casters toward the object you are transferring onto. Also be certain the wheel locks are engaged to help prevent wheels from moving.
2. **CAUTION:** When transferring, position yourself as far back as possible in the seat. This will prevent the possibility of the wheelchair tipping forward.
3. **NOTE:** This activity may be performed independently provided you have adequate mobility and upper body strength.
4. Position the wheelchair as close as possible along side the seat to which you are transferring, with the front casters pointing toward it. Engage wheel locks. Shift body weight into seat with transfer.
5. During independent transfer, little or no seat platform will be beneath you. Use a transfer board if at all possible.

## L. Reaching, Leaning and Bending - Forward



1. **DO NOT** attempt to reach objects if you have to move forward in the seat or pick them up from the floor by reaching down between your knees.
2. Many activities require the wheelchair owner to reach, bend and transfer in and out of the wheelchair. These movements will cause a change to the normal balance, the center of gravity, and the weight distribution of the wheelchair. To determine and establish your particular safety limits, practice bending, reaching and transferring activities in several combinations in the presence of a qualified health professional **BEFORE** attempting active use of the wheelchair.
3. Proper positioning is essential for your safety. When reaching, leaning, bending forward, it is important to use the front casters as a tool to maintain stability and balance.

## M. Reaching and Leaning - Backwards



1. **DO NOT** lean over the top of the back upholstery. This will change your center of gravity and may cause you to tip over.
2. Position wheelchair as close as possible to the desired object. Point front casters forward to create the longest possible wheelbase. Reach back only as far as your arm will extend without changing your sitting position.

## N. Motor Vehicle Use



Identify whether your chair has been manufactured with the Transit Tie-Down System (TTDS).

**If your chair is NOT equipped with the Transit Tie-Down System (TTDS), this wheelchair DOES NOT meet federal standards for motor vehicle seating.**

1. NEVER let anyone sit in this chair while in a moving vehicle.
2. ALWAYS secure the rider with proper vehicle restraints. In an accident or sudden stop the rider may be thrown from the chair. Wheelchair seatbelts will not prevent this and further injury may result from the belts or straps.
3. NEVER transport this chair in the front seat of a vehicle. It may shift and interfere with the driver.
4. ALWAYS secure this chair so that it cannot roll or shift.
5. Do not use any chair that has been involved in a motor vehicle accident.

**If your chair is equipped with the Transit Tie-Down System (TTDS):**

1. If possible and feasible, the rider should transfer to the Original Equipment Manufacturer vehicle seat and use the vehicle restraint.
2. Use only Wheelchair Tie Down and Occupant Restraint Systems (WTORS) which meet the requirements of SAE J2249 Recommended Practice – Wheelchair Tie Down and Occupant Restraint Systems For Use in Motor Vehicles. Do not use WTORS designed to rely on the wheelchair structure to transfer occupant restraint loads to the vehicle.
3. The rider must not weigh more than 250 lbs.
4. The wheelchair has been dynamically tested in a forward –facing mode for a 30 mph frontal impact test. The wheelchair must be forward facing during transport.
5. In order to reduce the potential of injury to vehicle occupants, wheelchair-mounted accessories, such as trays and respiratory equipment should be removed and secured separately.
6. Postural supports and positioning devices should not be relied on for occupant restraint.
7. Do not alter or substitute wheelchair frame parts, components or seating.
8. The figures below show the locations of the wheelchair securement points, front and back.

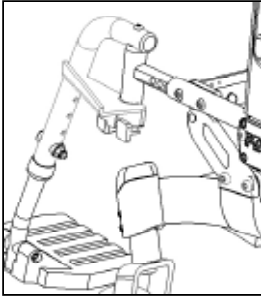

Fuze T20 Front Tiedown

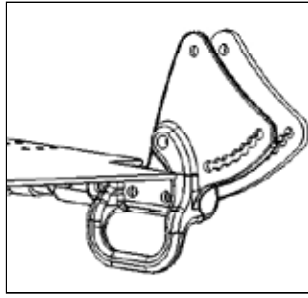

Fuze T20 Rear Tiedown

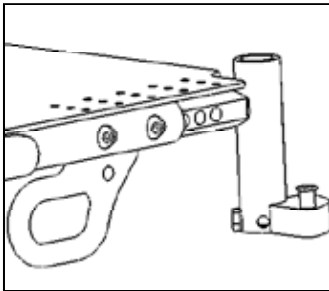

Fuze T50 Front Tiedown

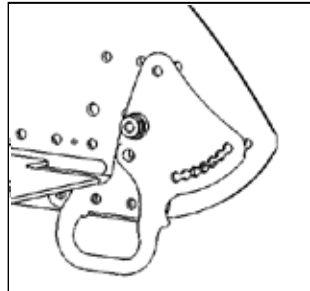

Fuze T50 Rear Tiedown

9. Use only with Wheelchair Tie Down and Occupant Restraint Systems (WTORS) that have been installed in accordance with the manufacturer's instructions and SAE J2249.
10. Attach WTORS to securement points in accordance with the manufacturer's instructions and SAE J2249.
11. Attach occupant restraints in accordance with the manufacturer's instructions and SAE J2249.
12. Sudden stops or impacts can structurally damage your chair. Chairs involved in such incidents should be replaced.

If you fail to heed these warnings, damage to your chair, a fall, tip-overs or loss of control may occur and cause severe injury to the rider or others.

### 3. TROUBLESHOOTING

You will need to adjust your chair from time to time for best performance. Use the chart provided below to troubleshoot and find a solution.

Note: Make only ONE change at a time.

<i>Symptoms</i>	<i>Chair Veers to Right</i>	<i>Chair Veers to Left</i>	<i>Sluggish Turning or Performance</i>	<i>Casters Flutter</i>	<i>Squeaks and Rattles</i>	<i>Looseness in Chair</i>	<i>Chair Contacts Only On 3 Wheels</i>	<i>Solutions</i>
✓				✓	✓	✓	✓	Check tire pressure.
	✓	✓	✓	✓	✓	✓	✓	Check for loose nuts and bolts.
				✓	✓	✓	✓	Check caster angle.
				✓	✓	✓	✓	Check that both casters contact the ground. If not, add proper spacers between bottom surface of lower bearing and top of fork stem nut. Check on a flat surface.

### 4. MAINTENANCE

Every six (6) months take your wheelchair to a qualified technician for a thorough inspection and servicing. Regular cleaning will reveal loose or worn parts and enhance the smooth operation of your wheelchair. To operate properly and safely, your wheelchair must be cared for just like any other vehicle. Routine maintenance will extend the life and efficiency of your wheelchair. Initial adjustments should be made to suit personal body structure and preference. Thereafter, follow these maintenance procedures:

#### A. Maintenance Safety Precautions



1. After ANY adjustments, repair or service and BEFORE use, make sure all attaching hardware is tightened securely - otherwise injury or damage may result.
2. DO NOT over tighten hardware attaching to the frame. This could cause damage to the frame tubing.
3. If the tires are pneumatic, DO NOT use the wheelchair unless it has the proper tire pressure. DO NOT over inflate the tires. Failure to follow these suggestions may cause the tire to explode and cause bodily harm. Recommended tire pressures will be listed on the sidewall of the tires.
4. Periodically adjust wheel locks in correlation to tire wear. Refer to the WHEEL LOCKS SECTION of this manual.



5. Make sure that ALL bolts are tight before operating wheelchair.
6. As with any vehicle, the wheels, casters and tires should be checked periodically for cracks and wear, and any defective components should be replaced.
7. Clean quick-release axles once (1) a week with a Teflon® lubricant. DO NOT use WD-40®, 3-in-1 oil®, or other penetrating lubricants on quick release axles. Otherwise, binding and/or damage to the wheelchair may occur.

**B. Tools Required**

The following tools are needed to make adjustments to the wheelchair

1. Philips Screw Driver
2. Allen Keys: 1/8", 5/32", 3/16", 7/32", 1/4"
3. Adjustable or Open-End Wrenches: 3/8", 7/16", 1/2", 9/16", 3/4"
4. Socket Head Driver with Socket Heads: 3/8", 7/16", 1/2", 9/16", 3/4", 1-1/6"

**C. Cleaning**

Periodic cleaning of all surfaces will help keep you wheelchair looking good and operating properly. All surfaces may be cleaned with warm water and a mild detergent. Do not use abrasive cleaners on any surfaces.

**D. Recommended Maintenance Schedule**

CHECK	<i>Initially</i>	<i>Inspect / Adjust Weekly</i>	<i>Inspect / Adjust Weekly</i>	<i>Inspect / Adjust Periodically</i>
GENERAL •Wheelchair rolls straight (No excessive drag or pull to one side).	✓			✓
WHEEL LOCKS •Make sure they are not interfering with tires rolling. •Pivot points are free of wear and looseness. •Wheel locks are easily engaged.	✓		✓	✓
SEAT / BACK UPHOLSTERY •Inspect for rips and sagging. •Inspect fastenings to ensure they are secure.	✓		✓	✓
REAR WHEELS •No excessive side movement or binding when lifted and spun. •Quick-release axles lock properly (if applicable). Inspect wheels and tires for cracks and wear. •Replace when necessary.	✓	✓	✓	✓
FRONT CASTER •Inspect wheelfork assembly. Caster should spin freely. •Wheel bearings are clean and free of moisture. Inspect wheels and tires for cracks and wear. •Replace when necessary.	✓	✓	✓	
CLEANING •Clean upholstery and armrests	✓			✓

## 5. SET-UP AND ADJUSTMENT



After ANY adjustments, repair or service and BEFORE use, make sure all attachment hardware is tightened securely; otherwise, injury or damage may result.

### A. Footrests – Swing-away (70° and 90°)

#### 1. Installation

- a. Turn the footrest to the side (open footplate is perpendicular to wheelchair).
- b. Insert footrest mounting pin into mounting tube.
- c. Rotate the footrest towards the inside of the wheelchair until it locks into place. The footplate will be on the inside of the wheelchair when locked in place.
- d. Repeat this procedure for other footrest assembly.

#### 2. Removal

- a. To release the footrest, push the footrest release lever.
- b. Rotate footrest outward and lift.

#### 3. Adjusting

**NOTE:** Release the footrest locking mechanism and lift the footrest mounting pins out of its mounting tube.

**NOTE:** Make sure to note the position of the washers before disassembly.

- a. Remove impact guards and/or calf strap, if so equipped. Remove the hex screw and coved washer and position the footrest assembly to a determined height.
- b. Line up the mounting hole in the footrest frame, reinsert the hex screw and coved washer; hand-tighten.
- c. Securely tighten the hex screw and coved washer.
- d. Repeat this procedure for the other footrest.
- e. Replace impact guards and/or calf strap, if so equipped.

## B. Locking Flip-up Arms

### 1) Use

- a. Pull actuator D shown in Figure 1 towards the front of the wheelchair.
- b. While holding the actuator of the locking mechanism, lift up on the cantilever arm.  
NOTE: If necessary, the locking mechanism in the cantilever arm can be repositioned so the cantilever arm will open down instead of up. For this adjustment, contact a qualified technician.

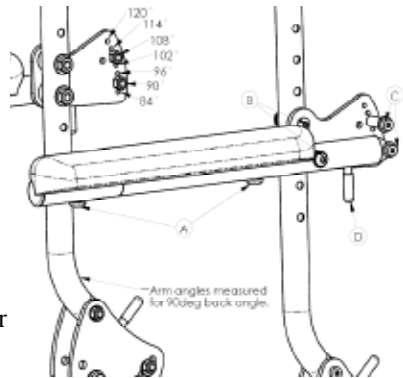

Figure 1

- c. To lock the cantilever arm in the down position, push down until there is an audible click.
- d. Pull up on the cantilever arm to make sure it is locked in place.

### 2) Installation

NOTE: When removing the locknuts and washers from the cantilever arm assembly, leave the top hex bolt, coved washers and spacer (between adjustment plate and cantilever arm) in place.

- a. Place the partially assembled cantilever arm assembly with mounting hardware against the back cane at the desired height. Make sure the adjustment plate is on the outside of the wheelchair.
- b. Insert the bottom bolt (with coved washer) through the adjustment plate and back cane.
- c. Securely tighten the cantilever arm to the wheelchair with two locknuts and washers (B in figure 2).
- d. Adjust the angle of the cantilever arm, if necessary. Refer to Step 3 below in this section of the manual.

### 3) Adjustment

#### e. Arm Angle Adjustment

NOTE: This adjustment is recommended if the back angle has been changed.

- i. Flip the cantilever arm up and out of the way.
- ii. Remove the locknut that secures the locking pin to the arm adjustment plate (C in figure 2).

- iii. Install pin in the mounting hole in the armrest mount plate that gives the desired angle adjustment plate that will be used to correspond to the back angle.

NOTE: Arm angles are displayed in figure 2 for a back at 90°, they vary by 6°, also the pins cannot occupy adjacent holes (i.e. both 90° and 96°).

- iv. Securely tighten the locking pin and washer to the adjustment plate with a locknut.
- v. Repeat STEPS I to iv for the other arm, if necessary.

#### 4) Height Adjustment

- a. Remove fasteners securing the cantilever arm assembly to the back cane (item B as shown in Figure 2).
- b. Remove the cantilever arm assembly with hardware from the back cane.
- c. Perform STEPS a. to d. in Installation section to reposition the arm at the desired height.

#### 5) Arm Depth Adjustment and Arm Pad Replacement

- a. Remove the mounting screws from the armrest pad (A in Figure 2).
- b. Replace with NEW armrest pad and/or adjust to desired length.
  - i. Desk Length Arms - to one of three positions depending on the desired arm pad depth.
  - ii. Full Length Arms - to one of five positions depending on the desired arm pad depth.
- c. Secure with existing hardware.

### C. T-Style Arms

#### Installation

- a. Attach the T-style arm rest receiver using the shoulder bolt (item B in Figure 2) and the button-head cap screw (item E in Figure 2).

NOTE: Make sure the locking lever is towards the front of the wheelchair. Spacers must be added on the far side of the shoulder bolt and between the T-style arm rest receiver and the seat rail for the hex bolt.

- b. Slide the T-style arm into the socket until the locking lever is in the slot in the T-arm socket and an audible “click” is heard.

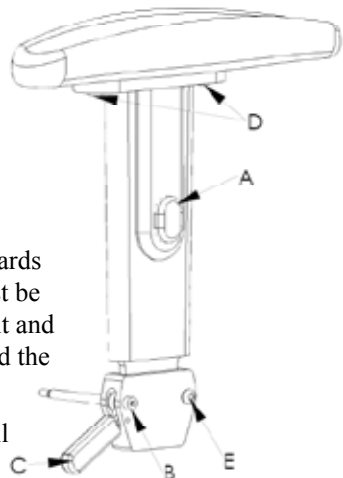

Figure 2

- c. Pull up on the T-style arm to make sure it is locked in place.
- d. Adjust the T-style arm for desired height, width and depth, if necessary.  
Refer to Adjustment instructions in this section of the manual below.
- e. Repeat STEPS 1-4 for opposite side of wheelchair.

#### Removal

- a. Press up on the locking lever, indicated by C in figure 3, and lift the T-style arm straight up and out of the socket.
- b. Repeat for opposite side of the wheelchair.

#### Adjustment

- a. Depth Adjustment
  - i. Remove the two screws that secure the arm pad to the arm tube (item D in Figure 3).
  - ii. Turn the arm pad 180° around and reposition the arm pad on the arm tube.
  - iii. Re-secure the arm pad to the arm tube with the same screws. Tighten securely.
  - iv. Repeat for the opposite side, if necessary.
- b. Height Adjustment
  - i. Depress button A, indicated in figure 3, then pull up or push down on the T-style arm until desired height is reached.
  - ii. Release button A and continue pushing or pulling until an audible “click” is heard and the arm is locked in place.

### D. Back Angle



The back **MUST** be locked securely in place **BEFORE** using the wheelchair.

#### 1. Adjustment – Back Angle Locking Pin Locations

- a. Locking pins in (items A in Figure 3) can be repositioned to change the back angle of the chair.
- b. The available angles start at 84° in the top hole and incremented by 6° for each subsequent hole, as noted in Figure 3.

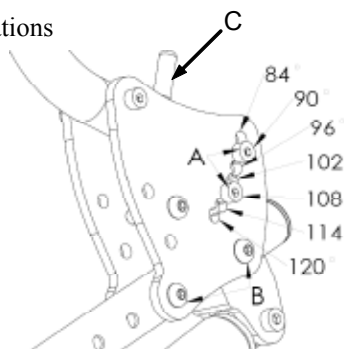

Figure 3

- c. Loosen and withdraw locking pin from back angle support plates.
- d. Reposition to desired location and reinsert and tighten locking pin.

## 2. Selecting Between Back Angles

- a. To adjust between the two locking pin (back angle) positions, lift the actuator handles (item C in Figure 3) on each side of the seat back upwards to release the latches from the pins.
- b. Reposition the seat back to the desired angle and align the latches with the desired pin location and release latches to engage.
- c. Push and pull the back to make sure it is locked in position.

## E. Adjustable Angle Stroller Handle

### 1. Installation

- a. Remove end caps from both back canes.
- b. Slide the adjustable height stroller handle into the back canes.
- c. Secure adjustable angle stroller handle to the back canes with the two quick release pins (C in Figure 4).
- d. If necessary, adjust the height. Refer to ADJUSTMENT in this section of the manual.

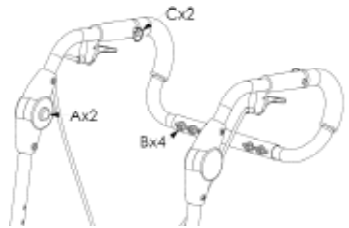

Figure 4

### 2. Removal

- a. Remove the two quick release pins (item C in Figure 4) by pulling on the rings.
- b. Remove the adjustable angle stroller handle from the back cane.
- c. Install end caps on the back canes.

### 3. Adjustment

- a. Angle
  - i. Depress the 2 buttons labeled A in figure 4.
  - ii. Adjust stroller handle to desired angle.
  - iii. Release the buttons and push down on the stroller handle to ensure release levers hold the desired position.

## b. Width

- i. Undo the 4 fasteners (B in Figure 4)
- ii. Insert one half of the stroller handle into a back cane, secure it with a quick release pin (C in figure 5)
- iii. Insert the other half of the stroller handle into the other back cane (previously set to the desired width) and fasten it with a quick release pin. Slide the connecting tube until it lines up with 2 sets of holes on each half of the handle.
- iv. Replace and tighten the fasteners and push on the handle to make sure it's secure.

## F. Quick Release Axles (Optional)



If any adjustments (size or position) to the rear wheels have been made, the anti-tippers must be adjusted to maintain the 1-1/2 to 2-inch clearance. If this adjustment cannot be made with the anti-tippers currently installed, a different model may be required. Consult a qualified technician for assistance.



Make sure detent button and locking balls of the quick-release axles are fully engaged BEFORE operating the wheelchair. The locking balls MUST be protruding past the inside of the axle mounting plate for a positive lock. Keep locking balls clean.

### 1. Installation

- a. Push in the detent button of the quick-release axle and insert the quick-release axle through the center bearings of the rear wheel.
- b. Push in the button of the quick-release axle again and insert the axle (with wheel) into the axle mounting plate on the side of the wheelchair frame until the assembly locks in place.
- c. If the locking balls of the quick-release axles are not protruding past the inside of the axle mounting plate or there is too much movement of the rear wheel assembly in a back and forth position, refer to ADJUSTMENT section below.
- d. Repeat STEPS a to c for other rear wheel assembly.
- e. Adjust the wheel locks. Refer to WHEEL LOCKS SECTION of this manual.

## 2. Removal

- a. Reverse the procedure outlined in the INSTALLATION SECTION above.

## 3. Adjustment

- a. Remove rear wheel and quick-release axle from the wheelchair. Refer to REMOVAL instructions above.
- b. Depress detent button in the quick-release axle and slide axle through the wheel hub bearings.
- c. Increase or decrease axial engagement in the quick-release axle by adjusting the locknut at the end of the quick-release axle.
- d. Reinstall rear wheel onto the wheelchair. Refer to INSTALLATION instructions above.
- e. Release detent button ensuring that the locking balls are fully engaged.
- f. Repeat STEPS a to d above as necessary until the quick-release axle locks properly (the properly adjusted quick release axle should have a maximum axial movement of no more than 1/32" or 1 mm when it is engaged in the axle housing).
- g. Repeat for other wheel, if necessary.

## G. Wheel Locks – Front or Rear



Rear wheel locks are NOT designed to slow or stop a moving wheelchair. Use them only to keep the rear wheels from rolling when the chair is at a complete stop.



When changing the position of the rear wheels, the wheel locks MUST be repositioned.



Ensure pneumatic tires are inflated to the recommended pressure as listed on the sidewall of the tires before adjusting or replacing the wheel lock assemblies



If wheel locks need replacement, installation must be performed by a qualified technician.



## 1. Adjustment

- a. Loosen, but do not remove the two (2) capscrews that secure the wheel lock assembly to the wheelchair frame.
- b. Measure the distance between the WHEEL LOCK SHOE and the REAR WHEEL in the disengaged position.
- c. Slide the wheel lock along the wheelchair frame until the measurement between the SHOE and the REAR WHEEL is between 3/16 and 5/16-inches.
- d. Securely tighten the two (2) capscrews
- e. Repeat STEPS a. to d. for the other wheel lock.
- f. Engage the wheel locks and push against the wheelchair to determine if the wheel locks engage the rear wheels sufficiently to hold the occupied wheelchair.
- g. Repeat STEPS above until the wheel locks engage the rear wheels sufficiently to hold the occupied wheelchair.

## H. Anti-Tip Tubes



A 1-1/2 to 2-inches clearance between the bottom of the anti-tip tube wheels and the ground **MUST** be maintained at all times. If set too high, they may not prevent a tip-over. If set too low, they may interfere with obstacles.



If any adjustments/replacement of the rear wheels have been made, the anti-tip tubes must be adjusted to maintain the 1-1/2 to 2-inch clearance. If this adjustment cannot be made with the anti-tippers currently installed, a different model may be required. Consult a qualified technician for assistance.

### 1. Installation

- a. Depress the release pin
- b. Insert the anti-tip tube into the anti-tip tube receiver mounting bracket.
- c. Turn the anti-tip tube down until release pin is positioned through the receiver mounting hole.
- d. Insert second anti-tip tube the same way.

### 2. Adjustment

- a. Adjust the anti-tip wheels to achieve the proper clearance of 1 1/2" to 2".
- b. Remove the fasteners that hold lower tube to upper tube.
- c. Adjust length of lower tube to one of the predrilled positions.
- d. Reinsert and tighten fasteners.

### 3. Turning Anti-Tip Tubes Up

Turn anti-tip tubes up when being pushed by attendant, overcoming obstacles or climbing curbs.

- a. Press the anti-tip tube release pin.
- b. Hold pin in and turn anti-tip tube up.
- c. Release pin.
- d. Repeat with second anti-tip tube.

## I. Adjustable Seat Tilt



When tilting the seat assembly of the wheelchair, the attendant must hold push handles securely in order to ensure the seat does not drop suddenly.

### 1. Seat Tilt Activation

- a. To adjust the seat tilt angle, activate tilt lever mounted on the push handle.
- b. Change the seat back angle by pushing down or lifting up on push handles.
- c. Release tilt trigger to lock seat in new tilt position.

## J. Seat Height

The seat height is adjusted using a combination of rear wheel mounting locations and rear wheel sizes and front caster sizes. The following charts indicate the possible combinations.

### Fuze T50 Seat Height Options

#### Seat Height

Rear Wheel	5" Casters			
12"	-	13"	14"	
16"	14"	15"	16"	
20"	16"	17"	-	
22"	17"	-	-	

Rear Wheel	6" Casters/6" Fork			
12"	-	-	14"	
16"	14"	15"	16"	
20"	16"	17"	18"	
22"	17"	18"	-	
24"	18"	-	-	

Rear Wheel	6" Casters/8" Fork			
16"	-	15"	16"	
20"	16"	17"	18"	
22"	17"	18"	19"	
24"	18"	19"	-	

Rear Wheel	8" Casters/8" Fork			
16"	-	-	16"	
20"	16"	17"	18"	
22"	17"	18"	19"	
24"	18"	19"	20"	

### Fuze T20 Seat Height Options

#### Seat Height

Rear Wheel	5" Casters					
12"	13"	-	-	-	-	
16"	13"	14"	15"	-	-	
20"	13"	14"	15"	16"	17"	
22"	14"	15"	16"	17"	-	
24"	-	15"	16"	17"	-	

Rear Wheel	6" Casters/6" Fork					
16"	14"	15"	-	-	-	
20"	14"	15"	16"	17"	-	
22"	14"	15"	16"	17"	18"	
24"	-	15"	16"	17"	18"	

Rear Wheel	6" Casters/8" Fork					
16"	15"	-	-	-	-	
20"	15"	16"	17"	-	-	
22"	15"	16"	17"	18"	-	
24"	15"	16"	17"	18"	19"	

Rear Wheel	8" Casters/8" Fork					
20"	16"	17"	-	-	-	
22"	16"	17"	18"	-	-	
24"	16"	17"	18"	19"	-	



Any adjustments to seat height must be performed by a qualified technician.

\* 13” Seat height is only available with 12” urethane rear wheels.

#### 1. Rear Axle Adjustment

- a. Remove rear wheels and rear axles to expose axle receivers
- b. Loosen and remove locknut holding axle receiver to axle plate
- c. Withdraw axle receiver from axle plate and reposition to new desired location

Note: PDG recommends the axle receiver be positioned in the rearmost set of holes for additional stability when the chair is in tilt.

- d. Tighten locknut to lock axle receiver to axle plate.
- e. Repeat for other side.

#### 2. Caster Fork Height Adjustment

- a. The front caster fork has 2 positions that are 1” apart.
- b. To reposition the caster wheel to a different position on the caster fork, loosen the locknut and remove the capscrew holding the wheel to the fork assembly.
- c. Reposition wheel to new location and insert capscrew.
- d. Tighten locknut.

### K. Seat Depth



Any adjustments to seat depth must be performed by a qualified technician.

Wheelchair seat depth may be adjusted from 15” to 20” deep. Seat depth is adjusted by adjusting the front seat rail extensions and/or by adjusting the back support brackets.

#### 1. Seat Depth Adjustment

- a. Remove the two (2) fasteners holding the front seat rail extension to the seat rail.
- b. Reposition the front seat rail extension to the desired position.
- c. Reinstall the two fasteners.
- d. Remove the two (2) fasteners holding back support bracket to seat rail.
- e. Reposition the back support bracket to the desired position.
- f. Reinstall the two fasteners.
- g. Repeat for the other side.

## L. Seat Width



Any adjustments to chair width must be performed by a qualified technician

- a. Remove the four fasteners from each cross brace.
- b. Adjust to desired width (15" to 20").
- c. Tighten fasteners.

## 6. SET UP GUIDELINES

See appendix for set up guidelines.

## 7. TESTING

The Fuze wheelchairs have been designed to meet the following standards:  
ANSI/RESNA WC.19 and ISO 7176.

Upholstery specifications meet the State of California Technical Bulletin 117 Section D.

## 8. LIMITED WARRANTY

PLEASE NOTE: THE WARRANTY BELOW HAS BEEN DRAFTED TO COMPLY WITH FEDERAL LAW APPLICABLE TO PRODUCTS MANUFACTURED AFTER JULY 4, 1975.

This warranty is extended only to the original purchaser/user of our products.

This warranty gives you specific legal rights and you may also have other legal rights, which vary from state to state.

PDG warrants its product, except for the seat cushion (which is not warranted), to be free from defects in materials and workmanship for a period of one (1) year from date of purchase. The side frames and cross-members are warranted for the lifetime of the original purchaser/user. If within such warranty period any such product shall be proven to be defective, such product shall be repaired or replaced, at PDG's option. This warranty does not include any labor or shipping charges incurred in replacement part installation or repair of any such product. PDG's sole obligation and your exclusive remedy under this warranty shall be limited to such repair and/or replacement.

For warranty service, please contact the dealer from whom you purchased your PDG product. In the event you do not receive satisfactory warranty service, please write directly to PDG at the address on the back cover page, provide dealer's name, address, and date of purchase, indicate nature of the defect and, if the product is serialized, indicate the serial number. Do not return products to our factory without our prior consent.

Limitations and exclusions: the foregoing warranty shall not apply to serial numbered products if the serial number has been removed or defaced, products subjected to negligence, accident, improper operation, maintenance or storage, products modified without pdg's express written consent including, but not limited to, modification through the use of unauthorized parts or attachments; products damaged by reason of repairs made to any component without the specific consent of pdg, or to a product damaged by circumstances beyond pdg's control, and such evaluation will be solely determined by pdg. The warranty shall not apply to problems arising from normal wear or failure to adhere to these instructions. The foregoing express warranty is exclusive and in lieu of any other warranties whatsoever, whether express or implied, including the implied warranties of merchantability and fitness for a particular purpose, and the sole remedy for violations of any warranty whatsoever, shall be limited to repair or replacement of the defective product pursuant to the terms contained herein. The application of any implied warranty whatsoever shall not extend beyond the duration of the express warranty provided herein. The manufacturer shall not be liable for any consequential or incidental damages whatsoever.

This warranty shall be extended to comply with state/provincial laws and requirements.

# Appendix Table 1

## Fuze Setup Guidelines

**Table 1. Seat Height Adjustments**









- Using Table # 1 below, find the Rear Wheel size, Caster / Fork size, and Seat Height desired.
- Using Table # 2, set up configurations for Axle Position (AP), Caster Journal Size (CJ), Caster Fork Position (CFP), and Setup Distance (SD).

Table # 1		Seat Height		Rear Wheel	Seat Height		Seat Height		Seat Height	
Rear Wheel	6" Fork / 5" Caster		6" Fork / 6" Caster		Rear Wheel	6" Fork / 8" Caster		8" Fork / 8" Caster		Rear Wheel
12"	13" AP(2) CJ-S CFP-2* SD(1.5")	14" AP(3) CJ-S CFP-2* SD(1.5")	X	X	12"	X	X	X	X	12"
	15" AP(1) CJ-M CFP-1* SD(1.5")	16" AP(3) CJ-M CFP-2* SD(2.5")	14" AP(3) CJ-S CFP-2 SD(1.5")	15" AP(2) CJ-S CFP-2 SD(1.5")		16" AP(3) CJ-S CFP-2 SD(1.5")	15" AP(2) CJ-S CFP-1 SD(3.75")	16" AP(3) CJ-L-S CFP-2 SD(3.75")	17" AP(2) CJ-M CFP-2 SD(1.375")	
16"	14" AP(1) CJ-M CFP-1* SD(1.5")	15" AP(2) CJ-M CFP-2* SD(2.5")	14" AP(1) CJ-S CFP-1 SD(1.5")	15" AP(2) CJ-S CFP-2 SD(1.5")	16"	X	X	X	X	16"
	16" AP(1) CJ-L CFP-1 SD(3")	17" AP(2) CJ-L CFP-2 SD(3")	16" AP(1) CJ-L CFP-1 SD(2.5")	17" AP(2) CJ-L CFP-2 SD(2.5")		16" AP(1) CJ-M CFP-1 SD(1.375")	17" AP(2) CJ-M CFP-2 SD(1.375")	18" AP(3) CJ-M CFP-2 SD(2.375")	19" AP(2) CJ-S CFP-2 SD(3.75")	
20"	17" AP(1) CJ-L CFP-1 SD(3")	18" AP(2) CJ-L CFP-2 SD(3")	17" AP(1) CJ-L CFP-1 SD(2.5")	18" AP(2) CJ-L CFP-2 SD(2.5")	20"	X	X	X	X	20"
	19" AP(1) CJ-L CFP-2 SD(3")	20" AP(2) CJ-L CFP-2 SD(3")	18" AP(1) CJ-L CFP-1 SD(3.5")	19" AP(2) CJ-L CFP-2 SD(3.5")		17" AP(1) CJ-M CFP-1 SD(1.375")	18" AP(2) CJ-M CFP-2 SD(1.375")	19" AP(3) CJ-L CFP-2 SD(2.375")	20" AP(2) CJ-M CFP-2 SD(3.75")	
22"	18" AP(1) CJ-L CFP-2 SD(3")	19" AP(2) CJ-L CFP-2 SD(3.5")	18" AP(1) CJ-L CFP-1 SD(3.5")	19" AP(2) CJ-L CFP-2 SD(3.5")	22"	X	X	X	X	22"
	20" AP(1) CJ-L CFP-2 SD(3")	21" AP(2) CJ-L CFP-2 SD(3.5")	19" AP(1) CJ-L CFP-1 SD(3.5")	20" AP(2) CJ-L CFP-2 SD(3.5")		18" AP(1) CJ-M CFP-1 SD(1.375")	19" AP(2) CJ-M CFP-2 SD(1.375")	20" AP(3) CJ-L CFP-2 SD(2.375")	21" AP(2) CJ-M CFP-2 SD(3.75")	
24"	20" AP(1) CJ-L CFP-2 SD(3.5")	21" AP(2) CJ-L CFP-2 SD(3.5")	20" AP(1) CJ-L CFP-1 SD(3.5")	21" AP(2) CJ-L CFP-2 SD(3.5")	24"	X	X	X	X	24"
	22" AP(1) CJ-L CFP-2 SD(3.5")	23" AP(2) CJ-L CFP-2 SD(3.5")	21" AP(1) CJ-L CFP-1 SD(3.5")	22" AP(2) CJ-L CFP-2 SD(3.5")		18" AP(1) CJ-L CFP-1 SD(2.5")	19" AP(2) CJ-L CFP-2 SD(2.5")	20" AP(3) CJ-L CFP-2 SD(3.75")	21" AP(2) CJ-L CFP-2 SD(3.75")	

\* With Caster Forks having 3 holes, the middle hole should be ignored for the purposes of the set up guide. The top hole of the 3 will be considered to be Hole #1, the bottom hole of the 3 will be considered to be Hole #2. The middle hole of the 3 will not be used.

# Appendix Table 2

Table 2.

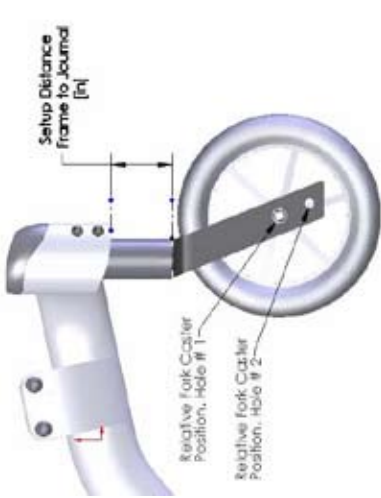
Axle Position (AP) Options		Caster Journal (CJ) Sizes			Caster Fork Position (CFP)		Setup Distance (SD)	
								
AP (1) A		P (2)	AP (3)	CJ - S (3.125") Short	CJ - M (4.125") Medium	CJ - L (5.125") Long	CFP - 1	CFP - 2

# Appendix

## Table 3 and Table 4

### Seat Pan Sizes

#### Seat Pan Dimensions

The following Table # 3 shows the seat pan sizes available from PDG. All seat pans will grow 2" in width and 2" in depth from the stated size below:

**Table 3**

Seat Pan	Seat Pan Dimension
A	15" W x 15" D
B	15" W x 18" D
C	16" W x 16" D
D	16" W x 20" D
E	17" W x 17" D
F	18" W x 15" D
G	18" W x 18" D
H	18" W x 20" D

#### Seat Pan Size Options

For any given seat dimension (for example, 16" W x 16" D or 17 " W x 18" D), there may be more than pan suitable Seat Pan to fit. Table 4 below shows the various options available for any given seat Width and Depth. The shaded option is the seat pan PDG ships on the chair because it gives the most growth upward from the starting position.

**Table 4**

		Seat Depth																	
		15"			16"			17"			18"			19"			20"		
Seat Width	15"	A			A			A			B			B			B		
	16"	A	A	C	A		C	B			C	B			B		D		
	17"	A	A	C	A	C	E	B	C	E	B	E	B		D		D		
	18"	F	C	F	C	E	F	C	E	G	E	G	D	G		H			
	19"	F	F			E	F	E	G	E	G	G		H					
	20"	F	F			F			G			G			G		H		

# Appendix

## Table 5

Seat Pan Size Overlap

The following Table 5 shows the overlap of the seat pans available.

**Table # 5**

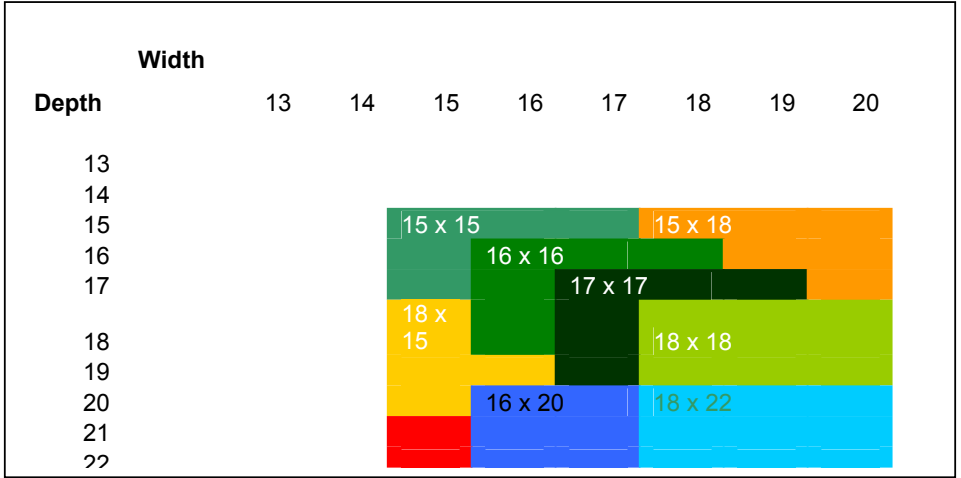





# Appendix Table 7

**Table # 7 Fuze T50 Set Up Guide**

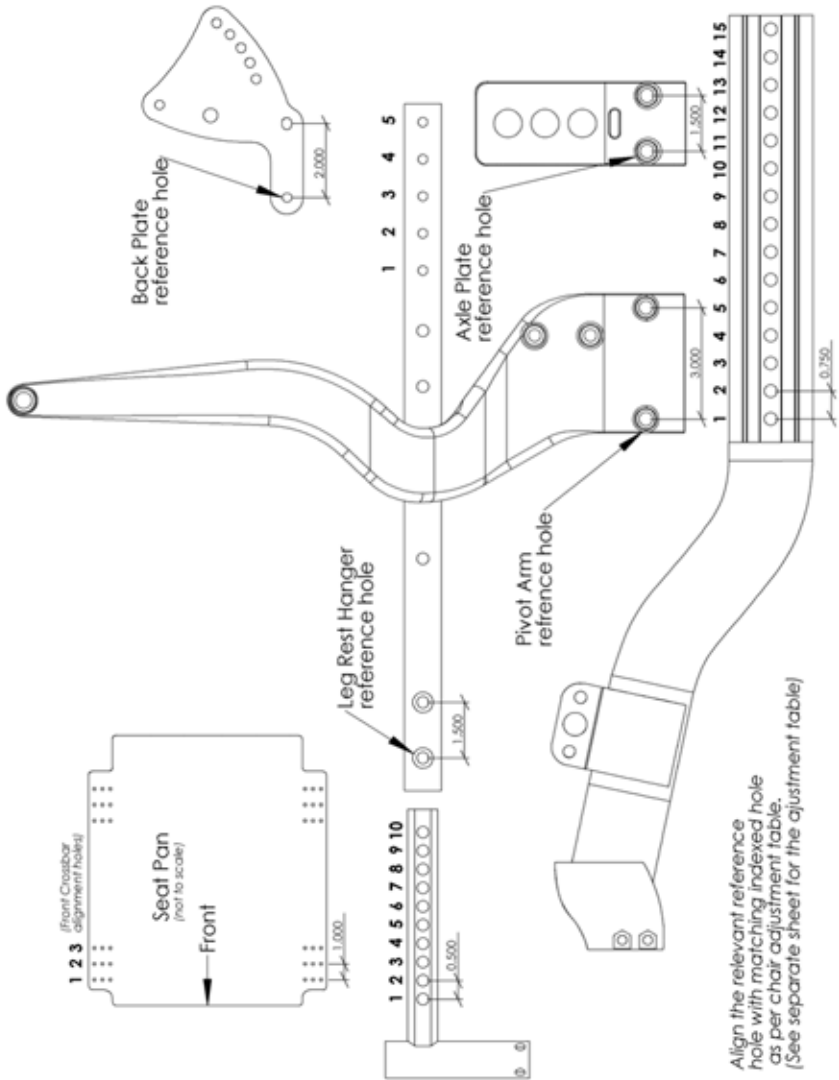





Product Design Group Inc.

Unit 103

318 East Kent Avenue South

Vancouver, BC

Canada V5X 4N6

Customer Service: 604-323-9220

Toll Free In N. America: 1-888-858-4422

[www.PDGmobility.com](http://www.PDGmobility.com)