



Your Source for Home Comfort

(5,000 BTU)
**WINDOW
AIR CONDITIONER**

USER MANUAL

FOR MODELS:

PES5000



Before using your window air conditioner, please read this manual carefully and keep it for future reference, along with your receipt.



CONTENTS

SAFETY PRECAUTIONS	2
IMPORTANT SAFETY INSTRUCTIONS	4
NORMAL SOUNDS	5
AIR CONDITIONER FEATURES	5
INSTALLATION INSTRUCTIONS	9
CARE AND CLEANING	13
TROUBLESHOOTING TIPS	14

This manual provides the information needed for proper use and maintenance of this air conditioner. Basic preventative care can help extend the life of this unit. The “Troubleshooting Tips” section in this manual contains a chart with solutions to the most common problems. Referring to this section may save time and prevent the need for a service call in the event of a problem.

CAUTION



- Contact an authorized service technician for repair or maintenance of this unit.
- Contact an installer for installation of this unit if necessary.
- ***The air conditioner is not intended for use by young children without supervision.***
Young children should be supervised to ensure that they do not play with the air conditioner.
- Disabled persons may require assistance with set up.
- If the power cord is to be replaced, replacement work should be performed by authorized personnel only.
- Installation and repair work must be performed in accordance with the national wiring standards by authorized personnel only.
- Do not operate your air conditioner in a wet room such as a bathroom or laundry room.

NOTE: *All the illustrations in this manual are for explanation purposes only. Unit purchased may be slightly different.*



The design and specifications are subject to change without prior notice for product improvement. Contact customer service for details.

SAFETY PRECAUTIONS

















To prevent injury to the user or other people and property damage, the following instructions must be followed. Incorrect operation due to ignoring of instructions may cause harm or damage. The seriousness is classified by the following indications.

 WARNING	This symbol indicates the possibility of death or serious injury.
 CAUTION	This symbol indicates the possibility of injury or damage to property.

■ Meanings of symbols used in this manual are as shown below.

	Never do this.
	Always do this.

WARNING

 Plug in power plug properly.	 Do not operate or stop the unit by inserting or pulling out the power plug directly from the wall.	 Do not use a damaged power cord.
● Failure to do so may cause electric shock or fire due to excess heat generation.	● Doing so may cause electric shock or fire due to heat generation.	● Doing so may cause electric shock or fire. If the power cord is damaged, it must be replaced by the manufacturer or an authorized service center or a similarly qualified person in order to avoid a hazard.
 Do not modify power cord length or share the outlet with other appliances.	 Do not operate with wet hands or in damp environment.	 Do not direct airflow directly at room occupants.
● Doing so may cause electric shock or fire due to heat generation.	● Doing so may cause electric shock.	● This could cause health issues.
 Always ensure effective grounding.	 Do not allow water to run into electric parts.	 Always install circuit breaker and a dedicated power circuit.
● Incorrect grounding may cause electric shock.	● Doing so may cause failure of machine or electric shock.	● Incorrect installation may cause fire and electric shock.
 Always unplug the unit if strange sounds, smell or smoke comes from the unit.	 Do not use the socket if it is loose or damaged.	 Do not open the unit during operation.
● Failure to do so may cause fire and electric shock.	● Doing so may cause fire and electric shock.	● Doing so may cause electric shock.
 Do not use firearms near unit.	 Do not use the power cord close to heating appliances.	 Do not disassemble, modify, or drill holes into the air conditioner.
● Doing so may cause fire.	● Doing so may cause fire and electric shock.	● Doing so may cause failure and electric shock.
 Ventilate room before operating air conditioner if there is a gas leakage from another appliance such as a stove.	 Do not use the power cord near flammable gas or combustibles, such as gasoline, benzene, thinner, etc.	
● Failure to do so may cause explosion, fire and burns.	● Doing so may cause an explosion or fire.	



CAUTION

⊘ When removing air filter, do not touch metal parts of the unit.

- Doing so may cause an injury.

⊘ Do not clean with water.

- Water may enter the unit and degrade the insulation causing an electric shock.

⚠ Ensure proper ventilation especially in rooms with a stove or other appliances.

- Failure to do so may result in an oxygen shortage.

⚠ Unit and Circuit breaker/fuse must be switched OFF when cleaning.

- Cleaning unit when power is ON may cause fire and electric shock and may cause an injury.

⊘ Do not put a pet or house plant where it will be exposed to direct air flow.

- This could injure the pet or plant.

⚠ Use only as intended.

- This unit is NOT intended to preserve precision devices, food, pets, plants, and art objects. It may cause deterioration of quality, etc.

⚠ Stop operation and close the window in severe storms or hurricanes.

- Operation with windows open may cause moisture to enter the room.

⚠ Hold the plug by the head of the power plug when taking it out.

- Failure to do so may cause electric shock and damage.

⚠ If unit will not be used for a long period of time, turn OFF main power switch.

- Leaving power on may cause unit failure or fire.

⊘ Do not place obstacles around air-inlets or inside of air-outlet.

- Obstacles may cause appliance failure or accident.

⚠ Periodically check installation bracket for damage.

- Prolonged exposure to outdoor elements may cause damage to installation bracket causing unit to fall.

⚠ Always insert the filters securely. Clean filter AT LEAST once every two weeks.

- Operation without secured filters may cause failure. A dirty filter can cause the unit to not run efficiently.

⚠ Use only a soft cloth to clean the unit.

- Cleaners or detergents may change the color or scratch the surface of the unit.

⚠ Use caution when unpacking and installing.

- Sharp edges could cause injury.

⊘ NEVER drink water drained from air conditioner.

- Water from unit contains contaminants and could cause illness.

⊘ Do not place heavy objects on the power cord and always ensure that the cord is not compressed.

- There is danger of fire or electric shock.

⚠ If water enters the unit, turn the unit off at the power outlet and switch off the circuit breaker. Isolate supply by taking the power-plug out and contact a qualified serviced technician.

- There is danger of electric shock.

Meeting Electrical Requirements



WARNING

Electrical Shock and Personal Injury Hazard

- Electrical ground is required on this appliance.
 - DO NOT ground to a gas line.
 - If cold water pipe is interrupted by using plastic, non-metallic gaskets, or other insulating materials. DO NOT use for grounding.
 - Check with a qualified electrician if you are in doubt as to whether the appliance is properly grounded.
 - DO NOT modify power supply cord plug. If it does not fit the outlet, have a proper outlet installed by a qualified electrician.
 - DO NOT have a fuse in the neutral or grounding circuit.
- A fuse in the neutral, or grounding circuit could result in an electrical shock.
- DO NOT use an extension cord with this appliance.

Failure to follow these instructions could result in electrical shock, serious injury, or death.

Observe all local governing codes and ordinances.

Do not, under any circumstances, remove the power supply cord grounding prong.

NOTE: If codes permit, and a separate grounding wire is used, it is recommended that a qualified electrician determine that the grounding path is adequate and not interrupted by plastic, non-metallic gaskets, or other insulating materials.

Receptacle Wiring

Receptacle wiring should be a minimum of 14 gauge. Use copper wire only. It is your responsibility to provide proper and adequate receptacle wiring, installed by a qualified electrician.

Electrical Requirements

A time delay fuse or time delay circuit breaker is also required. A separate circuit, serving only this appliance, MUST be provided.

IMPORTANT SAFETY INSTRUCTIONS

NOTE The power supply cord with this air conditioner contains a current detection device designed to reduce the risk of fire. Please refer to the section "Operation of Current Device" (below) for details. In the event that the power supply cord is damaged, it **MUST** be replaced by an authorized repairman.

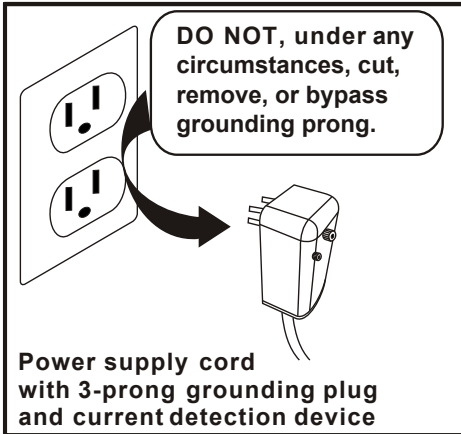

⚠️ WARNING! For Your Safety

- DO NOT store or use gasoline or other flammable vapors or liquids in the vicinity of this or any other appliance.
- Avoid fire hazard or electric shock. DO NOT use an extension cord or an adaptor plug. DO NOT remove any prong from the power cord.

⚠️ WARNING! Electrical Information

- Be sure the electrical service is adequate for the model you have chosen. This information can be found on the serial plate, which is located on the side of the cabinet and behind the grille.
- Be sure the air conditioner is properly grounded. To minimize shock and fire hazards, proper grounding is important. The power cord is equipped with a three-prong grounding plug for protection against shock hazards.
- Your air conditioner must be used in a properly grounded wall receptacle. If the wall receptacle you intend to use is not adequately grounded or protected by a time delay fuse or circuit breaker, have a qualified electrician install the proper receptacle.
- Ensure the receptacle is accessible after the unit installation.
- Do not run air conditioner without side protective cover in place. This could result in mechanical damage within the air conditioner.
- **Do not use an extension cord or an adaptor plug.**

Operation of Current Device

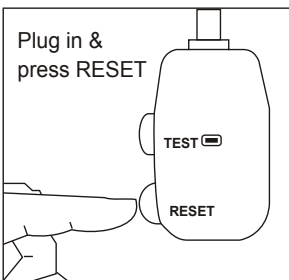

NOTE: Some plugs have buttons on the top.

The power supply cord contains a current device that senses damage to the power cord. To test your power supply cord do the following:

1. Plug in the air conditioner.
2. The power supply cord will have TWO buttons on the plug head. Press the TEST button. The RESET button will click as it pops out.
3. Press the RESET button; again you will notice a click as the button engages.
4. The power supply cord is now supplying electricity to the unit.
(On some products this is also indicated by a light on the plug head.)

NOTES:

- Do not use this device to turn the unit on or off.
- Always make sure the RESET button is pushed in for correct operation.
- The power supply must be replaced if it fails to reset when either the TEST button is pushed or it cannot be reset.
- If power supply cord is damaged, it cannot be repaired. Please call customer service to assist with replacement.

NOTE: This air conditioner is designed to be operated under conditions as follows:

Cooling operation	Outdoor temp:	18-43°C/64-109°F (18-52°C/64-125°F for special tropical models)
	Indoor temp:	17-32°C/62-90°F

If the unit is operated beyond the conditions specified above, it may cause a failure of the unit.

AIR CONDITIONER FEATURES (CONTINUED)

NOTE: The following instructions represent the Unit Controls.
The same instructions can be used for the Remote Control.

TO TURN UNIT ON:

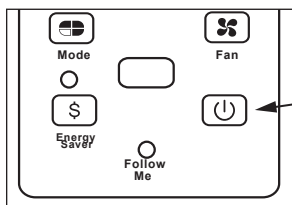

DO THIS:
Press the
"On/Off" button.

NOTE: The unit will automatically initiate the Energy Saver function under "Cool," "Dry" and "Auto" (only Auto-Cooling and Auto-Fan) modes.

TO CHANGE TEMPERATURE SETTING:

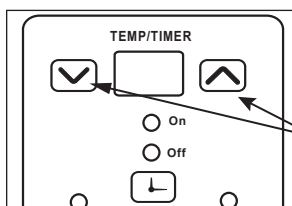

DO THIS:
Press to adjust
temperature setting

NOTE: (UP/DOWN button)

Press or hold either Up (▲) or Down (▼) button until the desired temperature is seen on the display. This temperature will be automatically maintained anywhere between 62°F (17°C) and 86°F (30°C). If you want the display to read the actual room temperature, see "To Operate on Fan Only" section.

TO ADJUST FAN SPEEDS:

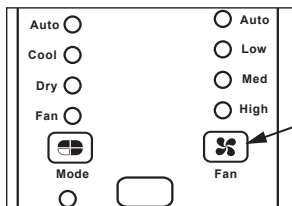

DO THIS:
Press "Fan" to
select fan speed

NOTE: (FAN button)

There are four (4) fan speeds: "Auto," "Low," "Med" or "High." Each time the button is pressed, the fan speed mode is shifted. On "Dry" mode the fan speed is controlled at low automatically.

TO SELECT THE OPERATING MODE:

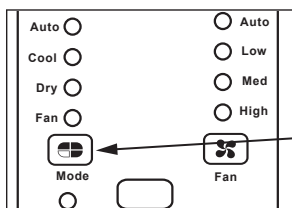

DO THIS:
Press the
"Mode" button.

NOTE: MODE button

To choose operating mode, press the "Mode" button. Each time you press the button, a mode is selected in a sequence that goes from "Auto," "Cool," "Dry," and "Fan." The indicator light will be illuminated and remain on once the mode is selected.

The unit will automatically initiate the Energy Saver function under "Cool," "Dry," and "Auto" (only Auto-Cooling and Auto-Fan) modes.

To operate on "Auto" feature:

When you set the air conditioner in "Auto" mode, it will automatically select cooling or fan only operation depending on what temperature you have selected and the room temperature. The air conditioner will control room temperature automatically around the temperature you set.

In this mode, the fan speed cannot be adjusted. It starts automatically at a speed according to the room temperature. If the room does not get too warm, it will stay at "Low" speed.

AIR CONDITIONER FEATURES (CONTINUED)

TO USE THE ENERGY SAVER FEATURE:

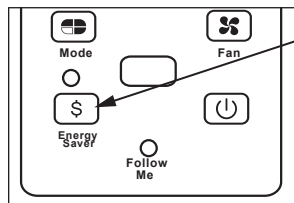

DO THIS:
Press the
“Energy Saver”
button

To operate on “Fan” only (not available on all models):

Use this function only when cooling is not desired, such as for room air circulation or to exhaust stale air. (Remember to open the vent during this function, but keep it closed during cooling for maximum cooling efficiency.) You can choose any fan speed you prefer. During this function, the display will show the actual room temperature, not the set temperature as in the cooling mode.

To operate on “Dry” mode:

In this mode, the air conditioner will reduce air humidity. If the space is a closed or sealed area, some degree of cooling will continue.

NOTE: ENERGY SAVER button

This function is available on “Cool,” “Dry,” and “Auto” (only Auto-Cooling and Auto-Fan) modes. In this mode, the fan will continue to run for 3 minutes after the compressor shuts off. The fan then cycles on for 2 minutes, at 10 minute intervals, until the room temperature is above the set temperature, at which time the compressor turns back on and cooling starts.

NOTE: SLEEP button

In this mode the selected temperature will increase (cooling) or decrease (heating - units with heater only) by 2°F/1°C 30 minutes after the mode is selected. The temperature will then increase (cooling) or decrease (heating - units with heater only) by another 2°F/1°C after an additional 30 minutes. This new temperature will be maintained for 6 hours before it returns to the originally selected temperature. This ends the Sleep mode and the unit will continue to operate as originally programmed. The Sleep mode program can be cancelled at any time during operation by pressing the “Sleep” button again.

SLEEP FEATURE:

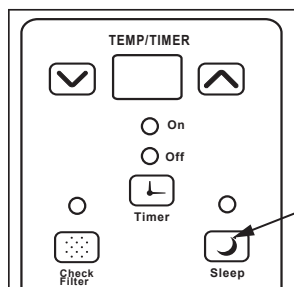

DO THIS:
Press “Sleep”
button

NOTE: TIMER button

First press the “Timer” button. The indicator light beside the word “On” will illuminate indicating the Auto Start program is on.

Press or hold the Up or Down Temp/Timer arrows to change the Auto time by 0.5 hour increments, up to 10 hours, then at 1 hour increments up to 24 hours. The control will count down the time remaining until start. The selected time will register for 5 seconds and the system will automatically revert back to display the previous temperature setting.

When the “Timer On” is displayed, press the “Timer” button again and the “Timer Off” indicator light illuminates. It indicates the Auto Stop program is initiated.

Turning the unit on or off at any time or adjusting the timer setting to 0.0 will cancel the Auto Start/Stop function.

TIMER: AUTO START/ STOP FEATURE:

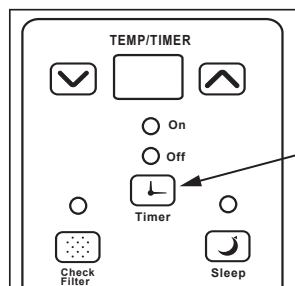

DO THIS:
Press “Timer”
button

AIR CONDITIONER FEATURES (CONTINUED)

CHECK FILTER FEATURE:

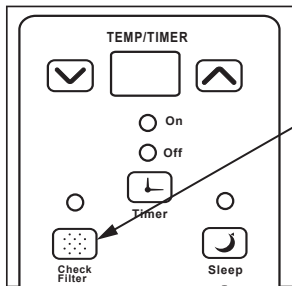

DO THIS:
Press "Check Filter" button

NOTE: CHECK FILTER button

This feature is a reminder to clean the Air Filter for more efficient operation. The LED (light) will illuminate after 250 hours of operation. To reset after cleaning the filter, press the "Check Filter" button and the light will go off.

NOTE: FOLLOW ME indicator light

This feature can ONLY be activated from the remote control. The remote control serves as a remote thermostat allowing for precise temperature control at its location.

FOLLOW ME FEATURE: (on some models)

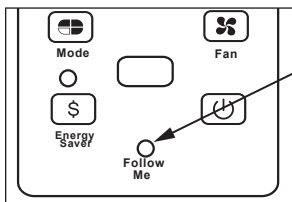

Light flashing

To activate the Follow Me feature, point the remote control towards the unit and press the "Follow Me" button. The remote displays the actual temperature at its location. The remote control will send this signal to the air conditioner every 3 minutes until the "Follow Me" button is pressed again. If the unit does not receive the "Follow Me" signal during any 7 minute interval, the unit will beep to indicate the Follow Me mode has ended. The actual temperature can be displayed at the unit by pressing the "Fan" only mode. When in the "Cool" mode, the unit display indicates the set temperature.

DISPLAYS:

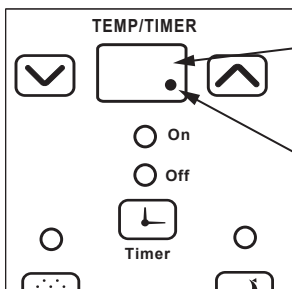

Displays

NOTE: DISPLAYS

Shows the set temperature in "°C" or "°F" and the Auto-timer settings. While on "Fan" only mode, it shows the room temperature.

Error Codes:

- AS - Room temperature sensor error** - Unplug the unit and plug it back in. If error repeats, call customer service.
- HS - Electric heating sensor error** - Unplug the unit and plug it back in. If error repeats, call customer service.
- - **Evaporator temperature sensor error** - Unplug the unit and plug it back in. If error repeats, call customer service. ("•" is displayed as shown in left picture.)

NOTE: If the unit breaks off unexpectedly due to power being cut, it will restart with the previous function setting automatically when the power resumes.

NOTE: In "Fan" only mode, unit will display "Lo" or "Hi".

ADDITIONAL THINGS YOU SHOULD KNOW

- The Cool circuit has an automatic 3 minute time delayed start if the unit is turned off and on quickly. After unit is turned off, leave unit off for a minimum of 3 minutes before attempting to turn back on. This prevents overheating of the compressor and possible circuit breaker tripping. The fan will continue to run during this time.
- The control is capable of displaying temperature in degrees Fahrenheit or degrees Celsius. To convert from one to the other, press and hold the Up and Down Temp/Timer buttons at the same time, for 3 seconds.

Air Directional Louvers

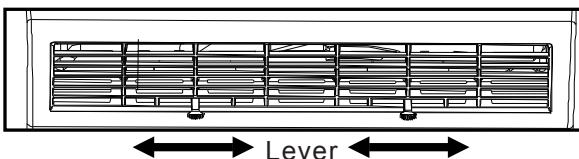

HOW TO USE:

The louvers will allow you to direct the air flow left or right throughout the room as needed.

Move the levers from side to side until the desired left/right direction is obtained.

INSTALLATION INSTRUCTIONS



BEFORE YOU BEGIN

Read these instructions completely and carefully.

IMPORTANT- Save these instructions.

IMPORTANT- Observe all governing codes and ordinances.

Note to Installer- Be sure to leave these instructions with the Consumer.

Note to Consumer- Keep these instructions for future reference.

Skill level- Installation of this appliance requires basic mechanical skills.

Completion time- Approximately 1 hour.

We recommend that two people install this product.

Proper installation is the responsibility of the installer.

Product failure due to improper installation is not covered under the Warranty.

You **MUST** use all supplied parts and use proper installation procedures as described in these instructions when installing this air conditioner.



WINDOW REQUIREMENTS

Your air conditioner is designed to install in standard double hung windows with opening widths of 23 to 36 inches (584 mm to 914 mm).

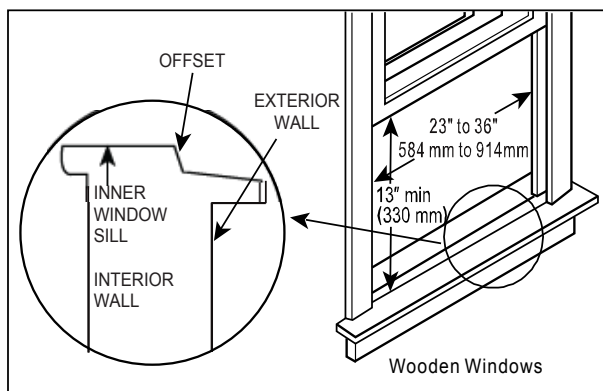

CAUTION

Do not, under any circumstances, cut or remove the third (ground) prong from the power cord.

Do not change the plug on the power cord of the air conditioner.

Aluminum house wiring may present special problems- consult a qualified electrician.

When handling unit, be careful to avoid cuts from sharp metal edges and aluminum fins on front and rear coils.

TOOLS YOU WILL NEED

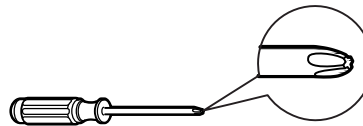

**Phillips
Screwdriver**



Level

TOOLS YOU MAY USE



Screwdriver



Pencil

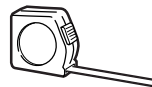

Ruler or tape measure

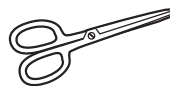

Scissors or knife

NOTE: Save carton and these Installation Instructions for future reference.
The carton is the best way to store unit during winter or when not in use.

INSTALLATION INSTRUCTIONS (CONTINUED)

1 PREPARE THE WINDOW

Lower sash must open sufficiently to allow a clear vertical opening of 13 inches (330 mm). Side louvers and the rear of the AC must have clear air space to allow enough airflow through the condenser, for heat removal. The rear of the unit must be outdoors, not inside a building or garage.

Mounting Hardware

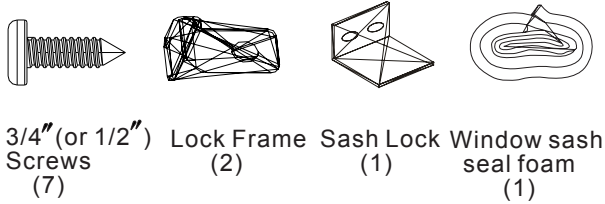

2 PREPARE AIR CONDITIONER

A: Remove the air conditioner from the carton and place on a flat surface.

B: Remove top rail from the rear of the packaging material as shown in Fig. A.

Top Rail Hardware

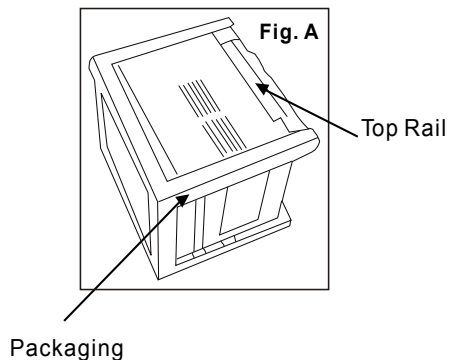
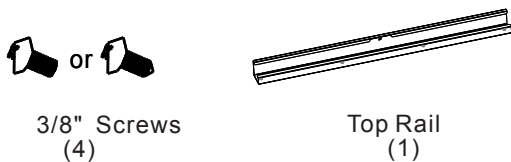

C: Align the hole in the top rail with those in the top of the unit as shown in Fig.B

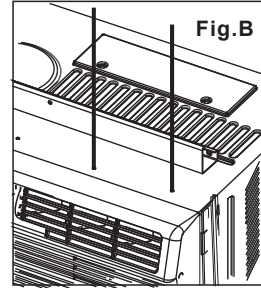

D: Secure the top rail to the unit with the 3/8" screws as shown in Fig.C.

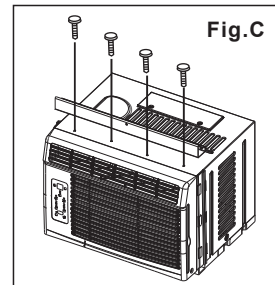

NOTE: For safety reasons, all four(4) screws MUST be securely fastened.

3 INSTALL THE ACCORDION PANELS

NOTE: Top rail and sliding panels at each side are offset to provide the proper pitch to the rear of (5/16"). This is necessary for proper condensed water utilization and drainage. If you are not using the side panels for any reason, this pitch to the rear must be maintained.

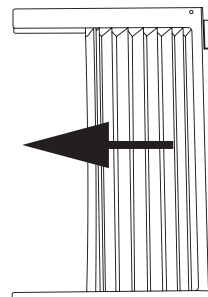

A. Place unit on floor, a bench or a table. Hold the accordion panel in one hand and gently pull back the center to fill the open end. See Fig. 1.

INSTALLATION INSTRUCTIONS (CONTINUED)

- B. Slide the free end "Γ" section of the panel directly into the cabinet as shown in Fig. 2. Slide the panel down. Be sure to leave enough space to slip the top and bottom of the frame into the rails on the cabinet.

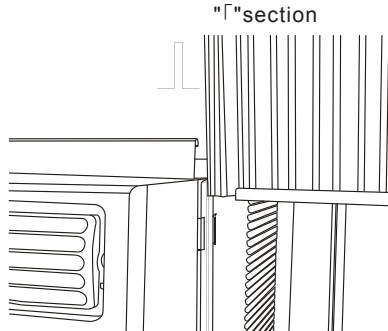

Fig. 2

- C. Once the panel has been installed on the side of the cabinet, make sure it sits securely inside the frame channel by making slight adjustments. Slide the top and bottom ends of the frame into the top and bottom rails of the cabinet. Fig. 3.

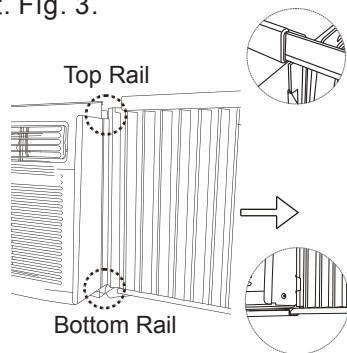

Fig. 3

- D. Slide the panel all the way in and repeat on the other side.

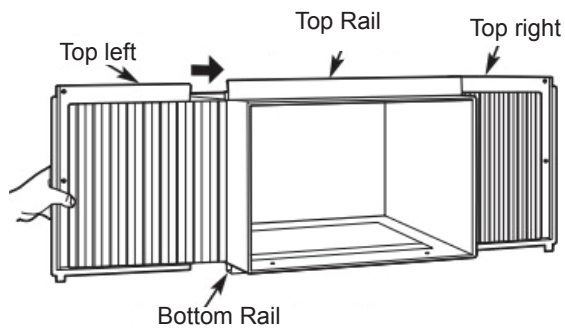
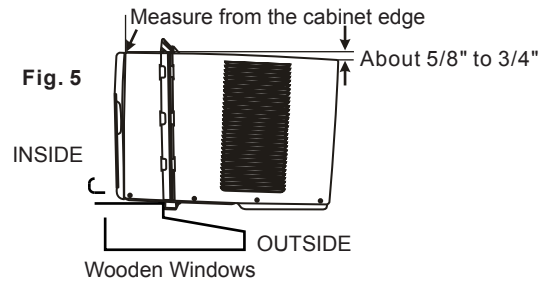

Fig. 4

NOTE: If storm window blocks AC, see Fig. 11.

4 SECURE THE ACCORDION PANELS

- A. Keeping a firm grip on the air conditioner, carefully place the unit into the window opening so the bottom of the air conditioner frame is against the window sill (Fig. 5). Carefully close the window behind the top rail of the unit.



NOTE: Check that air conditioner is tilted back about 5/8" to 3/4" (tilted about 3° to 4° downward to the outside). After proper installation, condensation should not drain from the overflow drain hole during normal use, correct the slope otherwise.

- B. Extend the side panels out against the window frame (Fig. 6).

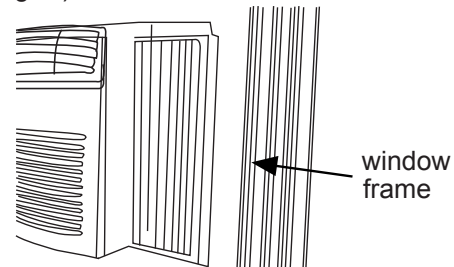

Fig. 6

5 INSTALL SUPPORT BRACKET

- A. Place the frame lock between the frame extensions and the window sill as shown in Fig. 7. Drive 3/4" (19 mm) or 1/2" (12.7 mm) locking screws through the frame lock and into the sill.

NOTE: To prevent window sill from splitting, drill 1/8" (3 mm) pilot holes before driving screws.

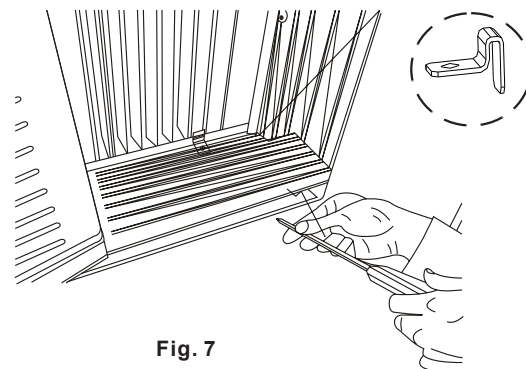

Fig. 7

INSTALLATION INSTRUCTIONS (CONTINUED)

B. Drive 3/4" (19 mm) or 1/2" (12.7 mm) locking screws through frame holes into window sash (Fig. 8).

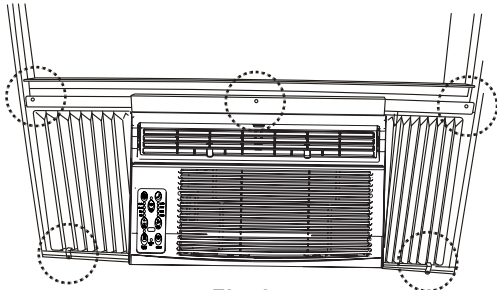

Fig. 8

C. To secure lower sash in place, attach right angle sash lock with 3/4" (19 mm) or 1/2" (12.7 mm) screw as shown (Fig. 9).



Fig. 9

D. Cut Window sash seal foam and insert it in the space between the upper and lower sashes (Fig. 10).

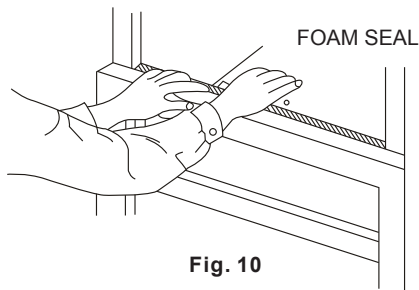

Fig. 10

If AC is Blocked by Storm Window

Add wood as shown in Fig. 11, or remove storm window before air conditioner is installed.

If Storm Window Frame must remain, be sure the drain holes or slots are not caulked or painted shut. Accumulated rain water or condensation must be allowed to drain out.

Removing AC From Window

- Turn AC off, and disconnect power cord.
- Remove sash seal from between windows, and unscrew safety sash lock.
- Remove screws installed through frame and frame-lock.
- Close (slide) side panels into frame.
- Keeping a firm grip on air conditioner, raise sash and carefully remove.
- Be careful not to spill any remaining water while lifting unit from window. Store parts WITH air conditioner.

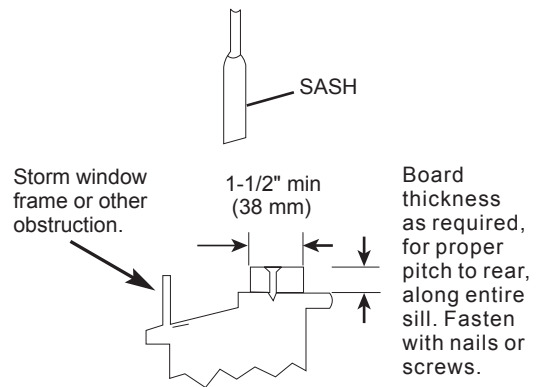
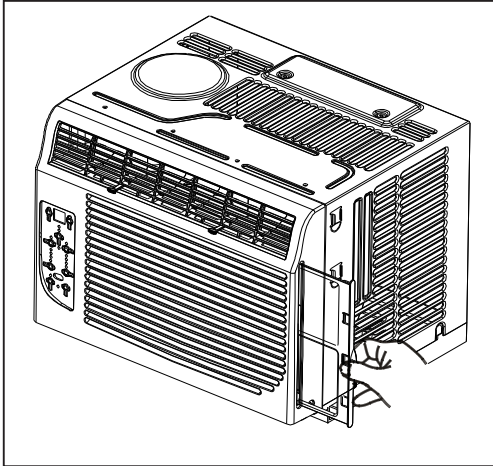

Fig. 11

CARE AND CLEANING

CAUTION

Clean air conditioner occasionally to keep it looking and operating like new. Be sure to unplug the unit before cleaning to prevent shock or fire hazards.



Air Filter Cleaning

The air filter should be cleaned at least every two weeks or as necessary. Trapped particles in the filter can build up and cause an accumulation of frost on the cooling coils.

Remove the filter by sliding out from the right-hand side. Wash the filter using liquid dishwashing detergent and warm water. Rinse filter thoroughly. Gently shake excess water from the filter. Be sure the filter is thoroughly dry before replacing. Or, instead of washing, you may vacuum the filter clean.

NOTE: Never use hot water over 104°F (40°C) to clean the air filter. Never attempt to operate the unit without the air filter.

Cabinet Cleaning

- Be sure to unplug the air conditioner to prevent shock or fire hazard. The cabinet and front may be dusted with an oil-free cloth or with a cloth dampened in a solution of warm water and mild liquid dishwashing detergent. Rinse thoroughly and wipe dry.
- Never use harsh cleaners, wax or polish on the cabinet front.
- Be sure to wring excess water from the cloth before wiping the controls. Excess water in or around the controls may cause damage to the air conditioner.
- Plug in air conditioner after unit has dried completely.

Winter Storage

If air conditioner will be stored during the winter, remove it carefully from the window according to the installation instructions. Cover it with plastic or return it to the original carton. **Always store unit in upright position.**

TROUBLESHOOTING TIPS

Before calling for service, please review the chart below.

Issue	Possible Solutions
AIR CONDITIONER NOT COOLING ROOM, OR NOT BLOWING COLD AIR	<ul style="list-style-type: none"> • Be sure unit is not too large or too small for the area of the room. • Verify that all doors, windows, curtains and any other openings are closed off. Verify nothing is obstructing the front grille of unit, such as curtains, etc. • Allow enough time for room to cool, especially if outside temp is very high. • Check that the filter is not dirty and louvers are open all the way and blowing in the direction desired. • Check that unit is set to Cool Mode and that temperature is down enough (but not too low). • If unit is near a heat source, such as a stove, etc., then relocate unit. • If air coming from unit is cool to the touch, then unit is working properly; please double check the first three bullet points above. • If using Follow Me remote feature, move remote away from unit. • Temperature sensor behind air filter touching cold coil. These two elements should not be touching. Carefully straighten tube away from coil. • Unplug unit for at least 5 minutes. Follow Reset instructions on plug.
AIR CONDITIONER COOLING BUT ROOM IS TOO WARM - ICE FORMING ON COOLING COIL BEHIND DECORATIVE FRONT	<ul style="list-style-type: none"> • Outdoor temperature is below 64°F (18°C). To defrost the coil, set to Fan Only mode. • Air filter may be dirty. Clean filter. Refer to Care and Cleaning section. To defrost, set to Fan Only mode. • Thermostat is set too cold for night-time cooling. To defrost the coil, set to Fan Only mode. Then, set temperature to a higher setting.
AIR CONDITIONER CYCLING ON AND OFF TOO FREQUENTLY OR NOT ENOUGH	<ul style="list-style-type: none"> • Be sure unit is not too large or too small for the area of the room. • Remove grille and make sure the temperature sensor is not too close to the coils. These two elements should not be touching. Carefully straighten tube away from coil. • Make sure nothing is blocking the grille or side vents. • Make sure there is no dirt or debris inside the unit or on the filter.
UNIT WILL NOT TURN ON	<ul style="list-style-type: none"> • Reset circuit breaker. Make sure there are not too many items (ie lamps, TV's, etc.) working off the same breaker. • Check plug connection. • If plug is operating on an on/off switch, be sure that the switch is 'on'. • Try plugging unit into another outlet. • Unplug unit for at least 5 minutes. Follow Reset instructions on plug.
UNIT BLOWS FUSES OR POPS CIRCUIT BREAKER	<ul style="list-style-type: none"> • Make sure there are enough available amps on the circuit for the air conditioner. • Large units which run on a 230v will require a dedicated 20 or 30 amp circuit.
AIR CONDITIONER IS MAKING NOISES	<ul style="list-style-type: none"> • Check to be sure the unit is free from debris such as leaves, sticks, etc. Verify nothing is obstructing the unit. • Check the fan blade for cracks or chips. • Make sure the unit is properly and securely mounted inside the window or wall. • Clean the air filter.
WATER PUDDLES INSIDE UNIT OR IS COMING INTO ROOM	<ul style="list-style-type: none"> • Adjust the slope of the unit so that it drains downward toward the exterior of the home. (See Installation Instructions.) • Make sure that there is no debris blocking the drainage area of the unit.
WATER DRIPPING OUTSIDE	<ul style="list-style-type: none"> • Unit is removing a large quantity of moisture from a humid room. This is normal during excessively humid days.
REMOTE SENSING / FOLLOW ME DEACTIVATING PREMATURELY	<ul style="list-style-type: none"> • Remote control not located within range. Place remote control within 20 ft and 180° radius of the front of the unit. • Remote control signal obstructed. Remove obstruction.

NOTE: A highly recommended troubleshoot for any issue in general consists of turning off unit and unplugging for 5 minutes. It is also recommended to try another wall outlet.



Your Source for Home Comfort

Distributed by:

Perfect Aire, LLC
5151 Belt Line Rd.
Suite 878
Dallas, TX 75254

877-365-6274
www.perfectaire.us

Specification and performance data is subject to change without notice.

Printed in PRC