

olivetti



Advanced Operation Guide

GB

Cod 544803en

PUBLICATION ISSUED BY:

Olivetti S.p.A.

Gruppo Telecom Italia

Via Jervis, 77 - 10015 Ivrea (ITALY)

www.olivetti.com

Copyright © 2007, Olivetti All rights reserved

The mark affixed to the product certifies that the product satisfies the basic quality requirements.



The manufacturer reserves the right to carry out modifications to the product described in this manual at any time and without any notice.



ENERGY STAR is a U.S. registered mark.

The ENERGY STAR program is an energy reduction plan introduced by the United States Environmental Protection Agency in response to environmental issues and for the purpose of advancing the development and utilization of more energy efficient office equipment.

Your attention is drawn to the following actions which could compromise the conformity attested to above, as well as the characteristics of the product:

- incorrect electrical power supply;
 - incorrect installation, incorrect or improper use or use not in compliance with the warnings provided in the User's Manual supplied with the product;
 - replacement of original components or accessories with others of a type not approved by the manufacturer, or performed by unauthorised personnel.
-

All rights reserved. No part of this material may be reproduced or transmitted in any form or by any means, electronic or mechanical, including photocopying, recording or by any information storage and retrieval system, without permission in writing from the Publisher.

This Advanced Operation Guide is for models d-Copia 2500 and d-Copia 3000. In this guide, d-Copia 2540 refers to the 25 cpm (copies per minute) model and d-Copia 3000 to the 30 cpm model.



Note This Advanced Operation Guide contains information that corresponds to using both the inch and metric versions of these machines.

The inch versions of these machines are shown in the screens in this guide. If you are using the metric version, use the messages provided for the inch version as reference only. In the body text, only the inch messages are given if these versions differ only in capitalization. When there is even a slight difference in the message, we have listed the information for the inch version followed, in brackets, by the corresponding information for the metric version.

Included Guides

The following guides are included with this machine. Refer to the proper guide based on your requirements.

Operation Guide

Describes how to load paper, basic copy operations, and troubleshooting.

Advanced Operation Guide (This Guide)

Explains copying features in depth, as well as default settings.

Quick Start Guide

Lists and briefly describes the copy functions of the machine.

Contents

	Legal Information and Conventions	iii
1	Copy Functions	1-1
	Selecting Paper Source	1-2
	Selecting Original Size	1-3
	Copy Quantity	1-5
	Orientation of Original Document	1-6
	Offset Mode	1-7
	Stapling	1-8
	Combine Mode	1-9
	Margin Mode	1-12
	Centering Originals	1-13
	Border Erase	1-14
	Page Numbering	1-16
	Cover Mode	1-18
	Booklet from Sheets	1-19
	Booklets from Facing Pages	1-21
	Memo Mode	1-22
	Continuous Scan	1-24
	Proof Copy	1-24
	Repeat Copy	1-25
	Auto Image Rotation	1-27
	Selecting Output Destination	1-28
	EcoPrint	1-28
	Negative Image Copying	1-29
	Mirror Copying	1-29
	Mixed Size Originals Mode	1-30
	Programmed Copying	1-31
	Assigning Register Keys	1-33
	Job Build	1-34
2	Output Management Functions	2-1
	Overview of Output Management Functions	2-2
	Using the Output Management Functions	2-2
3	System Menu	3-1
	Default Settings	3-2
	Setting MP Tray	3-23
	Registering Non-standard Sizes for Originals	3-24
	Drum Refresh	3-25
	Printing Reports	3-26
	Checking Total Copy Count	3-28
4	Job Accounting	4-1
	Overview of Job Accounting	4-2
	Managing Accounts	4-4
	Copy Count per Department	4-10
	Activating and Deactivating Job Accounting	4-12
	Job Accounting Default Settings	4-13
	Using Job Accounting	4-18
5	Troubleshooting	5-1
	Solving Malfunctions	5-2

	Responding to Error Messages	5-4
6	Appendix	6-1
	Paper	6-2
	Intercompatibility of Functions	6-10
	Glossary	6-15
	Index	Index-1

Legal Information and Conventions

Please read this information before using your machine.

Regarding Tradenames

- KPDL is trademark of Kyocera Corporation.
- Windows and Windows Server are registered trademarks of Microsoft Corporation.
- Windows NT is a trademark of Microsoft Corporation.
- PCL and PJI are registered trademarks of Hewlett-Packard Company.
- Adobe, Adobe Acrobat and Adobe Reader are registered trademarks of Adobe Systems Inc.
- PowerPC is a trademark of International Business Machines Corporation.
- CompactFlash is a trademark of SanDisk Corporation.
- This product was developed using the Tornado™ Real Time Operating System and Tools from Wind River Systems.
- This product uses PeerlessPrintXL to provide the HP LaserJet compatible PCL 6 language emulation. PeerlessPrintXL is a trademark of Peerless Systems Corporation, 2381 Rosecrans Ave. El Segundo, CA 90245, U.S.A.
- TrueType is a registered trademark of Apple Computer Inc.
- All resident fonts in this printer are licensed from Monotype Imaging Inc.
- Helvetica, Palatino and Times are registered trademarks of Linotype-Hell AG.
- ITC Avant Garde Gothic, ITC Bookman, ITC ZapfChancery and ITC Zapf Dingbats are registered trademarks of International Typeface Corporation.
- This product contains UFST™ and MicroType® from Monotype Imaging Inc.

All other brand and product names are registered trademarks or trademarks of their respective companies. The designations ™ and ® will not be used in this Operation Guide.

IBM PROGRAM LICENSE AGREEMENT

THE DEVICE YOU HAVE PURCHASED CONTAINS ONE OR MORE SOFTWARE PROGRAMS ("PROGRAMS") WHICH BELONG TO INTERNATIONAL BUSINESS MACHINES CORPORATION ("IBM"). THIS DOCUMENT DEFINES THE TERMS AND CONDITIONS UNDER WHICH THE SOFTWARE IS BEING LICENSED TO YOU BY IBM. IF YOU DO NOT AGREE WITH THE TERMS AND CONDITIONS OF THIS LICENSE, THEN WITHIN 14 DAYS AFTER YOUR ACQUISITION OF THE DEVICE YOU MAY RETURN THE DEVICE FOR A FULL REFUND. IF YOU DO NOT SO RETURN THE DEVICE WITHIN THE 14 DAYS, THEN YOU WILL BE ASSUMED TO HAVE AGREED TO THESE TERMS AND CONDITIONS.

The Programs are licensed not sold. IBM, or the applicable IBM country organization, grants you a license for the Programs only in the country where you acquired the Programs. You obtain no rights other than those granted you under this license.

The term "Programs" means the original and all whole or partial copies of it, including modified copies or portions merged into other programs. IBM retains title to the Programs. IBM owns, or has licensed from the owner, copyrights in the Programs.

1. License

Under this license, you may use the Programs only with the device on which they are installed and transfer possession of the Programs and the device to another party. If you transfer the Programs, you must transfer a copy of this license and any other documentation to the other party. Your license is then terminated. The other party agrees to these terms and conditions by its first use of the Program.

You may not:

- 1) use, copy, modify, merge, or transfer copies of the Program except as provided in this license;
- 2) reverse assemble or reverse compile the Program; or
- 3) sublicense, rent, lease, or assign the Program.

2. Limited Warranty

The Programs are provided "AS IS."

THERE ARE NO OTHER WARRANTIES COVERING THE PROGRAMS (OR CONDITIONS), EXPRESS OR IMPLIED, INCLUDING, BUT NOT LIMITED TO, THE IMPLIED WARRANTIES OF MERCHANTABILITY AND FITNESS FOR A PARTICULAR PURPOSE.

Some jurisdictions do not allow the exclusion of implied warranties, so the above exclusion may not apply to you.

SUPPLEMENT TO AGREEMENT FOR SOFTWARE BUNDLING AND DISTRIBUTION FOR ALDC

3. Limitation of Remedies

IBM's entire liability under this license is the following;

- 1) For any claim (including fundamental breach), in any form, related in any way to this license, IBM's liability will be for actual damages only and will be limited to the greater of;
 - a) the equivalent of U.S.\$25,000 in your local currency; or
 - b) IBM's then generally available license fee for the Program

This limitation will not apply to claims for bodily injury or damages to real or tangible personal property for which IBM is legally liable. IBM will not be liable for any lost profits, lost savings, or any incidental damages or other economic consequential damages, even if IBM, or its authorized supplier, has been advised of the possibility of such damages. IBM will not be liable for any damages claimed by you based on any third party claim. This limitation of remedies also applies to any developer of Programs supplied to IBM. IBM's and the developer's limitations of remedies are not cumulative. Such developer is an intended beneficiary of this Section. Some jurisdictions do not allow these limitations or exclusions, so they may not apply to you.

4. General

You may terminate your license at any time. IBM may terminate your license if you fail to comply with the terms and conditions of this license. In either event, you must destroy all your copies of the Program. You are responsible for payment of any taxes, including personal property taxes, resulting from this license. Neither party may bring an action, regardless of form, more than two years after the cause of action arose. If you acquired the Program in the United States, this license is governed by the laws of the State of New York. If you acquired the Program in Canada, this license is governed by the laws of the Province of Ontario. Otherwise, this license is governed by the laws of the country in which you acquired the Program.

Monotype Imaging License Agreement

1. "Software" shall mean the digitally encoded, machine readable, scalable outline data as encoded in a special format as well as the UFST Software.
2. You agree to accept a non-exclusive license to use the Software to reproduce and display weights, styles and versions of letters, numerals, characters and symbols ("Typefaces") solely for your own customary business or personal purposes at the address stated on the registration card you return to Monotype Imaging. Under the terms of this License Agreement, you have the right to use the Fonts on up to three printers. If you need to have access to the fonts on more than three printers, you need to acquire a multi-user license agreement which can be obtained from Monotype Imaging. Monotype Imaging retains all rights, title and interest to the Software and Typefaces and no rights are granted to you other than a License to use the Software on the terms expressly set forth in this Agreement.
3. To protect proprietary rights of Monotype Imaging, you agree to maintain the Software and other proprietary information concerning the Typefaces in strict confidence and to establish reasonable procedures regulating access to and use of the Software and Typefaces.
4. You agree not to duplicate or copy the Software or Typefaces, except that you may make one backup copy. You agree that any such copy shall contain the same proprietary notices as those appearing on the original.
5. This License shall continue until the last use of the Software and Typefaces, unless sooner terminated. This License may be terminated by Monotype Imaging if you fail to comply with the terms of this License and such failure is not remedied within thirty (30) days after notice from Monotype Imaging. When this License expires or is terminated, you shall either return to Monotype Imaging or destroy all copies of the Software and Typefaces and documentation as requested.
6. You agree that you will not modify, alter, disassemble, decrypt, reverse engineer or decompile the Software.
7. Monotype Imaging warrants that for ninety (90) days after delivery, the Software will perform in accordance with Monotype Imaging-published specifications, and the diskette will be free from defects in material and workmanship. Monotype Imaging does not warrant that the Software is free from all bugs, errors and omissions. The parties agree that all other warranties, expressed or implied, including warranties of fitness for a particular purpose and merchantability, are excluded.

-
8. Your exclusive remedy and the sole liability of Monotype Imaging in connection with the Software and Typefaces is repair or replacement of defective parts, upon their return to Monotype Imaging. In no event will Monotype Imaging be liable for lost profits, lost data, or any other incidental or consequential damages, or any damages caused by abuse or misapplication of the Software and Typefaces.
 9. Massachusetts U.S.A. law governs this Agreement.
 10. You shall not sublicense, sell, lease, or otherwise transfer the Software and/or Typefaces without the prior written consent of Monotype Imaging.
 11. Use, duplication or disclosure by the Government is subject to restrictions as set forth in the Rights in Technical Data and Computer Software clause at FAR 252-227-7013, subdivision (b)(3)(ii) or subparagraph (c)(1)(ii), as appropriate. Further use, duplication or disclosure is subject to restrictions applicable to restricted rights software as set forth in FAR 52.227-19 (c)(2).
 12. You acknowledge that you have read this Agreement, understand it, and agree to be bound by its terms and conditions. Neither party shall be bound by any statement or representation not contained in this Agreement. No change in this Agreement is effective unless written and signed by properly authorized representatives of each party. By opening this diskette package, you agree to accept the terms and conditions of this Agreement.

About this Operation Guide

This Operation Guide contains the following chapters:

1 Copy Functions

Describes the full-featured copying functions of the machine.

2 Output Management Functions

Explains the output management functions.

3 System Menu

Covers general default settings.

4 Job Accounting

Explains how to manage job accounting to share usage among various departments.

5 Troubleshooting

Explains how to handle error messages and other problems.

Appendix

Lists supported paper and intercompatible functions. Includes a glossary.

Conventions in This Guide

The following conventions are used depending on the nature of the description.

Convention	Description	Example
Bold	Indicates operation panel keys.	Press the Start key.
[Regular]	Indicates touch panel keys.	Press [Basic].
<i>Italic</i>	Indicates touch panel messages.	<i>Ready to copy</i> is displayed.
Note	Indicates supplemental information or operations for reference.	 Note -
IMPORTANT	Indicates items that are required or prohibited so as to avoid problems.	IMPORTANT -

Originals and Paper Sizes

This section explains the notation used in this guide when referring to sizes of originals or paper sizes.

As in A4 and B5, which may be used either in the horizontal or vertical direction, in order to indicate the orientation of the original/paper, horizontal orientation is indicated by an additional R character.

Set direction	Indicated size ^a
<p data-bbox="635 533 826 562">Vertical direction</p> <div data-bbox="687 571 1157 779"> <p data-bbox="762 790 863 819">Original</p> <p data-bbox="1046 790 1106 819">Size</p> </div> <p data-bbox="635 831 1182 860">For original/paper, dimension A is longer than B.</p>	<p data-bbox="1219 533 1401 595">A4, B5, A5, B6, A6, 16K</p>
<p data-bbox="635 873 858 902">Horizontal direction</p> <div data-bbox="687 911 1157 1120"> <p data-bbox="762 1131 863 1160">Original</p> <p data-bbox="1046 1131 1106 1160">Size</p> </div> <p data-bbox="635 1167 1182 1196">For original/paper, dimension A is shorter than B.</p>	<p data-bbox="1219 873 1417 936">A4R, B5R, A5R, B6R, A6R, 16KR</p>

- a. The size of original/paper that can be used depends on the function and source tray. For further details, refer to the page detailing that function or source tray.

1 Copy Functions

This chapter covers the following topics.

Selecting Paper Source	1-2
Selecting Original Size	1-3
Standard Sizes	1-3
Other Standard Sizes	1-3
Size Entry	1-4
Custom Size	1-4
Copy Quantity	1-5
Orientation of Original Document	1-6
Offset Mode	1-7
Stapling	1-8
Combine Mode	1-9
Margin Mode	1-12
Centering Originals	1-13
Border Erase	1-14
Sheet Border Erase	1-14
Book Border Erase	1-14
Separate Border Erase	1-15
Page Numbering	1-16
Cover Mode	1-18
Booklet from Sheets	1-19
Booklets from Facing Pages	1-21
Memo Mode	1-22
Continuous Scan	1-24
Proof Copy	1-24
Repeat Copy	1-25
Preparing a Job for Repeat Copy	1-25
Repeat Copy Output	1-25
Auto Image Rotation	1-27
Selecting Output Destination	1-28
EcoPrint	1-28
Negative Image Copying	1-29
Mirror Copying	1-29
Mixed Size Originals Mode	1-30
Programmed Copying	1-31
Using Programs to Copy	1-31
Editing Program Names	1-31
Deleting programs	1-32
Assigning Register Keys	1-33
Assigning Register Keys	1-33
Deleting Register Keys	1-33
Job Build	1-34
Job Build Procedure	1-34
Setting Functions	1-37

Selecting Paper Source

To select paper of different sizes, change the cassette or MP tray paper source.

Follow the steps as below to select the paper source.

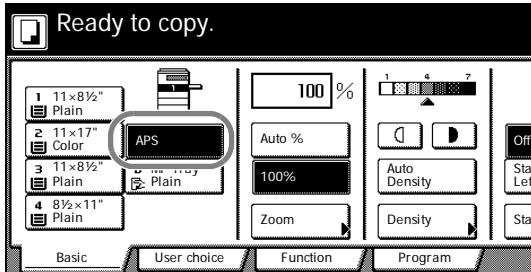

- 1 Place the original.

When [APS] is selected, paper matching the size of the original will be selected automatically.



Note You may override the automatic paper selection default. For further details, refer to *Setting Auto Paper Selection* on page 3-5.

- 2 To change the paper size, press the button corresponding to the desired paper size to select that paper source.

When using the MP tray, refer to *Chapter 2 of Operation Guide: Setting Media Type and Paper Size for the Cassettes and MP Tray* to set the paper size and media type.

- 3 Press the **Start** key. Copying begins.

Selecting Original Size

Specify the size of originals that will serve as the basis for scanning. Be sure to specify the original size when copying originals of nonstandard sizes.

Select the original size from the following groups of original size.

- **Standard Sizes** – Select from commonly used standard sizes.
Inch models: 11 × 17", 8 1/2 × 14", 11 × 8 1/2", 8 1/2 × 11", 5 1/2 × 8 1/2", 8 1/2 × 5 1/2", 8 1/2 × 13 1/2", 8 1/2 × 13" (Oficio II), 11 × 15", A4 and A4R
Metric models: A3, B4, A4, A4R, B5, B5R, A5, A5R, B6, B6R, A6R, Folio, 11 × 15", 11 × 8 1/2" and 8 1/2 × 11"
- **Other Standard Sizes** – Select from special-purpose standard sizes.
Inch models: A3, B4, B5, B5R, A5, A5R, B6, B6R, A6R, Folio, P, Card, OUFUKU HAGAKI, 8K, 16K and 16KR
Metric models: 11 × 17", 8 1/2 × 14", 5 1/2 × 8 1/2", 8 1/2 × 5 1/2", 8 1/2 × 13 1/2", 8 1/2 × 13" (Oficio II), Pstcard, OUFUKU HAGAKI, 8K, 16K and 16KR
- **Size Entry** – Enter the size for when not shown in the list of standard sizes.
Inch models
Vertical: 2 - 11 5/8" (1/8" increments), Horizontal: 2 - 17" (1/8" increments)
Metric models
Vertical: 50 - 297 mm (1 mm increments), Horizontal: 50 - 432 mm (1 mm increments)
- **Custom Size** – Select entered and registered original sizes. For setting custom original sizes, refer to *Registering Non-standard Sizes for Originals* on page 3-24.

Standard Sizes

Follow the steps as below to specify the standard size.

- 1 Place the original.
- 2 Press [Function].
- 3 Press [Original Size].
- 4 Select the original size.
Choose [Auto] to match the size of placed originals automatically.
- 5 Press the **Start** key. Copying begins.

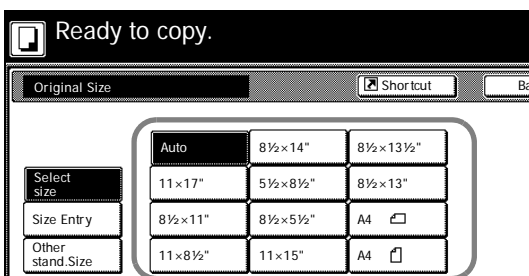

Other Standard Sizes

Follow the steps as below to specify the other standard sizes.

- 1 Place the original.
- 2 Press [Function].
- 3 Press [Original Size].

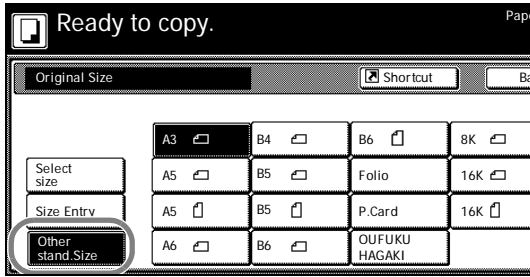

- 4 Press [Other stand.Size] ([Others stand.Size]).
- 5 Select the original size.
- 6 Press the **Start** key. Copying begins.

Size Entry

Follow the steps as below to enter the original size when not listed in the standard sizes.

- 1 Place the original.
- 2 Press [Function].
- 3 Press [Original Size].
- 4 Press [Size Entry].
- 5 Press [+] or [-] to set the Y (height) and X (width) sizes.

With the metric models, you may enter the size directly using the numeric keys by pressing [#-Keys].

- 6 Press the **Start** key. Copying begins.

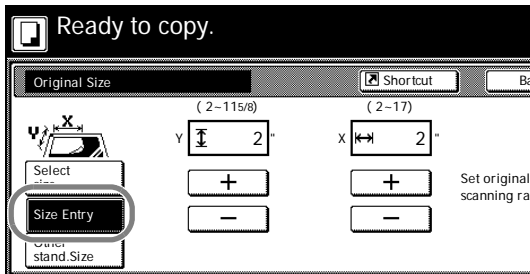

Custom Size

Follow the steps as below to specify one of the custom sizes.

- 1 Place the original.
- 2 Press [Function].
- 3 Press [Original Size].
- 4 Select the original size from *Custom Size (Use regist)*.
- 5 Press the **Start** key. Copying begins.

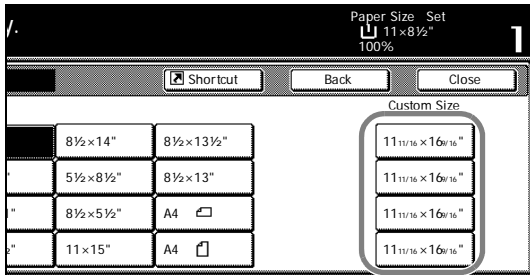

Copy Quantity

Sets the number of sheets to copy. You may specify up to 999 sheets for a single copy job.

Follow the steps as below to specify the copy quantity.

- 1 Place the original.
- 2 Use the numeric keys on the operation panel to enter the desired copy quantity.



Note To clear the copy quantity, press the **Stop/Clear** key. Copy quantity will be reset to 1.

- 3 Press the **Start** key. Copying begins.

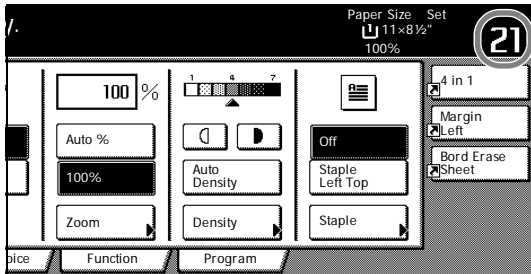

Orientation of Original Document

Orientation of the original must be specified to use the following functions.

- Duplex Mode
- Split Mode (separate copies from two-sided originals)
- Margin Mode
- Centering Originals
- Border Erase
- Combine Mode
- Memo Pages
- Page Numbering
- Booklet
- Stapling (optional feature)

Placing originals on the platen

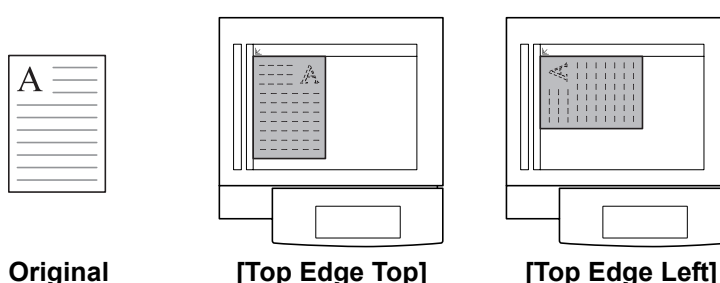

Placing originals in the optional document processor

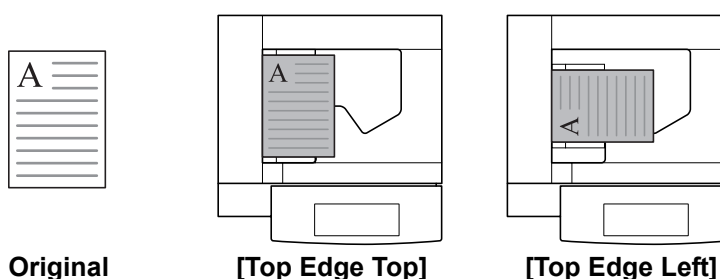

 **Note** The default setting for the original orientation may be changed. For further details, refer to *Orientation of Original Document* on page 3-17.

Follow the steps as below to specify the original orientation.

- 1** Place the original.
- 2** Press [Function] and then press [▼ Down].
- 3** Press [Original Orient.].
- 4** According to the placed orientation of the original, press [Top Edge Top] or [Top Edge Left].
- 5** Press [Close].
- 6** Configure the functions which require specification of the original orientation, such as Duplex mode.
- 7** Press the **Start** key. Copying begins.

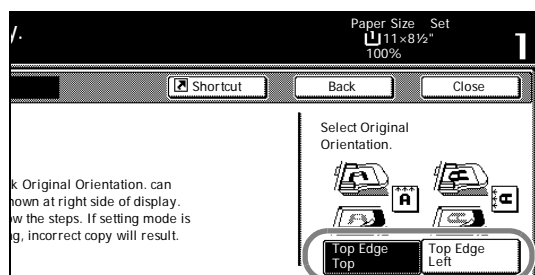

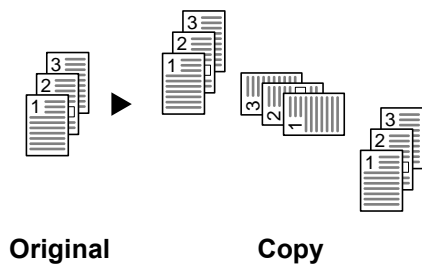

Offset Mode

Outputs printed copies such that each set is stacked perpendicular (rotated 90 degrees) to the previous set.



Note Use of this feature requires paper of the same size must be loaded in the different cassettes with portrait and landscape orientations.

Only 11 × 8 1/2", A4, B5 and 16K paper sizes may be used with Offset mode.

Follow the steps as below for using Offset mode.

- 1** Press [Function].
- 2** Press [Collate/Offset].
- 3** Press [On].
- 4** Use the numeric keys to enter the copy quantity.
- 5** Place the original and press the **Start** key. Copying begins.

If the original has been placed on the optional document processor, copying begins automatically.

If the original is placed on the platen, *Scan next original(s)* is displayed. Place the next original and press the **Start** key.

If all original pages have been scanned, press [Scanning finished]. Copying begins.

Copied pages are output to the top tray offset per each set.

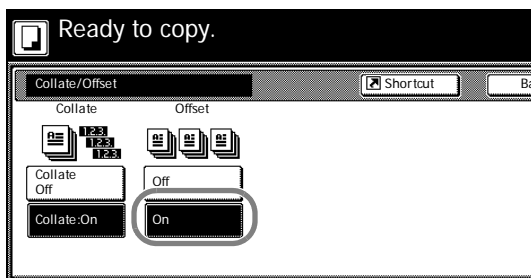

Stapling

Staples sets of copies.



Note Requires the optional document finisher or built-in finisher.

The orientations of the original and corresponding staple positions are as follows.

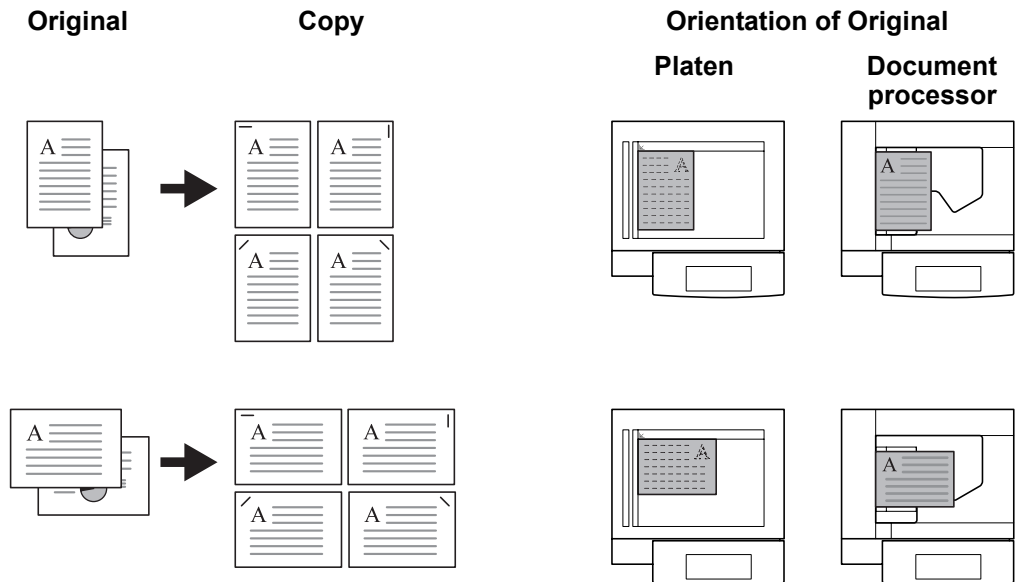

Follow the steps as below for stapling.

- 1 Press [Function] and then press [▼ Down].
- 2 Press [Staple].
- 3 Press [1 staple].
- 4 Select the staple position.
- 5 Place the original and press the **Start** key.

If the original has been placed on the optional document processor, copying begins automatically.

If the original is placed on the platen, *Scan next original(s)* is displayed. Place the next original and press the **Start** key.

If all original pages have been scanned, press [Scanning finished]. Copying begins.

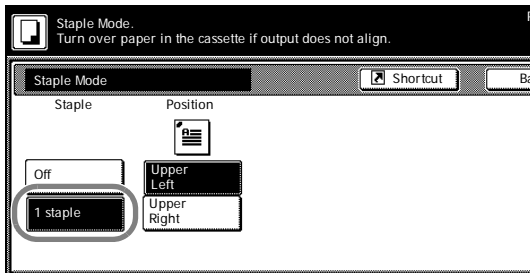

Combine Mode

Images from either two or four originals are reduced and combined onto a single copy. The page boundary of each original can be indicated by a solid or dotted line.

 **Note** Combine mode supports 11 × 17", 11 × 8 1/2", 8 1/2 × 11", A3, B4, A4, A4R, B5, B5R, 8K, 16K and 16KR paper sizes.

2-in-1 Mode

Copy two originals onto a single sheet. This mode can be used with Duplex mode to copy four originals onto one sheet.

The orientations of the original and corresponding output are as follows.

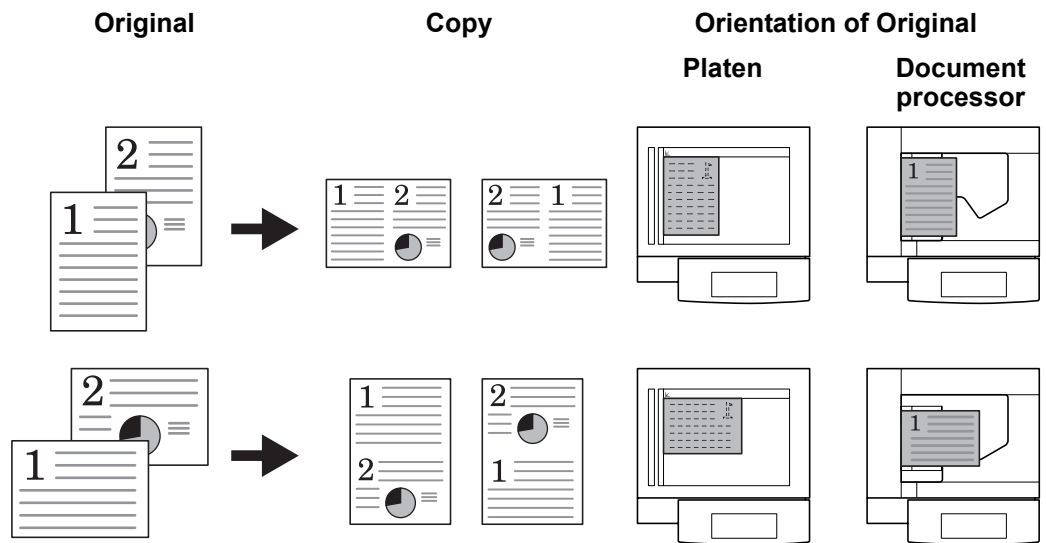

 **Note** When placing the original on the platen, copy originals in the page order.

4-in-1 Mode

For copying four originals onto a single sheet. This mode can be used with Duplex mode to copy eight originals onto one sheet.

The orientations of the original and corresponding output are as follows.

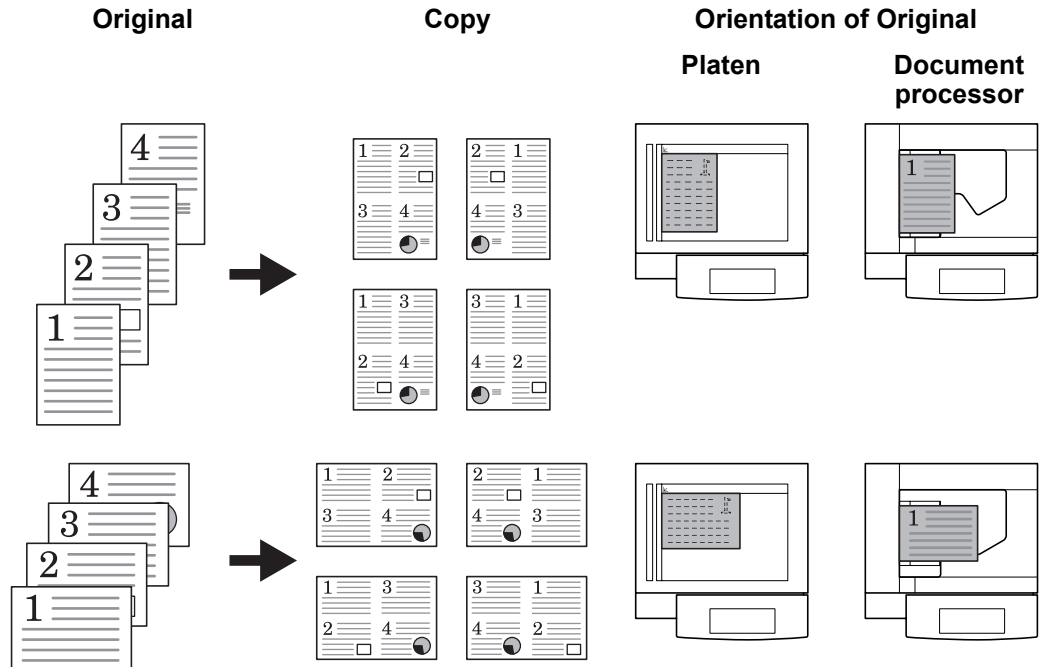

Note When placing the original on the platen, copy originals in the page order.

Types of Page Boundary Lines

Choose from the following options for lines to indicate page boundaries.

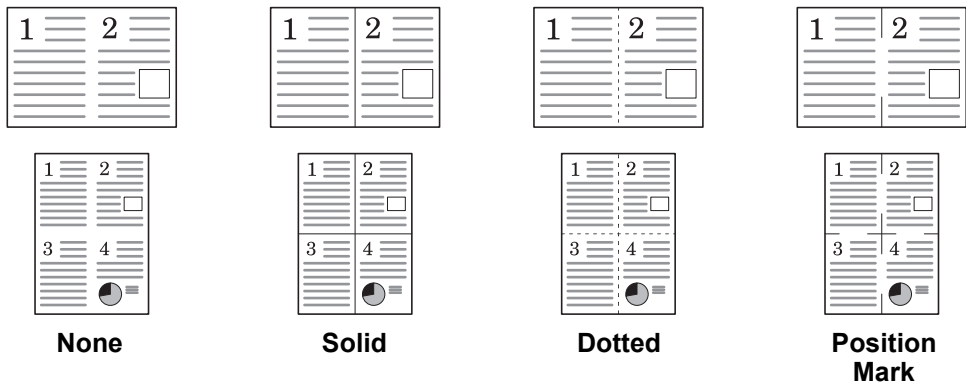

Follow the steps as below to combine originals.

- 1** Press [Function].
- 2** Press [Combine].

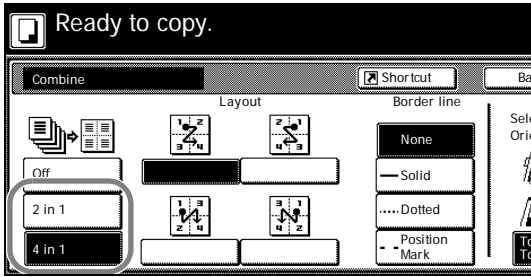

- 3 Press either [2 in 1] ([2-in-1]) or [4 in 1] ([4-in-1]).
- 4 Select desired page sequence from *Layout*.
- 5 Select the page boundary line from *Border line*.
- 6 Place the original and press the **Start** key.

If the original has been placed on the optional document processor, copying begins automatically.

If the original is placed on the platen, *Scan next original(s)* is displayed. Place the next original and press the **Start** key.

If all original pages have been scanned, press [Scanning finished]. Copying begins.

Margin Mode

You can shift the original image to make space on the copy for binding on the left (right) or top (bottom) side. Margin widths are as follows.

Model Type	Range
Inch models	0 - 3/4" (1/8" increments)
Metric models	0 - 18 mm (1 mm increments)

Margin on the Back Side

When duplexing, you can also specify the margin on the back side.

Auto – Automatically sets margins to match the front side setting. When [Auto] is specified, the left and right margins on the front are reversed on the back. In other words, when the left margin of the front side is set to 1/2" (10 mm), the back side right margin is set to 1/2" (10 mm). The top and bottom margin widths on the back will match those on the front.

Separate Front/Back Margins – Enables you to specify the front and back settings separately.



Note You can set the default margin width. For further details, refer to *Setting Margin Defaults* on page 3-8.

Follow the steps as below to use the Margin mode.

- 1 Place the original so the top edge is aligned with the back or left of the platen.
- 2 Press [Function].
- 3 Press [Margin/Centering].
- 4 Press [Margin].
- 5 Press [▲], [▼], [◀] or [▶] to adjust the top, bottom, left and right margins.
- 6 For duplex copying, press [Back page margin].
- 7 Press [Auto] or [Front/Back margin].
[Auto] specifies the margin on the back side automatically based on the front margin.
For [Front/Back margin], press [▲], [▼], [◀] or [▶] to adjust the top, bottom, left and right margins.
- 8 Depending on the placed original, select [Top Edge Top] or [Top Edge Left] from *Select Original Orientation*.
- 9 Press the **Start** key. Copying begins.

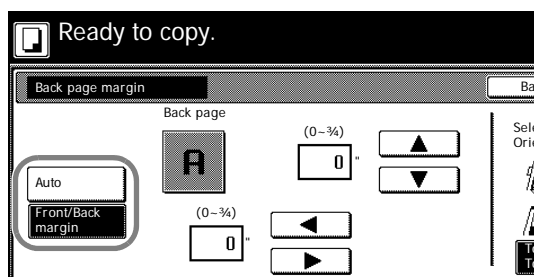
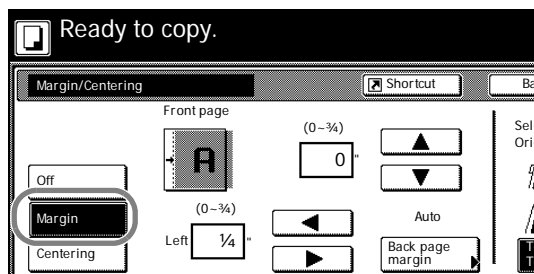

Centering Originals

When copying onto paper larger than the original size, centers the original image on the paper.

Follow the steps as below for centering.

- 1** Place the original so the top edge is aligned with the back or left of the platen.
- 2** Press [Function].
- 3** Press [Margin/Centering].
- 4** Press [Centering].
- 5** Depending on the placed original, select [Top Edge Top] or [Top Edge Left] from *Select Original Orientation*.
- 6** Press the **Start** key. Copying begins.

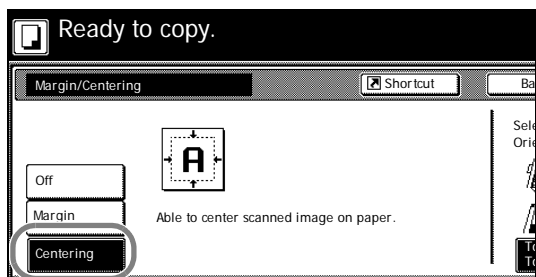

Border Erase

Prevents the appearance of shadows from around the edges of originals.

Choose from the following Border Erase modes.

Sheet Border Erase – Use this mode to erase black borders around the single sheet original.

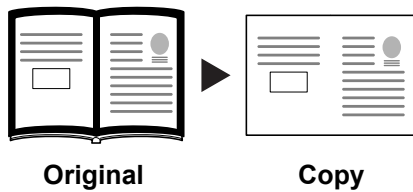
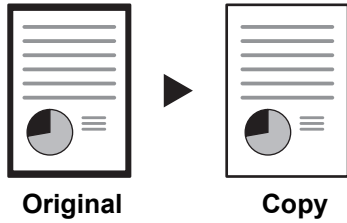

Book Border Erase – Use this mode to erase black borders around the edges and in the middle of the original such as a thick books. You can specify the widths individually to erase the borders around the edges and in the center of the book.

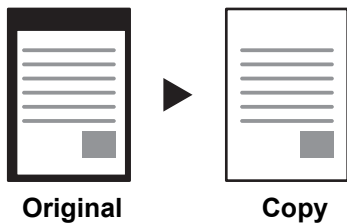

Separate Border Erase – Use this mode to specify border widths individually on all sides to erase.

The border widths that can be set for each mode are as follows.

Model Type	Range
Inch models	0 - 2" (1/8" increments)
Metric models	0 - 50 mm (1 mm increments)



Note You can set the default width for erasing borders. For further details, refer to *Erasing Borders* on page 3-9.

Sheet Border Erase

Follow the steps as below to erase the black borders from around the edges of the single sheet original.

- 1 Place the original.
- 2 Press [Function].
- 3 Press [Border Erase].
- 4 Press [Bord Erase Sheet].
- 5 Press [+] or [-] to set the border erase width.

With metric models, you can enter the border width directly using the numeric keys by pressing [#-Keys].

- 6 Press the **Start** key. Copying begins.

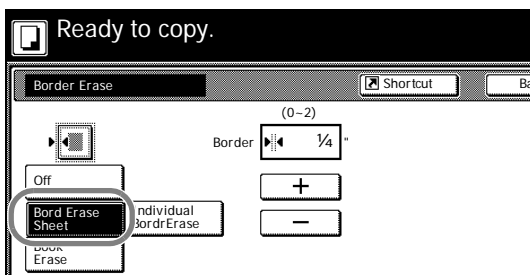

Book Border Erase

Follow the steps as below to erase the black borders around the edges of original such as a book.

- 1 Place the original.
- 2 Press [Function].

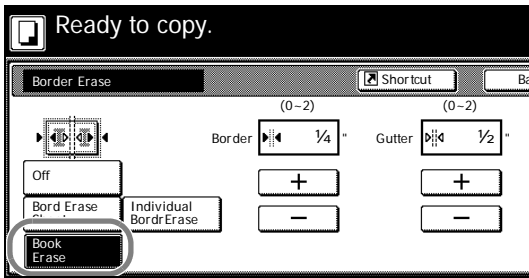

- 3 Press [Border Erase].
- 4 Press [Book Erase].
- 5 Press [+] or [-] to set the *Border* (outer edges) and *Gutter* (middle) border widths.
With metric models, you can enter the border width directly using the numeric keys by pressing [#-Keys].
- 6 Press the **Start** key. Copying begins.

Separate Border Erase

Follow the steps as below to erase the black borders specifying the width of the borders individually.

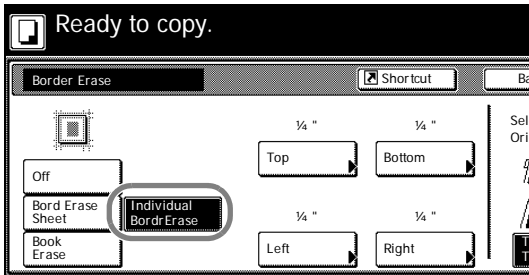

- 1 Place the original so the top edge is aligned with the back or left of the platen.
- 2 Press [Function].
- 3 Press [Border Erase].
- 4 Press [Individual BordrErase].
- 5 Depending on orientation of the placed original, select [Top Edge Top] or [Top Edge Left] from *Select Original Orientation*.
- 6 From [Top], [Bottom], [Left] and [Right], select the desired border to adjust the border width.

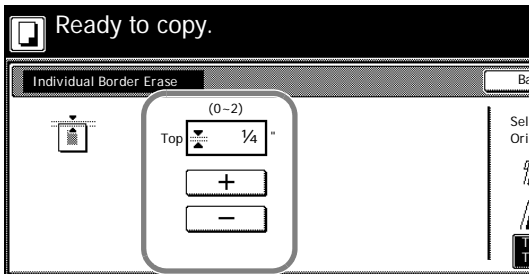

- 7 Press [+] or [-] to set the border erase width.
With metric models, you can enter the border width directly using the numeric keys by pressing [#-Keys].
- 8 Press [Close]. To specify widths of other borders to erase, repeat steps 6 - 8.
- 9 Press the **Start** key. Copying begins.

Page Numbering

Numbers multi-page originals in sequential order. The formats of numbering include: [- 1 -], [P. 1], or [1/n]. [1/n] prints the total number of pages in the place of 'n'.

The page number will be centered at the bottom of the page.

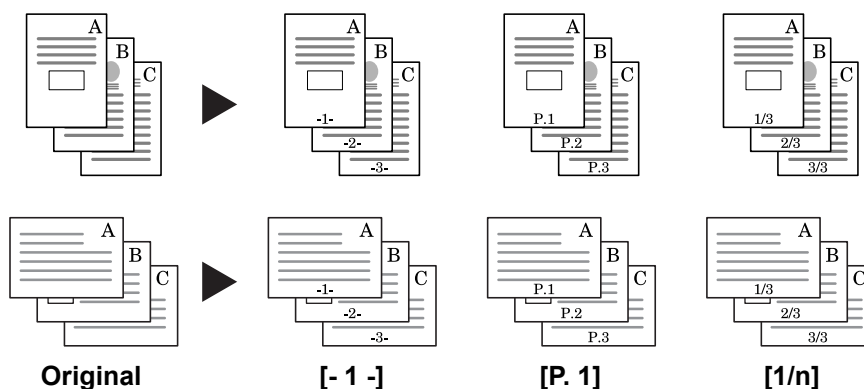

Follow the steps as below for page numbering.

- 1** Place the original so the top edge is aligned with the back or left of the platen.
- 2** Press [Function].
- 3** Press [Page #] ([Page numbering]).
- 4** Select the page stile from [- 1 -], [P. 1], or [1/n].
- 5** To start page numbering from the page other than the first page, press [Select 1st page] ([Setting 1st page]).
- 6** Press [+] or [-] to select the starting page and press [Close].
- 7** To specify the starting a number other than 1, press [Select start #] ([Setting Start page]).
- 8** Press [+] or [-] to select the starting page and press [Close]. Press [# keys] ([#-Keys]) to enter with numeric keys.
- 9** To specify the page to end numbering, press [Select last page] ([Setting last page]).

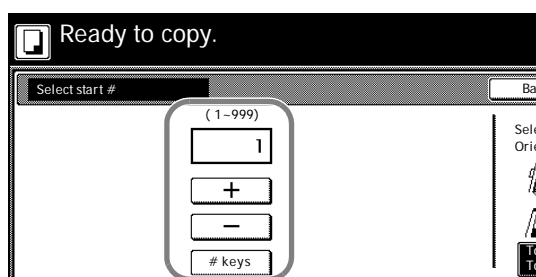
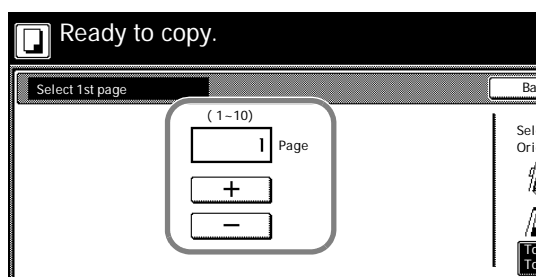
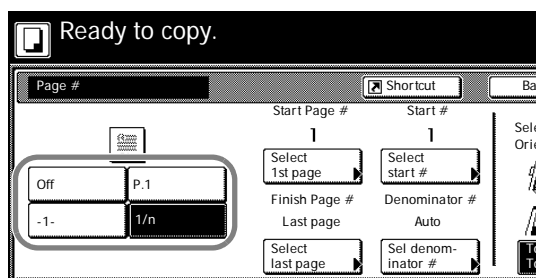

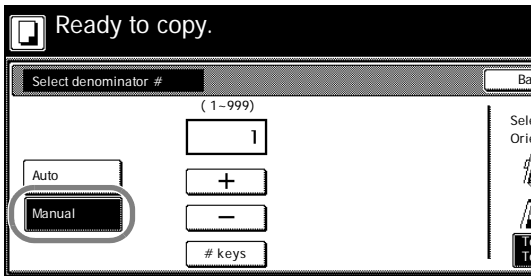
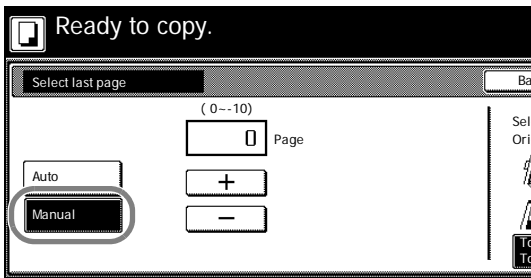

10 Press [Manual].

11 Press [+] or [-] to select the starting page and press [Close].

12 For [1/n], to manually set the number for 'n', press [Sel denominator #] ([Set Denomin. #]).

13 Press [Manual].

14 Press [+] or [-] to select the number for 'n' and press [Close].

Press [# keys] ([#-Keys]) to enter with numeric keys.

15 Depending on the placed original, select [Top Edge Top] or [Top Edge Left] from *Select Original Orientation*.

16 Press the **Start** key.

If the original has been placed on the optional document processor, copying begins automatically.

If the original is placed on the platen, *Scan next original(s)* is displayed. Place the next original and press the **Start** key.

If all original pages have been scanned, press [Scanning finished]. Copying begins.

Cover Mode

Use a distinctive front and/or back cover. Change the paper source and copy the first and last page of the original onto colored or thick paper.

Cover sheet types	Description
Front cover	Copies the first page of the original onto cover sheet specified paper as the cover page.
Front Cvr + Back Cvr	Copies the first page and last page of the original onto cover sheet paper as back and front covers.

Paper for the cover page is fed from the MP tray. To supply cover paper from a cassette, refer to *Specifying Paper Source for Cover* on page 3-6.

For duplex copying, The cover page is also printed on both sides.

Follow the steps as below for adding covers.

- 1 Place the original.
- 2 Press [Function].
- 3 Press [Cover].
- 4 Press [Front cover] or [Front Cvr + Back Cvr].
- 5 Press the **Start** key.

If the original has been placed on the optional document processor, copying begins automatically.

If the original is placed on the platen, *Scan next original(s)* is displayed. Place the next original and press the **Start** key.

If all original pages have been scanned, press [Scanning finished]. Copying begins.

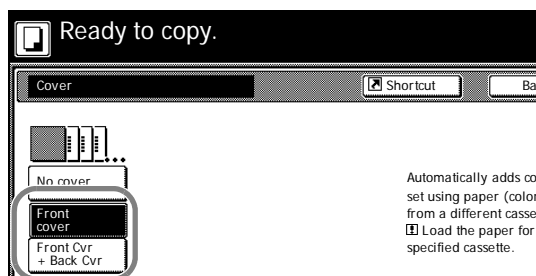

Booklet from Sheets

Delivers booklet of two-sided copies with facing pages from one-sided or two-sided originals. Booklets such as magazines can be created by folding at the center. Also, thick paper or colored paper may be inserted as a cover page.

Paper for the cover page is fed from the MP tray. To supply cover paper from a cassette, refer to *Specifying Paper Source for Cover* on page 3-6.



Note Paper sizes available for booklet (sheet original) are limited to 11 × 17", 8 1/2 × 14", 11 × 8 1/2", 8 1/2 × 11", A3, B4, A4, A4R, B5 and B5R.

For binding on the left side

The folded copies can be read from left to right.

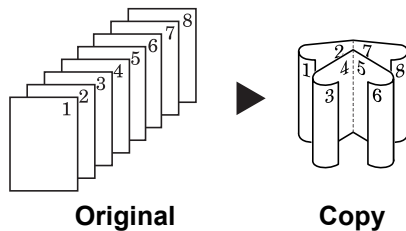

For binding on the right side

The folded copies can be read from right to left.

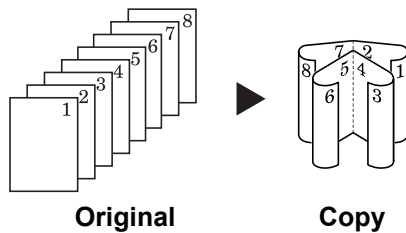

For top binding

The folded copies can be read from top to bottom.

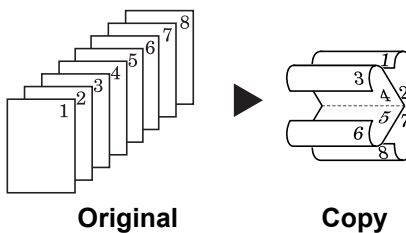

Follow the steps as below for these booklet types.

- 1 Press [Function].
- 2 Press [Booklet].
- 3 Press [Booklet].
- 4 Select binding orientation for *Original* and *Finishing*.

If the message *Cannot copy with these settings. Modify settings according to the original and finishing* is displayed, verify that you are selecting the correct original orientation (shown at the right of the touch panel) and the correct settings for the original and finished copies.

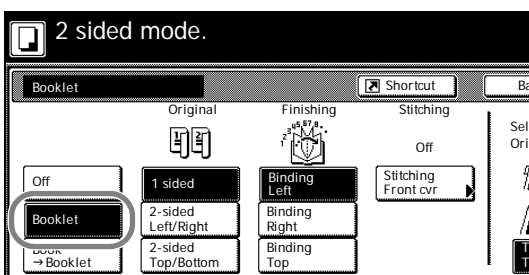

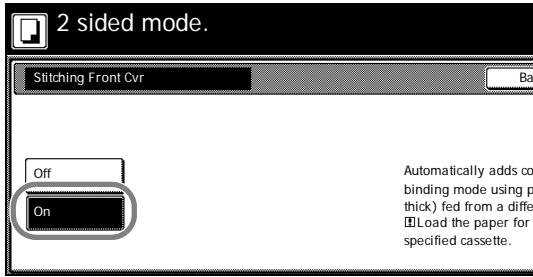

5 To insert a cover page, press [Stitching Front cvr] ([Stitching Front cov.]).

Press [On] and press [Close].

6 Place the original and press the **Start** key.



Note When using the platen, be sure to place the originals in page order.

If the original has been placed on the optional document processor, copying begins automatically.

If the original is placed on the platen, *Scan next original(s)* is displayed. Place the next original and press the **Start** key.

If all original pages have been scanned, press [Scanning finished]. Copying begins.

Booklets from Facing Pages

Copies book originals to booklets consisting of two-sided copies with facing pages. Booklets such as magazines can be created by folding at the center. Also, thick paper or colored paper may be inserted as a cover page.

You can change the cassette set as the paper to be used for the cover page. For further details, refer to *Specifying Paper Source for Cover* on page 3-6.



Note Original sizes that can be used with Booklets from Facing Pages are limited to 11 × 17", 8 1/2 × 11", A3, B4, A4R, B5R, A5R, 8K, and output paper size is limited to 11 × 17", 8 1/2 × 14", 11 × 8 1/2", 8 1/2 × 11", A3, B4, A4, A4R, B5 and B5R.

Follow the steps as below for these booklet types.

- 1 Place the book original and press [Function].
- 2 Press [Booklet].
- 3 Press [Book→Booklet].
- 4 Select the original and finished types.

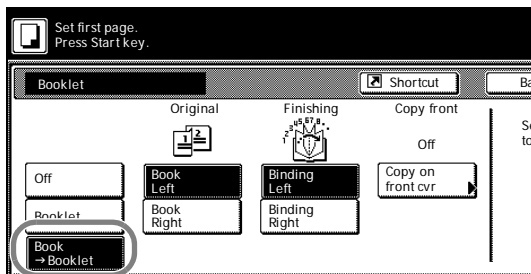

- 5 To insert a cover page, press [Copy on front cvr] ([Copy on front cov.]). Press [On] and press [Close].

- 6 Press the **Start** key. Scanning of the original begins.

Scan next original(s) is displayed. Place the next original and press the **Start** key.

If all original pages have been scanned, press [Scanning finished]. Copying begins.

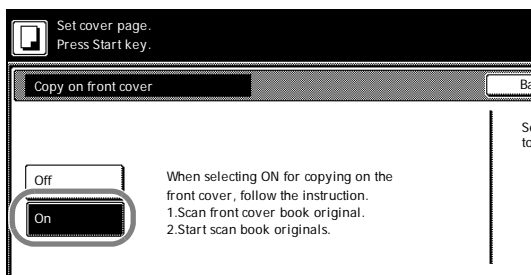

Memo Mode

Makes copies with a space for adding notes. You can also copy two originals onto the same sheet with a space for notes.



Note Memo page mode supports 11 × 17", 11 × 8 1/2", 8 1/2 × 11", A3, B4, A4, A4R, B5, B5R, 8K, 16K and 16KR page sizes.

Layout A

Reduces images of one original page for copying onto half of a single page, leaving the other half blank for notes.

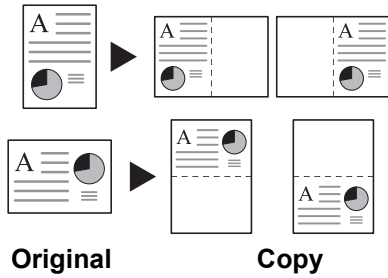

Original

Copy

Layout B

Reduces images of two original pages for copying onto half of a single page, leaving the other half blank for notes.

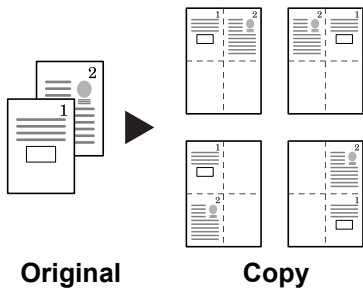

Original

Copy

Types of Page Boundary Lines

Choose from the following options for lines to indicate page boundaries.

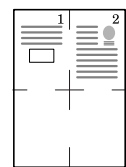
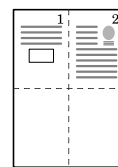
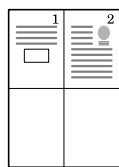
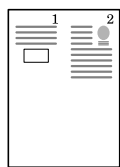

None

Solid

Dotted

Position
Mark

Follow the steps as below for Memo mode.

- 1** Press [Function] and then press [▼ Down].
- 2** Press [Memo Pages].

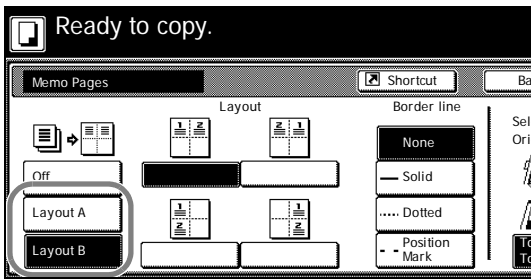

- 3 Press [Layout A] or [Layout B].
- 4 Select desired page sequence from *Layout*.
- 5 Select the page boundary line from *Border line*.
- 6 Place the original and press the **Start** key.

If the original has been placed on the optional document processor, copying begins automatically.

If the original is placed on the platen, *Scan next original(s)* is displayed. Place the next original and press the **Start** key.

If all original pages have been scanned, press [Scanning finished]. Copying begins.

Continuous Scan

Scans multiple originals for a single copy job without using the optional document processor. Divide the original into smaller sets and scan each set with the document processor. In Continuous Scan mode, you can continue scanning originals until you press [Scanning finished].

Follow the steps as below to use continuous scan.

- 1 Press [Function].
- 2 Press [Continuous Scan].
- 3 Press [On].
- 4 Place the original and press the **Start** key.

Place the next original and press the **Start** key. Scan the remaining original pages in the same manner.

When done, press [Scanning finished]. Copying begins.

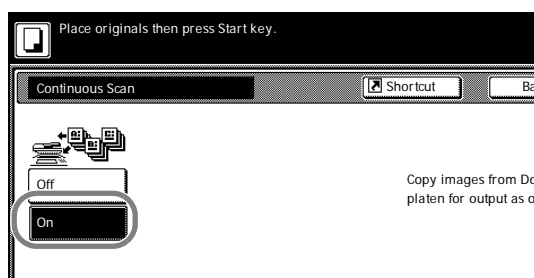

Proof Copy

Make a test copy of a single set to verify settings before printing the remaining sets. If a problem is found, avoid wasting paper canceling the remaining copy job.

Follow the steps below to do a Proof copy job.

- 1 Press [Function] and then press [▼ Down].
- 2 Press [Proof Copy].
- 3 Press [On].
- 4 Place the original and press the **Start** key. The proof copy begins.

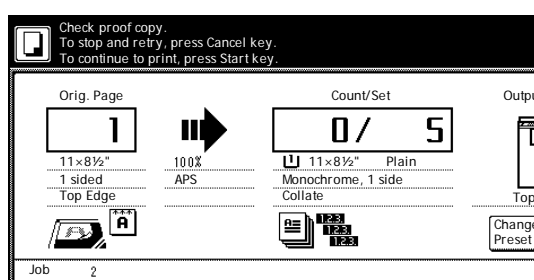
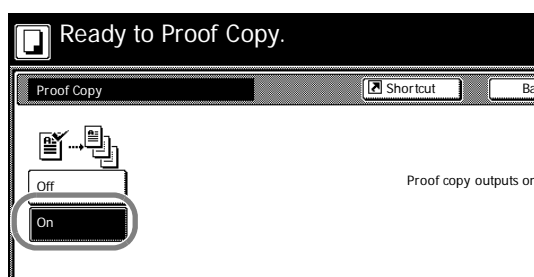

- 5 After printing a single test copy, a confirmation screen will be displayed, and the copier will remain in standby mode until the job is approved or cancelled. Check the proof copy.

If it is acceptable, press the **Start** key. The remaining sets will be printed.

To change the copy quantity, press [Change Preset] and change the copy count.

If there is a problem with the copy, press [Cancel] to redo the copy settings.

Repeat Copy

Set Repeat Copy to enable printing additional sets if required after copy completion.



Note Only one job can be stored for repeat copying. If you store a new Repeat Copy job, the data for the previous job is deleted.

Repeat Copy job is deleted when the main power is switched off.

It is also possible to disable Repeat Copy or configure Repeat Copy in default settings mode. For further details, refer to *Enabling Repeat Copy* on page 3-9.

Preparing a Job for Repeat Copy

Configure Repeat Copy as shown below.

- 1 Press [Function] and then press [▼ Down].
- 2 Press [Repeat Copy].
- 3 Press [On].
- 4 Place the original and press the **Start** key. Copying begins and the job is stored as a Repeat Copy job.

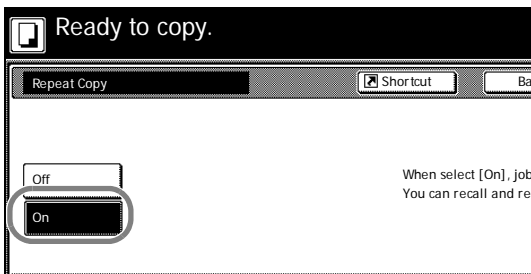

Repeat Copy Output

Press the **Repeat Copy** key to display the *Check Details/Reprint* screen and review the details of stored job. You can then reprint stored job entirely, print just the first page or delete the job.

Re-Printing Jobs

Follow the steps as below to reprint a Repeat Copy job.

- 1 Press the **Repeat Copy** key.

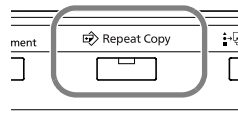

- 2 Press [Reprint].

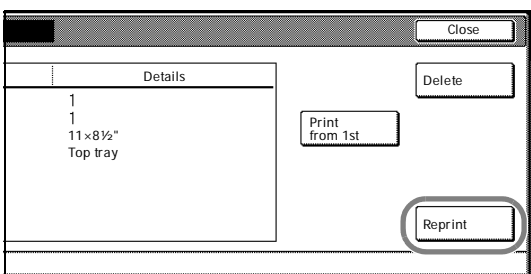

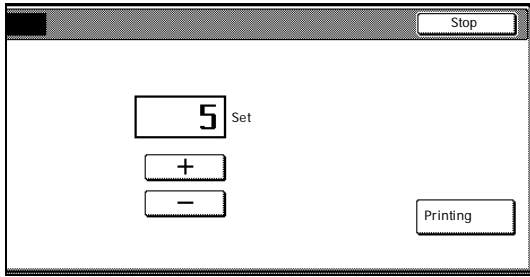

- 3** Press [+] or [-], or use the numeric keys to set the number of copies.
- 4** Press [Printing]. Printing begins.

Printing the First Page

This function allows you to check Repeat Copy job by printing just the first page.

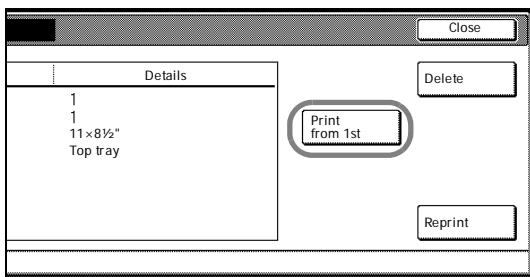

- 1** Press the **Repeat Copy** key.
- 2** Press [Print from 1st] ([Head Print]). The first page of the Repeat Copy job is printed.

Deleting Repeat Copy Job

Follow the steps as below to delete stored Repeat Copy job.

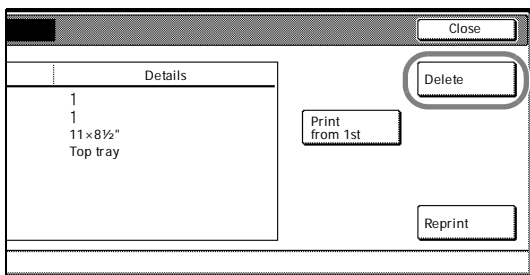

- 1** Press the **Repeat Copy** key.
- 2** Press [Delete].
- 3** Press [Yes] to delete the job.

Auto Image Rotation

Copies the original image rotated clockwise 90 degrees if set original and the paper loaded into the cassette are the same size but different orientations.



Note Set whether to enable or disable Auto Image Rotation mode in default settings mode. For further details, refer to *Selecting Auto Image Rotation* on page 3-8.

Auto Image Rotation mode supports 11 × 8 1/2", 8 1/2 × 11", 5 1/2 × 8 1/2", A4, A4R, A5R, B5, B5R, B6R, 16K and 16KR paper sizes only.

Follow the steps as below to use Auto Image Rotation.

- 1 Press [Function] and then press [▼ Down].
- 2 Press [Auto Image Rotation].
- 3 Press [On].

Auto Image Rotation is enabled.

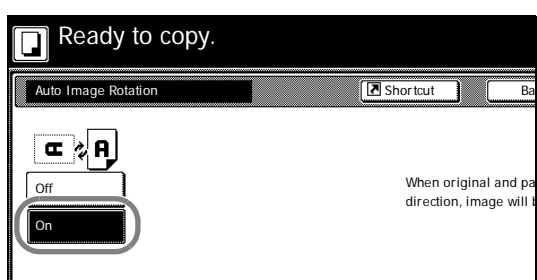

Selecting Output Destination

The optional job separator, document finisher or built-in finisher can be specified as copy output destinations.

Paper Output	Description
Top tray	Outputs to the top tray of the machine.
Job Sep. Tray	Outputs to the optional job separator.
Finisher tray	Outputs to the optional document finisher tray or built-in finisher tray.

 **Note** Requires the optional job separator, document finisher or built-in finisher.

Change the default destination for copies in default settings mode. For further details, refer to *Selecting Output Destination* on page 3-18.

Follow the steps as below to select the output destination.

- 1 Press [Function] and then press [▼ Down].
- 2 Press [Output Tray].
- 3 Select the output destination.
- 4 Place the original and press the **Start** key. Copying begins.

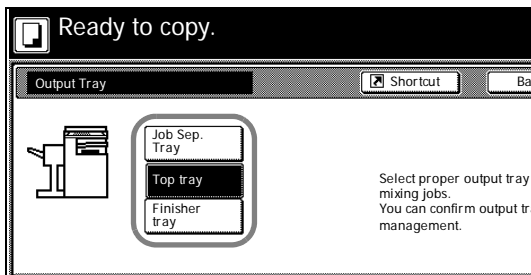

EcoPrint

Set EcoPrint mode to save toner consumption. Use this mode when high-quality copying is not required (e.g., when making test copies).

 **Note** The image may appear lighter.

Follow the below steps to configure EcoPrint.

- 1 Press [Function] and then press [▼ Down].
- 2 Press [EcoPrint].
- 3 Press [On]. EcoPrint is enabled.

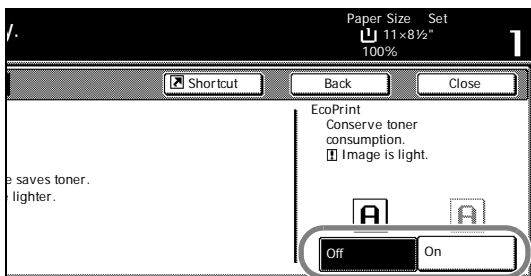

Negative Image Copying

Copies the black and white negative (reversed) images of black and white originals.

Follow the steps as below for negative image copying.

- 1 Press [Function] and then press [▼ Down].
- 2 Press [Negative Image].
- 3 Press [On]. Negative image copying is enabled.

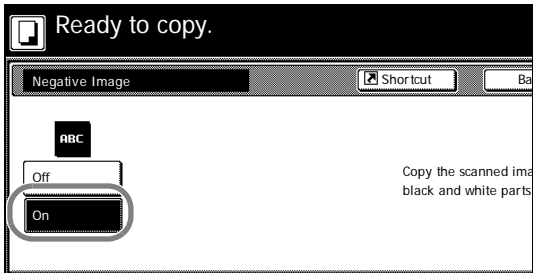

Mirror Copying

Copies mirrored images of the original.

Follow the steps as below for Mirror Copying.

- 1 Press [Function] and then press [▼ Down].
- 2 Press [Mirror Image].
- 3 Press [On]. Mirror copying is enabled.

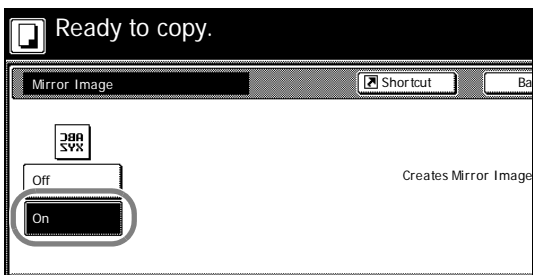

Mixed Size Originals Mode

Using the optional document processor, the originals of different sizes can be loaded in a batch and copied. The size of each original page is automatically detected and each original is automatically printed to the matching paper size or all originals printed are on the same size output paper.



Note This operation requires the optional document processor.

Up to 30 sheets can be loaded in to the document processor at once for Mixed Size Originals mode.

The following paper sizes can be used.

Inch models: 11 × 8 1/2" and 11 × 17", 8 1/2 × 14" and 8 1/2 × 11"

Metric models: A3 and A4, B4 and B5

Mixed Size Copies

Each copy is the same size as the original.

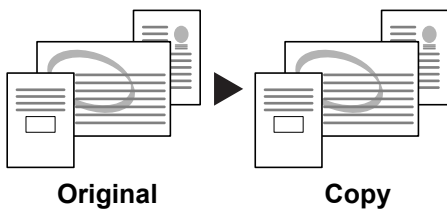

Original

Copy

Same Sized Copies

All originals are output on a single size copy.

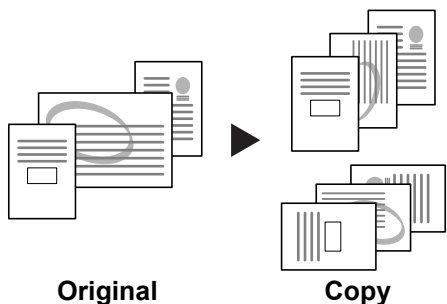

Original

Copy

Follow the steps as below for Mixed Size Originals mode.

- 1 Place originals in document processor.
- 2 Press the **Mixed Sized Originals** key.
- 3 Press [Mixed Size Copies] or [Same Sized Copies].

For [Same Sized Copies], select the size of the first original page and press [Close]. Select the paper tray from the [Basic] screen.



Note In order to correctly set the finished bind direction, set the size of the first page of the original.

- 4 Press the **Start** key. Copying begins.

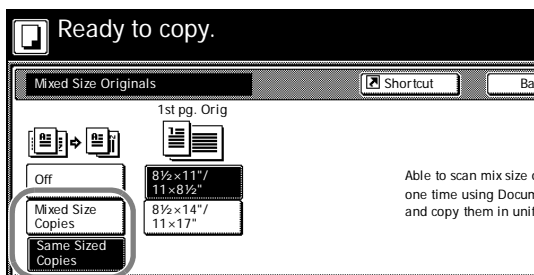
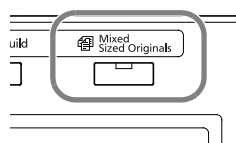

Programmed Copying

Press the program number (1 to 8) to recall the program. After registering sets of frequently used functions as a single program, you can simply press the program number as needed to recall those functions. You can also name the programs to identify them.

Registering Programs

Follow the steps as below to register a program.

- 1 Access the copy mode you would like to register and press [Program].
- 2 Press [Register].
- 3 Press the number (1 to 8) of the program to register.
- 4 Enter the program name and press [End].



Note Refer to the *Operation Guide* for how to enter text characters.

- 5 Press [Yes]. The program is registered.

Register present setting
Select program number.

1. No registration	5. No registration
2. No registration	6. No registration
3. No registration	7. No registration
4. No registration	8. No registration

Using Programs to Copy

Press the number (1 to 8) of the program to use for copying.

- 1 Press [Program].
- 2 Press the button for the desired program number (1 to 8).
- 3 Place the original and press the **Start** key. Copying begins using the configured program.

Ready to copy.

Recall

1. abc	5. list d
2. list a	6.
3. list b	7. file 1
4. list c	8. file 2

Basic User choice Function Program

Editing Program Names

Follow the steps as below to edit the names assigned to registered programs.

- 1 Press [Program].
- 2 Press [Change Name].
- 3 Press the number (1 to 8) of the program to rename.
- 4 Re-enter the program name and press [End].



Note Refer to the *Operation Guide* for how to enter text characters.

- 5 Press [Yes]. The modified program name is saved.

Registration name change
Select the number for changing name.

1. abc	5. list d
2. list a	6. No registration
3. list b	7. file 1
4. list c	8. file 2

Deleting programs

Follow the steps below to delete saved programs.

- 1** Press [Program].
- 2** Press [Delete].
- 3** Press the number (1 to 8) of the program to delete.
- 4** Press [Yes]. The program is deleted.

The screenshot shows a menu titled "Delete registration" with the instruction "Select the number of program to delete." Below this, there are eight numbered options, each in a rectangular box:

1. abc	5. list d
2. list a	6. No registration
3. list b	7. file 1
4. list c	8. file 2

Assigning Register Keys

Assigns three frequently used functions listed on the [Function] screen to assign keys. Functions may also be assigned from the [Basic] screen or [User choice] screen.

Assigning Register Keys

Follow the steps as below to assign register keys.

 **Note** To assign a register key, first set *Showing the Register Key* on page 3-10 to [On].

- 1 Open the function you would like to assign.
- 2 Press [Shortcut] ([Register]).

 **Note** Functions in which [Shortcut] ([Register]) is displayed may be assigned register keys.

- 3 Press [Register].
- 4 Press the number (1 to 3) to be assigned.
- 5 Press [Yes]. The registered register keys will be displayed at the right of the [Basic] screen.

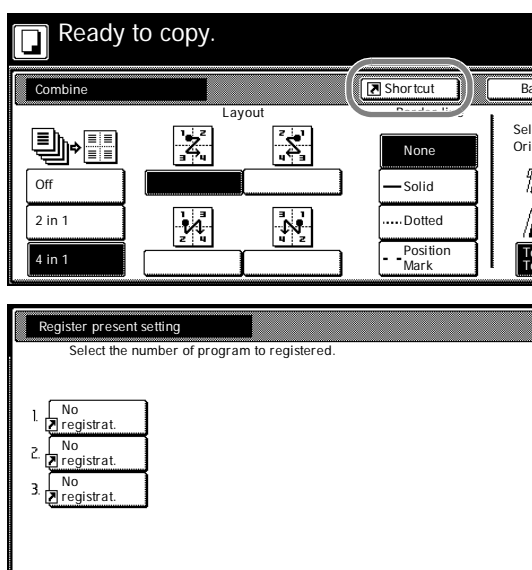

Deleting Register Keys

Follow the steps as below to delete Register keys.

- 1 Press the Register key display the assigned function.
- 2 Press [Shortcut] ([Register]) to display *Create Shortcut (Register)*.
- 3 Press [Delete].
- 4 Press the number (1 to 3) you would like to delete.
- 5 Press [Yes]. The register key is deleted.

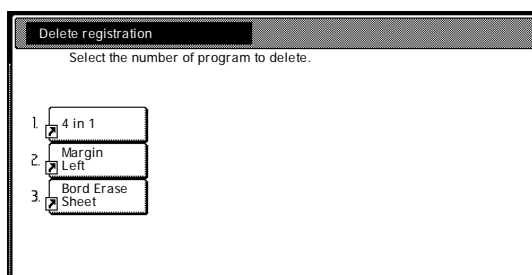

Job Build

Job Build allows you to scan originals in several separate steps and copy at once. In each step of the scanning process you can specify different settings (such as zooming and border erase) and you can specify different types of originals. Other examples include inserting a blank sheet between sets of copies from each step and specifying a front cover page during a duplexing step.

Job Build Procedure

This procedure describes how to use a job build for the following example.

Example

<Finished Copies>

Pages marked with * are blank, pages shown in gray are colored paper.

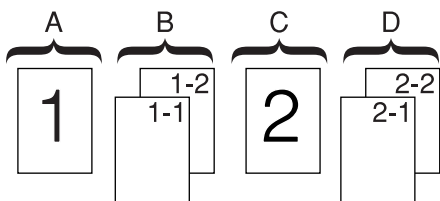
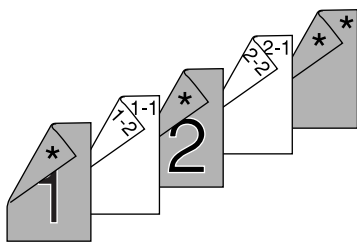

<Originals>



Note In this example, color paper to be used for the cover page is set in the MP tray and regular paper is loaded in Cassette 1.

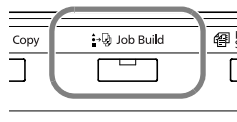

Open the Job Build Screen. Step 1:

- 1 Press the **Job Build** key.

Settings Common to All Steps

Sets Duplexing and Repeat Copy.



Note Set Repeat Copy to increase number of sets later as needed.

Other settings not used in this example may also be configured here. For further details, refer to *Setting Functions* on page 1-37.

- 2 Press [1 sided/2 sided] ([1-sided/2-sided]).

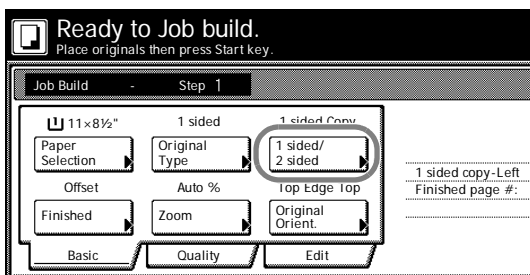

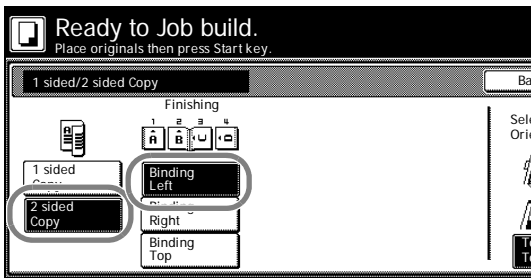

3 Press [2 sided Copy] ([2-sided Copy]), and from *Finishing* select [Binding Left] and press [Close].

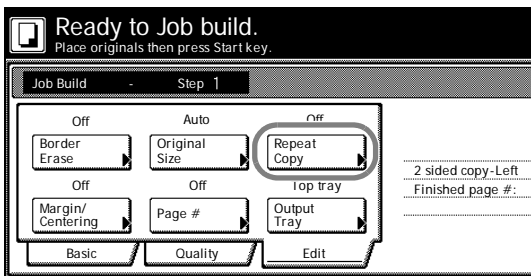

4 Press [Edit] and on the next screen press [Repeat Copy].

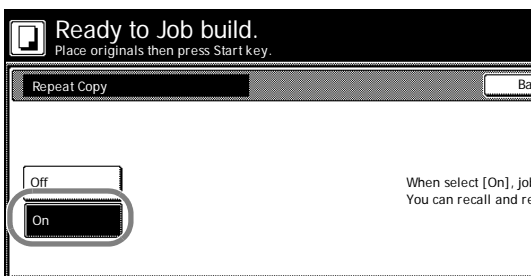

5 Press [On] and press [Close].

Original A Settings

For paper selection, set MP tray (color paper).

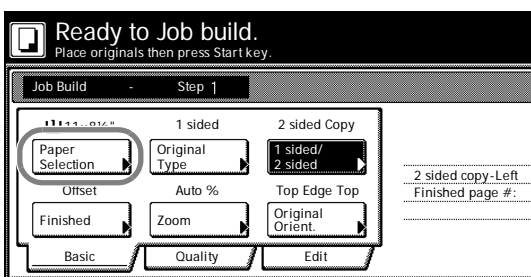
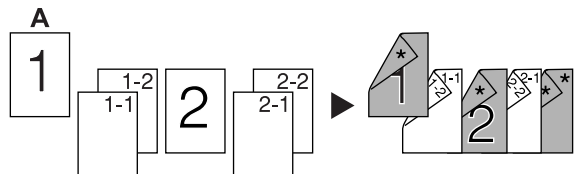

6 Press [Basic]. On the next screen, press [Paper Selection].

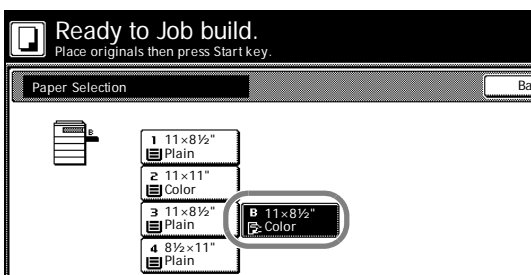

7 Select the MP tray and press the [Close].

8 Place the Original A and press the **Start** key. Scanning of the original begins.

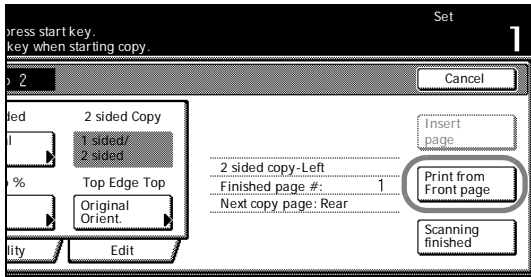

Step 2: Set Original A Back Side to Blank

9 Press [Print from Front page].

The back side of the page will be left blank and copying will continue from the next page.

Step 3: Complete the Settings for Original B.

Select Cassette 1 (plain paper) for paper setting.

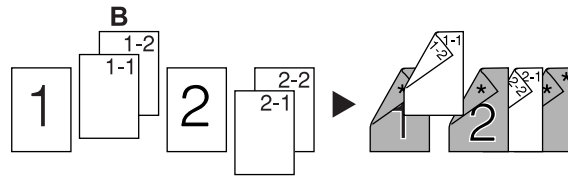

10 Press [Paper Selection].

11 Select Cassette 1 and press [Close].

12 Place Original B and press the **Start** key. Scanning of the original begins.

Step 4: Complete the Settings for Original C

For paper selection, set MP tray (color paper).

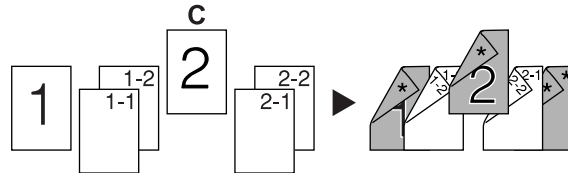

13 Press [Paper Selection].

14 Select the MP tray and press [Close].

15 Place Original C and press the **Start** key. Scanning of the original begins.

Step 5: Leave Back Side of Original C Blank

16 Press [Print from Front page].

The back side of the page will be left blank and copying will continue from the next page.

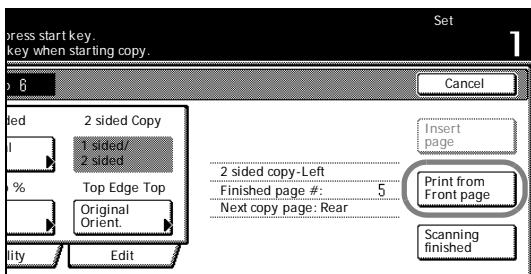

Step 6: Complete the Settings for Original D

Select Cassette 1 (plain paper) for paper setting.

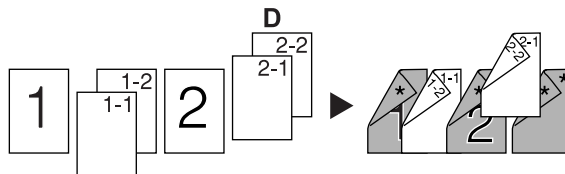

17 Press [Paper Selection].

18 Select Cassette 1 and press [Close].

19 Place the Original D and press the **Start** key. Scanning of the original begins.

Step 7: Specify Blank Colored Paper for the Back Cover

For paper selection, set MP tray (color paper).

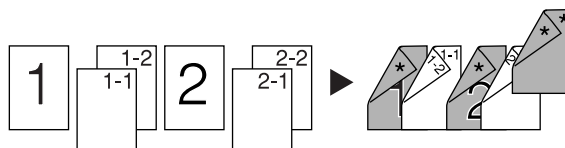

20 Press [Paper Selection].

21 Select the MP tray and press [Close].

22 Press [Insert page] ([Insert blank page]).

23 All originals have been scanned. Press [Scanning finished]. Printing begins.

24 If there are no problems with the output, use Repeat Copy to produce additional copies as necessary. For further details, refer to *Repeat Copy* on page 1-25.

This completes the steps for the above operation.

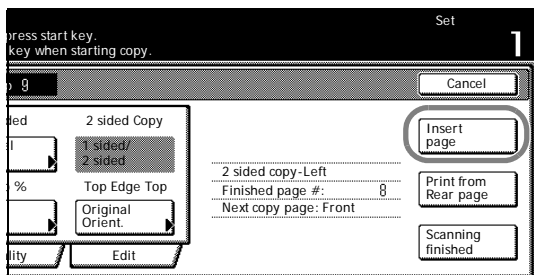

Setting Functions

This section explains the copying functions available when using Job Build.

Paper Selection

Select the paper size.

1 Press [Basic]. On the next screen, press [Paper Selection].

2 Select the MP tray or a cassette and press [Close].

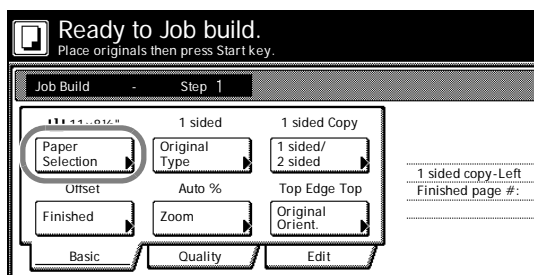

Original Type

Select the original type according to type of original being scanned. The following original types are available.

Original Type	Description
1 sided (1-sided)	Single sided sheet original.
2 sided (2-sided)	2-sided sheet original.
Book	Magazine or book originals with facing pages.

- 1 Press [Basic]. On the next screen, press [Original Type].
- 2 Select [1 sided] ([1-sided]), [2 sided] ([2-sided]) or [Book].
When selecting [2 sided], check the binding direction and be sure that the originals are placed in the correct orientation.
When selecting [Book], be sure that the binding direction is correct.



Note [2 sided] ([2-sided]) is displayed when the optional document processor is installed.

- 3 Press [Close].

1 sided/2 sided Copying

Select either [1 sided Copy] ([1-sided Copy]) or [2 sided Copy] ([2-sided Copy]) for the finish type.

- 1 Press [Basic]. On the next screen, press [1 sided/2 sided] ([1-sided/2-sided]).



Note 1 sided/2 sided copy selection is common to all steps. It may only be configured as the first step.

- 2 Press [1 sided Copy] ([1-sided Copy]) or [2 sided Copy] ([2-sided Copy]) and from *Finishing* select the binding direction.
- 3 Check the orientation of the original.



Note Incorrect copying may occur if the original is not placed correctly.

- 4 Press [Close].

Finish

Set the Finish options. The following settings are available.

Offset (Group) – Each completed set is rotated 90 degrees to the next before stacking.

Stapling – Use the optional document finisher or built-in finisher to staple the completed copies.

- 1 Press [Basic]. On the next screen, press [Finished].



Note Finish settings are common for all steps. It may only be configured as the first step.

- 2 For finishing, press [On] ([1 set]). For further details, refer to *Offset Mode* on page 1-7.

For stapling, press [Staple Mode] and complete the settings. For further details, refer to *Stapling* on page 1-8.

- 3 Check the orientation of the original.



Note Incorrect copying may occur if the original is not placed correctly.

- 4 Press [Close].

Zoom

Select the desired magnification.

- 1 Press [Basic]. On the next screen, press [Zoom].
- 2 Select the desired magnification.

For instructions on reducing/enlarging, refer to *Zoom* in *Chapter 3 of Operation Guide*.

- 3 Press [Close].

Original Orientation

Check the orientation of the original.

- 1 Press [Basic]. On the next screen, press [Original Orient.].
- 2 Select [Top Edge Top] or [Top Edge Left].



Note Incorrect copying may occur if the original is not placed correctly.

- 3 Press [Close].

Density

Set the copy density. The setting items are as follows.

Item	Description
Auto	Automatically adjusts copy contrast.
Manual	Manually adjust the copy contrast.

- 1 Press [Quality] and on the next screen press [Density].
- 2 Select [Auto] or [Manual].
If [Manual] is selected, press [Lighter] or [Darker] to adjust the contrast.
- 3 Press [Close].

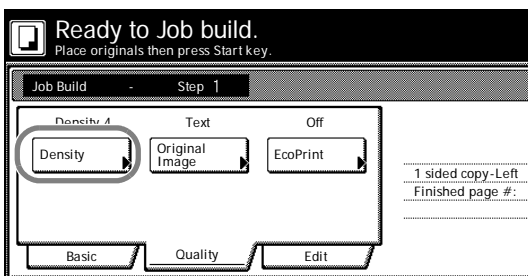

Original Image Quality

Specify the Image Quality based on the original type.

- 1 Press [Quality] and on the next screen, press [Original Image].
- 2 Select the image quality. For further details on image quality, refer to *Selecting Image Quality* in *Chapter 3 of Operation Guide*.
- 3 Press [Close].

EcoPrint

Set EcoPrint to save toner consumption.

- 1 Press [Quality] and on the next screen press [EcoPrint].



Note EcoPrint is a common setting to all steps. It may only be configured as the first step.

- 2 Press [On]. EcoPrint is enabled.
- 3 Press [Close].

Border Erase

Prevents the appearance of shadows from around the edges of originals. The setting items are as follows.

Item	Description
Bord Erase Sheet	Erase black borders around the single sheet original.
Individual BordrErase	Specify border widths individually on all sides to erase.

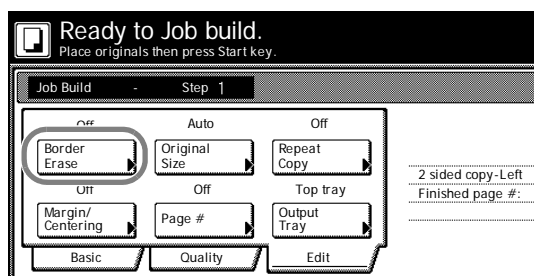

- 1 Press [Edit] and on the next screen press [Border Erase].
- 2 Press [Bord Erase Sheet] or [Individual BordrErase] and specify the border width to erase. For further details, refer to *Border Erase* on page 1-14.
- 3 Press [Close].

Selecting original size

Specify the size of the original.

- 1 Press [Edit] and on the next screen press [Original Size].
- 2 Set the original size. For further details, refer to *Selecting Original Size* on page 1-3.
- 3 Press [Close].

Repeat Copy

Specify Repeat Copy as follows. Use Repeat Copy to enable the production of additional copies as needed after a copy job is completed.

- 1 Press [Edit] and on the next screen press [Repeat Copy].



Note Repeat Copy setting is common to all steps. It may only be configured as the first step.

- 2 Press [On] to activate Repeat Copy. For further details, refer to *Repeat Copy* on page 1-25.
- 3 Press [Close].

Margin/Centering

Set margin (blank borders) and centering options.

- 1 Press [Edit] and on the next screen press [Margin/Centering].



Note Margin/Centering setting is common to all steps. It may only be configured as the first step.

- 2 Press [Margin] or [Centering]. For further details, refer to *Margin Mode* on page 1-12 and *Centering Originals* on page 1-13.
- 3 Press [Close].

Page Numbering

Specify page numbering in the sequence of originals as follows.

- 1 Press [Edit] and on the next screen press [Page #] ([Page numbering]).



Note Page numbering configuration is common to all steps. It may only be configured as the first step.

- 2 For further details about page numbering, refer to *Page Numbering* on page 1-16.
- 3 Press [Close].

Selecting Output Destination

The optional job separator, document finisher or built-in finisher can be specified as copy output destinations.

- 1 Press [Edit] and on the next screen press [Output Tray].



Note Output destination is displayed with the optional job separator, document finisher or built-in finisher is installed.

The output destination setting applies to all other steps. It may only be configured as the first step.

- 2 Specify the output destination. For further details, refer to *Selecting Output Destination* on page 1-28.
- 3 Press [Close].

2 Output Management Functions

This chapter explains the machine's output management functions.

Overview of Output Management Functions	2-2
Using the Output Management Functions	2-2
[Prt Status] Screen.....	2-3

Overview of Output Management Functions

The output management functions manage jobs that are queued for printing. For example, if the machine receives a print job or a fax while it is copying, the incoming job is placed in the print queue until it can be printed. The output management functions allow you to review the job currently being printed as well as any queued jobs.

Output management functions are useful in the following situations.

Purpose	Method
To find out the position of your job in the queue	You can check the status of currently queued jobs in the [Print Management] screen. Jobs are listed in order from the top down, allowing you to see at a glance how far down the queue your job is. (In the list, [📄] indicates a copy job, [📠] indicates a print job and [📠] indicates a fax.)
To find out whether your job has been printed	Check the [Print Management] screen. If your job is listed in the [Print Management] screen, it has not yet been printed.
To move a job up in the print queue	Select the job you want to print sooner in the [Print Management] screen and press [Move ahead] ([Move up]). The job moves up in the queue. You can also pause the job currently being printed and print the selected job immediately by pressing [Interrupt Print].



Note To use the machine as a printer or fax, you must install the optional printer kit or fax kit.

Using the Output Management Functions

Manage jobs using the [Prt Status] ([Prt Status]) screen for output management function.

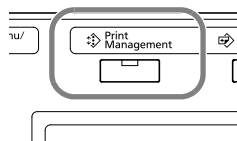

Press the **Print Management** key. [Prt Status] ([Prt Status]) screen is displayed.

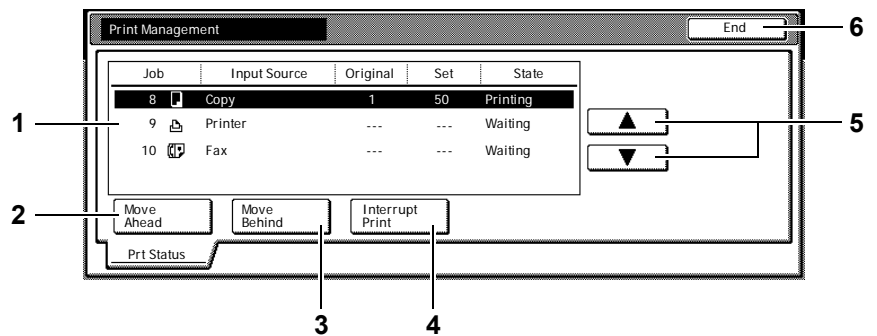

[Prt Status] Screen

Displays information about current printing status and queued jobs.



- 1 Job List** – Shows job information. The job currently in progress is listed on top, with subsequent jobs listed below in the order they will be finished. In the list, copy jobs are designated by , print jobs by , and fax jobs by .
- 2 [Move Ahead] ([Move up])** – Increases the print priority of the selected job.
- 3 [Move Behind] ([Move down])** – Decreases the print priority of the selected job.
- 4 [Interrupt Print]** – Cancels the current print operation and begins printing the selected job. The job is moved to the top of the list.
- 5 [▲]/[▼]** – Use to select the desired job.
- 6 [End]** – Close the Output Management Function. Pressing this key displays the [Basic] screen or shows the current progress.

3 System Menu

This chapter explains how to configure various settings using the menus on the machine's operation panel.

The main configurable settings are as follows.

Default Settings	3-2
Default Settings for Copying.....	3-2
Machine Default.....	3-11
Setting MP Tray	3-23
Specifying the Paper Size for the MP Tray.....	3-23
Specifying the Media Type for the MP Tray.....	3-23
Registering Non-standard Sizes for Originals	3-24
Drum Refresh	3-25
Printing Reports	3-26
Checking Total Copy Count	3-28

Default Settings

This section explains how to change default settings which are applied when the machine is powered up or the **Reset** key is pressed. Automatically configured details set in default setting mode are called default settings. Default settings are divided between *Default Settings for Copying* and *Machine Default*. These settings may be freely modified to suit your usage patterns.

Default Settings for Copying

Set the following default copy settings.

- Density...3-3
- Density Steps...3-3
- Original Image Quality...3-3
- Setting EcoPrint...3-4
- Adjusting Background Density...3-4
- Correcting Black Lines...3-4
- Paper Selection...3-5
- Setting Auto Paper Selection...3-5
- Selecting Media Types for Automatic Paper Selection...3-5
- Selecting Default Paper Source...3-6
- Specifying Paper Source for Cover...3-6
- Setting Auto % Priority...3-6
- Adjusting Auto Density...3-7
- Adjusting Manual Density...3-7
- Selecting Default Zoom...3-7
- Selecting Collating and Offsetting Output...3-8
- Selecting Auto Image Rotation...3-8
- Setting Margin Defaults...3-8
- Erasing Borders...3-9
- Selecting Maximum Number of Copies...3-9
- Enabling Repeat Copy...3-9
- Showing the Register Key...3-10
- Customize (Basic Screen)...3-10
- Customize (User Choice)...3-10

Accessing the *Copy Default* screen

Follow the procedures below to access the *Copy Default* screen.

- 1 Press the **System Menu/Counter** key.
- 2 Press [Copy Default].
- 3 Use the numeric keys to enter the 4 digit management code. The default setting is 2500 for the 25 cpm model and 3000 for the 30 cpm model.

If the correct management code has been entered, the *Copy Default* screen will be displayed.



Note For security, it is recommended to change the management code. For further details, refer to *Changing Management Code* on page 3-20.

- 4 Refer to the following configuration items to configure the default settings.

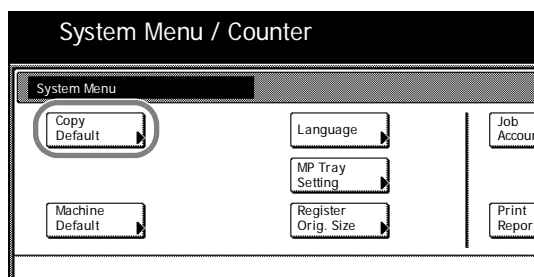

Density

Set the density for default settings mode. The setting items are as follows.

Item	Description
Manual	Sets manual copy density.
Auto	Sets automatic copy density.

For further information regarding density, refer to the *Operation Guide*.

- 1 Referring to *Accessing the Copy Default screen* on page 3-2, access the *Copy Default* screen.
- 2 Press [▲] or [▼] to select *Density Mode* and press [Change #].
- 3 Select [Manual] or [Auto].
- 4 Press [Close] to save settings or [Back] to cancel settings. The display returns to the *Copy Default* screen.

Density Steps

Change the density adjustment step amount. The setting items are as follows.

Item	Description
1 step	7 density adjustment steps are available.
0.5 step	13 more accurate density adjustment steps are available.

- 1 Referring to *Accessing the Copy Default screen* on page 3-2, access the *Copy Default* screen.
- 2 Press [▲] or [▼] to select *Density Steps* and press [Change #].
- 3 Select [1 step] or [0.5 step].
- 4 Press [Close] to save settings or [Back] to cancel settings. The display returns to the *Copy Default* screen.

Original Image Quality

Set the original image quality for default settings mode. The setting items are as follows.

Item	Description
Text+Photo	Appropriate for mixed text and photo originals.
Photo	Appropriate for photo originals.
Text	Appropriate for document originals with large amounts of text.

- 1 Referring to *Accessing the Copy Default screen* on page 3-2, access the *Copy Default* screen.
- 2 Press [▲] or [▼] to select *Original Image* and press [Change #].
- 3 Select [Text+Photo], [Photo] or [Text].
- 4 Press [Close] to save settings or [Back] to cancel settings. The display returns to the *Copy Default* screen.

Setting EcoPrint

Set EcoPrint for default settings mode. The setting items are as follows.

Item	Description
Off	Do not enable EcoPrint.
On	Enable EcoPrint.

For more information on EcoPrint, refer to page 1-28.

- 1 Referring to *Accessing the Copy Default screen* on page 3-2, access the *Copy Default* screen.
- 2 Press [▲] or [▼] to select *EcoPrint* and press [Change #].
- 3 Select [Off] or [On].
- 4 Press [Close] to save settings or [Back] to cancel settings. The display returns to the *Copy Default* screen.

Adjusting Background Density

If the background on copies appears too dark, you can lighten it. The setting items are as follows.

Item	Description
Lighter	Lightens the background color in copies.
Darker	Darkens the background color in copies.

- 1 Referring to *Accessing the Copy Default screen* on page 3-2, access the *Copy Default* screen.
- 2 Press [▲] or [▼] to select *Background Density Adj* and press [Change #].
- 3 Press [Lighter] or [Darker] to adjust the density.
- 4 Press [Close] to save settings or [Back] to cancel settings. The display returns to the *Copy Default* screen.

Correcting Black Lines

Set Black Line correction to reduce the black lines (dragged stains not appearing on the original) that may occur when copying using the optional document processor. The setting items are as follows.

Item	Description
Off	Disables Black Line correction.
On (Low)	Suppress black streaks moderately.
On (High)	Suppress black streaks strongly.



Note When suppressing black streaks, select [On (Low)]. Select [On (High)] only when the black streaks are not suppressed with the Low setting.

When black line correction is enabled, the ability to reproduce fine text characters is reduced. For normal usage, the default setting ([Off]) is recommended.

- 1 Referring to *Accessing the Copy Default screen* on page 3-2, access the *Copy Default* screen.
- 2 Press [▲] or [▼] to select *Correcting Black Line* and press [Change #].

- 3** Select [Off], [On (Low)] or [On (High)].
- 4** Press [Close] to save settings or [Back] to cancel settings. The display returns to the *Copy Default* screen.

Paper Selection

In default settings mode, set the paper selection method for when an original is set. The setting items are as follows.

Item	Description
APS	Selects the cassette loaded with the same size paper as the original.
Default cassette	Selects the cassette configured as the default paper source (refer to page 3-6).

- 1** Referring to *Accessing the Copy Default screen* on page 3-2, access the *Copy Default* screen.
- 2** Press [▲] or [▼] to select *Paper Selection* and press [Change #].
- 3** Select [APS] or [Default cassette].
- 4** Press [Close] to save settings or [Back] to cancel settings. The display returns to the *Copy Default* screen.

Setting Auto Paper Selection

Set the paper selection method for Auto Paper Selection mode when changing the zoom ratio. The setting items are as follows.

Item	Description
Most Suit Size	Changes the paper size to match the size after zooming.
Same as Orig. Size	Leaves the paper size the same size as the original, even after zooming.

- 1** Referring to *Accessing the Copy Default screen* on page 3-2, access the *Copy Default* screen.
- 2** Press [▲] or [▼] to select *APS Setting* and press [Change #].
- 3** Select [Most Suit Size] or [Same as Orig. Size].
- 4** Press [Close] to save settings or [Back] to cancel settings. The display returns to the *Copy Default* screen.

Selecting Media Types for Automatic Paper Selection

Select Automatic Paper Selection mode to limit the available media types. For example, set to [Plain] to select the cassette set the same size paper and set to plain paper for the media type. Set to [Off] to select the cassette with the same size paper regardless of media type.

The following media types are available.

Plain, Rough, Vellum, Recycled, Preprinted, Bond, Color (Colour), Prepunched, Letterhead, Thick paper, High Quality, Custom 1 - 8



Note Select the media type set for the current cassette. For further details, refer to *Specifying the Media Type* on page 3-13.

- 1** Referring to *Accessing the Copy Default screen* on page 3-2, access the *Copy Default* screen.

- 2** Press [▲] or [▼] to select *Select media type (APS)* and press [Change #].
- 3** Select [Off] or [On].
If [On] is selected, select the media type.
- 4** Press [Close] to save settings or [Back] to cancel settings. The display returns to the *Copy Default* screen.

Selecting Default Paper Source

Automatically selects the default cassette (1 - 4).



Note The MP tray may not be set as the default paper source.

Cassette 3 and *Cassette 4* are shown when the optional paper feeder have been installed.

- 1** Referring to *Accessing the Copy Default screen* on page 3-2, access the *Copy Default* screen.
- 2** Press [▲] or [▼] to select *Default Paper Source* and press [Change #].
- 3** Select the cassette to use as the default.
- 4** Press [Close] to save settings or [Back] to cancel settings. The display returns to the *Copy Default* screen.

Specifying Paper Source for Cover

Specify the paper source cassette (1 - 4) or MP tray which is loaded with cover paper. Cover paper is used in cover mode (refer to page 1-18) and booklet mode (refer to page 1-19, page 1-21).



Note *Cassette 3* and *Cassette 4* are shown when the optional paper feeder have been installed.

- 1** Referring to *Accessing the Copy Default screen* on page 3-2, access the *Copy Default* screen.
- 2** Press [▲] or [▼] to select *Paper Source for Cover* and press [Change #].
- 3** Select the paper source containing the cover paper.
- 4** Press [Close] to save settings or [Back] to cancel settings. The display returns to the *Copy Default* screen.

Setting Auto % Priority

Specify whether to set auto zoom when the paper in the selected cassette is different from the size of the original. The setting items are as follows.

Item	Description
Off	Sets zoom to equal (100%).
On	Automatically sets zoom to fit the paper size.

- 1** Referring to *Accessing the Copy Default screen* on page 3-2, access the *Copy Default* screen.
- 2** Press [▲] or [▼] to select *Auto % Priority Setting* and press [Change #].
- 3** Select [Off] or [On].

-
- 4 Press [Close] to save settings or [Back] to cancel settings. The display returns to the *Copy Default* screen.

Adjusting Auto Density

Adjusts the overall lightness or darkness when copying with auto density. The setting items are as follows.

Item	Description
Lighter	Lightens the overall density when copying with auto density.
Darker	Darkens the overall density when copying with auto density.

- 1 Referring to *Accessing the Copy Default screen* on page 3-2, access the *Copy Default* screen.
- 2 Press [▲] or [▼] to select *Density Adjustment (Auto)* and press [Change #].
- 3 Press [Lighter] or [Darker] to adjust the density.
- 4 Press [Close] to save settings or [Back] to cancel settings. The display returns to the *Copy Default* screen.

Adjusting Manual Density

Adjusts the overall lightness or darkness when copying with manual density. The setting items are as follows.

Item	Description
Lighter	Lightens the overall density when copying with manual density.
Darker	Darkens the overall density when copying with manual density.

- 1 Referring to *Accessing the Copy Default screen* on page 3-2, access the *Copy Default* screen.
- 2 Press [▲] or [▼] to select *Density Adjust. (Manual)* and press [Change #].
- 3 Press [Lighter] or [Darker] to adjust the density.
- 4 Press [Close] to save settings or [Back] to cancel settings. The display returns to the *Copy Default* screen.

Selecting Default Zoom

Set the reduce/enlarge setting in default settings mode. The setting items are as follows.

Item	Description
Auto %	Automatically sets zoom to fit the paper size.
100%	Sets zoom to equal (100%).

- 1 Referring to *Accessing the Copy Default screen* on page 3-2, access the *Copy Default* screen.
- 2 Press [▲] or [▼] to select *Zoom* and press [Change #].
- 3 Select [Auto %] or [100%].

- 4 Press [Close] to save settings or [Back] to cancel settings. The display returns to the *Copy Default* screen.

Selecting Collating and Offsetting Output

Set collating and offsetting output options in default settings mode. The setting items are as follows.

Item		Description
Collate	Off	Do not enable collate mode.
	On	Enable collate mode.
Offset	Off	Do not enable offset mode.
	On	Enable offset mode.

For further details about collate mode, refer to *Operation Guide*; for further details about offset mode, refer to page 1-7.

- 1 Referring to *Accessing the Copy Default screen* on page 3-2, access the *Copy Default* screen.
- 2 Press [▲] or [▼] to select *Collate/Offset* and press [Change #].
- 3 Under *Collate*, select [Off] or [On].
- 4 Under *Offset*, select [Off] or [On].
- 5 Press [Close] to save settings or [Back] to cancel settings. The display returns to the *Copy Default* screen.

Selecting Auto Image Rotation

Set auto image rotation in default settings mode. The setting items are as follows.

Item	Description
Off	Do not enable auto image rotation.
On	Enable auto image rotation.

For further details about auto image rotation, refer to page 1-27.

- 1 Referring to *Accessing the Copy Default screen* on page 3-2, access the *Copy Default* screen.
- 2 Press [▲] or [▼] to select *Auto Image Rotation* and press [Change #].
- 3 Select [Off] or [On].
- 4 Press [Close] to save settings or [Back] to cancel settings. The display returns to the *Copy Default* screen.

Setting Margin Defaults

Set the margin width default values. The setting ranges are as follows.

Model Type	Range
Inch models	0 - 3/4" (1/8" increments)
Metric models	0 - 18 mm (1 mm increments)

For further details about margin mode, refer to page 1-12.

- 1 Referring to *Accessing the Copy Default screen* on page 3-2, access the *Copy Default* screen.

- 2 Press [▲] or [▼] to select *Default margin width* and press [Change #].
- 3 Press [▲], [▼], [◀] or [▶] to set the margin width.
- 4 Press [Close] to save settings or [Back] to cancel settings. The display returns to the *Copy Default* screen.

Erasing Borders

Set the border erase default values. The setting ranges are as follows.

Model Type	Range
Inch models	0 - 2" (1/8" increments)
Metric models	0 - 50 mm (1 mm increments)

For further details about border erase, refer to page 1-14.

- 1 Referring to *Accessing the Copy Default screen* on page 3-2, access the *Copy Default* screen.
- 2 Press [▲] or [▼] to select *Default erase width* and press [Change #].
- 3 Press [+] or [-] to set the *Border* (outer edges) and *Gutter* (middle) border widths.
- 4 Press [Close] to save settings or [Back] to cancel settings. The display returns to the *Copy Default* screen.

Selecting Maximum Number of Copies

Limits the number of sets that can be specified for a single copy. Set to between 1 - 999 sets.

- 1 Referring to *Accessing the Copy Default screen* on page 3-2, access the *Copy Default* screen.
- 2 Press [▲] or [▼] to select *Preset limit* and press [Change #].
- 3 Use the numeric keys to specify the preset limit value.
- 4 Press [Close] to save settings or [Back] to cancel settings. The display returns to the *Copy Default* screen.

Enabling Repeat Copy

Disable repeat copy or configure repeat copy in the default settings mode. The setting items are as follows.

Item		Description
Function	Off	Prevents the use of repeat copy.
	On	Allows the use of repeat copy.
Default	Off	Do not enable repeat copy.
	On	Enable repeat copy.

For further details about repeat copy, refer to page 1-25.

- 1 Referring to *Accessing the Copy Default screen* on page 3-2, access the *Copy Default* screen.
- 2 Press [▲] or [▼] to select *Repeat Copy* and press [Change #].
- 3 Under *Function*, select [Off] or [On].
- 4 Under *Default*, select [Off] or [On].

- 5 Press [Close] to save settings or [Back] to cancel settings. The display returns to the *Copy Default* screen.

Showing the Register Key

Sets whether to show or hide [Shortcut] ([Register]) used to register/delete register keys. For further details about register keys, refer to page 1-33.

- 1 Referring to *Accessing the Copy Default screen* on page 3-2, access the *Copy Default* screen.
- 2 Press [▲] or [▼] to select *Display register key (Display "Register" key)* and press [Change #].
- 3 Select [Off] or [On].
- 4 Press [Close] to save settings or [Back] to cancel settings. The display returns to the *Copy Default* screen.

Customize (Basic Screen)

Rearrange the basic screen layout for maximum ease of use. You can rearrange 3 [Basic] screen functions and 3 [User choice] screen functions.

- 1 Referring to *Accessing the Copy Default screen* on page 3-2, access the *Copy Default* screen.
- 2 Press [▲] or [▼] to select *Customize (Basic Screen) (Customize (Main function))* and press [Change #].
- 3 The current functions are shown in *Register Mode*.

Press [▲] or [▼] to select the function to rearrange. Press [Move Ahead] or [Move Behind] ([Move Backward]) to change the *Register Mode* order.

The number in *Register Mode* corresponds to the display position number (left side of the screen).

- 4 Press [Close] to save settings or [Back] to cancel settings. The display returns to the *Copy Default* screen.

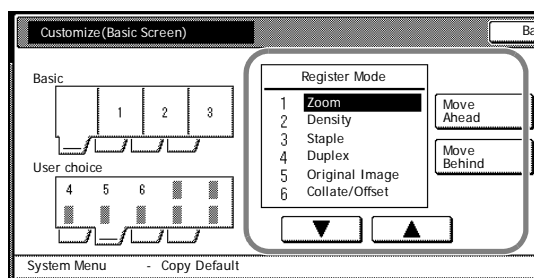

Customize (User Choice)

Rearrange the screen to easily access frequently used functions. You can change 6 frequently used features on the [User choice] screen.

- 1 Referring to *Accessing the Copy Default screen* on page 3-2, access the *Copy Default* screen.
- 2 Press [▲] or [▼] to select *Customize (User Choice) (Customize (Add function))* and press [Change #].
- 3 Current functions are shown in *Register Mode* and *Addition Mode* shows available functions that can be substituted for the current functions.

Under *Addition Mode*, press [▲] or [▼] to select the function to change. Under *Register Mode*, press [▲] or [▼] to select the function that is to be added and press [←] to move the function.

The number in *Register Mode* corresponds to the display position number (left side of the screen).

- 4 Press [Close] to save settings or [Back] to cancel settings. The display returns to the *Copy Default* screen.

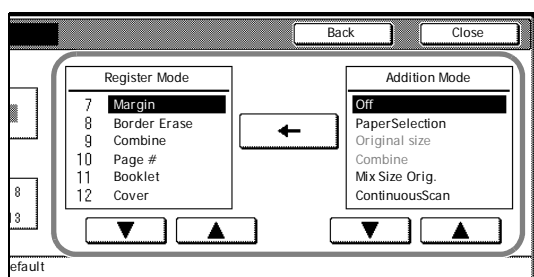

Machine Default

The following items can be set for machine default.

- Enabling Auto Cassette Switching...3-12
- Specifying the Paper Size...3-12
- Specifying the Media Type...3-13
- Registering MP Tray Paper Size...3-13
- Enabling Quick Access to MP Tray Settings...3-14
- Setting Media Type Properties (Paper Weight)...3-14
- Setting Media Type Properties (Duplex Mode)...3-15
- Setting Handling for Special Media Types...3-16
- Auto Detect Originals...3-17
- Orientation of Original Document...3-17
- Setting Sleep Timer Timeout...3-18
- Setting Low-Power Timer Timeout...3-18
- Setting Auto Clear Timeout Time...3-18
- Selecting Output Destination...3-18
- Selecting FAX Output Mode...3-19
- Select the Main Mode...3-19
- Setting Notification Sounds...3-20
- Silent Mode...3-20
- Changing Management Code...3-20
- Activating Auto Sleep...3-21
- Activating Auto Clear...3-21
- Auto Drum Refresh...3-22

Accessing the *Machine Default* Screen

Follow the steps as below to access the *Machine Default* screen.

- 1** Press the **System Menu/Counter** key.
- 2** Press [Machine Default].
- 3** Use the numeric keys to enter the 4 digit management code. The default setting is 2500 for the 25 cpm model and 3000 for the 30 cpm model.

If the correct management code has been entered, the *Machine Default* screen will be displayed.



Note For security, it is recommended to change the management code. For further details, refer to *Changing Management Code* on page 3-20.

- 4** Refer to the following configuration items to configure the default settings.

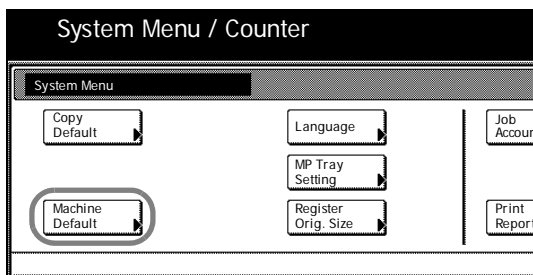

Enabling Auto Cassette Switching

Use auto cassette switching to automatically switch the paper source to another cassette loaded with the same size and orientation paper when the current cassette runs out of paper. You can also switch to a cassette with a different media type.

The setting items are as follows.

Item		Description
Function	Off	Do not enable auto cassette switching.
	On	Enable auto cassette switching.
Paper Type	All types of paper	Automatically switches a cassette even with different media type if the paper is the same size and direction.
	Feed same paper type	Do not switch to a cassette with different media type.

- 1 Referring to *Accessing the Machine Default Screen* on page 3-11, access the *Machine Default* screen.
- 2 Press [▲] or [▼] to select *Auto cassette switching* and press [Change #].
- 3 Under *Function*, select [Off] or [On].
- 4 Under *Paper Type*, select [All types of paper] or [Feed same paper type].
- 5 Press [Close] to save settings or [Back] to cancel settings. The display returns to the *Machine Default* screen.

Specifying the Paper Size

Specify the paper sizes for Cassettes 1 - 4. The setting items are as follows.

Item	Description
Auto Detection	The paper size is automatically detected. [Centimeter] ([Centimetre]) or [Inch] selection is required.
Standard sizes	Specify a standard size. The following paper sizes: 11 × 17", 8 1/2 × 14", 11 × 8 1/2", 8 1/2 × 11", 5 1/2 × 8 1/2", 8 1/2 × 13 1/2", 8 1/2 × 13" (Oficio II), A3, B4, A4, A4R, B5, B5R, A5R, Folio, 8K, 16K, 16KR are available.



Note *Cassette 3* and *Cassette 4* are shown when the optional paper feeder is installed.

- 1 Referring to *Accessing the Machine Default Screen* on page 3-11, access the *Machine Default* screen.
- 2 Press [▲] or [▼] to select the cassette to configure from *Paper size (Cassette 1 - Cassette 4)* and press [Change #].
- 3 Select [Auto Detection] or [Standard sizes].
If [Auto Detection] is selected, choose the unit type.
If [Standard sizes] is selected, choose the paper size.
- 4 Press [Close] to save settings or [Back] to cancel settings. The display returns to the *Machine Default* screen.

Specifying the Media Type

Specify the media type for Cassettes 1 - 4.

The available media types are *Plain, Vellum, Rough, Recycled, Preprinted, Bond, Color (Colour), Prepunched, Letterhead, Thick paper, High Quality*, and *Custom 1 - 8*.



Note *Cassette 3* and *Cassette 4* are shown when the optional paper feeder have been installed.

Media types in *Setting Media Type Properties (Paper Weight)* (refer to page 3-14) with weight (thickness) that cannot be inserted in the Cassette are not available.

- 1 Referring to *Accessing the Machine Default Screen* on page 3-11, access the *Machine Default* screen.
- 2 Press [▲] or [▼] to select the cassette to specify media type from *Media Type (Cassette 1 - Cassette 4)* and press [Change #].
- 3 Select the media type.
- 4 Press [Close] to save settings or [Back] to cancel settings. The display returns to the *Machine Default* screen.

Registering MP Tray Paper Size

Up to 4 custom paper sizes can be pre-registered for use with the MP tray. Registered sizes are shown as custom sizes when selecting paper size. The media type can also be specified for each registered size. The setting items are as follows.

Setting Detail	Setting Item
Paper size	Inch models Height: 3 7/8 - 11 5/8" (1/8" increments) Width: 5 7/8 - 17" (1/8" increments)
	Metric models Height: 98 - 297 mm (1 mm increments) Width: 148 - 432 mm (1 mm increments)
Media type	<i>Plain, Transparency, Rough, Vellum, Labels, Recycled, Preprinted, Bond, Cardstock, Color (Colour), Prepunched, Letterhead, Thick paper, Envelope, High Quality, Custom 1 - 8</i>

- 1 Referring to *Accessing the Machine Default Screen* on page 3-11, access the *Machine Default* screen.
- 2 Press [▲] or [▼] to select *Store Paper Size for MPT* and press [Change #].
- 3 Press [▲] or [▼] to select the number to register from *Paper size (User reg. 1 - 4)* and press [Change #].
- 4 Press [On] and press [+] or [-] to set the Y (height) and X (width).
With the metric models, you may enter the size directly using the numeric keys by pressing [#-Keys].
To specify a media type, press [Select Media Type]. Select the media type and press [Close].
- 5 Press [Close] to save settings or [Back] to cancel settings.
- 6 Press [Close]. The display returns to the *Machine Default* screen.

Enabling Quick Access to MP Tray Settings

Set whether to show the *MP tray Settings* screen when the MP tray is selected from the [Basic] screen. The setting items are as follows.

Item	Description
Off	Do not show <i>MP tray Settings</i> when MP tray is selected.
On	Show <i>MP tray Settings</i> when MP tray is selected.

- 1 Referring to *Accessing the Machine Default Screen* on page 3-11, access the *Machine Default* screen.
- 2 Press [▲] or [▼] to select *Check MP Tray sizing* and press [Change #].
- 3 Select [Off] or [On].
- 4 Press [Close] to save settings or [Back] to cancel settings. The display returns to the *Machine Default* screen.

Setting Media Type Properties (Paper Weight)

Set the weight (paper thickness) for each type of paper. The weights that can be configured for media type are as follows.

Media type to be placed in the Cassette.

Media Type	Light (thin)	Normal 1	Normal 2	Normal 3	Heavy 1	Heavy 2	Heavy 3	Extra Heavy
Plain	Y	Y	Y	Y	N	N	N	N
Preprinted	Y	Y	Y	Y	N	N	N	N
Bond	Y	Y	Y	Y	Y	Y	Y	N
Recycled	Y	Y	Y	Y	N	N	N	N
Vellum	Y	Y	Y	Y	N	N	N	N
Rough	Y	Y	Y	Y	Y	Y	Y	N
Letterhead	Y	Y	Y	Y	N	N	N	N
Color (Colour)	Y	Y	Y	Y	N	N	N	N
Prepunched	Y	Y	Y	Y	N	N	N	N
Thick paper	N	N	N	N	Y	Y	Y	Y
High Quality	Y	Y	Y	Y	N	N	N	N
Custom 1 - 8	Y	Y	Y	Y	Y	Y	Y	Y

Y: Available.

N: Not Available.

Media type to be placed in the MP tray.

Media Type	Light (thin)	Normal 1	Normal 2	Normal 3	Heavy 1	Heavy 2	Heavy 3	Extra Heavy
Plain	Y	Y	Y	Y	N	N	N	N
Transparency	N	N	N	N	Y	Y	Y	Y
Preprinted	Y	Y	Y	Y	N	N	N	N
Labels	Y	Y	Y	Y	Y	Y	Y	Y
Bond	Y	Y	Y	Y	Y	Y	Y	N
Recycled	Y	Y	Y	Y	N	N	N	N
Vellum	Y	Y	Y	Y	N	N	N	N
Rough	Y	Y	Y	Y	Y	Y	Y	N
Letterhead	Y	Y	Y	Y	N	N	N	N
Color (Colour)	Y	Y	Y	Y	N	N	N	N
Prepunched	Y	Y	Y	Y	N	N	N	N
Envelope	N	N	N	N	Y	Y	Y	Y
Cardstock	N	N	N	N	Y	Y	Y	Y
Thick paper	N	N	N	N	Y	Y	Y	Y
High Quality	Y	Y	Y	Y	N	N	N	N
Custom 1 - 8	Y	Y	Y	Y	Y	Y	Y	Y

Y: Available.

N: Not Available.

Set paper weight according to the following media types and weights (g/m²).

- *Light (Thin)*: 64 g/m² or less
- *Normal 1*: From 60 g/m² to 75 g/m² or less
- *Normal 2*: From 76 g/m² to 90 g/m² or less
- *Normal 3*: From 91 g/m² to 105 g/m² or less
- *Heavy 1*: From 106 g/m² to 135 g/m² or less
- *Heavy 2*: From 136 g/m² to 170 g/m² or less
- *Heavy 3*: 171 g/m² or more
- *Extra Heavy*: OHP transparencies

- 1 Referring to *Accessing the Machine Default Screen* on page 3-11, access the *Machine Default* screen.
- 2 Press [▲] or [▼] to select *Media Type (paper weight)* and press [Change #].
- 3 Press [▲] or [▼] to select the media type to set the weight and press [Change #].
- 4 Select the weight. Press [Close] to save settings or [Back] to cancel settings.
- 5 Press [Close]. The display returns to the *Machine Default* screen.

Setting Media Type Properties (Duplex Mode)

Specify whether to allow duplex printing for each of custom media types 1 - 8. The setting items are as follows.

Item	Description
Off	Do not use duplex mode.
On	Use duplex mode.

- 1** Referring to *Accessing the Machine Default Screen* on page 3-11, access the *Machine Default* screen.
- 2** Press [▲] or [▼] to select *Select media type (2sided)* and press [Change #].
- 3** Press [▲] or [▼] to select the media type to adjust from *Custom 1 - Custom 8* and press [Change #].
- 4** Select [Off] or [On]. Press [Close] to save settings or [Back] to cancel settings.
- 5** Press [Close]. The display returns to the *Machine Default* screen.

Setting Handling for Special Media Types

When printing on prepunched, preprinted, or letterhead paper, depending on the original placement method or combination of copier functions, the hole positions may not align or images may be printed upside-down. Use this setting to change the direction of the finished output. The setting items are as follows.

Item	Description
Adj. Print Direction	Print with aligned finish direction.
Speed Priority	Releases the [Adj. Print Direction] setting.

When [Adj. Print Direction] is enabled, load paper according to the following method.

Example: Copying on letterhead paper

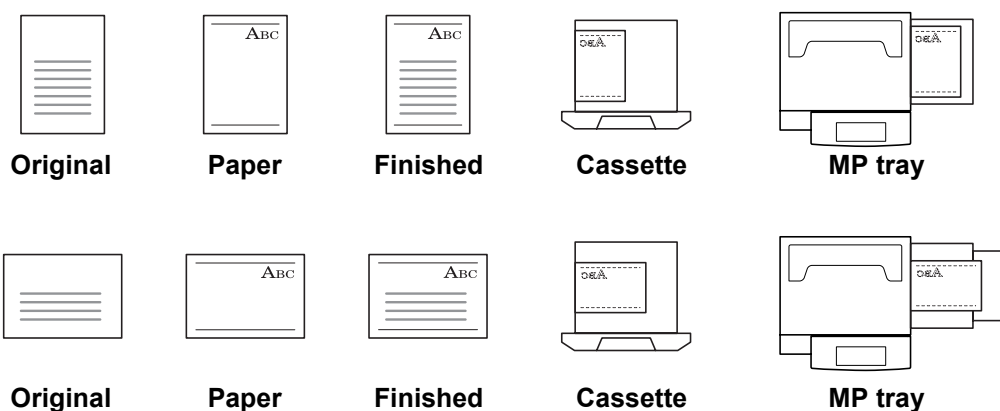

Note When loading paper into the cassette and MP tray, place the surface to be printed facing up.

When [Adj. Print Direction] is enabled, the printing speed decreases slightly.

- 1** Referring to *Accessing the Machine Default Screen* on page 3-11, access the *Machine Default* screen.
- 2** Press [▲] or [▼] to select *Special paper action mode (Specif. paper action mode)* and press [Change #].
- 3** Select [Adj. Print Direction] or [Speed Priority].
- 4** Press [Close] to save settings or [Back] to cancel settings. The display returns to the *Machine Default* screen.

Auto Detect Originals

Specify the paper size to select when an original with a similar size is automatically detected. The setting items are as follows.

Item	Description
Cardstock/A6	Select whether to detect the size as Postcard or A6R.
B4/Folio	Select whether to detect the size as B4 or Folio.
11 × 15"	Select whether to automatically detect as 11 × 15".



Note This setting is displayed only for metric models.

- 1 Referring to *Accessing the Machine Default Screen* on page 3-11, access the *Machine Default* screen.
- 2 Press [▲] or [▼] to select *Org. Auto Detect Setting* and press [Change #].
- 3 Press [▲] or [▼] to select the paper size to specify and press [Change #].
- 4 For *Cardstock/A6*, select [Cardstock] or [A6].
For *B4/Folio*, select [B4] or [Folio].
For *11 × 15"*, select [On] or [Off].
- 5 Press [Close] to save settings or [Back] to cancel settings.
- 6 Press [Close]. The display returns to the *Machine Default* screen.

Orientation of Original Document

Set the original orientation in default settings mode. The setting items are as follows.

Item	Description
Top Edge Top	Sets the top edge as the original's upper edge.
Top Edge Left	Sets the left edge as the original's upper edge.

For further details about original orientation, refer to page 1-6.

- 1 Referring to *Accessing the Machine Default Screen* on page 3-11, access the *Machine Default* screen.
- 2 Press [▲] or [▼] to select *Orig. Orient* and press [Change #].
- 3 Select [Top Edge Top] or [Top Edge Left].
- 4 Press [Close] to save settings or [Back] to cancel settings. The display returns to the *Machine Default* screen.

Setting Sleep Timer Timeout

Set the time until Auto Sleep mode is activated when [On] is selected in *Activating Auto Sleep* on page 3-21. Specify a value from 1 - 240 minutes (1 minute increments). For further details on Auto Sleep mode, refer to *Sleep Mode* in *Chapter 3 of Operation Guide*.



Note If the device is used frequently, it is recommended to set Auto Sleep mode to a larger time delay, and to a shorter time delay if the periods of non-use are longer.

- 1 Referring to *Accessing the Machine Default Screen* on page 3-11, access the *Machine Default* screen.
- 2 Press [▲] or [▼] to select *Sleep mode changing time* and press [Change #].
- 3 Press [+] or [-] to set the time until Auto Sleep mode is activated.
- 4 Press [Close] to save settings or [Back] to cancel settings. The display returns to the *Machine Default* screen.

Setting Low-Power Timer Timeout

Set the time until Auto Low-Power mode is activated. Specify a value from 1 - 240 minutes (1 minute increments). For further details on Auto Low-Power mode, refer to *Low-Power Mode* in *Chapter 3 of Operation Guide*.

- 1 Referring to *Accessing the Machine Default Screen* on page 3-11, access the *Machine Default* screen.
- 2 Press [▲] or [▼] to select *Low power mode chng. time* and press [Change #].
- 3 Press [+] or [-] to set the time until Auto Low-Power mode is activated.
- 4 Press [Close] to save settings or [Back] to cancel settings. The display returns to the *Machine Default* screen.

Setting Auto Clear Timeout Time

Set the time until Auto Clear is activated after the last operation when [On] is selected in *Activating Auto Clear* on page 3-21. Specify a value from 10 - 270 minutes (10 minute increments).

- 1 Referring to *Accessing the Machine Default Screen* on page 3-11, access the *Machine Default* screen.
- 2 Press [▲] or [▼] to select *Auto Clear Time Setting* and press [Change #].
- 3 Press [+] or [-] to set the time until Auto Clear is activated.
- 4 Press [Close] to save settings or [Back] to cancel settings. The display returns to the *Machine Default* screen.

Selecting Output Destination

Set the default copy output destination.

Paper Output	Description
Top tray	Outputs to the top tray of the machine.
Job Sep. Tray	Outputs to the optional job separator.
Finisher tray	Outputs to the optional document finisher tray or built-in finisher tray.



Note This setting is displayed when the optional job separator, document finisher or built-in finisher is installed.

- 1** Referring to *Accessing the Machine Default Screen* on page 3-11, access the *Machine Default* screen.
- 2** Press [▲] or [▼] to select *Select Copy output tray* and press [Change #].
- 3** Select the output destination.
- 4** Press [Close] to save settings or [Back] to cancel settings. The display returns to the *Machine Default* screen.

Selecting FAX Output Mode

Set the default output destination for printing originals or reports received by fax.

Paper Output	Description
Top tray	Outputs to the top tray of the machine.
Job Sep. Tray	Outputs to the optional job separator.
Finisher tray	Outputs to the optional document finisher tray or built-in finisher tray.



Note This setting is displayed when the fax kit and optional job separator, document finisher or built-in finisher is installed.

- 1** Referring to *Accessing the Machine Default Screen* on page 3-11, access the *Machine Default* screen.
- 2** Press [▲] or [▼] to select *Select FAX output tray* and press [Change #].
- 3** Select the output destination.
- 4** Press [Close] to save settings or [Back] to cancel settings. The display returns to the *Machine Default* screen.

Select the Main Mode

Specify the screen to be first shown after power-on. The setting items are as follows.

Item	Description
Copy Mode	Copy mode is set as the first screen to be shown after the power is switched on (the screen shown when the Copy key is pressed).
FAX Mode	Fax mode is set as the first screen to be shown the power is switched on (the screen shown when the FAX key is pressed).



Note This setting is displayed when the optional fax kit is installed.

- 1** Referring to *Accessing the Machine Default Screen* on page 3-11, access the *Machine Default* screen.
- 2** Press [▲] or [▼] to select *Select the main mode (Select main mode)* and press [Change #].
- 3** Select [Copy Mode] or [FAX Mode].

- 4 Press [Close] to save settings or [Back] to cancel settings. The display returns to the *Machine Default* screen.

Setting Notification Sounds

Set the notification sounds made by the machine during operation. The setting items are as follows.

Item	Description
<i>Touch tone</i> notification	The beep sound made when a key on the operation panel or touch panel is pressed.
<i>Finish</i> notification	The sound made when a copy or print operation finishes without error.
<i>Ready</i> notification	The sound made when warm-up is complete.
<i>Attention</i> notification	The sound made when an error has occurred.

Set each item to [On] to enable sound notification. Set each item to [Off] to disable sound notification.

- 1 Referring to *Accessing the Machine Default Screen* on page 3-11, access the *Machine Default* screen.
- 2 Press [▲] or [▼] to select *Notify (Touch tone)*, *Notify (Finish)*, *Notify (Ready)* or *Notify (Attention)* and press [Change #].
- 3 Select [Off] or [On].
- 4 Press [Close] to save settings or [Back] to cancel settings. The display returns to the *Machine Default* screen.

Silent Mode

Configures the machine to operate more quietly. To decrease the operating noise level, set Silent Mode to [On]. The setting items are as follows.

Item	Description
Off	Do not enable Silent Mode.
On	Enable Silent Mode and reduce the operating noise level.

- 1 Referring to *Accessing the Machine Default Screen* on page 3-11, access the *Machine Default* screen.
- 2 Press [▲] or [▼] to select *Silent Mode* and press [Change #].
- 3 Select [Off] or [On].
- 4 Press [Close] to save settings or [Back] to cancel settings. The display returns to the *Machine Default* screen.

Changing Management Code

Change the machine's management code.

IMPORTANT Be sure to record the management code when changing it. If forgotten, contact your Service Representative.



Note The default setting is 2500 for the 25 cpm model and 3000 for the 30 cpm model.

Change the management code to a value between 0000 - 9999. Always set to 4 digits.

It is recommended to not set the management code to an easily guessed number such as 1111 or 1234.

The following settings require the management code to be entered.

- Default Settings for Copying
- Machine Default
- Printing Reports
- Job Accounting

- 1** Referring to *Accessing the Machine Default Screen* on page 3-11, access the *Machine Default* screen.
- 2** Press [▲] or [▼] to select *Management code change (Change MGMT code with #)* and press [Change #].
- 3** Use the numeric keys to enter the new management code.
- 4** Press [Close] to save settings or [Back] to cancel settings. The display returns to the *Machine Default* screen.

Activating Auto Sleep

In Auto Sleep mode, the machine automatically switches to Sleep mode if left idle for a preset period. Enable/disable the use of Auto Sleep mode here. For further details on Sleep mode, refer to *Sleep Mode* in *Chapter 3 of Operation Guide*. The setting items are as follows.

Item	Description
Off	Do not use Auto Sleep mode.
On	Use Auto Sleep mode.



Note If Auto Sleep mode interferes with normal operation, set to disable Auto Sleep mode. Before disabling Auto Sleep mode, it is first recommended to try extending the time until Auto Sleep mode is activated (sleep mode change time).

- 1** Referring to *Accessing the Machine Default Screen* on page 3-11, access the *Machine Default* screen.
- 2** Press [▲] or [▼] to select *Auto sleep* and press [Change #].
- 3** Select [Off] or [On].
- 4** Press [Close] to save settings or [Back] to cancel settings. The display returns to the *Machine Default* screen.

Activating Auto Clear

Auto Clear automatically releases various specified setting and returns to default settings mode after a specified period of time since the last device operation. Enable/disable the use of Auto Clear here. The setting items are as follows.

Item	Description
Off	Do not use Auto Clear.
On	Use Auto Clear.

-
- 1 Referring to *Accessing the Machine Default Screen* on page 3-11, access the *Machine Default* screen.
 - 2 Press [▲] or [▼] to select *Auto Clear* and press [Change #].
 - 3 Select [Off] or [On].
 - 4 Press [Close] to save settings or [Back] to cancel settings. The display returns to the *Machine Default* screen.

Auto Drum Refresh

When the machine is turned on or is woken up from Low-Power mode or Sleep mode, the drum is sometimes automatically refreshed. Automatic drum refreshing is carried out to maintain printing quality and allows for the ambient temperature and humidity.

Use this setting to specify the duration of automatic drum refreshing. The setting items are as follows.

Item	Description
Off	Disables automatic drum refreshing.
Standard	Sets the standard duration for automatic drum refreshing (maximum 140 sec.).
Long	Sets a longer time for automatic drum refreshing (maximum 180 sec.).

- 1 Referring to *Accessing the Machine Default Screen* on page 3-11, access the *Machine Default* screen.
- 2 Press [▲] or [▼] to select *Auto Drum Refresh* and press [Change #].
- 3 Select [Off], [Standard] or [Long].
- 4 Press [Close] to save settings or [Back] to cancel settings. The display returns to the *Machine Default* screen.

Setting MP Tray

Set the paper size and media type to match paper loaded in the MP tray.

Specifying the Paper Size for the MP Tray

The MP tray paper size setting method and available paper sizes are as follows.

Setting method	Unit	Paper size
Auto Detect	Inch	11 × 17", 8 1/2 × 14", 11 × 8 1/2", 8 1/2 × 11", 5 1/2 × 8 1/2"
	Centimeter	A3, B4, A4, A4R, B5, B5R, A5R, B6R, A6R
Other Standard Sizes		ISO B5, Envelope DL, Envelope C5, Envelope C4, Comm. #10, Comm. #9, Comm. #6-3/4, Monarch, Executive, OUFUKU HAGAKI (return postcard), YOUKEI 2, YOUKEI 4, 8 1/2 × 13 1/2", 8 1/2 × 13" (Oficio II), 8K, 16K, 16KR
Input Size		Inch models Height: 3 7/8 - 11 5/8" (1/8" increments) Width: 5 7/8 - 17" (1/8" increments) Metric models Height: 98 - 297 mm (1 mm increments) Width: 148 - 432 mm (1 mm increments)
Custom Size		Pre-assigned paper size 1-4 Assignable paper sizes Inch models Height: 3 7/8 - 11 5/8" (1/8" increments) Width: 5 7/8 - 17" (1/8" increments) Metric models Height: 98 - 297 mm (1 mm increments) Width: 148 - 432 mm (1 mm increments)



Note For further details on MP tray size setting, refer to *Specifying the Paper Size for the MP Tray* in *Chapter 2* of *Operation Guide*.

Specifying the Media Type for the MP Tray

The following media types can be specified for the MP tray.

Plain, Transparency, Rough, Vellum, Labels, Recycled, Preprinted, Bond, Cardstock, Color (Colour), Prepunched, Letterhead, Thick paper, Envelope, High Quality, Custom 1 - 8



Note For further details about MP tray media type setting, refer to *Specifying the Media Type for the MP Tray* in *Chapter 2* of *Operation Guide*.

Registering Non-standard Sizes for Originals

Pre-register 4 types of non-standard original sizes. Registered sizes are shown as custom sizes when selecting the original size.

The size range that can be registered is as follows.

Model Type	Range
Inch models	Height: 2 - 11 5/8" (1/8" increments) Width: 2 - 17" (1/8" increments)
Metric models	Height: 50 - 297 mm (1 mm increments) Width: 50 - 432 mm (1 mm increments)

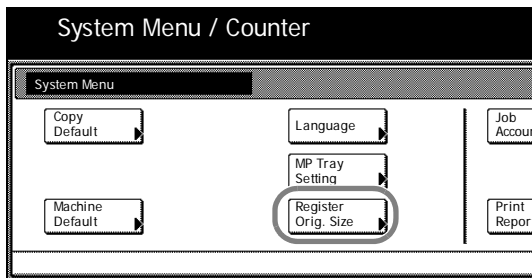

- 1 Press the **System Menu/Counter** key.
- 2 Press [Register Orig. Size].
- 3 Select the number to register from *Original Size (custom 1 - 4)* and press [Change #].
- 4 Press [On].
- 5 Press [+] or [-] to set the Y (height) and X (width) sizes.
- 6 Press [Close] to save settings or [Back] to cancel settings.
- 7 Press [Close]. The display is returned to the *System Menu* screen.

Drum Refresh

Refresh the drum when image blur or white spots appear on images in copies. There are 2 drum refresh modes.

Item	Description
Drum Refresh 1	Use this mode when images are blurred or smeared. Refreshing takes about 160 seconds.
Drum Refresh 2	Use this mode when white spots appear on images. Refreshing takes about 90 seconds.

IMPORTANT To use [Drum Refresh 2], load 11 × 17" or A3 size paper into the MP tray.

When you run [Drum Refresh 2], the machine makes a vibrating sound for about 90 seconds until drum refreshing is completed. The toner soiling on the ejected paper is normal and does not indicate a fault.

- 1 Press the **System Menu/Counter** key.
- 2 Press [User Adjustment].
- 3 Press [Drum refresh].

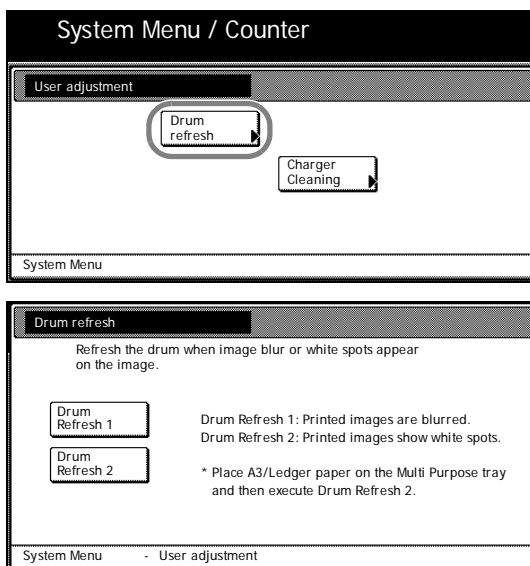

- 4 Press [Drum Refresh 1] or [Drum Refresh 2]. Drum refresh begins.
- 5 Press [Close] after drum refresh is complete. The display is returned to the *System Menu* screen.

Toner Coverage Report

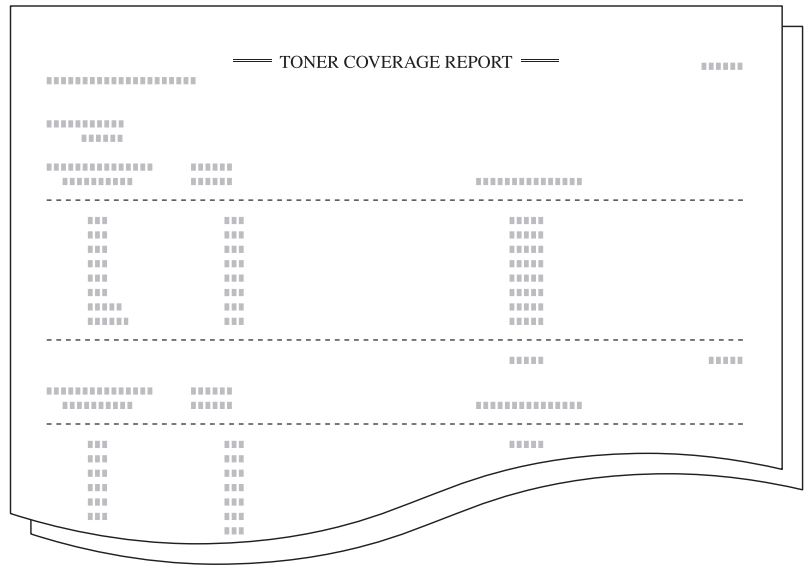

The toner coverage report indicates the number of copying volume that has been made. It also shows the black toner coverage in percentage for individual paper sizes including the following.

- Total toner coverage report
- Copy toner coverage report
- Printer toner coverage report
- Fax toner coverage report

The copying volume as calculated from information indicated on toner coverage reports will not match the guaranteed volume given on toner containers exactly. The actual copying volume supported depends on conditions of use (such as the content of copies and the frequency of single or consecutive copies), as well as environmental factors (temperature and humidity).



Note Before printing reports, verify that either 11 × 8 1/2" or A4 paper is loaded into a cassette.

- 1** Press the **System Menu/Counter** key.
- 2** Press [Print Report].
- 3** Use the numeric keys to enter the 4 digit management code. The default setting is 2500 for the 25 cpm model and 3000 for the 30 cpm model.

If the correct management code has been entered, the *Print Report Menu* is displayed.



Note For security, it is recommended to change the management code. For further details, refer to *Changing Management Code* on page 3-20.

- 4** Press the key for the report you would like to print. Report printing begins.
- 5** Press [Close]. The display is returned to the *System Menu* screen.

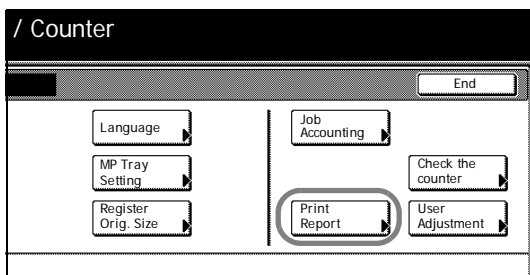

Checking Total Copy Count

Check the total copy count from the operation panel. You can check the following values.

- Number of copies, number of prints, number of faxes, and total of all of these
- Number of original pages scanned for copy mode and fax send mode, and total of all of these

You can also print this information as a counter report.

Counter Report

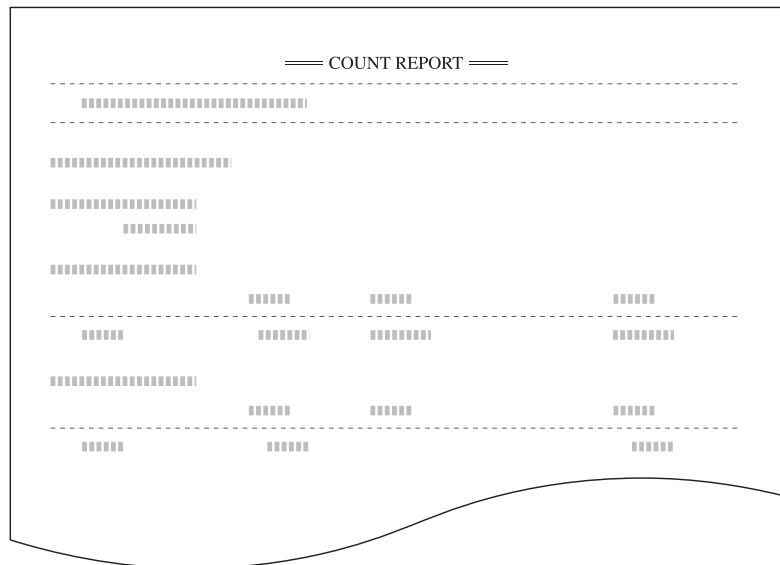

Note Before printing reports, verify that either 11 × 8 1/2" or A4 paper is loaded into a cassette.

To use the machine as a printer or fax, you must install the optional printer kit or fax kit.

- 1** Press the **System Menu/Counter** key.
- 2** Press [Check the counter].
- 3** The counts are displayed on the touch panel.

To print a counter report, press [Print Report].

To finish checking, press [Close]. The display is returned to the *System Menu* screen.

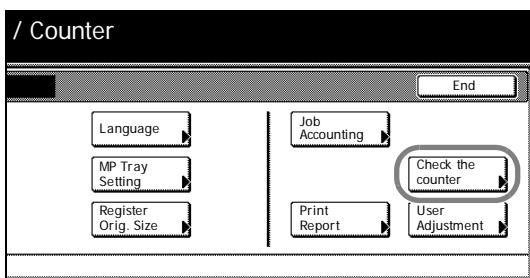

4 Job Accounting

This chapter explains how to manage job accounting to share usage among various departments.

Overview of Job Accounting	4-2
Managing Accounts	4-4
New Account	4-4
Restricting Usage	4-5
Editing Department Information	4-8
Changing Restrictions on Usage	4-9
Copy Count per Department	4-10
Total Job Accounting	4-10
Copy Count per Department.....	4-11
Activating and Deactivating Job Accounting	4-12
Job Accounting Default Settings	4-13
Using Job Accounting	4-18
Copying	4-18
Printing	4-18
Faxing.....	4-18

Overview of Job Accounting

You can manage accounting the copy count incurred by individual departments by assigning a unique ID code to each department.

Job accounting helps the following activities in business organizations.

- Integrated management of copier and optional printer functions using the same department ID code.
- Manageability of up to 500 individual departments.
- Availability for department ID codes with as many as eight digits (between 0 and 99999999) for security.
- Tracking the copy volume for each department and for all departments combined.
- Restricting the copy count per department in one-page increments up to 999,999 copies.
- Resetting the copy counter for each department or for all departments combined.
- Checking the total count for each department by entering the department ID code.

IMPORTANT To restrict the number of copies using job accounting, you must switch the *Copy Job Accounting* from [Off] to [On] as the default. If the machine is equipped with the optional printer kit, also activate *Printer Job Accounting* as the default. Refer to *Job Accounting Default Settings* on page 4-13 for details.

Job accounting includes the following functions for managing printing counts.

Setting	Description	Reference Page
Management Edit	New Account: Adds a new department. Up to 500 departments may be added. Delete Account: Deletes the registered departments. Edit Department Information: Changes the name and ID code for the department. Restricting Usage: Changes usage restrictions for each department.	page 4-4
Copy Count per Department	Total Copy Volume: For reading the total copy counts of all departments, printing job accounting reports and resetting the copy counter. Copy count by department: Takes totals for each department and clears counters.	page 4-10
Activating and Deactivating Job Accounting	Set whether to use Job Accounting.	page 4-12
Job Accounting Default Settings	Changes the defaults for Job Accounting.	page 4-13

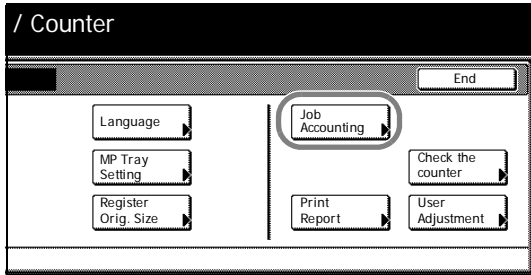

Accessing the Job Accounting Screen

Set up Job Accounting from the *Job Accounting* screen. Follow the steps below to access the *Job Accounting* screen.

- 1** Press the **System Menu/Counter** key.
- 2** Press [Job Accounting].
- 3** Use the numeric keys to enter the 4 digit management code. The default setting is 2500 for the 25 cpm model and 3000 for the 30 cpm model.

If the correct code has been entered, the *Job Accounting* screen will be displayed.



Note For security, it is recommended to change the management code. For further details, refer to *Changing Management Code* on page 3-20.

- 4** Refer to the following configuration items to configure the default settings.

Managing Accounts

You can add and delete departments and define restrictions to copy count as needed.

New Account

Adds a new department. The following settings are required.

Setting	Description
Department ID Code	Set for department ID codes up to 8 digits long (between 0 and 99999999) for security.
Name to display	Set the department name using a maximum of 32 alphanumeric characters.
Limit in use	Set usage limitation for each of the copier/printer functions. Refer to <i>Restricting Usage</i> on page 4-5 for setting procedure.

- 1 Referring to *Accessing the Job Accounting Screen* on page 4-3, access the *Job Accounting* screen.
- 2 Press [Management Edit].

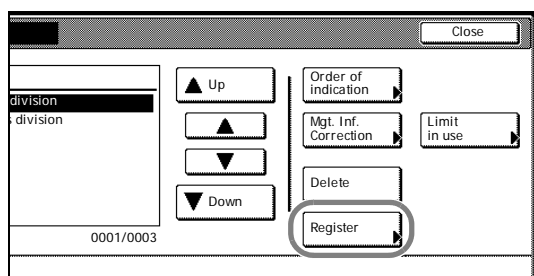
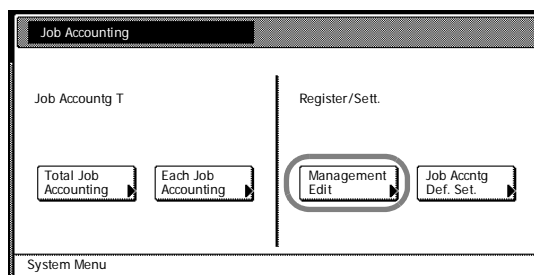

- 3 Press [Register].
- 4 Press [▲] or [▼] to select *Account ID* and press [Change #].
- 5 Use the numeric keys to enter the department ID code.
- 6 Press [Close].
- 7 Press [▲] or [▼] to select *Name to Display* and press [Change #].
- 8 Enter the department name and press [End].
Refer to the *Operation Guide* for how to enter text characters.
- 9 When all entries are complete, press [Next].

IMPORTANT An error will occur if you do not complete *Account ID* and *Name to display*, and you will not be able to proceed to the next screen. Be sure that you have completed the entries.

An error will occur if you attempt to enter an existing department ID code. You will not be able to proceed to the next screen. Use a different ID code.

- 10 Specify restrictions on copying as desired.
Refer to *Restricting Usage* for how to set usage restrictions.
- 11 Press [Registr.] to finalize settings.
To make settings on another department, press [Register] and repeat steps 4 to 11.
- 12 Press [Close]. The touch panel will return to the *Job Accounting* screen.

Restricting Usage

Set usage restrictions to restrict copier/printer functions to specific departments or set page count limitations.

For *Copy/Printer Output Management* under Job Accounting default settings, select [All] or [Split] to change the setting items for usage restriction. For further details, refer to *Copy/Printer Output Management* on page 4-15.

When [All] is set under copier/printer output management (factory default)

Manage copier and printer output count together. The items that may be configured are as follows.

- Restricting Copying (All)
- Restricting Printing (All)
- Limitation
- Restricting FAX Usage

When [Split] is set under copier/printer output management

Manage copier and printer output count individually. The items that may be configured are as follows.

- Restricting Copy Usage (Split)
- Restricting Printer Usage (Split)
- Restricting FAX Usage

Restricting Copying (All)

Specify whether to allow copying. The setting items are as follows.

Item	Description
Permitted	Allows copying.
Is not permitted (Is not permitted)	Prevents copying.



Note Turn *Copy Job Accounting* [On] in the job accounting default settings to use this function.

- 1** Refer to steps 1 to 9 of *New Account* on page 4-4 to display the usage restriction screen.
- 2** Press [▲] or [▼] to select *Copy* and press [Change #].
- 3** Select [Permitted] or [Is not permitted] ([Is not permitted]).
- 4** Press [Close] to save settings or [Back] to cancel settings. The touch panel will return to the usage restriction screen.

Restricting Printing (All)

Specify whether to allow printing. The setting items are as follows.

Item	Description
Permitted	Allows printing.
Is not permitted (Is not permitted)	Prevents printing.



Note This setting is displayed when the optional printer kit is installed.

Turn *Printer Job Accounting* [On] in the job accounting default settings to use this function.

- 1** Refer to steps 1 to 9 of *New Account* on page 4-4 to display the usage restriction screen.
- 2** Press [▲] or [▼] to select *Printer* and press [Change #].
- 3** Select [Permitted] or [Is not permitted] ([Is not permitted]).
- 4** Press [Close] to save settings or [Back] to cancel settings. The touch panel will return to the usage restriction screen.

Limitation

Sets a limit on the number of copies printed. When the optional printer kit is installed, this limit applies to the total number of pages, including both printed and copied pages. The setting items are as follows.

Item	Description
No limit	Do not limit the number of pages used by the copier and printer functions.
Counter limit	Limit the total number of pages used by the copier and printer functions to between 1-999,999 pages (1 page increments).



Note This setting is not displayed in the following situations:

- When [Is not permitted] is selected in both *Restricting Copying (All)* (refer to page 4-5) and *Restricting Printing (All)* (refer to page 4-5)
- When [Is not permitted] is selected in *Restricting Copying (All)* and the optional printer kit is not installed

- 1** Refer to steps 1 to 9 of *New Account* on page 4-4 to display the usage restriction screen.
- 2** Press [▲] or [▼] to select *Limitation (All)* and press [Change #].
- 3** Select [No limit] or [Counter limit].
When [Counter limit] is selected, use the numeric keys to enter the page limit.
- 4** Press [Close] to save settings or [Back] to cancel settings. The touch panel will return to the usage restriction screen.

Restricting FAX Usage

Set limitations for sending faxes. The setting items are as follows.

Item	Description
No limit	Do not limit the number of pages transmitted by fax
Counter limit	Limit the total number of pages sent by fax to between 1-999,999 pages (1 page increments).
Is not permitted (Is not permitted)	Prevents fax transmission.



Note This setting is displayed when the optional fax kit is installed. Turn *Fax Job Accounting* [On] in the job accounting default settings to use this function.

- 1** Refer to steps 1 to 9 of *New Account* on page 4-4 to display the usage restriction screen.
- 2** Press [▲] or [▼] to select *FAX TX* and press [Change #].
- 3** Select [No limit], [Counter limit] or [Is not permitted] ([Is not permitted]).
When [Counter limit] is selected, use the numeric keys to enter the page limit.
- 4** Press [Close] to save settings or [Back] to cancel settings. The touch panel will return to the usage restriction screen.

Restricting Copy Usage (Split)

Set the number of sheets to copy. The setting items are as follows.

Item	Description
No limit	Do not limit the number of pages copied
Counter limit	Limit the total number of pages copied to between 1-999,999 pages (1 page increments).
Is not permitted (Is not permitted)	Prevents copying.



Note Turn *Copy Job Accounting* [On] in the job accounting default settings to use this function.

- 1** Refer to steps 1 to 9 of *New Account* on page 4-4 to display the usage restriction screen.
- 2** Press [▲] or [▼] to select *Copy* and press [Change #].
- 3** Select [No limit], [Counter limit] or [Is not permitted] ([Is not permitted]).
When [Counter limit] is selected, use the numeric keys to enter the page limit.
- 4** Press [Close] to save settings or [Back] to cancel settings. The touch panel will return to the usage restriction screen.

Restricting Printer Usage (Split)

Set printer usage restrictions. The setting items are as follows.

Item	Description
No limit	Do not limit the number of pages printed.
Counter limit	Limit the total number of pages printed to between 1-999,999 pages (1 page increments).
Is not permitted (Is not permitted)	Prevents printing.



Note This setting is displayed when the optional printer kit is installed.

Turn *Printer Job Accounting* [On] in the job accounting default settings to use this function.

- 1 Refer to steps 1 to 9 of *New Account* on page 4-4 to display the usage restriction screen.
- 2 Press [▲] or [▼] to select *Printer* and press [Change #].
- 3 Select [No limit], [Counter limit] or [Is not permitted] ([Is not permitted]).
When [Counter limit] is selected, use the numeric keys to enter the page limit.
- 4 Press [Close] to save settings or [Back] to cancel settings. The touch panel will return to the usage restriction screen.

Deleting Accounts

You can delete the department accounts registered.

- 1 Referring to *Accessing the Job Accounting Screen* on page 4-3, access the *Job Accounting* screen.
- 2 Press [Management Edit].
- 3 Select the department ID code to delete and press [Delete].



Note You can change the department display order. Press [Order of indication] and select from [Sort by Code] ([1→9] and [9→1]) and [Sort by Name] ([A→Z] and [Z→A]).

- 4 Check the ID code to delete and press [Yes].



Note To delete other ID codes, repeat steps 3 and 4.

- 5 Press [Close]. The touch panel will return to the *Job Accounting* screen.

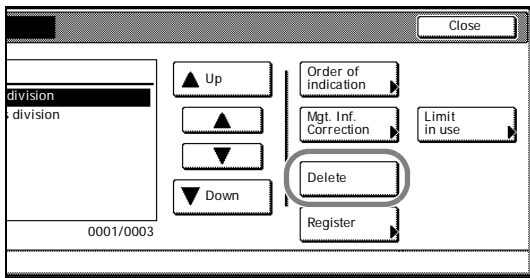

Editing Department Information

Changes the name and ID code registered for the department.

- 1 Referring to *Accessing the Job Accounting Screen* on page 4-3, access the *Job Accounting* screen.
- 2 Press [Management Edit].
- 3 Select the department ID code to modify and press [Mgt. Inf. Correction].



Note You can change the department display order. Press [Order of indication] and select from [Sort by Code] ([1→9] and [9→1]) and [Sort by Name] ([A→Z] and [Z→A]).

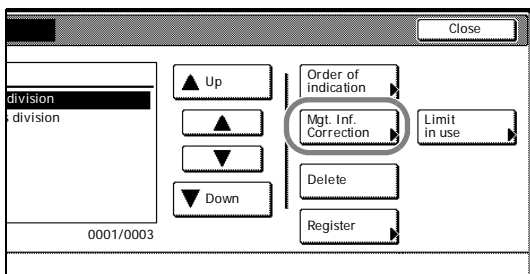

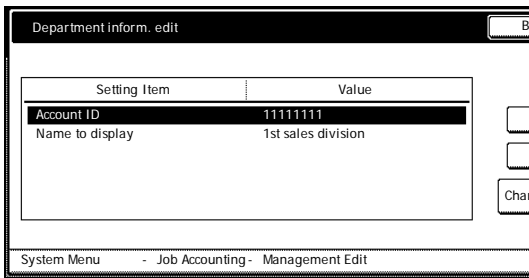

- 4 Press [▲] or [▼] to select *Account ID* and press [Change #].
- 5 Press [Clear] to blank the current entry. Use the numeric keys to enter the new ID code (up to eight digits). Press [Close].
- 6 To change the department name, press [▲] or [▼] to select *Name to display* and press [Change #].
- 7 Press [AllDel.] to clear the old department name. Enter the new department name and press [End].
Refer to the *Operation Guide* for how to enter text characters.
- 8 Press [Close].
- 9 Press [Close] to save settings or [Back] to cancel settings. The touch panel will return to the *Job Accounting* screen.

Changing Restrictions on Usage

You can change the restriction on usage per individual department.

IMPORTANT To restrict the number of copies using job accounting, you must switch the *Copy Job Accounting* from [Off] to [On] as the default. If the machine is equipped with the optional printer kit, also activate *Printer Job Accounting* as the default. Refer to *Job Accounting Default Settings* on page 4-13 for details.

- 1 Referring to *Accessing the Job Accounting Screen* on page 4-3, access the *Job Accounting* screen.
- 2 Press [Management Edit].
- 3 Select the department ID code to modify and press [Limit in use].



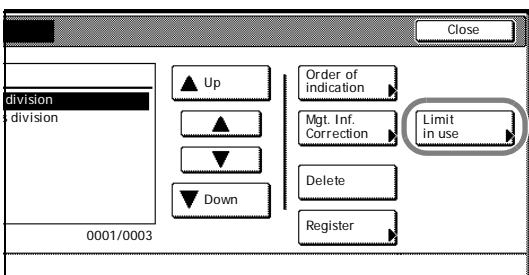

Note You can change the department display order. Press [Order of indication] and select from [Sort by Code] ([1→9] and [9→1]) and [Sort by Name] ([A→Z] and [Z→A]).

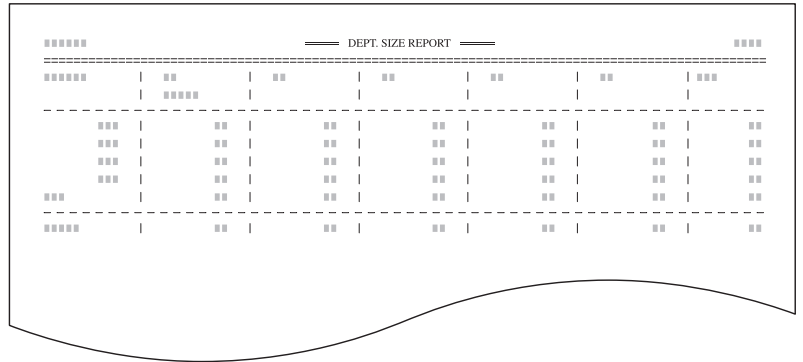

- 4 Select the usage restriction as desired. Refer to *Restricting Usage* on page 4-5 for how to set restrictions on usage.
- 5 Press [Close].
- 6 Press [Close]. The touch panel will return to the *Job Accounting* screen.

By paper size



 **Note** Change the type of form to be printed from the Job Accounting default settings in *Copy/Printer Output Management* (refer to page 4-15).

- 4** To reset the usage count, press [Counter clear].
- 5** Press [Yes].
- 6** Press [Close]. The touch panel will return to the *Job Accounting* screen.

Copy Count per Department

Tracks the copy count per individual department. The copy count per department can be reset as necessary.

- 1** Referring to *Accessing the Job Accounting Screen* on page 4-3, access the *Job Accounting* screen.
- 2** Press [Each Job Accounting].
- 3** Select the ID-code of the department and press [Total].

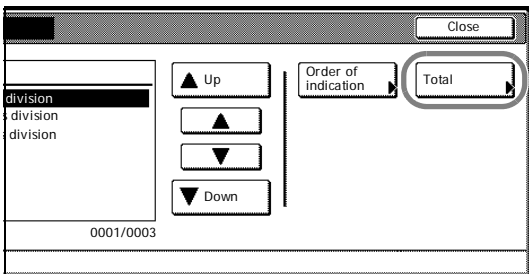

 **Note** In the list, ---ETC indicates the number of printouts delivered without entering an ID-code. The printouts include the following documents:

- Various reports
- Reports for printing errors
- Printouts from computers of which the department ID-codes are not specified (if *Printing from Unregistered Sources (Printer)* is enabled in the job accounting default settings)

You can change the department display order. Press [Order of indication] and select from [Sort by Code] ([1→9] and [9→1]) and [Sort by Name] ([A→Z] and [Z→A]).

- 4** The usage count for the selected department is displayed for your reference.

 **Note** The copy limitation per department is given in parentheses after the current volume, as in 1,234 (999,999).

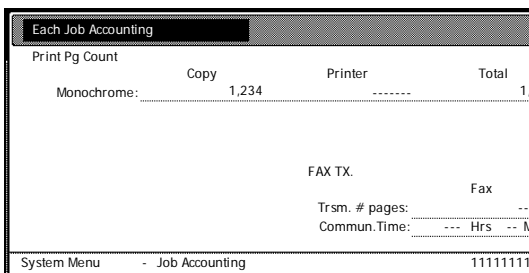

- 5** To reset the usage count, press [Counter clear].
- 6** Press [Yes].
- 7** Press [Close].
- 8** Press [Close]. The touch panel will return to the *Job Accounting* screen.

Activating and Deactivating Job Accounting

Turn job accounting on or off as necessary. The setting items are as follows.

Setting	Description
Off	Job accounting is deactivated.
On	Job accounting is activated.

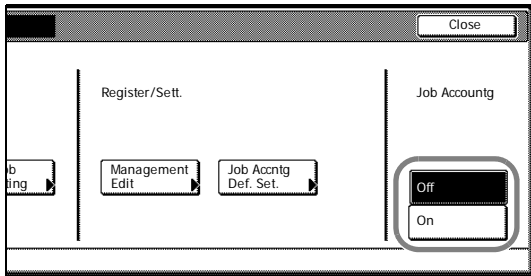

1 Referring to *Accessing the Job Accounting Screen* on page 4-3, access the *Job Accounting* screen.

2 Select [On] or [Off].

3 Press [Close].

4 Press [End].

When you select [On], the screen for the department ID-code entry is displayed.

When you select [Off], the screen [Basic] screen is displayed.

Job Accounting Default Settings

Changes the defaults for Job Accounting.

The following items can be configured for Job Accounting default settings.

- Copy Job Accounting...4-13
- Printer Job Accounting...4-13
- Printer Error Report...4-14
- Printing from Unregistered Sources (Printer)...4-14
- Copy/Printer Output Management...4-15
- Fax Job Accounting...4-15
- Response to Unauthorized Requests...4-16
- Default Counter Limit Value...4-16
- Total Count by Size, 1-5...4-16

Copy Job Accounting

Activate or deactivate Job Accounting for copy jobs. The setting items are as follows.

Setting	Description
Off	Copy Job Accounting is deactivated.
On	Copy Job Accounting is activated.

- 1 Referring to *Accessing the Job Accounting Screen* on page 4-3, access the *Job Accounting* screen.
- 2 Press [Job Acctng Def. Set.].
- 3 Press [▲] or [▼] to select *Copy Job Accounting* and press [Change #].
- 4 Select [On] or [Off].
- 5 Press [Close] to save settings or [Back] to cancel settings.
- 6 Press [Close]. The touch panel will return to the *Job Accounting* screen.

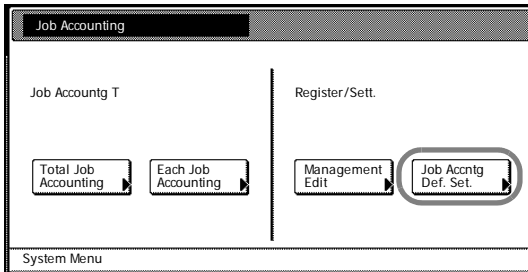

Printer Job Accounting

Activate or deactivate Job Accounting when the device is used as a printer. The setting items are as follows.

Setting	Description
Off	Printer Job Accounting is deactivated.
On	Printer Job Accounting is activated.



Note This setting is displayed when the optional printer kit is installed.

- 1 Referring to *Accessing the Job Accounting Screen* on page 4-3, access the *Job Accounting* screen.
- 2 Press [Job Acctng Def. Set.].
- 3 Press [▲] or [▼] to select *Print. Job Accounting* and press [Change #].
- 4 Select [On] or [Off].

- 5 Press [Close] to save settings or [Back] to cancel settings.
- 6 Press [Close]. The touch panel will return to the *Job Accounting* screen.

Printer Error Report

When you use Job Accounting to manage printing, you can specify whether an error report is printed in case that the user attempts to print using the incorrect department code.

When the user attempts to print using the incorrect department ID code, *Account ID mismatch* will be displayed and the job will not be printed. Press [GO] to print the error report.

The setting items are as follows.

Setting	Description
Off	Do not print error report when there is an account ID mismatch.
On	Print error report even if there is an account ID mismatch.



Note This item is displayed when *Printer Job Accounting* (refer to page 4-13) is set to [On].

- 1 Referring to *Accessing the Job Accounting Screen* on page 4-3, access the *Job Accounting* screen.
- 2 Press [Job Acctng Def. Set.].
- 3 Press [▲] or [▼] to select *Printer error report* and press [Change #].
- 4 Select [On] or [Off].
- 5 Press [Close] to save settings or [Back] to cancel settings.
- 6 Press [Close]. The touch panel will return to the *Job Accounting* screen.

Printing from Unregistered Sources (Printer)

If you use Job Accounting to manage printing, you can authorize or prohibit printing from computers with printer drivers that do not support Job Accounting. The setting items are as follows.

Setting	Description
Off	Users cannot print unless their printer driver supports Job Accounting.
On	Users can print from computers with printer drivers that do not support Job Accounting.



Note This item is displayed when *Printer Job Accounting* (refer to page 4-13) is set to [On].

- 1 Referring to *Accessing the Job Accounting Screen* on page 4-3, access the *Job Accounting* screen.
- 2 Press [Job Acctng Def. Set.].
- 3 Press [▲] or [▼] to select *Other Mgt. reg. (print)* and press [Change #].
- 4 Select [On] or [Off].

- 5 Press [Close] to save settings or [Back] to cancel settings.
- 6 Press [Close]. The touch panel will return to the *Job Accounting* screen.

Copy/Printer Output Management

You can choose whether copying and printing are managed together or separately. The setting items are as follows.

Setting	Description
All	Manage copier and printer output count together.
Split	Manage copier and printer output count individually.



Note Changing this setting affects which setting items are available in the usage restriction screen. For further details, refer to *Restricting Usage* on page 4-5.

- 1 Referring to *Accessing the Job Accounting Screen* on page 4-3, access the *Job Accounting* screen.
- 2 Press [Job Acctng Def. Set.].
- 3 Press [▲] or [▼] to select *Copy/Printer output mgt* and press [Change #].
- 4 Select [All] or [Split].
- 5 Press [Close] to save settings or [Back] to cancel settings.
- 6 Press [Close]. The touch panel will return to the *Job Accounting* screen.

Fax Job Accounting

Activate or deactivate job accounting when the optional fax function is used. The setting items are as follows.

Setting	Description
Off	Fax Job Accounting is deactivated.
On	Fax Job Accounting is activated.



Note This setting is displayed when the optional fax kit is installed.

- 1 Referring to *Accessing the Job Accounting Screen* on page 4-3, access the *Job Accounting* screen.
- 2 Press [Job Acctng Def. Set.].
- 3 Press [▲] or [▼] to select *Fax Job Accounting* and press [Change #].
- 4 Select [On] or [Off].
- 5 Press [Close] to save settings or [Back] to cancel settings.
- 6 Press [Close]. The touch panel will return to the *Job Accounting* screen.

Response to Unauthorized Requests

Specify the actions when users attempt to copy in excess of the specified copy limitation. The setting items are as follows.

Setting	Restriction
Stop job immediately	Restricts usage and stops output immediately once the maximum usage has been exceeded.
Sub-sequently	Continues output or scanning of the current job and restricts usage from the next job.
Alert Only	Only a warning message is displayed.

- 1 Referring to *Accessing the Job Accounting Screen* on page 4-3, access the *Job Accounting* screen.
- 2 Press [Job Acctng Def. Set.].
- 3 Press [▲] or [▼] to select *Apply Limit* and press [Change #].
- 4 Press [Stop job immediately], [Sub-sequently] or [Alert Only].
- 5 Press [Close] to save settings or [Back] to cancel settings.
- 6 Press [Close]. The touch panel will return to the *Job Accounting* screen.

Default Counter Limit Value

Specify the default of usage limitation when registering a new department. Specify between 1-999,999 sheets in 1 sheet increments.

- 1 Referring to *Accessing the Job Accounting Screen* on page 4-3, access the *Job Accounting* screen.
- 2 Press [Job Acctng Def. Set.].
- 3 Press [▲] or [▼] to select *Def. Val. of coun. Limit* and press [Change #].
- 4 Use the numeric keys to enter the counter limit default value.
- 5 Press [Close] to save settings or [Back] to cancel settings.
- 6 Press [Close]. The touch panel will return to the *Job Accounting* screen.

Total Count by Size, 1-5

You can register specific paper sizes to monitor so that you can check the copy count. You can also register types of paper.



Note Up to five different paper sizes can be registered for keeping track of the copy count.

If you do not specify the media type, the registered paper size will be counted regardless of the type. However, if you register a size without specifying the type as the first entry and register the same size with a type as the second entry, the usage count for the first entry will not include the count of the second entry.

- 1 Referring to *Accessing the Job Accounting Screen* on page 4-3, access the *Job Accounting* screen.
- 2 Press [Job Acctng Def. Set.].
- 3 Press [▲] or [▼] to select the number to configure from *Total size 1-5* and press [Change #].

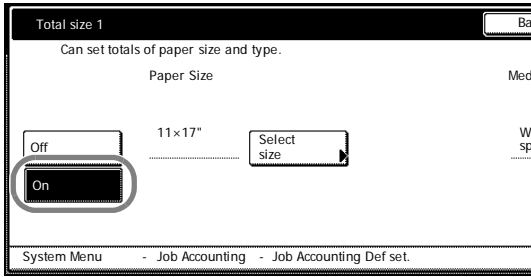

- 4 Press [On].
- 5 Press [Select Size].
- 6 Select a paper size and press [Close].
- 7 To specify a media type, press [Select Media Type].
- 8 Select the media type and press [Close].
- 9 Press [Close] to save settings or [Back] to cancel settings.
- 10 Press [Close]. The touch panel will return to the *Job Accounting* screen.



Note You can include the registered copy count of the paper when printing reports on copy count per department. For further details, refer to *Total Job Accounting* on page 4-10.

Using Job Accounting

Copying

When Job Accounting is activated, users must enter their department ID-code on the numeric keys to perform copying.

IMPORTANT After copying, be sure to press the **Logout** key to display the initial screen so that the next user is prompted to enter the department ID-code.

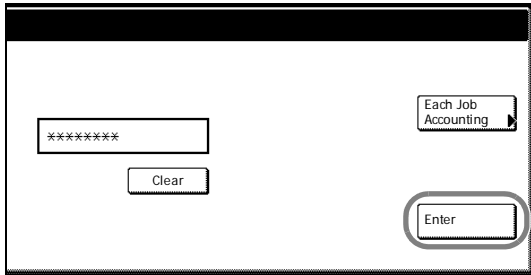

- 1 Use the numeric keys to enter the department ID code and press [Enter]. [Basic] screen is displayed.



Note If you enter the code incorrectly, press [Clear] to reenter the correct code.

Entering an invalid department ID-code will trigger an error alarm. Use the numeric keys to enter the correct code.

You can review the department's copy count by pressing [Each Mgt. Total] after entering your department ID-code.

- 2 Complete the copy job as usual.
- 3 After finishing copying, Press the **Logout** key. The screen for the department ID-code entry is displayed.

Printing

When Job Accounting is activated, users must enter the department ID code from the computer to print using the device. For further details, refer to the *Kyocera Extended Driver User Guide*.



Note Requires the optional printer kit.

Faxing

When Job Accounting is activated, users must enter their department ID-code on the numeric keys to use the fax functions. For further details, refer to the *Fax Kit Operation Guide*.



Note Requires the optional fax kit.

5 Troubleshooting

This chapter explains how to solve problems when they occur.

Solving Malfunctions	5-2
Responding to Error Messages	5-4

Solving Malfunctions

The table below provides general guidelines for problem solving.

If a problem occurs with your machine, check the checkpoints and perform procedures indicated on the following pages. If the problem persists, contact your Service Representative.

Symptom	Checkpoints	Corrective Actions	Reference Page
The operation panel does not respond when the machine is switched on (position).	Is the machine plugged in?	Plug the power cord into an AC outlet.	—
Pressing the Start key does not produce copies.	Is a message displayed on the touch panel?	Determine the appropriate response to the message and take action accordingly.	page 5-4
The original size is not detected properly.	Are the originals loaded correctly?	When placing originals on the platen, place them face-down and align them with the original size indicator plates.	Refer to <i>Operation Guide, Chapter 2</i>
		Place originals face-up in the optional document processor.	Refer to <i>Operation Guide, Chapter 2</i>
	Is the machine installed beneath fluorescent lights?	Do not install this machine beneath fluorescent lights.	—
Blank sheets are output.	Are the originals loaded correctly?	When placing originals on the platen, place them face-down and align them with the original size indicator plates.	Refer to <i>Operation Guide, Chapter 2</i>
		Place originals face-up in the optional document processor.	Refer to <i>Operation Guide, Chapter 2</i>
	Is the machine installed beneath fluorescent lights?	Do not install this machine beneath fluorescent lights.	—
Copies are too light.	Is Auto Density set?	Set the correct density for auto density.	page 3-7
	Is Manual Density set?	Use the density adjustment key to set the correct density.	Refer to <i>Operation Guide, Chapter 3</i>
		When changing the default density, adjust the density manually and choose the desired level.	page 3-7
	Is the toner distributed evenly within the toner container?	Shake the toner container up and down approximately 10 times.	Refer to <i>Operation Guide, Chapter 5</i>
	Is EcoPrint is enabled?	Set EcoPrint to [Off].	page 1-28
	Is there a message indicating the addition of toner?	Replace the toner container.	Refer to <i>Operation Guide, Chapter 5</i>
	Is the paper damp?	Replace the paper with new paper.	Refer to <i>Operation Guide, Chapter 2</i>
Copies are too dark.	Is Auto Density set?	Set the correct density for auto density.	page 3-7
	Is Manual Density set?	Use the density adjustment key to set the correct density.	Refer to <i>Operation Guide, Chapter 3</i>
		When changing the default density, adjust the density manually and choose the desired level.	page 3-7
Copies have a moire pattern (dots grouped together in patterns and not aligned uniformly).	Is the original a printed photograph?	Set the original image to [Photo].	Refer to <i>Operation Guide, Chapter 3</i>

Symptom	Checkpoints	Corrective Actions	Reference Page
Copies are not clear.	Did you choose appropriate image quality for the original?	Select an appropriate original image mode.	Refer to <i>Operation Guide, Chapter 3</i>
	Is the paper damp?	Replace the paper with new paper.	Refer to <i>Operation Guide, Chapter 2</i>
Copies are dirty.	Are the original cover or platen dirty?	Clean the original cover or platen glass.	Refer to <i>Operation Guide, Chapter 5</i>
Copies are fuzzy.	Is the machine in a high humidity environment?	Perform a drum refresh.	page 3-25
	Is the paper damp?	Replace the paper with new paper.	Refer to <i>Operation Guide, Chapter 2</i>
Copies are skewed.	Are the originals loaded correctly?	When placing originals on the platen, place them face-down and flush against the original size indicator plates.	Refer to <i>Operation Guide, Chapter 2</i>
		When placing originals in the document processor, align the original width guides securely before placing the originals.	Refer to <i>Operation Guide, Chapter 2</i>
	Is the paper loaded correctly?	Check the position of the paper width guides.	Refer to <i>Operation Guide, Chapter 2</i>
Paper jams frequently occur.	Is the paper loaded correctly?	Load the paper correctly.	Refer to <i>Operation Guide, Chapter 2</i>
	Is the paper of the supported type? Is it in good condition?	Remove the paper from the cassette, turn it over, and reload it.	Refer to <i>Operation Guide, Chapter 2</i>
	Is the paper curled, folded, or wrinkled?	Replace the paper with new paper.	Refer to <i>Operation Guide, Chapter 2</i>
	Are any loose scraps of paper or is there any jammed paper inside the device?	Remove any jammed paper.	Refer to <i>Operation Guide, Chapter 6</i>
	Is the paper damp?	Replace the paper with new paper.	Refer to <i>Operation Guide, Chapter 2</i>
Copies from the optional document processor have black lines.	Is the slit glass dirty?	Clean the slit glass.	Refer to <i>Operation Guide, Chapter 5</i>
	—	Follow the procedure for correcting black lines. This may remove the black lines.	page 3-4
Copies are wrinkled.	Is the separator dirty?	Clean the separator.	Refer to <i>Operation Guide, Chapter 5</i>
	Is the paper damp?	Replace the paper with new paper.	Refer to <i>Operation Guide, Chapter 2</i>
	Is the paper set in a proper orientation?	Change the orientation in which the paper is positioned.	—

Responding to Error Messages

If the touch panel displays any of these messages, follow the corresponding procedure.

Display	Checkpoints	Corrective Actions	Reference Page
Close ### cover.	Is the indicated cover open?	Close all covers securely.	—
Check the cover.	Are any covers open? Does the message indicate which cover is open?	Close all covers securely.	—
Close Document Processor.	Is the optional document processor open while loading the original?	Close the document processor.	—
Close Document processor cover.	Is the optional document processor top cover open?	Close the document processor top cover.	Refer to <i>Operation Guide, Chapter 2</i>
Set cassette #. (Close paper cassette #.)	Is the indicated cassette not fully closed?	Pull out the cassette and push in securely.	—
Open cassette #, check and remove paper from inside of the machine. (Open cassette #, check and remove paper from inside of machine.)	—	Completely pull out the indicated cassette and remove any paper inside.	—
Reset feeding unit for paper cassette.	Is the paper feed unit securely pushed into the machine?	Pull out the paper feed unit and securely push it all the way into the machine.	Refer to <i>Operation Guide, Chapter 6</i>
Add paper in cassette #. (Add paper cassette #.)	Is the indicated cassette out of paper?	Load paper. If the same type of paper is loaded in another cassette in the same orientation, you can press either one of paper selection keys on the left of the touch panel to switch to that cassette for copying.	—
Add paper in the Multi Purpose Tray. ### size (Place paper on the Multi Purpose Tray. ### size)	Is paper of the specified size loaded in the MP tray?	Load paper of the size indicated in the MP tray.	Refer to <i>Operation Guide, Chapter 2</i>
Add paper in the Multi Purpose Tray. (Add paper on the Multi Purpose Tray.)	Has all the paper on the MP tray been fed?	Load paper in the MP tray.	Refer to <i>Operation Guide, Chapter 2</i>
Change the size of MP tray.	Is the specified size paper loaded in the MP tray?	Reconfigure the size of the MP tray.	Refer to <i>Operation Guide, Chapter 2</i>
Check paper size.	Is the specified size paper loaded?	Load paper of a size that can be used.	—
Reposition original.	Is the orientation of the specified paper different from that of the original?	Change the orientation of the original. If you press the Start key without doing so, the original will be copied at the current size.	—

Display	Checkpoints	Corrective Actions	Reference Page
Check paper size. Copy paper is not the same size as original. (Paper size in cassette differs from actual size. Check paper size in cassette.)	Is the specified paper loaded? Or are the settings incorrect?	Load the specified paper. Adjust any settings that are incorrect.	—
Reposition original or change cassette. (Reset original or select another paper cassette.)	Is the orientation of the specified paper different from that of the original?	Change the orientation of the original.	—
	Is the machine installed beneath fluorescent lights?	Do not install this machine beneath fluorescent lights.	—
Reset originals in processor.	—	Remove originals from the optional document processor, stack them uniformly and reset them.	Refer to <i>Operation Guide, Chapter 2</i>
Reset all originals in processor. (Reset originals in processor.)	—	Remove originals from the optional document processor, and reset them in the original order.	Refer to <i>Operation Guide, Chapter 2</i>
Reset all originals in Document Processor. (Reset originals in Document Processor.)	Are there any originals left in the optional document processor?	Remove all originals in the optional document processor.	—
Cannot copy this paper type.	Can the specified copy functions be used with the selected media type?	Select another type of media.	—
Cannot staple this paper type.	Did you select a media type that cannot be stapled?	Select another type of media.	Refer to the optional Document Finisher <i>Operation Guide</i> .
Cannot offset this paper size.	Is a paper size not supported by Offset mode (11 × 17", 8 1/2 × 14", 5 1/2 × 8 1/2", A3, B4, A5R, B6R, Folio, 8K) loaded?	Change the paper size.	page 1-9
Cannot staple this size. (Cannot staple this paper size.)	Is stapling available for the size of the loaded paper?	Change the paper size.	Refer to <i>Operation Guide, Chapter 7</i>
			Refer to the optional Document Finisher <i>Operation Guide</i> .
Cannot staple. ## :maximum capacity (Staple) (Cannot staple. ## :Max. staples)	Is the maximum page quantity for stapling exceeded?	Decrease the number of sheets to be stapled to less than the maximum staple sheet count.	Refer to <i>Operation Guide, Chapter 7</i> Refer to the optional Document Finisher <i>Operation Guide</i> .
The top tray is full of paper. Remove paper, and press Start key.	During copying, is the maximum capacity of the top tray exceeded?	Remove some pages from the top tray and press the Start key. Printing continues.	—
The top tray is full of paper. Remove paper, and press Continue key.	During printing, is the maximum capacity of the top tray exceeded?	Remove some pages from the top tray and press [Continue]. Printing continues.	—

Display	Checkpoints	Corrective Actions	Reference Page
<i>Paper capacity exceeded. (Finisher) Remove paper, and press Start key.</i>	During copying, is the maximum capacity of the optional document finisher output tray exceeded?	Remove some pages from the optional document finisher and press the Start key. Printing continues.	—
<i>Paper capacity exceeded. (Finisher) Remove paper, and press Continue key.</i>	During printing, is the maximum capacity of the optional document finisher output tray exceeded?	Remove some pages from the optional document finisher and press [Continue]. Printing continues.	—
<i>Remove paper. Finisher tray.</i>	Is the maximum capacity of the optional document finisher output tray exceeded?	Remove some pages from the optional document finisher.	—
<i>These functions cannot be combined.</i>	Have you selected functions that cannot be used together?	Check the settings.	—
<i>Exceeds pre registered copying quantity. (Copy limit for this ID-code has been reached. No copying possible.)</i>	Is the maximum limit for copying as specified in Job Accounting mode exceeded?	The copy volume has been reached the set limit of your department. No additional copying is possible. Clear the copy count in Job Accounting.	<i>page 4-11</i>
<i>Insert key counter.</i>	Is the optional key counter inserted correctly?	Insert the optional key counter securely and completely.	—
<i>Memory full.</i>	—	The current copy cannot be processed because there is no more copy memory free space, or the number of original pages exceeded the maximum 999 pages. When the following message is displayed select the resolution method. [Cancel]: Cancels copying. [Continue]: Copies up to the last scanned page.	—
<i>Toner will be empty soon.</i>	—	The toner container will need to be replaced soon. Prepare the replacement toner container.	Refer to <i>Operation Guide, Chapter 5</i>
<i>Ready to copy. Add toner.</i>	—	Remaining toner is low, so only one page may be printed at a time. Prepare the replacement toner container.	Refer to <i>Operation Guide, Chapter 5</i>
<i>Add toner.</i>	—	Replace the toner container.	Refer to <i>Operation Guide, Chapter 5</i>
<i>Set the toner container.</i>	Is the toner container securely installed?	Open the front cover and pull the toner container out. Shake the container well and set back in place.	Refer to <i>Operation Guide, Chapter 5</i>
<i>Clean the main charger.</i>	Have you cleaned the main charger?	Clean the main charger after replacing the toner container. After cleaning, press [End]. Adjustment begins. Wait 5 minutes.	Refer to <i>Operation Guide, Chapter 5</i>
<i>Image cycle. (Now adding toner.)</i>	—	Toner replenishment is in progress. Wait until the process is completed.	—
<i>Please wait. Now in the fusing temperature adjustment process</i>	—	Performing internal maintenance. Wait until the process is completed.	—

Display	Checkpoints	Corrective Actions	Reference Page
<i>Check waste toner box.</i>	Is the waste toner box securely fastened?	Securely fasten the waste toner box.	Refer to <i>Operation Guide, Chapter 5</i>
<i>Replace the waste toner box.</i>	—	Replace the waste toner box.	Refer to <i>Operation Guide, Chapter 5</i>
<i>Clean the slit glass for original fed from DP. (Clean the slit glass for original fed.)</i>	—	Rub the slit glass with the included dry cleaning cloth.	Refer to <i>Operation Guide, Chapter 5</i>
<i>Install duplex unit.</i>	Is the duplex unit securely installed?	Open left cover 1 and install the duplex unit in place securely.	—
<i>Out of staples. Add staples. (Stapler empty. Add staples.)</i>	Is the optional document finisher or built-in finisher out of staples?	Refill staples.	Refer to <i>Operation Guide, Chapter 4</i> Refer to the optional Document Finisher <i>Operation Guide</i> .
<i>Time for maintenance.</i>	—	Periodic maintenance is required to maintain the equipment in good condition. Contact your Service Representative or Authorized Service Center promptly.	—
<i>Paper misfeed.</i>	—	If a paper jam occurs, the location of the jam will be indicated on the touch panel and the machine will stop. Leaving the main power switched on (I position) follow the instructions to remove the jammed paper.	Refer to <i>Operation Guide, Chapter 6</i>
<i>Remove paper from inner tray of Finisher.</i>	Is there any paper left in the optional document finisher?	Remove all paper left in the optional document finisher.	—
<i>Staple jam.</i>	Is the optional document finisher or built-in finisher experiencing a staple jam?	Remove the jammed staple.	Refer to <i>Operation Guide, Chapter 4</i> Refer to the optional Document Finisher <i>Operation Guide</i> .
<i>System error. Call service.</i>	Is it re-displayed after opening and closing the front cover, turning off and on the main power switch, and plugging out and plugging in the power plug in the power outlet?	Make a note of this message (C followed by a number). Switch off the power (⏻ position), unplug the power cord, and contact your Service Representative or Authorized Service Center.	—
<i>Paper cassette is out of order. Select another paper cassette. (Paper cassette is out of order. Select other paper cassette.)</i>	—	The cassette in use has a problem and is temporarily unavailable. Contact your Service Representative or Authorized Service Center promptly. To continue copying, use another cassette.	—
<i>System error. Main Power Switch Off / On.</i>	—	A system error has occurred. Turn the main power switch off and on again.	—

Display	Checkpoints	Corrective Actions	Reference Page
<i>Please wait. Remote edit. (Please wait. Remote editing.)</i>	Is Job account editing being done from a network connected computer?	Copying is not possible until editing is complete.	—

6 Appendix

This chapter covers the following topics.

Paper	6-2
Basic Paper Specifications	6-2
Choosing the Appropriate Paper	6-3
Special Paper	6-6
Intercompatibility of Functions	6-10
Glossary	6-15

Paper

Basic Paper Specifications

This machine is designed to print on standard copy paper as used in regular ('dry') copiers and page printers such as laser printers. It also supports a variety of other types of paper that conform to the specifications given in this appendix.

Be careful when choosing paper. Paper unsuitable for the machine may cause jams or may be wrinkled.

For transparencies, labels, envelopes, and similar types of paper, use the MP tray.



Note Some recycled paper does not meet requirements for use with this machine as listed in the Basic Paper Specifications shown below, such as moisture or pulp content. For this reason, we recommend purchasing a small amount of recycled paper as a sample for testing prior to use. Choose recycled paper that gives the best copying results and contains low levels of paper dust.

We are not responsible for problems that occur from the use of paper that does not conform to our specifications.

Supported Paper

Use standard copy paper for regular copiers or laser printers. The copy quality will be affected by the quality of paper. Poor quality paper may result in unsatisfactory output.

Basic Paper Specifications

The following table lists the specifications of paper that is supported with this machine. Refer to the subsequent sections for further details.

Criteria	Specifications
Weight	Cassettes: 60 to 120 g/m ² MP tray: 45 to 200 g/m ²
Thickness	0.086 to 0.110 mm
Dimensional accuracy	±0.7 mm
Squareness of corners	90° ±0.2°
Moisture content	4 to 6 %
Grain direction	Long grain (paper supply direction)
Pulp content	80 % or more

Choosing the Appropriate Paper

This section describes guidelines for choosing paper.

Condition

Avoid using paper with bent corners or that is curled, dirty, or torn. Do not use paper that has a rough surface or paper fiber lint, or that is especially delicate. Use of paper in any of these conditions will not only deliver poor copies but may also cause jams and shorten the useful life of the machine. Choose paper with a smooth and even surface; however, avoid coated paper or paper with a treated surface as it may damage the drum or fusing unit.

Ingredient

Do not use paper such as paper that has been coated or surface-treated or paper that contains plastic or carbon. These types of paper may produce harmful fumes from the heat of copying and may damage the drum.

Be sure to use plain paper that contains at least 80 % pulp, i.e., not more than 20 % of the total paper content consists of cotton or other fibers.

Supported Paper Sizes

Paper of the following sizes is supported by the cassettes and MP tray.

Measurements in the table take into account a ± 0.7 -mm dimensional accuracy for length and width. Corner angles must be $90^\circ \pm 0.2^\circ$.

MP Tray	Cassette or MP Tray
B6R (128 × 182 mm)	A3 (297 × 420 mm)
Postcard (100 × 148 mm)	B4 (257 × 364 mm)
Return postcard (148 × 200 mm)	A4 (297 × 210 mm)
Executive (7 1/4 × 10 1/2")	A4R (210 × 297 mm)
Envelope DL (110 × 220 mm)	B5 (257 × 182 mm)
Envelope C5 (162 × 229 mm)	B5R (182 × 257 mm)
Envelope C4 (229 × 324 mm)	A5R (148 × 210 mm)
ISO B5 (176 × 250 mm)	Folio (210 × 330 mm)
Comm. #10 (4 1/8 × 9 1/2")	11 × 17"
Comm. #9 (3 7/8 × 8 7/8")	8 1/2 × 14"
Comm. #6-3/4 (3 5/8 × 6 1/2")	11 × 8 1/2"
Monarch (3 7/8 × 7 1/2")	8 1/2 × 11"
YOUKEI 2 (114 × 162 mm)	5 1/2 × 8 1/2"
YOUKEI 4 (105 × 235 mm)	8 1/2 × 13" (Oficio II)
Input size (3 7/8 × 5 7/8" to 11 5/8 × 17") (98 × 148 to 297 × 432 mm)	8 1/2 × 13 1/2"
	8K (273 × 394 mm)
	16K (273 × 197 mm)
	16KR (197 × 273 mm)

Smoothness

The paper surface should be smooth, but it must be uncoated. With paper that is too smooth and slippery, several sheets may accidentally be supplied at once, causing jams.

Basis Weight

In countries that use the metric system, basis weight is the weight in grams of one sheet of paper one square meter in area. In the United States, basis weight is the weight in pounds of one ream (500 sheets) of paper cut to the standard size (or trade size) for a specific grade of paper. Paper that is too heavy or too light may be supplied incorrectly or cause paper jams, which may cause excessive wear to the machine. Mixed paper weight (i.e., thickness) may cause several sheets to be supplied at once accidentally and may also cause blurring or other copying problems if the toner fails to adhere correctly.

The recommended basis weight is between 60 and 120 g/m² (16 and 31.5 lb/ream) for the cassettes and between 45 and 200 g/m² (12 and 53 lb/ream) for the MP tray.

Thickness

Avoid using paper that is too thick or thin. Signs that paper may be too thin include frequent problems with paper jams or with several sheets being supplied at once. Paper jams may also indicate that the paper is too thick. The proper thickness is between 0.086 and 0.110 mm.

Moisture Content

Paper moisture content is the ratio of moisture to dryness expressed as a percentage. Moisture affects how the paper is supplied, the electrostatic chargeability of the paper, and how the toner adheres.

Paper moisture content varies depending on the relative humidity in the room. High relative humidity causes paper to become damp, making the edges expand so it appears wavy. Low relative humidity causes paper to lose moisture, making the edges tighten and weakening copy contrast.

Wavy or tight edges may cause the paper to slip when it is supplied. Try to keep the moisture content between 4 to 6 %.

To maintain the right level of moisture content, bear in mind the following considerations.

- Store paper in a cool, well-ventilated place.
- Store paper flat and unopened in the package. Once the package is opened, reseal it if the paper is not to be used for a while.
- Store paper sealed in the original package and box. Put a pallet under the carton to keep it raised above the floor. Especially during rainy seasons keep the paper a sufficient distance away from wooden or concrete floors.
- Before using paper that has been stored, keep it at the proper moisture level for at least 48 hours.
- Do not store paper where it is exposed to heat, sunlight, or dampness.

Paper Grain

Paper is cut into sheets either with the grain running parallel to the length (long grain) or with the grain parallel to the width (short grain). Avoid using short-grain paper because it may be supplied incorrectly; use long-grain paper.

Other Paper Specifications

Porosity: The density of the paper fibers.

Stiffness: Paper must be stiff enough or it may buckle in the machine, causing jams.

Curl: Most paper naturally tends to curl in one direction after the package is opened. When paper passes through the fixing unit, it curls upward slightly. To deliver flat printouts, load the paper so that the curl faces towards the bottom of the paper tray.

Static electricity: During copying, paper is electrostatically charged so that the toner adheres. Choose paper that can be discharged quickly so that copies do not cling together.

Whiteness: Paper whiteness affects copy contrast. Use whiter paper for sharper, brighter copies.

Quality: Machine problems may occur if sheet sizes are not uniform or if corners are not square, edges are rough, sheets are uncut, or edges or corners are crushed. In order to prevent these problems, be especially careful when you cut the paper yourself.

Packaging: Choose paper that is properly packaged and stacked in boxes. Ideally, the packaging itself should have been treated with a coating to inhibit moisture.

Specially treated paper: We do not recommend copying onto the following types of paper, even if it conforms to the basic specifications. When you use these kinds of paper, purchase a small amount first as a sample to test.

- Glossy paper
- Watermarked paper
- Paper with an uneven surface
- Perforated paper

Special Paper

This section describes copying onto special paper and copy media.

The following paper and media can be used.

- Transparencies
- Preprinted paper
- Bond paper
- Recycled paper
- Thin paper (from 45 g/m² to 64 g/m² or less)
- Letterhead
- Colored paper
- Prepunched paper
- Envelopes
- Postcards
- Thick paper (from 106 g/m² to 200 g/m² or less)
- Label paper
- Rough paper
- High-quality paper

When using these paper and media, choose that are designed specifically for copiers or page printers (such as laser printers). Use the MP tray for transparencies, thin paper, envelopes, and postcards.

Choosing Special Paper

Although special paper that meets the following requirements can be used with the machine, copy quality will vary considerably due to differences in the construction and quality of special paper. Thus, special paper is more likely than regular paper to cause copying problems. Before purchasing special paper in volume, try testing a sample to ensure the copy quality is satisfactory. General precautions when copying onto special paper are given below. Note that we are not responsible for any harm to the user or damage to the machine caused by moisture or specifications of special paper.

When using special paper, set the media type to use the cassette or MP tray. (Refer to *Setting Media Type and Paper Size for the Cassettes and MP Tray* in *Chapter 2 of Operation Guide*.)

Transparencies

Transparencies must be able to withstand the heat of copying.

Transparencies must meet the following conditions.

Item	Specifications
Heat resistance	Must withstand at least 190 °C.
Thickness	0.100 to 0.110 mm
Material	Polyester
Dimensional accuracy	±0.7 mm
Squareness of corners	90° ±0.2°

To avoid problems, use the MP tray for transparencies and load transparencies with the long side facing the machine.

If transparencies jam frequently, try pulling the leading edge of sheets gently as they are ejected.

Label

Be sure to feed labels from the MP tray.

For selecting labels, use extreme care so that the adhesive may not come in direct contact with any part of the machine and that the labels are not easily peeled from the carrier sheet. Adhesives that stick to the drum or rollers and peeled labels remaining in the machine may cause a failure.

When printing onto labels, you must be liable for the print quality and possible trouble.

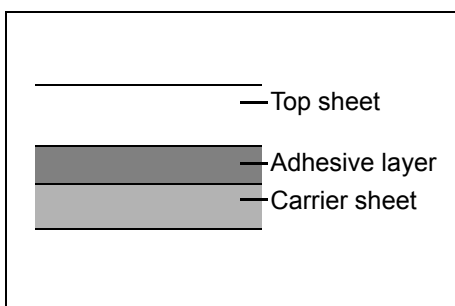

Labels consist of three layers as shown in the illustration. The adhesive layer contains materials that are easily affected by the force applied in the machine. The carrier sheet bears the top sheet until the label is used. This composition of labels may cause more problems.

The label surface must be covered completely with the top sheet. Gaps between labels may cause peeling of labels, resulting in a serious failure.

Some label paper has large margins on the top sheet. When using such paper, do not peel these margins from the carrier sheet before completing output.

Allowed

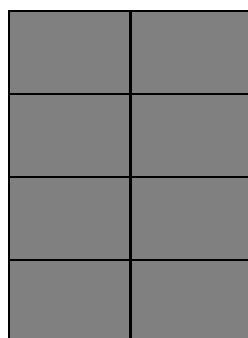

Not allowed

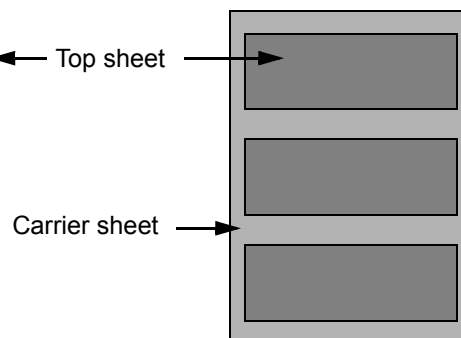

Use label paper that conforms to the following specifications.

Item	Specifications
Top sheet weight	44 to 74 g/m ²
Basis weight (overall paper weight)	104 to 151 g/m ²
Top sheet thickness	0.086 to 0.107 mm
Overall paper thickness	0.115 to 0.145 mm
Moisture content	4 to 6 % (composite)

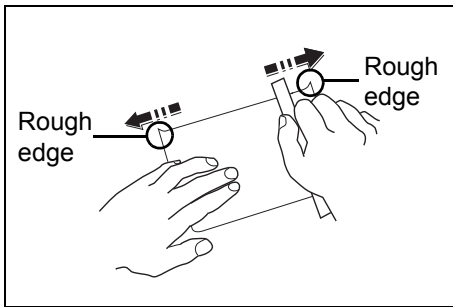

Postcards

Before loading postcards into the MP tray, fan them and align the edges. If the postcard paper is curled, straighten it before loading. Copying onto curled postcards may cause jams.

Do not use perforated return postcards.

Some postcards may still have rough edges on the back side caused by a paper cutter. Remove any such rough edges by placing the postcards on a flat surface and rubbing the edges gently a few times with a ruler.

Envelopes

Use the MP tray for envelopes.

Due to the structure of envelopes, copying evenly over the entire surface may not be possible in some cases. Thin envelopes in particular may be wrinkled by the machine in some cases as they pass through it. Before purchasing envelopes in volume, try testing a sample to ensure the copy quality.

Storing envelopes for a long period may cause them to become wrinkled. Thus, keep the package sealed until you are ready to use them.

Keep the following points in mind.

Do not use envelopes with exposed adhesive. In addition, do not use the type of envelope in which the adhesive is exposed after the top layer is peeled off. Serious damage may be caused if the paper covering the adhesive comes off in the machine.

Do not use envelopes with certain special features. For example, do not use envelopes with a grommet for winding a string to close the flap or envelopes with an open or film-covered window.

If paper jams occur, load fewer envelopes at once.

To prevent paper jams when copying onto multiple envelopes, do not allow more than ten envelopes to remain in the top tray at once.

Thick Paper

Before loading thick paper in the MP tray, fan it and align the edges. Some thick paper may still have rough edges caused by a paper cutter on the back side. Remove any such rough edges just as with *Postcards* by placing the paper on a flat surface and rubbing the edges gently a few times with a ruler. Copying onto paper with rough edges may cause jams.

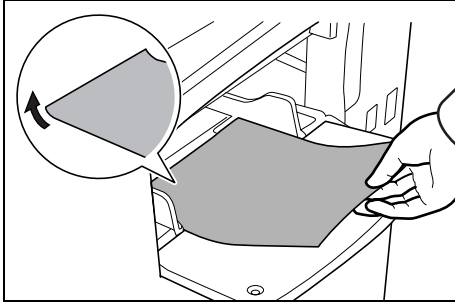

Note If the paper is not supplied correctly even after it is smoothed, load the paper in the MP tray with the leading edge raised a few millimeters as shown in the figure.

Colored Paper

Colored paper must conform to the specifications listed on the page 6-2. In addition, the pigments in the paper must be able to withstand the heat of copying (up to 200 °C or 392 °F).

Preprinted Paper

Preprinted paper must conform to the specifications listed on the page 6-2. The colored ink must be able to withstand the heat of copying. It must be resistant to silicone oil as well. Do not use paper with a treated surface such as glossy paper used for calendars.

Recycled Paper

Recycled paper must conform to the specifications listed on the page 6-2; however, its whiteness may be considered separately.



Note Before purchasing recycled paper in volume, try testing a sample to ensure that the copy quality is satisfactory.

Intercompatibility of Functions

Combine the various functions to provide even greater usage efficiency. Refer to the following charts for a list of functions that may be used in combination.

		Secondary Functions																									
		Duplex/Split Mode					Select original size					Zoom				Image Quality											
		Selection of Paper	One-sided to Two-sided	Two-sided to Two-sided ^a	Book to Two-sided	Two-sided to One-sided ^a	Book to One-sided	Standard/Other Standard Size	Size Entry	Auto Detect	Custom size	Combine mode	Auto Density	Manual Density	Equal size (100%)	XY zoom	Auto zoom	Manual zoom	Mixed Size Originals mode copying (mixed finish sizes) ^a	Mixed Size Originals mode copying (same finish size) ^a	Continuous Scan	Text + Photo	Photo	Text	Margin mode		
Primary Function	Selection of Paper	Y	Y	Y	Y	Y	Y	Y	Y	Y	Y	Y	Y	Y	Y	Y	Y	26	Y	Y	Y	Y	Y	Y			
	Duplex/Split Mode	One-sided to Two-sided	Y	N	N	N	N	Y	Y	Y	Y	Y	Y	Y	Y	Y	Y	Y	9	Y	Y	Y	Y	Y	Y		
		Two-sided to Two-sided ^a	Y	N	N	N	N	Y	Y	Y	Y	Y	Y	Y	Y	Y	Y	Y	9	9	Y	Y	Y	Y	Y		
		Book to Two-sided	Y	N	N	N	N	31	11	Y	11	12	Y	Y	Y	Y	Y	Y	9	9	Y	Y	Y	Y	Y		
		Two-sided to One-sided ^a	Y	N	N	N	N	Y	Y	Y	Y	Y	Y	Y	Y	Y	Y	Y	9	9	Y	Y	Y	Y	Y		
		Book to One-sided	Y	N	N	N	N	31	11	Y	11	12	Y	Y	Y	Y	Y	Y	9	9	Y	Y	Y	Y	Y		
	Select original size	Standard/Other Standard Size	Y	Y	Y	36	Y	36	N	N	N	Y	Y	Y	Y	Y	Y	Y	9	9	Y	Y	Y	Y	Y		
		Size Entry	Y	Y	Y	16	Y	16	N	N	N	27	Y	Y	Y	Y	Y	Y	9	9	Y	Y	Y	Y	Y		
		Auto Detect	Y	Y	Y	Y	Y	Y	N	N	N	Y	Y	Y	Y	Y	Y	Y	9	9	Y	Y	Y	Y	Y		
		Custom size	Y	Y	Y	16	Y	16	N	N	N	27	Y	Y	Y	Y	Y	Y	9	9	Y	Y	Y	Y	Y		
	Combine mode	Y	Y	Y	34	Y	34	Y	27	Y	27	N	Y	Y	Y	N1	Y	Y	9	9	Y	Y	Y	Y	N1		
	Auto Density	Y	Y	Y	Y	Y	Y	Y	Y	Y	Y	Y	N	Y	Y	Y	Y	Y	Y	Y	Y	Y	Y	Y	30	Y	Y
	Manual Density	Y	Y	Y	Y	Y	Y	Y	Y	Y	Y	Y	Y	N	Y	Y	Y	Y	Y	Y	Y	Y	Y	Y	Y	Y	
	Zoom	Equal size (100%)	Y	Y	Y	Y	Y	Y	Y	Y	Y	2	Y	Y	N	N	N	3	2	Y	Y	Y	Y	Y	Y	Y	
		XY zoom	Y	Y	Y	Y	Y	Y	Y	Y	Y	2	Y	Y	N	N	N	3	2	Y	Y	Y	Y	Y	Y	Y	
		Auto zoom	Y	Y	Y	Y	Y	Y	Y	Y	Y	2	Y	Y	N	N	N	3	2	Y	Y	Y	Y	Y	Y	Y	
		Manual zoom	Y	Y	Y	Y	Y	Y	Y	Y	Y	2	Y	Y	N	N	N	3	2	Y	Y	Y	Y	Y	Y	Y	
	Mixed Size Originals mode copying (mixed finish sizes) ^a	9	9	Y	9	Y	9	9	9	Y	9	9	Y	Y	3	3	3	3	N	Y	Y	Y	Y	Y	Y		
	Mixed Size Originals mode copying (same finish size) ^a	Y	Y	Y	9	Y	9	9	9	Y	9	9	Y	Y	N1	N1	Y	N1	N	28	Y	Y	Y	Y	Y		
	Continuous Scan	Y	Y	Y	Y	Y	Y	Y	Y	Y	Y	Y	Y	Y	Y	Y	Y	Y	22	N	Y	Y	Y	Y	Y		
	Image Quality	Text + Photo	Y	Y	Y	Y	Y	Y	Y	Y	Y	Y	Y	Y	Y	Y	Y	Y	Y	Y	Y	N	N	N	Y		
		Photo	Y	Y	Y	Y	Y	Y	Y	Y	Y	Y	1	Y	Y	Y	Y	Y	Y	Y	Y	N	N	N	Y		
		Text	Y	Y	Y	Y	Y	Y	Y	Y	Y	Y	Y	Y	Y	Y	Y	Y	Y	Y	Y	N	N	N	Y		
	Margin mode	Y	Y	Y	Y	Y	Y	Y	Y	Y	Y	22	Y	Y	Y	Y	Y	Y	Y	Y	Y	Y	Y	Y	Y		
	Centering Originals	Y	Y	Y	Y	Y	Y	Y	Y	Y	Y	Y	Y	Y	Y	Y	Y	Y	Y	Y	Y	Y	Y	Y	N		
	Page Numbering	42	Y	Y	Y	Y	Y	Y	Y	Y	Y	Y	Y	Y	Y	Y	Y	Y	9	Y	Y	Y	Y	Y	Y		
	Collate mode	Y	Y	Y	Y	Y	Y	Y	Y	Y	Y	Y	Y	Y	Y	Y	Y	Y	Y	Y	Y	Y	Y	Y	Y		
	Offset mode (per page)	Y	Y	Y	Y	Y	Y	Y	Y	Y	Y	Y	Y	Y	Y	Y	Y	Y	Y	Y	Y	Y	Y	Y	Y		
	Offset mode (per set)	Y	Y	Y	Y	Y	Y	Y	Y	Y	Y	Y	Y	Y	Y	Y	Y	Y	Y	Y	Y	Y	Y	Y	Y		
	Border erase	Sheet Erase	Y	Y	Y	Y	Y	Y	5	Y	5	Y	Y	Y	Y	Y	Y	Y	6	6	Y	Y	Y	Y	Y		
Book Erase		Y	Y	Y	Y	Y	Y	5	Y	5	Y	Y	Y	Y	Y	Y	Y	6	6	Y	Y	Y	Y	Y			
Separate Border Erase		Y	Y	Y	Y	Y	Y	5	Y	5	Y	Y	Y	Y	Y	Y	Y	6	6	Y	Y	Y	Y	Y			
Cover Mode	Y	Y	Y	Y	Y	Y	19	Y	19	20	Y	Y	Y	Y	Y	Y	9	9	Y	Y	Y	Y	Y	Y			
Booklet from Sheets	Y	N1	N1	N1	N1	N1	38	15	Y	15	18	Y	Y	N1	Y	Y	9	9	Y	Y	Y	Y	Y	4			
Booklet from Facing Pages	Y	N1	N1	N1	N1	N1	31	15	Y	15	18	Y	Y	35	35	Y	35	9	9	Y	Y	Y	Y	4			
Auto Image Rotation	Y	Y	Y	Y	Y	Y	Y	Y	Y	Y	Y	Y	Y	Y	Y	Y	Y	Y	Y	Y	Y	Y	Y	Y			
Proof Copy	Y	Y	Y	Y	Y	Y	Y	Y	Y	Y	Y	Y	Y	Y	Y	Y	Y	Y	Y	Y	Y	Y	Y	Y			
Memo Mode	Y	Y	Y	N1	Y	N1	Y	27	Y	27	N	Y	Y	Y	32	Y	Y	9	9	Y	Y	Y	Y	N1			
EcoPrint	Y	Y	Y	Y	Y	Y	Y	Y	Y	Y	Y	Y	Y	Y	Y	Y	Y	Y	Y	Y	Y	Y	Y	Y			

a. This operation requires the optional document processor.

Secondary Functions																				Primary Function				
Centering Originals	Page Numbering	Collate mode	Offset mode (per page)	Offset mode (per set)	Border erase			Cover Mode	Booklet from Sheets	Booklet from Facing Pages	Auto Image Rotation	Proof Copy	Memo Mode	EcoPrint	Original Orientation	Negative Image Copying	Mirror Copying	Preparing a Job for Repeat Copy	Output destination ^a			Interrupt Mode		
					Sheet Erase	Book Erase	Separate Border Erase												Job separator	Top tray	Finisher tray		Stapling ^b	
Y	41	Y	Y	Y	Y	Y	Y	Y	Y	Y	Y	Y	Y	Y	Y	Y	Y	Y	Y	Y	Y	Y	Y	Selection of Paper
Y	Y	Y	Y	Y	Y	Y	Y	Y	8	8	Y	Y	Y	Y	Y	10	Y	Y	Y	Y	Y	Y	Y	One-sided to Two-sided
Y	Y	Y	Y	Y	Y	Y	Y	Y	8	8	Y	Y	Y	Y	Y	10	Y	Y	Y	Y	Y	Y	Y	Two-sided to Two-sided ^c
Y	Y	Y	Y	Y	Y	Y	Y	Y	8	8	Y	Y	N1	Y	7	10	Y	Y	Y	Y	Y	Y	Y	Book to Two-sided
Y	Y	Y	Y	Y	Y	Y	Y	Y	8	8	Y	Y	Y	Y	Y	Y	Y	Y	Y	Y	Y	Y	Y	Two-sided to One-sided ^c
Y	Y	Y	Y	Y	Y	Y	Y	Y	8	8	Y	Y	N1	Y	7	Y	Y	Y	Y	Y	Y	Y	Y	Book to One-sided
Y	Y	Y	Y	Y	Y	Y	Y	Y	38	36	Y	Y	Y	Y	Y	Y	Y	Y	Y	Y	Y	Y	Y	Standard/Other Standard Size
Y	Y	Y	Y	Y	5	5	5	19	16	16	Y	Y	N1	Y	Y	Y	Y	Y	Y	Y	Y	Y	Y	Size Entry
Y	Y	Y	Y	Y	Y	Y	Y	Y	Y	Y	Y	Y	Y	Y	Y	Y	Y	Y	Y	Y	Y	Y	Y	Auto Detect
Y	Y	Y	Y	Y	5	5	5	19	16	16	Y	Y	N1	Y	Y	Y	Y	Y	Y	Y	Y	Y	Y	Custom size
Y	Y	Y	Y	Y	Y	Y	Y	20	18	18	Y	Y	N	Y	Y	Y	Y	Y	Y	Y	Y	Y	Y	Combine mode
Y	Y	Y	Y	Y	Y	Y	Y	Y	Y	Y	Y	Y	Y	Y	Y	Y	Y	Y	Y	Y	Y	Y	Y	Auto Density
Y	Y	Y	Y	Y	Y	Y	Y	Y	Y	Y	Y	Y	Y	Y	Y	Y	Y	Y	Y	Y	Y	Y	Y	Manual Density
Y	Y	Y	Y	Y	Y	Y	Y	Y	2	2	Y	Y	Y	Y	Y	Y	Y	Y	Y	Y	Y	Y	Y	Equal size (100%)
Y	Y	Y	Y	Y	Y	Y	Y	Y	2	2	Y	Y	2	Y	Y	Y	Y	Y	Y	Y	Y	Y	Y	XY zoom
Y	Y	Y	Y	Y	Y	Y	Y	Y	2	2	Y	Y	Y	Y	Y	Y	Y	Y	Y	Y	Y	Y	Y	Auto zoom
Y	Y	Y	Y	Y	Y	Y	Y	Y	2	2	Y	Y	Y	Y	Y	Y	Y	Y	Y	Y	Y	Y	Y	Manual zoom
Y	9	Y	Y	Y	6	6	6	9	9	9	Y	Y	9	Y	Y	Y	Y	Y	Y	Y	Y	Y	24	Mixed Size Originals mode copying (mixed finish sizes) ^c
Y	Y	Y	Y	Y	6	6	6	9	9	9	Y	Y	9	Y	Y	Y	Y	Y	Y	Y	Y	Y	Y	Mixed Size Originals mode copying (same finish size) ^c
Y	Y	Y	Y	Y	Y	Y	Y	Y	Y	Y	Y	Y	Y	Y	Y	Y	Y	Y	Y	Y	Y	Y	Y	Continuous Scan
Y	Y	Y	Y	Y	Y	Y	Y	Y	Y	Y	Y	Y	Y	Y	Y	Y	Y	Y	Y	Y	Y	Y	Y	Text + Photo
Y	Y	Y	Y	Y	Y	Y	Y	Y	Y	Y	Y	Y	Y	Y	Y	Y	Y	Y	Y	Y	Y	Y	Y	Photo
Y	Y	Y	Y	Y	Y	Y	Y	Y	Y	Y	Y	Y	Y	Y	Y	Y	Y	Y	Y	Y	Y	Y	Y	Text
N	Y	Y	Y	Y	Y	Y	Y	Y	22	22	Y	Y	22	Y	Y	Y	Y	Y	Y	Y	Y	Y	Y	Margin mode
Y	Y	Y	Y	Y	Y	Y	Y	Y	Y	Y	Y	Y	Y	Y	Y	Y	Y	Y	Y	Y	Y	Y	Y	Centering Originals
Y	Y	Y	Y	Y	Y	Y	Y	Y	Y	Y	Y	Y	Y	Y	Y	Y	Y	Y	Y	Y	Y	Y	Y	Page Numbering
Y	Y	Y	Y	Y	Y	Y	Y	Y	23	23	Y	Y	Y	Y	Y	Y	Y	Y	Y	Y	Y	Y	Y	Collate mode
Y	Y	Y	Y	N	Y	Y	Y	Y	23	23	Y	Y	Y	Y	Y	Y	Y	Y	Y	39	39	Y	N	Offset mode (per page)
Y	Y	Y	N	Y	Y	Y	Y	Y	23	23	Y	Y	Y	Y	Y	Y	Y	Y	Y	39	39	Y	N	Offset mode (per set)
Y	Y	Y	Y	Y	Y	N	N	Y	Y	Y	Y	Y	Y	Y	Y	Y	Y	Y	Y	Y	Y	Y	Y	Sheet Erase
Y	Y	Y	Y	Y	N	N	N	Y	N1	Y	Y	Y	Y	Y	7	Y	Y	Y	Y	Y	Y	Y	Y	Book Erase
Y	Y	Y	Y	Y	N	N	Y	Y	Y	Y	Y	Y	Y	Y	Y	Y	Y	Y	Y	Y	Y	Y	Y	Separate Border Erase
Y	Y	Y	Y	Y	Y	Y	Y	Y	14	14	Y	Y	N1	Y	Y	21	Y	Y	Y	Y	Y	Y	Y	Cover Mode
Y	Y	N1	13	13	Y	N1	Y	14	N	Y	Y	N1	Y	Y	10	Y	Y	Y	Y	Y	Y	Y	17	Booklet from Sheets
Y	Y	N1	13	13	Y	Y	Y	14	N	Y	Y	N1	Y	7	10	Y	Y	Y	Y	Y	Y	Y	17	Booklet from Facing Pages
Y	Y	Y	Y	Y	Y	Y	Y	Y	Y	Y	Y	Y	Y	Y	Y	Y	Y	Y	Y	Y	Y	Y	Y	Auto Image Rotation
Y	Y	Y	Y	Y	Y	Y	Y	Y	Y	Y	Y	Y	Y	Y	Y	Y	Y	Y	Y	Y	Y	Y	29	Proof Copy
Y	Y	Y	Y	Y	Y	Y	Y	N1	N1	N1	Y	Y	Y	Y	Y	Y	Y	Y	Y	Y	Y	Y	Y	Memo Mode
Y	Y	Y	Y	Y	Y	Y	Y	Y	Y	Y	Y	Y	Y	Y	Y	Y	Y	Y	Y	Y	Y	Y	Y	EcoPrint

- a. This operation requires the optional job separator, document processor or built-in finisher.
- b. This operation requires the optional document finisher or built-in finisher.
- c. This operation requires the optional document processor.

		Secondary Functions																								
		Duplex/Split Mode					Select original size			Zoom							Image Quality									
		Selection of Paper	One-sided to Two-sided	Two-sided to Two-sided ^a	Book to Two-sided	Two-sided to One-sided ^a	Book to One-sided	Standard/Other Standard Size	Size Entry	Auto Detect	Custom size	Combine Mode	Auto Density	Manual Density	Equal size (100%)	XY zoom	Auto zoom	Manual zoom	Mixed Size Originals mode copying (mixed original sizes) ^a	Mixed Size Originals modecopying (all same size) ^a	Continuous Scan	Text + Photo	Photo	Text	Margin mode	
Primary Function	Original Orientation	Y	Y	Y	33	Y	33	Y	Y	Y	Y	Y	Y	Y	Y	Y	Y	Y	Y	Y	Y	Y	Y	Y	Y	
	Negative Image Copying	Y	22	22	22	Y	Y	Y	Y	Y	Y	Y	Y	Y	Y	Y	Y	Y	Y	Y	Y	Y	Y	Y	Y	
	Mirror Copying	Y	Y	Y	Y	Y	Y	Y	Y	Y	Y	Y	Y	Y	Y	Y	Y	Y	Y	Y	Y	Y	Y	Y	Y	
	Preparing a Job for Repeat Copy	Y	Y	Y	Y	Y	Y	Y	Y	Y	Y	Y	Y	Y	Y	Y	Y	Y	Y	Y	Y	Y	Y	Y	Y	
	Output destination ^b	Job separator	Y	Y	Y	Y	Y	Y	Y	Y	Y	Y	Y	Y	Y	Y	Y	Y	Y	Y	Y	Y	Y	Y	Y	
		Top tray	Y	Y	Y	Y	Y	Y	Y	Y	Y	Y	Y	Y	Y	Y	Y	Y	Y	Y	Y	Y	Y	Y	Y	
		Finisher tray	Y	Y	Y	Y	Y	Y	Y	Y	Y	Y	Y	Y	Y	Y	Y	Y	Y	Y	Y	Y	Y	Y	Y	
	Stapling ^c	Y	Y	Y	Y	Y	Y	Y	Y	Y	Y	Y	Y	Y	Y	Y	Y	25	Y	Y	Y	Y	Y	Y	Y	
	Interrupt Mode	Y	Y	Y	Y	Y	Y	Y	Y	Y	Y	Y	Y	Y	Y	Y	Y	Y	Y	Y	Y	Y	Y	Y	Y	
	Programming multi-part jobs: Step 1	Y	Y	Y	Y	Y	Y	Y	Y	Y	Y	N	Y	Y	Y	Y	Y	N	N	N	Y	Y	Y	Y	Y	
	Programming multi-part jobs: Step 2-	Y	N	N	N	Y	Y	Y	Y	Y	Y	N	Y	Y	Y	Y	Y	N	N	N	Y	Y	Y	Y	N	
	Output Management Functions	N	N	N	N	N	N	N	N	N	N	N	N	N	N	N	N	N	N	N	N	N	N	N	N	N
	Repeat Copy	N	N	N	N	N	N	N	N	N	N	N	N	N	N	N	N	N	N	N	N	N	N	N	N	N

- a. This operation requires the optional document processor.
- b. This operation requires the optional job separator, document processor or built-in finisher.
- c. This operation requires the optional document finisher or built-in finisher.

Y: May be combined.

N: May not be combined.

N1: Primary function takes precedence. Secondary function cannot be selected.

- 1 Auto Density is not available for photo original and print original.
- 2 Auto zoom is set because only auto zoom is available.
- 3 Auto paper is set because only auto paper is available.
- 4 Margin mode and Booklet mode cannot be combined.
- 5 Border erase is not available when the original size is selected via user entry.
- 6 Border erase and Mixed Size Originals cannot be combined.
- 7 Combination not available because book original only allows top edge to align to the back.
- 8 When Duplex mode or Split mode is selected, Booklet modes are given secondary priority.
- 9 May not be combined with Mixed Size Originals mode.
- 10 Negative image copying not permitted for Duplex mode.
- 11 Original size selection not available for Split mode (booklet to one-sided).

Secondary Functions																				Primary Function	
Centering Originals	Page Numbering	Collate Mode	Offset mode (per page)	Offset mode (per set)	Sheet Erase	Book Erase	Separate Border Erase	Cover Mode	Booklet from Sheets	Booklet from Facing Pages	Auto Image Rotation	Proof Copy	Memo Mode	EcoPrint	Original Orientation	Negative Image Copying	Mirror Copying	Preparing a Job for Repeat Copy	Output destination ^a		Interrupt Mode
Y	Y	Y	Y	Y	Y	33	Y	Y	Y	33	Y	Y	Y	Y	Y	Y	Y	Y	Y	Y	Original Orientation
Y	Y	Y	Y	Y	Y	Y	Y	22	22	22	Y	Y	Y	Y	Y	Y	Y	Y	Y	Y	Negative Image Copying
Y	Y	Y	Y	Y	Y	Y	Y	Y	Y	Y	Y	Y	Y	Y	Y	Y	Y	Y	Y	Y	Mirror Copying
Y	Y	Y	Y	Y	Y	Y	Y	Y	Y	Y	Y	Y	Y	Y	Y	Y	Y	Y	Y	Y	Preparing a Job for Repeat Copy
Y	Y	Y	40	40	Y	Y	Y	Y	Y	Y	Y	Y	Y	Y	Y	Y	Y	Y	Y	N	Job separator
Y	Y	Y	40	40	Y	Y	Y	Y	Y	Y	Y	Y	Y	Y	Y	Y	Y	Y	N	N	Top tray
Y	Y	Y	Y	Y	Y	Y	Y	Y	Y	Y	Y	Y	Y	Y	Y	Y	Y	Y	N	N	Finisher tray
Y	Y	Y	N	N	Y	Y	Y	Y	Y	Y	Y	Y	Y	Y	Y	Y	Y	Y	N	N	Stapling ^b
Y	Y	Y	Y	Y	Y	Y	Y	Y	Y	Y	Y	Y	Y	Y	Y	Y	Y	Y	Y	Y	Interrupt Mode
Y	Y	Y	Y	Y	Y	N	Y	N	N	N	N	N	N	Y	Y	N	N	Y	Y	Y	Programming multi-part jobs: Step 1
N	N	N	N	N	Y	N	Y	N	N	N	N	N	N	Y	N	N	N	N	N	N	Programming multi-part jobs: Step 2-
N	N	N	N	N	N	N	N	N	N	N	N	N	N	N	N	N	N	N	N	N	Output Management Functions
N	N	N	N	N	N	N	N	N	N	N	N	N	N	N	N	N	N	N	N	N	Repeat Copy

- a. This operation requires the optional job separator, document processor or built-in finisher.
- b. This operation requires the optional document finisher or built-in finisher.

- 12 Combine mode not available for Split mode (booklet to one-sided).
- 13 Booklet copying may not be combined with Offset mode.
- 14 Cover page may be set during booklet operation setting.
- 15 Booklet mode is not available when the original size is selected via user entry.
- 16 The secondary function takes priority and setting is returned to Auto Detect.
- 17 Stapling is not permitted.
- 18 Combine mode and Booklet mode may not be combined.
- 19 Cover mode is not available when the original size is selected via user entry.
- 20 Cover mode and Combine mode may not be combined.
- 21 Cover mode is not available with Negative image copying.
- 22 The secondary function takes priority and the primary function is released.
- 23 If the optional document finisher is installed, the secondary function takes priority and the Collate mode changes to [Collate: On] while the Offset mode changes to [Off].
If the optional document finisher is not installed, the secondary function takes priority and the Collate mode changes to [Collate: On] while the Offset mode changes to [On].
- 24 If the optional built-in finisher is installed, the primary function takes precedence and the secondary function cannot be selected.
- 25 If the optional built-in finisher is installed, the secondary function takes priority and the primary function is released.

-
- 26** Setting is canceled due to switch to automatic paper select.
 - 27** Combine mode is not available when the original size is selected via user entry.
 - 28** May not be combined with Continuous scan.
 - 29** May not be combined with Interrupt mode.
 - 30** Auto Density is not available for photo original. (switches to manual density)
 - 31** Original size selection (Paper sizes other than 11 × 17", 8 1/2 × 11", A3, B4, A4R, B5R, A5R and 8K.) not available.
 - 32** May not be combined with Memo mode.
 - 33** The secondary function takes priority and original set direction is set to [Top Edge Top].
 - 34** May not be combined with Combine mode.
 - 35** May not be combined with Booklet mode. (switches to auto zoom)
 - 36** When selecting original size (B6, B6R, A6R, 11 × 15", Postcard), secondary function is given priority and setting switches to auto detect.
 - 37** The secondary function takes priority and the output destination changes to [Finisher Tray].
 - 38** When selecting original size (B6, B6R, A6R, 11 × 15", Postcard), a message prompt is displayed to change the setting.
 - 39** Cannot be selected when the optional document finisher is installed.
 - 40** The output destination changes to [Finisher tray] when the optional document finisher is installed.
 - 41** When [APS] is set, the secondary function takes priority and the [APS] setting is cancelled.
 - 42** [APS] cannot be selected when page numbering is set.

Glossary

Additional Memory

Increase the memory available to the printer. Additional memory enables printing more complex data. An additional 128 MB, 256 MB or 512 MB may be added. Contact your product service representative to find out about memory that can be used in this machine.

AppleTalk

A standard network function provided in the Mac OS from the Apple Corporation. Also used to refer to the protocol family used in AppleTalk network functionality. AppleTalk provides file sharing and printer sharing services. Applications may also be launched from other computers on an AppleTalk network.

Auto Low-Power mode

A low power mode designed for electrical power saving, activated when the machine is left unused or data has not been received for a specific period. Less power is consumed in Low-Power mode than in standby mode.

Auto Paper Selection

Automatically selects the same output paper size as the original paper size when copying.

Auto Sleep mode

A mode designed for electrical power saving, activated when the machine is left unused or data has not been received for a specific period. In Sleep mode, power consumption is kept to a minimum.

CPM (copies per minute)

The number of A4-sized copies (printouts) that can be delivered in one minute.

Default gateway

The address representing the computer or router used when accessing a computer outside the local network. If a specific gateway is not defined for the IP address being accessed, the data is sent to the host specified by the default gateway.

DHCP (Dynamic Host Configuration Protocol)

DHCP is a protocol to automatically resolve IP addresses, subnet masks, and gateway addresses on a TCP/IP network. Because it is not necessary to manually assign an IP address to each client (including printers), it is especially useful to reduce the network management workload for networks with many clients.

dpi (dots per inch)

A measure of image resolution. Indicates the number of dots in 1 inch (25.4mm).

EcoPrint

A printing mode that helps conserve toner. Prints made in this mode are thus lighter than normal.

Emulation

A function to decode and process the page description languages of other printers. This printer provides support for PCL6, KPDL, and KC-GL emulation.

Form Feed Timeout

When sending data to a printer, there may occur time pauses. This printer includes functionality to avoid form feeding even when data is not received for a while and continue after a pause in sent data. Form feed timeout is a feature to wait the specified time before outputting this auto form feed page. The printer automatically outputs a page when the wait period has exceeded the configured form feed timeout period. However, no page is output if there is no print data on the last page.

Grayscale

A method of representing colors on a computer. Images are expressed in only shades of brightness from black to white, including no color information, or 'monochrome.' The number of gray levels that can be expressed is determined by the number of bits. 1 bit allows only black and white and no intermediate levels, 8 bits allows 256 levels (including black and white) and 16 bit allows 65536 gray levels.

IEEE1284

An international standard for connecting printers and computers. This standard was established in 1994 by the IEEE (Institute of Electrical and Electronic Engineers).

IP Address

An identification number assigned to every computer connected to a TCP/IP network. Represented by 4 octets of numbers from 0 - 255, such as 192.168.110.171.

KPDL

A Kyocera page description language compatible with Adobe PostScript Level 3.

MP tray

The paper supply tray on the right side of the machine. Use this tray instead of the cassettes when printing onto envelopes, postcards, transparencies, or labels.

NetBEUI (NetBIOS Extended User Interface) Setting

A network protocol developed by IBM in 1985. An extension of the NetBIOS protocol, NetBEUI delivers better performance than TCP/IP on small scale networks. However, it is not suitable for large scale networks because it has no routing functionality to determine the best suitable route from many routes. A standard protocol of IBM OS/2 and Microsoft Windows operating systems, which provide file and print services based on NetBEUI.

NetWare

A network OS (network management software) from Novell. Netware can be run on many different operating systems.

PostScript

A page description language developed by Adobe Systems. PDL provides flexible font functionality and high quality graphics to deliver high quality printing. The first version, now referred to as Level 1, was introduced in 1985. Level 2, which included support for color printing and double byte languages such as Japanese was released in 1990. Level 3, which provided support for the Internet, an implementation criteria hierarchy, and support for the PDF format, was introduced in 1996.

Printer Driver

Software used to convert application data for printing. The printer driver is stored on the included CD-ROM. Install onto computers connected to this machine/printer.

Status Page

Print the Status Page to confirm various information about this device, such as total installed memory, number of pages printed or copied, or paper feed settings. The Status Page can be printed from the device operation panel.

Subnet Mask

A 32 bit value that defines how many bits of an IP address are used to identify a network in a network address.

TCP/IP (Transmission Control Protocol/Internet Protocol)

A network protocol to define data transmission standards for communication between computers and other devices.

USB (Universal Serial Bus)

This device includes a Hi-Speed USB compliant USB interface. The maximum communication speed is 480 Mbps, which supports high speed data transfer.

Index

Numerics

- 2-in-1 mode 1-9
- 4-in-1 mode 1-10

A

- Additional memory 6-15
- Adjusting auto density
 - Default setting 3-7
- Adjusting background density 3-4
- Adjusting manual density
 - Default setting 3-7
- AppleTalk 6-15
- Auto cassette switching 3-12
- Auto clear
 - Enabling/Disabling 3-21
 - Time setting 3-18
- Auto detect originals 3-17
- Auto image rotation 1-27
 - Default settings 3-8
- Auto Low-Power mode 6-15
 - Setting timeout 3-18
- Auto paper selection 6-15
 - Selecting media types for automatic paper selection 3-5
 - Setting auto paper selection 3-5
- Auto Sleep mode 6-15
 - Enabling/Disabling 3-21
 - Setting timeout 3-18

B

- Booklet
 - Book 1-21
 - Sheet originals 1-19
- Border erase 1-14
 - Default settings 3-9

C

- Centering originals 1-13
- Changing management code 3-20
- Checking total copy count 3-28
- Collate mode
 - Default settings 3-8
- Colored paper 6-9
- Combine mode 1-9
- Continuous scan 1-24
- Copy/Printer output management 4-15
- Copy count per department
 - Copy count per department 4-11
 - Total job accounting 4-10
- Copy functions 1-1
- Copy quantity 1-5
 - Preset limit 3-9
- Correcting black lines 3-4

- Cover 1-18
 - Paper source for cover 3-6
- cpm 6-15
- Customize (basic screen) 3-10
- Customize (user choice) 3-10

D

- Default counter limit value 4-16
- Default gateway 6-15
- Default settings
 - Default settings for copying 3-2
 - Job accounting 4-13
 - Machine default 3-11
- Density 3-3
- Density steps 3-3
- DHCP 6-15
- dpi 6-15
- Drum refresh 3-25
 - Auto drum refresh 3-22

E

- EcoPrint 1-28, 6-15
 - Default settings 3-4
- Emulation 6-16
- Envelopes 6-8
- Error messages 5-4

F

- Form feed timeout 6-16

G

- Grayscale 6-16

I

- IEEE1284 6-16
- Image quality
 - Default settings 3-3
- Intercompatibility of functions 6-10
- IP address 6-16

J

- Job accounting
 - Activating and deactivating 4-12
 - Copy 4-13
 - Default settings 4-13
 - Delete 4-8
 - Description 4-2
 - Editing department information 4-8
 - Fax 4-15

Limit in use	4-5
New account	4-4
Operation during setting	4-18
Printer	4-13
Total	4-10
Job build	1-34
Procedure	1-34
Setting functions	1-37

K

KPDL	6-16
------------	------

L

Label	6-7
Legal information and conventions	
About this Operation Guide	vii
Conventions in this guide	vii
Originals and paper sizes	viii
Regarding tradenames	iii
Limit in use	
Change	4-9
Copy	4-5, 4-7
Description	4-5
Fax	4-6
Limitation	4-6
Printer	4-5, 4-7

M

Margin mode	1-12
Default settings	3-8
Memo mode	1-22
Mirror copying	1-29
Mixed size originals	1-30
MP tray	6-16
Enabling quick access to MP tray settings	3-14
Registering MP tray paper size	3-13
Specifying the media type	3-23
Specifying the paper size	3-23

N

Negative image copying	1-29
NetBEUI	6-16
NetWare	6-16
Notification sounds	3-20

O

Offset mode	1-7
Default settings	3-8
Original	
Size	viii
Original orientation	1-6
Default settings	3-17
Output management functions	
Description	2-2
[Prt Status] screen	2-3

Using the output management functions	2-2
---	-----

P

Page numbering	1-16
Paper	6-2
Basic paper specifications	6-2
Choosing the appropriate paper	6-3
Size	viii
Special paper	6-6
Paper Selection	3-5
Paper source	1-2
Postcards	6-8
PostScript	6-17
Preprinted paper	6-9
Printer driver	6-17
Printer error report	4-14
Printing from unregistered sources (printer)	4-14
Printing reports	3-26
Programmed copying	
Deleting	1-32
Editing names	1-31
Registering	1-31
Using programs to copy	1-31
Proof copy	1-24

R

Recycled paper	6-9
Register keys	
Deleting	1-33
Registering	1-33
Setting to show/hide	3-10
Repeat copy	
Default settings	3-9
Deleting	1-26
Output	1-25
Printing the first page	1-26
Setting	1-25
Response to unauthorized requests	4-16

S

Selecting default paper source	3-6
Selecting default zoom	3-7
Selecting original size	1-3
Registration method	3-24
Selecting output destination	1-28
Default setting (fax)	3-19
Default settings (copy)	3-18
Select the main mode	3-19
Setting auto % priority	3-6
Setting handling for special media types	3-16
Silent mode	3-20
Solving malfunctions	5-2
Specifying the media type	3-13
Specifying the paper size	3-12
Stapling	1-8
Status page	6-17
Subnet mask	6-17
System menu	3-1

T

TCP/IP	6-17
Thick paper	6-9
Total count by size	4-16
Transparencies	6-6
Type adjust	
Duplex mode	3-15
Paper weight	3-14

U

USB	6-17
-----------	------

DIRECTIVE 2002/96/CE ON THE TREATMENT, COLLECTION, RECYCLING AND DISPOSAL OF ELECTRIC AND ELECTRONIC DEVICES AND THEIR COMPONENTS

INFORMATION

1. FOR COUNTRIES IN THE EUROPEAN UNION (EU)

The disposal of electric and electronic devices as solid urban waste is strictly prohibited: it must be collected separately.

The dumping of these devices at unequipped and unauthorized places may have hazardous effects on health and the environment.

Offenders will be subjected to the penalties and measures laid down by the law.

TO DISPOSE OF OUR DEVICES CORRECTLY:

- a) Contact the Local Authorities, who will give you the practical information you need and the instructions for handling the waste correctly, for example: location and times of the waste collection centres, etc.
- b) When you purchase a new device of ours, give a used device similar to the one purchased to our dealer for disposal.



The crossed dustbin symbol on the device means that:

- when it to be disposed of, the device is to be taken to the equipped waste collection centres and is to be handled separately from urban waste;
- The producer guarantees the activation of the treatment, collection, recycling and disposal procedures in accordance with Directive 2002/96/CE (and subsequent amendments).

2. FOR OTHER COUNTRIES (NOT IN THE EU)

The treatment, collection, recycling and disposal of electric and electronic devices will be carried out in accordance with the laws in force in the country in question.