



TELARIS 0100 *plus*













Content	Page
1.0 Introduction	4
1.1 Model and Type	4
1.2 Product description	4
2.0 Transport and Storage	5
3.0 Safety Measures	5
3.1 Appropriate Usage	6
4.0 Display and Control Elements	7
4.1 Display	7
4.2 Operation Elements	8
5.0 Carrying out Measurements	9
5.1 Voltage Measurement	10
5.2 Low-Ohm Resistance Measurement	11
5.3 Insulation Measurement	13
5.4 Mains Internal Resistance Measurement / SCC Measurement	15
5.5 Loop Impedance Measurement / PSCCurrent Measurement	18
5.6 Loop Impedance Measurement without RCD Tripping	20
5.7 General Information about RCD Tests	21
5.7.1 RCD – Measurement of Contact Voltage UB and the Earthing Resistance RE without RCD Tripping	22
5.7.2 RCD Trip Time Test, Contact Voltage (ta, VB / RE)	24
5.7.3 RCD Test with Rising Residual Current, Trip Current (I, ta/VC	27
5.8 Rotary Field Test	29
6.0 Storing, Printing, and Data Transfer	30
6.1 Storing Measurement Data	30
6.2 Viewing Measurement Data	31
6.3 Printing Measurement Data	32
6.4 Deleting Saved Measurement Data/View the Memory Location Number	32
6.5 Delete all Saved Measurement Values	32
6.6 Infrared Interface, send Measurement Data	32
7.0 Displays / Error Messages	33
8.0 Energy Management	36
9.0 Maintenance	36
9.1 Cleaning	36
10.0 Battery Replacement	36
11.0 Built in fuses	38
11.1 Display for Tripped Fuses	38
12.0 Calibration Interval	38
13.0 Technical Data	39
24 month Warranty	43

Introduction/Product description

References marked on instrument or in instruction manual:

-  Warning of a potential danger, comply with instruction manual.
-  Reference. Please use utmost attention.
-  Caution! Dangerous voltage. Danger of electrical shock.
-  Continuous double or reinforced insulation complies with Category II.
-  Warning of potential danger caused by accumulators and batteries.
-  Conformity symbol, the instrument complies with the valid directives. It complies with the EMC Directive (89/336/EEC), Standards EN 50081 and EN 50082-1 are fulfilled. It also complies with the Low Voltage Directive (73/23/EEC), Standard EN 61010-1 is fulfilled.
-  **The instruction manual contains information and references necessary for safe operation and maintenance of the instrument.** Prior to using the instrument (commissioning / assembly) the user is kindly requested to thoroughly read the instruction manual and comply with it in all sections.
-  Failure to read the instruction manual or to comply with the warnings and references contained herein can result in serious bodily injury or instrument damage.

1.0 Introduction

You have purchased a high quality measurement instrument from Ch. BEHA GmbH which will allow you to carry out measurement for many years to come. Ch. BEHA GmbH is a member of the world-wide operating BEHA Group with its head office in Glottertal/ Schwarzwald which also houses our development centre. The BEHA Group is a leading organisation for Test and Measuring instruments.

1.1 Model and Type Designation

The type shield sticker is located on the rear of the instrument. It contains the instrument serial number and product designation. When questions arise regarding the instrument, please always quote product designation and serial number.

1.2 Product description

The UNITEST TELARIS 0100 plus is a handy test and measurement instrument for testing in systems and installations in compliance with DIN VDE. All values required for FAT (Final Approval Test) reports (e.g. ZVEH) can be measured by using the TELARIS 0100 plus. Reporting, filing or further processing of measured values is ensured by means of an internal data memory and built-in infrared interface (for data transfer to PC).

The UNITEST TELARIS 0100 plus is characterised by the following features:

- Measurement of loop resistance and prospective short circuit current measurement without tripping the RCD
- Line resistance measurement up to 440 V
- Prospective short circuit current measurement
- RCD measurements (contact voltage, trip time, trip current - ramp method)
- Low Ohm measurement
- Insulation measurement with 100, 250 500 V
- Voltage and frequency measurement
- Rotary field test
- Integrated socket test with contact electrode to enable the user to quickly establish incorrectly installed sockets and/or protective conductor failures
- Integrated memory for approx. 500 measurement values
- Standard, built-in IR RS-232 interface for transferring measurement data to the PC
- Clear and large LCD providing the user with an optimum visual indication of both test values and limits
- Auto power off

Scope of Supply

- 1 pc. UNITEST TELARIS 0100 plus
- 3 pc. Measurement leads
- 1 Three-pole test lead with safety plug
- 3 pcs Crocodile clamps
- 3 pcs Test probe
- 6 pcs Battery 1.5V, type IEC LR6 (Size AA)
- 1 pc Protective Holster
- 1 pc Carrying Case
- 1 pc Instruction manual

2.0 Transport and Storage

Please keep the original packaging for later transport, e.g. for calibration. Any transport damage due to faulty packaging will be excluded from warranty claims.

In order to avoid instrument damage, we recommend that accumulators are removed when not using the instrument over a certain period of time. However, should the instrument be contaminated by leaking batteries cells, you are kindly requested to return it to the factory for cleaning and inspection.

Instruments must be stored in dry and closed areas. In the case of an instrument being transported in extreme temperatures, a recovery time of at least 2 hours is required prior to instrument operation.

3.0 Safety Measures

The UNITEST Telaris 0100 plus has been designed and checked in accordance with the safety regulations for Electronic test and Measurement Instruments EN 61010 and IEC 61010, and left our factory in a safe and perfect condition.

⚠ The instruction manual contains information and references necessary for safe operation and maintenance of the instrument.

⚠ The respective accident prevention regulations established by the professional association for electrical systems and equipment must be strictly met at all times.

Safety Measures

- ⚠ In order to avoid electrical shock, the valid safety and VDE regulations regarding excessive contact voltages must receive the utmost attention when working with voltages exceeding 120V (60V) DC or 50V (25V)rms AC. The values in brackets are valid for limited ranges (for example medicine and agriculture).
- ⚠ Measurements in dangerous proximity of electrical installations are only to be executed when instructed by a responsible electrical specialist, and never alone.
- ⚠ If the operator's safety is no longer guaranteed, the instrument is to be put out of service and protected against use. The safety can no longer be guaranteed if the instrument (or leads):
 - shows obvious damage
 - does not carry out the desired measurements
 - has been stored for too long under unfavourable conditions
 - has been subjected to mechanical stress during transport.
- ⚠ Prior to usage, inspect the instrument and test leads for external damage. Prior to any operation, ensure that connecting leads used and instruments are in perfect condition.
- ⚠ The test leads, the measurement accessories and the mains plug may only be touched at the handle section provided. Direct contact of measurement ports or test probes must be avoided.
- 👉 Avoid any heating up of the instrument by direct sunlight to ensure perfect functioning and long instrument life.

3.1 Appropriate Usage

- ⚠ The instrument may only be used under those conditions and for those purposes for which it was built.
- ⚠ When modifying or changing the instrument, the operational safety is no longer guaranteed.
- ⚠ The opening of the instrument for fuse replacement, for example, may only be carried out by professionals. Prior to opening, the instrument has to be switched off and disconnected from any voltages.
- 👉 Any maintenance and calibration tasks may only be carried out by our repair service staff.
- ⚠ The instrument may not be operated if the battery case is open.
- 👉 If the instrument is subjected to an extremely high electro-magnetic field, its functioning ability may be impaired.

4.0 Display and Control Elements

4.1 Display (see also chapter 7.0)

- 1) Attention, warning symbol
- 2) AC voltage / DC voltage
- 3) Exceeding the threshold
- 4) Exceeding the Contact voltage threshold
- 5) External voltage / extraneous voltage present
- 6) Socket error
- 7) Turn socket by 180°
- 8) Battery status indication
- 9) Unit indication
- 10) Selective RCD has been chosen
- 11) Contact voltage threshold
- 12) Measurement value indication, large resultfield
- 13) Unit indication, small resultfield
- 14) Measurement value indication, small resultfield
- 15) Current factor display for IΔN when performing RCD checks
- 16) Small result field shows pre-selected IΔN when performing RCD checks
- 17) Symbol for memory entry
- 18) Symbol for compensating test lead resistance
- 19) Ramp function (trip current)
- 20) Exceeding temperature limit, instrument overheating

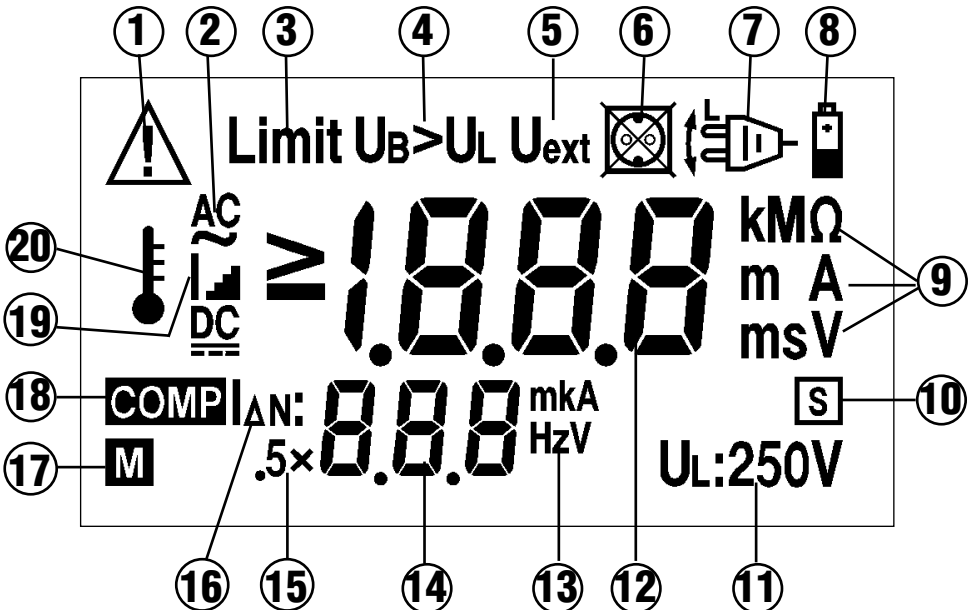

Operation Elements

4.2 Operation Elements

- 21) Display key to select individual measurement results
- 22) V_{INS} , $I_{\Delta N}$ key: select one lower insulation test voltage or $I_{\Delta N}$. Low Ω : start / switch off compensation.
- 23) V_{INS} , $I_{\Delta N}$ key : select one higher insulation test voltage or I_{dn} .
- 24) VL key (contact voltage threshold)
- 25) PE contact electrode
- 26) Start key
- 27) Store key
- 28) Send key
- 29) Clear key
- 30) IR-RS232 PC interface
- 31) Print key
- 32) Measurement range selection switch.

Plastic holster (not shown in picture)

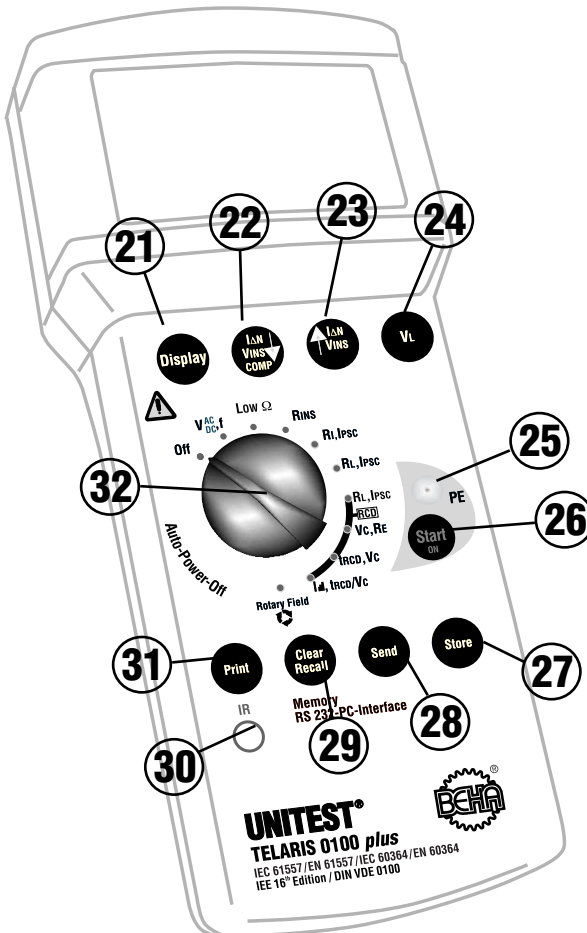

- 33) Connection Socket L - L1
- 34) Connection Socket N - L2
- 35) Connection Socket PE - L3

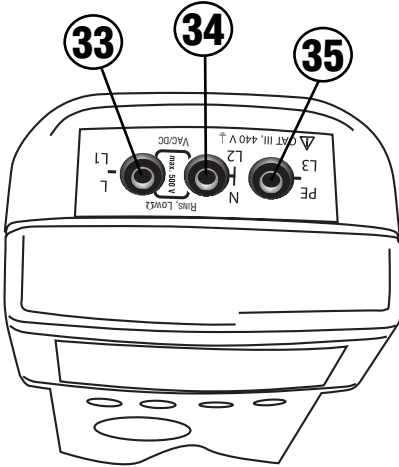

Acoustic Signals

Confirmation Signal:

The confirmation signal is a short beep which is audible once an important procedure is started (e.g. start of measurement, data memorisation or deleting)

Error Signal:

The error signal is a sequence of two short beep sounds. It indicates either errors occurring during the measurement or that the selected function may not be carried out.

5.0 Carrying out Measurements

- ☞ FAT (Final Approval Test) measurements have to be carried out in compliance with the appropriate applicable standards.

Voltage Measurement

5.1 Voltage Measurement

⚠ Never apply voltages exceeding 440V AC/DC to input sockets.

👉 The instrument is equipped with an integrated internal over voltage protection up to maximum 500 V AC/DC.

👉 When switching on or changing to VAC/DC measurement range, „AC" is automatically selected.

5.1.1 AC Voltage and Frequency Measurement

- ▶ Select measurement range „VAC/DC, f" by means of measurement range selection switch (32).
- ▶ Connect mains connection cable or test lead to the measurement instrument
- ▶ Now connect the mains connection cable or the L and N connections of the test leads to the UUT.

👉 For DC voltage measurements, the socket L1 polarity is positive (+), the L2 polarity is negative (-).

- ▶ Read measurement result on display.

👉 AC voltage is displayed in the large result field (12), frequency in the small result field (14).

⚠ If voltage exceeds 440V, „>440V" is displayed in the large result field. Should this occur disconnect the test instrument from the EUT immediately.

👉 If the frequency value is outside 10Hz ... 99,9Hz range, „---" is displayed in the small result-field. This indication is also displayed on the screen if the AC voltage is extremely low.

👉 Measurement results may be stored by pressing the „Store" (27) key.

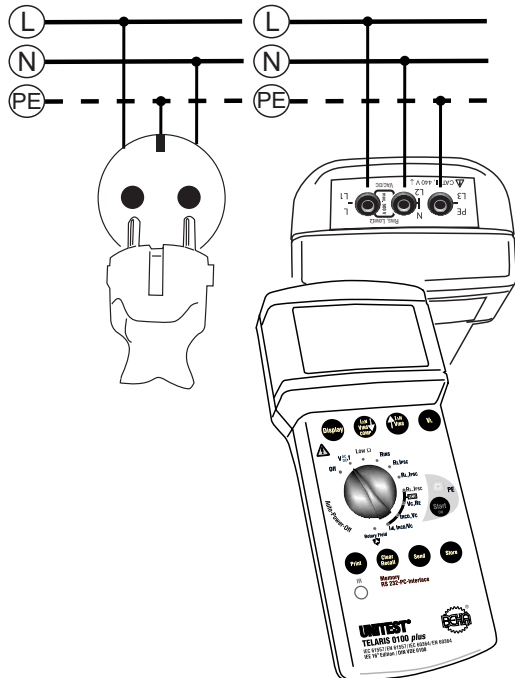

5.2 Low-Ohm Resistance Measurement

This measurement is used to check protective earth conductors, grounding conductors, and equipotential bonding conductors for low-impedance continuity. The resistance is determined by current/voltage measurement.

⚠️ Prior to any Resistance measurement, it must be guaranteed that no installation parts to be tested are live.

👉 Prior to any resistance measurement it is possible to compensate test lead resistance (please refer to chapter 5.2.1)

- ▶ Connect 2 test leads to the TELARIS 0100 plus (sockets L1 and L2).
- ▶ Plug test probes or crocodile clips onto the test leads and connect the test leads to the EUT.
- ▶ Set measurement range selection switch (32) to „LOW-Ω“ measurement range.

👉 If an external voltage is present, the instrument displays U_{ext} (5) and attention (1). The Low-Ohm resistance measurement is then blocked. The symbol „Uext“ (5) disappears if a second measurement is started without foreign voltage present.

- ▶ Press the "Start" (26) key. During the measurement the display shows "∞".
- ▶ Read measurement value on display.

👉 If „>1999 Ω“ appears on the display, the resistance is higher than 1999 Ohm.

👉 The polarity of the test current applied may influence the measurement result by means of galvanic elements within the EUT. For this reason always repeat the measurement with reversed polarity to compare the measurement results.

👉 The measurement results can be falsified by parallel connection of impedances of additional service circuits or by compensating currents.

👉 It is possible to store the measurement result by pressing „Store“ (27) key.

👉 The instrument automatically remains in continuous measurement mode when pressing the "Start" key (26). The measurement lasts until the "Start" key (26) is released again.

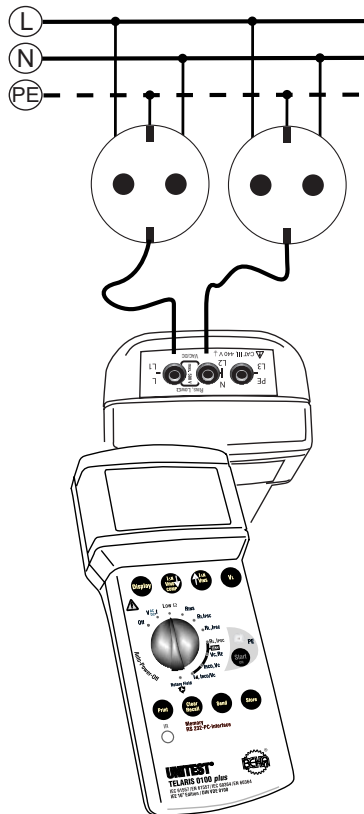

5.3 Insulation Measurement

For electrical installations the insulation measurement has to be carried out prior to final commissioning. This measurement is of basic importance as the insulation measurement is considered to be the only measurement for fire protection. If, due to an insulation error, a limited fault current flows between two conductors, this leads to a heating up or even to a fire. Only the insulation measurement procedure can detect such a fault.

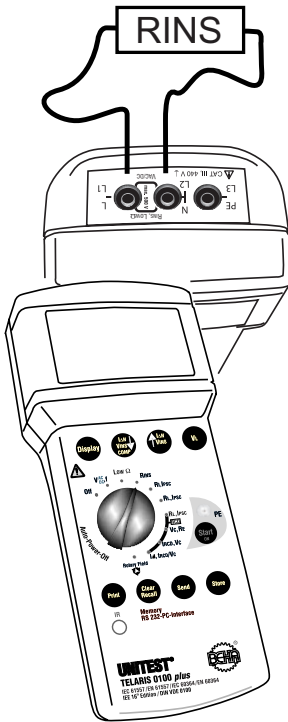

☞ If an external voltage is present, the instrument displays „Uext” and “attention” after the „Start” key has been pressed. The insulation measurement is then blocked. The symbol „Uext” (5) appears if a second measurement is started without an extraneous voltage present.

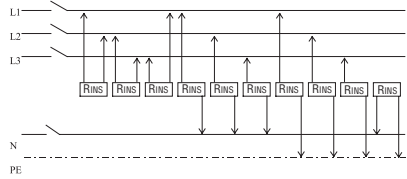

According to IEC 60364 (DIN VDE 0100 Part 610) the insulation resistance measurement is carried out:

- from all phase conductors (e.g. L1, L2, L3) towards earth or to protective earth (PE)
 - between protective earth (PE) and neutral (N)
- Additionally, it is advised to perform the following measurements:
- between all active conductors (e.g. L1, L2, L3, N).

This measurement must be carried out individually for each current circuit. The measurement is carried out a DC voltage of 100V, 250V or 500V.

The insulation resistance is determined by current/voltage measurement. The Telaris 0100 plus can perform an automatic measurement or a permanent measurement. The measurement duration is dynamic for automatic measurements.

The measurement lasts until measurement value stabilisation, however a maximum of 10s. Thus, the correct measurement result is determined for less capacitive loads within a very short time period and the battery life is increased.

⚠ During insulation measurement, ensure that all loads are disconnected from the mains and it must be ensured that all current circuits are switched on.

⚠ Prior to any insulation measurement, it must be guaranteed that no installation parts to be tested are live.

Insulation Measurement

 During insulation measurements, the measurement voltage charges capacitive UUTs. The UNITEST TELARIS 0100 plus automatically discharges the UUT after completion of the measurement. When interrupting the measurement or when removing the test leads prior to test termination, a dangerous voltage may be present at the UUT. If a dangerous voltage is detected during voltage measurement, the UUT must be manually discharged using a high impedance resistance (not via short-circuit!).

 During the measurement, the operator may not touch the UUT/the installation being tested, danger of electrical shock!

 If UUTs of higher capacitance's are tested (e.g. long cables or conductors), the automatic discharge may take longer.

▶ Connect 2 test leads to the TELARIS 0100 plus (sockets L1 and L2).

▶ Only Connect both ends to the UUT by using alligator clips.

 The PE connection should not be connected; otherwise, the TELARIS 0100 plus cannot perform correct measurements and displays 0.00 M Ω .

▶ Select insulation resistance measurement range (RINS) via the rotary switch.

▶ Select the desired test voltage (100V / 250V / 500V) by means of 'VINS ▲' (22) or 'VINS ▼' (23) keys.

▶ To start automatic measurements, briefly press the "Start" key (26)

 If the automatic measurement takes a long time (approx. 10s), then the UUT has a high capacitance value. In this case, you should carry out a continuous measurement, as the automatic measurement should be interrupted after 10s. Possibly, the correct final value has not yet stabilised.

 During the measurement, the instrument continuously shows the nominal voltage (500 V) of the insulation measurement function in the lower display part.

▶ Read the measurement value on the display.

 If „>199.9 M Ω “ appears on the display, a particularly good insulation resistance has been measured.

 It is possible to store the measurement result by pressing the „Store“ (27) key.

 You may even enter continuous measurement if the instrument program is set to automatic measurement by pressing the "Start" key (26) and keeping it depressed. The measurement lasts until the "Start" key (26) is released again. Even during automatic measurement you may enter continuous measurement mode when pressing the 'Start' key (26) and keeping it depressed.

 During the measurement process, intermediate results are displayed. The continuous measurement should be carried out until final measurement value stabilisation.

Mains Internal Resistance Measurement / Short Circuit Current Measurement

5.4 Mains Internal Resistance Measurement / Short Circuit Current Measurement

The mains internal resistance is determined by applying a brief mains load using a large current. This measurement is not required by DIN VDE [German Standard], however it is considered as important and valuable support in practical applications e.g. for evaluating an installation as well as for trouble shooting.

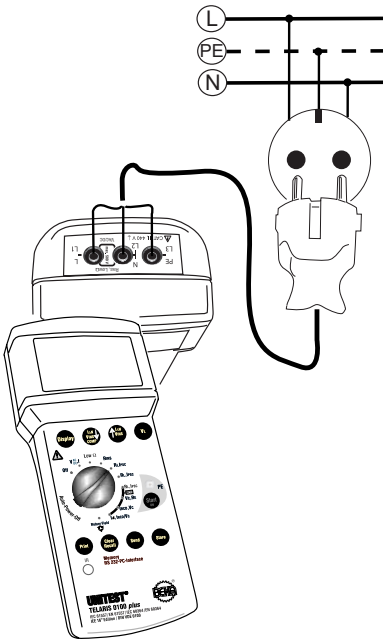

Terms:

Loop Impedance (ZL):

Sum of impedance values within a current loop (between the L and PE conductor).

Internal Resistance (RI):

Sum of resistance values within a current loop (between the L and N conductor).

RL: Phase resistance

RPE: Protective conductor resistance

RN: Neutral conductor

RE: Earth-Resistance

Short-Circuit Current (IPSC):

Occurring current flow in the event of short circuit.

☞ This measurement can be used in installations (TN systems) equipped with RCDs to detect any exchange of the PE and the neutral conductor (N) without opening within the divider. Any faulty connection results in RCD tripping when measuring the mains internal resistance.

☞ Furthermore, this measurement may be used to prove the low impedance of the neutral conductor (N).

⚠ To obtain fairly precise measurement results, it is advised to switch off all loads or to disconnect them from the mains and to ensure that the UUT is faultfree.

- ▶ Connect the 'Schuko-Plug – Measurement Plug' measurement adapter to the Telaris 0100 plus, by plugging the measurement plug labelled with L, N, PE into the respective sockets: L (33), N (34), and PE (35).

Mains Internal Resistance Measurement / Short Circuit Current Measurement

- ▶ Plug the plug into the socket under test.

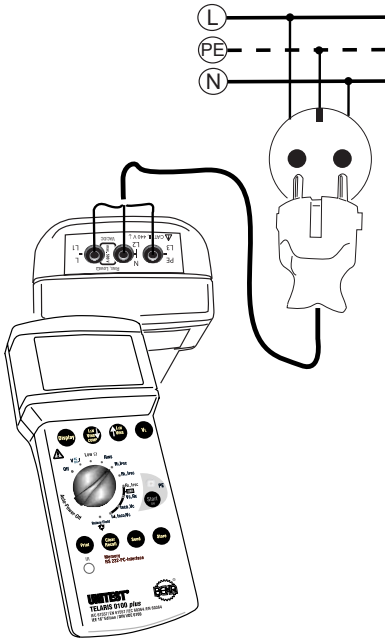

- ▶ Select the Mains Internal Resistance function (RI, IK) using the "Measurement Function" rotary dial (32).
- ▶ Select the contact voltage limit by pressing the 'VL' key (24).

👉 The socket is continuously checked for faults. If the "turn plug by 180°" symbol (7) is displayed on the screen, you are advised to either turn the Schuko-plug or the exchange the L and N connectors at the instrument.

👉 If the symbol for socket error (6) is displayed on the screen, we are dealing with a socket wiring error. If a voltage exceeding the pre-selected contact voltage limit is present between N and PE, 'UB>UL' (4) is displayed on the screen.

⚠ To perform a complete socket test, touch the contact electrode PE (25) and observe the displayed values on the screen. A valid result may only be achieved when touching the contact electrode PE (25)!

⚠ You are dealing with a PE error, if the error signal is audible and the 'Attention' symbol (1), and 'Socket Error' symbol (6) are displayed. I.e., either the PE is not connected or a high voltage (phase) is present at PE.

👉 The measurement may only be started if the socket is not faulty and if the measurement adapter has been connected by respecting correct polarity.

- ▶ Press the "Start" key (26) to start the measurement. During the measurement ' - ' is displayed on the screen.

- ▶ Read the measurement result displayed on the screen. The mains internal resistance is displayed in the large result field (12). The short-circuit current IPSC is displayed in the small result field (14).

Mains Internal Resistance Measurement / Short Circuit Current Measurement

- ☞ If the resistance measured exceeds 1999 Ω , the attention symbol (1) and '>1999 Ω ' are displayed on the screen. As there is no valid measurement value for RI, it is not possible to calculate and display the short-circuit current IK. '---' is displayed in the small result field (14).
- ☞ The short-circuit current is calculated using the mains voltage and the loop impedance. Here, the value 230V/400V is used for the mains voltage if it amounts close to 230V / 400V. If the measurement value deviates considerably from 230V / 400V, the actual measurement value is used to calculate the short-circuit current.
- ☞ Supply system preloading and voltage fluctuations can lead to erroneous measurement results. Therefore, you are advised to perform several measurements and to compare the measurement results.
- ☞ If many measurements are performed allowing only "short breaks", the internal over temperature protection of the Telaris 0100 plus is triggered and the symbol for excessive temperature (20) is displayed on the screen. The following mains internal resistance measurement may only be started once the instrument has cooled down and the symbol (20) has disappeared from the screen. Thus, any damage to the instrument can be avoided.
- ☞ You may store the measurement result by pressing the 'Store' key (27).
- ☞ If you wish to store the condition of a faulty socket, please press the "Start" key (26) first. After hearing the "Error Signal" you may press the "Store" key (27).
- ☞ **Measurements within the three-phase system:** when measuring the internal resistance within a three-phase system, you must connect L1 (33) and L2 (34) to the phases to be tested. You may not connect L3 (35). The socket test does not make sense for the internal resistance measurement between two phases. Therefore, the contact electrode (25) should not be touched. When touching the contact electrode, a PE error is indicated.

5.5 Loop Impedance Measurement / Prospective Short-Circuit Current Measurement

The loop impedance (L-PE / loop impedance) is understood as the sum of all resistance values within a current loop, consisting of the resistors of the current source, the external conductor of the current source up to the measurement point and the return line (PE conductor) and the other current source pole. The measurement determines the loop impedance between the external conductor and the PE conductor. The loop impedance value is measured by short-term mains loading. With the instrument the TELARIS 0100 plus, short-circuit current is determined by calculation.

The short-circuit current must be known such that an excess current release having been switched in series can trigger at an appropriate current level and thus at sufficient speed in the event of a short-circuit.

- ⚠ This measurement is used to perform the loop impedance measurement within current circuits which are not equipped with an RCD. If this measurement is started in correct circuits equipped with RCDs, the RCD will trip!
- ⚠ To obtain precise measurement results, switch off all loads or disconnect them from the mains.
- ⚠ To obtain fairly precise measurement results, switch off all loads or disconnect them from the mains. Ensure that the UUT is faultfree.
- ⚠ Only the calibrated test lead which are in scope of supply must be used!
- ▶ Connect the 'Schuko-Plug - Measurement Plug' mains adapter to the Telaris 0100 plus, by inserting the measurement plugs labelled with L, N, PE into the respective sockets L (33), N (34), and PE (35).

- ▶ Connect the mains to the socket plug by respecting the correct polarity.
- ▶ Select measurement range („ZL, IPSC“) by means of the measurement range selection switch (32).
- ▶ Select the contact voltage limit by pressing the 'VL' key (24).

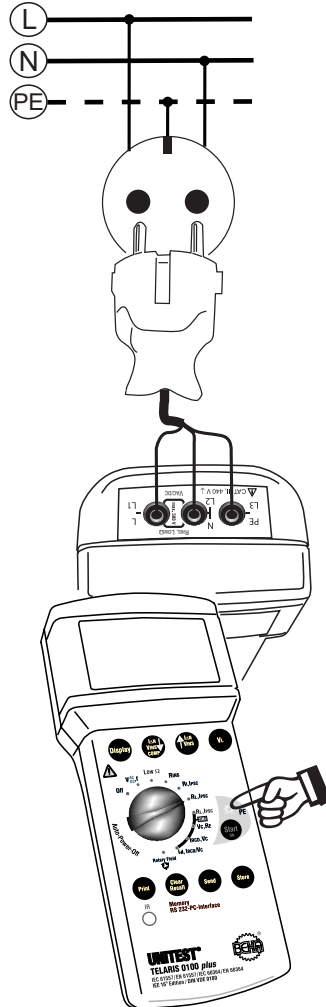

Loop Impedance Measurement / Prospektive Short-Circuit Current Measurement

- ☞ If symbol „turn plug by 180°“ (7) appears, turn the mains plug by 180° and connect to the socket or exchange the N and L connectors at the test instrument.
- ☞ If the symbol for socket error (6) is displayed on the screen, an error within the mains has occurred. If a voltage is present between N and PE exceeding the pre-selected contact voltage limit (50V/25V), "UB>UL" is displayed on the screen (4).
- ⚠ To perform a complete socket test touch the contact electrode PE (25) and observe the display on the screen. You may only achieve a valid result when touching the contact electrode PE (25)!
- ⚠ If the error signal is audible and the 'Attention' (1) and 'Socket Error' (6) symbols are displayed on the screen, we are dealing with a PE error. I.e., either the PE is not connected or a high voltage (phase) is present at PE.
- ☞ The measurement may only be started if the socket is faultfree and the measurement adapter has been connected by respecting correct polarity.
- ▶ Press the "Start" key (26) to start the measurement. During the measurement ' - ' is displayed on the screen.
- ▶ Read the measurement result displayed on the screen. The loop resistance is displayed on the large result field (12), the short-circuit current IPSC is displayed on the small result field (14).
- ☞ If the resistance measured is larger than 1999Ω The attention symbol (1) and '>1999Ω' are displayed on the screen. As there is no valid measurement value for RS, the short-circuit current IPSC cannot be calculated and displayed. '---' appears on the small result field (14).
- ☞ The short-circuit current is calculated using the mains voltage and the loop resistance. For this, the value 230V is used as mains voltage if the actual mains voltage amounts to approx. 230V. If the measurement value differs considerably from 230V, the actual measurement value is used for short-circuit current calculation.
- ☞ Supply system preloading and voltage fluctuations can lead to erroneous measurement results. Therefore, you are advised to perform several measurements and to compare the measurement results
- ☞ If several measurements are carried out, interrupted only by „short“ breaks, the internal over-temperature protection of TELARIS 0100 plus is triggered and the symbol for overtemperature (20) appears on the display. The next loop impedance measurement can only be started, once the instrument has cooled down and after the symbol (20) has gone out. Instrument damage is therefore avoided..
- ☞ Measurement results can be saved by pressing key „Store“ (27).
- ☞ If the user wishes to save the condition information of a faulty socket, first press the "Start" key (26). After hearing the "error signal", the "Store" key (27) can be pressed.

Loop Impedance Measurement without RCD Tripping

5.6 Loop Impedance Measurement without RCD Tripping

This measurement is used for loop measurement within current circuits equipped with RCDs without causing the RCD to trip during the measurement.

⚠ To obtain precise measurement results, switch off all loads or disconnect them from the mains.

- ▶ Connect the 'Schuko-Plug-Measurement Plug' measurement adapter to the Telaris 0100 plus, by inserting the measurement plug labelled with L, N, PE into the respective sockets: L (33), N (34), and PE (35).

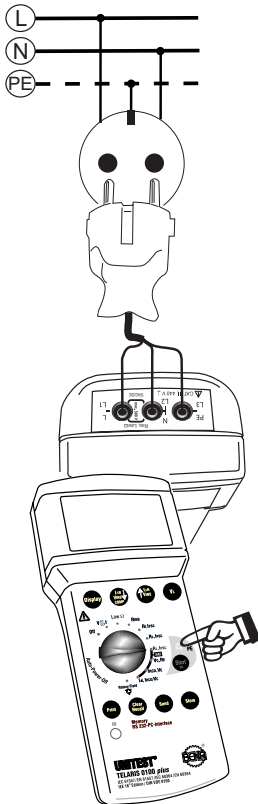

- ▶ Plug the Schuko-plug into the socket under test.
- ▶ Select measurement range („ZL, IPSC/RCD“) by means of the measurement range selection switch (32).
- ▶ Select contact voltage threshold by means of the key „VC“ (24).
- 🔊 The socket is continuously checked for faults. If the "turn plug by 180°" symbol (7) is displayed on the screen, you are advised to either turn the Schuko-plug or to exchange the L and N connectors at the instrument.
- 🔊 If the symbol for socket error (6) is displayed on the screen, we are dealing with a socket wiring error. If a voltage exceeding the pre-selected contact voltage limit is present between N and PE, 'UB>UL' (4) is displayed on the screen.
- ⚠ To perform a complete socket test, touch the contact electrode PE (25) and observe the displayed values on the screen. A valid result may only be achieved when touching the contact electrode PE (25)!
- ⚠ You are dealing with a PE error, if the error signal is audible and the 'Attention' symbol (1), and 'Socket Error' (6) are displayed. I.e., either the PE is not connected or a high voltage (phase) is present at PE.
- 🔊 The measurement may only be started if the socket is not faulty and the measurement adapter has been connected by respecting correct polarity.
- ▶ Press the "Start" key (26) to start the measurement. During the measurement ' - ' is displayed on the screen.

- ▶ Read the measurement result displayed on the screen. The loop resistance is displayed in the large result field (12). The short-circuit current Ik is displayed in the small result field (14).

☞ If the resistance measured exceeds $1999\ \Omega$, the attention symbol (1) and '>1999 Ω ' are displayed on the screen. As there is no valid measurement value for ZL, it is not possible to calculate and display the short-circuit current IK. '---' is displayed in the small result field (14)

☞ The short-circuit current is calculated using the mains voltage and the loop impedance. Here, the value 230V is used for the mains voltage if the mains voltage amounts close to 230V. If the measurement value deviates considerably from 230V, the actual measurement value is used to calculate the short-circuit current.

☞ Supply system preloading and voltage fluctuations can lead to erroneous measurement results. Therefore, you are advised to perform several measurements and to compare the measurement results.

☞ If many measurement are performed allowing only "short breaks", the internal over temperature protection of the Telaris 0100 plus is triggered and the symbol for excessive temperature (20) is displayed on the screen. The following mains internal resistance measurement may only be started once the instrument has cooled down and the symbol (20) has disappeared from the screen. Thus, any damage to the instrument can be avoided.

☞ You may store the measurement result by pressing the 'Store' key (27).

☞ If you wish to store the condition of a faulty socket, please press the "Start" key (26) first. After hearing the "Error Signal" you may press the "Store" key (27).

5.7 General Information about RCD Tests

The contact voltage U_B and the trip time t required by the RCD to disconnect the subsequent current circuit from the mains represent important measurement units for the assessment of an RCD.

For this reason, IEC 60364 prescribes that

a) the maximum allowable value for the contact voltage (25V/50V) may not be exceeded within any system during tripping at nominal residual current.

b) the RCD must trip within a time limit of 300ms.

The task of an residual current device (RCD) consists in switching off a system within a defined time period after an error prior the contact voltage reaches the permissible limit value of 25V / 50V.

The system testing should be started by carrying out a visual inspection, in particular of the protective earth connection.

1. Within the IT system, the protective earth conductor does not have to be connected with the PEN but with the protective earth connection.
2. The protective earth conductor must be connected to the PEN prior to the RCD within the TN system.
3. An insulation measurement as described in Section 5.3 must be performed. In particular it must be proofed, that there is no connection between N and PE following the RCD.
4. Proof regarding the low impedance connection of equipotential bonding conductors in compliance with Section 5.2 must be available.

RCD – Measurement of Contact Voltage UB

- 🗨️ Time-delayed residual current devices trip at nominal residual current within 130...500ms, for double nominal fault current within 60...200 ms. Such RCDs are implemented as main residual current protection devices (please refer to IEC 61008-1) and are marked with the symbol .
- 🗨️ The contact voltage represents the voltage present during an insulation error between two simultaneously touchable components.
- ⚠️ At a measuring circuit without probe, available voltages between PE and earth can influence the measurement.
- ⚠️ At use of the N-conductor as probe, the N-conductor should be checked first for all of correct and low-ohm connection to neutral point of system. An available voltage of the N conductor to the earth can influence the measurement.
- ⚠️ Leakage currents by preconnected loads can influence the measuring.
- ⚠️ Attached loads or operating supplies which contains capacitors or circulating machines can elongate the trip time.
- ⚠️ Any test and measurement procedures in circuits equipped with residual current devices should only be performed after having consulted the operator terminals (data processing systems, material processing, motors, etc.).
- ⚠️ For measurements on earthed sockets or equipment with protective conductor connection, the protective earth must be checked for correct connection by touching contact electrode "PE". If an error is indicated via the socket error symbol (6), the PE connection must be checked! The user may only start the test, once the protective conductor is properly connected.

- 🗨️ Prior to testing, we recommend all loads are switched off as they could falsify the measurement result.
- 🗨️ The protective earth must be free of external voltage for the RCD test. However if an extraneous voltage is present, the instrument only indicates the voltage VC having been generated by the measurement. The measurement interruption caused by excess of VL by VC is only generated by the actual voltage present between the neutral conductor (N) and the protective earth (PE).

5.7.1 RCD – Measurement of Contact

Voltage UB and the Earthing Resistance

RE without RCD Tripping

The instrument UNITEST TELARIS 0100 plus offers the facility to test contact voltage or the earthing resistance with reference to the nominal current of the RCD within supply systems equipped with RCDs without causing the RCD to trip. The contact voltage measurement is performed at approximately 1/3 of the pre-selected nominal current. The measured contact voltage is then extrapolated to nominal trip current and finally displayed.

The contact voltage is determined by short-term mains loading, the measurement current flows within the PE and L conductors.

- ⚠️ To achieve a precise measurement result, we advise to switch off all loads or to disconnect them from the mains, and to ensure that the UUT is faultfree.
- ⚠️ Leakage currents within the current circuit following the residual current circuit breaker may falsify the measurement, like any possible voltage present between PE and ground, and any possible voltage present between neutral conductor and ground.

RCD – Measurement of Contact Voltage UB

⚠ Prior to performing the measurement, check the connection of the neutral conductor between the mains neutral point and the earth.

👉 The contact voltage only refers to the contact voltage generated by the measurement and not to the actual contact voltage present.

- ▶ Connect the "Schuko-plug Measurement Plug" mains adapter to the Telaris 0100 plus, by inserting the measurement plugs labelled with L, N, PE into the respective sockets L (33), N (34), and PE (35).

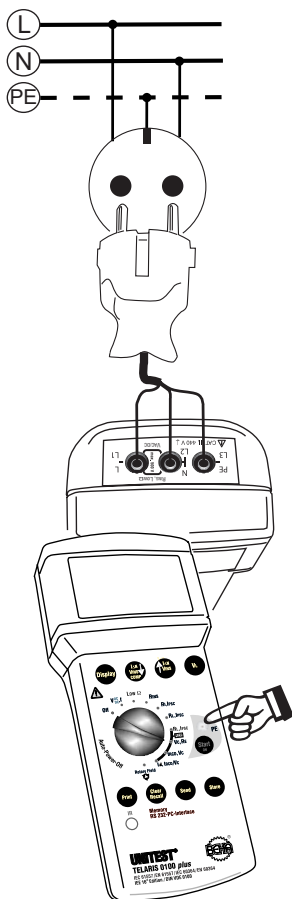

- ▶ Plug the Schuko-plug into the socket under test.

▶ Select the contact voltage measurement function (UB/RE [RCD/FI]) by means of the rotary dial (32).

▶ Select the nominal current of the installed RCD using the 'IΔN ▲' (22) and 'IΔN ▼' keys (23).

👉 The following nominal trip currents are available: 10mA, 30mA, 100mA, 300mA, 500mA, selective 100mA, selective 300mA, and selective 500mA.

▶ Select the contact voltage limit by pressing the 'VL' key (24).

👉 The socket is continuously tested for perfect functioning. If the display indicates the symbol „Turn plug by 180°“, turn the plug by 180° or the connection N and L of the instrument must be exchanged.

👉 If the symbol for socket error (6) is displayed on the screen, we are dealing with a socket wiring error. If a voltage exceeding the preselected contact voltage limit is present between N and PE, 'UB>UL' (4) is displayed on the screen.

⚠ To perform a complete socket test, touch the contact electrode PE (25) and observe the displayed values on the screen. A valid result may only be achieved when touching the contact electrode PE (25)!

⚠ You are dealing with a PE error, if the error signal is audible and the 'Attention' symbol (1), and 'Socket Error' (6) are displayed. I.e., either the PE is not connected or a high voltage (phase) is present at PE.

RCD Trip Time Test, Contact Voltage (ta, UB / RE)

- 🔊 The measurement may only be started if the socket is not faulty and the measurement adapter has been connected by respecting correct polarity.
- ▶ Press the "Start" key (26) to start the measurement. During the measurement ' - ' is displayed on the screen.
- 🔊 If the RCD trips during the measurement, the attention symbol (1) is then illuminated as well as the symbol for socket error (6). In this instance, please check if the correct nominal trip current has been selected. Possibly, the current preload of the PE is at such a high level that the RCD trips orderly caused by the test, or the RCD itself might even be faulty.
- 🔊 If the contact voltage measured exceeds the 50 V or 100 V measurement range, the attention symbol (1) and '>50V' or '>100V' are displayed on the screen.
- 🔊 The short-circuit current is calculated using the contact voltage and the selected nominal trip current of the RCD.
- 🔊 Supply system preloading and voltage fluctuations can lead to erroneous measurement results. Therefore, you are advised to perform several measurements and to compare the measurement results
- 🔊 If many measurement are performed allowing only "short breaks", the internal over temperature protection of the Telaris 0100 plus is triggered and the symbol for excessive temperature (20) is displayed on the screen. The following measurement may only be started once the instrument has cooled down and the symbol (20) has disappeared from the screen. Thus, any damage to the instrument can be avoided.
- 🔊 You may store the measurement result by pressing the 'Store' key (27).

- 🔊 If you wish to store the condition of a faulty socket, please press the "Start" key (26) first. After hearing the "Error Signal" you may press the "Store" key (27).

5.7.2 RCD Trip Time Test, Contact Voltage (ta, UB / RE)

This test is used to check the trip time of standard and selective RCDs. Additionally, the contact voltage (UB) generated during the test is measured. This RCD test is divided into two tests: the preliminary test is performed at 1/3 I Δ N, the RCD not trip. The contact voltage UB is measured during this preliminary test and extrapolated to the nominal trip current I Δ N (or 2 I Δ N for selective RCDs). During the main test, the selected nominal trip current (I Δ N or 2 I Δ N) flows. The RCD must trip.

⚠ To obtain a precise measurement result, we advise to switch off all loads or to disconnect them from the mains.

- ▶ Connect the 'Schuko-Plug–Measurement Plug' measurement adapter to the Telaris 0100 plus, by inserting the measurement plugs labelled L, N, PE into the respective sockets: L (33), N (34), and PE (35).
- ▶ Plug the Schuko-plug into the socket under test.
- ▶ Select the trip time measurement (tA/UB [RCD]) using the "Measurement Function" rotary dial (32)..
- ▶ Select the nominal current of the installed RCD using the 'I Δ N ▲' (22) and 'I Δ N ▼' (23) keys.

RCD Trip Time Test, Contact Voltage (ta, UB / RE)

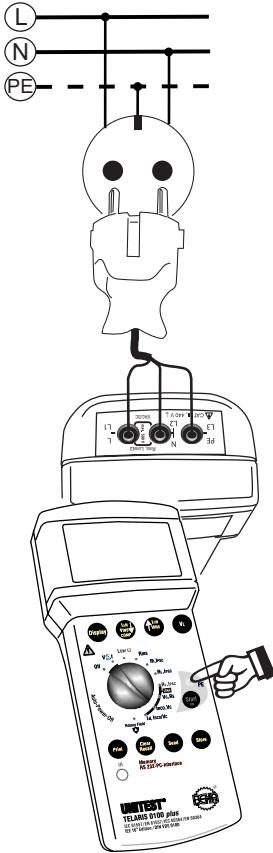

☞ The following nominal trip currents are available: 10mA, 30mA, 0.5x 30mA, 5x 30mA, 100mA, 300mA, 500mA, selective 100mA, selective 300mA, and selective 500mA.

▶ Select the contact voltage limit by pressing the 'VL' (24) key.

☞ The socket is continuously checked for faults. If the "turn plug by 180°" symbol (7) is displayed on the screen, you are advised to either turn the Schuko-plug or the exchange the 'L' and 'N' connectors at the instrument.

☞ If the symbol for socket error (6) is displayed on the screen, we are dealing with a socket wiring error. If a voltage exceeding the preselected contact voltage limit is present between N and PE, 'UB>UL' (4) is displayed on the screen

⚠ To perform a complete socket test, touch the contact electrode PE (25) and observe the displayed values on the screen. A valid result may only be achieved when touching the contact electrode PE (25)!

⚠ You are dealing with a PE error, if the error signal is audible and the 'Attention' symbol (1), and 'Socket Error' (6) are displayed. I.e., either the PE is not connected or a high voltage (phase) is present at PE.

☞ The measurement may only be started if the socket is not faulty and the measurement adapter has been connected by respecting correct polarity.

☞ When testing a selective RCD a waiting time of 30s is respected between preliminary test and main test. The remaining waiting time is continuously displayed on the screen. You may interrupt the test by turning the rotary dial.

▶ Press the "Start" key (26) to start the measurement. During the measurement ' - ' is displayed on the screen.

☞ If a contact voltage UB is generated between conductors N and PE exceeding the pre-selected contact voltage limit VL, the measurement is interrupted and the 'Attention' (1), 'UB>UL' (4) symbols are displayed on the screen.

RCD Trip Time Test, Contact Voltage (ta, UB / RE)

 If the contact voltage measured exceeds the 50V or 100V measurement range, the attention symbol (1) and '>50V' or '>100V' are displayed on the screen.

The trip time t_A is displayed in the large result field (12). The measured contact voltage may be called for display by pressing the 'display' key (21).

 If the RCD trips during the measurement, the symbol for socket error (6) is displayed. If the RCD already trips during the preliminary test, the "Attention" symbol (1) is displayed, in addition. In this instance, please check whether the correct nominal trip current has been selected. Possibly, the current preload of the PE is at such a high level that the RCD trips orderly caused by the test, or the RCD itself might even be faulty.

 If the trip time t_A is not within the admissible range (standard RCD: $A < 300\text{ms}$; selective RCD: $60\text{ms} < t_A < 200\text{ms}$), the 'Attention' symbol (1) is displayed and the symbol for 'Limit Value exceeded' (3) appears to indicate the trip time. The test time is set to respectively 500ms.

Two additional test currents are integrated as special options for the RCD with a nominal current of 30mA and may be selected using the ' $I_{\Delta N} \blacktriangledown$ ' (22) and ' $I_{\Delta N} \blacktriangle$ ' (23) keys:

- a) 0.5x 30mA (=15mA). The test time is set to 2s, the RCD may not trip.
- b) 5x 30mA (=150mA). The test time is set to 50ms, the RCD must trip within 40 ms.

 Failure for RCD tripping could be a wrong setting of the nominal current or a faulty RCD.

 Supply system preloading and voltage fluctuations can lead to erroneous measurement results. Therefore, you are advised to perform several measurements and to compare the measurement results.

 If many measurement are performed allowing only "short breaks", the internal over temperature protection of the Telaris 0100 plus is triggered and the symbol for excessive temperature (20) is displayed on the screen. The following measurement may only be started once the instrument has cooled down and the symbol (20) has disappeared from the screen. Thus any damage to the instrument can be avoided.

 You may store the measurement result by pressing the 'Store' key (27).

 If you wish to store the condition of a faulty socket, please press the "Start" key (26) first. After hearing the "Error Signal" you may press the "Store" key (27).

RCD Test with Rising Residual Current (Ramp Method), Trip Current ($I_{\Delta n}$), ta/VC

5.7.3 RCD Test with Rising Residual Current

(Ramp Method), Trip Current

($I_{\Delta n}$), ta/VC

For this test, the trip current $I_{\Delta n}$ of the RCD is measured. The contact voltage VC is measured during the preliminary test at a current of $1/3 I_{\Delta n}$. The RCD test is resumed after the successful preliminary test at a residual current, rising in steps of 10 % from 40 % $I_{\Delta n}$ until maximum 140 % $I_{\Delta n}$. The presently active residual current is indicated on the display and in the event of the RCD tripping the trip time of the RCD is measured. The contact voltage VC is evaluated for the trip current $I_{\Delta n}$.

⚠ To obtain a precise measurement result, we advise to switch off all loads or to disconnect them from the mains.

- ▶ Connect the 'Schuko-Plug–Measurement Plug' measurement adapter to the Telaris 0100 plus, by inserting the measurement plugs labelled L, N, PE into the respective sockets: L (33), N (34), and PE (35).
- ▶ Connect mains plug or test lead to UUT, respecting correct polarity.
- ▶ Select the trip time measurement (IR, tA/UB [RCD]) using the "Measurement Function" rotary dial (32).
- ▶ Select the nominal current of the installed RCD using the ' $I_{\Delta n}$ ▲' (22) and ' $I_{\Delta n}$ ▼' (23) keys.

📖 The following nominal trip currents are available: 10mA, 30mA, 100mA, 300mA, and 500mA.

- ▶ Select the contact voltage limit by pressing the 'VL' (24) key.

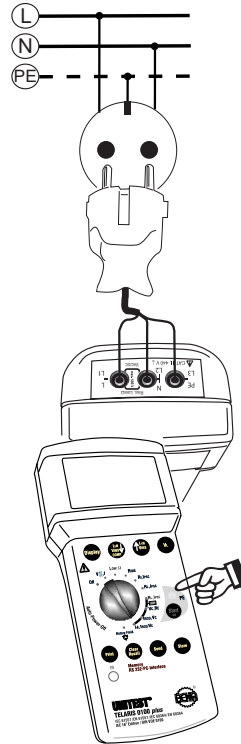



👉 The socket is continuously checked for faults. If the "turn plug by 180°" symbol (7) is displayed on the screen, you are advised to either turn the Schuko-plug or the exchange the L and N connectors at the instrument.

👉 If the socket symbol (6) is displayed, a mains error is present. If the voltage present between N and PE exceeds the preselected contact voltage limit (50V/25V), „UB>UL" (4) is displayed.

⚠ To perform a complete socket test, touch the contact electrode PE (23) and observe the displayed values on the screen. If the symbol "socket error" (6) occurs, a PE error is present.

RCD Test with Rising Residual Current (Ramp Method), Trip Current ($I_{\Delta n}$, t_A/VC)

 You are dealing with a PE error, if the error signal is audible and the 'Attention' symbol (1), and 'Socket Error' (6) are displayed. I.e., either the PE is not connected or a high voltage (phase) is present at PE.

 The measurement may only be started if the socket is not faulty and the measurement adapter has been connected by respecting correct polarity.

▶ Press the "Start" key (26) to start the measurement. During the measurement ' - ' is displayed on the screen.

 If a contact voltage U_B is generated between conductors N and PE exceeding the pre-selected contact voltage limit VL, the measurement is interrupted and the 'Attention' (1), ' $U_B > U_L$ ' (4) symbols are displayed on the screen.

 If the contact voltage measured exceeds the 50V or 100V measurement range, the attention symbol (1) and '>50V' or '>100V' are displayed on the screen..

The trip time t_A is displayed in the large result field (12). The measured trip time t_A and the contact voltage with reference to the trip current may be called for display by pressing the 'display' key (21).

 If the RCD trips during the measurement, the symbol for socket error (6) is displayed. If the RCD already trips during the preliminary test, the "Attention" symbol (1) is displayed in addition. In this instance, please check whether the correct nominal trip current has been selected. Possibly, the current preload of the PE is at such a high level that the RCD trips correctly caused by the test, or the RCD itself might even be faulty.

 If the trip time t_A measured is not within the admissible range ($t_A < 300\text{ms}$; $50\% I_{\Delta n} \leq I_R \leq 100\% I_{\Delta n}$), the 'Attention' symbol (1) is displayed and for the display of the respective level the symbol for 'Limit Value exceeded' (3) appears. To make a safe decision whether the RCD is defective, a trip test should be performed at nominal trip current (t_A, U_B). For example, an RCD is in perfect condition when having a trip time $> 300\text{ms}$ at $60\% I_{\Delta n}$, and when testing at nominal trip current (at $100\% I_{\Delta n}$) showing however a trip time $< 300\text{ms}$.

 Failure for RCD tripping could be a wrong setting of the nominal current or a faulty RCD.

 Supply system preloading and voltage fluctuations can lead to erroneous measurement results. Therefore, you are advised to perform several measurements and to compare the measurement results.

 If many measurement are performed allowing only "short breaks", the internal over temperature protection of the Telaris 0100 plus is triggered and the symbol for excessive temperature (20) is displayed on the screen. The following mains internal resistance measurement may only be started once the instrument has cooled down and the symbol (20) has disappeared from the screen. Thus, any damage to the instrument can be avoided.

 You may store the measurement result by pressing the 'Store' key (27).

 If you wish to store the condition of a faulty socket, please press the "Start" key (26) first. After hearing the "Error Signal" you may press the "Store" key (27).

5.8 Rotary Field Test

The UNITEST Telaris 0100 plus allows to check the rotary field within systems of nominal user voltages of approx. 100 to 440V.

- ▶ Connect the test leads supplied with the Telaris 0100 plus, by inserting the measurement plugs labelled L1, L2, L3 into the respective sockets L1 (33), L2 (34), and L3 (35).
- ▶ Plug test probe or alligator clips onto the plugs of the test leads and connect to the socket or the connection field.
- ▶ Select the rotary field function using the rotary dial (32).

☞ Once the three test leads have been connected to the three phases L1, L2, and L3 and a rotary field is present, the instrument will display the respective rotary field:

1.2.3 for clockwise rotary field,
2.1.3 for anti-clockwise rotary field.

- ▶ In addition to the rotary field, display can be made of the external conductor voltages. For this, you have to press the 'Display (21) key (several times). Thus, the voltage for U₁₂ (for U[L1-L2]), U₂₃, and U₃₁ can be subsequently displayed.

☞ Correct display of the rotary field can only be performed if the ratio between maximum single conductor voltage and minimum single conductor voltage does not exceed 1.8. .

☞ Save the measurement result by pressing the 'Store' key (27).

☞ The external conductor voltages are not saved.

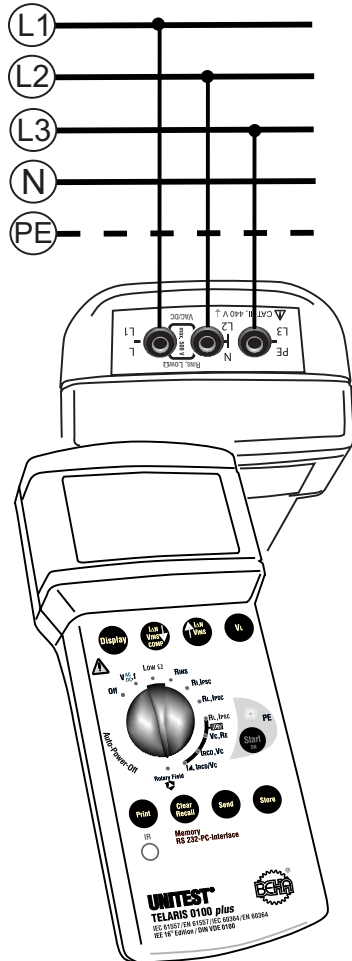

Storing, Printing and Data Transfer

6.0 Storing, Printing and Data Transfer

After a successful measurement, it is possible to save the measurement value by means of „Store“ key (27). Approximately 500 measurement values can be saved. Proceed as follows:

After the saving process, it is possible to view the last saved measurement result and to print a report containing the measurement results using the protocol printer (option Cat. No. 1196).

If desired, the data may be transferred via a serial interface to a PC for the reporting using the software es control 0100 (option Cat. No. 1251).

6.1 Storing Measurement Data

To save the measurement data, please proceed as follows:

- ▶ Perform a measurement.
- ▶ Store the measurement result by pressing the “Store” (27) key.
- ▶ After successful saving, a brief signal is audible and the symbol "M" (17) is displayed, followed by the brief display of the continuous memory location number.

If the memory is full and the key “Store” (27) is pressed, the symbol "M" (17) is briefly displayed and an error signal is audible.

 The saved data is kept in the memory even when the appliance is switched off.

It is not possible to save a measurement value twice!

 **Under certain unfavourable conditions, data may be lost or modified with any electronic memory. The company CH. BEHA GmbH will not be held responsible, neither for financial nor for any other losses caused by data loss, incorrect handling, or any other reason.**

 **We highly recommend to perform a daily measurement data transfer to a PC and to save the data. The measurement data within the measurement appliance might be lost by unforeseeable and exterior influences (drop, electro-magnetic influence, etc.).**

6.2 Viewing Measurement Data

Respectively, the last measurement value can be displayed.

To view measurement data, please proceed as follows:

- ▶ Briefly press the key “Clear/Recall” (29). The last memory location number is displayed.
- ▶ After this, the measurement data and the pre-selected limit values are displayed for approx. 2 seconds.

 Attention, extended pressing (longer than 2s) of the key “Clear/Recall” (29) causes the last measurement value to be deleted.

6.3 Printing Measurement Data

Saving after the measurement result, it is possible to print the data. For this, the UNITEST Protocol Printer (Cat. No. 1196) and the Interface Adapter (Cat. No. 1157) are required (option).

Selection can be made whether the last saved result, all results, or part of the results should be printed.

To print the measurement data, please proceed as follows:

- ▶ Perform the desired measurements and save these measurements by pressing the key "Store" (17), please refer to section 6.1.
 - ▶ Remove holster
 - ▶ Apply the TELARIS Interface Adapter (Cat. No. 1157) onto the TELARIS 0100 plus.
 - ▶ Connect the serial connection cable with the protocol printer.
 - ▶ Switch on the printer and set the interface parameter on the protocol printer in compliance with the TELARIS 0100 plus .
 - ▶ To print the last saved result, briefly press the "Print" key (31). "Prt" is displayed on the screen, the data is transmitted to the protocol printer.
- ▶ To print all memorised data, press the "Print" key (31) for a longer time (approx. 3 seconds). "Prt" is displayed on the screen, The data is transmitted to the protocol printer.

Now, all data is printed starting from the last memorised result. During printing, the currently printed memory address number is displayed

- ▶ The printout of all results can be cancelled at any time. This is done by pressing the "Print" key (31) again during the printing of the last requested data string. Keep the key pressed until the print job has been cancelled.

This function allows partial printing of data.

- ☞ It is important to observe the interface settings of the protocol printer and accordingly set the interface parameter of the TELARIS 0100 plus (9600 Baud, even parity, 8 data bit, 1 stop bit, 1 start bit, please refer to the technical data section). Please refer to the instruction manual supplied with the protocol printer (Cat. No. 1196) for printer parameter setting.

Deleting Saved Measurement Data/View the Memory Location Number

6.4 Deleting Saved Measurement

Data/View the Memory Location Number

It is possible to delete the last measurement value or all measurement values by pressing the key "Clear/Recall" (29).

6.4.1 Delete Last Saved Measurement Value:

- ▶ Press the key "Clear/Recall" (29) and keep it depressed.
- 🔊 An acoustic signal is audible and the last memory location number is briefly displayed.
- ▶ Now release the key "Clear/Recall" (29) to avoid deletion of the complete memory.
- 🔊 Deleting the last saved measurement value or last entered UUT number can be repeated as desired, i.e. as long as data is available within the memory.

6.5 Delete all Saved Measurement Values:

- ▶ Press the key "Clear/Recall" (29) for and keep it depressed for approx. 5 s
- ▶ An acoustic signal is audible and the last memory location number is briefly displayed. Afterwards, the measurement value or the UUT number saved at this memory location is displayed
- ▶ A beep signal is audible after 2 sec. and the last stored value is deleted.
- ▶ A beep signal is audible after 2 sec. and all stored values are deleted.
- ▶ "0" appears on the LC-display. The memory is completely deleted, the „M" symbol in the display disappears.













6.6 Infrared Interface, send Measurement Data

Additionally, all stored measurement data may be transferred to the PC (for reporting) by the Infrared Interface. For this purpose, the interface adapter and the Software "es control 0100" (Cat. No. 1251) and Interface (Cat. No. 1157), available as an optional feature, are required.



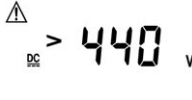
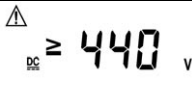

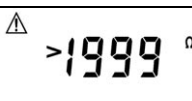













The data transfer procedure is a simple process:















- ▶ Carry out measurements and save these by pressing key "Store" (27), see also section 6.1.
- ▶ Remove holster
- ▶ Apply the Interface adapter (Cat. No. 1157) to TELARIS 0100 plus.
- ▶ Connect interface cable via 9pole D-sub connector to serial interface of PC (ie COM 1).
- ▶ Call the "es control 0100" Software (please refer to user manual "es control 0100").
- ▶ If PC is ready for receiving data, press the key Send (28)
- 🔊 Data transfer is carried out. After a succesful data transfer all stored data is available for further processing in the PC.

7.0 Displays / Error Messages

Functions	Message	Cause
All		Attention symbol for exceeding limit values
All		Batteries are virtually empty and have to be replaced. Measurement results no longer comply with the specifications.
All	 is blinking	Batteries are empty. No function of the Telaris
All		Minimum one measurement result has been stored in memory.
All Functions		TELARIS is ready for measurement.
All Functions		TELARIS is active (active measurement).
Vac		Overflow, voltage present exceeds 440 VAC
Vac		Frequency of AC voltage outside range 10.0 ... 99,9Hz
Vdc		Overflow, voltage present exceeds 440 VDC
Vdc		Overflow, voltage present falls below -440V DC
Rins		Insulation resistance exceeds or is greater than 199,99MΩ Selected voltage is 500V
Rins		Test leads are short circuited or PE test leads are connected to one of the other test leads Selected test voltage is 250 V
Low Ω		Low ohm resistance higher than 1999 Ohm
Low Ω		Test lead resistance has been compensated.
Rins Low Ω	 U_{ext}	External voltage present, measurement may not be carried out.

Displays / Error Messages

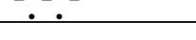
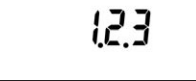
Function	Message	Cause
Rs, IPSC RI, IPSC	 >1999 Ω - - - U _L : 50V	Loop impedance is higher than 1999 Ohm
Rs, IPSC RI, IPSC	 U _e >U _L - - - U _L : 50V	Contact voltage has exceeded preset limit during the socket test. Measurement therefore not carried out, until instrument has been allowed to cool down.
Rs, IPSC RI, IPSC RCD	 	TELARIS 0100 is overheated, therefore no further measurements can be carried out.
Rs, IPSC RI, IPSC RCD		Socket incorrectly connected, or RCD has tripped. For correct measurement touch contact electrode
Rs, Ik; RI, IPSC; RCD Contact-electrode has touched	 	PE - Error
Rs, IPSC RI, IPSC RCD		Insert plug after turning it by 180°C or change L and N of test leads. For correct measurement touch contact electrode
RCD		Measurement of trip current, Display of trip current
RCD		Test of selective RCD's Test of selective RCD's
RCD	 Limit > 500 ms I _{ΔN} : 30 ^m A U _L : 50V	RCD has not tripped.
RCD	 Limit  > 500 ms I _{ΔN} : 30 ^m A U _L : 50V	Trip time exceeds 500ms
RCD	 Limit > 1999 ms I _{ΔN} : 5x 30 ^m A U _L : 50V	Trip time exceeds 1999 ms or RCD has not tripped (only at nominal fault current I _{ΔN} = 0.5 x 30 mA)
RCD	 Limit > 50 ms I _{ΔN} : 5x 30 ^m A U _L : 50V	Trip time exceeds 50 ms or RCD has not tripped (only at nominal fault current I _{ΔN} = 5 x 30 mA)
RCD	 Limit > 300 ms I _{ΔN} : 30 ^m A U _L : 50V	Trip time exceeds 300 ms or RCD has not tripped Measurement of trip time I _a
RCD	 Limit  19 ms I _{ΔN} : 100 ^m A U _L : 50V 	Selective RCD has tripped after 19 ms. RCD error, trip time is less than 60 ms

Function	Message	Cause
RCD	 <p>Limit   219 ms $I_{\Delta N}$: 100 mA $I_{\Delta N}$ U_L: 50 V</p>	Selective RCD has tripped at 219 ms. As trip time exceeds 200ms, the RCD has failed!
RCD	 <p>Limit   345 ms $I_{\Delta N}$: 30 mA $I_{\Delta N}$ U_L: 50 V</p>	RCD has tripped at 345 ms. As trip time exceeds 300ms, the RCD has failed!
RCD	 <p> $U_B > U_L$ 56 V $I_{\Delta N}$: 30 mA $I_{\Delta N}$ U_L: 50 V</p>	The contact voltage exceeded the pre-set limit Measurement therefore not carried out
RCD	 <p> $U_B > U_L$ > 100 V $I_{\Delta N}$: 30 mA $I_{\Delta N}$ U_L: 50 V</p>	The contact voltage exceeded the pre-set limit, more than 100 V. Measurement therefore not carried out
RCD	 <p> $U_B > U_L$ $---$ $I_{\Delta N}$: 30 mA $I_{\Delta N}$ U_L: 50 V</p>	The contact voltage exceeded the pre-set limit already during the socket test. Measurement therefore not carried out
Rotary field	 <p>$---$</p>	No rotary field is present or one voltage is out of specific. range
Rotary field	 <p>12.3</p>	Rotary field (right) is present at L1, L2, L3
Rotary field	 <p>2.13</p>	Rotary field (left) is present at L1, L2, L3

Energy Management /Maintenance/Battery Replacement

8.0 Energy Management

Approximately 5 minutes after the last key operation, the instrument switches off automatically (auto-power-off). To switch the instrument on again, turn the rotary switch from the „OFF" position to the desired function or press the key "Start" (26) again .

If the battery symbol (8) appears in the display the battery is low. The instrument might still function, however, without fulfilling the specifications. If the batteries are used further and discharged, the instrument will automatically switch off once the battery voltage falls below the minimum level. The battery symbol (8) will blink for several seconds. You cannot switch on the instrument with discharged batteries.

9.0 Maintenance

When using the instrument in compliance with the instruction manual, no special maintenance is required.

Should operational problems occur during daily use, our Hotline Support (phone 0049(0)7684/8009-29) will be at your disposal, free of charge. For any queries regarding the instrument, please always quote product designation and serial number, both marked on the typed shield label on the rear of the instrument.

If functional errors occur after expiration of warranty, our after sales service will repair your instrument without delay.

9.1 Cleaning

If the instrument is dirty after daily usage, it is advised to clean it by using a damp cloth and a mild household detergent.

⚠ Prior to cleaning, ensure that the instrument is switched off and disconnected from external voltage supply and any other instruments connected (such as EUT, control instruments, etc.).

⚠ Never use acid detergents or dissolvants for cleaning.

👉 Do not use the instrument after cleaning until it has completely dried off.

10.0 Battery Replacement

If the battery symbol (8) appears in the display, proceed with battery replacement.

⚠ Prior to storage battery replacement, disconnect the instrument from any connected test leads.

⚠ When replacing or changing the battery, make certain of correct polarity.

⚠ Reverse polarity of batteries may destroy the instrument. Furthermore, they may explode or ignite.

⚠ Only use batteries in compliance with the specifications in the technical data section 1,5V Mignon Typ IEC LR6 (size AA).

⚠ Never try to disassemble battery cells !The battery contains highly alkaline electrolyte. If electrolyte gets in contact with skin or clothing, rinse immediately with water. If electrolyte gets in contact with the eyes, immediately flush by using pure water and consult a doctor.

⚠ Never try to make contact between both battery cell poles, for example by using a wire connection. The resulting short-circuit current is very high and causes extreme heat. Danger of fire and explosion !

- ▶ Switch off the instrument via the rotary switch and disconnect the instrument from the connected measurement circuits.
- ▶ Remove holster
- ▶ Loosen the screws on the rear of the instrument
Lift the battery case cover (by gently hitting the instrument in the palm of your hand).
- ▶ Remove the discharged batteries.
- ▶ Insert new batteries and ensure there is correct polarity.
- ▶ Replace the battery case cover and retighten the screws.
- ▶ The instrument is now ready for further measurements.

 **Please consider your environment when you dispose of your used batteries or accumulators. They belong in a rubbish dump for hazardous waste. In most cases, the batteries can be returned to their point of sale.**

 Please, comply with the appropriate regulations concerning the return, recycling and disposal of used batteries.

 If an instrument is not used over an extended period of time, the batteries must be removed. Should the instrument be contaminated by leaking battery cells, the instrument has to be returned for cleaning and inspection to the factory.

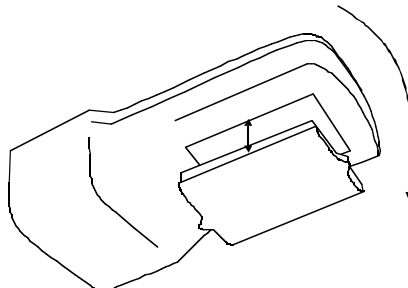
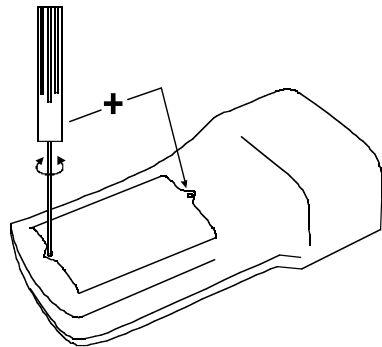

Built in fuses

11.0 Built in fuses

The instrument measurement inputs are protected by fuses, described in Section 13, Technical Data.

Both fuses are housed within the test instrument: Fuse F1 is located within the input circuit of L1 (or L). Fuse F2 is located within the input circuit of L3 (or PE). To replace the fuses, you must open the instrument TELARIS 0100 plus.

The fuses may only be replaced by our factory service department.

You may only use fuses complying with the current values, voltage values, switch off characteristics and capacities as stipulated in our technical data section.

11.1 Display for Tripped Fuses

If during the measurement, the TELARIS 0100 plus displays the measurement data described below, this indicates that the respective fuse has tripped.

The fuse must be replaced and the measurement instrument must be returned to our factory or an authorised service department for overhauling.

Function "Low Ohm":

Display >19.99 Ohm in spite of short-circuited test leads: Fuse F1 has tripped.

For the function "Rins":

Display >199.9 MOhm in spite of short-circuited test leads: Fuse F1 has tripped or the measurement is cancelled. The following symbols are briefly displayed: 'Attention' (1) and 'Uext' (5): Fuse F1 has tripped.

For the function RI, IPSC - Internal Line Resistance

Display >19990hm also for sockets, which possess a known low internal resistance (other electrical loads do function): Fuse F1 has tripped.

If the fuse F2 is faulty, the socket test will indicate a PE error, which will disappear when touching the PE electrode (25). During the PE electrode contact the measurement may be started. The internal resistance measurement between both phases works correctly if the fuse F1 is in good condition.

Functions "Rs":

Display >19990hm also for sockets, which possess a lower loop resistance: Fuse F1 has tripped.

If the fuse F2 is faulty, the socket test will indicate a PE error, which will disappear when touching the PE electrode (25).

RCD-Test

Display UB>UL also for sockets, which are in good condition: Fuse F1 has tripped.

If the fuse F2 is faulty, the socket test will indicate a PE error, which will disappear when touching the PE electrode (25).

The rotary field recognition and the voltage measurement facilities function even if fuses F1 and/or F2 have tripped.

12.0 Calibration Interval

We suggest a calibration interval of one year. If the instrument is used very often or if it is used under rough conditions we recommend shorter intervals. If the instrument is used few times only the calibration interval can be extended on to 3 years.

13.0 Technical Data

General technical data:

Display:	3 ½ digit or 3 digit LCD
Reference-Range:	+17°C to 27°C, max. 70% rel. humidity
Temperature-Range:	0°C to 40°C, relative humidity max. 80%
Storage temperature:	-10°C...+60°C
Height above MSL:	up to 2000m
Battery type:	6x 1,5V Mignon Typ IEC LR6 (size AA)
Current-consumption:	20mA (Stand-by)
Battery life:	for average use approx. 1 year after approx. 5min
Fuses:	F1/F2: T 1,26A/500 V 1000 A, 6 x 32 mm
Data memory Interface:	9600 Baud, 1 startbit, 8 data bits, even parity, 1 stopbit
Overvoltage Category:	CAT III / 440V against ground
Pollution degree:	2
Protection Category:	2, IP50
Dimensions:	235 x 103 x 70 mm
Weight:	650g incl. Batteries

Voltage measurement Vac, Vdc:

Measurement Range Vac:	1 ... 440VAC (Frequency f: 10 ... 99.9 Hz)
Measurement Range Vdc:	1 ... ±440VDC
Resolution:	1 V
Tolerance:	±(3% rdg. +3 Digit)
Internal Resistance:	1 MΩ

Frequency Measurement f:

Measurement Range:	10,0 ... 99,9Hz
Resolution:	0,1Hz
Tolerance:	±(1% rdg. +1 Digit)
Voltage Range:	5 ... 440VAC

Low Ω Measurement:

Measurement range:	0,01...19,99 Ω, 20,0 ... 199,9 Ω, 200 ... 1999Ω
Resolution:	0,01 Ω, 0,1Ω, 1Ω
Tolerancy:	± (3% + 5digits)
Output voltage Uq:	4V...9V DC
Test Current:	≥ 200mA (at resistance < 2Ω+Rcomp)
Measurement time:	approx. 1s (automatic) (continuous)
Number of Measurements:	approx. 4000 (1Ω, 1 measurement- 25s break)
Compensated test lead resistance:	max. 1,99 Ω

Technical Data

Insulation Measurement Rins:

Measurement Range: 0,05 ... 19,99 M Ω , 20,0 ... 199,9 M Ω
Resolution: 0,01 M Ω , 0,1 M Ω
Tolerance: \pm (5% rdg. + 5 Digit)

Nominal-output voltage	Max. open-circuit voltage U_q	Numbers of measurement with 1mA Load (1 Measurement - 25s break)
100V DC	UN + 50%	approx. 6000
250V DC	UN + 50%	approx. 4000
500V DC	UN + 50%	approx. 3000

Max. open-circuit voltage Un + 50 %
Test current: ≥ 1 mA at Vn
Short-circuit current: < 3 mA
Measurement time: 1 - 3 s (automatic)
1 - 10 s (automatic, at capacitive Load)
optional (continuous)
Overload-Protection: 500V AC/DC continuous, 600V AC/DC for 10s
Automatic measurement range selection.
EUT automatically discharged after measurement.

Mains internal resistance RI, IPSC

Measurement range: 0,15...19,99 Ω (Display range: 0,05 Ω ...)
20,0 ... 199,9 Ω
200 ... 1999 Ω
Resolution: 0,01 Ω , 0,1 Ω , 1 Ω
Tolerancy: \pm (6% v.M. + 5 Digit)
Test current: < 4.5 A (230 V), < 8A (400 V)
Load time: < 200 ms
Nominal mains voltage: 230V (-15 %) ... 400V (+10 %), 50 ... 60Hz, $\cos \varphi > 0,95$
Measurement time: approx. 3s

Prospective Short-Circuit Current :

Measurement Range: 0,10...9,99 A, 10,0 A...99,9 A, 100 A...999 A,
1,00 ... 8,80 kA
Resolution: 0,01 A, 0,1 A, 1 A, 0,01 kA
Short-circuit current is calculated by the measured mains internal resistance

Max. mains fluctuations during measurement: 1%
Automatic measurement range selection

Loop Impedance ZL:

Mains nominal voltage: 230 V +10 % -15 % (50...60 Hz), $\cos \varphi$ 0,95
 Measurement Range: 0,15 ... 19,99 Ω , 20,0 ... 199,9 Ω , 200 ... 1999 Ω
 Display Range: 0,05 Ω ...1999 Ω
 Resolution: 0,01 Ω , 0,1 Ω , 1 Ω
 Tolerance: \pm (6% rdg. +5 Digit)
 Test current: < 4,5 A
 Load time: < 200 ms
 Measurement time: approx. 3s
 Max. nominal voltage fluctuation during the measurement: 1%
 Protective conductor must not be live.
 RCD's have to be bridged
 Automatic measurement range selection

Prospective Short-Circuit Current :

Measurement Range: 0,10...9,99 A, 10,0 A...99,9 A, 100 A...999 A,
 1,00...5,06 kA
 Resolution: 0,01 A, 0,1 A, 1 A, 0,01 kA
 Short-circuit current is calculated by the measured mains internal resistance

Some limit values for measured short-circuit currents I_k for low voltage fuses DIN VDE 0636,
 Characteristics gL:

Nominal Current	min. IPSC for save blowing < 5 s	min. IPSC for save blowing < 0,2 s
6 A	33 A	71 A
10 A	56 A	120 A
16 A	86 A	181 A
26 A	145 A	342 A
35 A	213 A	617 A

Loop Resistance RCD/FI

Measurement range: 0,50..19,99 Ω (Display range: 0,05 Ω .)/20,0 ... 199,9 Ω / 200 ... 1999 Ω
 Resolution: 0,01 Ω , 0,1 Ω , 1 Ω
 Tolerancy: \pm (6% v.M. + 5Digit)
 Test current: < 4.5 A
 Nominal mains voltage: 230V (-15%, +10%), 50 ... 60 Hz, $\cos \varphi$ > 0,95
 Measurement time: approx. 7 s

Prospective Short-Circuit Current

Display range: 0,10...9,99 A, 10,0 A...99,9 A, 100 A...999 A, 1,00 ... 5,06 kA
 Resolution: 0,01 A, 0,1 A, 1 A, 0,01 kA
 Short-circuit current is calculated by the measured mains internal resistance
 Max. mains voltage fluctuations during measurement: 1 %
 Max. mains internal resistance: 50 Ω
 Max. resistance of RN: 20 Ω
 An RCD does not trip during measurement!
 The protective conductor must be free of noise voltage; automatic range selection

Technical Data

RCD-Test:

Nominal Voltage:	230 V, +10 % -15 %, (50...60 Hz)
Measurement time:	approx. 2s, approx. 31s (selektive RCD/FI), max. 18s (measurement of trip current)
Current switch-off:	immediately at RCD tripping or at true excess of contact voltage limit.

The protective conductor must be free of noise voltage.

Measurement of Contact Voltage UB:

Measurement current:	1/3 nominal fault current $I_{\Delta N}$
Measurement duration:	< 100 ms, when exceeding limits immediate measurement
Measurement Range:	1...100 V
Resolution:	1 V
Tolerance:	-0%...+10%, +5 Digit
Threshold values:	VL selection between 25V / 50V

Contact voltage is measured at 1/3 $I_{\Delta N}$ and may be extrapolated to nominal current $I_{\Delta N}$ or double nominal current 2 $I_{\Delta N}$ for time delayed residual current circuit breakers.

Measurement of Ground Resistance:

Nominal fault Current $I_{\Delta N}$:	10, 30, 100, 300, 500mA standard 100, 300, 500mA selectiv
Measurement current:	1/3 nominal fault current $I_{\Delta N}$
Measurement duration:	< 100 ms, when exceeding limits immediate measurement
Measurement range:	10 ... 1999 Ω , 0,20 ... 10,00 k Ω at $I_{\Delta N}$ = 10mA, 30mA.
Display range:	1...1999 Ω , 0,01...10,00 k Ω

 Maximum RE is defined by the contact voltage limit VL. For $UB > 2x UL$, the measurement is interrupted and, thus, no measurement values can be obtained.

Resolution:	1 Ω , 0,01 k Ω
Tolerancy:	\pm (6% v. M. + 10 digit)

* Maximum RE is defined by the contact voltage UB. For $UB > UL$, the measurement is interrupted and, thus, no measurement values can be obtained.

Measurement of trip Time t_A :

Nominal fault current $I_{\Delta N}$:	10, 0.5x 30, 30, 5x 30, 100, 300, 500mA Standard 100, 300, 500mA selective
Test current type:	AC
Measurement time:	500ms, not at: 0.5x 30mA - 1999ms, 5x 30mA - 50ms each 300ms when measuring trip time
Measurement range:	1 ... t_{max} , t_{max} is the max. test time.
Resolution:	1ms
Tolerancy:	\pm (2% v. M. + 2 digit)

Measurement of trip Current I_{Δ} :

Nominal fault current $I_{\Delta N}$:	10, 30, 100, 300, 500mA Standard
Measurement Current:	40 ... 140% of the nominal fault current $I_{\Delta N}$
Resolution:	10% $I_{\Delta N}$
Tolerancy:	-0% ... +10%
Measurement time:	max. each 300ms
Current cut off:	immediately for RCD tripping or when exceeding contact voltage (25V / 50V)

Rotary Field

Nominal Voltage:	100V ... 440V, 3~, 50 ... 60Hz
Max. difference of phase voltage:	\pm 30%

24 month Warranty

UNITEST instruments are subject to strict quality control. However, should the instrument function improperly during daily use, you are protected by our 24 months warranty (valid only with invoice). We will repair free of charge any defects in workmanship or material, provided the instrument is returned unopened and untampered with, i.e. with undamaged warranty label. Any damage due to dropping or incorrect handling are not covered by the warranty. If the instrument shows failure following expiration of warranty, our service department can offer you a quick and economical repair.



CH. BEHA GmbH

Elektronik - Elektrotechnik

In den Engematten 14
79286 Glottertal / Germany
Tel.: +49 (0) 76 84/80 09-0
Fax: +49 (0) 76 84/80 09-410
Techn. Hotline: +49 (0) 76 84/80 09-429
internet: <http://www.beha.com>
e-mail: info@beha.de

Qualitätszertifikat • Certificate of Quality Certificat de Qualité • Certificado de calidad



Die BEHA-Gruppe bestätigt hiermit, dass das erworbene Produkt gemäß den festgelegten Beha-Prüfanweisungen während des Fertigungsprozesses kalibriert wurde. Alle innerhalb der Beha-Gruppe durchgeführten, qualitätsrelevanten Tätigkeiten und Prozesse werden permanent durch ein Qualitätsmanagement-System nach ISO 9000 überwacht.

Die BEHA-Gruppe bestätigt weiterhin, dass die während der Kalibrierung verwendeten Prüfeinrichtungen und Instrumente einer permanenten Prüfmittelüberwachung unterliegen. Die Prüfmittel und Instrumente werden in festgelegten Abständen mit Normalen kalibriert, deren Kalibrierung auf nationale und internationale Standards rückführbar ist.



The BEHA Group confirms herein that the unit you have purchased has been calibrated, during the manufacturing process, in compliance with the test procedures defined by BEHA. All BEHA procedures and quality controls are monitored on a permanent basis in compliance with the ISO 9000 Quality Management Standards.

In addition, the BEHA Group confirms that all test equipment and instruments used during the calibration process are subject to constant control. All test equipment and instruments used are calibrated at determined intervals, using reference equipment which has also been calibrated in compliance with (and traceable to) the calibration standards of national and international laboratories.



Le groupe BEHA déclare que l'appareil auquel ce document fait référence a été calibré au cours de sa fabrication selon les procédures de contrôle définies par BEHA. Toutes ces procédures et contrôles de qualité sont régis par le système de gestion ISO 9000.

Le groupe BEHA déclare par ailleurs que les équipements de contrôle et les instruments utilisés au cours du processus de calibrage sont eux-mêmes soumis à un contrôle technique permanent.

Ces mêmes équipements de contrôle sont calibrés régulièrement à l'aide d'appareils de référence calibrés selon les directives et normes en vigueur dans les laboratoires de recherche nationaux et internationaux.



El grupo BEHA declara que el producto adquirido ha sido calibrado durante la producción de acuerdo a las instrucciones de test BEHA. Todos los procesos y actividades llevados a cabo dentro del grupo BEHA en relación con la calidad del producto son supervisados permanentemente por el sistema ISO 9000 de control de calidad.

Adicionalmente, el grupo BEHA constata que los equipos e instrumentos de prueba utilizados para la calibración también son sometidos a un permanente control. Estos equipos e instrumentos de prueba son a su vez calibrados en intervalos regulares valiéndose de equipos de referencia calibrados de acuerdo a directivas de laboratorios nacionales e internacionales.



CH. BEHA GmbH

Elektrotechnik - Elektronik
In den Engematten 14
D-79286 Glottertal / Germany
Tel. +49 (0) 76 84 / 80 09 - 0
Fax +49 (0) 76 84 / 80 09 - 410
e-mail: info@beha.de
internet: <http://www.beha.com>



Reg. No. 3335
Quality Management System
ISO 9001



Connemara Electronics Beha GmbH

Industrial Park
Carrigaline, Co. Cork
Republic of Ireland
Tel. (+353) 21 4919000
Fax (+353) 21 4919010
e-mail: connemara.electronics@connelec.ie



I.S./ISO 9002/EN 29002
Quality Management System

IQ NET

AENOR Spain **AFAQ** France **AIB-Vincotte Inter** Belgium **APCER** Portugal **BSI** United Kingdom **CSIQ** Italy
CQS Czech Republic **DQS** Germany **DS** Denmark **ELOT** Greece **FCAV** Brazil **IRAM** Argentina **JQA** Japan
KEMA Netherlands **KSA-QA** Korea **MSZT** Hungary **NCS** Norway **NSAI** Ireland **ÖQS** Austria **PCBC** Poland **PSB** Singapore
QAS Australia **QMI** Canada **SFS** Finland **SII** Israel **JQA** Japan **SIQ** Slovenia **SIS-SAQ** Sweden **SQS** Switzerland
IQNet is represented in the USA by the following IQNet members: **AFAQ, AIB-Vincotte Inter, BSI, DQS, KEMA, NSAI and QMI**