

SR Research Experiment Builder User Manual

Version 1.4.402

**Please report all functionality comments and bugs to:
support@sr-research.com**

An HTML version of this document, which contains extra sections on example projects and frequently asked questions, is available at <https://www.sr-support.com/forums/showthread.php?t=99>

Copyright ©2004-2007 SR Research Ltd.
EyeLink© is a registered trademark of SR Research Ltd., Mississauga, Canada

Table of Contents

1	Introduction.....	1
1.1	Features.....	1
1.2	How to Use This Manual.....	2
2	Experiment Builder Experiment Life Cycle.....	4
2.1	Experiment Design.....	4
2.2	Building and Test-running Experiment.....	5
2.3	Experiment Deployment.....	5
2.4	Participant Data Set Randomization.....	6
2.5	Data Collection.....	6
2.6	Data Analysis.....	6
3	Installation.....	7
3.1	System Requirements.....	7
3.1.1	Computer Configuration.....	7
3.1.2	Maximizing the Real-time Performance of the Deployment PC.....	9
3.1.3	Host PC and Display PC Software Requirements.....	9
3.2	Installing Software.....	9
3.2.1	For Standard Installation (applicable to most users).....	10
3.2.2	For Installation using Network Licensing.....	10
3.3	Licensing.....	11
3.3.1	HASP Driver Installation.....	11
3.3.2	Software Licensing.....	13
4	Working with Files.....	14
4.1	Creating a New Session.....	14
4.2	Saving a Session.....	16
4.3	Saving an Existing Session to a Different Directory.....	16
4.4	Opening a Session.....	17
4.5	Reopening a Recent Experiment Session.....	18
4.6	Packaging an Experiment.....	18
4.7	Unpacking an Experiment.....	19
4.8	Building an Experiment.....	19
4.9	Cleaning an Experiment.....	19
4.10	Test-running an Experiment from EB Application.....	20
4.11	Deploying an Experiment.....	20
4.12	Running an Experiment for Data Collection.....	20
5	Experiment Builder Graphical User Interface.....	22
5.1	Project Explorer Window.....	22
5.2	Graph Editor Window.....	25
5.3	Application Menu Bar and Toolbar.....	26
5.3.1	File Menu and Tool Buttons.....	26
5.3.2	Edit Menu and Tool Buttons.....	27
5.3.3	View Menu.....	27
5.3.4	Experiment Menu and Tool Buttons.....	28
5.3.5	Help Menu.....	28
6	Designing an Experiment in Experiment Builder.....	29
6.1	Hierarchical Organization of Experiments.....	29

6.2	Experiment Graph: Flow Diagram.....	30
6.2.1	Adding Components to an Experiment.....	31
6.2.2	Linking Experiment Components.....	32
6.2.3	Linking Rules.....	32
6.3	Actions.....	33
6.4	Triggers.....	34
6.5	Other Node Types.....	35
6.6	Sequence/Sub-graph.....	36
6.7	References and Equations.....	37
7	Experiment Graph and Components.....	39
7.1	Graph Editing Operations.....	39
7.2	Node Connection.....	40
7.2.1	Connection: Create, Cancel, and Delete.....	40
7.2.2	Connection Order.....	40
7.3	Experiment Node Exporting and Importing.....	41
7.3.1	Exporting.....	41
7.3.2	Importing.....	42
7.4	Layout of Nodes in Work Space.....	43
7.5	Editing Properties of a Node.....	44
7.6	Experiment Node.....	46
7.7	Sequence/Subgraph.....	47
7.8	Start Node.....	51
7.9	Actions.....	52
7.9.1	Display Screen.....	52
7.9.2	Performing Drift Correction.....	56
7.9.3	Performing Camera Setup and Calibration.....	60
7.9.4	Sending EyeLink© Message.....	63
7.9.5	Sending EyeLink© Command.....	65
7.9.6	Sending TTL Signal.....	68
7.9.7	Adding to Experiment Log.....	69
7.9.8	Updating Attribute.....	71
7.9.9	Adding to Accumulator.....	72
7.9.10	Adding to Result File.....	73
7.9.11	Preparing Sequence.....	74
7.9.12	Reset Node.....	77
7.9.13	Playing Sound.....	78
7.9.14	Play Sound Control.....	84
7.9.15	Record Sound.....	86
7.9.16	Record Sound Control.....	89
7.9.17	Terminating an Experiment.....	90
7.9.18	Recycle Data Line.....	91
7.9.19	Execute Action.....	93
7.9.20	Null Action.....	94
7.10	Triggers.....	95
7.10.1	Timer Trigger.....	95
7.10.2	Invisible Boundary Trigger.....	98

7.10.3	Conditional Trigger.....	104
7.10.4	EyeLink© Button Trigger.....	107
7.10.5	Cedrus© Button Trigger.....	109
7.10.6	Keyboard Trigger.....	111
7.10.7	Mouse Trigger.....	114
7.10.8	TTL Trigger.....	118
7.10.9	Fixation Trigger.....	120
7.10.10	Saccade Trigger.....	124
7.10.11	Sample Velocity Trigger.....	128
7.10.12	ASIO Voicekey Trigger.....	132
7.11	Other Building Components.....	135
7.11.1	Variable.....	135
7.11.2	Result File.....	138
7.11.3	Accumulator.....	140
7.11.4	Custom Class Instance.....	143
8	Screen Builder.....	145
8.1	Resources.....	146
8.1.1	Image Resource.....	146
8.1.1.1	Image Displaying Modes.....	149
8.1.1.2	Gaze-Contingent Window Manipulations.....	150
8.1.2	Video Resource.....	151
8.1.2.1	Reading Frame Time.....	155
8.1.2.2	Video Frame Timing.....	155
8.1.2.3	Video Frame Rate and Display Retrace Rate.....	156
8.1.2.4	Dropping Frames.....	157
8.1.2.5	Frame Caching.....	157
8.1.2.6	Video Codec.....	158
8.1.2.7	Playing Video Clips with Audio.....	158
8.1.3	Text Resource.....	159
8.1.3.1	Non-ASCII characters.....	161
8.1.3.2	Anti-aliasing and Transparency.....	161
8.1.4	Multiline Text Resource.....	163
8.1.5	Line Resource.....	165
8.1.6	Rectangle Resource.....	167
8.1.7	Ellipse Resource.....	168
8.1.8	Triangle Resource.....	170
8.1.9	Freeform Resource.....	172
8.2	Movement Patterns.....	173
8.2.1	Sinusoidal Movement Pattern.....	174
8.2.2	Custom Movement Pattern.....	176
8.3	Interest Areas.....	180
8.3.1	Manually Creating an Interest Area.....	181
8.3.1.1	Rectangular/Elliptic Interest Area.....	181
8.3.1.2	Freeform Interest Area.....	182
8.3.2	Automatic Segmentation.....	182
8.3.3	Using Interest Area File.....	184

8.4	Resource Operations	184
8.4.1	Resource Editing	184
8.4.2	Resource Alignments	185
8.4.3	Resource Locking	186
8.4.4	Resource Grouping	186
8.4.5	Resource Order	187
8.4.6	Composite Resource	188
8.4.7	Others	189
9	Data Source	191
9.1	Creating Data Source	192
9.2	Editing Data Source	192
9.3	Importing Existing Files as Data Source	194
9.4	Datasource Splitby	195
9.5	Datasource Randomization	195
9.5.1	Internal Randomization	196
9.5.1.1	Randomization Seed	196
9.5.1.2	Blocking	197
9.5.1.3	Trial randomization and run length control	197
9.5.1.4	Randomize on Roll-Over	198
9.5.1.5	Splitting Column	198
9.5.1.6	Running Experiment with Internal Randomizer	198
9.5.2	External Randomization	198
10	References	201
10.1	Using References	201
10.2	Entering in Values	202
10.3	Entering in References	203
10.4	Entering in Equations	203
10.5	Reference Manager	205
11	EyeLink© Data Viewer Integration	207
11.1	TRIALID Message	208
11.2	Recording Status	208
11.3	Image and Interest Areas	209
12	Custom Class	211
12.1	Enabling Custom Class Option	211
12.2	Creating a New Custom Class	211
12.3	Syntax of Custom Class	212
12.3.1	Example	212
12.3.2	Class Definition	214
12.3.3	Class Initialization	214
12.3.4	Class Attributes	215
12.3.5	Class Methods	216
12.3.6	'setX' and 'getX' Methods	217
12.4	Instantiating Custom Class	218
12.5	Using Custom Class	219
12.6	Using Custom Class Editor	221
13	Creating Experiments: Overview	223

14	Creating EyeLink Experiments: The First Example.....	224
14.1	Creating the Experiment	224
14.1.1	Creating a New Experiment Session.....	224
14.1.2	Configuring Experiment Preference Settings	225
14.1.3	Creating Experiment Block Sequence	227
14.1.4	Editing Block Sequence.....	228
14.1.5	Creating Instruction Screen.....	230
14.1.6	Editing Trial Sequence: Data Source.....	232
14.1.7	Editing Trial Sequence: Preparing Sequence and Drift Correction.....	233
14.1.8	Editing Recording Sequence.....	235
14.1.9	Modifying Properties of Display Screen.....	236
14.1.10	Creating Display Screen	237
14.1.11	Writing Trial ID to EDF file	239
14.1.12	Showing Experiment Progress Message on Tracker Screen.....	239
14.2	Building the Experiment	240
14.3	Deploying the Experiment	241
14.4	Running the Experiment	241
14.4.1	Error in Initializing Graphics.....	242
14.4.2	Error in Tracker Version.....	242
15	Creating Non-EyeLink Experiments: Stroop Effect.....	243
15.1	Creating a New Experiment Session.....	243
15.2	Configuring Experiment Preference Settings	244
15.3	Creating Experiment Block Sequence	245
15.4	Editing Block Sequence.....	246
15.5	Creating Instruction Screen.....	248
15.6	Editing Trial Sequence: Data Source.....	249
15.7	Editing Trial Sequence: Setting Initial Values and Preparing Sequence.....	252
15.8	Editing Trial Event Sequence – Part 1	256
15.8.1	Creating the Fixation Screen.....	258
15.8.2	Creating the Stroop Display Screen.....	259
15.9	Editing Trial Event Sequence – Part 2.....	260
15.10	Outputting Data to the Result File	266
15.11	Running the Experiment	267
16	Experiment Builder Project Check List.....	268
17	Preference Settings.....	271
17.1	Experiment.....	271
17.1.1	EyeLink©.....	273
17.1.2	Display	279
17.1.3	Audio.....	281
17.1.4	TTL	282
17.1.5	Cedrus	283
17.1.6	Keyboard.....	283
17.1.7	Mouse.....	284
17.1.8	Timer.....	284
17.1.9	Invisible Boundary.....	285
17.1.10	Conditional.....	285

17.1.11	EyeLink© Button.....	285
17.1.12	Cedrus Input.....	285
17.1.13	Mouse.....	285
17.1.14	Fixation.....	285
17.1.15	Saccade.....	285
17.1.16	Sample Velocity.....	285
17.1.17	Display Screen.....	285
17.1.18	Drift Correct.....	285
17.1.19	Camera Setup.....	285
17.1.20	Send EyeLink© Message.....	285
17.1.21	Send Command.....	285
17.1.22	Add to Experiment Log.....	285
17.1.23	Add to Accumulator.....	285
17.1.24	Prepare Sequence.....	286
17.1.25	Play Sound.....	286
17.1.26	Sequence.....	286
17.1.27	Set TTL.....	286
17.1.28	Accumulator.....	286
17.1.29	Result File.....	286
17.2	Screen.....	286
17.2.1	Screen.....	286
17.2.2	Image Resource.....	287
17.2.3	Video Resource.....	287
17.2.4	Text Resource.....	287
17.2.5	Multiline Text Resource.....	287
17.2.6	Line Resource.....	287
17.2.7	Rectangle Resource.....	287
17.2.8	Ellipse Resource.....	287
17.2.9	Triangle Resource.....	287
17.2.10	Freeform Resource.....	287
17.2.11	Sine Pattern.....	287
17.2.12	Grid Segmentation.....	288
17.2.13	Auto Segmentation.....	288
17.2.14	Word Segmentation.....	289
17.3	Build/Deploy.....	290
17.4	GUI.....	291
17.4.1	Graph_Layout.....	292
17.4.2	CustomClass_Editor.....	292

List of Figures

Figure 3-1. Installing new version of HASP key driver	13
Figure 3-2. Getting the ID of USB Dongle Key and Entering Licensing Code	13
Figure 4-1. File Menu	14
Figure 4-2. Dialog for Creating a New Project.....	15
Figure 4-3. Warning Messages after Experiment Creation	16
Figure 4-4. Open an Experiment Builder Session	17
Figure 4-5. Save Confirmation When Opening a New Session.....	17
Figure 4-6. Reopening Recent Experiment Sessions	18
Figure 4-7. Experiment Menu.....	19
Figure 5-1. Sample Experiment Builder Interface.....	22
Figure 5-2. The View Menu.....	23
Figure 5-3. Components of the Project Explorer Window	24
Figure 5-4. Different Tabs of the Structure Panel.....	24
Figure 5-5. Components of the Graph Editor Window.....	26
Figure 6-1. Hierarchical Organization of Events in an Experiment	30
Figure 6-2. Sample Experiment Sequence.....	31
Figure 6-3. Connecting between Source and Target Components	32
Figure 6-4. Nested Sequences in an Experiment.	37
Figure 6-5. Using a Reference to Update Text to Be Displayed.	38
Figure 7-1. Connectin Order	40
Figure 7-2. Exporting Node	41
Figure 7-3. Importing Node	43
Figure 7-4. Choosing Layout of Components in Work Space.....	44
Figure 7-5. Property Field Editable with Attribute Reference Editor.....	45
Figure 7-6. Properties of the Experiment Node	47
Figure 7-7. Using Sequence in an Experiment	51
Figure 7-8. Action Tab of the Component Toolbox	52
Figure 7-9. Using Display Screen.....	56
Figure 7-10. Using Drift Correction Action	60
Figure 7-11. Using Camera Setup Action.....	63
Figure 7-12. Using Sending Message Action.	65
Figure 7-13. Using Sending EyeLink© Command Action.....	68
Figure 7-14. Using Add to Experiment Log Action	71
Figure 7-15. Using Update Attribute Action.	72
Figure 7-16. Using Prepare Sequence Action.....	77
Figure 7-17. Adding Sound Clips to the Library	79
Figure 7-18. Choose Audio driver.	80
Figure 7-19. Using Play Sound Action.	84
Figure 7-20. Using Play Sound Control Action.....	86
Figure 7-21. Using Record Sound Action.....	88
Figure 7-22. Using Terminate_ Experiment Action	91
Figure 7-23. Using Recycle Dataline Action.....	93
Figure 7-24. Triggers Implemented in Experiment Builder	95
Figure 7-25. Using Timer Trigger	98
Figure 7-26. Using Invisible Boundary Trigger	102

Figure 7-27. Using Conditional Trigger	105
Figure 7-28. Using EyeLink© Button Trigger	108
Figure 7-29. Using EyeLink© Button Trigger	111
Figure 7-30. Using Keyboard Trigger	114
Figure 7-31. Using Mouse Trigger	117
Figure 7-32. Making a Resource Position Contingent on Mouse Position.....	118
Figure 7-33. Using TTL Trigger.....	120
Figure 7-34. Using Fixation Trigger.....	124
Figure 7-35. Using Saccade Trigger.....	128
Figure 7-36. Using Sample Velocity Trigger	132
Figure 7-37. Using Voice Key Trigger	135
Figure 7-38. Other Components Implemented in Experiment Builder.....	135
Figure 7-39. Using a Variable.....	136
Figure 7-40. Property Settings for Variables	137
Figure 7-41. Dynamic Data Type Casting	138
Figure 7-42. Using Result File.....	139
Figure 7-43. Setting Properties of the Result File Node.....	140
Figure 7-44. Using Accumulator	141
Figure 7-45. Setting the Properties of Accumulator	142
Figure 7-46. Adding Data to and Retrieving Data from the Accumulator	143
Figure 8-1. Sample View of the Screen Builder Interface.....	145
Figure 8-2. Resources Implemented in Screen Builder	146
Figure 8-3. Loading Images into Image Library.....	147
Figure 8-4. Setting Different Location Types for Images Used in a Gaze-Contingent Window Application.....	151
Figure 8-5. Loading Video Clips into Video Library	152
Figure 8-6. Setting UTF-8 Encoding.....	161
Figure 8-7. Aliased and Anti-aliased Texts	162
Figure 8-8. Antialiasing Drawing Preference Setting.....	162
Figure 8-9. Setting the Transparency Color for the Experiment	163
Figure 8-10. Multiline Text Editor.....	164
Figure 8-11. Creating a Movement Pattern.....	174
Figure 8-12. Adding Resource Positions to a Custom Movement Pattern	176
Figure 8-13. Creating a Custom Movement Pattern	178
Figure 8-14. Creating a File-based Custom Movement Pattern	179
Figure 8-15. Toggling Interest Area Visibility	181
Figure 8-16 Creating an Interest Area	181
Figure 8-17. Creating Interest Area with Grid Segmentation.....	184
Figure 8-18. Resource Alignment (Left) and Toggling Grid Visibility.....	185
Figure 8-19. Snap to Grid	186
Figure 8-20. Error When Trying to Modified a Locked Resource	186
Figure 8-21. Resource Grouping.....	186
Figure 8-22. Creating a Composite Resource.....	187
Figure 8-23. Two Resources with Different Resource Order.....	187
Figure 8-24. Changing the Order of Resources	188
Figure 8-25. Choosing "Fit to Screen" Option.....	190

Figure 8-26. Save Screen as Image.....	190
Figure 9-1. Using Data Source in Experiment Builder.....	191
Figure 9-2. Change the Type of Variables.....	192
Figure 9-3. Data Types Used in Experiment Builder.....	193
Figure 9-4. Editing Operations for Data Source Columns and Rows.....	193
Figure 9-5. Editing Datasource Cells.....	194
Figure 9-6. Append or Overwrite Confirmation.....	195
Figure 9-7. Using "Split by" Option to Customize the Number of Iterations to Run in a Sequence.....	195
Figure 9-8. Using Internal Randomization.....	196
Figure 9-9. Using External Randomization.....	200
Figure 10-1. Using Attribute References.....	202
Figure 10-2. Creating Equations in Attribute Editor.....	204
Figure 10-3. Using the Reference Manager.....	206
Figure 11-1. Sending the Recording Status Message to the Tracker.....	207
Figure 11-2. Editing Trial ID Message.....	208
Figure 11-3. Creating Recording Status Message.....	209
Figure 12-1. Creating a New Custom Class.....	211
Figure 12-2. Attributes and Properties of a Custom Class Instance.....	219
Figure 12-3. Assigning Attribute Values through Custom Class Instance.....	220
Figure 12-4. Data Exchange through Execute Action.....	220
Figure 12-5. Custom Class Code Editor.....	221
Figure 14-1. Creating a New Experiment Builder Session.....	224
Figure 14-2. Configuring Preference Settings.....	226
Figure 14-3. Setting the Tracker Version for the Experiment.....	227
Figure 14-4. Creating Experiment Block Sequence.....	227
Figure 14-5. Editing Block Sequence.....	228
Figure 14-6. Adding Instruction to Block Sequence.....	230
Figure 14-7. Adding Multiline Text Resource onto a Display Screen.....	231
Figure 14-8. Create Instruction Screen.....	232
Figure 14-9. Creating Data Set.....	233
Figure 14-10. Editing Trial Sequence.....	234
Figure 14-11. Editing Recording Sequence.....	235
Figure 14-12. Modifying the Properties of DISPLAY_SCREEN Action.....	236
Figure 14-13. Adding Text to Display Screen.....	237
Figure 14-14. Referring Text to Be Shown to Data Source.....	238
Figure 14-15. Creating Trial ID Message.....	239
Figure 14-16. Creating Trial Recording Status Message.....	240
Figure 14-17. Error in Initializing Graphics.....	242
Figure 14-18. Error in Tracker Version.....	242
Figure 15-1. Creating a New Experiment Builder Session.....	243
Figure 15-2. Editing Project Preferences.....	244
Figure 15-3. Creating Experiment Block Sequence.....	245
Figure 15-4. Editing Block Sequence.....	246
Figure 15-5. Adding Instruction to Block Sequence.....	247
Figure 15-6. Adding Multiline Text Resource onto a Display Screen.....	248

Figure 15-7. Create Instruction Screen	249
Figure 15-8. Datasource Randomization.	251
Figure 15-9. Creating Data Set	252
Figure 15-10. Editing Trial Sequence.....	253
Figure 15-11. Updating Trial Index.	254
Figure 15-12. Update Trial Iteration.....	255
Figure 15-13. Updating the Attribute of RT	255
Figure 15-14. Editing Recording Sequence.....	256
Figure 15-15. Setting Response Keys.....	257
Figure 15-16. Loading Resources to Image Library.....	258
Figure 15-17. Adding Text to Display Screen.....	259
Figure 15-18. Referring Text to Be Shown to Data Source.....	260
Figure 15-19. Editing Recording Sequence.....	261
Figure 15-20. Accessing the Subattribute of the TriggeredData Attribute.....	262
Figure 15-21. Loading Feedback Audio Clips.....	263
Figure 15-22. Send Results to a Result File.....	265
Figure 15-23. Adding Variables to Results File	266
Figure 17-1. Accessing the Experiment Builder Preference Settings.....	271

1 Introduction

The SR Research Experiment Builder (SREB) is a visual experiment creation tool for use by Psychologists and Neuroscientists. The SREB is designed to be easy to use while maintaining a high degree of flexibility. This unique design combination allows for a wide range of experimental paradigms to be created by someone with little or no programming or scripting expertise. When used in combination with the SR Research EyeLink® eye tracking system, the SREB provides seamless integration into the EyeLink hardware and software platform.

1.1 Features

The SR Research Experiment Builder provides a comprehensive graphical experiment creation environment for Psychologists. The features in the Experiment Builder have been designed to address many of the research needs SR Research has encountered when working with EyeLink users on their applications. This ranges from simple experiments in which each trial shows a static screen of text or picture and then waits for a response from the participant; to more sophisticated experiments in which complex event sequence can be scheduled with good timing precision.

Experiments are created in the Experiment Builder by dragging and dropping experiment components into a workspace and configuring the properties of the added components. There are two main classes of experiment components in the Experiment Builder: Actions and Triggers. Actions tell the computer to do something, like displaying a set of graphics on the screen or playing a sound. Triggers define the conditions that must be met before an action can be performed. Examples of Triggers are keyboard events and eye (Fixation, Saccade, and Invisible Boundary) events.

The flow of the experiment is achieved by connecting sequentially related components in the workspace in a flow diagram like fashion. For example, a Display Screen Action may be connected to a button press Trigger, which is in turn connected to another Display Screen Action. This simple Action -> Trigger -> Action sequence would result in a given set of graphics being displayed until the user pressed a button, at which time a second set of graphics would be displayed. Detailed discussion on the experiment component connection or linking process, including a set of "rules" for linking experiment components together, can be found in Section 6.2 "Experiment Graph: Flow Diagram".

As a convenient tool for creating eye-tracking experiments, the Experiment Builder is fully integrated with the EyeLink eye tracker. Performing camera set-up, calibration, validation, and drift correction can be achieved by simply inserting the appropriate action in the experiment. A single check box setting can be enabled to record eye movements for a period of time. Online eye data can be used as triggers to drive display changes (e.g., displays can be made contingent on fixation, saccade, or instantaneous sample data so that gaze-contingent or gaze-control applications can be developed). In addition, users can set eye-tracker preferences and send commands and messages to the EyeLink tracker.

With these capabilities, the Experiment Builder allows the users to focus on stimulus presentation and data analysis. Recording data collected from experiments created by Experiment Builder is fully integrated with EyeLink Data Viewer. For example, Experiment Builder automatically sends messages to the EDF file when a screen is displayed so that images and/or simple drawings can be used as overlay background in Data Viewer. Experiment Builder also allows the users to specify condition variables for a trial and to add interest areas for a display screen. Finally, the users can send custom messages to the EDF file so that time critical or important events can be marked in the data file for the ease of future analyses.

The Experiment Builder also contains a built-in Screen Builder utility that makes the creation of 2D visual displays easier. The Screen Builder is a what-you-see-is-what-you-get ("WYSIWYG") tool, allowing experiment designers to create and view 2D visual stimuli right within the Experiment Builder application. The Screen Builder allows various types of graphic resources (images, text, or simple line drawings) to be added to a Display Screen action. The exact properties of the resources can be further modified from a property panel. In addition, the Screen Builder supports creation of both static and dynamic displays. In a dynamic display, the user can have some resources on the screen move along a pre-specified movement pattern.

The SR Research Experiment Builder is highly configurable. Nearly all of the properties of experiment components can be modified. This can be done either by directly entering the parameter values or, more flexibly, by attribute reference and equations (i.e., setting the value of one variable to the value of another variable). With this dynamic reference capability, a typical experiment requires the users to create a prototype of experiment conditions while leaving all parameter settings (e.g., experiment trial condition labeling, images to be used, text to be shown, positions of the resources) to be handled by a data source. This makes the randomization of trials across participants easier. In addition, attribute reference allows the user to access some run-time data so that useful experiment manipulations such as conditional branching, displaying feedbacks, and creating new variables can be made.

1.2 How to Use This Manual

This manual is intended for users who are using version 1.4 or later of SR Research Experiment Builder software. If you are still using an earlier version of the software, please download the latest version from <https://www.sr-support.com/forums/showthread.php?t=9>. The latest version of this document can be obtained from <https://www.sr-support.com/forums/showthread.php?t=99>. (Note: you must be a registered user of <https://www.sr-support.com> to access these updates and the Experiment Builder usage discussion forum.) If you have feature requests or bug reports, please send an e-mail to eb@sr-research.com. If you have questions on using the software, please check out the "Frequently Asked Questions" section of the user manual (html version), the Experiment Builder usage discussion forum, or send an e-mail to support@sr-research.com.

To use the Experiment Builder software effectively, it might help if you can follow the Chapter 14 "Creating EyeLink Experiments: The First Example" to re-create the "SIMPLE" example by yourself and get a sense of the life cycle of experiment generation and data collection with Experiment Builder software. This section can be used as a "Getting Started" guide. You should also read the following sections of the document very carefully as they discuss the basic concepts of Experiment Builder software: Chapter 2 "Experiment Builder Life Cycle", Chapter 6 "Designing an Experiment in Experiment Builder", Chapter 9 "Data Source", and Chapter 10 "References". Following this, you can then take a look at other examples we provided (see the .html version of this document for detailed explanations on the examples) and start reading other sections. Chapter 16 "Experiment Builder Project Checklist" may be used to make sure that common problems can be avoided when creating your experiments.

2 Experiment Builder Experiment Life Cycle

To create an experiment with the Experiment Builder, the user needs to go through the following steps:

- Experiment Design
- Building and Test-running Experiment
- Deploying Experiment
- Participant Data Set Randomization
- Data Collection
- Data Analysis

2.1 Experiment Design

While the Experiment Builder simplifies many of the tasks required for creating an experiment, a good understanding of experiment design (e.g., blocking, counterbalancing, factorial design, etc.) and experience with the EyeLink© system makes initial use of Experiment Builder easier. In the stage of experiment design, the user needs to do the following:

- 1) **Conceptualizing the Experiment.** The user should have a clear concept of the experiment before creating it. State clearly what variables should be manipulated in the experiment. Within each trial, how is the display presented: a static display or a dynamic display? Can the same display presentation routine be used across all conditions or a different routine should be created for each of the experiment condition? This allows the user to contemplate all of the possible trial types in the experiment, design conditional branching if necessary, and create a data source for filling trial parameters. Once this is done, study one or more sample experiments we supplied before creating your own project.
- 2) **Creating a New Experiment Session.** Start the Experiment Builder application and create a new experiment session. Please read Chapter 4 “Working with Files” for details on experiment creation and file/folder management.
- 3) **Adding Experiment Building Blocks to the Graph.** To schedule an array of events in an experiment, the user needs to add individual building blocks (triggers, actions, sequences, and other components) to the workspace in the Graph Editor Window. Connecting components by arrowed-lines, which represent sequence and dependency relationships, forms the experiment flow. Please read Chapter 6 on flow diagram and Chapter 7 on the components of the Experiment Builder.
- 4) **Modifying Properties of Experiment Components.** The user will need to change the default settings for the actions, triggers, and sequences so that the experiment can be run in the intended way. For example, if a timer trigger is used, the user may change the maximum duration set in the trigger. If an invisible-boundary trigger is used, the desired triggering location needs to be specified. Similarly, the user needs to supply data for all actions. For example, if a display screen action is used, the user needs to add different resources into the screen builder and adjust the layout of the resource in the screen. To change the default settings for triggers, actions, and subsequences, and make the new values available for future uses, the

- user may make the modification through the preference settings of the Experiment Builder application (see Chapter 17).
- 5) ***Creating a Data Source.*** The Experiment Builder allows the user to create prototypical trials for the experiment and to supply actual parameters for individual trials from a data source. A data source can be created within the Experiment Builder or by loading a text file. The use of data source makes the creation of experiment more efficient and less error-prone. It also makes the randomization of trial order across participants easier (see Chapter 9 “Data Source” for details)
 - 6) ***Saving the Experiment Session.*** After the experiment is generated, don't forget to save the experiment session so that it can be re-opened later on.

2.2 Building and Test-running Experiment

After the experiment is created, the next step is to see whether there is any error in the experiment graph (for example, failing to make a connection between items, incomplete data source, wrong data type used, etc). The user can compile the experiment by clicking on "Experiment -> Build" menu to build the experiment. Build time errors (in red) or warnings (in orange) will be displayed in the "Output" tab of the Graph Editor Window. In most of cases, clicking on the error or warning message will select the experiment component at issue and thus enable the user to identify and fix up the problem quickly.

Please note that the above build process just checks whether there are obvious mistakes in the experiment graph but does not check for the content and validity of the experiment per se. Therefore, the user should test-run the experiment on a couple of participants to see whether the experiment does exactly what was intended by the experiment designer. By clicking on "Experiment -> Test Run", the experiment will be executed from the Experiment Builder application. For an EyeLink experiment, a connection to the tracker PC will be made and the user may record some data using mouse simulation. The EDF data file should be carefully examined to see whether all of the trial condition variables are properly recorded, whether interest areas and images are shown correctly, whether time-critical and other important messages are recorded for analysis, and so on. For a non-EyeLink experiment, the user may rely on a log file or result file to debug the experiment.

Important Note: Every time "Experiment -> Test Run" is performed, the experiment is rebuilt and all of previous data files in the experiment directory are deleted. Do not use "Experiment -> Test Run" for collecting real experiment data; "Experiment -> Test Run" is intended for testing purposes only.

2.3 Experiment Deployment

After fixing errors in the experiment graph and checking validity of the experiment, the user can then deploy the experiment to a new directory. This will generate a set of files in the intended directory. Please note that the "Experiment -> Test Run" step mentioned in the previous section must be used only for the purpose of testing and debugging the experiment graph. To collect experiment data, the user must use a deployed version of the experiment as it does not rely on the Experiment Builder application. In addition, running

the deployed version of an experiment generally has a better timing performance than running it directly from the Experiment Builder application because the computer is not running the Experiment Builder interface at the same time as the experiment. To run an experiment in a different computer, the user should copy the entire directory of the deployed version of the experiment to the new experiment computer. The experiment should be run at least once and results validated on the new computer before starting full data collection from multiple participants.

2.4 Participant Data Set Randomization

As mentioned earlier, the experiment designer can use Experiment Builder to create prototypical trials for the experiment and to supply the actual parameters of individual trials from a data source. In most experiments, the user will need to randomize trial order so that the experiment materials are not presented in the same sequence across participants. Randomization of data source can be done with either an internal randomizer or an external randomizer. These two randomization methods are almost identical and therefore the user may use the internal randomizer to perform randomization unless counterbalancing or Latin-square designs are needed.

Please note that configuration of the internal randomization settings should be done before deploying the experiment project whereas the external randomization can be done after deploying the experiment project (see Chapter 9 “Data source”).

2.5 Data Collection

Data can now be collected from the deployed version of the experiment. Double click on the executable file in the deployed experiment directory or type in the .exe file name from the command-line prompt. If the experiment uses a data source, a dialog will be displayed, allowing the user to choose the appropriate data source file. In an EyeLink© Experiment, the user will also be asked to enter the experiment session name. At the End of experiment, an EDF file will be generated for EyeLink© recording session and saved in the experiment directory. Optional result file(s) will be created if the user has specified them in EyeLink© and non-EyeLink© experiments.

2.6 Data Analysis

EyeLink© recording file can be conveniently analyzed with EyeLink© Data Viewer as the experiments created with Experiment Builder are fully integrated with this analysis tool. Experiment Builder sends messages to the data file so that images or simple drawing can be added as overlay background. The user can also specify trial variables, create interest areas, and send messages for the ease of data analysis. The result file(s) from a non-EyeLink© recording session contains columnar outputs for selected variables in the experiment. This file can be easily loaded by common statistics packages.

3 Installation

The current section covers system requirements for computers used to create and run experiments with Experiment Builder as well as installation and licensing issues.

3.1 System Requirements

The computer recommendations for SR Research Experiment Builder are in a large part dependant on the experimental paradigm being run. For example, an experiment that simply displays a single screen of text and waits for a manual response can run on a computer with much lower specifications than an experiment where video presentation is occurring during the trial. It is always suggested to get the best computer you can for running your experiments, even if you do not immediately plan on using all the features of the computer, however due to monetary considerations this is not always possible. The following computer specifications are guidelines only. SR Research can be contacted for input on what computer specifications would best match your actual experiment designs.

IMPORTANT: Regardless of the computer used and the experimental design, it is always critical to spend time evaluating the timing of the experiment designed to ensure that it is operating as expected.

3.1.1 Computer Configuration

The minimum configuration should be fine for use in simple reading and scene perception type experiments:

- Pentium 4 1.4 GHz or higher
- Windows 2000 (32-bit version) or Windows XP (32-bit version). **Note:** Windows Vista and 64-bit versions of Windows 2000/XP are **not supported**.
- DirectX 9.0 or later.*
- 256 Mb of memory
- Hard-drive with enough free space to hold experiment and data collected.
- 64 MB Video Card
- Monitor **
- Sound Card***
- Keyboard and Mouse
- USB port for Experiment Builder key
- If using EyeLink: Ethernet connection to the EyeLink tracker.

The recommended PC configuration should handle any experiment that can be created by the SR Research Experiment Builder, including video presentation, saccade contingent display changes, accurately timed audio presentation, audio recording, and ASIO-based voice key support.

- Pentium 4 2.4 GHz or higher with Hyperthreading enabled or with multiple cores.
- Windows XP (32-bit version) Service pack 2. **Note:** Windows Vista and 64-bit versions of Windows 2000/XP are **not supported**.

- DirectX 9.0 or later.*
- 1 GB of memory
- Primary 80 GB or larger 10,000 RPM hard drive
- Secondary 80 GB or larger 7,200 RPM hard drive
- 256 MB AGP 8x or PCI Express video card.
- High refresh rate CRT Monitor (120 Hz or higher)
- Creative SoundBlaster Audigy 2 ZS, or other tested ASIO sound card ***
- Keyboard and Mouse
- Free USB ports (for Experiment Builder key)
- If using EyeLink: Ethernet connection to the EyeLink tracker.

* To check the version of DirectX installed in the PC, type "dxdiag" in the DOS command line prompt or search for the "dxdiag.exe" file in the {windows}\system32 directory and click on it. This will bring up a "DirectX Diagnostic Tool" dialog box. If a version older than DirectX 9.0 is installed on your computer, an updated version of DirectX should be downloaded and installed from <http://www.microsoft.com/windows/directx/>.

** For the most accurate display timing it is strongly suggested that a CRT monitor is used, as LCD monitors can add extra delay in display updating. The retrace rate capabilities of the monitor should also be considered. We suggest that a video card and CRT monitor are used that can run at a minimum of 100 Hz.

*** Any Direct X compatible sound card can be used for hearing calibration and drift correction feedback tones and playing audio files where exact audio timing is not important to the experiment. In cases where accurate audio timing is important, or if the audio recording and/or computer base voice key features of the Experiment Builder will be used, then an ASIO compliant audio card must be available in the PC. The following cards have been tested and the status of the ASIO driver tests are listed. SR Research strongly suggests that a card from the table is used that supports the features required for your experiment.

ASIO-compatible Sound Card	Play	Record	Voicekey
Creative Soundblaster Audigy 2 ZS	Yes	Yes	Yes
Creative Soundblaster Audigy 2 ZS Notebook	Yes	Yes	Yes
Creative Soundblaster Audigy 2 ZS Gamer	Yes	Yes	Yes
Creative Soundblaster Audigy 2 ZS Platinum	Yes	Yes	Yes
Creative Soundblaster Audigy 2 Platinum ex	Yes	Yes	Yes
Creative Soundblaster X-Fi XtremeGamer	Yes	Yes	Yes
Creative Soundblaster Audigy 4	Yes	No	No
Creative Soundblaster Audigy SE	Yes	No	No
Other Creative Soundblaster Audigy Cards	?	?	?

For details on ASIO sound card selection and installation, please see section "Installation -> System Requirements -> ASIO Card Installation" in the html version of this document.

3.1.2 Maximizing the Real-time Performance of the Deployment PC

To maximize the real-time performance of the Deployment PC, the user should do the following:

- Shut down all other applications (browser windows, chat clients, email programs, etc) prior to running an EyeLink experiment. These applications are listed in the taskbar at the bottom of the screen.
- Shut down any programs (Norton Antivirus, volume controller, Windows Messenger, etc) running in the notification area of the taskbar where you usually see the current time displayed (lower-right corner of the screen).
- Make sure no scheduled tasks (e.g., data backup, virus checking) are active.
- Remove unnecessary devices (e.g., DV converter, flash disk, external hard drive) connected through the USB or firewire ports.
- Shut down screen-saver management. Click the right mouse button at a blank space on the display PC desktop to open a dialog box for display properties settings. On the "Screen Saver" tab, set the screen saver to "None".
- Shut down power management. Select the "Screen Saver" tab of the "Display Properties" dialog box and click on the "Power ..." button. In the "Power Options Properties" dialog box, turn off all features related to power management (hibernation, advanced power management support, turning off monitors or hard drives).
- For a computer with multiple Ethernet cards installed, use the Windows Control Panel to temporarily disable all network connections except for the one dedicated for EyeLink connection. The user should disable the firewall for the EyeLink Ethernet connection as well.

3.1.3 Host PC and Display PC Software Requirements

SR Research Experiment Builder works with EyeLink I, EyeLink II, and EyeLink 1000 eye trackers. EyeLink I users should make sure that version 2.11 of eyelink.exe file is installed on the host PC whereas EyeLink II users should use a recent version (2.0 or later) of eyelink2.exe. If the EyeLink Data Viewer is used for data analysis, the user should get the most recent version of the software. The DriverLinx parallel port driver (Port95NT.exe) should also be installed if the user is using a TTL action or trigger. This driver can be found at C:\Program Files\SR Research\Eyelink\bin directory of the display PC if Windows Display Software Package is installed. All of the above-mentioned software can be downloaded from the EyeLink Support Site at <http://www.sr-support.com>.

3.2 Installing Software

The latest version of Experiment Builder installer can be downloaded from <https://www.sr-support.com/forums/showthread.php?t=9>. If you have a previous version of Experiment Builder installed on the computer, please uninstall it with the Experiment Builder installer or with Windows© Control Panel tool "Add or Remove Programs" before installing the new version. By default, the Experiment Builder software will be

installed at "{Windows Drive}\Program Files\SR Research\Experiment Builder". Click on ExperimentBuilderW.exe to run the software.

3.2.1 For Standard Installation (applicable to most users)

The following installation instruction is applicable to users who use a standalone USB dongle that supports a single-PC license.

1. Install the Experiment Builder software. Double click on the sreb_1.*.exe installer, keeping the default settings.
2. Install standalone HASP key driver (if this is the first time that the USB dongle have been used on the display PC). Plug the dongle to the display computer. You may install the driver by clicking "Start -> All Programs -> SR Research -> Install HASP Driver" from your computer desktop or double clicking on "hdd32.exe" in "C:\Program Files\SR Research\Common" folder (see section 3.3.1 "HASP Driver Installation").
3. Check license status. Click on the License Manager utility to check for the licensing status for the Experiment Builder software (see section 3.3.2 "Software Licensing").

3.2.2 For Installation using Network Licensing

The following is applicable to the users who have purchased a network license (i.e., a shared license for several computers on a network that running Experiment Builder at the same time) for the Experiment Builder software.

1. Install the Experiment Builder software. Double click on the sreb_1.*.exe installer, keeping the default settings on InstallShield Wizzard screens except for the following two:
 - On the "Setup Type" dialog box, select "Custom".
 - On the "Select Feature" screen, make sure that both "HASP4" and "HASP4HL" driver options are selected.
2. Install network HASP key driver. You may install the driver by clicking "Start -> All Programs -> SR Research -> HASP HL Driver" from your computer desktop or double clicking on "HaspUserSetup.exe" in "C:\Program Files\SR Research\Common" folder.
3. Install network HASP License Manager. You may install the tool by clicking "Start -> All Programs -> SR Research -> Networked HASP License Manager" from your computer desktop or double clicking on "lmsetup.exe" in "C:\Program Files\SR Research\Common" folder. Failing to install this will report a "NO HASP Key Found" error in the SR License Manager dialog box.
 - When installing the license manager, set the "Installation Type" to Service (nhsrvice.exe).
 - On the "HASP License Manager" dialog box, check either Yes or No to continue.
4. If this is the server computer, you may install optional Aladin Monitor software by clicking "Start -> All Programs -> SR Research-> Aladdin Monitor" from your

computer desktop or double clicking on "Aksmon32.exe" in "C:\Program Files\SR Research\Common" folder.

5. Test license status.
 - Please make sure that the server and client computers are running and visible to each other in the same network group (check this out from "My Network Places -> View Network computers"). Contact your system administrator if the computers cannot see each other in the same network group.
 - Please make sure that the network license dongle is plugged to server computer (remove all other HASP dongles) and drivers are already installed.
 - Now, click "Start -> All Programs -> SR Research -> License Manager" to check for the licensing status for each of the client computers in the network.

Note: If you are using Experiment Builder for developing EyeLink experiments, test running experiments must be done using a secondary network card unless the EyeLink host computer also stays on the same network as the other computers.

3.3 Licensing

The user can run the Experiment Builder application in a demo mode immediately. All of the functionality of the licensed copy of Experiment Builder is available in the demo mode. However, an "UNLICENSED DEMO VERSION" text will be drawn on every display screen in an experiment that is created with the demo version of the software.

To run Experiment Builder in a fully licensed mode, the user needs to purchase a license code for the software and have a USB dongle connected to the Development PC on which the Experiment Builder software is installed. The physical USB dongle is the same one we use to license the EyeLink© Data Viewer. After purchasing the software license, the user will then need to contact us (eb@sr-research.com) with the ID of the USB Dongle.

3.3.1 HASP Driver Installation

If this is the first time that the USB dongle have been used on the display PC, you will need to install HASP key driver. Click "Start" from the desktop, go to "Programs -> SR Research -> Install HASP driver" to install the driver. Follow the default settings. If the driver installation is successful and the USB dongle is attached to the display PC, the dongle will glow red. Now you can check the dongle licensing status.

For some display PCs, you may see the following message when running the 'Install HASP driver':

"Installing the Device Drivers failed. Error message is:
Failed to start the Aladdin Device Driver.
Failed to start a service in the Service Control Manager Database."

If this is the case, you will have to re-install the HASP driver, please follow the steps below:

4. Remove the USB key from the computer.
5. Reboot the computer.
6. When the computer starts up, select "Add or Remove Programs" from "Start -> Control Panel".

If you see "HASP Device Driver" listed there, please go to Step 4.

If you do not see "HASP Device Driver" listed there, please click "Start" from the desktop, go to "Programs -> SR Research -> Install HASP driver" to install the driver. Insert the HASP dongle key to check whether it glows. If it works, ignore the rest steps. Otherwise, remove the dongle key and continue with Step 4.

7. Select "Add or Remove Programs" from "Start -> Control Panel". Click "HASP Device Driver" to uninstall the existing installation.
8. Download the new driver from <http://download.sr-support.com/Hinstall.zip>.
9. Once you download the driver, extract to a directory (e.g., C:\tmp; see the attached image install.JPG; make sure that you have kept the directory structure).
10. From desktop, go to "Start->Programs->Accessories->Command Prompt". On the command prompt type in the following two commands (see Figure 3-1):
cd <folder you extracted the Hinstall to>\Hinstall (eg. C:\tmp\Hinstall)
hinstall.exe -i
11. When the installation is in progress, you should see "Please Wait ..." message and "The operation was completed successfully" messages. If you don't see this, the installation is not completed and you'll need to redo the above steps.
12. Now, Insert the HASP dongle key to check whether it glows and whether the Data Viewer is fully licensed.

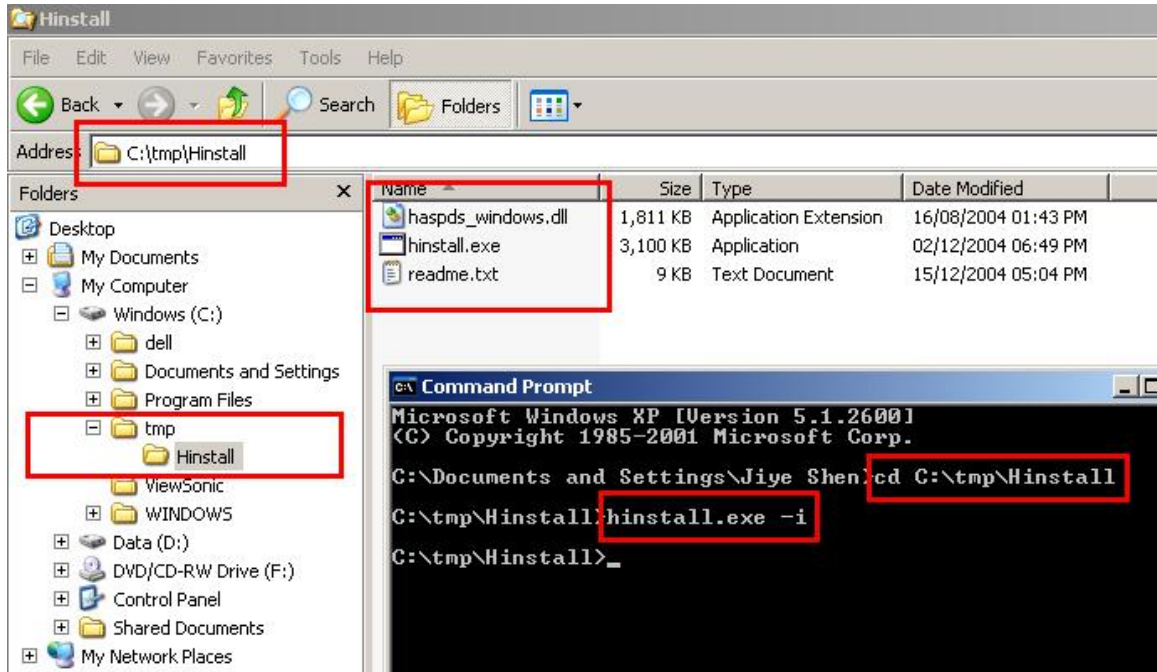

Figure 3-1. Installing new version of HASP key drvier

3.3.2 Software Licensing

To activate the Experiment Builder license, start "License Manager" program (click "Start" from the desktop, go to "Programs -> SR Research -> License Manager"). The ID of that dongle attached to the display PC will be displayed on the title of the dialog box. If the Experiment Builder License status is "No" and you have purchased the software license, please contact support@sr-research.com with that dongle ID; you will be given a license code for running Experiment Builder with that dongle. Click on the license button on the License Manager to enter the license code (see Figure 3-2).

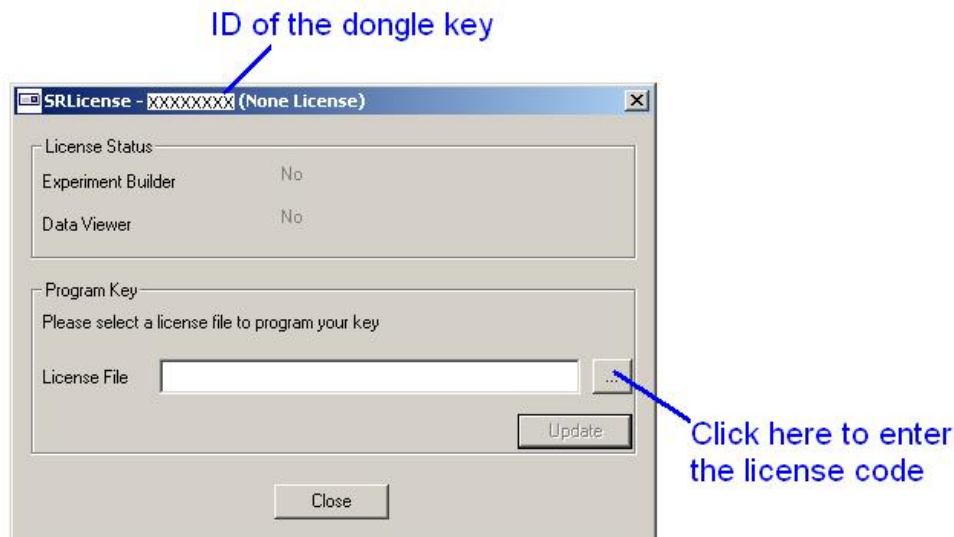

Figure 3-2. Getting the ID of USB Dongle Key and Entering Licensing Code

4 Working with Files

The SR Research Experiment Builder is used to create, build/test run, and deploy experiments. Each experiment creation session generates a binary file (graph.ebd), which contains the graphic layout of the experiment, and a set of supporting files and directories for preference settings, image loading, etc. With these files, the experiment creation session can be reopened later for review or modification. After the experiment is built, the user can deploy the experiment to a new directory. This will generate a set of files so that the experiment can be run on a different computer without relying on the Experiment Builder application.

4.1 Creating a New Session

To create a new experiment session, from the application menu bar, choose (see Figure 4-1):

File → New

Tip: A new experiment session can also be created by clicking on the “New Experiment” button () on the application toolbar, or by pressing shortcut keys Ctrl + N.

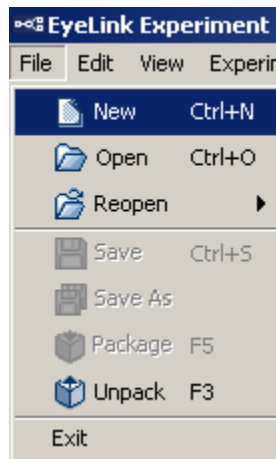

Figure 4-1. File Menu

This will bring up a “New Project” dialog (see Figure 4-2), prompting for the experiment project name and a directory under which the experiment project should be saved. Enter the name for the session in the “Project Name” edit box. Click on the button on the right end of the “Project Location” to browse to the directory where the experiment files should be saved. If you are manually entering the “Project Location” field, please make sure that the intended directory already exists.

Note: The experiment session name must start with a letter between ‘a’ and ‘z’ or ‘A’ and ‘Z’ and may contain letters, digits, and the underscore character. If there is any space in the filename, this will be replaced by an underscore. An “Invalid Value” error dialog box will be displayed if the format of session label is invalid.

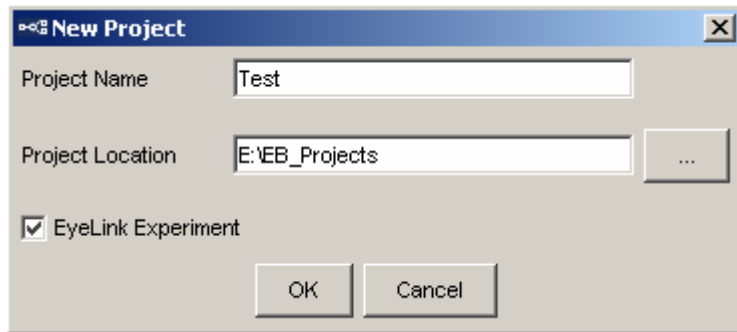

Figure 4-2. Dialog for Creating a New Project

After the experiment is generated, the following files and folders are created.

```

Experiment
  |--- [datasets]
  |--- [library]
      |--- [audio]
      |--- [customClass]
      |--- [images]
      |--- [interestAreaSet]
      |--- [video]
  |--- [myfiles]
  |--- [runtime]
      |--- [dataviewer]
      |--- [images]
  |--- graph.ebd
  |--- Preferences.properties
  
```

- *graph.ebd*: This file contains the experiment graph. Double clicking on this file will open the experiment session.
- *Preferences.properties*: This file contains the preference settings for the current experiment session.
- *datasets*: This is the directory where the data source file is located.
- *library*: This is the folder where the image, audio, interest area set, and video files are contained.
- *runtime*: This folder contains all of the runtime image and Data Viewer integration files (image drawing list and interest area set files).

Please avoid using non-ASCII characters in the project name or directory path as this may cause runtime problems.

Note: If you are running Experiment Builder from a non-Administrative account of Windows XP or 2000, you should create the new projects to the user account directory

(i.e., the project location should be "{Windows Drive}\Documents and Settings\{User Account}\My Documents"). Similarly, you should deploy your experiments to the user account directory.

Note: The above files and folders are created and maintained by the Experiment Builder. **The user should not attempt to modify these files and folders or store important files in the experiment project folder except within "myfiles" directory.** The Experiment Builder will overwrite any manual changes made to the experiment project directory (except "myfiles").

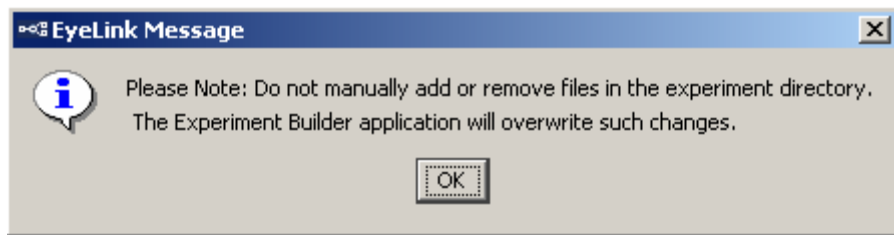



Figure 4-3. Warning Messages after Experiment Creation

4.2 Saving a Session

An experiment session can be saved by choosing from the application menu bar:

File → Save

Tip: The experiment creation session can also be saved by clicking on the **Save** button  on the application tool bar, or by pressing the shortcut keys CTRL + S.

If there is any change to the experiment session, the previous experiment graph is saved as “graph.ebd.bak” in the experiment directory.

4.3 Saving an Existing Session to a Different Directory

To save an experiment session with a different session name and/or in a different directory,

- 1) From the application menu bar, choose:
File → Save AS
- 2) In the Save As dialog box, click on the button to the right of “Project Location” to browse to the directory where the session should be saved.
- 3) Enter the new session name in the Project Name edit box.
- 4) Click OK button.

Tip: The session can also be saved by clicking the “Save As” button  on the application tool bar.

4.4 Opening a Session

To open an existing experiment session from the Experiment Builder application,

- 1) From the application menu bar, choose:
File → Open
- 2) In the “Open” dialog box, browse to the directory of experiment and select the “graph.ebd” file (see Figure 4-4).

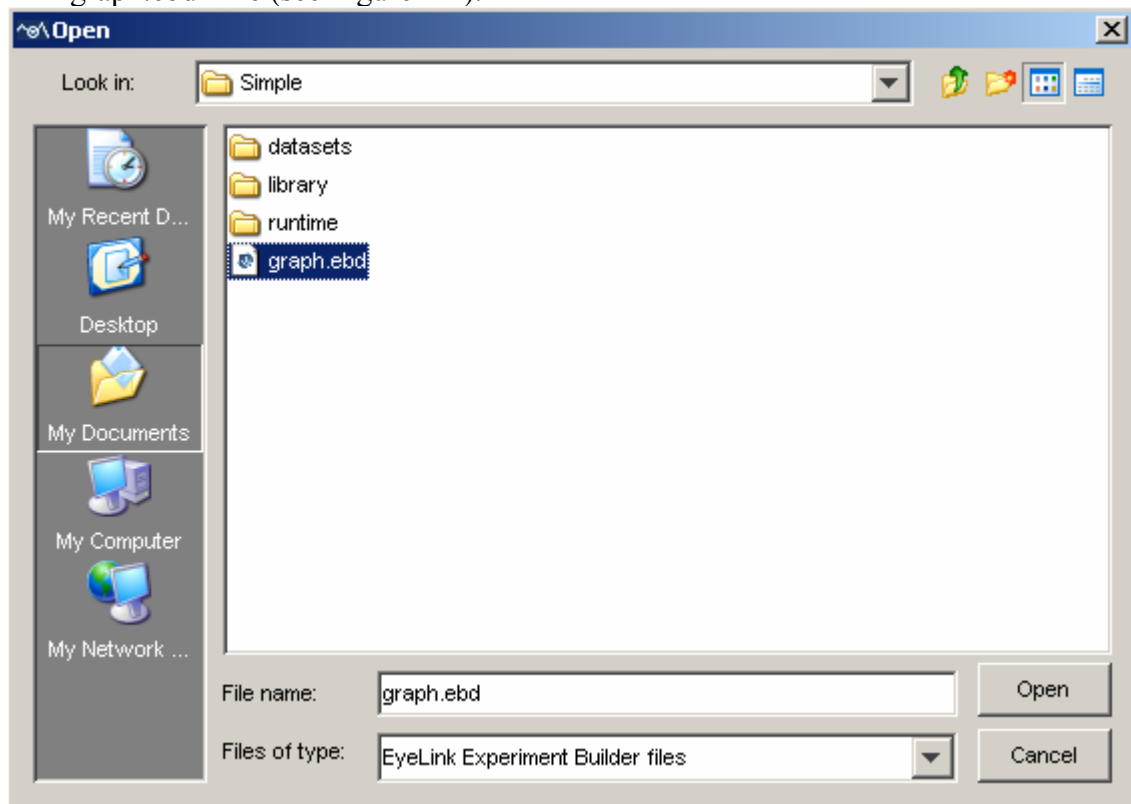

Figure 4-4. Open an Experiment Builder Session

- 3) Click on the “Open” button.

Note: If an experiment is already open in the current session, the “Open” operation will first bring up a “Save Confirmation” dialog box so that the user can either save the current session (“YES”), abandon the current session (“NO”), or stay in the current session (“CANCEL”; see Figure 4-5).

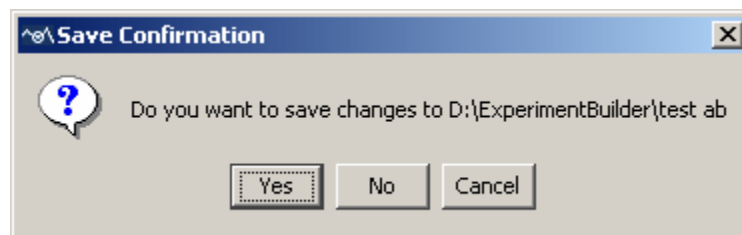



Figure 4-5. Save Confirmation When Opening a New Session

Tip: A saved experiment session can also be opened by clicking on the Open button  on the application toolbar, or pressing the shortcut keys **Ctrl+O**.

Note: The user can also open an existing experiment project with Window Explorer by going to the directory where the experiment project is contained and double clicking on the *graph.ebd* file.

4.5 Reopening a Recent Experiment Session

Experiment Builder keeps a history of five recently opened experiment projects. If the user needs to reopen a recent experiment project, try:

- 1) from the application menu bar, choose:
File → Reopen
- 2) from the list of recent experiment projects, choose the project to open (see Figure 4-6).

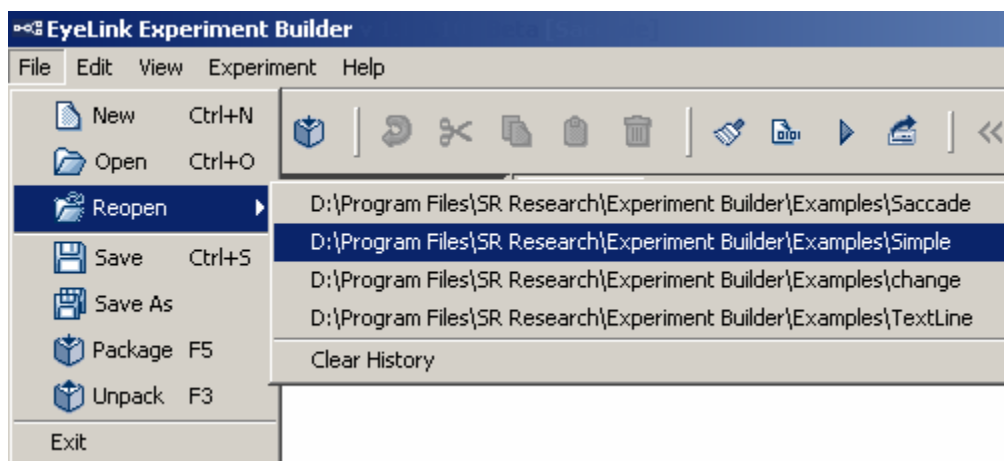

Figure 4-6. Reopening Recent Experiment Sessions

A “File Not Found” error will be displayed if the intended experiment project has been moved, renamed, or deleted. To clear the list of recent projects, click on the “Clear History” menu.

4.6 Packaging an Experiment

The user can pack up the current experiment project by clicking

File → Package

from the application File menu.

This will zip up the experiment directory and save the zip file at a location selected by the user. The created .zip file contains only the files necessary to rebuild and run the experiment (*graph.ebd*, *Preferences.properties*, and *library* directory). The packed project can be unpacked by Experiment Builder.

Tip: The experiment can also be packaged up by clicking the “Package” button  on the application tool bar or pressing F5.

Experiment packaging is very useful if you want to send another Experiment Builder user an experiment you have created so they can modify the experiment in the Experiment Builder.

4.7 Unpacking an Experiment

The packed experiment project can be unpacked by clicking

File → Unpack

from the application File menu. In the following dialog, the user should select the packed project (source) and specify a directory to which the project should be unpacked. Note that the packed project may be opened by common zipping/unzipping utilities such as Winzip (version 8.0 or later) and WinRAR. However, the project may not be opened properly by these zipping utilities if the project name contains non-ASCII characters.

Tip: A packed project can also be unpacked by pressing F3.

4.8 Building an Experiment

After creating the experiment, the user needs to compile the experiment to make sure that there is no error in the experiment graph. To do that, from the application menu bar, choose (see Figure 4-7):

Experiment → Build

Tip: Building an experiment can also be performed by clicking on the “Build” button  on the application tool bar or pressing F9.

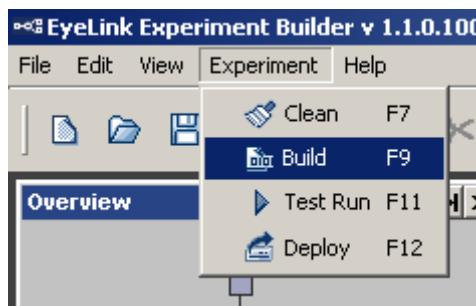



Figure 4-7. Experiment Menu

4.9 Cleaning an Experiment

Sometimes the user may want to clean up the experiment projects. This is especially important when the user has changed the images or other screen resources used for the experiment. To do that, from the application menu bar, choose:

Experiment → Clean

Tip: Cleaning an experiment can also be performed by clicking on the “Clean” button  on the application tool bar or by pressing shortcut key F7.

4.10 Test-running an Experiment from EB Application

To check whether the experiment works, the user may test-run the experiment from the Experiment Builder application. To do that, from the application menu bar, choose:

Experiment → Test Run

This will create a “Results” directory, containing data collected from the test run-session. Note that test run is not intended for real data collection and should be only used when you are testing your experiment.

Tip: Running an experiment can also be performed by clicking on the “Test Run” button  on the application tool bar or pressing the shortcut key F11.

Note: If the experiment is tested under dummy mode, a warning dialog box "You are running in dummy mode! Some eye tracking functionality will not be available" will be displayed at the beginning of the experiment and a warning dialog "No EDF file is created for dummy mode session" will be displayed at the end.

4.11 Deploying an Experiment

To deploy a built experiment so that it can be run on a different computer without relying on the Experiment Builder application, choose from the application menu bar:

Experiment → Deploy

Upon receipt of the deployment command, Experiment Builder asks for a directory to deploy. If the user selects a directory, a subdirectory with the name of the experiment session is created within it. This experiment subdirectory contains all of the required files generated. The user can cancel the deploy process by pressing the “Cancel” button. Please note that non-ASCII characters are not allowed in a deployment path (e.g., deploying a project to a folder that contains Chinese characters will fail).

Tip: Deploying an experiment can also be performed by clicking on the “Deploy” button  on the application tool bar or pressing shortcut key F12.

4.12 Running an Experiment for Data Collection

To run the experiment for data collection, simply double click on the executable file in the deployed directory, or from your computer desktop, click "Start -> All Programs -> Accessories -> Command Prompt". Go to the deployed experiment directory by typing "cd {experiment path}" on the command prompt and type the {experiment}.exe file name to start the experiment. Running the experiment from the command line prompt also allows the user to pass additional parameters to the program. Some of the useful command line options are:

- -session= <your edf or session name >

If the "-session" option is used, the software will not prompt for a session name via a dialog box at the beginning of the experiment. The session name pass along the "-session=" option must be within eight characters (consisting of letters or numbers).

- -ui=[GUI|CONSOLE|NONE]
The "-ui" option allows to disable the file transferring dialog box at the end of the session. If -ui=GUI the graphical progress bar is popped up(default); if -ui=CONSOLE progress updates are printed to the console; if -ui=NONE no progress messages are brought to the user. For example, for an experiment named "simple_deployed", you can pass the "-ui=NONE" to disable the files transfer progress bar.
`simple_deployed -session=myTest -ui=NONE`
- The actual parameters passed along the command line can be retrieved through the "Command Line Arguments" property of the Experiment node.

If the experiment needs to be run on a different machine with similar or better computer specifications, the user should first copy the entire directory of the deployed version of the experiment to that computer. The user should also pay attention to the following details:

Important: See section 3.1.2 regarding experiment runtime performance and steps that should be taken to maximize the real-time performance of the deployment computer.

5 Experiment Builder Graphical User Interface

The SR Research Experiment Builder uses a desktop framework that contains all windows of the application. The following figure shows a typical graphical user interface (GUI) the experiment designer will see in an experiment generation session. Besides the standard windows application menu bars and tool bars, the experiment builder desktop can be divided into two major parts: the Project Explorer Window on the left and the Graph Editor Window on the right. The Project Explorer Window lists all of the experiment components in a hierarchical fashion and allows the designer to select components for review or modification. The Graph Editor Window allows the designer to create the experiment graph by dragging individual building blocks and making connections between components to form experiment flow.

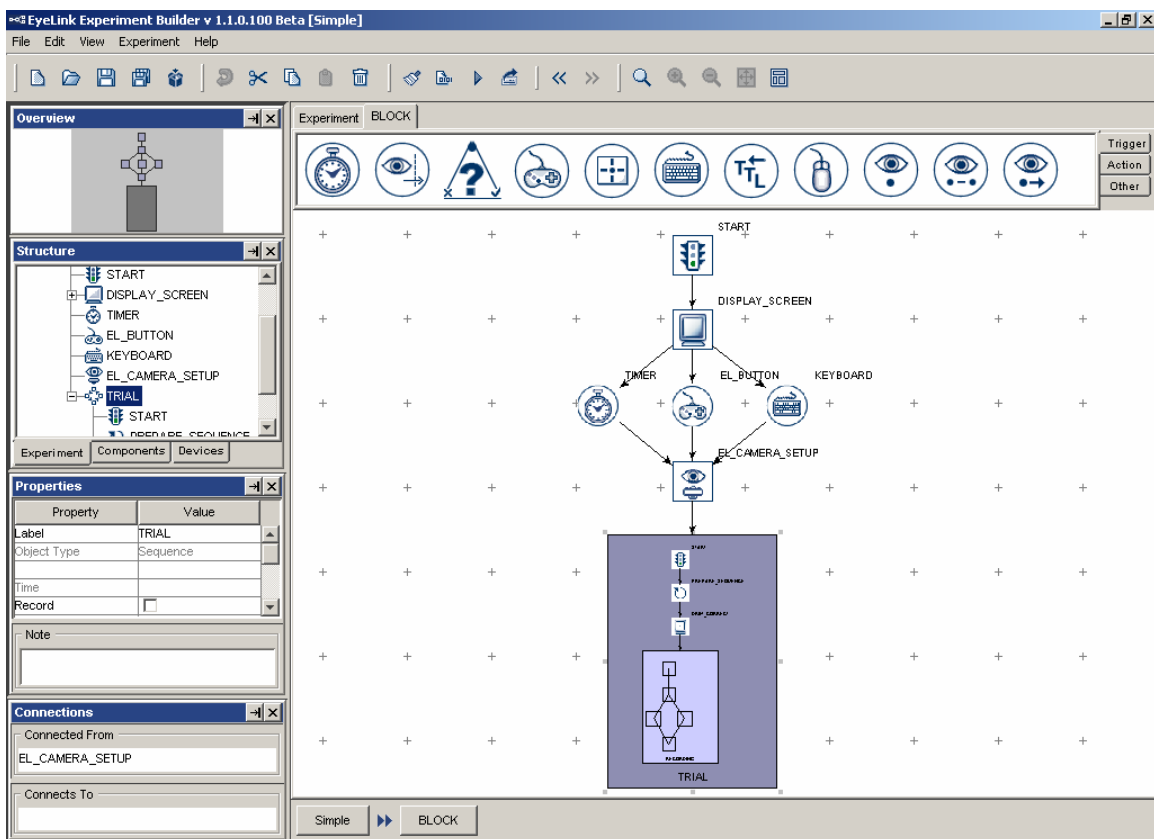

Figure 5-1. Sample Experiment Builder Interface

5.1 Project Explorer Window

The Project Explorer Window allows the designer to select experiment components to be viewed, to modify the current property values, and to configure default devices (eye tracker, display, audio driver, TTL, and Cedrus© input settings). This window has four individual panels: Overview, Structure, Property, and Connections panels. Each of the individual section can either be a docked (☰) panel of the project Explorer window or a free-floating (☞) window. In addition, each of the panels can be hidden or made visible from the "View" menu.

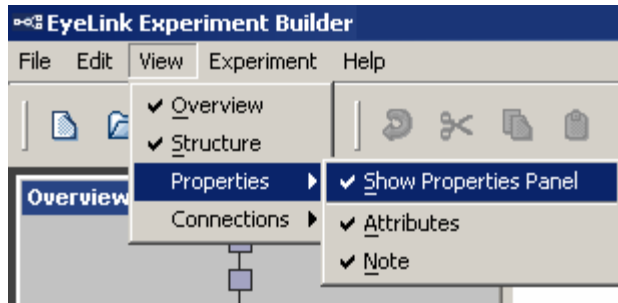

Figure 5-2. The View Menu.

The Overview panel (on the top) shows the graph layout of all components in the current level of experiment and highlights the currently selected components. The part of the graph within a gray background is currently visible in the workspace of the Graph Editor Window. The designer can choose to work on a different part of the graph by placing the mouse cursor on top of the gray area, holding down the left mouse button, and move the gray background to cover the intended region.

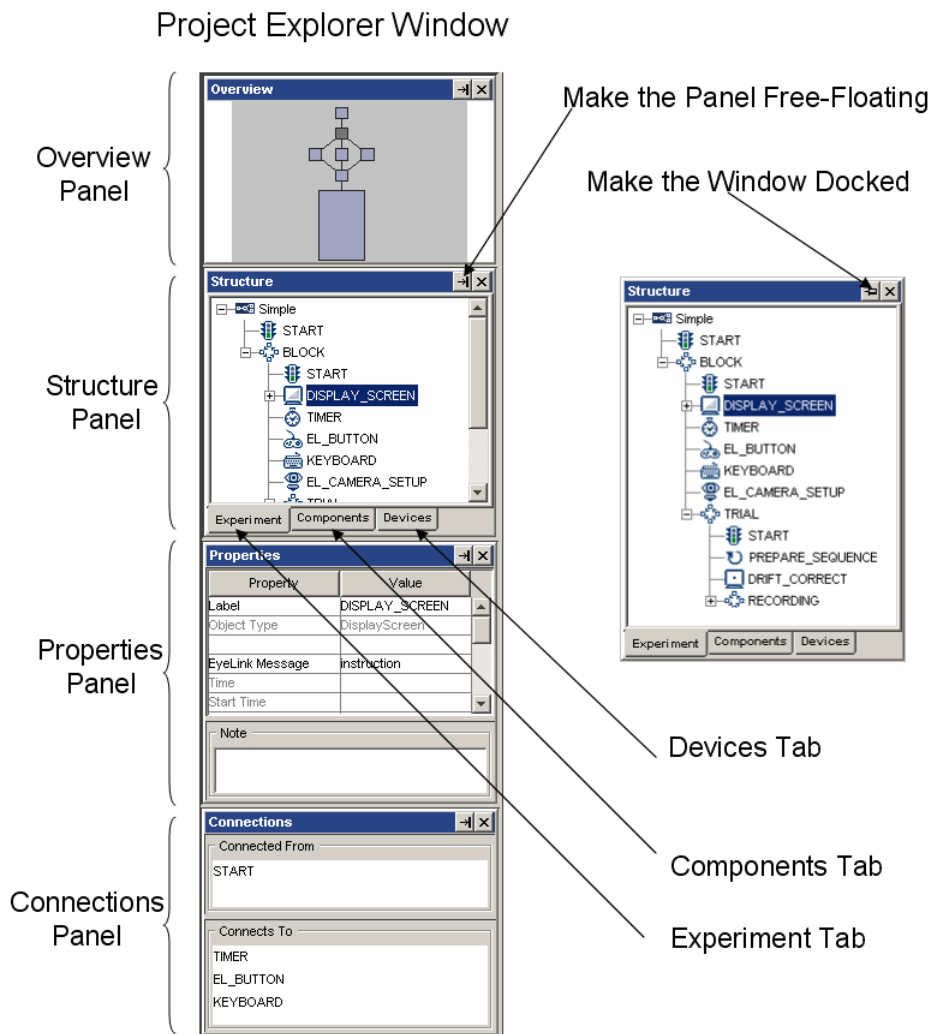

Figure 5-3. Components of the Project Explorer Window

The Structure panel (in the middle) lists the components used in the experiment. This panel has three tabs: Experiment, Components, and Devices. The Experiment Tab (left panel) contains a hierarchical representation of the Experiment -- all component nodes are listed under the sequence in which they are contained. The Components Tab (middle panel) lists the nodes by type (triggers, actions, or other components). Similar to the interface used by Windows Explorer, if a certain type of components is used, the folder containing those components can be opened (⊕) or closed (⊖). The Devices Tab (right panel) allows the designer to configure default settings for the EyeLink© tracker, experiment display and other devices (see preference settings).

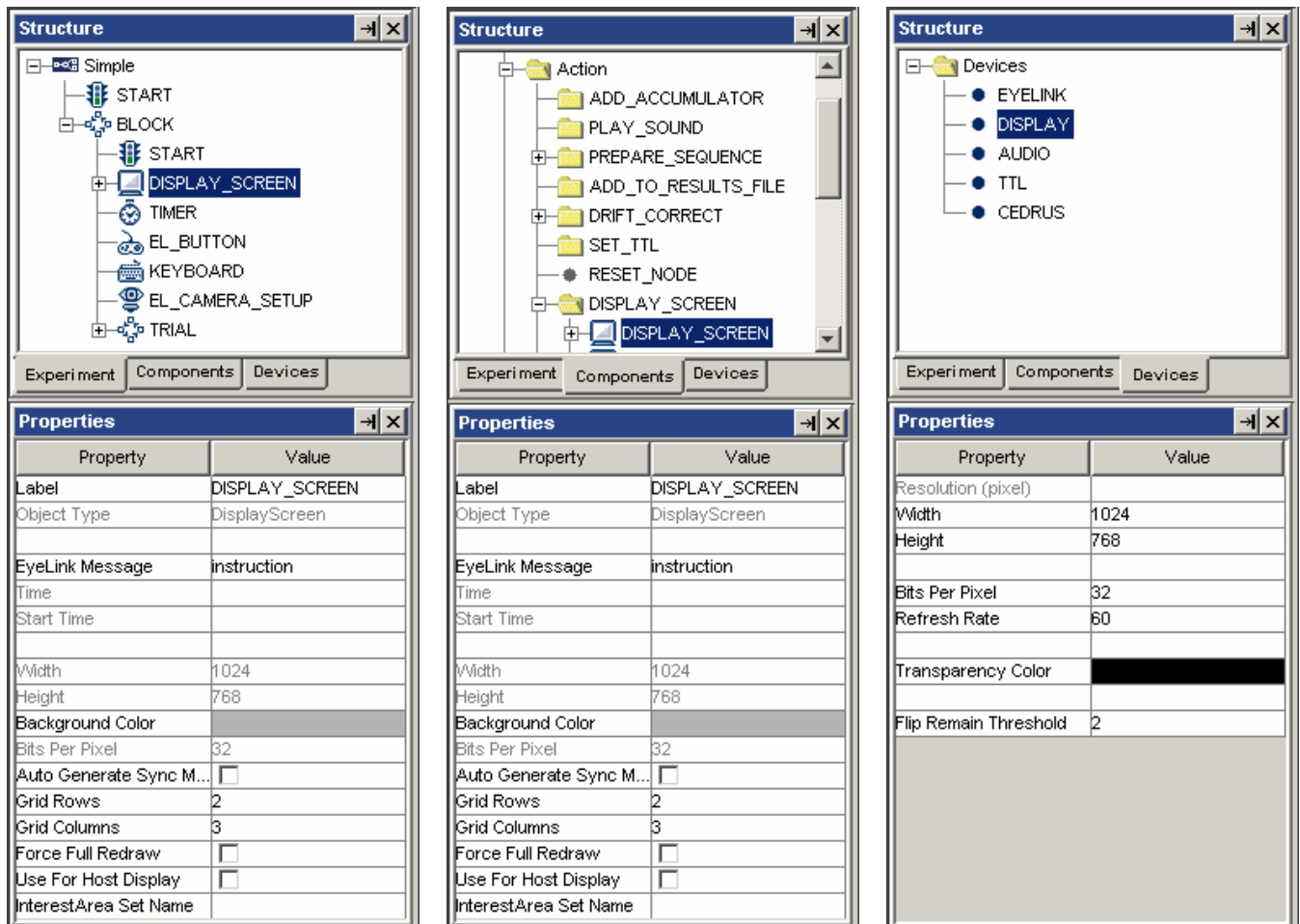

Figure 5-4. Different Tabs of the Structure Panel

The Properties panel (at the bottom) displays attributes associated with the selected item in the Structure panel. The designer can review the current settings for the attributes and make modifications if necessary. Please note that if a property field is grayed out, the value of the property cannot be directly modified but may be referred (e.g., "Time" of the DISPLAY_SCREEN action) whereas all of the other properties may be modified directly

(see section 7.5 "Editing Properties of a Node"). The Note section of a properties panel allows the user to add comments to the node.

The Connections panel lists all of the nodes that are connected to the current node. The "Connected From" section lists all of the nodes that target the current node and the "Connects To" section lists all of the nodes that receive a connection from the current node.

5.2 Graph Editor Window

The Graph Editor Window provides the interface where the experiment can be created graphically. This window can be divided into four sections: the Component Toolbox, Work Space, Editor Selection Tabs, and Navigation Nodes.

The Component Toolbox contains the basic building blocks of the experiment graph and allows the designer to select a desired component to be added into the experiment. The experiment components are grouped under three categories: trigger (including timer, invisible boundary, conditional, EyeLink© button, Cedrus© Input, TTL, keyboard, mouse, voice key, fixation, saccade, and sample velocity trigger), action (displaying screen, performing camera setup, performing drift correction, sending EyeLink© message, logging experiment, sending EyeLink© command, updating variable attribute, preparing sequence, adding to result file, adding to accumulator, sending TTL signal, playing/recording sound, controlling sound playing/recording, terminating experiment, or recycling data line), and other type (variable, result file, and accumulator).

The Work Space provides a venue where the experiment is generated. In an empty sequence, the Work Space area contains a START node to which actions and triggers can be connected. The designer needs to drag selected experiment elements from the Component Toolbox and drop them to the work space and make connections from/to other components. The designer can further select individual items for property editing.

The Editor Selection Tabs and Navigation Nodes provide convenient shortcuts for selecting a display screen or an experiment subgraph (sequence) to work on. When an experiment involves several different layers of subgraphs (for example blocks -> Trials -> Trial Recording), the Navigation Nodes at the bottom of the graph editor window informs the designer of the layer that they are currently at. The designer can switch to work on a different level by a simple click on the target sequence. In addition, all of the experiment sequences and display screens created in the experiment, as well as the project output screen, are listed as individual Editor Selection Tabs above the Component Toolbox for direct access.

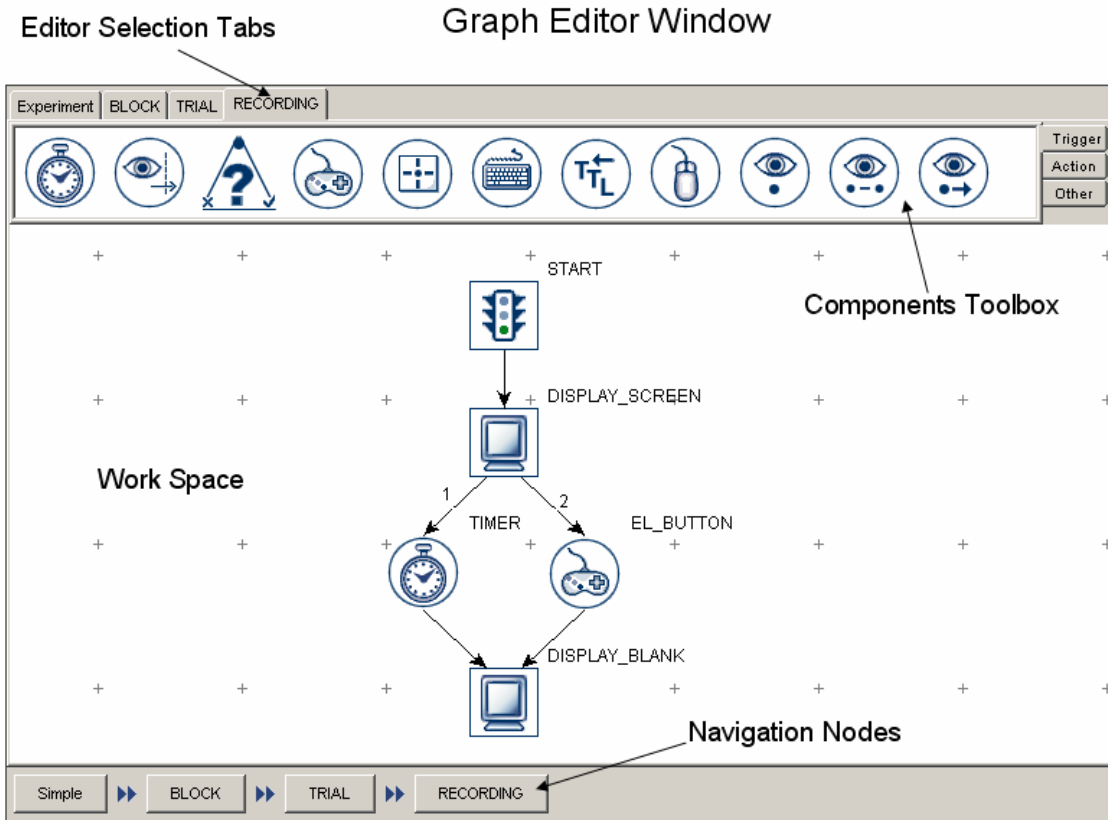

Figure 5-5. Components of the Graph Editor Window

5.3 Application Menu Bar and Toolbar

The Experiment Builder application menu bar and toolbar contain a list of common operations. If you are a menu-oriented person, you may access all of the operations from the menu bar. Most of the operations can also be performed by keyboard shortcuts or by using buttons on the application toolbar.

5.3.1 File Menu and Tool Buttons











Commands that affect creating, opening, saving, packaging, or closing the Experiment Builder sessions are located here (see Chapter 4 for details).

Operation	Short Cut	Function
New	CTRL + N	Creates a new experiment project.
Open	CTRL + O	Opens an existing experiment project.
Reopen		Reopens a recent Experiment Builder project.
Save	CTRL + S	Saves the current experiment project.
Save As		Saves the experiment project to a different directory.
	F5	Used to compress the experiment project into a .zip file for file

Package		sharing, etc.
 Unpack	F3	Used to extract the experiment project from a compressed .zip file.
Exit		Closes the Experiment Builder application.

5.3.2 Edit Menu and Tool Buttons

This menu contains commands such as copy, paste, cut, delete, and undo. The menu also contains tools for resource library management, node group organization, and preference settings (see Chapter 17).

Operation	Short Cut	Function
 Undo	CTRL + Z	Undoes the last action performed.
 Cut	CTRL + X	Removes a selection from the project and place it into the clipboard.
 Copy	CTRL + C	Puts a copy of a selection to the clipboard.
 Paste	CTRL + V	Inserts the previously copied item from the clipboard to the current position.
 Paste Multiple	CTRL + V	Inserts the previously copied item from the clipboard to the current position.
 Delete	Delete	Removes the selection from the current location.
 Preferences	F4	Shows a list of preference settings for Experiment Builder.
 Refresh Custom Class	CTRL + H	Refreshes the Custom Class files (i. e., reparses the contents of the files). This tool is useful to users who use an external editor to edit the content of custom classes.
 Library Manager	CTRL + L	Used to load in image, audio resources, or interest area set files.
 Reference Manager	CTRL + R	Tabulate the source, property, and value of each reference used in the experiment graph (see section 10.5).
 Node Groups	CTRL + G	Allows the user to rearrange the layout of the components in the component toolbox and structure list.
Select All	CTRL+ A	Selects the entire contents of the active window.





5.3.3 View Menu

This menu contains commands that display or hide panels in the project explorer window.

Operation	Short Cut	Function
Overview		If enabled (a tick to the left), displays the Overview panel.
Structure		Displays the Structure panel.
Properties		Displays the 'Attributes' and 'Note' section of the Properties Panel.
Connections		Displays the 'To Connections' and 'From Connections' section of the Connections Panel.
Navigator		Displays the Navigation Nodes" in the Graph Editor Window



5.3.4 Experiment Menu and Tool Buttons

Commands used to compile and run the experiment, clean up the experiment project, and to create a deployment version of the experiment are located here (see Chapter 4 for details).

Operation	Short Cut	Function
 Clean	F7	Used to clean up the experiment project
 Build	F9	Used to compile the experiment
 Test Run	F11	Used to test run the experiment from the Experiment Builder application
 Deploy	F12	Used to generate deploy code for running experiment without replying on the Experiment Builder software.

5.3.5 Help Menu

This menu contains commands that display licensing and product release information (see Chapter 3 for details).

Operation	Short Cut	Function
 Contents	F1	Displays the online help (this document) of the Experiment Builder application.
 About		Displays the Experiment Builder release information.
 Purchase		Displays license information for this copy of Experiment Builder

6 Designing an Experiment in Experiment Builder

This chapter introduces the general concepts of experiment design in the Experiment Builder: hierarchical organization of events in an experiment, flow diagram, and attribute referencing. It also provides an overview of Experiment Builder components (triggers, actions, sequences, and other nodes) and linking rules for the experiment graph.

6.1 Hierarchical Organization of Experiments

One of the important concepts in SR Research Experiment Builder is hierarchical organization of events in an experiment. A typical experiment can be dissected into several levels along a hierarchy of Experiment -> Blocks -> Trials -> Trial Runtime / Recording. All of the events within each level of this hierarchy can be conveniently wrapped in a loop (called sequence or sub-graph in Experiment Builder). This allows the whole sequence to be connected to other objects as a unit and be repeated several times in a row.

The following figure illustrates a common high-level EyeLink experiment architecture. To create an experiment, the designer needs to create several nested sequences, add a list of actions and triggers to each sequence, and make necessary connections between components to form experiment flow. In this example, the top-most level of the experiment (Experiment Sequence) contains a greeting message or instruction screen followed by a sub-sequence representing blocks of trials (Block Sequence), and then a goodbye or debriefing message at the end of the experiment. Within each repetition of the Block Sequence, the user first performs a camera adjustment, calibration and validation, and then runs several trials (Trial Sequence). Every iteration of the Trial Sequence starts with pre-recording preparations (e.g., preloading image, audio, video resources, clearing trigger data, sending some simple drawing graphics to the tracker screen, flushing log file) and drift correction followed by the trial recording (Recording Sequence), and finally displaying feedback information if necessary. The Recording Sequence is responsible for collecting the eye data and is where visual and auditory stimuli are presented. Response collection from the participant is also performed in the Recording Sequence.

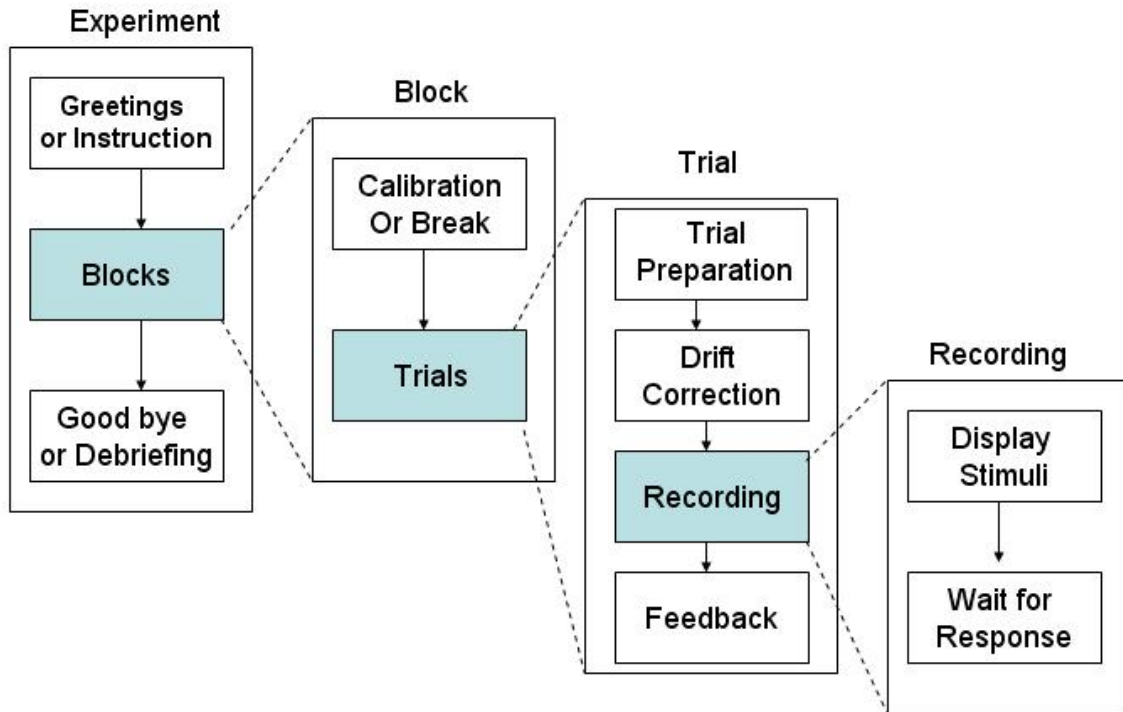

Figure 6-1. Hierarchical Organization of Events in an Experiment

6.2 Experiment Graph: Flow Diagram

Experiment Builder uses an intuitive flow diagram interface for experiment generation -- the whole experiment generated can be called a graph. Like a drawing board, the user can drag and drop experiment components into the workspace of the graph editor window. These experiment components are usually either triggers or actions that represent individual events and preconditions in the experiment. An Action tells the computer to do something, like displaying a screen or playing an audio clip, whereas a Trigger represents some precondition that must be met for the experiment to continue past that point. Experiment components are connected to each other using arrowed lines that represent sequence and dependency relationships (i.e., X must be done before Y can be done). The connection of experiment components forms the flow of the experiment. The following figure illustrates a very simple experiment sequence with gaze-contingent manipulation.

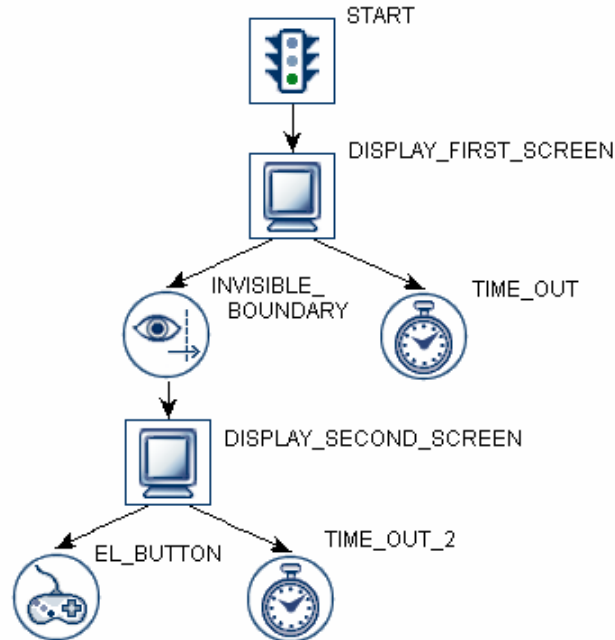

Figure 6-2. Sample Experiment Sequence

In this example, the experiment sequence starts with a `DISPLAY_FIRST_SCREEN` action, which draws graphics to the computer display. Now the sequence constantly monitors two Triggers until one of the Triggers is satisfied: an `INVISIBLE_BOUNDARY` trigger and a `TIME_OUT`. The `INVISIBLE_BOUNDARY` is triggered if the participant's gaze falls within a pre-specified region of the screen whereas the `TIME_OUT` is triggered if a specified amount of time (e.g., 30000 milliseconds) has passed since `DISPLAY_FIRST_SCREEN` was drawn.

If `TIME_OUT` is triggered, the sequence ends since the `TIME_OUT` Trigger does not connect to any subsequent experiment components. However if `INVISIBLE_BOUNDARY` is triggered, `DISPLAY_SECOND_SCREEN` action is performed and draws new graphics to the computer display.

Now the sequence monitors two new Triggers: a `TIME_OUT_2` trigger and an `EL_BUTTON` trigger. The `EL_BUTTON` trigger fires if the participant presses a button on the EyeLink© button box. `TIME_OUT_2` is triggered if a pre-specified duration has elapsed since the second display was drawn. The sequence ends when either of the triggers (`EL_BUTTON` and `TIME_OUT_2`) becomes true.

Important: Note that in the above example, once the `DISPLAY_SECOND_SCREEN` Action has been performed the `TIME_OUT` and `INVISIBLE_BOUNDARY` Triggers are no longer monitored; only the Triggers connected to the last processed Action are monitored.

6.2.1 Adding Components to an Experiment

In the Experiment Builder graphical user interface, the user can add individual components to the workspace of the Graph Editor Window by dragging them from the

component toolbox. To do that, first choose the right node group by clicking on the Trigger or Action, or Other Tab of the Components Toolbox. Place the mouse cursor on the icon of the desired component, press the left mouse button, hold it down as you move the mouse to drag the selected item to the desired location in the work space, and then release the left mouse button. (To find out the meaning of a component, simply place the mouse cursor over the icon.)

6.2.2 Linking Experiment Components

The flow of an experiment sequence moves from the default "START" node to one or several triggers or actions and then to other triggers or actions, and so on. This requires the designer to connect two experiment components with arrowed line to establish a directional or dependency relationship between a "Source" component and a "Target" component.

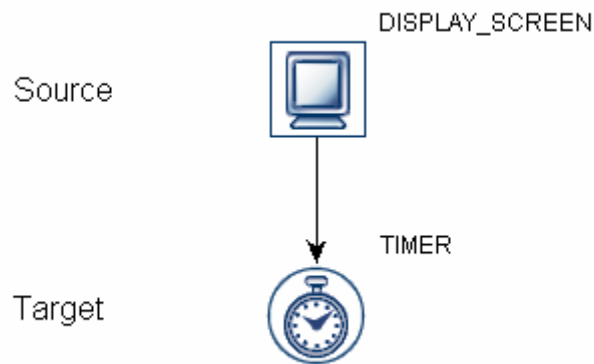



Figure 6-3. Connecting between Source and Target Components

To make a connection from a Source component to a Target component, place the mouse cursor on the Source component, hold down the left mouse button (without releasing the button as this constitutes a mouse click and will select the item instead), move the cursor to the Target component, and then release the left mouse button. To cancel a connecting operation in progress, press the "ESC" key. To remove a connection between two experiment components, click on the connecting line until it is highlighted in yellow, and then press the "Delete" key on the keyboard or select the  button on the application tool bar.

6.2.3 Linking Rules







The connection between a Source and Target component is governed by a set of rules:















- 1) A node cannot be connected to itself.
- 2) You cannot connect two components in the same direction twice.
- 3) The START node cannot be a Target (i.e., it cannot receive a connection from other components). The Source START node can target to an action, trigger, or sequence.

- 4) A Source node cannot have more than one Target Action; unless it is a Conditional Trigger in which case each conditional branch cannot Target more than one Action component.
- 5) A Source component can target many Trigger nodes.
- 6) A Source node cannot target a Trigger and an Action component at the same time.
- 7) A Sequence action cannot target a Trigger node.
- 8) A Target trigger node cannot receive connections from multiple source trigger nodes.
- 9) A Source node cannot target multiple Sequence nodes. That is, the current version of Experiment Builder does not support parallel processing.
- 10) A Drift Correct Action or Camera Setup Action cannot target any Trigger.
- 11) Storage space elements (Accumulator, Variable, and Result File) cannot be Source or Target Nodes (i.e., never directly connected to other components).
- 12) Certain node types, such as Fixation, Saccade, Invisible Boundary, and Sample Velocity Triggers, can only be added to a sequence that has the "Record" checkbox enabled.
- 13) Drift Correct and Camera Setup Actions cannot be added to a sequence that has the "Record" checkbox enabled.
- 14) A Trigger can not be the target of an action and a trigger at the same time.

6.3 Actions

Action components instruct the computer to do something, like displaying a screen or playing a sound. One or multiple actions can be added to a sequence, depending on the complexity of the experiment. For example, a recording sequence showing a static page of text may just require a single display screen action whereas an experiment studying change detection necessitates several display screen actions to present alternating screens at a fixed interval. SR Research Experiment Builder supports the set of actions listed in the following table.











	Display Screen	Used to show a set of 2D graphics on the computer screen. Please follow Chapter 8 "Screen Builder" to modify the content of the screen.
	Camera Setup	Displays the EyeLink© camera setup screen for the experimenter to perform camera setup, calibration, and validation.
	Drift Correction	Performs an EyeLink© drift correction by using a fixation point at a known position to correct for small drifts in the calculation of gaze position that can build up over time. This is particularly useful when using the pupil-only mode of EyeLink.
	EyeLink© Command	Sends a text command to the EyeLink© tracker through the Ethernet link for on-line tracker configuration and control.
	EyeLink© Message	Writes a text message to the EyeLink© eye tracker. The text is msec time stamped and is inserted into the EyeLink EDF file.
	Add to Log File	Allows the user to add text to a log file for experiment

		debugging.
	Prepare Sequence	Performs preparatory works for a sequence (e.g., preloading image or audio files, drawing feedback graphics on the host PC, and re-initializing trigger settings) to ensure real-time performance and better recording feedback.
	Add to Accumulator	Adds a number to an Accumulator object.
	Add to Result File	Used to output data to a tab delimited data to a Result File.
	Update Attribute	Updates the value of a Variable or an attribute of an experiment component.
	Send TTL Signal	Sends a TTL signal via the parallel port or other data ports.
	Reset Node	Allows the user to pick a node in the experiment and reset its data.
	Terminate Experiment	Used to terminate the experiment project programmatically.
	Recycle Data Line	Instruct the experiment sequencer to perform the current data source line again at a later time.
	Play Sound	Plays a .WAV audio file.
	Play Sound Control	Stop, pause, or unpause a specified playsound action
	Record Sound	Records audio to a .WAV file with an ASIO-compatible sound card.
	Record Sound Control	Stop, pause, unpause, or abort the current ASIO sound being recorded.
	Execute	Execute action is used to execute methods defined in custom class.
	Null Action	A dummy action used primarily for the purpose of controlling experiment flow and clearing cached trigger data.

6.4 Triggers





A Trigger is some condition that must be met for the sequence to continue past that point. Triggers are used by the Experiment Builder to control the transition from one Action to another, or to end a sequence itself. For example, in a simple reaction-time experiment, following the onset of the stimulus display a speeded response from the keyboard or a button box can be used as a trigger to end the trial. In a change-detection experiment, the time delay serves as a trigger to make the transition from one display screen to another (and therefore controls the exposure duration of a display screen). In a gaze-control experiment, a trigger for display change can be elicited when the eye is entering or leaving a pre-specified invisible boundary. SR Research Experiment Builder supports the following set of Triggers:

	Timer	Fires when a pre-specified amount of time elapses. Timers can be used to add a delay between actions and/or triggers, and to control the maximum amount of time a sequence can
---	-------	--

		last.
	Keyboard	Fires when a pre-specified keyboard key is pressed.
	Mouse	Fires when a specified mouse button is pressed or when the mouse's position falls within a specified region of the screen.
	TTL	Checks TTL input to the input ports (e.g., parallel port) of the display PC. TTL Trigger fires when a pre-specified TTL signal is received.
	Cedrus© Button	Fires when one of the pre-specified buttons on the Cedrus© response pad is pressed.
	EyeLink© Button	Fires when one of the pre-specified buttons on the EyeLink© button box is pressed.
	Boundary	Fires when one or multiple samples stay inside or outside of a pre-specified invisible boundary. Boundary trigger's can be used to implement display changes based on the locus of gaze.
	Fixation	Fires when a fixation occurs at a specific region of the display for a certain amount of time.
	Saccade	Fires following the detection of a saccade to a specific region of the display.
	Sample Velocity	Implements a "fast" saccade detection algorithm by checking the velocity and acceleration information on a sample-by-sample basis. Sample Velocity Trigger fires when the sample velocity and acceleration values exceed their respective thresholds.
	Conditional	Fires when one or two conditional evaluations are met. This is useful to implement conditional branching in a graph when several conditions are possible.
	Voice Key Trigger	Triggers when ASIO input exceeds a pre-specified threshold. This only works with an ASIO compatible sound card.

6.5 Other Node Types

SR Research Experiment Builder also supports other components: Variable, Result File, and Accumulator. These components mainly function as a temporary storage for experiment data. Note that these objects are never connected to other components in an experiment in the graph editor. Instead, they are used within the experiment by attribute referencing (see section 6.7).

	Accumulator	Used to keep numeric values and do statistical analysis on the accumulated data. The Accumulator is a circular list, so the last n items added to the list are kept.
	Result File	Provides a columnar output of selected variables.
	Variable	Used to store data during run time.
	Custom Class Instance	Used to create a new instance of a custom class

6.6 Sequence/Sub-graph

As the experiment-looping controller, a sequence (i.e., sub-graph) is used to chain together different actions and triggers and execute them in a loop. Therefore, the Sequence experiment component can itself be considered a complex action. To implement the hierarchical organization of events in an experiment, the Experiment Builders allows one graph containing the triggers and actions to be nested under another graph to represent a sub-sequence in the event chain. In a typical experiment, the user needs to add a couple of nested sequences so that the implementation of blocking, trial, and recording can be done efficiently (see the following figure for an example).

Given the repetitive nature of the sequence component, a data source can be attached to a sequence object to supply different parameters for each sequence iteration. Like Microsoft Excel software, each column of a data source contains a variable label and each row contains a value for the variables. For a typical experiment created by Experiment Builder, the user needs to create prototypical trials and to supply the actual parameters for individual trials from a data source attached to the trial sequence. During experiment runtime, individual lines can be read from the data source, supplying the actual parameters for each trial - the linkage between the two can be achieved by attribute referencing.

	Sequence/Sub-graph	A controller for experiment flow. Used to chain together different Actions and Triggers and execute them in a loop or to simply modularize a set of experiment components.
---	---------------------------	--

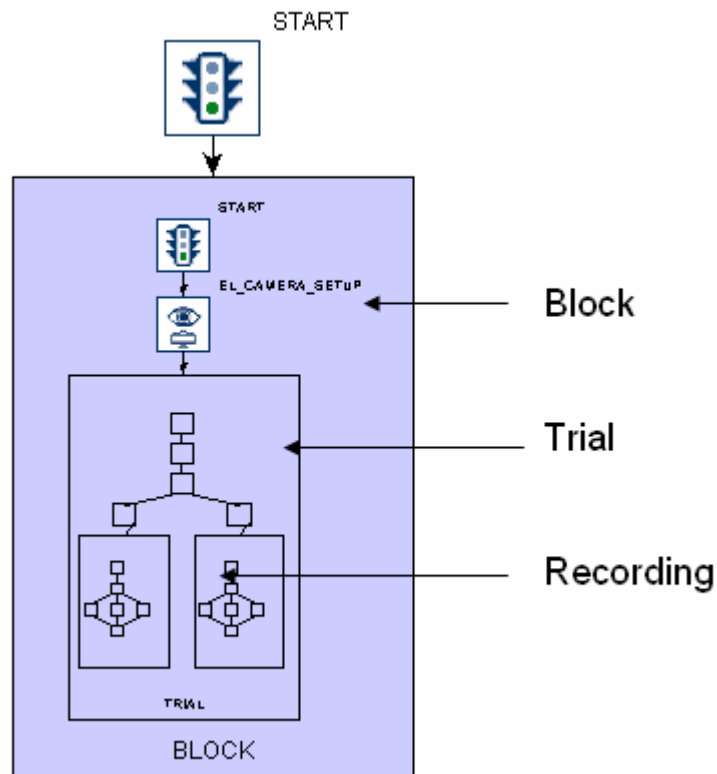

Figure 6-4. Nested Sequences in an Experiment.

6.7 References and Equations

The Experiment Builder uses "references" to link or bind an attribute of one experiment component to be equal to the value of another component attribute. References (see Chapter 10) are a critical part of the Experiment Builder, providing much of the flexibility to the application.

As an example, assume a sequence has two components, X and Y, and component X has attribute Ax and component Y has attribute Ay. If attribute Ax was set to reference Ay, then the value of Ax would always be equal to the value of Ay. In this example it is said that Ax is the "referencing" attribute and Ay is the "referenced" attribute. Even if Ay changes value during the experiment, Ax will always reflect the current value of Ay.

A reference is represented by a string that starts and ends with a @ symbol in the attribute editor for an experiment component. For example @X.Ax@ is a reference to the Ax attribute of component X. @Y.Ay@ is a reference to the Ay attribute of component Y. If the reference is to a component attribute that is not in the same sequence as the referencing component, the reference will also contain the graph path to the referenced component.

The user can refer a variable or an attribute of a node to the attribute of another node (trigger, action, or sequence), a variable, or data source. The users can also use a more complex form of references - equations, which are a combination of values and/or references. In most cases the data type of the referring attribute must match that of the referenced attribute.

As a more concrete example of using references, imagine that the user needs to show a text on the screen. In the property table of the text resource, the user can enter the text to be displayed directly in the "Text" property field (see left panel of the figure below). This static approach will be problematic when the user needs to display different text across trials. Another, more flexible approach, is to have the "Text" attribute of the text resource refer to a column (e.g., "Word") of a data source that contains a different text value in each iteration of the sequence (see the right panel). Obviously, using references is more advantageous when the user needs to set a value dynamically. In addition, references can also be used to access the value of attributes of an action or a trigger. In the above example, the width and height of the text shown on the screen will change dynamically across trials. To know the exact text dimension in one trial, the user can refer to the "Width" and "Height" property of the text resource.

Property	Value
Label	TEXT_RESOURCE
Visible	<input checked="" type="checkbox"/>
Position is Gaze Contingent	<input type="checkbox"/>
Position is Mouse Contingent	<input type="checkbox"/>
Host Outline Color	White
Screen Location Type	Center
Location	512, 384
Width	101
Height	38
Movement Pattern	None
Prebuild To Image	<input checked="" type="checkbox"/>
Font Color	
Font Name	Arial
Font Style	Normal
Font Size	40
Underline	<input type="checkbox"/>
Text	One
Use Runtime Word Segmen...	One

A

Property	Value
Label	TEXT_RESOURCE
Visible	<input checked="" type="checkbox"/>
Position is Gaze Contingent	<input type="checkbox"/>
Position is Mouse Contingent	<input type="checkbox"/>
Host Outline Color	White
Screen Location Type	Center
Location	512, 384
Width	101
Height	38
Movement Pattern	None
Prebuild To Image	<input checked="" type="checkbox"/>
Font Color	
Font Name	Arial
Font Style	Normal
Font Size	40
Underline	<input type="checkbox"/>
Text	@parent.parent.parent.TRIAL...
Use Runtime Word Segmen...	@parent.parent.parent.TRIAL_DataSource.Word@

B

Figure 6-5. Using a Reference to Update Text to Be Displayed.

7 Experiment Graph and Components

The Component toolbox in the Graph Editor Window contains the basic building blocks for creating experiments. To create an experiment, the user needs to add necessary components into different sequences of the experiment and make connections between those components. Following this, the properties of the individual components should be reviewed and modified as necessary. The current chapter reviews the usage and properties of the individual components in the toolbox.

7.1 Graph Editing Operations

The Experiment Builder is an interactive tool, allowing the user to create a new experiment graph from scratch and to modify an existing graph. With the graph editor window, the user is able to add/remove new experiment Builder component nodes, to add/remove the connection between nodes, to modify the attributes of node, and so on.

The following lists common operations used in editing a graph in Experiment Builder. Most of the operations can be performed by keyboard shortcuts, by using buttons on the application toolbar, or by entries in the "Edit" menu.

- **Inserting a new node:** Click on the "Action"/"Trigger"/"Other" Tab of component toolbox in the Graph Editor Window. Place the mouse cursor on the icon of the desired component, press the left mouse button, hold it down as you move the mouse to drag the selected item to the desired location in the work space, and then release the left mouse button.
- **Cutting nodes:** Select the nodes to be cut, press CTRL + X keys together or click the right mouse button to bring up a popup menu. Select "cut" to remove a selection from the project and place it into the clipboard.
- **Deleting nodes:** Select the nodes to be removed, press "Delete" key or select "Delete" from the popup menu to remove the selection from the current location. Note: Delete will not place the selection into the clipboard. Therefore, if you want to move one node from one sequence to another, you may first cut the selected nodes and then paste the selection to the intended location.
- **Copying a selection:** Select the nodes to be copied, press CTRL + C or select "Copy" from the popup menu to put a copy of a selection to the clipboard.
- **Pasting a selection:** Press CTRL + V or click the right mouse button to bring up a popup menu and select "Paste" to insert the previously copied/cut items from the clipboard to the current position.
- **Pasting a selection Multiple times:** Press CTRL + M or select "Paste Multiple" from the popup menu. This will bring up a dialog to let you specify the number of copies of the previously copied item from the clipboard to the current position.

- **Undoing:** Pressing CTRL + Z undoes the last action performed.

7.2 Node Connection

The flow of an experiment sequence moves from the default "START" node to one or several triggers or actions and then to other triggers or actions, and so on. This requires the designer to connect two experiment components with arrowed line to establish a directional or dependency relationship between a "Source" component and a "Target" component. Click here for a list of linking rules.

7.2.1 Connection: Create, Cancel, and Delete

To make a connection from a Source component to a Target component, place the mouse cursor on the Source component, hold down the left mouse button (without releasing the button as this constitutes a mouse click and will select the item instead), move the cursor to the Target component, and then release the left mouse button. To cancel a connecting operation in progress, press the "ESC" key. To remove a connection between two experiment components, click on the connecting line until it is highlighted in yellow, and then press the "Delete" key on the keyboard or select the "Delete" button on the application tool bar.

7.2.2 Connection Order

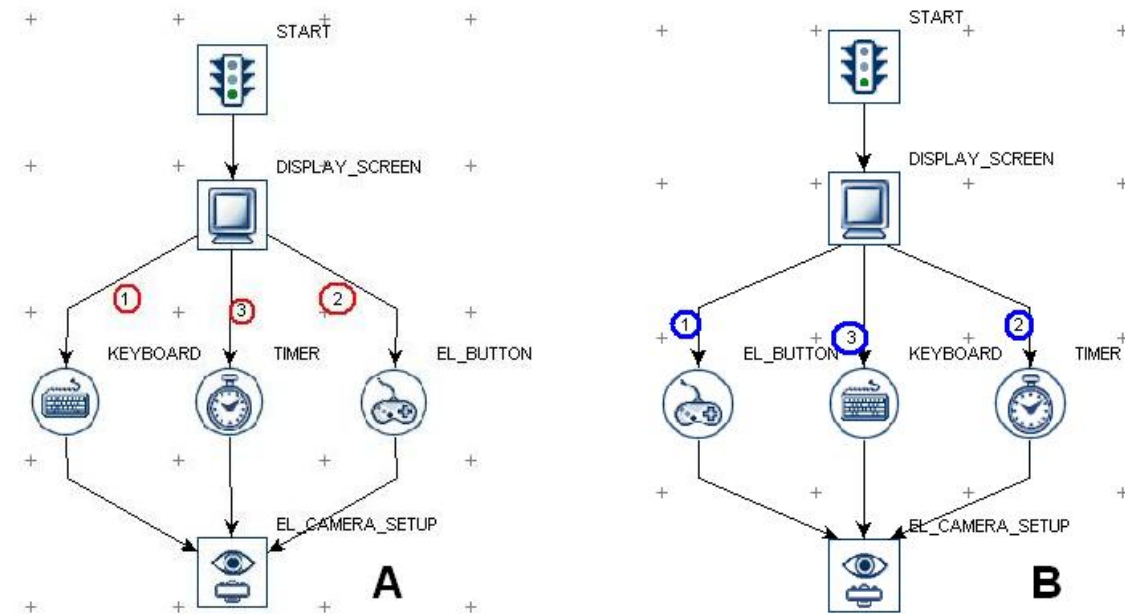

Figure 7-1. Connection Order

When several triggers are connected to a common node, a small number is drawn by each edge in the graph. This number represents the order that triggers will be evaluated from a source node that has multiple trigger targets. In the above example (Panel A), the keyboard trigger will be evaluated first, then followed by the EyeLink button trigger, and then by the timer trigger. To change the connection order, the user can first delete the

connection edges between the source and target nodes and then reconnect the nodes. For example, if the user deletes the connection between DISPLAY_SCREEN and KEYBOARD and then re-connects between them, the connection order of the triggers will be changed (see Panel B).

7.3 Experiment Node Exporting and Importing

The Experiment Builder allows the user to share data between several experiment creation sessions with newly-added importing/exporting features. You may select the nodes to be shared, export it to a file. In the target experiment builder session, you can then import the graph at the intended location. This topic explains in detail how to share data between Experiment Builder sessions by exporting and importing.

7.3.1 Exporting

- 1) Select the node/sequence to be exported. Please make sure that only one node or sequence is selected.
- 2) Click the right mouse button to bring up a popup menu (see Figure 7-2). Select "Export Node" (If the "Export Node" option is grayed out, please make sure that you have one and only one node/sequence selected).

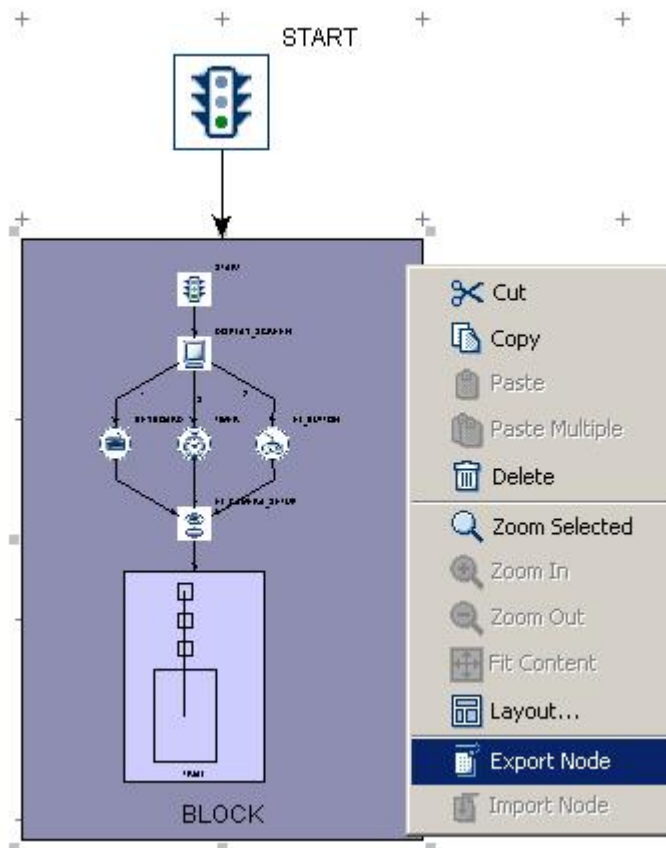
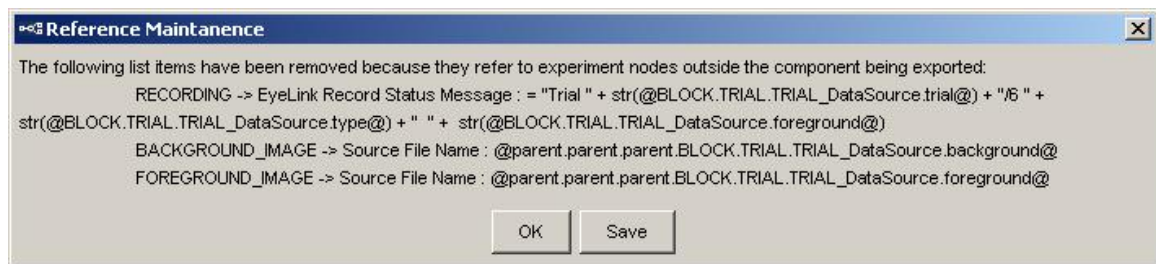

Figure 7-2. Exporting Node

3) In the following "Export" dialog box, go to the directory where the node should be exported, set the intended export file name, and then click on the "OK" button.

- If the node to be exported contains references to other nodes/data source that are not part of the selection, a "Reference Maintenance" dialog (see the figure below) will be displayed to enumerate all of the stripped references. You may click on the "Save" button to save the information to a text file before pressing the "OK" button.



- A dialog box will be displayed asking you whether you want to export all necessary library files. Press "Yes" to export all necessary library files. If "No" is pressed, Experiment Builder will not export library files; it is the user's responsibility to maintain the files herself/himself. If the "Cancel" button is pressed, the node-exporting operation will be cancelled.

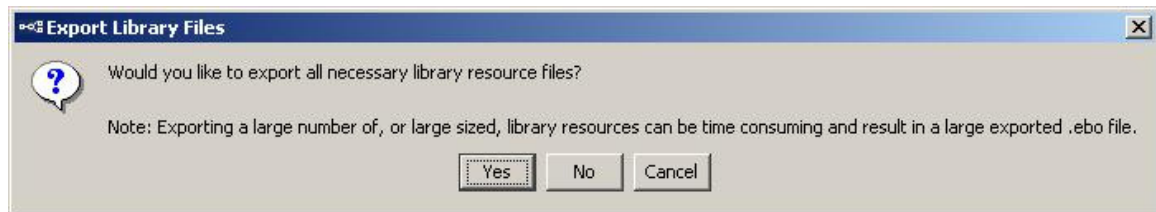

7.3.2 Importing

- 1) Click anywhere in the blank area of the workspace in the intended sequence level -- please make sure that no node/sequence is selected.
- 2) Click the right mouse button to bring up a popup menu (see Figure 7-3). Select "Import Node" (If the "Import Node" option is grayed out, please make sure that you do not have any node currently selected).
- 3) In the following "Open" dialog box, go to the directory where the exported node file is contained, select the ".ebo" file and then click "Open".

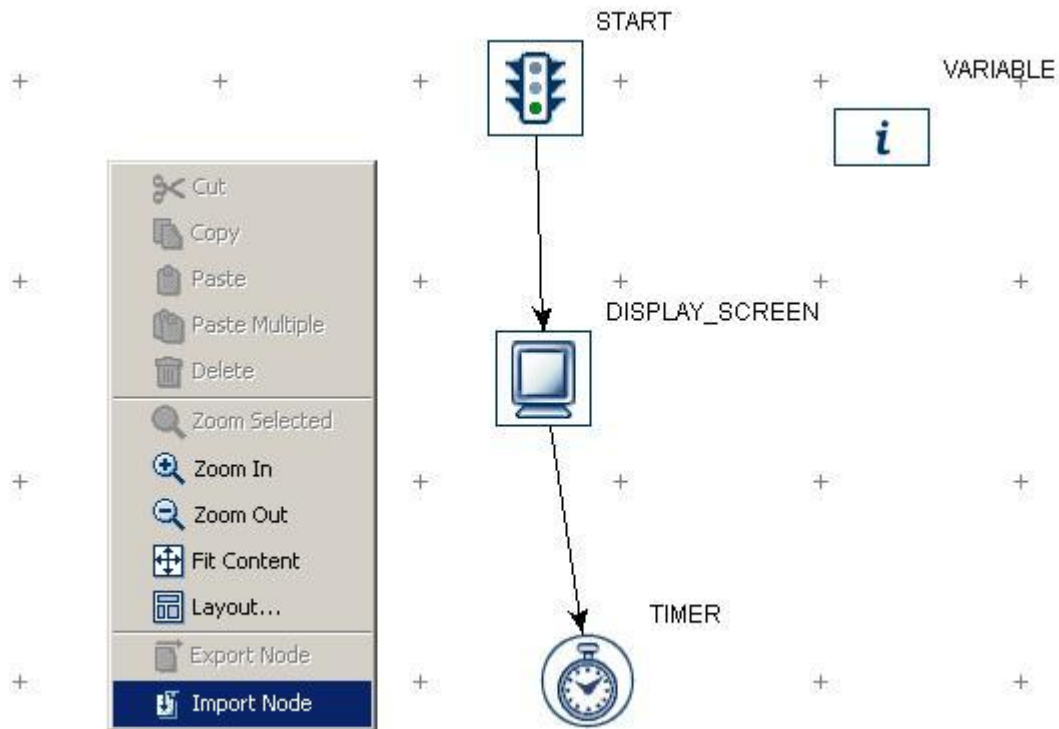







Figure 7-3. Importing Node

7.4 Layout of Nodes in Work Space

The Work Space in the Graph Editor Window functions like a flow diagram editor in which components are dragged onto and connected. If a large number of items are added, the work space may get cluttered. The graphic interface of Experiment Builder allows for automatic node arrangement, zoom-in or zoom-out operations to create high-quality drawings of a graph so that it can be understood easily.

To rearrange the layout of items in a hierarchical manner, place the mouse cursor to a blank area in the Work Space, click the right mouse button to bring up a popup menu, and choose “Layout ...” and then click “OK” (see Figure 7-4). From the menu, the users can also zoom in or out the current graph, or to make the current graph fit the screen. The following table lists of the options available from the popup menu.

Operation	Function
 Zoom Selected	Make a selection of components in one region and use this operation to zoom in the selected items for details.
 Zoom In	Zoom in towards the center of the work space (so that details of a selected portion of area can be viewed).
 Zoom Out	Zoom out the graph so that more items can be displayed in work Space.
 Fit Content	Rearrange the size of the graph so that the whole graph fits the size of the Work Space

 Layout Option	Click to bring up a configuration dialog box so that the layout of components in a graph can be configured.
 Arrange Layout	Rearrange the layout of components in the graph in a hierarchical manner.

Note: To perform the operations listed in the table, the user should first click on a blank area in the work space, click the right mouse button to bring up the menu, and then make a selection of the operation to be performed.



Figure 7-4. Choosing Layout of Components in Work Space

7.5 Editing Properties of a Node

After a component is added into the workspace, some of its default property values can be modified according to the requirements of the experiment. For example, the maximum “duration” set in a TIMER trigger is set to 4000 milliseconds by default. This may not be the desired value in an actual experiment and therefore the experiment designer needs to set a different value for it. To edit the properties of an item, click on the item until it is highlighted (i.e., a gray border encircles it). Double clicking on a sequence or a display screen action will also unfold the content of the sequence or display screen and make the current selection take up the whole work space for editing.

When one experiment component is selected, its properties and corresponding values are displayed in the property panel for review and modification. Depending on the nature of the property field, different operations are required to change the value.

- If a properties field (e.g., “Time” and “Start Time” of various actions) is grayed out then the value of the property is “read-only” and can only be referred by other components and cannot be directly modified.
- If the value field of a property contains a check box (e.g., “Record” property of a sequence), that property can be either enabled or disabled by clicking on the check box.
- If a dropdown list appears after doubling clicking on the property value field (e.g., “Duration Type” property of the Timer trigger), make the selection from the list.
- For some properties (e.g., “Label” of an action), the value can be modified by double clicking on the value field, entering the desired value, and then pressing the ENTER key to register the change.
- If a button box appears at the right side of the attribute cell after selecting the field (see Figure 7-5), the property field may be edited with Attribute Reference Editor (see Chapter 10) in addition to the above mentioned editing operations.

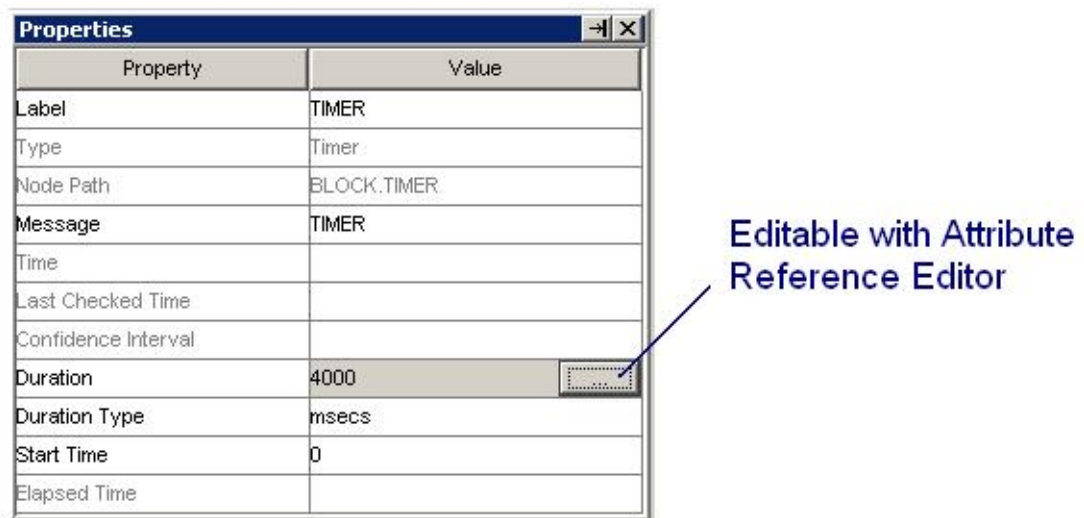

Figure 7-5. Property Field Editable with Attribute Reference Editor

In the following sections of this chapter, a set of symbols are used to indicate the properties of each attribute of an experiment component:

#	Attribute is read-only and is not directly modifiable
*	Attribute can not reference another attribute (Reference Editor is not available)
NR	The attribute can not be referred to by other component attributes.
¶	Attribute value can be selected from a dropdown list
†	Attribute is a Boolean value. True if the box is checked; false if unchecked.

The value of all other attributes can be modified either by entering value directly in the edit field or by attribute reference in an attribute editor dialog box and can be accessed by users for attribute references.

7.6 Experiment Node

Clicking on the topmost node (☰) of the structure list in the Project Explorer Window displays the properties of the experiment in the property panel.

Field	Attribute Reference	Type	Content
Label *	.label	String	Label of the Experiment
EyeLink© DV Variables	NR		Clicking on the value field of this property will bring up a dialog box so that the user can select variables and data source columns to be recorded in each trial as trial ID. This attribute is only available in an EyeLink© experiment (i.e., the “EyeLink© Experiment” setting of the Experiment Preference is enabled).
Time Out	.timeout	Integer	The maximum time (in milliseconds) the experiment should run. If 0, the experiment will not time out.
Created Date #	.createdDate	String	Time and Date when the experiment was first created.
Last Modified Date #	.lastModifiedDate	String	Time and Date when the experiment was last modified.
Session Name #	.sessionName	String	Name of the experiment session. This is the string you input in the "Session Name" dialogbox when running the experiment.
License ID #	NR		License ID of the dongle key. “Demo” if the Experiment Builder software is unlicensed.
Save Messages †	.saveMessages	Boolean	Whether the messages associated with any triggers or action should be logged. This attribute is available in Non-EyeLink Experiments only. If enabled, a message property will be available in most of the triggers and actions.
Read-Only †	NR	Boolean	Check this box if you do not want to save any changes made to the experiment project.

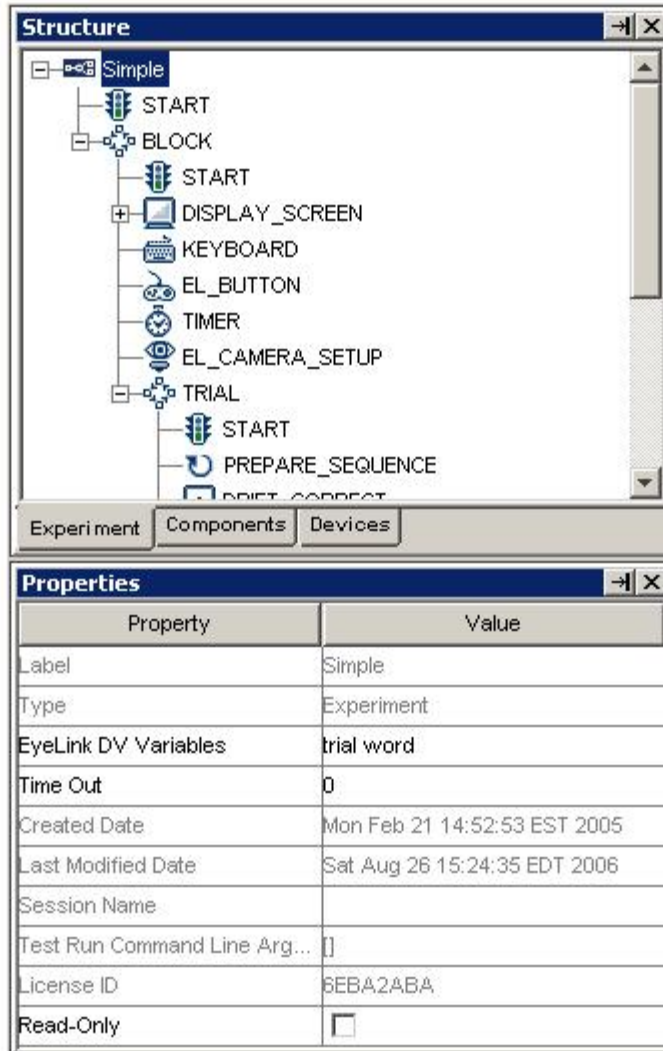



Figure 7-6. Properties of the Experiment Node

The "EyeLink© DV Variables" property is used to send trial condition messages to the EDF file so that the user knows exactly under which condition each trial recording is performed. After clicking on the value field of the property, a dialog box will be displayed to allow the user to choose variables to be recorded. The list of possible variables includes columns in the experiment data source (see "Data Source") as well as new variables created by the user (see "Variable"). If the user wants to have the experiment time out after certain duration, enter the millisecond time out value in the "Time Out" field.

7.7 Sequence/Subgraph

A sequence () is used to encapsulate different actions and triggers. This allows the user to perform editing operations (cut, copy, delete, paste) on all of the items contained within the sequence together. It also allows the user to execute them in a loop and repeat the execution several times if required. In a typical experiment, the user needs to add a couple of nested sequences so that blocking-trial-recording hierarchy can be implemented

efficiently. In an EyeLink© experiment, the "Record" attribute of one of the sequences must be checked so that eye-tracking data can be collected.

Field	Attribute Reference	Type	Content
Label *	.label	String	Label of the Sequence node. The default label is "SEQUENCE".
Type #	NR		The type of Experiment Builder objects ("Sequence") the current node belongs to.
Node Path #	.absPath	String	The absolute path of the node in the experiment graph.
Time #	.time	Float	Display PC Time (in milliseconds) when the sequence is executed.
Record †	.record	Boolean	Whether EyeLink© recording should be done within the sequence. Recording starts at the beginning of each iteration of the sequence and ends at the end of each iteration of the sequence. The default setting is "False" (box unchecked). This attribute is only available in an EyeLink© experiment.
EyeLink© Record Status Message	.eyeLinkRecordStatusMessage	String	This supplies the title at the bottom of the eye tracker display. This property is only available for a recording sequence. This attribute is only available in an EyeLink© experiment with the "Record" setting of the current sequence enabled.
Recording Pause Time	.recordingPauseTime	Integer	Time (in milliseconds) to wait to execute the sequence after the recording starts (typically set as 20). This attribute is only available in an EyeLink© experiment with the "Record" attribute of the current sequence enabled.
Trial Result	.trialResult	Integer	A value used to encode the result of current recording trial (e.g., "MSG 1067284 TRIAL_RESULT 12" in the EDF file). It is 0 by default but can be referred to some responses made in the trial. This attribute is only available in an EyeLink experiment with the "Record" setting of the current sequence enabled.
Is Real Time †	.isRealTime	Boolean	When set to True, sets the application priority to real-time mode. Real-time mode is only maintained for the duration of the sequence. It may take up to 100 milliseconds, depending on the operation system, for the real-time mode to stabilize. Also note that on some operating systems, real-time mode locks keyboard and mouse inputs from occurring.
Iteration #	.iteration	Integer	The current iteration of the sequence execution.

Iteration Count	.iterationCount	Integer	Total number of times (1 by default) the sequence should be executed.
Split by	.splitBy	List of integers	Specifies the number of iterations to be executed each time the sequence is encountered. If the list is not empty, each number in the list should be no less than 1 but also not more than the iteration count of the sequence.
Data Source	NR		Double clicking on this field will bring up a data Source editor (see Chapter 9 "Data Source" for details). The "Columns: X/Rows: X" reports the current size data source.
Freeze Display Until First Display Screen †	.freezeDisplayUntilFirstDisplayScreen	Boolean	If checked, the display will not be updated until the call of the first Display Screen action within the sequence (to avoid some undesired display change). The field should be checked in most experiments.
Prompt for Dataset File †	.promptForDatasetFile	Boolean	If checked, a dialog box will show up at the beginning of the experiment allowing user to choose the intended dataset file. If unchecked, it will load in the default dataset file.
Callback	NR		For an experiment project with custom class enabled, a method defined in the custom class can be run for every poll of the sequence. Similar to the EXECUTE action, a list of parameters will displayed if a method is selected from a custom class instance. Please note that running this callback function may add an extra delay to sequence polling and there should be used with caution (avoiding running any callback function that takes a significant amount of time to finish).
Result #	NR		Result of the execution method.
Result Data Type #	NR		Type of the data returned by the execute method.

A recording sequence should be included in an EyeLink experiment. Failing to do this will result in a build-time error - "error:2028 No Recording sequence found!!!". To specify one sequence as a recording sequence, check the "Record" checkbox. Note that this checkbox will not be available if the current project is a non-EyeLink experiment or if the sequence is already contained within a recording sequence. If the "Record" button is checked, the user will see additional properties - "EyeLink Record Status Message" field allows the user to send a text message to be displayed at the bottom of the tracker screen so that the experimenter can be informed of the progress of experiment testing; "Recording Pause Time" controls the delay in the execution of sequence following the start of the tracker recording.

Some nodes can only be used in a recording sequence. For example, all eye-based triggers such as invisible boundary trigger, fixation trigger, saccade trigger, and sample

velocity trigger should be only used in a recording sequence. However, some other node types, such as drift correction and camera setup actions, cannot be used in a recording sequence. To maximize real-time performance in data collection, the user should have the "Is Real Time" box checked and include a prepare sequence action before executing the sequence.

The following figure illustrates the use of sequences in one experiment. In this example, a RECORDING sequence that performs the actual eye-tracker recording is nested within a TRIAL sequence, which is contained within a BLOCK sequence. The "Record" field is checked in the RECORDING sequence but not in the BLOCK or TRIAL sequences. The RECORDING sequence also allows the user to send a message (EyeLink© Record Status Message) to the tracker screen so that the experimenter can be informed of the progress of the experiment.

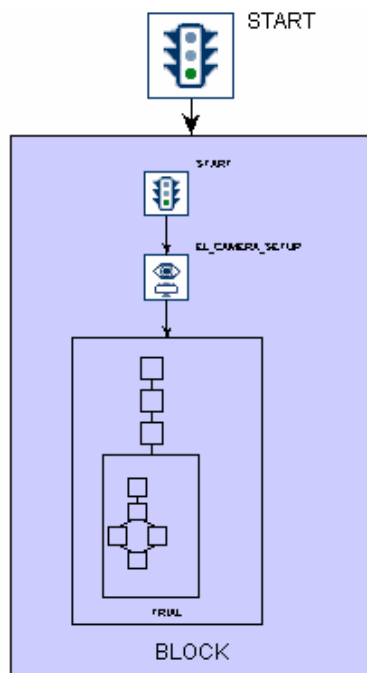

A

Property	Value
Label	BLOCK
Time	
Record	<input checked="" type="checkbox"/>
Is Real Time	<input type="checkbox"/>
Iteration	
Iteration Count	3
Split by	1
Data Source	Columns: 0 / Rows: 0

B

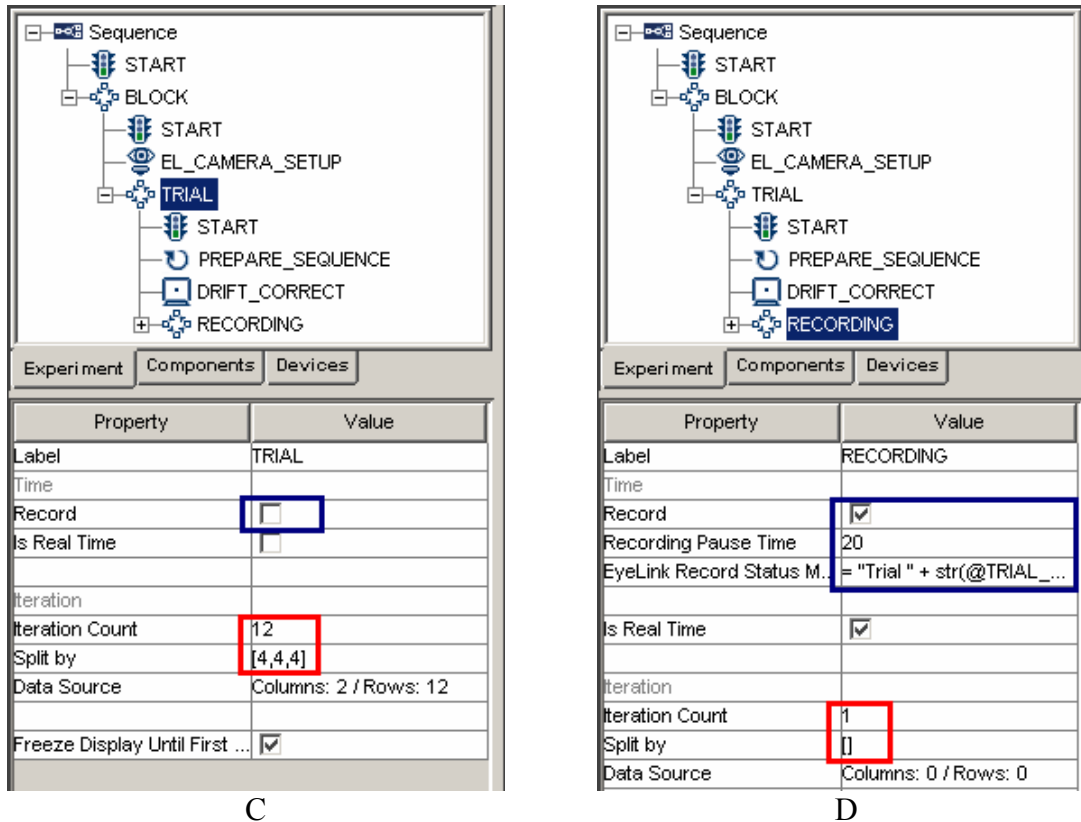

Figure 7-7. Using Sequence in an Experiment

The iteration count of a sequence specifies the maximum number of repetitions the sequence should be executed whereas the "Split by" field allows the user to flexibly configure the number of actual iterations to be executed. By default, the "Split by" field contains an empty list "[]", which means that all of the iterations should be executed in one set. A non-empty split-by list specifies the actual number of iterations to be executed for each call of the sequence. This feature can be conveniently used to design a data source for experiments in which uneven numbers of trials are tested in different blocks. In the above example, the iteration count of the BLOCK sequence is 3 and split by list is empty. This means that the BLOCK sequence will be executed three times in total (i.e., 3 blocks). The total iteration count of the TRIAL sequence is 12 and the split-by field contains a list of [2, 5, 5]. This means that the TRIAL sequence will be executed two, five, and five times during the first, second, and last call of the BLOCK sequence. The iteration count of the RECORDING sequence is 1 and the split-by list is empty. This means that the recording sequence will be executed once for each call. Therefore, the above graph indicates that this experiment has three blocks, which contains two, five, and five trials, respectively. Each trial will perform one eye-tracker recording.

7.8 Start Node

For each sequence in an experiment graph, the flow always begins with the default "START" node. Each sequence requires at least one connection made from the "START" node.

node to one or several triggers or actions. The START node cannot receive a connection from other nodes.

Field	Attribute Reference	Type	Content
Label *	.label	String	Label of the Display Screen action. The default value is "DISPLAY_SCREEN".
Type #	NR		The type of Experiment Builder objects ("Start") the current node belongs to.
Node Path #	.absPath	String	The absolute path of the node in the experiment graph.
Time #	.time	Float	Display PC Time when the experiment flow starts.

7.9 Actions

SR Research Experiment Builder supports a list of actions, such as displaying a screen, performing drift correction, performing camera setup and calibration, sending a message to an EDF file or to a log file, preparing sequence, sending a command, sending a TTL signal, updating variable value, adding to result file, adding data to an accumulator, outputting data to a result file, playing sound, recording sound, data source line recycling, or terminating the experiment. Actions can be accessed by clicking on the "Action Tab" of the Component Toolbox. The following sections describe the usage and properties of each action type in detail.



Figure 7-8. Action Tab of the Component Toolbox

7.9.1 Display Screen

The DISPLAY_SCREEN action () is used to show visual stimuli on the display PC screen. Double clicking on the newly created DISPLAY_SCREEN action will show a blank Screen Builder workspace for editing the screen. Please follow Chapter 8 "Screen Builder" to modify the content of the screen.

Field	Attribute Reference	Type	Content
Label *	.label	String	Label of the Display Screen action. The default value is "DISPLAY_SCREEN".
Type #	NR		The type of Experiment Builder objects ("DisplayScreen") the current node belongs to.
Node Path #	.absPath	String	The absolute path of the node in the experiment graph.
Message	.message	String	Message to be sent to EDF file (in an EyeLink® experiment.) or messages.txt (in a non-EyeLink experiment with "Save Messages" attribute of

			the Experiment node checked) when display screen action is processed.
Time #	.time	Float	Display PC time for the start of the retrace that the screen was actually drawn/redrawn. Important: This is the field you should use to check for the time when the display is actually shown.
Start Time #	.startTime	Float	Display PC Time when the display_screen action is entered (so that the screen can be prepared and shown). Note: the display screen is not shown yet by this time.
Clear Input Queues †	.clearInputQueues	Boolean	If true, all events from input queues are flushed when the action is started. This includes all Experiment Builder triggers, such as keyboard, mouse, TTL, and EyeLink inputs (button, saccade, fixation). This results in upcoming Triggers only firing based on events that are collected following the start of the Action. If false, the input queues are not cleared when the action is performed, meaning that any events already in the queues will be evaluated by Triggers following the action.
Prepare Time #	.prepareTime	Float	Actual time (in msec) used to prepare for the display screen action.
Width #	.width	Integer	The width of the display screen in pixels (1024 by default)
Height #	.height	Integer	The height of the display screen in pixels (768 by default)
Background Color	.backgroundColour	Color	The background color of the screen. The default color is white (0, 0, 0).
Bits Per Pixel #	.bitsPerPixel	Integer	The number of bits (32 by default) used to represent the luminance and chroma information contained in each pixel.
Auto Generate Sync Messages †	.autoGenerateSyncMessages	Boolean	Whether or not to send a default message (“SYNCTIME”) when the display changes. This message will not be generated if the “EyeLink© Message” field is filled. The default setting is “false” (box unchecked).
Resource Count	.resourceCount	Integer	Number of resources included in the display screen action, not including screen background
Grid Rows *	NR	Integer	If the “toggle grid visibility” button in the Screen Builder toolbar is on, several horizontal lines will be drawn to divide the screen into the specified number (2 by default) of rows.
Grid Columns *	NR	Integer	If the “toggle grid visibility” button in the Screen Builder toolbar is on, several vertical lines will be drawn to divide the screen into the specified number (3 by default) of columns.
Force Full	.forceFullRedraw	Boolean	If checked, this will force a full redraw of the

Redraw †		n	whole screen at every retrace. The possible values are 'true' and 'false' (default value).
Estimated Prepare Time	.estimatedPrepareTime	Integer	Time (in milliseconds) required to prepare for the display screen. This is typically set to the value of Default Estimated Prepare Time. The preparation time is influenced by screen resolution, computer video hardware, and whether the screen resources have been preloaded or not.
Default Estimated Prepare Time #	.defaultEstimatedPrepareTime	Integer	Default time (in milliseconds) set for display screen preparation. Typically this is set to 1.5 times of a display refresh cycle. Note that the Estimated Prepare time is useful only when a timer trigger is used before a display screen. This allows the timer to pre-release for the preparation of the following display screen action.
Auto Update Screen	.autoUpdateScreen	Boolean	If true (default), the display screen will be updated automatically without re-entering the display screen action again. This applies to anything that modifies the currently visible screen (e.g., if there are mouse- or gaze-contingent resources on the screen, resources have movement patterns, or resources visibility/position is modified by update_Attribute action or custom code, etc). If false, the screen is only ever updated when the display Screen action is re-entered (so no auto updating of any type is done). Note: If a static display is used (i.e., none of the above mentioned manipulations is applicable), turning off this option might be advantageous and will improve timing performance (e.g., trigger firing) as the program does not have to constantly checking whether the display should be updated.
Send EyeLink© DV Messages†	.sendEyeLinkDVMessages	Boolean	If checked, writes a message (“!V DRAW_LIST”) to the data File for the ease of analysis with EyeLink© Data Viewer. This message will draw images and simple graphics in Data Viewer as the background for gaze data. This field is only available when the action is contained in a recording sequence.
Use for Host Display †	.useForHostDisplay	Boolean	If checked, the current screen will be transferred to the host PC as a bitmap or primitive drawings for online gaze feedback. This field needs to work together with the “Draw to EyeLink© Host” field of the PREPARE_SEQUENCE action. This attribute is only available in an EyeLink© experiment.

Interest Area Set Name	.interestAreaSetName	String	If the user has already had interest area files for the current display, she/he can first add the interest area files into the library manager and set this field to a desired interest area set file. Returns "MISSING_DATA" if no value is set in this field. This attribute is only available in an EyeLink© experiment.
Synchronize Audio †	.syncAudio	Boolean	If checked, this will bring up a list of additional variables so that the parameters of sound playing can be specified (see PLAY_SOUND action for details). Note that this field is only available when the ASIO driver is used to play sound clips (see "Audio Driver" setting in the Audio Devices of the structure Panel).

The following figure illustrates a simple experiment trial by displaying a screen and then waiting for a button response from the participant, or the sequence ends after a pre-specified amount of time set in the TIMER trigger. For the ease of data analysis (reaction time calculation, for example), the user should record an EyeLink© message to the EDF file when the display is presented. This can be done by entering a text message on the "Message" field or by having "Auto Generate Sync Message" box checked.

In a trial with multiple display screens, each of the display-screen action should send a unique Data Viewer integration message. In a recording sequence, the user may enable the "Use for Host Display" button if this is the primary display of the trial for gaze accuracy monitoring and add a PREPARE_SEQUENCE action before the recording sequence, with its "Draw to EyeLink© Host" field enabled.

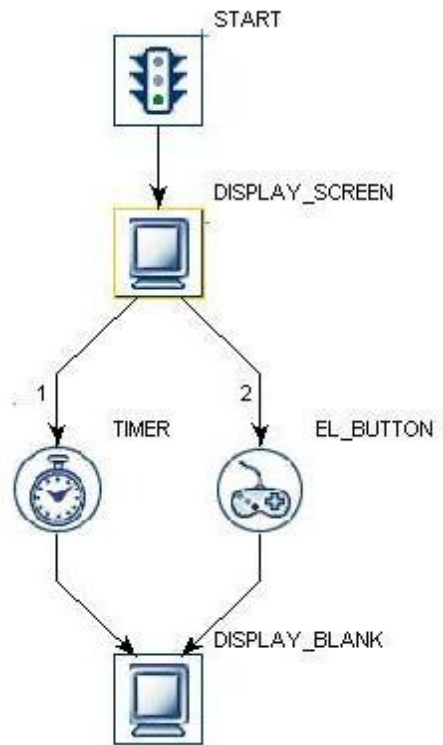



Figure 7-9. Using Display Screen.

7.9.2 Performing Drift Correction

At the start of each trial, a fixation point should be displayed, so that the participant's gaze is at a known position. The EyeLink© tracker is able to use this fixation point to correct for small drifts in the calculation of gaze position that can build up over time. Even when using the EyeLink© II tracker's corneal reflection mode, a drift correction allows the experimenter the opportunity to recalibrate if needed. Performing a drift correction is optional for EyeLink 1000.

The Drift Correction action () implements this operation. The display coordinates where the target is to be displayed should be supplied. Usually this is at the center of the display, but could be anywhere that gaze should be located at the start of trial recording. For example, it could be located over the first word in a page of text.

Field	Attribute Reference	Type	Content
Label *	.label	String	Label of the Drift correction action. The default value is "DRIFT CORRECT".
Message	.message	String	Message to be sent to EDF file (in an EyeLink© experiment.) or messages.txt (in a non-EyeLink experiment with " Save Messages" attribute of the Experiment node checked) when the Drift correction action is done.
Time #	.time	Float	Display PC Time when the drift correction action is done.
Start Time #	.startTime	Float	Display PC Time when the drift correction state was entered.
Clear Input Queues †	.clearInputQueues	Boolean	If true, all events from input queues are flushed when the action is started. This includes all Experiment Builder triggers, such as keyboard, mouse, TTL, and EyeLink inputs (button, saccade, fixation). This results in upcoming Triggers only firing based on events that are collected following the start of the Action. If false, the input queues are not cleared when the action is performed, meaning that any events already in the queues will be evaluated by Triggers following the action.
X Location	.xLocation	Integer	X coordinate of the drift correction target in screen pixels. Typically this is center of the screen.
Y Location	.yLocation	Integer	Y coordinate of the drift correction target in screen pixels.
Allow Setup †	.allowSetup	Boolean	If this is checked, the EyeLink© II Camera Setup screen (the Setup menu in EyeLink© I) can be called up to allow calibration problems to be corrected by pressing the 'Esc' key during drift correction. The default setting is 'true'.
Draw Drift Correction Target †	.drawDefaultTarget	Boolean	By default (the box is checked), the drift correction procedure clears screen, draws the fixation target, and clears screen when done. However, sometimes it is better for the user to draw the target herself/himself, for example if the drift correction is part of the initial fixation in a saccadic task and the user wants the target to stay on the screen after drift correction. To do this, the user can pre-draw the drift correction target (using a DISPLAY_SCREEN

			action) and check off this field.
Foreground Color	.foregroundColor	Color	Color in which the drift correction target drawn.
Background Color	.backgroundColor	Color	The color of the screen.
Use Animation Target †	.useAnimationTarget	Boolean	If checked, an video clip can be used as the drift correction target. The user should preload the intended video clip into the library manager.
Animation Target ¶	.animationTarget	String	The name of the video clip used as the drift correction target.
Animation Play Count	.animationPlayCount	Integer	Total number of times the video clip will be played before the drift correction is done.
Use Custom Target †	.useCustomTarget	Boolean	If checked, drift correction will use the custom target supplied by the user.
Custom Target *	.customTarget	String	The name of the image file that is used for the drawing the drift correction target. Note that this property is only available if "Use Custom Target" is checked.
Target Outer Size	.outerSize	Integer	Diameter of the outer disk in pixels.
Target Inner Size	.innerSize	Integer	Diameter of the inner disk in pixels.
Use Custom Background †	.useCustomBackground	Boolean	If checked, drift correction will use the custom target supplied.
Custom Background *	.customBackground	String	The name of the image file that is used for the drawing the drift correction background. Note that this property is only available if "Use Custom Background" is checked.
Target Beep ¶	.targetBeep	String	Sets sound to play when target moves. If set to DEFAULT, the default sounds are played; if set to OFF, no sound will be played for that event; otherwise a sound file from the audio library can be played.
Error Beep ¶	.errBeep	String	Sets sound (DEFAULT, OFF, or sound file) to play on successful operation.
Good Beep ¶	.goodBeep	String	Sound (DEFAULT, OFF, or sound file) to play on failure or interruption.
Result #	.result	Integer	0 if successful; 27 if 'Esc' key was pressed to enter Setup menu or abort; "None" if this attribute is accessed before this action is done.

Please note that the Drift Correction action is only available in EyeLink© experiments and must be placed outside of a recording sequence (see linking rules). In addition, this action cannot be connected to another drift correct action, camera setup action or any trigger. If a prepare sequence action is used, it should be placed before the drift correction action.

In typical experiments, the user may have "Allow Setup" field checked so that when the "ESC" key is pressed, the camera setup screen is displayed so that the experimenter can adjust the camera settings and redo a calibration and validation.

The "Draw Drift Correction Target" box should be checked if the built-in or custom drift correction target should be displayed when entering the drift correction mode. In some (e.g., pursuit or saccade) experiments, the user may want to have the drift correction target to be the same as the pursuit target or other display items. If this is the case, the user may uncheck this box and insert a display screen action to pre-draw the drift correction target. Please take a look at the PURSUIT experiment for an example. Alternatively, the user may have both "Draw Drift Correction Target" and "Use Custom Target" fields checked and supply an image for the "custom target" property.

The following figure illustrates the use of drift correction action in a typical trial.

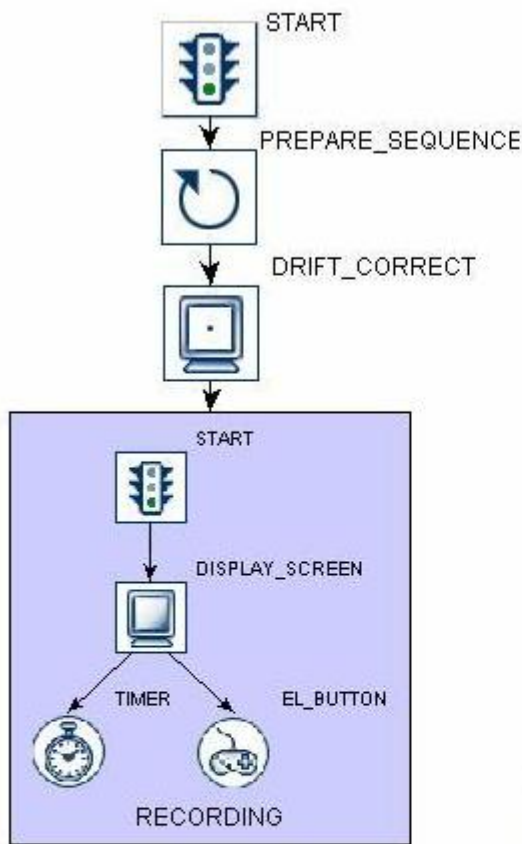

A

Structure

- Drift_correct
 - START
 - PREPARE_SEQUENCE
 - DRIFT_CORRECT
 - RECORDING

Experiment Components Devices

Properties

Property	Value
Label	DRIFT_CORRECT
Type	DriftCorrection
Message	
Time	
Start Time	
Clear Input Queues	<input checked="" type="checkbox"/>
X Location	512
Y Location	384
Allow Setup	<input checked="" type="checkbox"/>
Draw Drift Correction T...	<input checked="" type="checkbox"/>
Foreground Color	
Background Color	
Use Custom Target	<input type="checkbox"/>
Target Outer size	16
Target Inner Size	4
Use Custom Background	<input type="checkbox"/>
Target Beep	DEFAULT
Error Beep	DEFAULT
Good Beep	DEFAULT
Result	

B

Figure 7-10. Using Drift Correction Action

7.9.3 Performing Camera Setup and Calibration

The Camera Setup action (👁️) will bring up a camera setup screen for the experimenter to perform camera setup, calibration, and validation. Scheduling this at the start of each block gives the experimenter a chance to fix any setup problems. Simply pressing the ‘Esc’ key immediately can skip calibration. This also allows the participant an opportunity for a break, as the headband can be removed and the entire setup repeated when the participant is reseated. The user can set up the calibration type in this action.

All other calibration configurations can be found at the preference settings “Experiment → Devices → EyeLink®”.

Field	Attribute Reference	Type	Content
Label *	.label	String	Label of the Camera setup action. The default value is “EL_CAMERA_SETUP”.
Type #	NR		The type of Experiment Builder objects ("EyeLinkCameraSetup") the current node belongs to.
Node Path	.absPath	String	The absolute path of the node in the experiment graph
Message	.message	String	Message to be sent to EDF file (in an EyeLink® experiment.) or messages.txt (in a non-EyeLink experiment with "Save Messages" attribute of the Experiment node checked) when camera setup action is done.
Time #	.time	Float	Display PC Time when the camera setup action is done.
Start Time #	.startTime	Float	Display PC Time when camera setup action started.
Clear Input Queues †	.clearInputQueues	Boolean	If true, all events from input queues are flushed when the action is started. This includes all Experiment Builder triggers, such as keyboard, mouse, TTL, and EyeLink inputs (button, saccade, fixation). This results in upcoming Triggers only firing based on events that are collected following the start of the Action. If false, the input queues are not cleared when the action is performed, meaning that any events already in the queues will be evaluated by Triggers following the action.
Calibration Type ¶	.calibrationType	String	This sets the calibration type. One of these calibration type can be selected from the dropdown list: H3: horizontal 3-point calibration HV3: 3-point calibration, poor linearization HV5: 5-point calibration, poor at corners HV9: 9-point grid calibration, HV13: 13-point calibration (EyeLink® II version 2.0 or later). The default calibration type is HV9.
Foreground Color	.foregroundColor	Color	The color in which the calibration target drawn.
Background Color	.backgroundcolor	Color	The color of the screen.
Use Animation Target †	.useAnimationTarget	Boolean	If checked, an video clip can be used as the calibration target. The user should preload the intended video clip into the library manager.

Animation Target ¶	.animationTarget	String	The name of the video clip used as the calibration target.
Animation Play Count	.animationPlayCount	Integer	Total number of times the video clip will be played before the calibration is done.
Use Custom Target †	.useCustomTarget	Boolean	If checked, drift correction will use the custom target supplied by the user.
Custom Target *	.customTarget	String	The name of the image file that is used for the drawing the drift correction target. Note that this property is only available if "Use Custom Target" is checked.
Target Outer Size	.outerSize	Integer	The standard calibration and drift correction target is a filled circle (for peripheral delectability) with a central "hole" target (for accurate fixation). The disk is drawn in the calibration foreground color, and the hole is drawn in the calibration background color. The "Target Outer Size" property specifies the diameter of the outer disk of the default calibration target in pixels. Note that this property is only available if "Use Custom Target" is not checked.
Target Inner Size	.innerSize	Integer	Diameter of the inner disk of the default calibration target in pixels.). If holesize is 0, no central feature will be drawn. Note that this property is only available if "Use Custom Target" is not checked.
Target Beep ¶	.targetBeep	String	Experiment Builder plays alerting sounds during calibration. These sounds have been found to improve the speed and stability of calibrations by cueing the subject, and make the experimenter's task easier. The "Target Beep" property specifies the sound to play when target moves. If set to DEFAULT, the default sounds are played; if set to OFF, no sound will be played for that event; otherwise a sound file from the audio library can be played.
Error Beep ¶	.errBeep	String	Sound (DEFAULT, OFF, or sound file) to play on failure or interruption.
Good Beep ¶	.goodBeep	String	Sets sound (DEFAULT, OFF, or sound file) to play on successful operation.
Result #	.result	Integer	Always returns "None".

Please note that the Camera setup action is only available in EyeLink© experiments and must be placed outside of a recording sequence. As a linking rule, the camera setup action cannot be connected to another drift correct action, camera setup action, or any trigger. Figure 7-11 illustrates the use of camera setup in an experiment.

The screenshot shows the 'Structure' panel on the left, which displays a hierarchical tree of the experiment design. The 'EL_CAMERA_SETUP' action is highlighted in blue. Below it, the 'Properties' panel is visible, containing a table of configuration options for the 'EyeLinkCameraSetup' type.

Property	Value
Label	EL_CAMERA_SETUP
Type	EyeLinkCameraSetup
Message	
Time	
Start Time	
Clear Input Queues	<input checked="" type="checkbox"/>
Calibration Type	HV9
Foreground Color	
Background Color	
Use Custom Target	<input type="checkbox"/>
Target Outer size	16
Target Inner Size	4
Target Beep	DEFAULT
Error Beep	DEFAULT
Good Beep	DEFAULT
Result	

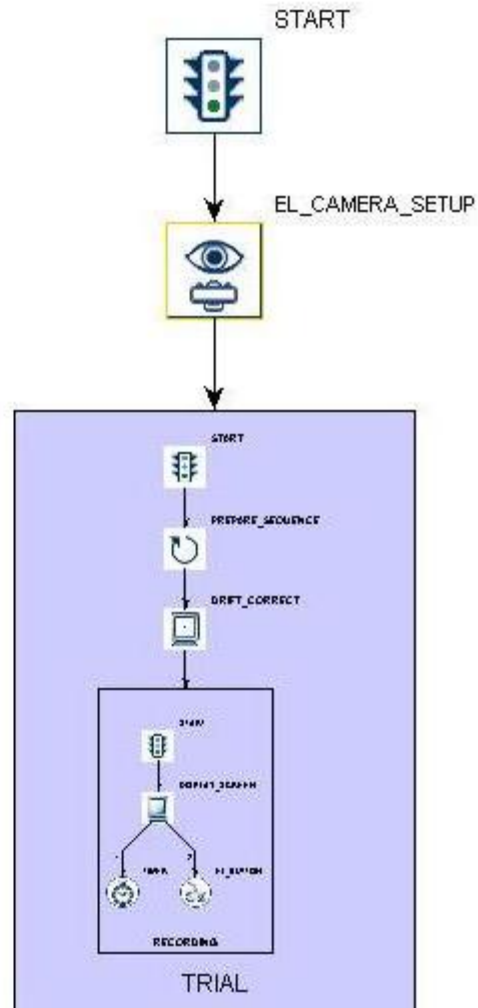



Figure 7-11. Using Camera Setup Action

7.9.4 Sending EyeLink® Message

The SEND_EL_MESSAGE action () writes a text message to the EyeLink® eye tracker, which timestamps it and writes to the EDF data file. Messages are useful for recording trial conditions, responses from the participant, or marking time-critical events for debugging and analysis. The EDF message text can be created with the attribute editor by double clicking at the right end of the value field, allowing for the use of numbers and strings in the message text. This action is not available in non-EyeLink® experiments.

When using the SEND_EL_MESSAGE action, the user should avoid end-of-line characters (“\n”) in the message text and avoid making reference to strings with quotes (“”). Message text should be no more than 128 characters in length –the tracker will

truncate text messages longer than 128 characters. Also be careful not to send messages too quickly: the eye tracker can handle about 2 messages a millisecond. Above this rate, some messages may be lost and not written to the EDF file.

Field	Attribute Reference	Type	Content
Label *	.label	String	Label of the SEND_EL_MSG action. The default value is "SEND_EL_MSG"
Type #	NR		The type of Experiment Builder objects ("SendEyeLinkMessage") the current node belongs to.
Node Path	.absPath	String	The absolute path of the node in the experiment graph
Time #	.time	Float	Display PC Time when the message is sent.
Start Time #	.startTime	Float	Display PC Time when this action starts.
Clear Input Queues †	.clearInputQueues	Boolean	If true, all events from input queues are flushed when the action is started. This includes all Experiment Builder triggers, such as keyboard, mouse, TTL, and EyeLink inputs (button, saccade, fixation). This results in upcoming Triggers only firing based on events that are collected following the start of the Action. If false, the input queues are not cleared when the action is performed, meaning that any events already in the queues will be evaluated by Triggers following the action.
Message	.message	String	Text to be sent to the tracker.

The following figure illustrates the use of SEND_EL_MESSAGE action. In the EyeLink© Message field, the user can enter a string directly (see panel A). In case runtime data accessing is required, the user may need to use references and equations and create the message text in the attribute editor (see Panel B; see Chapter 10 “References” for details).

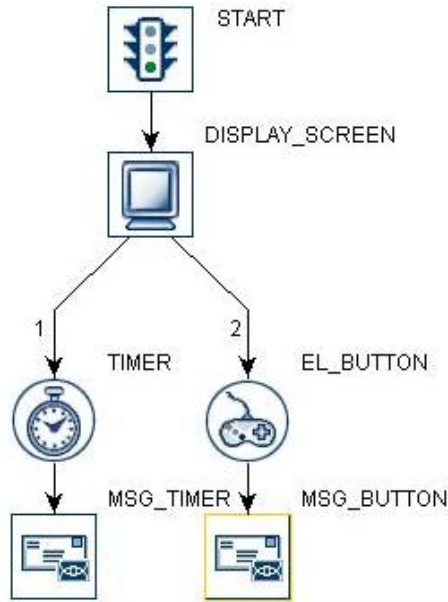

Structure

- DRIFT_CORRECT
- RECORDING
- START
- DISPLAY_SCREEN
- TIMER
- EL_BUTTON
- MSG_TIMER
- MSG_BUTTON

Experiment Components Devices

Properties

Property	Value
Label	MSG_BUTTON
Type	SendEyeLinkMessage
Time	
Start Time	
Clear Input Queues	<input checked="" type="checkbox"/>
Message	= "Button " + str(@EL_BUTTO...

Structure

- DRIFT_CORRECT
- RECORDING
- START
- DISPLAY_SCREEN
- TIMER
- EL_BUTTON
- MSG_TIMER
- MSG_BUTTON

Experiment Components Devices

Properties

Property	Value
Label	MSG_TIMER
Type	SendEyeLinkMessage
Time	
Start Time	
Clear Input Queues	<input checked="" type="checkbox"/>
Message	Timer Triggered

A

B

Figure 7-12. Using Sending Message Action.

7.9.5 Sending EyeLink® Command

The EyeLink® tracker accepts text commands sent through the link. The SEND_COMMAND action () is used for on-line tracker configuration and control. Please refer to the .ini files in the EyeLink® directory of the host PC (typically c:\eyelink2\exe for EyeLink® II and c:\EyeLink\exe for EyeLink® I system) for a list of

possible commands that can be sent with this action. The send-command action is not available in non-EyeLink© experiments.

Field	Attribute Reference	Type	Content
Label *	.label	String	Label of the SEND_COMMAND action. The default value is "EL_COMMAND".
Type #	NR		The type of Experiment Builder objects ("EyeLinkCommand") the current node belongs to.
Node Path	.absPath	String	The absolute path of the node in the experiment graph
Time #	.time	Float	Display PC Time when the SEND_COMMAND action is done.
Start Time #	.startTime	Float	Display PC Time when the action starts.
Clear Input Queues †	.clearInputQueues	Boolean	If true, all events from input queues are flushed when the action is started. This includes all Experiment Builder triggers, such as keyboard, mouse, TTL, and EyeLink inputs (button, saccade, fixation). This results in upcoming Triggers only firing based on events that are collected following the start of the Action. If false, the input queues are not cleared when the action is performed, meaning that any events already in the queues will be evaluated by Triggers following the action.
Command	.command	String	The command used to configure or control the EyeLink© tracker. For a complete list of commands and current tracker configuration, examine the *.INI files in the EyeLink© directory of the eye-tracker computer.
Text	.text	String	The parameters to be passed along with the command.
Priority †	.priority	Boolean	If enabled, causes the command to be executed with the highest priority. This priority is even higher than the output of analog or link sample data, so please use it carefully. The use of this prefix should be limited to the "write_ioport" command. Typical command execution is 1-20 ms after the action is pressed. With '!' prefix, this is reduced to less than 1 ms 99% of the time. In the worst case, it may still about 10 ms but rarely higher than 2 ms. The default setting is "False". This setting has no effect on EyeLink I.
Log Time †	.logTime	Boolean	If enabled, logs the command and its delay in execution to the EDF file (and link if message events are enabled). The default setting is "False". The message time is when the command completed execution. The message

			syntax is : !CMD <execution delay> <text of command> This setting has no effect on EyeLink © I.
Wait for Result †	.waitForResult	Boolean	Whether the program should wait for a response from the tracker.
Result Time Out	.resultTimeOut	Integer	Sets the maximum amount of time to wait for a response from the tracker. If no result is returned, then the error code NO_REPLY is returned.
Exit On Fail †	.exitOnFail	Boolean	Whether the experiment should be terminated if there is an error in the command. Important: please leave this field unchecked unless it is absolutely necessary that you should terminate the experiment if the EyeLink send command action fails.
Result #	.result	Integer	Result code for the command: 0: Command successfully sent; 1: Unknown command; -1: Unexpected end of line; -2: Syntax error; 1000: No reply from the tracker.
Result Message #	.resultMessage	String	Returns text associated with last command response: may have error message (see above).

Figure 7-13 illustrates how to draw a white filled box on the top-left quadrant of the tracker screen using the EyeLink© Command action. In the “Command” field, type in “draw_filled_box” (without quotes) and in the “Text” field, enter “0 0 512 384 15” (without quotes). Please refer to the .ini files in the host PC for the syntax of EyeLink© commands.

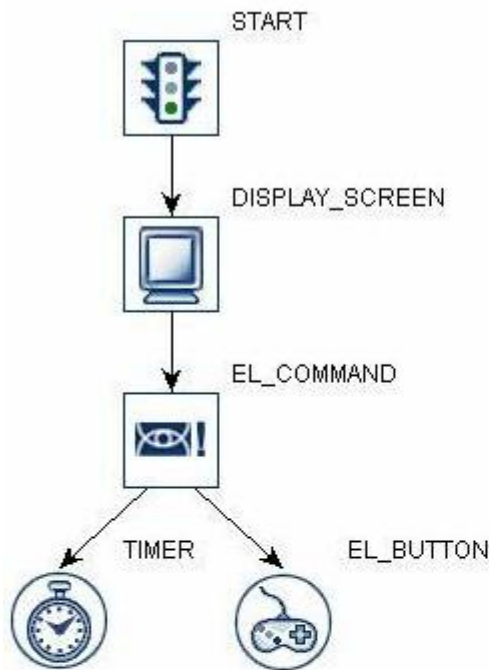

A

Property	Value
Label	EL_COMMAND
Type	EyeLinkCommand
Time	
Start Time	
Clear Input Queues	<input checked="" type="checkbox"/>
Command	draw_filled_box
Text	0 0 512 384 15
Priority	<input type="checkbox"/>
Log Time	<input type="checkbox"/>
Wait For Result	<input checked="" type="checkbox"/>
Result Timeout	1000
Exit On Fail	<input type="checkbox"/>
Result	
Result Message	

B

Figure 7-13. Using Sending EyeLink© Command Action.

7.9.6 Sending TTL Signal

This action () sends a TTL signal via the parallel port or other data ports of the display PC. Please make sure that you have DriverLINX Port I/O Driver installed before using this action.

Field	Attribute Reference	Type	Content
Label *	.label	String	Label of the SET TTL action.
Type #	NR		The type of Experiment Builder objects ("SetTTL") the current node belongs to.
Node Path	.absPath	String	The absolute path of the node in the experiment graph

Message	.message	String	Message to be written to EDF file when sending the TTL signal. This attribute is only available in an EyeLink© experiment.
Time #	.time	Float	Display PC Time when TTL signal is sent.
Start Time #	.startTime	Float	Display PC Time when sending TTL signal begins.
Clear Input Queues †	.clearInputQueues	Boolean	If true, all events from input queues are flushed when the action is started. This includes all Experiment Builder triggers, such as keyboard, mouse, TTL, and EyeLink inputs (button, saccade, fixation). This results in upcoming Triggers only firing based on events that are collected following the start of the Action. If false, the input queues are not cleared when the action is performed, meaning that any events already in the queues will be evaluated by Triggers following the action.
Register ¶	.register	String	Usually set as "DATA".
Mode *	.mode	String	Either "Word" mode (the decimal or hexadecimal value of the TTL signal output) or "Pin" mode (status of each individual pins).
Data	.data	Integer	The byte value of the current TTL signal output. It could be a decimal or hexadecimal value. This field is only available if the "Mode" property is set to "Word".
Pin0 Pin1 Pin2 Pin3 Pin4 Pin5 Pin6 Pin7	.pin0 .pin1 .pin2 .pin3 .pin4 .pin5 .pin6 .pin7	String	The desired status for the corresponding pins. The pin value can be either "ON" (high) or "OFF" (low). These fields are only available if the "Mode" property

7.9.7 Adding to Experiment Log

For the ease of experiment debugging, messages can be written to a log file so that errors in the experiment programming can be detected early. The ADD_TO_LOG action () allows the user to send one log message per call.

Field	Attribute Reference	Type	Content
Label *	.label	String	Label of the ADD_TO_LOG action. The default value is "ADD_TO_LOG".
Type #	NR		The type of Experiment Builder objects ("AddToExperimentLog") the current node belongs to.
Node Path #	.absPath	String	The absolute path of the node in the

			experiment graph.
Time #	.time	Float	Display PC Time when the action is processed.
Start Time #	.startTime	Float	Display PC Time when the action starts.
Clear Input Queues †	.clearInputQueues	Boolean	If true, all events from input queues are flushed when the action is started. This includes all Experiment Builder triggers, such as keyboard, mouse, TTL, and EyeLink inputs (button, saccade, fixation). This results in upcoming Triggers only firing based on events that are collected following the start of the Action. If false, the input queues are not cleared when the action is performed, meaning that any events already in the queues will be evaluated by Triggers following the action.
Log File Message	.logMessage	String	Message to be written to the log file.
Log File *	NR	String	File to which the log message is written. The default file name is "Logfile". If this field is left empty, the message will be printed to command line (or the output tab of Experiment Builder if test running the project).

In the following example (Figure 7-14), the user adds a sample velocity trigger in the experiment and wants to check out whether the values of trigger (e.g., left eye gaze position, eye velocity and acceleration, and trigger time) are right when it fires. The user may add an ADD_TO_LOG action following the sample_velocity trigger and set the “Log File Message” field of the action as:

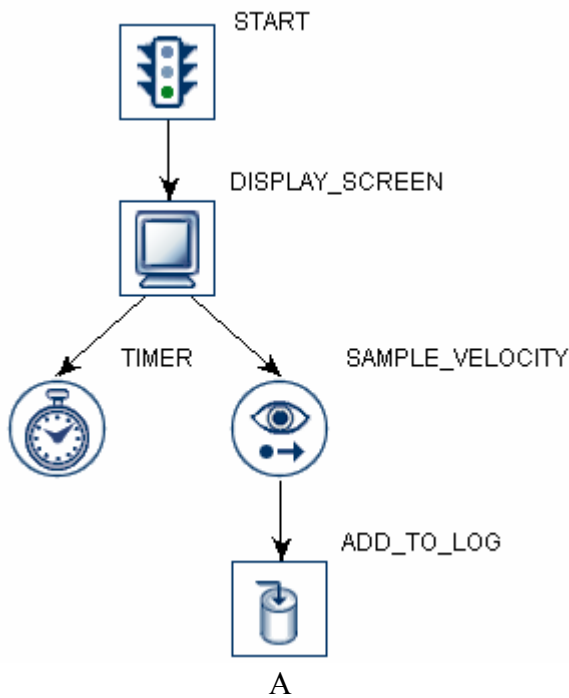

Property	Value
Label	ADD_TO_LOG
Time	
Start Time	
Log File Message	= "Trigger " + str(@SAM...
Log File	LogFile

Figure 7-14. Using Add to Experiment Log Action

```
= "Trigger " + str(@SAMPLE_VELOCITY.triggeredData.EDFTime@)
+ " LOC "+ str(@SAMPLE_VELOCITY.triggeredData.leftGazeX@)
+ " " + str(@SAMPLE_VELOCITY.triggeredData.leftGazeY@)
+ " VEL " + str(@SAMPLE_VELOCITY.triggeredData.leftVelocity@)
+ " ACCL " + str(@SAMPLE_VELOCITY.triggeredData.leftAcceleration@)
```

The following is one sample output from the LogFile.txt file when the sample-velocity trigger fires:

```
Trigger 852012 LOC 500.299987793 403.399993896 VEL 196.741027908
ACCL 98370.5273723
```

7.9.8 Updating Attribute

The UPDATE_ATTRIBUTE action () modifies the value of a variable or an attribute of an experiment component. For example, in a change-detection experiment (see section 7.11.1 “Variable”), the user may want to display two slightly different images for a certain number of cycles and then stop the presentation after that. To do that, the user may create a new variable to keep track of the current iteration status (behaving as a counter) and use the UPDATE_ATTRIBUTE action to update the counters value on each cycle of the graph.

Field	Attribute Reference	Type	Content
Label *	.label	String	Label of the UPDATE_ATTRIBUTE action. The default value is “UPDATE_ATTRIBUTE”.
Type #	NR		The type of Experiment Builder objects ("UpdateAttribute") the current node belongs to.
Node Path #	.absPath	String	The absolute path of the node in the experiment graph.
Message	.message	String	Message to be sent to EDF file (in an EyeLink© experiment.) or messages.txt (in a non-EyeLink experiment with " Save Messages" attribute of the Experiment node checked) when the action is executed.
Time #	.time	Float	Display PC Time when the UPDATE_ATTRIBUTE action is done.
Start Time #	.startTime	Float	Display PC Time when the action started.
Clear Input Queues †	.clearInputQueues	Boolean	If true, all events from input queues are flushed when the action is started. This includes all Experiment Builder triggers, such as keyboard, mouse, TTL, and EyeLink inputs (button, saccade, fixation). This results in upcoming Triggers only firing based on events that are collected following the start of the Action. If false, the input queues are not cleared when the action is performed, meaning that any events

			already in the queues will be evaluated by Triggers following the action.
Attribute, Attribute 2, Attribute 3	NR		Used to set up an attribute-value list; the number of currently established attribute-value pairs is displayed in the value field of the property. To add more attribute-value pairs, click on the value field. The "Attribute" column of the dialog box specifies the variable or attribute to which the current action is referring and the "Value" column specifies the new value assigned to the corresponding target attribute
Value, Value 2, Value 3	.value, .value2, .value3		The new value assigned to the corresponding target attribute.

The user can update the value of an attribute by assigning a value directly (e.g., setting the value of VARIABLE1 to 0), referring to another attribute (e.g., retrieving the time when the EyeLink button box was pressed and assign this time to VARIABLE2), or using equation (e.g., incrementing the value of VARIABLE3 by 1).

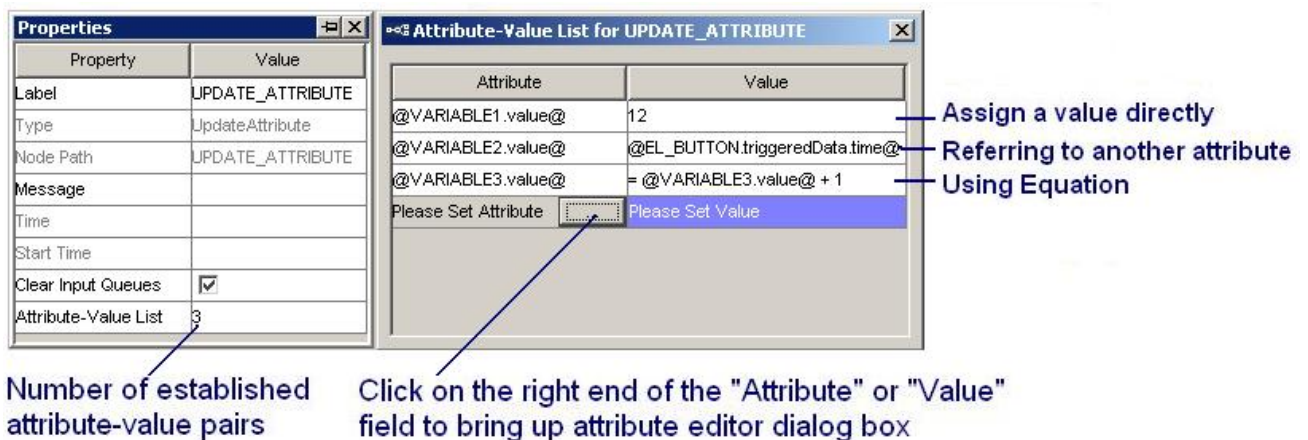

Figure 7-15. Using Update Attribute Action.

7.9.9 Adding to Accumulator

The ADD_ACCUMULATOR action (Σ^+) is used to add data to an accumulator object (see Section 7.11.3 “Accumulator” for example) so that statistical analysis can be done on the stored data.

Field	Attribute Reference	Type	Content
Label *	.label	String	Label of the ADD_ACCUMULATOR action. The default value is “ADD_ACCUMULATOR”.
Type #	NR		The type of Experiment Builder objects ("AddAccumulator") the current node

			belongs to.
Node Path	.absPath	String	The absolute path of the node in the experiment graph.
Message	.message	String	Message to be sent to EDF file (in an EyeLink© experiment.) or messages.txt (in a non-EyeLink experiment with "Save Messages" attribute of the Experiment node checked) when the action is executed.
Time #	.time	Float	Display PC Time when the action is done.
Start Time #	.startTime	Float	Display PC Time when the action starts.
Clear Input Queues †	.clearInputQueues	Boolean	If true, all events from input queues are flushed when the action is started. This includes all Experiment Builder triggers, such as keyboard, mouse, TTL, and EyeLink inputs (button, saccade, fixation). This results in upcoming Triggers only firing based on events that are collected following the start of the Action. If false, the input queues are not cleared when the action is performed, meaning that any events already in the queues will be evaluated by Triggers following the action.
Accumulator ¶*	NR		The accumulator the current action is referring to.
Add Value	.addValue	Number	This specifies the value (0.0 by default) to be added to the accumulator.

7.9.10 Adding to Result File

The ADD_RESULT action () is used to send data to a result file so that the user will get a columnar output for some variables. The user should first add a RESULT_FILE object (see Section 7.11.2 “Result File” for example) into the experiment graph and add columns of the data source file and/or newly created variables to the result file.

Field	Attribute Reference	Type	Content
Label *	.label	String	Label of the ADD_TO_RESULT_FILE action. The default value is “ADD_TO_RESULTS_FILE”.
Type #	NR		The type of Experiment Builder objects ("AddToResultsFile") the current node belongs to.
Node Path	.absPath	String	The absolute path of the node in the experiment graph.
Time #	.time	Float	Display PC Time when the action is done.
Start Time #	.startTime	Float	Display PC Time when the action starts.
Clear Input Queues †	.clearInputQueues	Boolean	If true, all events from input queues are flushed when the action is started. This includes all Experiment Builder triggers, such as keyboard, mouse, TTL, and EyeLink inputs (button,

			saccade, fixation). This results in upcoming Triggers only firing based on events that are collected following the start of the Action. If false, the input queues are not cleared when the action is performed, meaning that any events already in the queues will be evaluated by Triggers following the action.
Results File ¶*	NR		The Result file the current action is referring to.

7.9.11 Preparing Sequence

Before starting the portion of the experiment that contains the important experiment manipulations and time critical actions (often the sequence that eye data is recorded in as well), the experiment should be given the opportunity to prepare upcoming actions as much as possible. The Prepare Sequence Action includes the following operations:

- a) Preloading the image or audio files to memory for real-time image drawing or sound playing;
- b) Drawing feedback graphics on the host PC so that the participants' gaze accuracy can be monitored;
- c) Re-initializing trigger and action settings.
- d) Flush the log files.

In a typical experiment, the user should call the prepare-sequence action before entering the trial recording sequence, preferably before performing a drift correction. In most of the experiments, the "Reinitialize Triggers" box should be checked so that the data for each trigger is reset for re-firing.

IMPORTANT: For proper timing, it is critical that the Prepare Sequence Action be called before the trial run-time for **EVERY** iteration of the trial run-time sequence.

IMPORTANT: The Prepare Sequence Action Loads the image and audio files based on the state of display screen and Play Sound actions at the time the Prepare Sequence is called. This means that if an image name or audio file name is changed after the Prepare Sequence action is called, the new image or audio resource will not be preloaded and timing may be affected. If an image or audio file has not been preloaded when it is used in the Display Screen or Play Sound action that references it, a warning message will be written to the warnings.log file for the experiment session.

Field	Attribute Reference	Type	Content
Label *	.label	String	Label of the PREPARE_SEQUENCE action. The default value is "PREPARE_SEQUENCE".
Type #	NR		The type of Experiment Builder objects ("PrepareSequence") the current node belongs to.
Node Path	.absPath	String	The absolute path of the node in the

			experiment graph.
Message	.message	String	Message to be sent to EDF file (in an EyeLink© experiment.) or messages.txt (in a non-EyeLink experiment with "Save Messages" attribute of the Experiment node checked) when the PREPARE_SEQUENCE action is done.
Time #	.time	Float	Display PC Time when the PREPARE_SEQUENCE action is processed.
Start Time #	.startTime	Float	Display PC Time when the action starts.
Clear Input Queues †	.clearInputQueues	Boolean	If true, all events from input queues are flushed when the action is started. This includes all Experiment Builder triggers, such as keyboard, mouse, TTL, and EyeLink inputs (button, saccade, fixation). This results in upcoming Triggers only firing based on events that are collected following the start of the Action. If false, the input queues are not cleared when the action is performed, meaning that any events already in the queues will be evaluated by Triggers following the action.
Load Screen Resources *†	.loadImages	Boolean	If enabled (default), all of the possible images used in the current sequence (and sequences nested within it) will be preloaded for real-time performance.
Load Audio *†	.loadAudio	Boolean	If enabled (default), all of the possible sound clips used in the current sequence (and sequences nested within it) will be preloaded for real-time performance.
Draw to EyeLink© Host *†	.drawToEyeLinkHost	Integer	If "NO" (0), no feedback graphics is drawn on the host PC screen. If "IMAGE" (1), transfers one of the display screens to the tracker PC as backdrop for gaze cursors. If "PRIMITIVE" 2, draws primitive line drawings on the host PC to indicate the location of resources used in a display screen. This attribute is only available in an EyeLink© experiment.
Reinitialize Triggers *†	.reinitTriggers	Boolean	If checked, performing this action will also clear trigger data for re-initialization.
Reinitialize Actions *†	.reinitActions	Boolean	If checked, performing this action will also clear action data for re-initialization.
Reinitialize Video Resources *†	.reinitVideoResources	Boolean	If checked, the video resource, if used in the previous trial, will be rewound to the beginning.
Flush Log *†	.flushLogs	Boolean	If checked, this will write the messages to the log file and clear the buffer.

The following (Figure 7-16) illustrates the use of PREPARE_SEQUENCE action. In this example, "Draw to EyeLink© Host" field of the PREPARE_SEQUENCE action is checked. The "Use for Host Display" field of the DISPLAY_SCREEN is also checked

so that drawing on that screen will be shown on the host PC (simple rectangular boxes to mark the location of the resources).

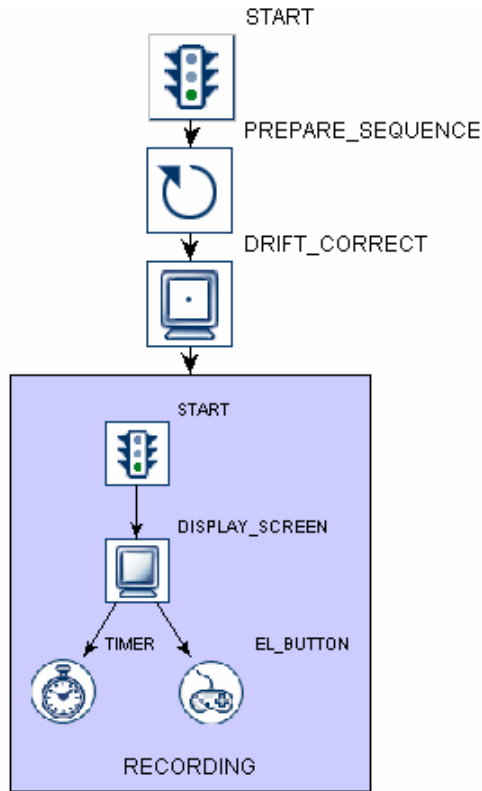

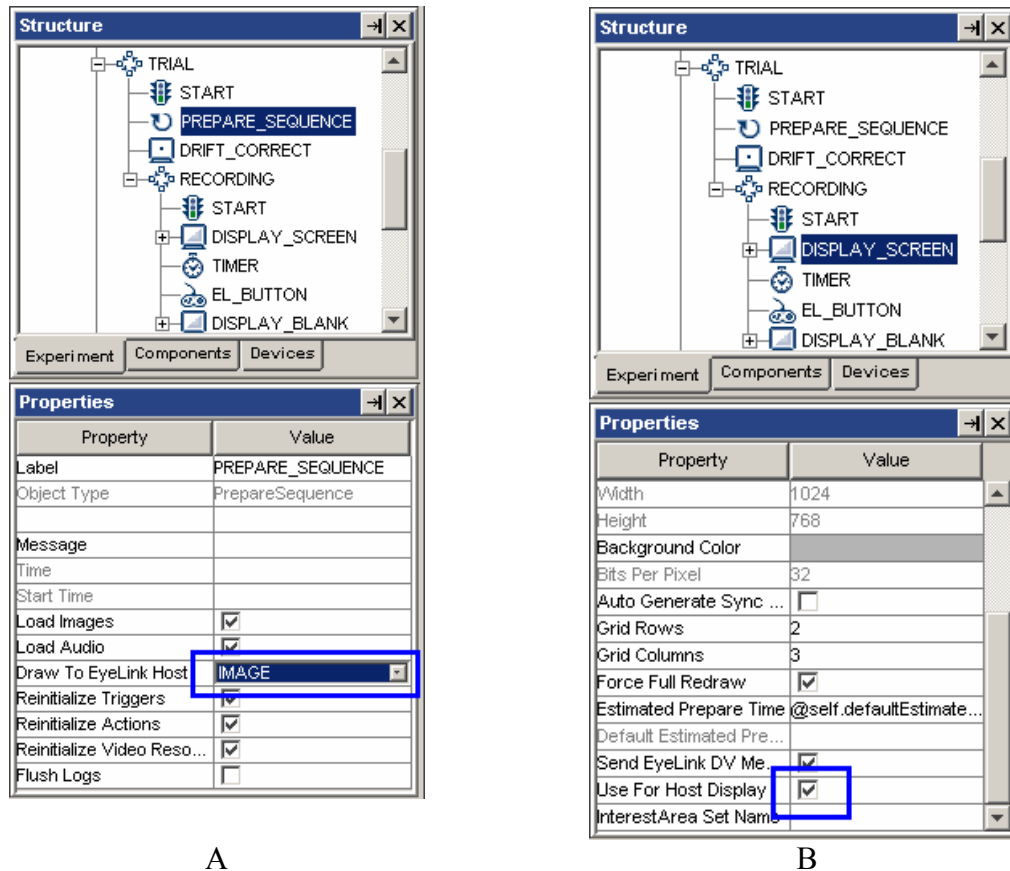

A
B
Figure 7-16. Using Prepare Sequence Action.

7.9.12 Reset Node

Similar to the PREPARE_SEQUENCE action, RESET_NODE action (🔄) can be used to re-initialize trigger and action data. The RESET_NODE can also be used to clear the data stored in an accumulator.

Field	Attribute Reference	Type	Content
Label *	.label	String	Label of the RESET_NODE action.
Type #	NR		The type of Experiment Builder objects ("ResetNode") the current node belongs to.
Node Path	.absPath	String	The absolute path of the node in the experiment graph.
Message	.message	String	Message to be sent to EDF file (in an EyeLink© experiment.) or messages.txt (in a non-EyeLink experiment with " Save Messages" attribute of the Experiment node checked) when the RESET_NODE action is done.
Time #	.time	Float	Display PC Time when this action is done.
Start Time #	.startTime	Float	Display PC Time when the action starts.
Clear Input	.clearInputQueue	Boolea	If true, all events from input queues are flushed

Queues †	s	n	when the action is started. This includes all Experiment Builder triggers, such as keyboard, mouse, TTL, and EyeLink inputs (button, saccade, fixation). This results in upcoming Triggers only firing based on events that are collected following the start of the Action. If false, the input queues are not cleared when the action is performed, meaning that any events already in the queues will be evaluated by Triggers following the action.
Reset Node *¶	NR		The node whose data will be reset.

7.9.13 Playing Sound

SR Research Experiment Builder supports loading of .WAV audio files and playing the clips with the PLAY_SOUND action (). Before using the PLAY_SOUND action, make sure that target sound files are loaded into the experiment library manager. This can be done by clicking “Edit → Library Manager” from the application menu bar (see Figure 7-17). A dialog box will show up to let the user load in image, sound resources, or interest area set files. Select the “Sound” tab and click “Add” button to load in the target sound files. Please note that the playing of an audio clip is asynchronous (i.e., the action returns before the sound finishes playing). As a result, if a sound clip is played at the end of a sequence (e.g., used as a feedback to the participant), the user needs to attach a timer following the play-sound action to ensure that the whole sound clip will be played.

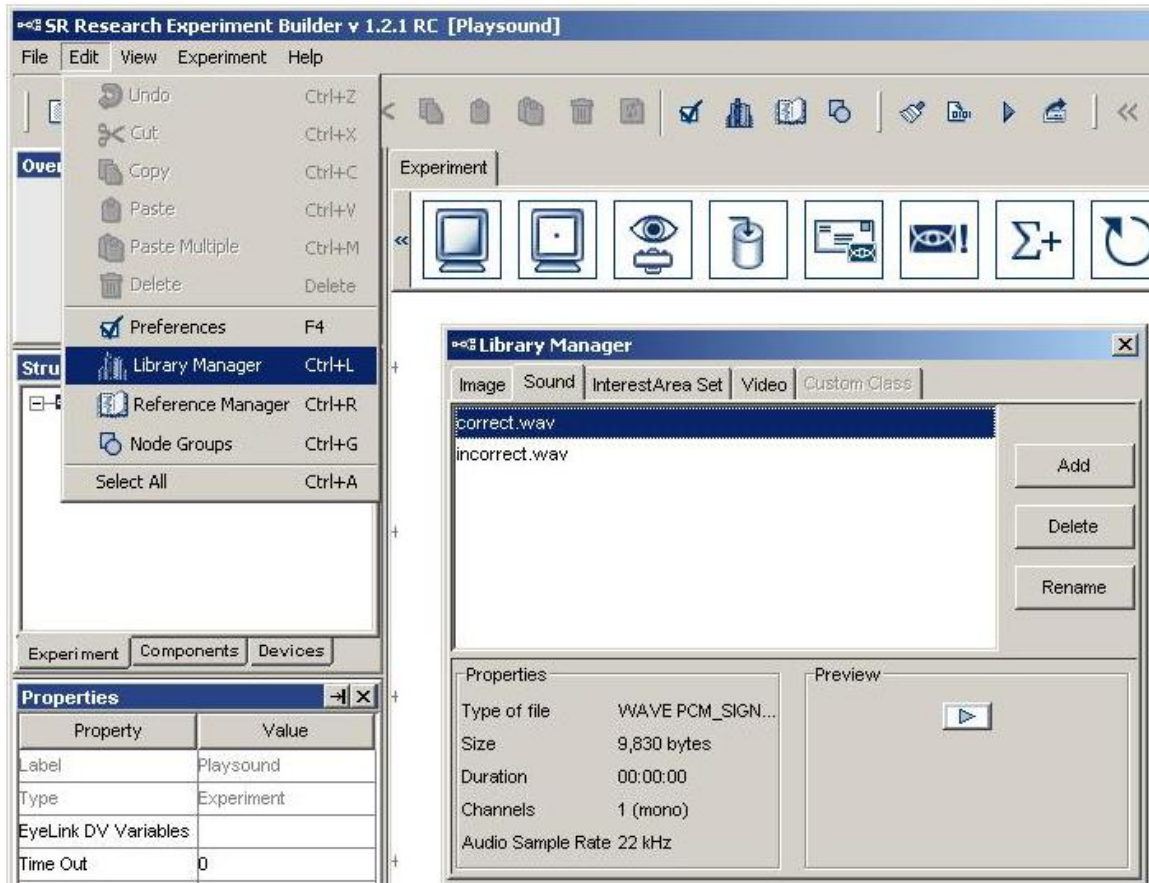

Figure 7-17. Adding Sound Clips to the Library

The user can play the sound clips with DirectX driver or with ASIO audio driver (chosen from the “Devices → Audio” settings; see Figure 7-18). The ASIO driver supports predictable and low latency audio playback and recording, and therefore, is ideal for experiments that require high audio playing precision (e.g., audio-visual synchronization or with audio stimulus onset asynchrony manipulation). If the user chooses to use the ASIO driver, please make sure that a Creative Audigy sound card that supports the ASIO 2.0 specification is installed on the Development PC (and the Deployment PC as well if it is used). In the device setting for ASIO driver (Figure 7-18, Panel A), “ASIO Audio driver” indicates the name of the ASIO driver. “Output Interval” returns the interval (in milliseconds) between ASIO buffer swaps, which determines how often new sounds can be output. “Minimum Output Latency” indicates the minimum output latency of the ASIO driver (delay from buffer switch to first sample output).

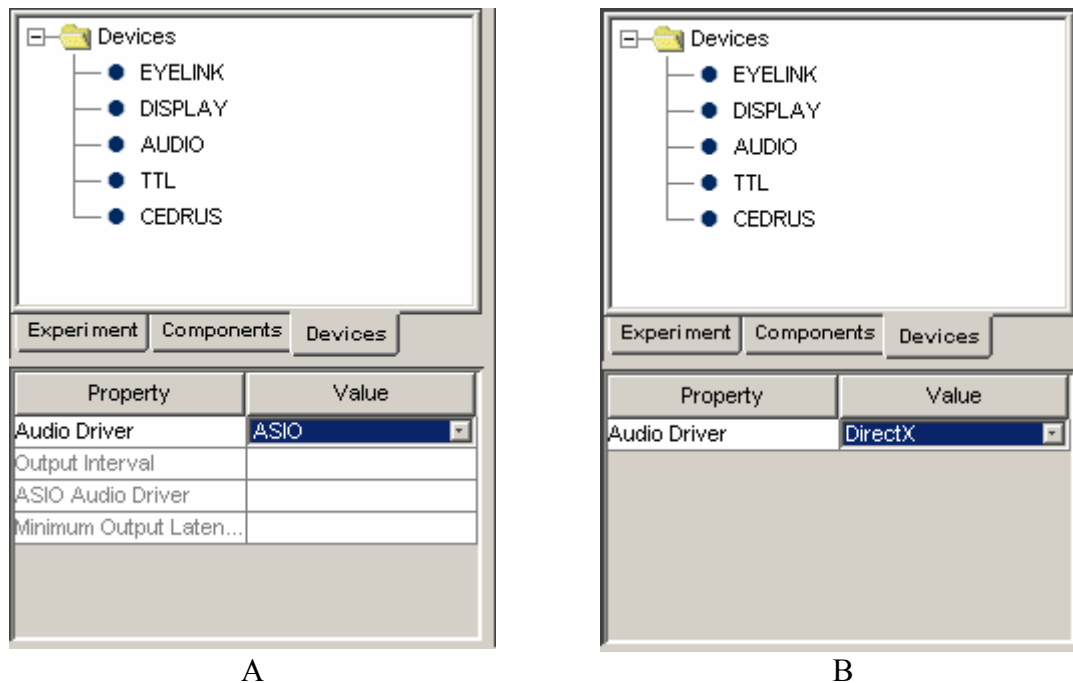

Figure 7-18. Choose Audio driver.

The following table lists the properties of a PLAY_SOUND action.

Field	Attribute Reference	Type	Content
Label *	.label	String	Label of the PLAY_SOUND Action. The default value is "PLAY_SOUND".
Type #	NR		The type of Experiment Builder objects ("PlaySound") the current node belongs to.
Node Path	.absPath	String	The absolute path of the node in the experiment graph.
Message	.message	String	Message to be sent to EDF file (in an EyeLink© experiment.) or messages.txt (in a non-EyeLink experiment with "Save Messages" attribute of the Experiment node checked) when the PLAY_SOUND action is executed.
Time #	.time	Float	Display PC Time when the PLAY_SOUND action is done.
Start Time #	.startTime	Float	Display PC Time when the action starts.
Clear Input Queues †	.clearInputQueues	Boolean	If true, all events from input queues are flushed when the action is started. This includes all Experiment Builder triggers, such as keyboard, mouse, TTL, and EyeLink inputs (button, saccade, fixation). This results in upcoming Triggers only firing based on events that are collected following the start of the Action. If false, the input queues are not cleared when the action is performed, meaning that any events already in the queues will be evaluated by Triggers following the action.

Audio Device #	NR		Indicating the current audio driver setting (either DirectX or ASIO). This field is neither editable nor referable.
Sound File	.firstSoundFile	String	The name of the sound file. This is automatically set to one of sound files in the library ("None" if no sound file is loaded in the library).
Volume	.firstvolume	Float	Adjusts the volume of audio playing. Volume ranges from 0.0 (muted) to 1.0 (full volume). The default value is 1.0.
Playing #	.playing	Boolean	Whether the sound playing has begun and is in progress. The possible values are 'true' and 'false'. If sound playing is done, this returns 'False'.

Note: The following fields are specific to the ASIO driver only.

Balance	.firstPan	Float	Adjusts the balance of the sound buffer. Balance ranges from -1.0 (left channel only) through 0.0 (left and right channels have equal volume) to 1.0 (right channel only). Balance works by attenuating one of the channels: for example, at a pan of 0.5 the right channel is at full volume while the left channel is at a volume of 0.5.
Estimated Prepare time	.estimatedPrepareTime	Float	If the sound is scheduled enough in advance it will play on time. The estimate time to prepare for clip playing for guaranteed performance will be ASIO minimum output latency * 2.
Play Start Sample	.playStartSample	Integer	The position within the buffer of the start of play (samples from start of file loaded into buffer; 0, start of buffer).
Play End Sample	.playEndSample	Integer	The position within the buffer for the end of play (samples from start of file loaded into buffer; 0, end of buffer).
Play Start Time #	.playStartTime	Float	Reports the time at which the first sample of a clip was last played (in Display PC time). This is set to 0 when the clip playing is scheduled and reset to 0 after the clip finishes playing.
Buffer Max Samples #	.bufferMaxSamples	Integer	Gets the maximum number of samples the audio buffer allocated can hold.
Sample Count #	.sampleCount	Integer	Retrieves the actual sample count stored in buffer.
Is Mono #	.ismono	Boolean	Determines if buffer contains mono or stereo data.
Sample Rate #	sampleRate	Integer	Retrieves the sample rate (in samples per second) of the buffer. All of the audio buffers have a sample rate of either 48,000 or 24,000 samples per second, chosen to be compatible with most ASIO drivers. When a .WAV file is loaded that has a different sample rate, it is converted to one of these sample rates using

			sophisticated digital signal processing algorithms which do not degrade sound quality.
Current Play Position #	playPosition	Float	Gets the current play position (time in milliseconds from the start of the clip playing).
Current Sample #	.currentSample	Integer	Gets the current sample being played.

The synchronization of audio and visual presentations is critical in some experiments. When the DirectX is used for playing an audio clip, the play sound action is done as quickly as possible; however, no timing certainty should be expected when using this audio driver. If your experiment requires accurate audio timing, the ASIO driver should be used. The ASIO driver creates two audio buffers for each input or output channel. When producing sounds, one buffer is being played by the audio card while the other buffer is being filled with sound data by the Experiment Builder. When the ASIO driver finishes playing its buffer, the application and driver buffers are switched. This means that sounds are actually produced at a short (but highly predictable) delay after the data is stored in the buffer. Since the Creative Labs sound cards we recommended have a typical latency setting of 10 milliseconds, this would have a buffer switch interval of 10 milliseconds and an output delay of 10 milliseconds. The time that the clip was actually played will be accurately reported in the EDF file. When using an ASIO driver:

- If the start of a sound has been commanded far enough in advance of the time the sound is to be played (e.g., the PLAY_SOUND action is preceded by a TIMER trigger with a duration of greater than 20 ms), the Experiment Builder software will be able to write the sound data in advance to the ASIO buffer and therefore the first sample of the clip will be emitted from the sound card within 3 milliseconds (plus or minus) of the scheduled time.
- If the sound is commanded to happen as quickly as possible (e.g., for example in response to a subject response, external signal, or eye movement event), or if the sound play command was not given far enough in advance (e.g., the PLAY_SOUND action is preceded by a TIMER with a duration shorter than 20 ms), Experiment Builder is unable to compensate for system delays and the audio will begin after a short delay. However, the exact moment that the sound will play is predictable and can be reported precisely for analysis later. This applies to experiments in which the PLAY_SOUND action is preceded by an action or by a node other than TIMER.
- Experiment Builder allows to synchronize the playing of the audio clip and displaying of visual stimuli when the display screen and play sound actions are intervened with a TIMER trigger only. Experiment Builder also allows the users to set the audio clip information from the DISPLAY_SCREEN action directly by enabling "Audio Synchronization" check box. The user needs to specify the clip to be played and the time offset relative to the display onset (a negative offset value means that the audio clip is played before visual onset whereas a positive offset means that the visual information is presented earlier). Please note that, in this case, the user does not have to add a PLAY_SOUND action immediately before or after the DISPLAY_SCREEN action.

Audio played with ASIO driver will have messages logged in the EDF (EyeLink experiment) or message file (non-EyeLink experiment with "Save Messages" option enabled in the project node). The start time of audio playing is logged as "!V APLAYSTART" message and the end time is marked by "!V APLAYSTOP " message. Both messages have a negative time offset typically preceding this message.

- Playing Starts: MSG <EDF time> <offset> <!V APLAYSTART> <start frame> <clip id> <audio file>
- Playing Ends: MSG <EDF time> <offset> <!V APLAYSTOP > <stop frame> <clip id> <audio file>

In the following example, the FIXATION_SCREEN is displayed at time 10400921 [10400919 - (-2)], and the PLAY_BEEP sound is emitted at time 10401021 [10401007 - (-14)]. So the delay between FIXATION_SCREEN and PLAY_BEEP is 100 ms.

```
MSG 10400919 -2 FIXATION_SCREEN
MSG 10401000 -2 !V DRAW_LIST ../../runtime/dataviewer/test/graphics/VC_1.vcl
MSG 10401007 -14 !V APLAYSTART 0 1 library\audio\innertrialbeep.wav
MSG 10401021 PLAY_BEEP
MSG 10401903 -14 !V APLAYSTOP 19755 1 library\audio\innertrialbeep.wav
```

The following figure illustrates the use of the PLAY_SOUND action to provide feedback to participant's performance: if the participant presses the correct button, one sound is played; if the participant presses the wrong button, another sound is played. For each PLAY_SOUND action, the user needs to specify the desired sound clip to be played from the sound library.

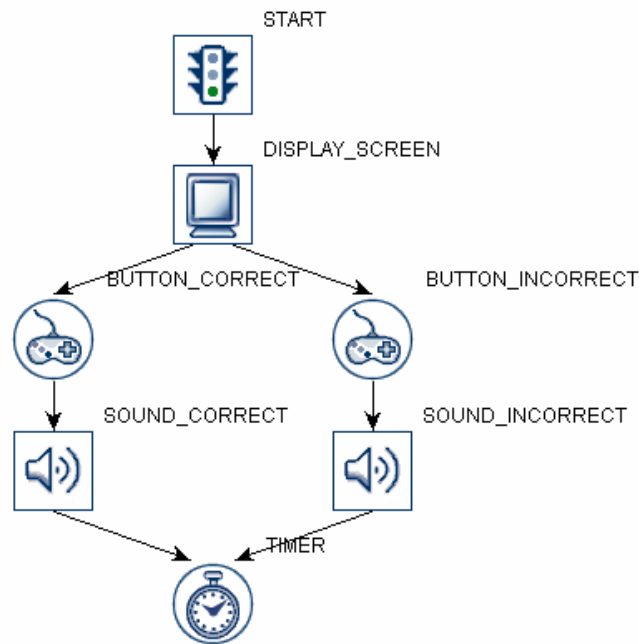

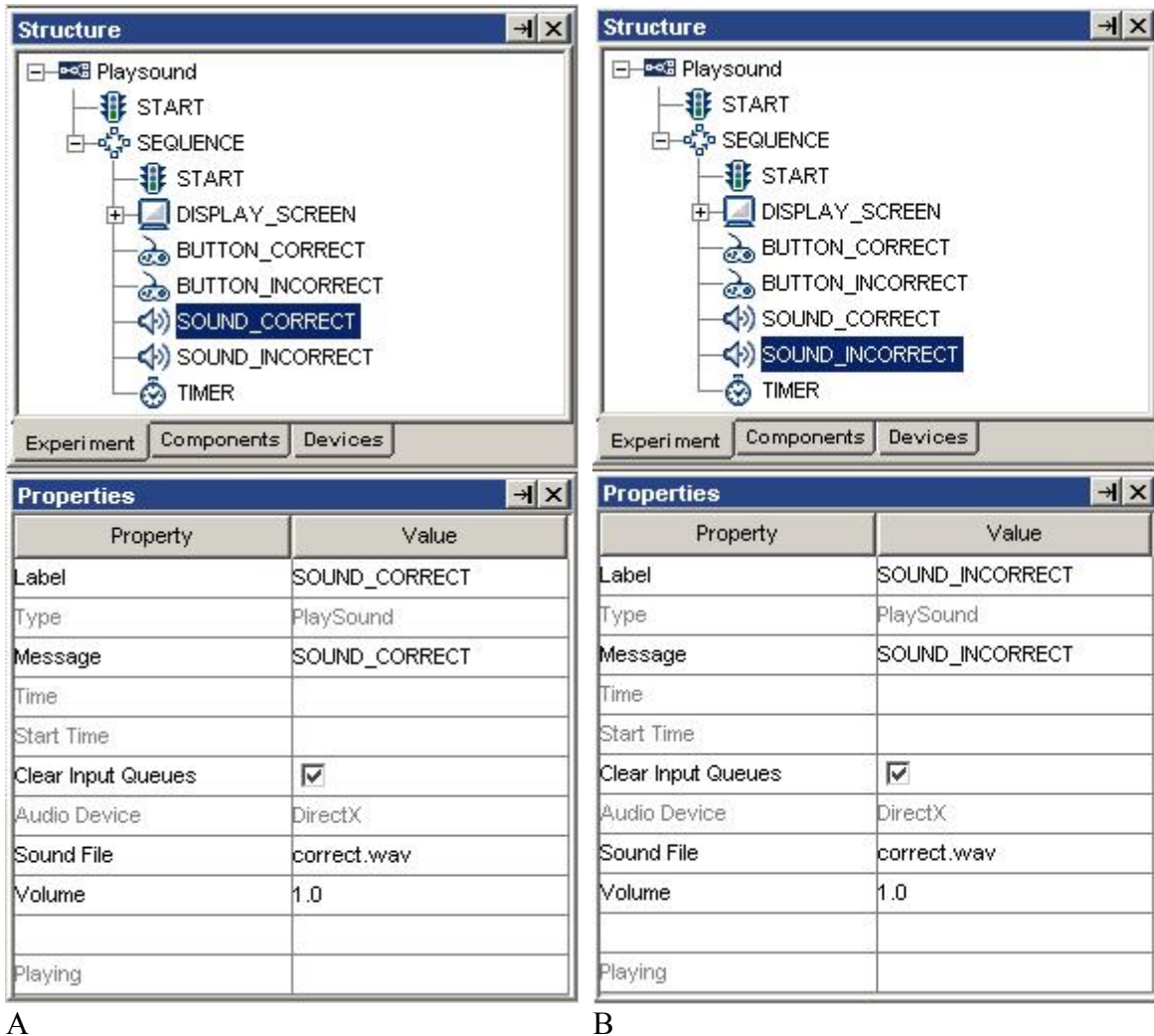



Figure 7-19. Using Play Sound Action.

7.9.14 Play Sound Control

Play Sound Control action () stops, pauses, or plays a specified playsound action. Please note that the "pause" and "play" (continue playing of a paused audio) actions are only applicable when DirectX driver is used.

Field	Attribute Reference	Type	Content
Label *	.label	String	Label of the Play Sound Control action. The default label is "PLAY_SOUND_CONTROL".
Type #	NR		The type of Experiment Builder objects ("PlaySoundControl") the current node belongs to.
Node Path	.absPath	String	The absolute path of the node in the experiment graph.
Message	.message	String	Message to be sent to EDF file (in an

			EyeLink© experiment.) or messages.txt (in a non-EyeLink experiment with " Save Messages" attribute of the Experiment node checked) when the action is done
Time #	.time	Float	Display PC Time when the action is done.
Start Time #	.startTime	Float	Display PC Time when play sound control action begins.
Clear Input Queues †	.clearInputQueues	Boolean	If true, all events from input queues are flushed when the action is started. This includes all Experiment Builder triggers, such as keyboard, mouse, TTL, and EyeLink inputs (button, saccade, fixation). This results in upcoming Triggers only firing based on events that are collected following the start of the Action. If false, the input queues are not cleared when the action is performed, meaning that any events already in the queues will be evaluated by Triggers following the action.
Target Play Sound Action *	NR		The intended play sound action to be controlled (stop, pause, or play).
Operation *	.operation	String	Action used to control the current audio recording: STOP, PAUSE, or PLAY (continue playing a paused audio). Please note that "PAUSE" and "PLAY" controls are only valid with DirectX driver.

The following graph illustrates playing a sound clip (PLAY_SOUND_DIRECTX) for 1 second (TIMER_PLAYING), pausing (PAUSE_AUDIO) for 1 second (TIMER_PAUSING), and then resume playing (UNPAUSE AUDIO) with Direct X driver.



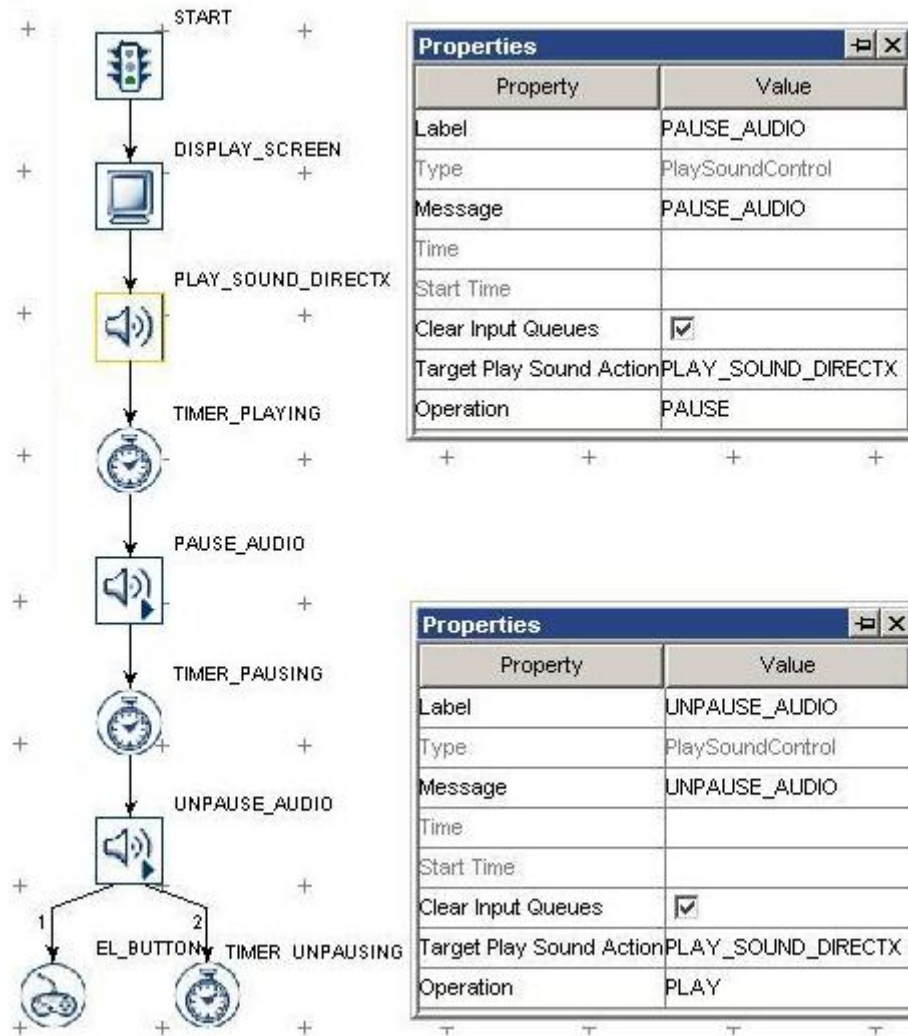



Figure 7-20. Using Play Sound Control Action

7.9.15 Record Sound

For experiments where verbal responses are required, the SR Research Experiment Builder supports both recording of audio to a WAV file and an integrated voicekey trigger. The recommended experimental procedure would be to record a .WAV file for each trial, using some numbering system, and to use the voicekey to detect the response. Recorded data is always written to an audio buffer first, and can later be copied to a WAV file. It is possible to record many short recording segments to one large file, relying on the messages placed in the EDF file to determine the start and end of each recording. However, this may require a lot of memory and take longer to save the file.

The Record_sound action () supports recording of audio to a .WAV file using the ASIO driver (and therefore this action is only supported when an ASIO-compatible sound

card is installed on the display PC and the Audio Device is set to "ASIO"). A message placed in the EDF file will mark the exact time and position in the WAV file of the first recorded sample for analysis. The resulting .wav files are saved in "results\{session name}" directory.

The following table lists the properties of a RECORD_SOUND action.

Field	Attribute Reference	Type	Content
Label *	.label	String	Label of the Record Sound action. The default label is "RECORD_SOUND".
Type #	NR		The type of Experiment Builder objects ("RecordSound") the current node belongs to.
Node Path	.absPath	String	The absolute path of the node in the experiment graph.
Message	.message	String	Message to be sent to EDF file (in an EyeLink© experiment.) or messages.txt (in a non-EyeLink experiment with "Save Messages" attribute of the Experiment node checked) when the action returns.
Time #	.time	Float	Display PC Time when the action is processed.
Start Time #	.startTime	Float	Display PC Time when record sound control action begins.
Clear Input Queues †	.clearInputQueues	Boolean	If true, all events from input queues are flushed when the action is started. This includes all Experiment Builder triggers, such as keyboard, mouse, TTL, and EyeLink inputs (button, saccade, fixation). This results in upcoming Triggers only firing based on events that are collected following the start of the Action. If false, the input queues are not cleared when the action is performed, meaning that any events already in the queues will be evaluated by Triggers following the action.
File Name	.fileName	String	Filename (.wav) for the audio clip.
Duration	.duration	Integer	Maximum duration for the sound recording.
Status	.status	Integer	Current status of the playsound action. 1 (recording yet to be started), -1 (recording in progress), -1000 (recording finished).
Position	.position	Integer	Position into recording (in milliseconds since the recording starts). Returns 0 before or after recording.
Record Start Time	.recordStartTime	Float	Display PC time when the audio recording starts. Returns 0 before or after recording.

A possible trial recording sequence involving audio recording would be:

- 1) Add a Record Sound action to open the recording file for the trial.
- 2) Present visual events with DISPLAY_SCREEN action. Add a Voice key trigger to the DISPLAY_SCREEN in addition to other trigger types.
- 3) Wait until timeout or a voicekey trigger event.
- 4) Blank the display immediately (or after a very short delay) to let the subject know their utterance has been detected.
- 5) Add a timer trigger so that recording can be continued for a short period (1000 ms?) to ensure the entire word has been recorded. If a long response is expected, you may want to continue checking the voicekey and end only after 1000 ms or so of silence.
- 6) Close the recording WAV file with the RECORD_SOUND_CONTROL action.

The following graph illustrates the above event sequence.

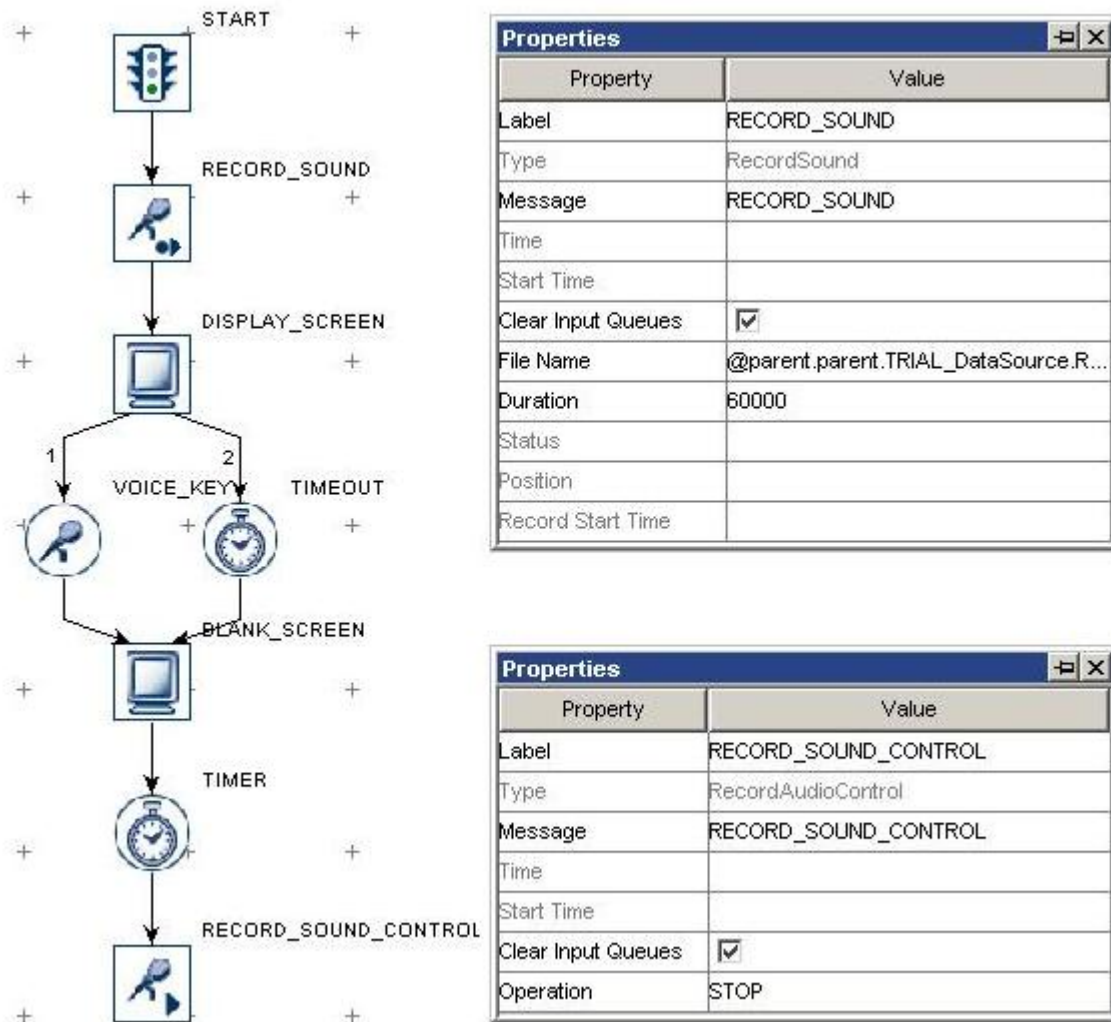



Figure 7-21. Using Record Sound Action.

7.9.16 Record Sound Control

Record Sound control action () stops, pauses, records, or aborts the current ASIO sound being recorded. This action is only supported when an ASIO-compatible sound card is installed on the display PC and the Audio Device is set to "ASIO".

Field	Attribute Reference	Type	Content
Label *	.label	String	Label of the Record Sound Control action. The default label is "RECORD_SOUND_CONTROL".
Type #	NR		The type of Experiment Builder objects ("RecordAudioControl") the current node belongs to.
Node Path	.absPath	String	The absolute path of the node in the experiment graph.
Message	.message	String	Message to be sent to EDF file (in an EyeLink [®] experiment.) or messages.txt (in a non-EyeLink experiment with " Save Messages" attribute of the Experiment node checked) when the action is done.
Time #	.time	Float	Display PC Time when the action is done.
Start Time #	.startTime	Float	Display PC Time when record sound control action begins.
Clear Input Queues †	.clearInputQueues	Boolean	If true, all events from input queues are flushed when the action is started. This includes all Experiment Builder triggers, such as keyboard, mouse, TTL, and EyeLink inputs (button, saccade, fixation). This results in upcoming Triggers only firing based on events that are collected following the start of the Action. If false, the input queues are not cleared when the action is performed, meaning that any events already in the queues will be evaluated by Triggers following the action.
Operation *	.operation	String	Action (STOP, PAUSE, PLAY, or ABORT) used to control the current audio recording. STOP: Stops the current audio recording, writes out the data stored in the record buffer to the .wav file; and frees the buffer. ABORT: Stops the current audio recording without saving the .wav file. PAUSE: Pauses the current audio recording. Recording may be continued by using the "RECORD" action. RECORD: Unpauses a paused recording.

The RECORD_SOUND_CONTROL action can only be applied after the

RECORD_SOUND action. For the usage of this action, please take a look at the Record Sound example.

7.9.17 Terminating an Experiment

The experiment ends when all iterations of sequences have been executed. The user can choose to terminate an experiment earlier by using the TERMINATE_EXPERIMENT action



Field	Attribute Reference	Type	Content
Label *	.label	String	Label of the TERMINATE_EXPERIMENT action. The default value is "TERMINATE_EXPERIMENT".
Type #	NR		The type of Experiment Builder objects ("TerminateExperiment") the current node belongs to.
Node Path	.absPath	String	The absolute path of the node in the experiment graph.
Message	.message	String	Message to be sent to EDF file (in an EyeLink© experiment.) or messages.txt (in a non-EyeLink experiment with " Save Messages" attribute of the Experiment node checked) when the TERMINATE_EXPERIMENT action is done.
Time #	.time	Float	Display PC Time when the TERMINATE_EXPERIMENT action is done.
Start Time #	.startTime	Float	Display PC Time when the action starts.
Clear Input Queues †	.clearInputQueues	Boolean	If true, all events from input queues are flushed when the action is started. This includes all Experiment Builder triggers, such as keyboard, mouse, TTL, and EyeLink inputs (button, saccade, fixation). This results in upcoming Triggers only firing based on events that are collected following the start of the Action. If false, the input queues are not cleared when the action is performed, meaning that any events already in the queues will be evaluated by Triggers following the action.

In the following example (Figure 7-22), an ERROR_COUNT variable is used to store the number of errors made in the experiment. When a target button is pressed, the ERROR_COUNT is updated. If the error count exceeds a pre-set number, the experiment can be terminated earlier by the TERMINATE_EXPERIMENT action.

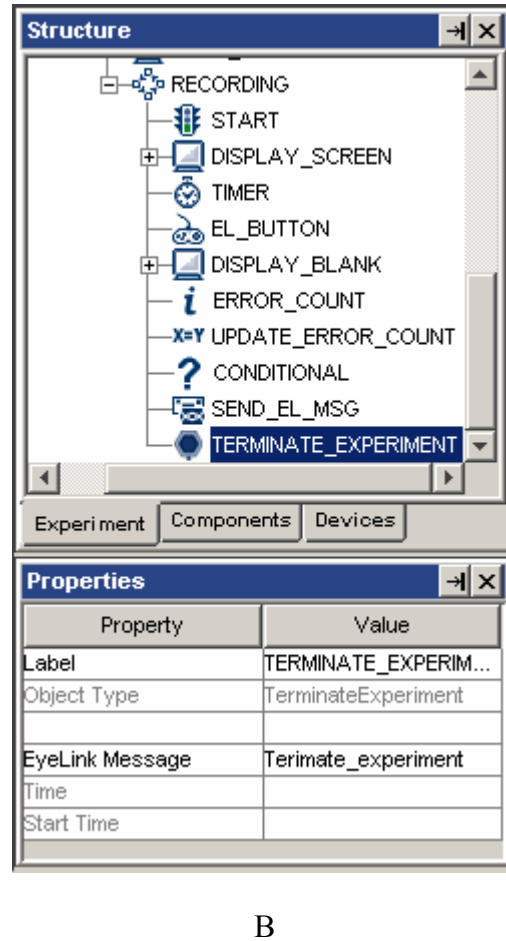
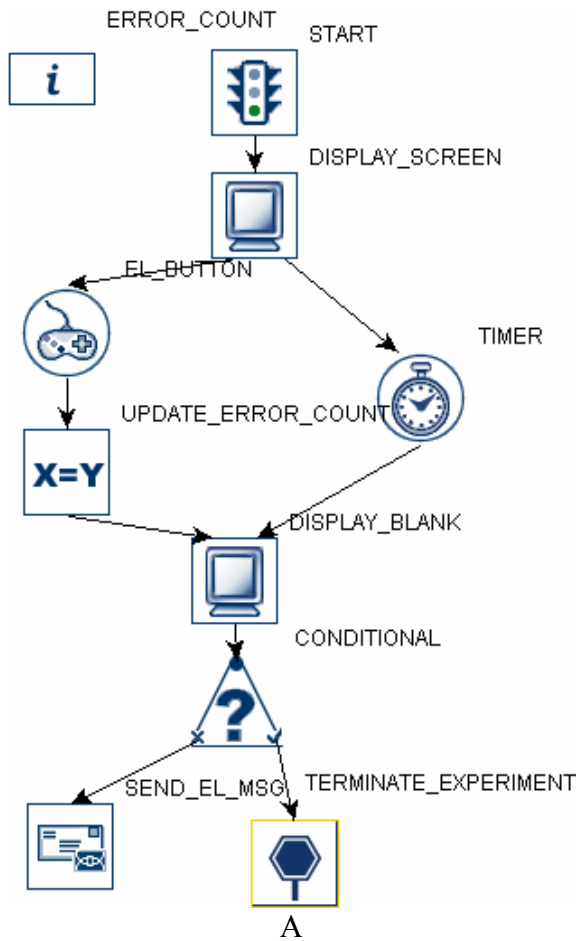

Figure 7-22. Using Terminate_Experiment Action

7.9.18 Recycle Data Line

Recycle Data Line action (🔄) instructs the experiment sequencer to perform the current data-source line at a later time. **Note:** If Recycle_DataLine action is used such that neither the containing sequence nor the parent(s) of the sequence has data source, a build-time error will be raised.

Field	Attribute Reference	Type	Content
Label *	.label	String	Label of the Recycle DataLine action. The default value is "RECYCLE_DATALINE".
Type #	NR		The type of Experiment Builder objects ("RecycleDataLine") the current node belongs to.
Node Path	.absPath	String	The absolute path of the node in the experiment graph.
Message	.message	String	Message to be sent to EDF file (in an EyeLink© experiment.) or messages.txt (in a non-EyeLink experiment with " Save Messages" attribute of

			the Experiment node checked) when the action is done.
Time #	.time	Float	Display PC Time when the action is done.
Start Time #	.startTime	Float	Display PC Time when this action starts.
Clear Input Queues †	.clearInputQueues	Boolean	If true, all events from input queues are flushed when the action is started. This includes all Experiment Builder triggers, such as keyboard, mouse, TTL, and EyeLink inputs (button, saccade, fixation). This results in upcoming Triggers only firing based on events that are collected following the start of the Action. If false, the input queues are not cleared when the action is performed, meaning that any events already in the queues will be evaluated by Triggers following the action.
Data Source #	NR	.	The data source from which the current trial data line will be repeated.
Recycling Mode *	.recyclingMode	String	Method of data-source line recycling. If set to "IMMEDIATE" (1), the same data-source line will be repeated in the next trial; if set to "RANDOM" (0), the data-source line will be repeated at a random point later; if set to "END" (2), the data-source line will be repeated at the end of the experiment.

Recycle Dataline action can be used to recycle a trial and rerun it at a later time. The following graph illustrates the case of recycling the trial if the subject press button 5. (Note a dummy action should be added to the false branch of the conditional trigger.)

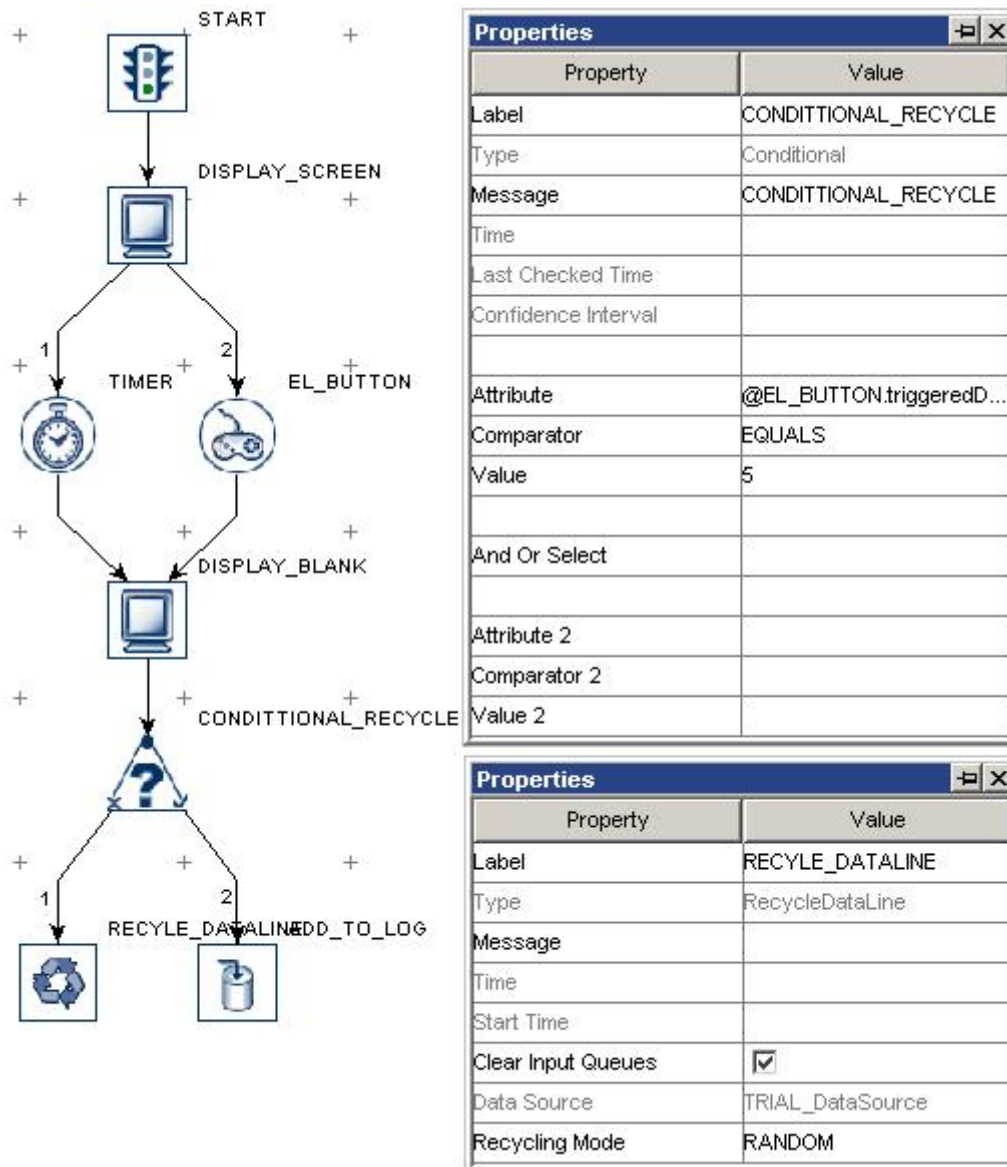

Figure 7-23. Using Recycle Dataline Action.

7.9.19 Execute Action

Execute action () is used to execute methods defined in custom class.

Field	Attribute Reference	Type	Content
Label *	.label	String	Label of the Execute action. The default label is "EXECUTE".
Type #	NR		The type of Experiment Builder objects ("Execute") the current node belongs to.
Node Path #	.absPath	String	Path of the node in the experiment graph.
Message	.message	String	Message to be sent to EDF file (in an EyeLink

			experiment.) or messages.txt (in a non-EyeLink experiment with " Save Messages" attribute of the Experiment node checked) when the action is done.
Time #	.time	Float	Display PC Time when the action is done.
Start Time #	.startTime	Float	Display PC Time when record sound control action begins.
Clear Input Queues †	.clearInputQueues	Boolean	If true, all events from input queues are flushed when the action is started. This includes all Experiment Builder triggers, such as keyboard, mouse, TTL, and EyeLink inputs (button, saccade, fixation). This results in upcoming Triggers only firing based on events that are collected following the start of the Action. If false, the input queues are not cleared when the action is performed, meaning that any events already in the queues will be evaluated by Triggers following the action.
Execute Method	NR		Method of a class to be executed. Click on right end of the value field to start the attribute editor to locate a method in a custom class instance. If a method in a custom code class is already linked to this field, double clicking on the execute action should bring up the custom code text editor and set the current editing position to the start of the method that the execute action was using.
Parameter(s)	NR		A list of parameters the execute method may take.
Result #	.result		Result of the execution method.
Result Data Type	# NR		Type of the data returned by the execute method.

7.9.20 Null Action

The Null action node () , as suggested by its name, does not perform any actual actions. It is primarily used for two reasons:

- a) Controlling experiment flow. For example, the linking rules do not allow for a direct connection between a sequence and triggers. A null action can be used as a dummy action in between, instead of using SEND_EL_MESSAGE action or ADD_TO_LOG action. The null action can also be attached to the unused branch of conditional trigger so that the experiment flow can continue.
- b) Clearing cached trigger data.

Field	Attribute Reference	Type	Content
Label *	.label	String	Label of the NULL_ACTION action. The

			default value is "NULL ACTION".
Type #	NR		The type of Experiment Builder objects ("NullAction") the current node belongs to.
Node Path	.absPath	String	The absolute path of the node in the experiment graph
Message	.message	String	Message to be sent to EDF file (in an EyeLink experiment.) or messages.txt (in a non-EyeLink experiment with " Save Messages" attribute of the Experiment node checked) when the action is executed.
Time #	.time	Float	Display PC Time when the action is done.
Start Time #	.startTime	Float	Display PC Time when the action starts.
Clear Input Queues #	.clearInputQueues	Boolean	If true, all events from input queues are flushed when the action is started. This includes all Experiment Builder triggers, such as keyboard, mouse, TTL, and EyeLink inputs button, saccade, fixation). This results in upcoming Triggers only firing based on events that are collected following the start of the Action. If false, the input queues are not cleared when the action is performed, meaning that any events already in the queues will be evaluated by Triggers following the action.

7.10 Triggers

Triggers are used to control the flow of actions within a sequence, such as the transition from one action to the other, or ending the sequence. SR Research Experiment Builder supports several kinds of triggers, including timer control, those from a device input (keyboard, mouse, TTL, Cedrus, voice key, and EyeLink© button box), those involving online eye data (invisible boundary, fixation, saccade, and sample velocity), and conditional evaluations. The following sections list the use of each trigger type. Triggers can be selected from the trigger tab of the component toolbox (Figure 7-24).



Figure 7-24. Triggers Implemented in Experiment Builder

7.10.1 Timer Trigger

Timer Trigger (🕒) fires when a pre-specified amount of time has elapsed since the trigger started. It can be used to introduce a delay between actions and/or triggers, and to control the maximum amount of time a sequence can last. The following table lists the properties of a timer trigger.

Field	Attribute Reference	Type	Content
-------	---------------------	------	---------

Label *	.label	String	Label of the Timer trigger. The default value is "TIMER".
Type #	NR		The type of Experiment Builder objects ("Timer") the current node belongs to.
Node Path	.absPath	String	The absolute path of the node in the experiment graph.
Message	.message	String	Message to be sent to EDF file (in an EyeLink© experiment.) or messages.txt (in a non-EyeLink experiment with "Save Messages" attribute of the Experiment node checked) when the timer trigger fires.
Time #	.time	Float	Display PC Time when the trigger fires.
Last Check Time #	.lastCheckedTime	Float	Experiment Builder checks for the status of the timer trigger about every 1 msec. This property can be used to retrieve the display PC Time when the trigger was checked for the last time.
Confidence Interval #	.confidenceInterval	Float	Time difference between the trigger time and last check time of the trigger. This indicates a window of uncertainty.
Duration	.duration	Integer	The maximum duration (4000 msec by default) of delay set in the trigger.
Duration Type ¶	.durationType	String	Unit of timer duration (either "msecs" or "frames").
Start Time	.startTime	Integer	Display PC time when the trigger starts. The default value is 0 – the timer starts from the previous action or trigger to which the timer is linked and resets if that action or trigger re-enters. If a different start time should be used for the trigger, the user should use the attribute reference functionality to set the start time.
Elapsed Time #	.elapsedTime	Integer	Amount of elapsed time (in milliseconds) since the timer starts.

By default, the start time of the timer trigger is set to "0", which means that the timer starts from the end time of the previous action. Therefore, if the timer is attached to a display screen, it doesn't start until the display screen's retrace starts. Similarly, if it is attached to a EyeLink Message action, the timer will start only after the message is sent. If the timer is connected from a trigger, the start time of the timer trigger will be the end of the previous action as well (not the time when the previous trigger fires).

The user need to explicitly set the 'start time' value of the TIMER trigger when the desired start time is the triggered time of the previous trigger, or when the action from which the timer trigger is connected may be repeated (see FAQ: "Using an EyeLink button trigger without ending the trial sequence" in the html version of this document).

The TIMER trigger uses a pre-release mechanism when it is connected to a DISPLAY SCREEN action or a PLAY SOUND action (when set to ASIO driver) to ensure that the upcoming audio/visual event will be presented on the predicted time. To make this

preleasing mechanism work, please do not insert any intervening trigger/actions between the TIMER trigger and the intended DISPLAY SCREEN or PLAY SOUND action. Therefore, a sequence like "DISPLAY A -> TIMER -> DISPLAY B -> UPDATE_ATTRIBUTE" is recommended for accurate timing while "DISPLAY A -> TIMER -> UPDATE_ATTRIBUTE -> DISPLAY B" is not.

The following illustrates the use of TIMER triggers to control the duration of display presentation and how long a sequence should be run. Imagine that the user wants to show display A for 500 milliseconds, then show display B for 500 milliseconds, and then display A for 500 milliseconds, and so on, while the whole sequence should end in 4000 milliseconds. The user may design the graph as following:

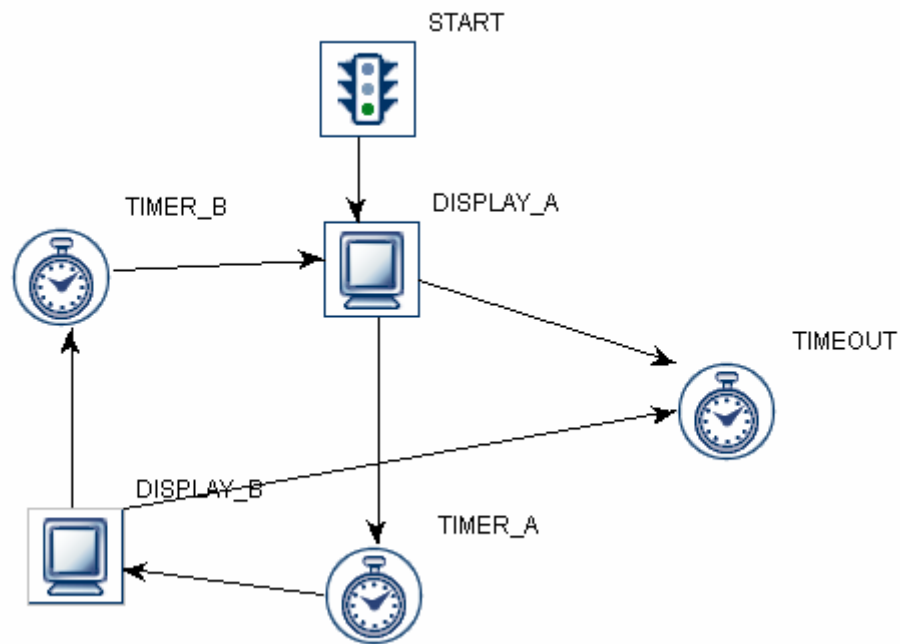

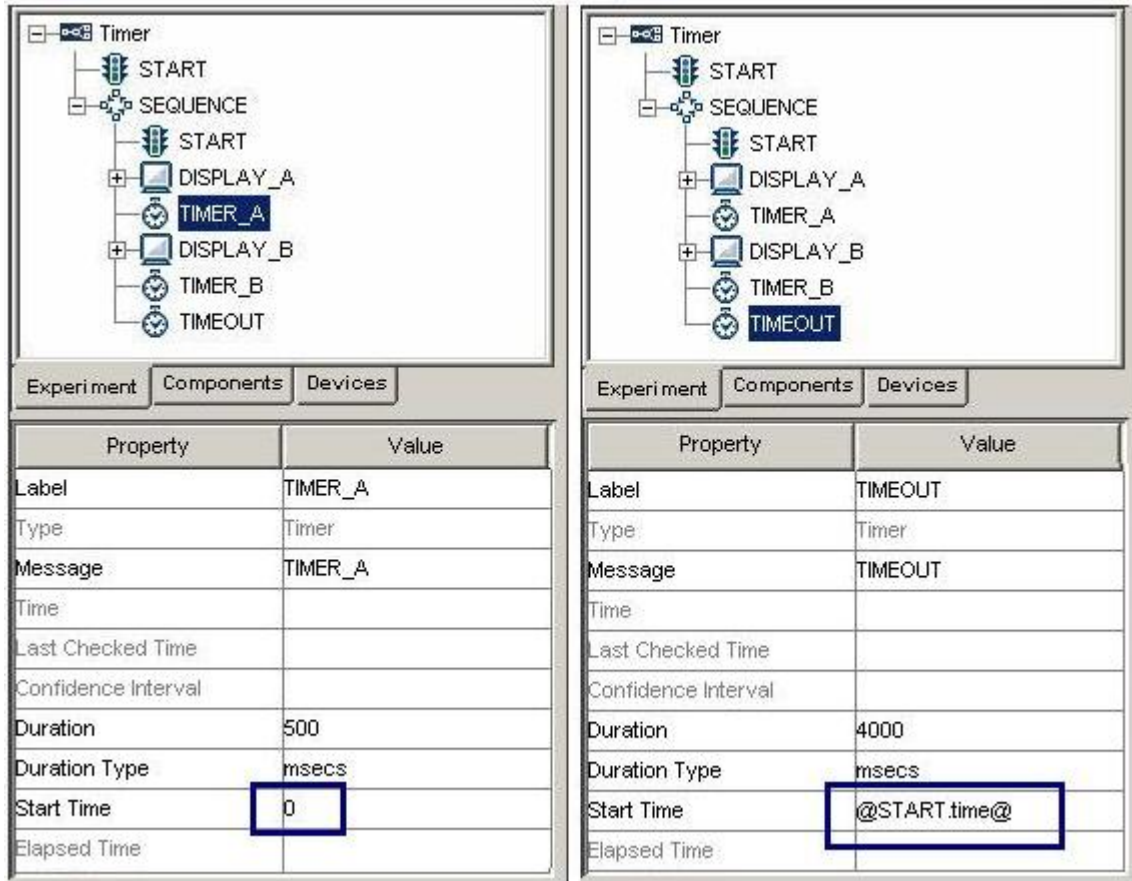

Figure 7-25. Using Timer Trigger

Note that the "Start Time" of TIMER_A and TIMER_B is set to 0, which means that the timers reset themselves when Display_A and Display_B actions are repeated. The Timer TIMEOUT controls the maximum duration to stay within the sequence and therefore its start time shouldn't be reset when either of the two display screen actions is repeated. The start time of this trigger is set to the start of the subgraph (@START.time@) instead.

7.10.2 Invisible Boundary Trigger

The EyeLink tracker provides two streams of: eye position samples (up to 2000 times per second for an EyeLink 1000/2K eye tracker) and events (eye-movement events such as saccades and fixations, blinks). The invisible boundary trigger fires when one or multiple eye samples stay inside or outside of a pre-specified invisible boundary. This trigger type can be used to implement all or part of display change based on the locus of gaze. For example, a line of text may be changed when the reader proceeds past a critical word in the sentence. This trigger is only available in an EyeLink experiment. Please note that the tracker heuristic filter setting influences how quickly the trigger will fire.

Field	Attribute Reference	Type	Content
Label *	.label	String	Label of the Invisible boundary trigger. The default value is "INVISIBLE_BOUNDARY".

Type #	NR		The type of Experiment Builder objects ("Boundary") the current node belongs to.
Node Path	.absPath	String	The absolute path of the node in the experiment graph.
Message	.message	String	Message to be sent to EDF file (in an EyeLink© experiment.) when the invisible boundary trigger fires.
Time #	.time	Float	Display PC Time when the trigger fires. Note: To check the time when the triggering sample occurs, you should use @*.triggeredData.time@ instead.
Last Check Time #	.lastCheckTime	Float	This property can be used to retrieve the display PC Time when the trigger was checked for the last time.
Confidence Interval #	.confidenceInterval	Float	Time difference between the trigger time and last check time of the trigger. This indicates a window of uncertainty as the trigger could actually occur between the last checked time and the actual firing time.
Region Type	.regionType	String	The type of triggering Region used: RECTANGLE (0), ELLIPSE (1), or INTEREST AREA (2). Note that the "INTEREST AREA" option is only available when interest areas are defined in one of the display screens in the same recording sequence.
Region Direction	.regionDirection	List of String	A range of eye angles from a multiple-selection list ['0 - 45', '45 - 90', '90 - 135', '135 - 180', '-180 - -135', '-135 - -90', '-90 - -45', '-45 - 0'] used to restrict the direction in which the invisible boundary trigger fires. For each angle range, the first value is inclusive and the second value is not inclusive.
Region Location (Top Left)	.regionLocation	Point	Pixel coordinate of the top-left corner of the boundary region in (x, y) tuple. The default value is (0.00, 0.00). Note that the x, y coordinate of the region location can be further referred as .regionLocation.x and .regionLocation.y respectively. Note that this property is only available when the "Region Type" property is set to either RECTANGLE or ELLIPSE.
Region Width	.regionWidth	Integer	Width (0 by default) of the boundary region in screen pixels. Note that this property is only available when the "Region Type" property is set to either RECTANGLE or ELLIPSE.
Region Height	.regionHeight	Integer	Height (0 by default) of the boundary region in screen pixels. Note that this property is only available when the "Region Type" property is set to either RECTANGLE or ELLIPSE.
Interest Area	NR .	.	The display screen on which target interest area

Screen *			regions are located. Note that this property is only available when the "Region Type" property is set to INTEREST AREA.
Interest Area Regions	NR	.	Target interest areas used to define the triggering region. Note that this property is only available when the "Region Type" property is set to INTEREST AREA.
Within †	.within	Boolean	If set to "True" (default), the trigger should fire when samples are within the boundary region; otherwise, the trigger fires when samples are outside of the prespecified region.
Tracking Eye ¶	.trackingEye	Integer	Decides which eye's data is used for online parsing. The default value is "EITHER" (2). It can also be LEFT (0) or RIGHT (1).
Minimum Duration	.minimumDuration	Integer	Duration (in milliseconds) in or out of the region before the trigger fires. If the default value 0 is used, the trigger fires immediately after detecting a sample inside (or outside) of the boundary. Changes from version 1.4.202: The "Sample Count" property has been removed and replaced with the "Minimum Duration" property.
Triggered Data #	.triggeredData		If the boundary trigger fires, the triggered data can be further accessed (see the following table)

If the Invisible Boundary Trigger fires, the user can further check the triggered data. The sub-attributes of the TriggeredData attribute are listed in the following table. They can be used for attribute references.

Attribute	Reference	Type	Content
Time	.time	Integer	Display PC time when the triggering sample occurs.
EDF Time	.EDFTime	Integer	EDF time of the triggering sample.
Eyes Available	.eyesAvailable	Integer	Eyes available in recording (0 for left eye; 1 for right eye; 2 for both eyes).
Start Time	.startTime	Float	Display PC time when the first sample appears in the region.
EDF Start Time	.EDFStartTime	Integer	EDF time (time since the EyeLink program started on the host PC) when the first sample occurs in the region.
Triggered Eye	.triggeredEye	Integer	Eye (0 for left eye; 1 for right eye) whose data makes the current invisible boundary trigger fire.
PPD X, PPD Y	.PPDX, .PPDY	Float	Angular resolution at the current gaze position (in screen pixels per visual degree) along the x-, or y-axis
Left Gaze X,	.leftGazeX, .right	Float	Gaze position of the triggering sample along the

Right Gaze X, Average Gaze X	GazeX, .average GazeX ¹		x-axis for the left eye, right eye and an average between the two.
Left Gaze Y, Right Gaze Y, Average Gaze Y	.leftGazeY, .right GazeY, .average GazeY ¹	Float	Gaze position of the triggering sample along the y-axis for the left eye, right eye and an average between the two.
Left Pupil Size, Right Pupil Size, Average Pupil Size	.leftPupilSize, .ri ghtPupilSize, .averagePupilSize ¹	Float	Left eye, right eye, or average pupil size (in arbitrary units, area or diameter as selected in the EyeLink© device settings)
Left Velocity, Right Velocity, Average Velocity	.leftVelocity, .rightVelocity, .averageVelocity ¹	Float	Left eye, right eye, or average sample velocity (in degrees /second) ²
Left Acceleration, Right Acceleration, Average Acceleration	.leftAcceleration, .rightAcceleratio n, .averageAccelerat ion ¹	Float	Left eye, right eye, or average sample acceleration (in degrees /second ²) ²
Angle	.angle	Float	The angle of the eye movements when the trigger fires.
Target Distance	.targetDistance	Integer	Distance between the target and camera (10 times the measurement in millimeters). This option is for EyeLink Remote eye tracker only. Returns "MISSING_DATA" (-32768) if target is missing or if running a non-Remote eye tracker.
Target X, Target Y	.targetX, .targetY	Integer	X, Y position of the target in camera coordinate. This option is for EyeLink Remote eye tracker only. Returns "MISSING_DATA" (-32768) if target is missing or if running a non-Remote eye tracker.
Target Flags	.targetFlags	Integer	Flags used to indicate target tracking status (0 if target tracking is ok; otherwise error code). This option is for EyeLink Remote eye tracker only. Returns "MISSING_DATA" (-32768) if running a non-Remote eye tracker.

Note:

¹ Returns "MISSING_DATA" (-32768) for the untracked eye.

² For EyeLink I and II, the velocity and acceleration of the 2nd sample before the triggering sample are reported. For EyeLink 1000, the reported velocity and acceleration values belong to the nth sample (n = 2, 4 or 8, respectively, if a 5-, 9-, or 17- sample velocity/acceleration model is used) before the triggering sample.

The Invisible Boundary Trigger can be used to check whether the participant's gaze position crosses a specified region and therefore is useful for experiments involving the boundary paradigm. To make this trigger useful, the user needs to specify a triggering location. For example, if the user wants to change a display when the participant's left-

eye gaze position has been in a rectangular region (100, 384, 250, 818), the recording sequence can be programmed as the following (see Figure 7-26):

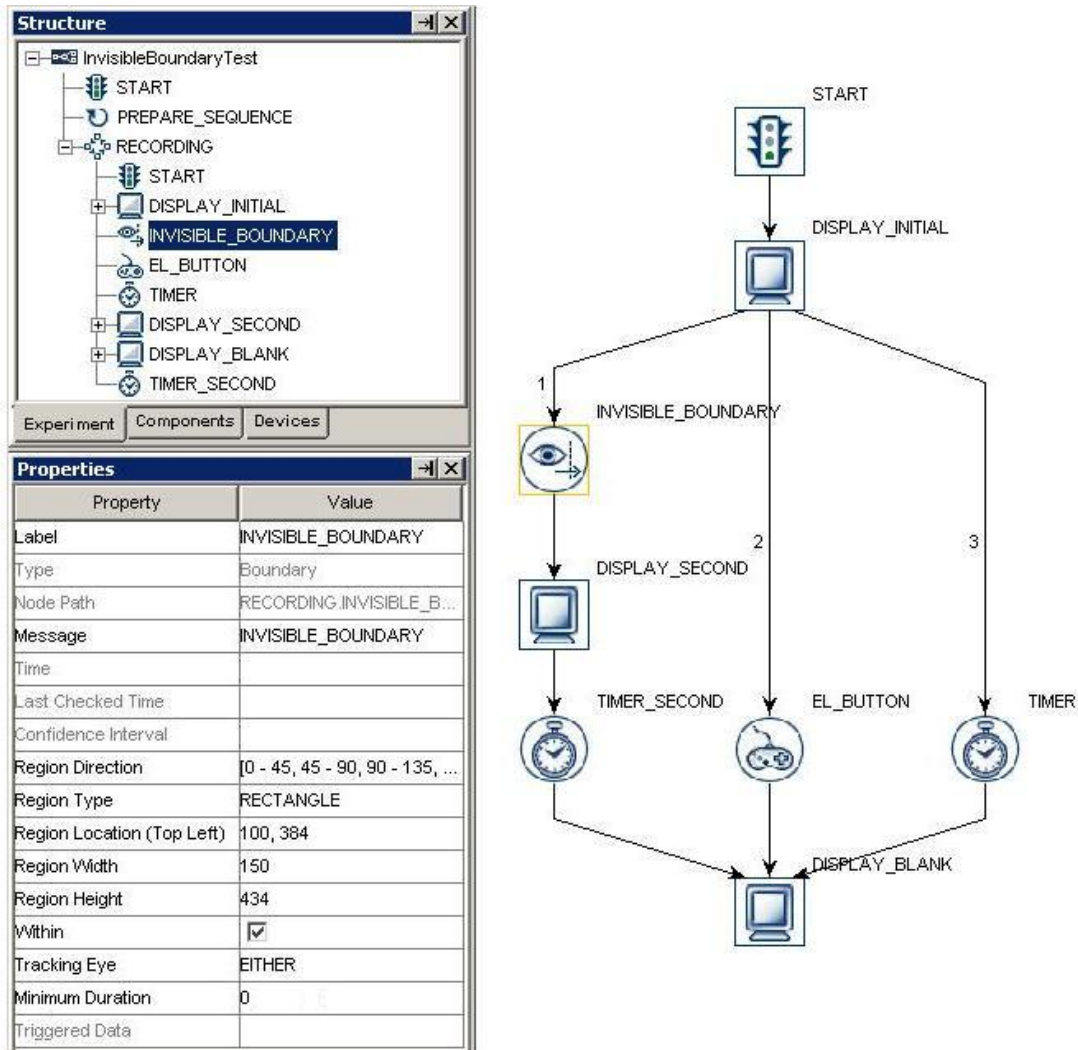

Figure 7-26. Using Invisible Boundary Trigger

Please note that the location type of all trigger types (invisible boundary triggers, mouse trigger, fixation trigger, saccade trigger, and sample velocity trigger) is top-left based whereas the screen resources can be either top-left based or center based. This means that references should be created differently depending on whether the region location of a trigger refers to a center-based resource or a top-left based screen resource. Imagine that an invisible boundary trigger should fire when the eye is within a rectangle resource (RECTANGLE_RESOURCE). The top-panel of the figure below illustrates creating the Region Location reference when the RECTANGLE_RESOURCE is top-left based (@DISPLAY_SCREEN.RECTANGLE_RESOURCE.location@). The bottom panel of the figure illustrates creating a location equation when the location type is center based (=EBPoint(@DISPLAY_SCREEN.RECTANGLE_RESOURCE.location.x@ - @DISPLAY_SCREEN.RECTANGLE_RESOURCE.width@/2,

@DISPLAY_SCREEN.RECTANGLE_RESOURCE.location.y@ -
 @DISPLAY_SCREEN.RECTANGLE_RESOURCE.height@/2)).

Property	Value
Label	INVISIBLE_BOUNDARY
Type	Boundary
Node Path	BLOCK.TRIAL.RECORDING.INVISIBLE_BOUNDARY
Message	
Time	
Last Checked Time	
Confidence Interval	
Region Direction	[0 - 45, 45 - 90, 90 - 135, 135 - 180, -180 - -135, -135 - ...
Region Type	RECTANGLE
Region Location (Top Left)	@DISPLAY_SCREEN.RECTANGLE_RESOURCE.location@
Region Width	@DISPLAY_SCREEN.RECTANGLE_RESOURCE.width@
Region Height	@DISPLAY_SCREEN.RECTANGLE_RESOURCE.height@
Within	<input checked="" type="checkbox"/>
Tracking Eye	EITHER
Minimum Duration	0
Triggered Data	

Property	Value
Label	RECTANGLE_RESOURCE
Type	RectangleResource
Visible	<input checked="" type="checkbox"/>
Screen Index	
Position is Gaze Contingent	<input type="checkbox"/>
Position is Mouse Contingent	<input type="checkbox"/>
Offset	0, 0
Host Outline Color	White
Screen Location Type	TopLeft
Location	0, 0
Width	429
Height	264
Movement Pattern	None
Prebuild To Image	<input checked="" type="checkbox"/>

Property	Value
Label	INVISIBLE_BOUNDARY
Type	Boundary
Node Path	BLOCK.TRIAL.RECORDING.INVISIBLE_BOUNDARY
Message	
Time	
Last Checked Time	
Confidence Interval	
Region Direction	[0 - 45, 45 - 90, 90 - 135, 135 - 180, -180 - -135, -135 - ...
Region Type	RECTANGLE
Region Location (Top Left)	=EBPoint(@DISPLAY_SCREEN.RECTANGLE_RESOURCE.location.x@ - @DISPLAY_SCREEN.RECTANGLE_RESOURCE.width@/2, @DISPLAY_SCREEN.RECTANGLE_RESOURCE.location.y@ - @DISPLAY_SCREEN.RECTANGLE_RESOURCE.height@/2)
Region Width	@DISPLAY_SCREEN.RECTANGLE_RESOURCE.width@
Region Height	@DISPLAY_SCREEN.RECTANGLE_RESOURCE.height@
Within	<input checked="" type="checkbox"/>
Tracking Eye	EITHER
Minimum Duration	0
Triggered Data	

Property	Value
Label	RECTANGLE_RESOURCE
Type	RectangleResource
Visible	<input checked="" type="checkbox"/>
Screen Index	
Position is Gaze Contingent	<input type="checkbox"/>
Position is Mouse Contingent	<input type="checkbox"/>
Offset	0, 0
Host Outline Color	White
Screen Location Type	Center
Location	214, 132
Width	429
Height	264
Movement Pattern	None
Prebuild To Image	<input checked="" type="checkbox"/>

Please note that the “Link Filter Level” in the Devices → EyeLink© settings may influence how quickly a sample is received by the Experiment Builder software. The filter used by EyeLink© system is essentially a data smoothing/averaging process. When the filter is turned off, the data (sample N) is sent to the Ethernet cable or analog card immediately after it arrives. The delay therefore will be 3 ms for a 500 Hz recording and 6 ms for a 250 Hz recording. When the filter is set to "standard", to report data of sample N, the tracker waits for one extra sample (N+1). When the data of sample N+1 arrives, the tracker sends processed data (based on samples N-1, N, and N+1) as the true value of sample N. As a result, there will be extra 2 or 4 msec delay in reporting the data of sample N. Similarly, when the filter level is set to "Extra", the tracker waits for two extra

samples (N+1, N+2) before reporting the data of sample N. When the data of sample N+2 arrives, the tracker sends the processed data (samples N-2, N-1, N, N+1, and N+2) as the true value of sample N. The delay in this case will be 4 or 8 milliseconds extra as we have waited for two more samples. If the user wants to make the invisible boundary trigger and sample velocity trigger fire as quickly as possible, the “Link Filter Level” may be set as “OFF”.

Since the invisible boundary trigger keeps monitoring the online recording data, this trigger type must be placed within a recording sequence (i.e., the “Record” property of the sequence is checked). If you see a “This node type cannot be added to this sequence” build-time warning message, please check whether the sequence to which the trigger belongs is a recording sequence.

7.10.3 Conditional Trigger

Conditional trigger fires  when one or two condition evaluations are met. This is useful to implement conditional branching in a sequence when several conditions are possible (see the SACCADE example). In each condition evaluation, the user needs to specify attribute (the variable to be evaluated), comparator (comparison operations such as equal, less than, greater than, etc), as well as the target value being compared to. Two condition evaluations, connected with an “and” or “or” logical operator, can be made within the same trigger.

Field	Attribute Reference	Type	Content
Label *	.label	String	Label of the conditional trigger. The default value is “CONDITIONAL”.
Type #	NR		The type of Experiment Builder objects (“Conditional”) the current node belongs to.
Node Path #	.absPath	String	The absolute path of the node in the experiment graph.
Message	.message	String	Message to be sent to EDF file (in an EyeLink© experiment.) or messages.txt (in a non-EyeLink experiment with “Save Messages” attribute of the Experiment node checked) when the conditional trigger fires.
Time #	.time	Float	Display PC Time when the trigger fires
Last Check Time #	.lastCheckTime	Float	This property can be used to retrieve the display PC Time when the trigger was checked for the last time.
Confidence Interval #	.confidenceInterval	Float	Time difference between the trigger time and last check time of the trigger. This indicates a window of uncertainty.
Attribute, Attribute 2	.attribute, .attribute2		The attribute whose value needs to be evaluated.
Comparator, ¶* Comparator 2 ¶*	.comparator, .comparator2	String	Dropdown list used to select possible comparison between the variable and value. Possible values: “EQUALS” (default value),

			“GREATER THAN”, “LESS THAN OR EQUALS”, “CONTAINS”, “NOT EQUALS”, “LESS THAN”, or “GREATER THAN OR EQUAL”
Value, Value 2	.value, .value2		The value used to evaluate one attribute. The data type of this field depends on the attribute used.
And Or Select ¶*	.andOrSelect	String	Connection between multiple conditional evaluations. Possible values are: “AND”, “OR”, “AND NOT”, or “OR NOT”.

In the previous example (section 7.5.2), the user may want to further check whether the velocity and acceleration of the triggering sample in the invisible boundary trigger exceeds a set of target values. The following figure illustrates the use of conditional trigger to check out these parsing criteria. The “Attribute” field of the trigger is set as “@INVISIBLE_BOUNDARY.triggeredData.leftVelocity@” and the “Attribute 2” field of the trigger is set as “@INVISIBLE_BOUNDARY.triggeredData.leftAcceleration@”.

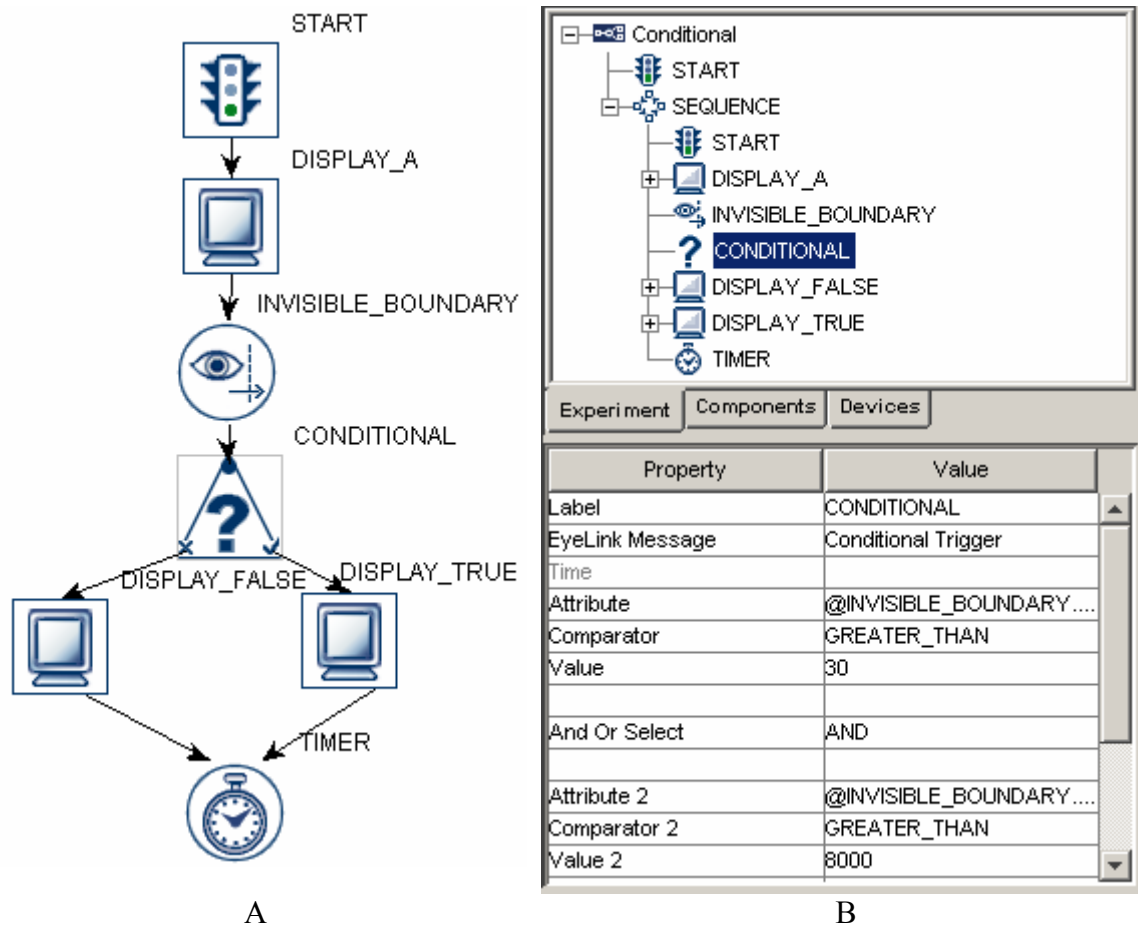

Figure 7-27. Using Conditional Trigger

When performing a conditional evaluation, the user must make sure that the data type of the “value” field must match that of the “attribute” field (ditto for “Value 2” and

“Attribute 2”). The data types supported in current implementation of conditional triggers are string, integer, double, and Boolean.

- When comparing strings, please make sure that the strings are case-sensitive (without quotes, see the “Saccade” template for the implementation of conditional evaluations with strings).
- In case of evaluating a Boolean comparison (for example checking whether the “Force Full Redraw” field of a DISPLAY_SCREEN action is checked or not), the user needs to set the “Attribute” field of the conditional trigger by referring to the target attribute (e.g., @DISPLAY_A.forceFullRedraw@), choose either “EQUALS” or “NOT EQUALS” as the comparator, and type in “true” or “false” (lower case without quotes) in the value field of the conditional trigger.
- Sometimes, the user may attempt to evaluate attributes against missing values. For example, the user may want to check whether a trigger has fired or whether a valid data has been retrieved from one attribute (e.g., the start time of an action). If the target attribute is a string type, set the “value” field of the conditional trigger to “MISSING_DATA”. If the target attribute is an integer or a float data, set the comparison value to “-32768”.
- To clear a non-string value (eg. 3) set in the "value" or "value2" attributes of a conditional trigger, you may first set the value to some string (e.g., "hello") and then clear it.

Please note that the conditional triggers can connect to a maximum of two actions or triggers (forming two branches). To make the conditional trigger valid, the user should attach triggers or actions to at least one of branches. If the firing of the conditional trigger exits the current sequence, the user needs to attach a blank display screen action or a timer following this trigger. As an exception to the general linking rules (#8, Section 6.2.3 “Linking Rules”), the user is allowed to connect from a conditional trigger to an action and a trigger at the same time.

Please note that the conditional triggers can connect to a maximum of two actions or triggers (forming two branches). To make the conditional trigger valid, the user should attach triggers or actions to at least one of branches. If the firing of the conditional trigger exits the current sequence, the user may attach a blank display screen action or a timer following this trigger. As an exception to the general linking rules (#8), the user is allowed to connect from a conditional trigger to an action and a trigger at the same time.

IMPORTANT: If a Conditional trigger does not have a connection from its TRUE or FALSE port, then the port that does not have a connection is NOT evaluated. For example, if a Conditional trigger has a connection from its TRUE port and no connection from its FALSE port, then the trigger will only fire if the conditional evaluates to TRUE and nothing will be done if the conditional evaluates to FALSE.

7.10.4 EyeLink© Button Trigger

The EyeLink© button trigger () , available only in an EyeLink© experiment, fires when one of the pre-specified EyeLink button box buttons is pressed. To set up this trigger type, the user needs to specify a list of candidate buttons.

Field	Attribute Reference	Type	Content
Label *	.label	String	Label of the EyeLink© button trigger. The default value is "EL_BUTTON".
Type #	NR		The type of Experiment Builder objects ("EyeLinkButton") the current node belongs to.
Node Path #	.absPath	String	The absolute path of the node in the experiment graph.
Message	.message	String	Message to be sent to EDF file (in an EyeLink© experiment.) when the EyeLink button trigger fires.
Time #	.time	Float	Display PC Time when the trigger fires. Note: To check the time when the button was pressed/released, you should use <code>@*.triggeredData.time@</code> instead.
Last Check Time #	.lastCheckTime	Float	This property can be used to retrieve the display PC Time when the trigger was checked for the last time.
Confidence Interval #	.confidenceInterval	Float	Time difference between the trigger time and last check time of the trigger. This indicates a window of uncertainty as the true trigger time could be between the last check time (.lastCheckTime) and the reported the trigger time (.time)
Clear Input Queue	.clearInputQueue	Boolean	EyeLink button trigger maintains an event queue so that multiple button events can be accessed over time. The current option checks whether the button event(s) cached in the event queue should be cleared when the trigger fires (NO: no event clearing; Event: removes the current triggering event from the button event queue; LIST: all button events from event queue will be removed).
Triggered Data #	.triggeredData		Data of the triggered button event (see the following table)
Buttons	.buttons	List of integers	List of buttons that may be pressed/released to fire the trigger. Default value is [1, 2, 3, 4, 5, 6,7]. Note: To check which button is actually pressed or released, use <code>@*.triggeredData.button@</code> (i.e., the .button sub-attribute of the .triggeredData attribute) instead.
Press Events †	.pressEvents	Boolean	Whether the trigger should fire when a button press event occurs. This is set to "True" (box checked) by default.

Release Events †	.releaseEvents	Boolean	Whether the trigger should fire when a button release event occurs. This is set to "False" (box unchecked) by default.
------------------	----------------	---------	--

To specify a list of button(s) used for response, click on the value field of the "Buttons" property and select the desired buttons. Multiple buttons can be selected or unselected by holding down the "CTRL" key. The buttons can also be set via attribute reference by double clicking on the right end of the "Buttons" value field.

When the button trigger fires, the triggered data can be further accessed. The sub-attributes of the TriggeredData field are listed in the following table.

Attribute	Reference	Type	Content
Time	.time	Integer	Display PC time when the button is pressed
EDF Time	.EDFTime	Integer	EDF time when the button is pressed
State	.state	Boolean	Whether button is pressed (True) or released (False) when the trigger fires.
Button	.button	Integer	The ID of the pressed button that fires the trigger

For example, if the user wants to end the trial by pressing button 1 and 4, the properties of the button trigger can be set as (see Figure 7-28):

The screenshot shows the 'Structure' panel on the left with a tree view containing: ButtonTest, START, RECORDING, START, DISPLAY_SCREEN, EL_BUTTON (highlighted), and TIMER. Below it are tabs for 'Experiment', 'Components', and 'Devices'. The 'Properties' panel on the right shows the following table:

Property	Value
Label	EL_BUTTON
Type	EyeLinkButton
Message	
Time	
Last Checked Time	
Confidence Interval	
Triggered Data	
Buttons	[1, 2, 3, 4, 5, 6, 7]
Press Events	<input checked="" type="checkbox"/>
Release Events	<input type="checkbox"/>

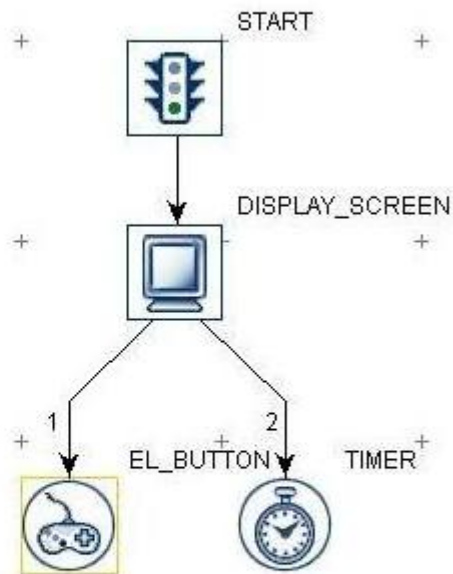



Figure 7-28. Using EyeLink© Button Trigger

7.10.5 Cedrus© Button Trigger

The Cedrus© button trigger () fires when one of the pre-specified buttons on a Cedrus RB Series response pad is pressed or released (please note that only RB-730 Model <http://www.cedrus.com/responsepads/rb730.htm> has been tested so far). To use the Cedrus button box, please follow the installation instruction provided by Cedrus (http://www.cedrus.com/support/rb_series) to install the USB driver to the display PC. In addition, the user should also check the setting of the DIP switches, which are located on the back of the response pads, to the left of where the USB cable plugs into the pad. Experiment Builder requires all the switches be in the down (On) position.

The Cedrus input trigger can also be used to detect Cedrus SV-1 Voice Key responses. The onset of a Voice Key trigger is represented as a button 1 down event; the offset of the voice key event is represented as a button 1 up event. Please follow <https://www.sr-support.com/forums/showthread.php?t=56> for setup and example. Please note that only ONE Cedrus device can be connected to the experiment PC at a time.

IMPORTANT: This trigger does not function in real-time sequences on some operating systems.

Field	Attribute Reference	Type	Content
Label *	.label	String	Label of the Cedrus button trigger. The default value is "CEDRUS_INPUT".
Type #	NR		The type of Experiment Builder objects ("CedrusInput") the current node belongs to.
Node Path #	.absPath	String	The absolute path of the node in the experiment graph.
Message	.message	String	Message to be sent to EDF file (in an EyeLink© experiment.) or messages.txt (in a non-EyeLink experiment with "Save Messages" attribute of the Experiment node checked) when the cedrus input trigger fires.
Time #	.time	Float	Display PC Time when the trigger fires. Note: To check the time when the Cedrus input was received, you should use <code>@*.triggeredData.time@</code> instead.
Last Check Time #	.lastCheckTime	Float	This property can be used to retrieve the display PC Time when the trigger was checked for the last time.
Confidence Interval #	.confidenceInterval	Float	Time difference between the trigger time and last check time of the trigger. This indicates a window of uncertainty as the true trigger time could be between the last check time (.lastCheckTime) and the reported the trigger time (.time)
Clear Input Queue	.clearInputQueue	Boolean	Cedrus Input trigger maintains an event queue so that multiple Cedrus input events can be accessed over time. The current

			option checks whether the Cedrus event(s) cached in the event queue should be cleared when the trigger fires (NO: no event clearing; Event: removes the current triggering event from the Cedrus event queue; LIST: all Cedrus events from event queue will be removed).
Triggered Data #	.triggeredData		Data of the triggered button event (see the following table)
Press Events †	.pressEvents	Boolean	Whether the trigger should fire when a button press event occurs. This is set to “True” (box checked) by default.
Release Events †	.releaseEvents	Boolean	Whether the trigger should fire when a button release event occurs. This is set to “True” by default.
Buttons	.buttons	List of integers	List of buttons that may be pressed/released to fire the trigger. Default value is [1, 2, 3, 4, 5, 6, 7, 8].

To set the button(s) used for response, click on the value field of the “Buttons” property and select the desired buttons. Multiple buttons can be selected or unselected by holding down the “CTRL” key. The buttons can also be set via attribute reference by double clicking on the right end of the “Buttons” value field.

When the Cedrus input trigger fires, the triggered data can be further accessed. The attributes of the TriggeredData attribute are listed in the following table.

Attribute	Reference	Type	Content
Time	.time	Integer	Display PC time when the button is pressed
EDF Time	.EDFTime	Integer	EDF time when the button is pressed
Button	.button	Integer	The ID of the pressed button that fires the trigger
Pressed	.pressed	Integer	Whether the triggering button is pressed (1) or released (0)

For example, if the user wants to end the trial by pressing button 1 and 4, the properties of the button trigger can be set as (see Figure 7-29):

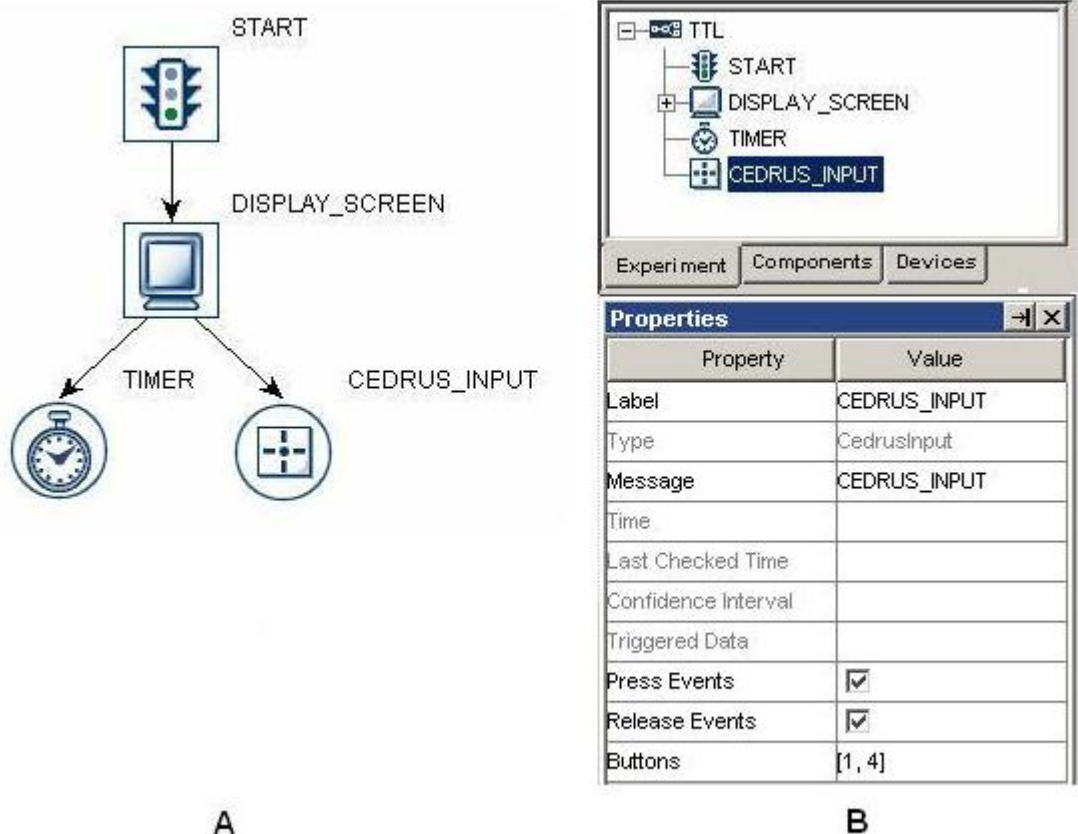

Figure 7-29. Using EyeLink© Button Trigger

7.10.6 Keyboard Trigger

The Keyboard trigger (🖱️) responds to an input from the display PC. The user needs to specify a list of possible key presses on the keyboard so that the trigger will fire. To set the key(s) used for response, click on the value field of the “Keys” property and select the desired keys. Multiple keys can be selected or unselected by holding down the “CTRL” key.

IMPORTANT: Please note that the user should not use the keyboard for collecting response in reaction-time sections of experiments, as the delays introduced by Windows are highly variable. This trigger does not function in real-time sequences on some operating systems.

Field	Attribute Reference	Type	Content
Label *	.label	String	Label of the keyboard trigger. The default label is “KEYBOARD”.
Type #	NR		The type of Experiment Builder objects (“Keyboard”) the current node belongs to.
Node Path #	.absPath	Strin	The absolute path of the node in the

			experiment graph.
Message	.message	String	Message to be sent to EDF file (in an EyeLink© experiment.) or messages.txt (in a non-EyeLink experiment with "Save Messages" attribute of the Experiment node checked) when the keyboard trigger fires.
Time #	.time	Float	Display PC Time when the trigger fires. Note: To check the time when the key was pressed, you should use @*.triggeredData.time@ instead.
Last Check Time #	.lastCheckTime	Float	This property can be used to retrieve the display PC Time when the trigger was checked for the last time.
Confidence Interval #	.confidenceInterval	Float	Time difference between the trigger time and last check time of the trigger. This indicates a window of uncertainty as the true trigger time could be between the last check time (.lastCheckTime) and the reported the trigger time (.time)
Clear Input Queue	.clearInputQueue	Boolean	Keyboard trigger maintains an event queue so that multiple key press events can be accessed over time. The current option checks whether the keyboard event(s) cached in the event queue should be cleared when the trigger fires (NO: no event clearing; Event: removes the current triggering event from the keyboard event queue; LIST: all key press events from event queue will be removed).
Keys # ‡	.keys	List of Strings	Keys allowed for the trigger firing. Use the drop down list to select target keys. In the attribute editor, the user should specify a list of keycode (the internal numeric identifier for a key on a keyboard).
Use Keyboard *	.useKeyboard	String	Specifies the keyboard (Display PC, Tracker PC, or Either) used for response
Triggered Data #	.triggeredData		If the keyboard trigger fires, the triggered data can be further accessed (see the following table).

‡ The supported named keys in attribute editor are:

Any, Backspace, Tab, Clear, Enter, Pause, Escape, Space, Exclaim, Quotedbl, Hash, Dollar, Ampersand, Quote, Leftparen, Rightparen, Asterisk, Plus, Comma, Minus, Period, Slash, 0, 1, 2, 3, 4, 5, 6, 7, 8, 9, Colon, Semicolon, Less, Equals, Greater, Question, At, Leftbracket, Backslash, Rightbracket, Caret, Underscore, Backquote, a, b, c, d, e, f, g, h, i, j, k, l, m, n, o, p, q, r, s, t, u, v, w, x, y, z, Delete, NumPad-0, NumPad-1, NumPad-2, NumPad-3, NumPad-4, NumPad-5, NumPad-6, NumPad-7, NumPad-8, NumPad-9, NumPad-Period, NumPad-Divide, NumPad-Multiply, NumPad-Minux, NumPad-Plus, NumPad-Enter, NumPad-Equals, Up, Down, Right, Left, Insert, Home, End, Pageup, Pagedown, F1, F2, F3,

F4, F5, F6, F7, F8, F9, F10, F11, F12, F13, F14, F15, Numlock, Capslock, Scrolllock, Rshift, Lshift, Rctrl, Lctrl, Ralt, Lalt, Rmeta, Lmeta, Lsuper, Rsuper, Mode, Compose, Help, Print, Sysreq, Break, Menu, Power, Euro, Undo.

When a keyboard trigger fires, the user can further access the triggered data. The sub-attributes of the TriggeredData for a keyboard trigger are listed in the following table.

Attribute	Reference	Type	Content
Keyboard	.keyboard	String	Keyboard (Display PC, Tracker PC, or Either) on which the triggering key is pressed.
Key	.key	String	The key pressed that fired the trigger.
Key Code	.keycode	Integer	The numeric code for the key pressed
Unicode Key	.unicodeKey	Integer	Returns the Unicode key for the key(s) pressed. A MISSING_DATA will be returned if the system cannot translate the key sequence to a character
Modifier	.modifier	Integer	A bit field enumeration for one or multiple modifier keys (Shift, CTRL, and ALT) pressed.
Is Shift Pressed	.isShiftPressed	Boolean	Whether one of the SHIFT keys is pressed.
Is CTRL Pressed	.isCtrlPressed	Boolean	Whether one of the CTRL keys is pressed.
Is ALT Pressed	.isAltPressed	Boolean	Whether one of the ALT keys is pressed.
EDF Time	.EDFTime	Integer	EDF time of the triggering key press
Time	.time	Integer	Display PC time when the triggering key is pressed

It is pretty ease to use a keyboard trigger. For example, if the user wants to press the “ENTER” or “SPACEBAR” to end the trial, the properties of the keyboard trigger can be set as shown in the following figure.

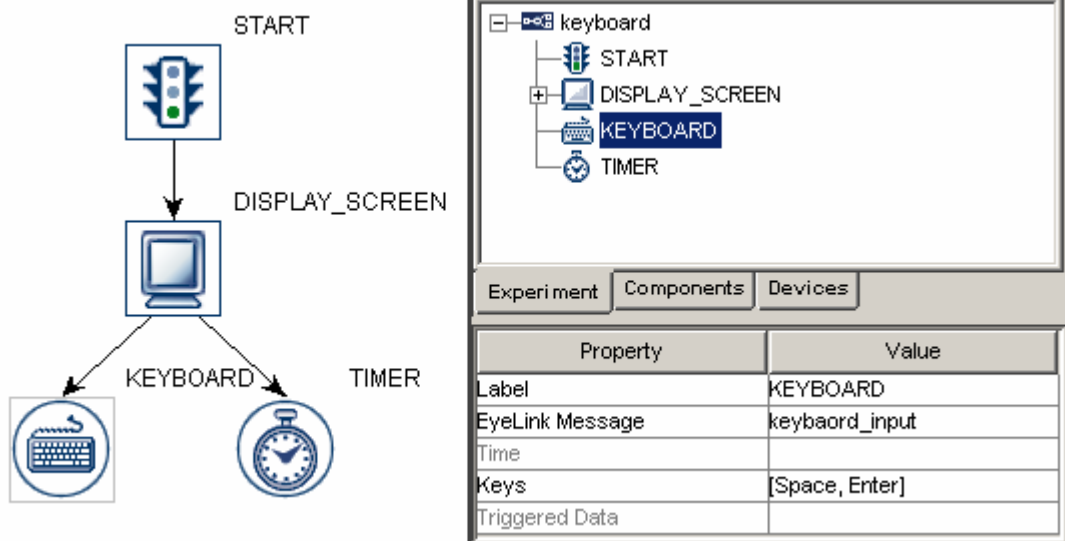



Figure 7-30. Using Keyboard Trigger.

To set the key(s) used for response, click on the value field of the “Keys” property and select the desired keys. By holding down the “CTRL” key, the user can select or de-select multiple target keys from the dropdown list.

7.10.7 Mouse Trigger

The mouse trigger () fires when a prespecified mouse button is pressed. As in the invisible boundary trigger, the user may also specify a particular region for mouse trigger to fire. Using mouse as a response device is not recommended for timing critical experiments because the temporal resolution of the mouse response is unknown and the timing performance may vary across different types of mouse (USB vs. serial).

IMPORTANT: This trigger does not function in real-time sequences on some operating systems.

Field	Attribute Reference	Type	Content
Label *	.label	String	Label of the mouse trigger. The default value is “MOUSE”.
Type #	NR		The type of Experiment Builder objects ("Mouse") the current node belongs to.
Node Path #	.absPath	String	The absolute path of the node in the experiment graph.
Message	.message	String	Message to be sent to EDF file (in an EyeLink® experiment.) or messages.txt (in a non-EyeLink experiment with "Save Messages" attribute of the Experiment node checked) when the mouse trigger fires.
Time #	.time	Float	Display PC Time when the mouse trigger returns. Note: To check the time when the mouse button is pressed/released or the mouse position falls within the triggering region, you should use @*.triggeredData.time@ (i.e., the .time sub-attribute of the .triggeredData attribute) instead.
Last Check Time #	.lastCheckTime	Float	This property can be used to retrieve the display PC Time when the trigger was checked for the last time.
Confidence Interval #	.confidenceInterval	Float	Time difference between the trigger time and last check time of the trigger. This indicates a window of uncertainty as the true trigger time could be between the last check time (.lastCheckTime) and the reported the trigger time (.time)
Clear Input Queue	.clearInputQueue	Boolean	Mouse trigger maintains event queues so that multiple mouse press/release events can be accessed over time. The current option checks

			whether the mouse event(s) cached in the event queue should be cleared when the trigger fires (NO: no event clearing; Event: removes the current triggering event from the mouse press/release event queue; LIST: all mouse events from event queue will be removed).
Buttons	.buttons	List of Integers	List of Integers ([1, 2, 3] by default) indicating the buttons may be pressed for trigger firing.
Press Events †	.pressEvents	Boolean	Whether the trigger should fire when a button press event occurs. This is set to “True” (box checked) by default.
Release Events †	.releaseEvents	Boolean	Whether the trigger should fire when a button release event occurs. This is set to “True” by default.
Position Triggered †	.positionTriggered	Boolean	Whether the mouse trigger should fire when the mouse is placed over a specific region (without any press/release events).
Region Direction	.regionDirection	List of String	A range of eye angles from a multiple-selection list ['0 - 45', '45 - 90', '90 - 135', '135 - 180', '-180 - -135', '-135 - -90', '-90 - -45', '-45 - 0'] used to restrict the direction in which the mouse trigger fires. For each angle range, the first value is inclusive and the second value is not inclusive.
Region Type	.regionType	String	The type of triggering Region used: RECTANGLE (0), ELLIPSE (1), or INTEREST AREA (2). Note that the "INTEREST AREA" option is only available when interest areas are defined in one of the display screens in the same recording sequence.
Region Location (Top Left)	.regionLocation	Point	Pixel coordinate of the top-left corner of the trigger region in (x, y) tuple. The default value is (0.00, 0.00). Note that the x, y coordinate of the region location can be further referred as .regionLocation.x and .regionLocation.y respectively. Note that this property is only available when the "Region Type" property is set to either RECTANGLE or ELLIPSE.
Region Width	.regionWidth	Integer	Width (0 by default) of the boundary region in screen pixels. Note that this property is only available when the "Region Type" property is set to either RECTANGLE or ELLIPSE.
Region Height	.regionHeight	Integer	Height (0 by default) of the boundary region in screen pixels. Note that this property is only available when the "Region Type" property is set to either RECTANGLE or ELLIPSE.
Interest Area Screen *	NR .	.	The display screen on which target interest area regions are located. Note that this property is only available when the "Region Type" property

			is set to INTEREST AREA.
Interest Area Regions	NR	.	Target interest areas used to define the triggering region. Note that this property is only available when the "Region Type" property is set to INTEREST AREA.
Within	.within	Boolean	If set to "True" (default), the trigger should fire when the mouse is within the above-mentioned trigger region; otherwise, the trigger fires when the mouse is outside of the region.
Triggered Data #	.triggeredData		Data of the triggered mouse button event (see the following table for further attributes of the mouse triggered data)

When a mouse trigger fires, the user may further access the triggered Data. The sub-attributes of the TriggeredData attribute are listed in the following table.

Attribute	Reference	Type	Content
Time	.time	Integer	Display PC time when the mouse button pressed/released
DEF Time	.EDFTime	Integer	EDF time of the mouse button press/release
Pressed	.pressed	Integer	Whether the mouse button is pressed (1) or released (0)
Button	.button	Integer	Specific button pressed/released for trigger firing
X	.x	Float	Pixel coordinate of the mouse cursor along x-axis when the trigger fired.
Y	.y	Float	Pixel coordinate of the mouse cursor along y-axis when the trigger fired.
Offset	.offset	Point	The triggered mouse position relative to the top-left corner of the triggering region.
Angle	.angle	Float	The angle of the mouse movements when the trigger fires.

For example, if the user wants to press any button to end the sequence, the properties of the mouse trigger can be set as shown in Figure 7-31. Please note that the "Position Triggered" check box should be unchecked so that clicking one of the mouse buttons anywhere on the screen fires the mouse trigger. If the "Position Triggered" check box is enabled, the user may set the width and height of the triggering region to the width and height of the display area respectively.

Some paradigms require the mouse trigger to fire at a specific region. For example, the user can click on a link in a webpage to move onto the next page. If this is the case, please make sure that the "Position Triggered" attribute is checked and that a target region is specified (see Panel A of Figure 7-31). In addition, the user may add a small image on the display screen and make its position mouse contingent (behaving as if a mouse cursor) so that the user knows the current mouse position (see Panel B of Figure 7-31).

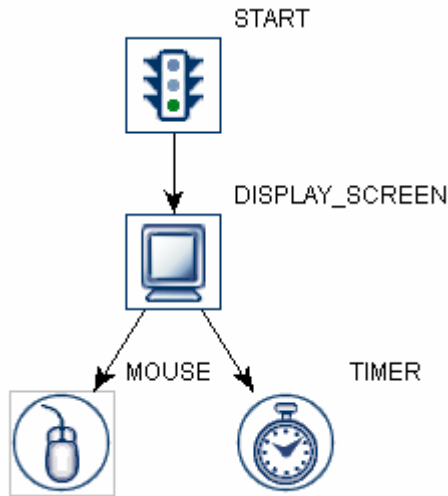

A

Property	Value
Label	MOUSE
Time	
Buttons	[1, 2, 3]
Press Events	<input checked="" type="checkbox"/>
Release Events	<input checked="" type="checkbox"/>
Position Triggered	<input type="checkbox"/>
Location	0, 0
Width	0
Height	0

B

Figure 7-31. Using Mouse Trigger

Property	Value
Label	MOUSE
EyeLink Message	
Time	
Buttons	[1, 2, 3]
Press Events	<input checked="" type="checkbox"/>
Release Events	<input checked="" type="checkbox"/>
Position Triggered	<input checked="" type="checkbox"/>
Location	0, 0
Width	256
Height	384
Offset	
Triggered Data	

A

Property	Value
Label	ELLIPSE_RESOURCE
Visible	<input checked="" type="checkbox"/>
Position is Gaze Contingent	<input type="checkbox"/>
Position is Mouse Contingent	<input checked="" type="checkbox"/>
Offset	0, 0
Location	56, 122
Width	30
Height	30
Movement Pattern	None
Prebuild To Image	<input checked="" type="checkbox"/>
Color	
Filled	<input checked="" type="checkbox"/>
Fill Color	
Stroke Width	1

B

Figure 7-32. Making a Resource Position Contingent on Mouse Position

The initial position of a mouse-contingent resource can be reset by updating the "X Position" and "Y Position" of the mouse device to intended values.

7.10.8 TTL Trigger

The TTL trigger () is used to check for TTL input to the parallel port (or other data port) of the display PC. It fires when specified TTL data is received. Please make sure that you have DriverLINX Port I/O Driver installed.

Field	Attribute Reference	Type	Content
Label *	.label	String	Label of the TTL trigger. The default value is "TTL".
Type #	NR		The type of Experiment Builder objects ("TTL") the current node belongs to.
Node Path #	.absPath	String	The absolute path of the node in the experiment graph.
Message	.message	String	Message to be sent to EDF file (in an EyeLink® experiment.) or messages.txt (in a non-EyeLink experiment with "Save Messages" attribute of the Experiment node checked) when the TTL trigger fires.
Time #	.time	Float	Display PC Time when the trigger fires. Note: To check the time when the triggering TTL pulse was received, you should use @*.triggeredData.time@ (i.e., the .time sub-attribute of the .triggeredData attribute) instead.
Last Checked Time #	.lastCheckedTime	Float	Display PC time of previous check on the trigger.
Confidence Interval #	.confidenceInterval	Float	Time difference between the trigger time and last check time of the trigger. This indicates a window of uncertainty as the true trigger time could be between the last check time (.lastCheckTime) and the reported the trigger time (.time)
Clear Input Queue	.clearInputQueue	Boolean	TTL trigger maintains event queues so that multiple TTL events can be accessed over time. The current option checks whether the TTL event(s) cached in the event queues should be cleared when the trigger fires (NO: no event clearing; Event: removes the current triggering event from the TTL event queue; LIST: all TTL events from event queue will be removed).
Register	.register	String	Usually set as "STATUS" register.
Mode *	.mode	String	Either "Word" mode (the decimal or hexadecimal value of the TTL input value) or

			"Pin" mode (status of each individual pins).
Data	.data	Integer	The byte value of the current input TTL signal. This could be a decimal or hexadecimal number. This field is only available if the "Mode" property is set to "Word".
Pin0 Pin1 Pin2 Pin3 Pin4 Pin5 Pin6 Pin7	.pin0 .pin1 .pin2 .pin3 .pin4 .pin5 .pin6 .pin7	String	The desired status for the corresponding pins. The pin value can be either "ON" (high), "OFF" (low), or "EITHER" (the status of that pin is ignored).
Triggered Data #	.triggeredData	.	If the TTL trigger fires, the triggered data can be further accessed (see the following table).

When the TTL trigger fires, the triggered data can be further accessed. The sub-attributes of the TriggeredData field are listed in the following table.

Attribute	Reference	Type	Content
Time	.time	Float	Display PC time when the voicekey trigger fires.
EDF Time	.EDFTime	Integer	EDF time when the voicekey trigger fires.
Pin Data	.pinData	integer	The byte value (a decimal number) of the current input TTL signal.

For example, if the user wants to end the trial when the parallel port received a specific input (data 0x58), the properties of the TTL trigger can be set as the following:

- If the Mode set to 'PIN', the user should make sure that pin #3, 4, and 6 set to "ON", while the rest pins set to "OFF" (see panel A).
- If the Mode set to 'WORD', the user should enter either '0x58' (hexadecimal) or '88' (decimal) in the Data field. If a decimal number is entered, this will be automatically converted to a hexadecimal number (see panel B).

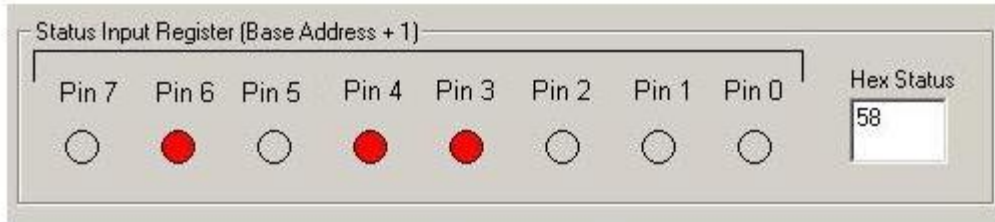

Property	Value
Label	TTL_INPUT
Object Type	TTL
Message	
Time	
Last Checked Time	
Confidence Interval	
Register	STATUS
Mode	PIN
Pin 0	OFF
Pin 1	OFF
Pin 2	OFF
Pin 3	ON
Pin 4	ON
Pin 5	OFF
Pin 6	ON
Pin 7	OFF
Triggered Data	

A

Property	Value
Label	TTL_INPUT
Object Type	TTL
Message	
Time	
Last Checked Time	
Confidence Interval	
Register	STATUS
Mode	WORD
Data	0x58
Triggered Data	

B

Figure 7-33. Using TTL Trigger

7.10.9 Fixation Trigger

The fixation trigger (👁️) fires when a fixation occurs at a specific region of the display for a certain amount of time. Depending on the settings in the event type property, this trigger can fire when the fixation starts (STARTFIXATION) or ends (ENDFIXATION) or after a pre-specified amount of time into a fixation (UPDATEFIXATION). This trigger is only available in an EyeLink© experiment.

Field	Attribute Reference	Type	Content
Label *	.label	String	Label of the fixation trigger. The default value is "FIXATION".
Type #	NR		The type of Experiment Builder objects ("Fixation") the current node belongs to.

Node Path	.absPath	String	The absolute path of the node in the experiment graph
Message	.message	String	Message to be sent to EDF file (in an EyeLink© experiment.) when the fixation trigger fires.
Time #	.time	Float	Display PC Time when the trigger fires. Note: To check the start and end time of the triggering fixation, you should use @*.triggeredData.startTime@ and @*.triggeredData.endTime@ (i.e., the .startTime and .endTime sub-attributes of the .triggeredData attribute).
Last Check Time #	.lastCheckTime	Float	This property can be used to retrieve the display PC Time when the trigger was checked for the last time.
Confidence Interval #	.confidenceInterval	Float	Time difference between the trigger time and last check time of the trigger. This indicates a window of uncertainty as the true trigger time could be between the last check time (.lastCheckTime) and the reported the trigger time (.time)
Clear Input Queue	.clearInputQueue	Boolean	Fixation trigger maintains an event queue so that multiple fixation events (start of a fixation, fixation updates, and end of a fixation) can be accessed over time. The current option checks whether the fixation event(s) cached in the event queue should be cleared when the trigger fires (NO: no event clearing; Event: removes the current triggering event from the fixation event queue; LIST: all fixation events from event queue will be removed).
Region Type	.regionType	String	The type of triggering Region used: RECTANGLE (0), ELLIPSE (1), or INTEREST AREA (2). Note that the "INTEREST AREA" option is only available when interest areas are defined in one of the display screens in the same recording sequence.
Region Location (Top Left)	.regionLocation	Point	Pixel coordinate of the top-left corner of the boundary region in (x, y) tuple. The default value is (0.00, 0.00). Note that the x, y coordinate of the region location can be further referred as .regionLocation.x and .regionLocation.y respectively. Note that this property is only available when the "Region Type" property is set to either RECTANGLE or ELLIPSE.
Region Width	.regionWidth	Integer	Width (0 by default) of the boundary region in screen pixels. Note that this property is only available when the "Region Type" property is set to either RECTANGLE or ELLIPSE.
Region Height	.regionHeight	Integer	Height (0 by default) of the boundary region in

			screen pixels. Note that this property is only available when the "Region Type" property is set to either RECTANGLE or ELLIPSE.
Interest Area Screen *	NR .	.	The display screen on which target interest area regions are located. Note that this property is only available when the "Region Type" property is set to INTEREST AREA.
Interest Area Regions	NR	.	Target interest areas used to define the triggering region. Note that this property is only available when the "Region Type" property is set to INTEREST AREA.
Within †	.within	Boolean	If set to "True", the trigger should fire when the fixation are within the target region.
Tracking Eye ¶	.trackingEye	String	Decides which eye's data is used for online parsing. The default value is "EITHER". It can also be LEFT or RIGHT.
Minimum Duration	.minimumDuration	Integer	Duration (0 by default) of fixation in or out of the region before the trigger fires. This property is available only if the Event Type is set as "UPDATEFIXATION" or "ENDFIXATION".
Event Type ¶¶	.eventType	String	Fixation Event used for parsing. This trigger fires when the start of a fixation is detected when set to "STARTFIXATION", or the end of a fixation if set to "ENDFIXATION". If set to "UPDATEFIXATION", Experiment Builder checks for fixation update event (i.e., summary data of the fixation) sent from the tracker at a constant interval (50 ms or so). It will fire after a pre-specified amount of time into a fixation. If the "Minimum Duration" of the "UPDATEFIXATION" is set to 0 (or any value within one fixation update interval), the trigger will fire after receiving one fixation update event.
Triggered Data #	.triggeredData		Data about the fixation trigger, if fired (see the following table).

When a fixation trigger fires, the user can further get access to the triggered data. The sub-attributes of the TriggeredData attribute are listed in the following table.

Attribute	Reference	Type	Content
Start Time	.startTime	Integer	Display PC time when the triggering fixation or fixation update event starts.
End Time	.endTime *	Integer	Display PC time when the triggering fixation or fixation update event ends (-32768 if eye event is set to "STARTFIXATION").

EDF Star Time	.EDFStartTime	Integer	EDF time (time since the EyeLink© program started on the host PC) when the triggering fixation starts
EDF End Time	.EDFEndTime *	Integer	EDF time when the triggering fixation or fixation update event ends.
Eyes Available	.eyesAvailable	Integer	This attribute is depreciated; it will always return the same value as the "Triggered Eye" property. To find out the eye(s) used in the recording, check the "Eye Used" property (.eyeUsed) of the EyeLink Device.
Triggered Eye	triggeredEye	Integer	Eye (0 for left eye; 1 for right eye) whose data makes the current fixation trigger fire.
Duration	.duration *	Integer	Duration of the triggering fixation or fixation update event.
Average Gaze X, Average Gaze Y	.averageGazeX* .averageGazeY *	Float	Average x/y gaze position of the triggering fixation or fixation update event.
Average Pupil Size	.averagePupilSize *	Float	Average pupil size of the triggering fixation or fixation update event.
Start Gaze X, Start Gaze Y	.startGazeX .startGazeY	Float	X/Y gaze position when the triggering fixation or fixation update event started
Start Pupil Size	.startPupilSize	Float	Pupil size when the triggering fixation or fixation update event started.
End Gaze X, End Gaze Y	.endGazeX * .endGazeY *	Float	X/Y gaze position when the triggering fixation or fixation update event ended
End Pupil Size	.endPupilSize *	Float	Pupil size when the triggering fixation or fixation update event ended.
Start PPD X, Start PPD Y	.startPPDX .startPPDY	Float	Angular x/y resolution when triggering fixation or fixation update event starts (in screen pixels per visual degree, PPD).
End PPD X, End PPD Y	.endPPDX * .endPPDY *	Float	Angular x/y resolution when triggering fixation or fixation update event ends (in screen pixels per visual degree, PPD).

Note: * -32768 if the eye event is set to "STARTFIXATION".

For example, if the user wants to end a display after the participant looks at the target region for a couple hundred of milliseconds. The user may set the "Event Type" as "UPDATEFIXATION" (see Figure 7-34).

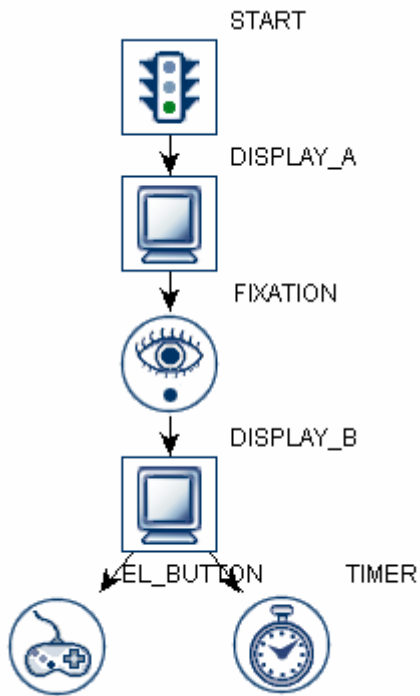

A

Property	Value
Label	FIXATION
EyeLink Message	Fixation_trigger
Time	
Region Location	0, 0
Region Width	256
Region Height	192
Within	<input checked="" type="checkbox"/>
Tracking Eye	LEFT
Minimum Duration	500
Event Type	UPDATEFIXATION
Triggered Data	

B

Figure 7-34. Using Fixation Trigger.

If the fixation trigger should fire regardless where the participant is fixating at, the user may set the trigger region as the whole screen (i.e., Region Location as (0,0), Region Width as 1024, and Region Height as 768 for a 1024 × 768 screen resolution). Alternatively, the user may keep the default region settings and uncheck the “Within” button. Since the fixation trigger keeps monitoring the online eye data, it must be placed within a recording sequence (i.e., the “Record” property of the sequence is checked).

7.10.10 Saccade Trigger

The saccade trigger (👁️), available only in an EyeLink© experiment, fires following the detection of a saccade to a specific region of the display. This trigger waits for a “STARTSACC” online parser signal from the tracker following the start of a saccade. Typically this data is available about 20 milliseconds after the actual start of the saccade. If the timing of saccade detection is critical, the user may use the sample velocity trigger instead. Since the saccade trigger keeps monitoring the online eye data, this trigger type must be placed within a recording sequence (i.e., the “Record” property of the sequence is checked). If you see a “This node type cannot be added to this sequence” warning message, check whether the sequence to which the current trigger belongs is a recording sequence.

Field	Attribute	Type	Content
-------	-----------	------	---------

	Reference		
Label #	.label	String	Label of the saccade trigger. The default value is "SACCADE".
Type #	NR		The type of Experiment Builder objects ("Saccade") the current node belongs to.
Node Path	.absPath	String	The absolute path of the node in the experiment graph
Message	.message	String	Message to be written to EDF file when the saccade trigger fires.
Time #	.time	Float	Display PC Time when the trigger fires. Note: To check the start and end time of the triggering saccade, you should use @*.triggeredData.startTime@ and @*.triggeredData.endTime@ (i.e., the .startTime and .endTime sub-attributes of the .triggeredData attribute).
Last Check Time #	.lastCheckTime	Float	This property can be used to retrieve the display PC Time when the trigger was checked for the last time.
Confidence Interval #	.confidenceInterval	Float	Time difference between the trigger time and last check time of the trigger. This indicates a window of uncertainty as the true trigger time could be between the last check time (.lastCheckTime) and the reported the trigger time (.time)
Clear Input Queue	.clearInputQueue	Boolean	EyeLink saccade trigger maintains an event queue so that multiple saccade events can be accessed over time. The current option checks whether the saccade event(s) cached in the event queue should be cleared when the trigger fires (NO: no event clearing; Event: removes the current triggering event from the saccade event queue; LIST: all saccade events from event queue will be removed).
Region Type	.regionType	String	The type of triggering Region used: RECTANGLE (0), ELLIPSE (1), or INTEREST AREA (2). Note that the "INTEREST AREA" option is only available when interest areas are defined in one of the display screens in the same recording sequence.
Region Direction	.regionDirection	List	A range of eye angles from a multiple-selection list ['0 - 45', '45 - 90', '90 - 135', '135 - 180', '-180 - -135', '-135 - -90', '-90 - -45', '-45 - 0'] used to restrict the direction in which the saccade trigger fires.
Region Location (Top Left)	.regionLocation	Point	Pixel coordinate of the top-left corner of the boundary region in (x, y) tuple. The default value is (0.00, 0.00). Note that the x, y coordinate of the region location can be further referred as .regionLocation.x

			and .regionLocation.y respectively. Note that this property is only available when the "Region Type" property is set to either RECTANGLE or ELLIPSE.
Region Width	.regionWidth	Integer	Width (0 by default) of the boundary region in screen pixels. Note that this property is only available when the "Region Type" property is set to either RECTANGLE or ELLIPSE.
Region Height	.regionHeight	Integer	Height (0 by default) of the boundary region in screen pixels. Note that this property is only available when the "Region Type" property is set to either RECTANGLE or ELLIPSE.
Interest Area Screen *	NR .	.	The display screen on which target interest area regions are located. Note that this property is only available when the "Region Type" property is set to INTEREST AREA.
Interest Area Regions	NR	.	Target interest areas used to define the triggering region. Note that this property is only available when the "Region Type" property is set to INTEREST AREA.
Within †	.within	Boolean	If checked, the trigger fires when the saccade lands within the target region.
Tracking Eye ¶	.trackingEye	String	Decides which eye's data is used for online parsing. The default value is "EITHER". It can also be LEFT or RIGHT.
Minimum Amplitude	.minimumAmplitude	Integer	Minimum amplitude (0 by default) of the triggering saccade.
Triggered Data #	.triggeredData		Data about the saccade trigger if fired (see the following table)

The user can further get access to the triggered data if a saccade trigger fires. The sub-attributes of the TriggeredData field are listed in the following table.

Reference	Attribute	Type	Content
Start Time	.startTime	Integer	Display PC time when the triggering saccade starts
End Time	.endTime	Integer	Display PC time when the triggering saccade ends
EDF Start Time	.EDFStartTime	Integer	EDF time (time since the EyeLink© program started on the host PC) when the triggering saccade starts
EDF End Time	.EDFEndTime	Integer	EDF time when the triggering saccade ends
Eyes Available	.eyesAvailable	Integer	This attribute is depreciated; it will always return the same value as the "Triggered Eye" property. To find out the eye(s) used in the recording, please check the "Eye Used" property (.eyeUsed) of the EyeLink Device
Triggered Eye	.triggeredEye	Integer	Eye (0 for left eye; 1 for right eye) whose data makes the current saccade trigger fire.

Duration	.duration	Integer	Duration of the triggering saccade.
Start Gaze X	.startGazeX	Float	X gaze position when the triggering saccade started
Start Gaze Y	.startGazeY	Float	Y gaze position when the triggering saccade started.
End Gaze X	.endGazeX	Float	X gaze position when the triggering saccade ended
End Gaze Y	.endGazeY	Float	Y gaze position when the triggering saccade ended.
Start PPD X	.startPPDX	Float	Angular x resolution at the start of saccade (in screen pixels per visual degree, PPD).
Start PPD Y	.startPPDY	Float	Angular y resolution at the start of saccade (in screen pixels per visual degree, PPD).
End PPD X	.endPPDX	Float	Angular x resolution at the end of saccade (in screen pixels per visual degree, PPD).
End PPD Y	.endPPDY	Float	Angular y resolution at the end of saccade (in screen pixels per visual degree, PPD).
Average Velocity	.averageVelocity	Float	Average velocity (in degrees/second) of the current saccade.
Peak Velocity	.peakVelocity	Float	Peak value of gaze velocity (in degrees/second) of the current saccade.
Amplitude	.amplitude	Float	Amplitude of the current saccade in degrees of visual angle.
Angle	.angle	Float	The angle of the saccade movement when the trigger fires.

For example, if the user wants to end a sequence after the participant makes a saccade towards the target region (200, 360, 248, 408). The user may use a saccade trigger, set the “Region Location” as (200, 360), “Region Width” as 24 and “Region Height” as 24. The user may further configure the minimum saccade amplitude and the triggering eye (see Figure 7-35).

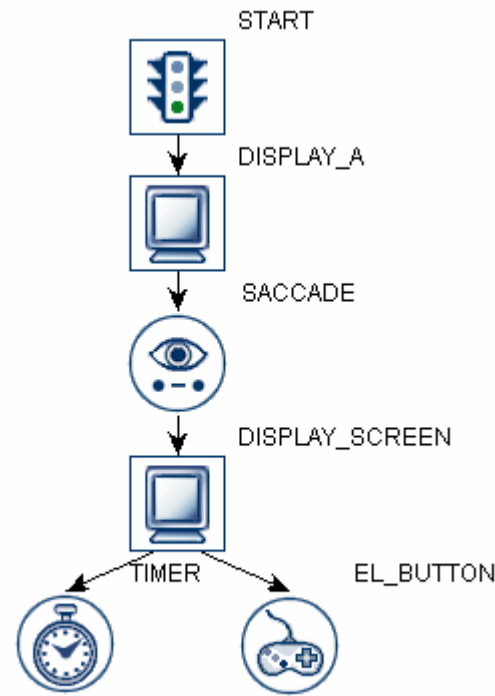

A

Property	Value
Label	SACCADDE
EyeLink Message	Saccade_trigger
Time	
Region Location	200, 360
Region Width	24
Region Height	24
Within	<input checked="" type="checkbox"/>
Tracking Eye	EITHER
Minimum Amplitude	2.0
Triggered Data	

B

Figure 7-35. Using Saccade Trigger.

If the saccade trigger should fire regardless where the saccade is directed to, the user may set the triggering region as the whole screen (i.e., Region Location as (0,0), the Region Width as 1024 and Region Height as 768 for a 1024 × 768 screen resolution). Alternatively, the user may keep the default region settings and uncheck the “Within” button.

7.10.11 Sample Velocity Trigger

The sample velocity trigger (👁️➡️), available only in an EyeLink© experiment, implements a “fast” saccade detection algorithm by checking the velocity and acceleration information on a sample-by-sample basis. This trigger will fire much quicker than the Saccade trigger, so the Sample Velocity Trigger should be used for saccade contingent paradigms. The Sample velocity trigger fires when both the sample velocity and acceleration values exceed their respective criteria. Occasionally, there will be “misses” and “false alarms” in saccade detection compared to the “slower” saccade trigger.

The sample velocity trigger is location-based and fires only when the eyes are within or outside of a specified region. To make the trigger fire regardless of current eye position, the user can keep the default location settings but uncheck the “within” check box. Alternatively, the user may set the triggering region as the whole display area. As all

other eye-based trigger types, a sample velocity trigger must be used in a recording sequence.

Field	Attribute Reference	Type	Content
Label *	.label	String	Label of the sample velocity trigger. The default label is "SAMPLE_VELOCITY".
Type #	NR		The type of Experiment Builder objects ("SampleVelocity") the current node belongs to.
Node Path	.absPath	String	The absolute path of the node in the experiment graph
Message	.message	String	Message to be sent to EDF file (in an EyeLink© experiment.) when the sample velocity trigger fires.
Time #	.time	Float	Display PC Time when the trigger fires. Note: To check the time when the triggering sample occurs, you should use @*.triggeredData.time@ instead.
Last Check Time #	.lastCheckTime	Float	This property can be used to retrieve the display PC Time when the trigger was checked for the last time.
Confidence Interval #	.confidenceInterval	Float	Time difference between the trigger time and last check time of the trigger. This indicates a window of uncertainty as the true trigger time could be between the last check time (.lastCheckTime) and the reported the trigger time (.time)
Region Type	.regionType	String	The type of triggering Region used: RECTANGLE (0), ELLIPSE (1), or INTEREST AREA (2). Note that the "INTEREST AREA" option is only available when interest areas are defined in one of the display screens in the same recording sequence.
Region Direction	.regionDirection	List of String	A range of eye angles from a multiple-selection list ['0 - 45', '45 - 90', '90 - 135', '135 - 180', '-180 - -135', '-135 - -90', '-90 - -45', '-45 - 0'] used to restrict the direction in which the sample velocity trigger fires. For each angle range, the first value is inclusive and the second value is not inclusive.
Region Location (Top Left)	.regionLocation	Point	Pixel coordinate of the top-left corner of the boundary region in (x, y) tuple. The default value is (0.00, 0.00). Note that the x, y coordinate of the region location can be further referred as .regionLocation.x and .regionLocation.y respectively. Note that this property is only available when the "Region Type" property is set to either RECTANGLE or ELLIPSE.
Region Width	.regionWidth	Integer	Width (0 by default) of the boundary region in

			screen pixels. Note that this property is only available when the "Region Type" property is set to either RECTANGLE or ELLIPSE.
Region Height	.regionHeight	Integer	Height (0 by default) of the boundary region in screen pixels. Note that this property is only available when the "Region Type" property is set to either RECTANGLE or ELLIPSE.
Interest Area Screen *	NR .	.	The display screen on which target interest area regions are located. Note that this property is only available when the "Region Type" property is set to INTEREST AREA.
Interest Area Regions	NR	.	Target interest areas used to define the triggering region. Note that this property is only available when the "Region Type" property is set to INTEREST AREA.
Within †	.within	Boolean	If checked, the trigger fired when the samples are in the target region.
Tracking Eye ¶	.trackingEye	String	Decides which eye's data is used for online parsing. The default value is "EITHER". It can also be LEFT or RIGHT.
Trigger Above Threshold †	.triggerAboveThreshold	Integer	Decide whether the trigger should fire if the current velocity and acceleration values exceed the threshold values.
Velocity Threshold	.velocityThreshold	Integer	Sets velocity threshold of saccade detector: usually 30 (°/sec) for cognitive research, 22 (°/sec) for pursuit and neurological work. The default is 30-degrees. This will override the "saccade sensitivity" settings in Preferences → Experiment → Devices → EyeLink©.
Use Acceleration	.useAcceleration	Boolean	Whether the acceleration value should be considered. Given the dynamics of acceleration/deceleration during a saccade, this field may be checked whether determining a saccade with no region location constrain (e.g., when the location is set to full-screen). If the trigger should fire when entering or leaving a particular region, the user may leave this box unchecked (i.e., ignore the acceleration data).
Acceleration Threshold	.accelerationThreshold	Integer	Sets acceleration threshold of saccade detector: usually 8000 (°/sec/sec) for cognitive research, 3800 (°/sec/sec) for pursuit and neurological work. The default value is 8000. This will override the "saccade sensitivity" settings in Preferences → Experiment → Devices → EyeLink©.
Triggered Data #	.triggeredData		Data about the saccade trigger, if fired (see the following table)

If the Sample Velocity trigger fires, the user can access to the triggered data. The attributes of the TriggeredData field are listed in the following table.

Reference	Attribute	Type	Content
Time	.time	Integer	Display PC time when the trigger fires.
EDF Time	.EDFTime	Integer	EDF time of the triggering sample.
Eyes Available	.eyesAvailable	Integer	Eyes available in recording (0 for left eye; 1 for right eye; 2 for either eye).
Triggered Eye	.triggered Eye	Integer	Eye (0 for left eye; 1 for right eye) whose data makes the current sample velocity trigger fire.
PPD X, PPD Y	.PPDX, .PPDY	Float	Angular resolution at current gaze position in screen pixels per visual degree along the x-, or y-axis
Left Gaze X, Right Gaze X, Average Gaze X	.leftGazeX, .rightGazeX, .averageGazeX ¹	Float	Gaze position of the triggering sample along the x-axis for the left eye, right eye and the average between the two.
Left Gaze Y, Right Gaze Y, Average Gaze Y	.leftGazeY, .rightGazeY, .averageGazeY ¹	Float	Gaze position of the triggering sample along the y-axis for the left eye, right eye and the average between the two.
Left Pupil Size, Right Pupil Size, Average Pupil Size	.leftPupilSize, .rightPupilSize, .averagePupilSize ¹	Float	Left eye, right eye, or average pupil size (in arbitrary units, area or diameter)
Left Velocity, Right Velocity, Average Velocity	.leftVelocity, .rightVelocity, .averageVelocity ¹	Float	Left eye, right eye, or average velocity (in degrees /second)
Left Acceleration, Right Acceleration, Average Acceleration	.leftAcceleration, .rightAcceleration, .averageAcceleration ¹	Float	Left eye, right eye, or average acceleration (in degrees /second ²)
Angle	.angle	Float	The angle of the eye movements when the trigger fires.
Target Distance	.targetDistance	Integer	Distance between the target and camera (10 times the measurement in millimeters). This option is for EyeLink Remote eye tracker only. Returns "MISSING_DATA" (-32768) if target is missing or if running a non-Remote eye tracker.
Target X, Target Y	.targetX, .targetY	Integer	X, Y position of the target in camera coordinate. This option is for EyeLink Remote eye tracker only. Returns "MISSING_DATA" (-32768) if target is missing or if running a non-Remote eye tracker.
Target Flags	.targetFlags	Integer	Flags used to indicate target tracking status (0 if target tracking is ok; otherwise error code). This option is for EyeLink Remote eye tracker only.

		Returns "MISSING_DATA" (-32768) if running a non-Remote eye tracker.
--	--	--

Note:

¹ Returns "MISSING_DATA" (-32768) for the untracked eye.

The sample velocity trigger can be used when a saccade needs to be detected as quickly as possible so that a display change can be implemented. To detect a saccade, instantaneous velocity and acceleration values are calculated for each sample and compared to the threshold values. For cognitive experiments, the velocity threshold is typically set to 30 degrees/sec and the acceleration threshold is set to (8000 degrees/sec²) to detect saccades of 0.5 degrees of visual angle or greater (see Figure 7-36). For psychophysical studies, the threshold values are much lower to make the parser more sensitive.

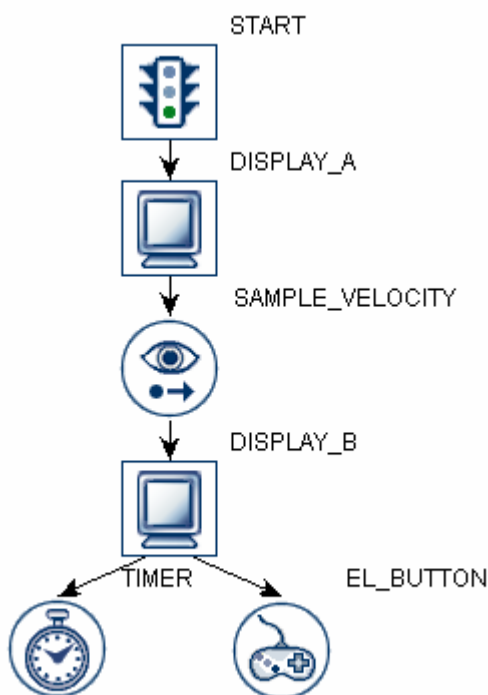

A

Property	Value
Label	SAMPLE_VELOCITY
EyeLink Message	sample_velocity
Time	
Region Location	0, 0
Region Width	1024
Region Height	768
Within	<input checked="" type="checkbox"/>
Tracking Eye	EITHER
Velocity Threshold	30
Acceleration Threshold	9500
Triggered Data	

B

Figure 7-36. Using Sample Velocity Trigger

7.10.12 ASIO Voicekey Trigger

ASIO Voicekey trigger (🗣️) fires when ASIO input exceeds a pre-specified threshold. Note that this trigger type only works in experiments with ASIO-compatible sound card and the Audio devices set to the "ASIO" driver. It must be realized that a voice key will typically respond to the "voiced" parts of vowels and some consonants, and therefore will not accurately measure the onset time of words. For this purpose, the user may use some

other audio editing tools to analyze the recorded audio. The voice key is most useful in detecting that a subject has made a response, for the purpose of ending trials.

Field	Attribute Reference	Type	Content
Label *	.label	String	Label of the voice key trigger. The default value is "VOICE_KEY".
Type #	NR		The type of Experiment Builder objects ("VoiceKey") the current node belongs to.
Node Path	.absPath	String	The absolute path of the node in the experiment graph
Message	.message	String	Message to be sent to EDF file (in an EyeLink© experiment.) or messages.txt (in a non-EyeLink experiment with " Save Messages" attribute of the Experiment node checked) when the trigger fires.
Time #	.time	Float	Time when the trigger fires. Note: To check the time when the input voice level exceeds the threshold, you should use @*.triggeredData.time@ (i.e., the .time sub-attribute of the .triggeredData attribute) instead.
Last Check Time #	.lastCheckTime	Float	Experiment Builder checks for the status of the trigger about every 1 msec. This property can be used to retrieve the display PC Time when the trigger was checked for the last time.
Confidence Interval #	.confidenceInterval	Float	Time difference between the trigger time and last check time of the trigger. This indicates a window of uncertainty as the true trigger time could be between the last check time (.lastCheckTime) and the reported the trigger time (.time)
Clear Input Queue	.clearInputQueue	Boolean	ASIO Voicekey trigger maintains an event queue so that multiple voicekey events can be accessed over time. The current option checks whether the voicekey event(s) cached in event queue should be cleared when the trigger fires (NO: no event clearing; Event: removes the current triggering event from the voicekey event queue; LIST: all voicekey events from event queue will be removed).
Threshold	.threshold	Float	Value from 0.0 to 1.0 to set voicekey trigger level, with 1.0 being the maximum audio level. The threshold should be set high enough to reject noise and prevent false triggering, but low enough to trigger quickly on speech. A threshold of 0.05 to 0.10 is typical.
Below Threshold	.belowThreshold	Boolean	Whether the voice key should trigger is the audio level is below the specified threshold level.
Triggered Data #	.triggeredData	.	If the voice key trigger fires, the triggered data

			can be further accessed (see the following table).
--	--	--	--

When the voicekey trigger fires, the triggered data can be further accessed. The sub-attributes of the TriggeredData field are listed in the following table.

Reference	Attribute	Type	Content
Time	.time	Integer	Display PC time when the voicekey trigger fires.
EDF Time	.EDFTime	Integer	EDF time when the voicekey trigger fires.
Level	.level	Float	Returns the voicekey audio level (in the same units as the voicekey threshold) when the voicekey trigger fires, with 0.0 being silence and 1.0 being the maximum audio level.

For example, the user may want to use voicekey to detect the onset of spoken word. As shown in the following graph, the user may first add a "RECORD_SOUND" action to start audio recording. When the voicekey trigger fires, a "RECORD_SOUND_CONTROL" action may be used to stop the sound recording:

Property	Value
Label	VOICE_KEY
Object Type	VoiceKey
Message	VOICE_KEY_TRIGGER
Time	
Last Checked Time	
Confidence Interval	
Threshold	0.5
Triggered Data	

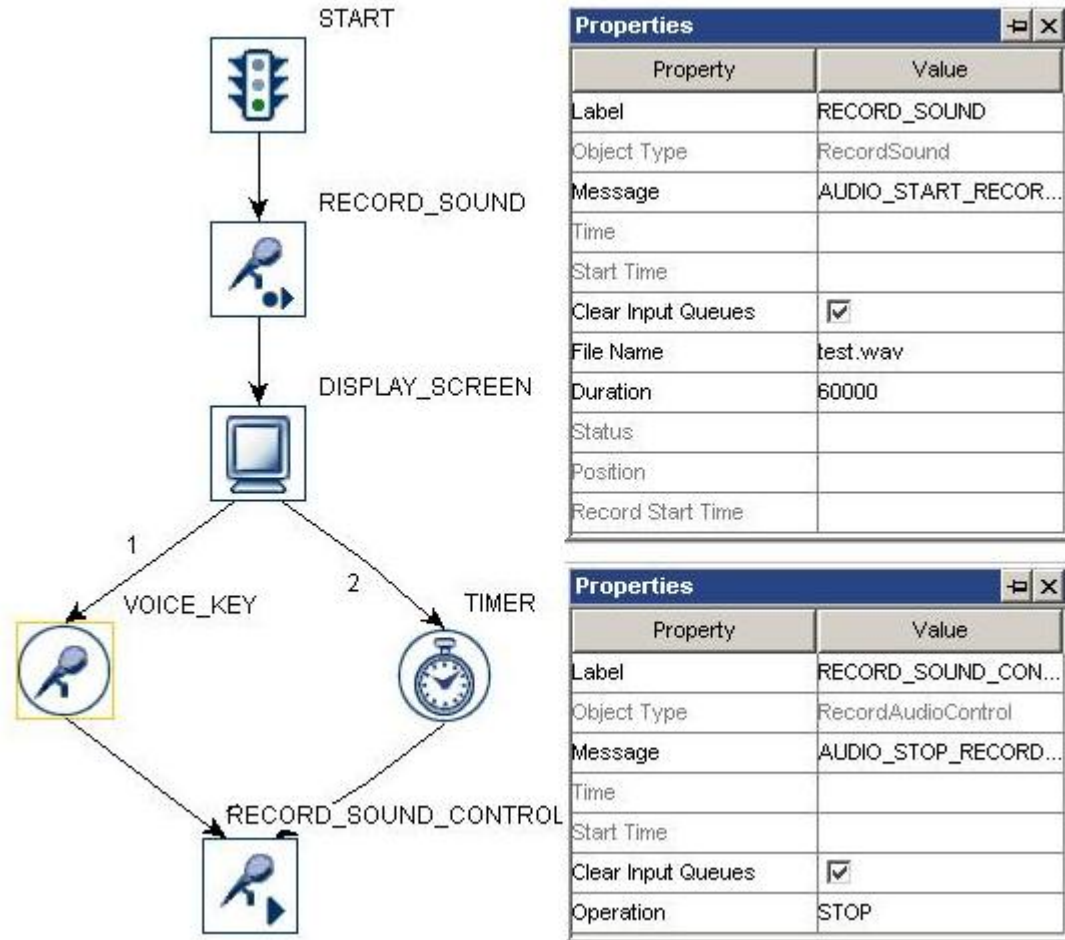

Figure 7-37. Using Voice Key Trigger

7.11 Other Building Components

This section lists other components for experiment building: variable, result file, and accumulator (see Figure 7-38).

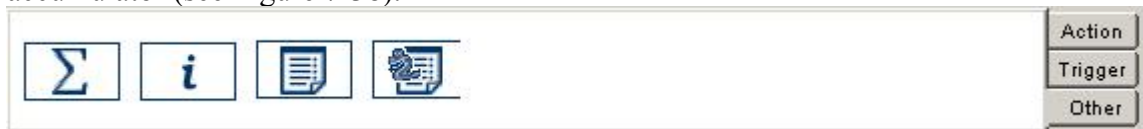



Figure 7-38. Other Components Implemented in Experiment Builder

7.11.1 Variable

The user can create a variable () during run time to keep track of some important information (e.g., the iteration status in a loop). To create a new variable, simply drag it from the component toolbox to the Work Space. Note that the variable object should be used without connecting to other items in a graph. The user can update the value of the

variable by assigning a value directly, referring to the attribute of another item, or by equation.

Field	Attribute Reference	Type	Content
Label *	.label	String	Label of the variable. The default value is "VARIABLE".
Type #		NR	The type of Experiment Builder objects ("Variable") the current node belongs to.
Node Path	.absPath	String	The absolute path of the node in the experiment graph
Data Type	NR		The data type of the variable (could be "String", "Integer", "Float", "Point", "Color", and "List").
Value	.value		The value of the variable.

Image one experiment in which the display screen alternates between displays A and B and the trial ends after a certain number of alternations. The user may want to create a counter to keep track of the number of loops. The user may first add a Variable object to the graph (see Figure 7-39) and set its initial value to 0 (see Panel A of Figure 7-40). Following this, an update-attribute action can be added in the loop to increase the value of the variable by 1 for each loop (set the "Attribute" property of the action as "@VARIABLE.value@" and set its "value" field as "=@VARIABLE.value@ + 1"; see Panel B of Figure 7-40). Finally, a conditional trigger should be added so that the loop can be ended after 5 repetitions (see Panel C of Figure 7-40).

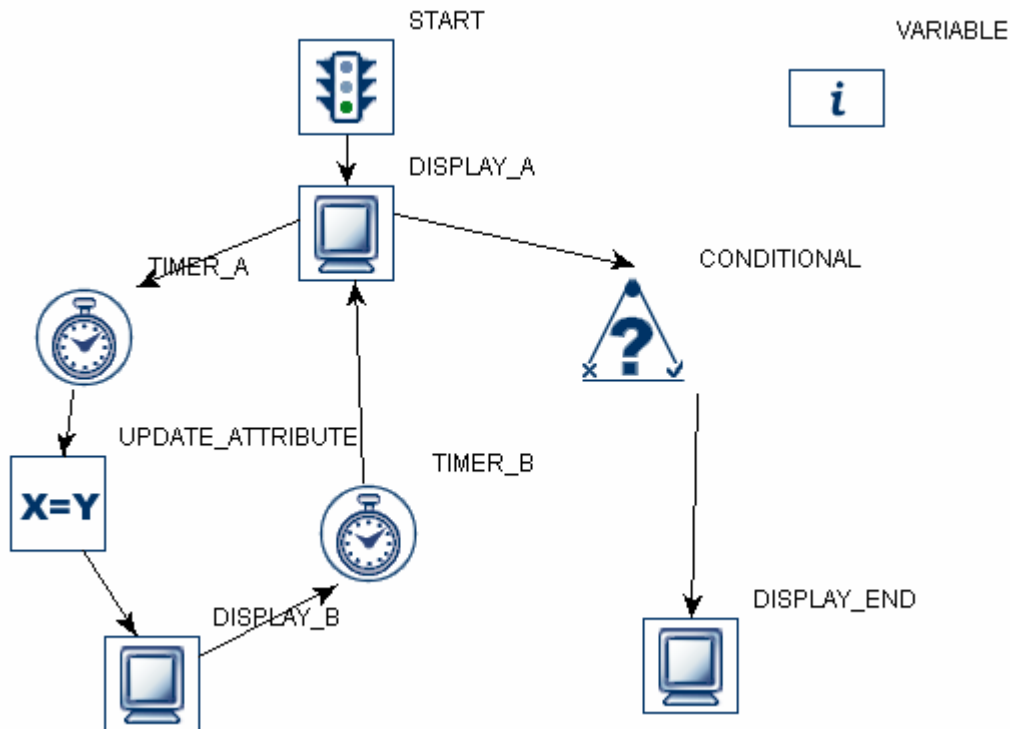
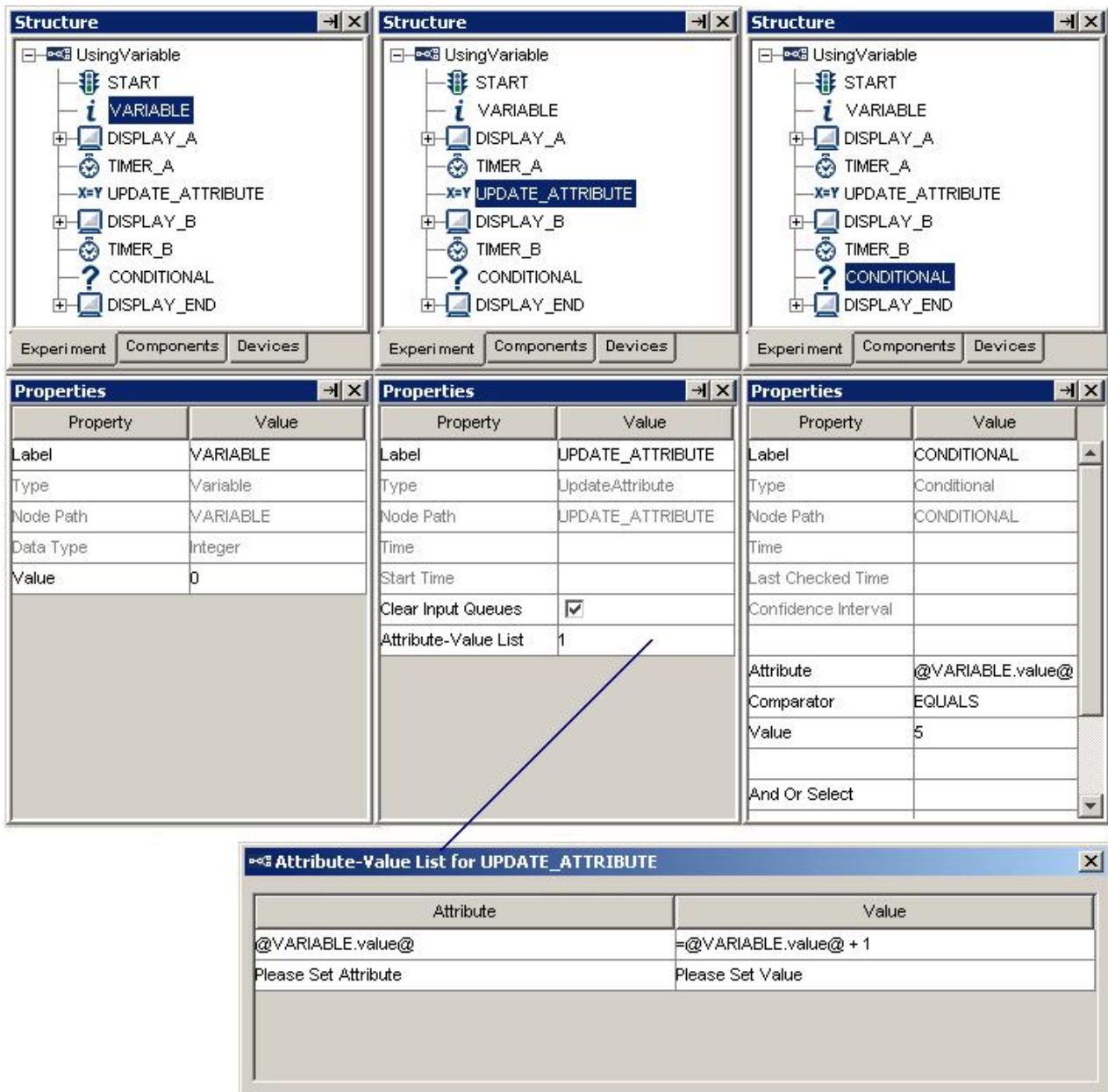

Figure 7-39. Using a Variable



A

B

C

Figure 7-40. Property Settings for Variables

Variable can be conveniently used as temporary data storage. For example, to output some trigger data to a result file or to record it to a Trial ID message, the user may first create a variable and refer it to the target triggered data. Please note that a variable in Experiment Builder has no intrinsic data type. As a result, the user can flexibly change the type of the variable by setting an initial value to the “Value” field – the default data type for a new variable is “String”. For example (see Figure 7-41), if the user enters “0” in the Value field, the Type is automatically reset to “Integer”. If “0.0” is entered instead, the Type is set to “Double”. When referring the variable to an attribute of a node in the

graph, the user should make sure that the type of the variable matches the data type of the intended attribute.

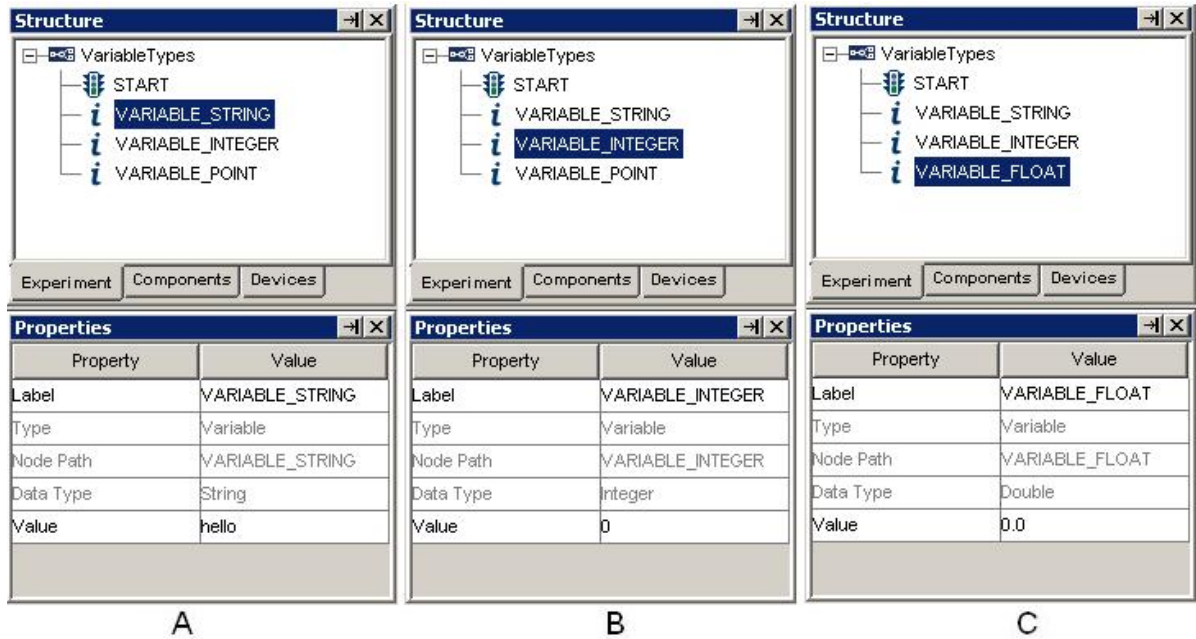

Figure 7-41. Dynamic Data Type Casting

In addition, the user should set the initial value of a variable to a plausible value to avoid build-time error. For example:

- If the user wants to use a variable to store the temporary value of the image file name, the initial value of the variable should be set to the name of one image resource in the image library, instead to an arbitrary string like “abc”.
- Default value needs to be a valid value for equation use. For example, if a variable is used as the divisor in a division operation, make sure that the initial value of the divisor is non-zero.

To clear a non-string value (eg. 3) set in the "value" attribute of a variable, the user may first set the value to some string (e.g., "hello") and then clear it.

7.11.2 Result File

In addition to the EyeLink© EDF file, the user can also create her/his own output file.

This is especially the case for non-EyeLink© experiments. Result file (📄), working together with the ADD_RESULT action, is used to record experiment data. It provides a columnar output of selected variables. Each row of the file represents a call of the ADD_RESULT action. Similar to the above mentioned Variable object, a Result File object should be used without connecting to any other item in a graph.

Field	Attribute Reference	Type	Content
Label *	.label	String	Label of the RESULT FILE object. The default

			value is "RESULTS_FILE".
Type #		NR	The type of Experiment Builder objects ("ResultsFile") the current node belongs to.
Node Path	.absPath	String	The absolute path of the node in the experiment graph
Columns	NR		The list of variables to be recorded in the result file.
Use Period for Missing Values † *	.usePeriodForMissingValues	Boolean	If true, a "." will be written out to the result file instead of missing values (i.e., -32768 for numbers and "MISSING_VALUE" for strings)
Field Width *	.fieldWidth	Integer	An integer specifying the minimum output field width. This will be exceeded if necessary.
Precision *	.precision	Integer	Specifies the number of digits to appear after the decimal point.

Result file is useful for recording data in non-EyeLink© experiments. The following graph (see Figure 7-42) illustrates part of a simple reaction-time experiment.

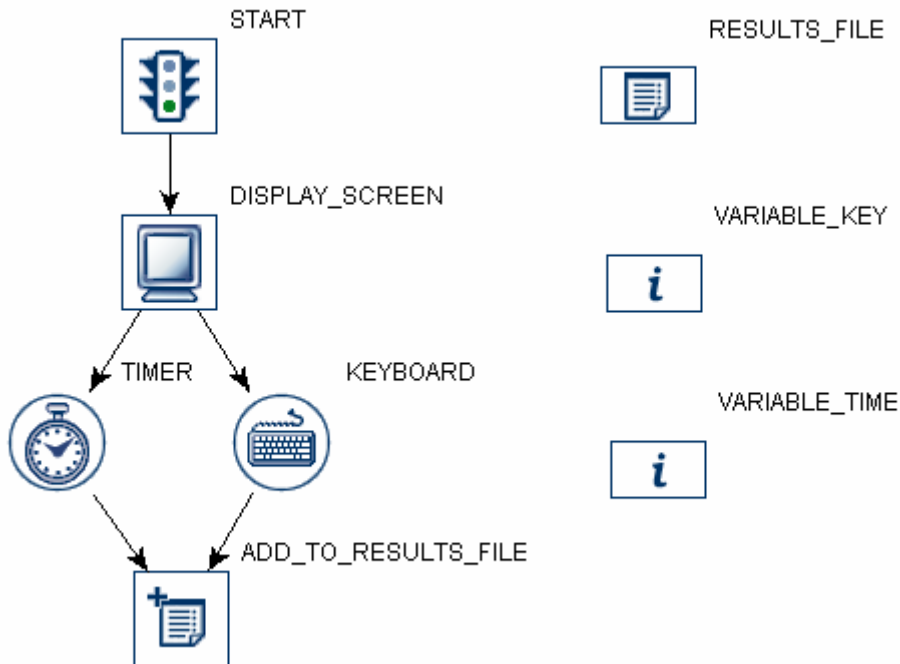

Figure 7-42. Using Result File

To record the keyboard response and response time to the result file, the user needs to create two new variables: "VARIABLE_KEY" referring to the keyboard response (@KEYBOARD.triggeredData.key@) and "VARIABLE_TIME" referring to the elapse time of the timer trigger (@TIMER.elapsedTime@). The user also needs to add a "RESULTS_FILE" object to the experiment and click on the "Columns" property to add both variables for output (see Panel A of Figure 7-43). An ADD_RESULT action is added following the timer and keyboard triggers to record responses and reaction time for the

sequence. The “Results File” property of the ADD_RESULT action is set to “RESULT FILE”.

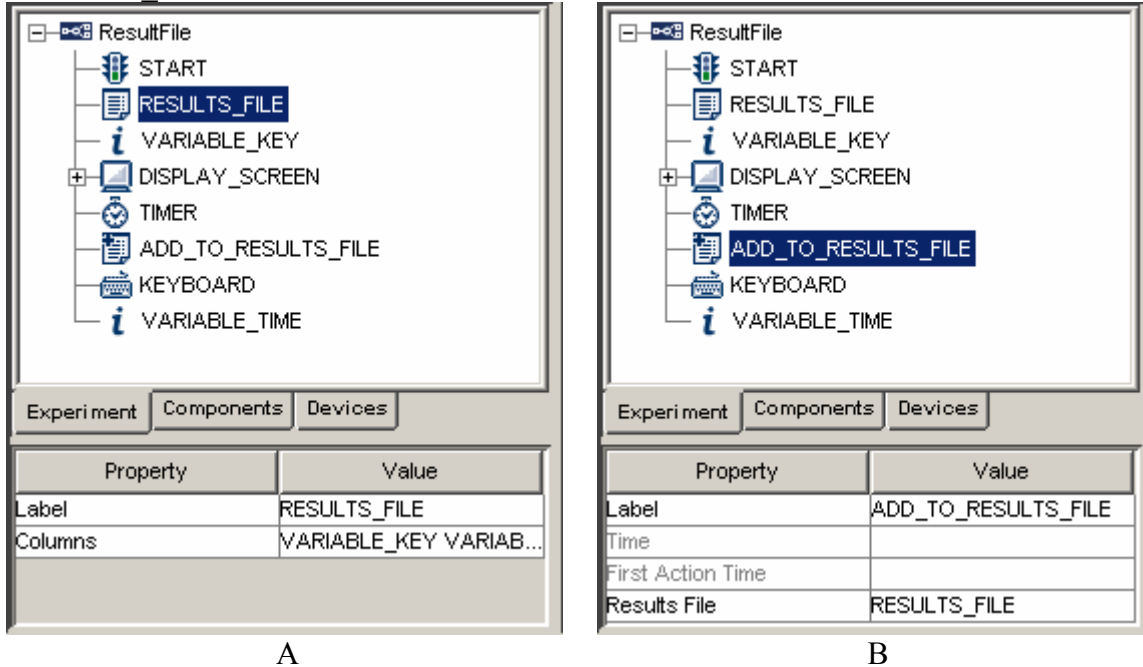

Figure 7-43. Setting Properties of the Result File Node

When the experiment is executed, a result file is generated in the experiment directory, with one column for each of the output variables. The result file is tab-delimited and can be easily imported by most statistical software.

VARIABLE_TIME	VARIABLE_BUTTON
686.0	b
603.0	n
530.0	n
532.0	b

7.11.3 Accumulator

The accumulator is used to keep numeric values and do statistical analysis on the accumulated data.

Field	Attribute Reference	Type	Content
Label *	.label	String	Label of the accumulator
Maximum Size	.maximumSize	Integer	Maximum number of data points can be added into the accumulator. If the number added exceeds the limit, the initial few data points will be overwritten.
Elements #	.elements	Integer	Data points added in the accumulator.
Size #	.size	Integer	Actual number of elements in the accumulator
Sum #	.sum	Number	Sum of all values
Maximum #	.maximum	Number	Maximum value on all added values

Minimum #	.minimum	Number	Minimum value on all added values
Mean #	.mean	Number	Mean value across all added values
Median #	.median	Number	Median value across all added values
Standard Deviation #	.stddev	Number	Standard Deviation for all added values
Standard Error #	.stderr	Number	Standard error value for all added values

The accumulator can be used as a handy tool for presenting a summary of participant's performance (RT calculation) at the end of the experiment. Suppose that we have a saccade trigger. Whenever the saccade trigger is fired, the triggered data is collected and the duration of each saccade can be added to the accumulator. At the end of the trial or at the end of the experiment, we can easily calculate the max, min, mean, etc. of the duration of all saccades. The following figure illustrates the experiment.

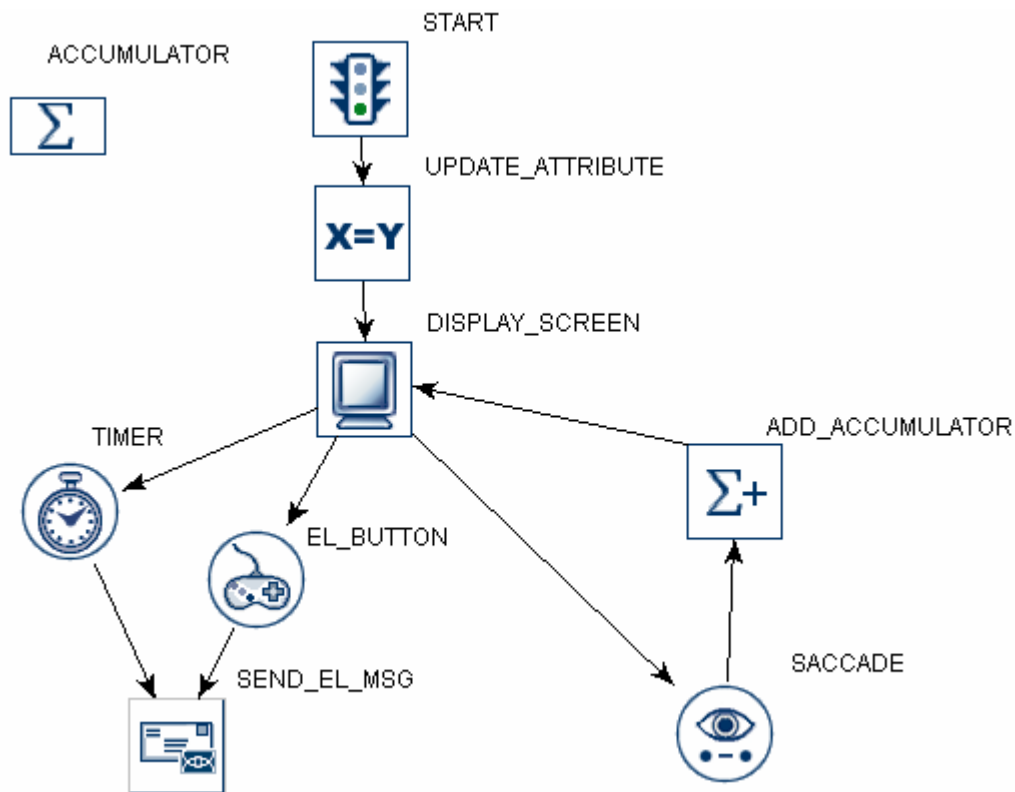

Figure 7-44. Using Accumulator

The user needs first to add one accumulator object into a graph and set the maximum data size for the accumulator (see Panel A of Figure 7-45). At the beginning of the sequence execution, the user may need to clear the data in the accumulator if it has been used previously. This is done by adding an “UPDATE_ATTRIBUTE” action and resetting the maximum data size for the accumulator (see Panel B of Figure 7-45). Note that the user can also reset the data points in an accumulator with the “RESET_NODE” action.

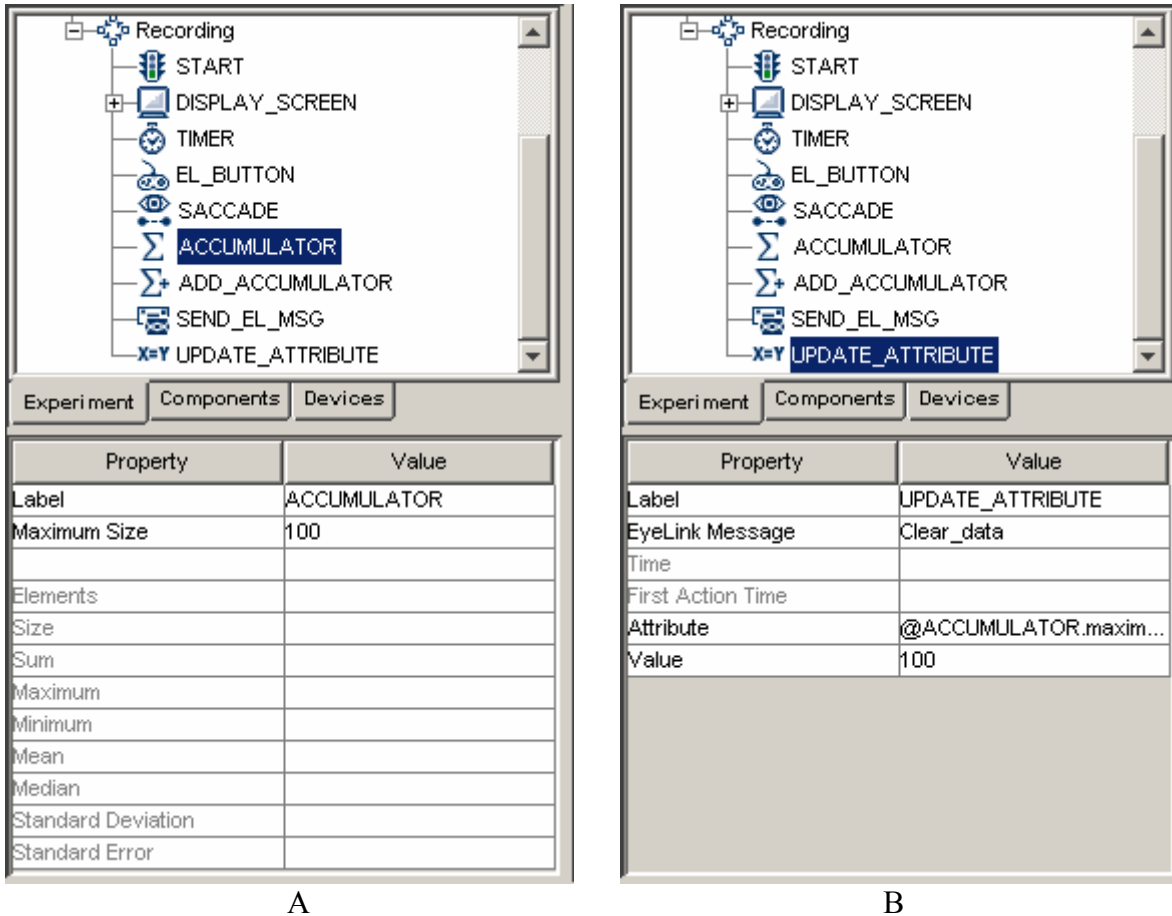

Figure 7-45. Setting the Properties of Accumulator

An Add-to-Accumulator action is added to the sequence to store saccade duration data. The user needs to specify the accumulator in which the data is stored and the data to be stored (see Panel A of Figure 7-46). Finally, at the end of the trial or experiment, the data can be retrieved. For example, if the user wants to know the number of saccades in the sequence and some basic statistics of saccade duration, a “SEND_EL_MSG” action can be used.

```
= "saccade data "+ str(@ACCUMULATOR.size@) + "max " + str(@ACCUMULATOR.maximum@)
+ " min " + str(@ACCUMULATOR.minimum@) + " mean " + str(@ACCUMULATOR.mean@)
```

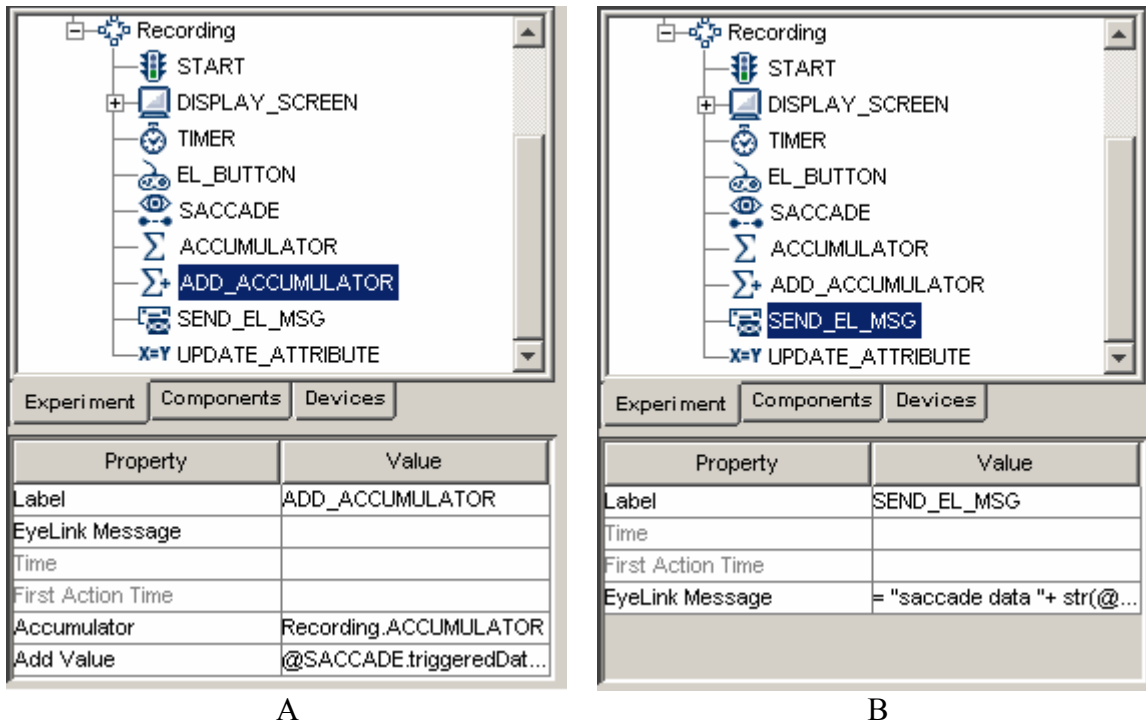

Figure 7-46. Adding Data to and Retrieving Data from the Accumulator

This will record a message similar to “MSG 3153136 saccade data 8 max 60.0 min 48.0 mean 55.0” in the EDF file.

7.11.4 Custom Class Instance

The custom class instance creates a new instance of a class. The user can select a class (defined in the Experiment Builder library) to which the current instance should belong from the dropdown list associated with the "custom class" property.

Once such a link is established, double clicking on the custom class instance in the experiment graph will automatically start a custom class editor for viewing and editing the source code of the custom class.

Field	Attribute Reference	Type	Content
Label *	.label	String	Label of the custom class instance. By default, the label is "CUSTOM_CLASS_INSTANCE".
Type #	NR		The type of Experiment Builder objects ("CustomClassInstance") the current node belongs to.
Node Path #	.absPath	String	The absolute path of the node in the experiment graph. Custom Class * NR . Select a class

			(defined in the Experiment Builder library) to which the current instance belongs.
--	--	--	--

Note: The property table will also list all of the methods and attributes defined in the custom class in alphabetical order.

8 Screen Builder

The Screen Builder provides a convenient tool for creating visual displays. After adding a Display Screen action in the workspace, the user can start the Screen Builder by double clicking it.

Screen Builder is a what-you-see-is-what-you-get (“WYSIWYG”) type of application, which allows the user to see how the display will actually look like during the runtime of the experiment. It behaves like a drawing board onto which various types of the graphic resources (images, text, or simple line drawings) can be added (see Figure 8-1). Once added, the exact properties of the resources can be further edited from the property panel. For example, for text presentation, the user can specify the position, font (name, size, or style), color, and alignment style of the text. For a dynamic display with moving object on the screen, the user can further specify the movement pattern of the graphic resources. Finally, auxiliary utilities (e.g., interest area, drawing grid) are provided for the ease of editing and data analysis.

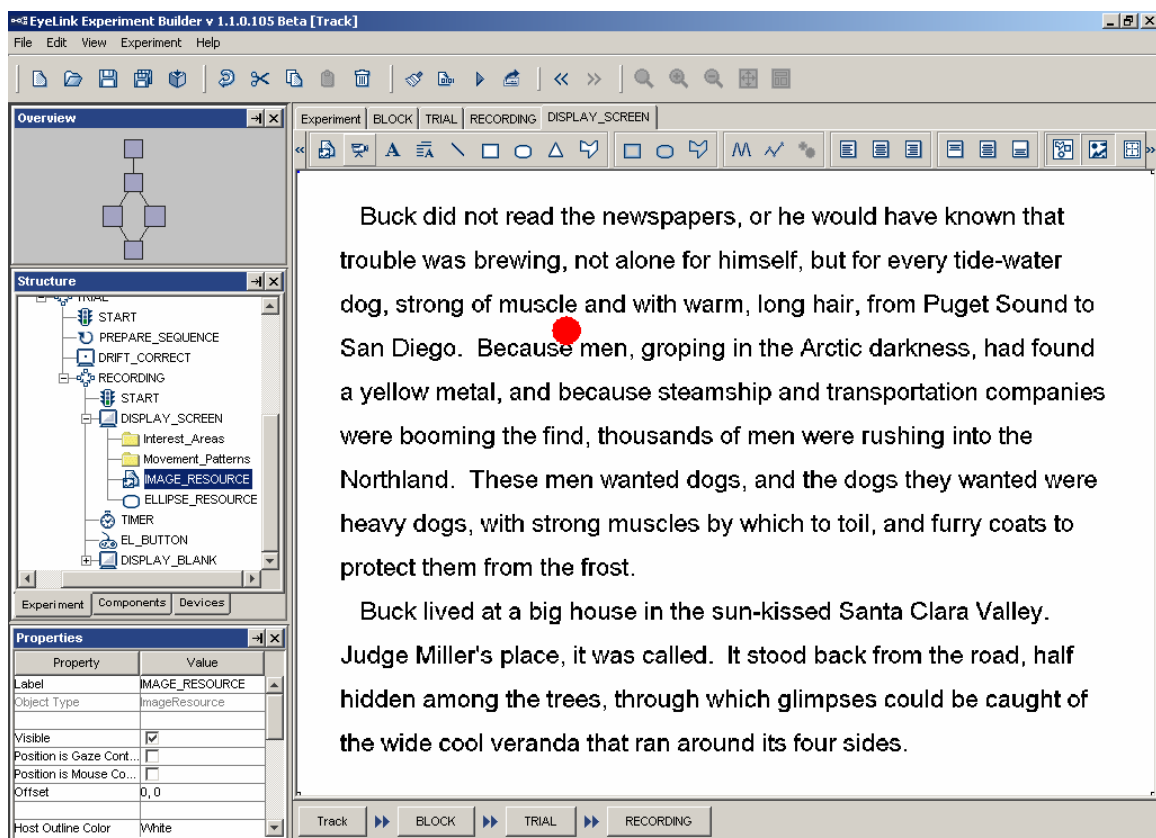

Figure 8-1. Sample View of the Screen Builder Interface

8.1 Resources

Resources are the individual graphic drawings (e.g., image, text, line, etc) to be displayed on the screen. Currently, the following list of resources can be added to a display screen: images, texts (single line or multiple lines), and simple drawings like rectangles, ellipses, lines, triangles, and polygons (see Figure 8-2).



Figure 8-2. Resources Implemented in Screen Builder

As for triggers and actions discussed in the previous chapter, the layout and properties of a selected resource can be easily modified by using the Property panel. In addition to the physical appearance of the resource (position, size, style, etc.), the user needs to keep in mind the following issues when reviewing the properties of a graphic resource:

- **Visibility:** After a resource is added to a screen, it can be either visible or invisible when the display is shown. This property is especially useful for those experiments in which similar displays are used except that one or several items are present or absent.
- **Position is Gaze or Mouse Contingent:** This is useful for those experiments in which the resource position is changed according to the current gaze or mouse position (see the GCWINDOW and TRACK examples) during recording. For an image resource, the clipping area can also be made gaze contingent (see the GCWINDOW example).
- **Movement Pattern:** The Experiment Builder supports both static and dynamic resource presentations. In the latter case, users can specify a movement pattern (sinusoidal or custom) for a resource (see the PURSUIT example). Note, if a movement pattern has been assigned to a resource, the position of the resource cannot be gaze- or mouse-contingent at the same time.
- **Interest Area:** For static resources, creating interest areas may make data analysis in the future easier. Interest areas can be generated either manually or with the auto segmentation feature of the Screen Builder.
- **Last but not least, two location types can be used in the Screen Builder: top-left or center.** In the top-left location type, the “Location” attribute of the resource refers to the top-left corner of the resource whereas in the center location type, the “Location” attribute of the resource refers to the center of the resource. The screen location type can be set from “Preferences → Screen → Location Type”.

The following sections describe the usage and properties of each resource type in detail.

8.1.1 Image Resource

In order to add an image resource onto a display screen, the user should first make sure that images are loaded into the Experiment Builder library. To add images into the image library, click on “Edit → Library Manager” from the application menu bar. This will bring up a “Library Manager” dialog box. Select the “Image” tab and click on the “Add” button to load in the desired image(s) (see Figure 8-3). The following image file formats is supported by the current version of Experiment Builder: .PNG, .TIF, .GIF, .JPG,

.BMP, and .PCX. Please note that the BMP files with 32 bit depth may not be displayed properly.

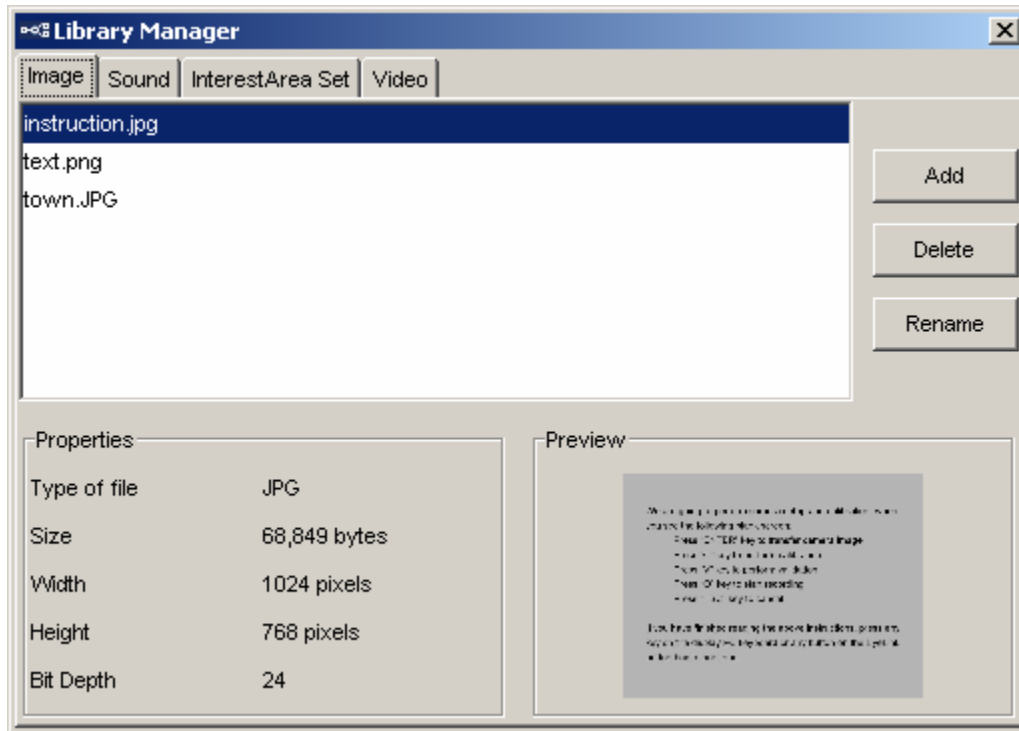



Figure 8-3. Loading Images into Image Library

To add an image resource onto a display screen, click on the “Insert Image Resource” button () on the Screen Builder toolbar, and then click anywhere in the screen workspace. When a “Select Image” dialog shows up, choose the desired image file. The image will now be displayed on the screen.

To adjust the position of the image resource, select the image by clicking left mouse button and keep holding down the mouse button while dragging the resource to the desired location. Release the mouse button when the image resource is at the desired location. The resource position can also be set from the value field of the “Location” property in the property panel.

Tip: The x, y coordinate of the current mouse cursor position will be displayed below the cursor if the mouse is left static for a couple of seconds in the Screen Builder workspace.

Field	Attribute Reference	Type	Content
Label *	.label	String	Label of the resource. The default label is “IMAGE_RESOURCE”.
Type #		NR	The type of screen resource (“ImageResource”) the current item belongs to.
Visible †	.visible	Boolean	Whether the resource should be visible. The default setting is True (box checked).

Screen Index	.screenIndex	NR	Index of the resource in screen resource list (0 - n).
Position is Gaze Contingent †	.positionAtGazeContingent	Boolean	Whether the position of the resource is contingent on the gaze position. The default setting is False. This setting can only be modified when the display screen is contained in a recording sequence.
Position is Mouse Contingent †	.positionAtMouseContingent	Boolean	Whether the position of the resource is contingent on the mouse position. The default setting is False.
Offset	.offset	Point	Adjustment of the resource position relative to the intended resource location, or the position of the current gaze or mouse, movement pattern. The default value is (0.00, 0.00) for a perfect alignment of the resource position with the current gaze or mouse position. For example, if the location field is set to (512, 384) and the offset is (100, 100). The actual resource position will be (612, 484).
Host Outline Color ¶	.hostOutlineColor	Color	The color of the box drawn on the host screen to show the position and dimension of the current resource. This property is available only if the “Use for Host Display” option of the containing display screen action is enabled and the “Draw to EyeLink Host” of the prepare sequence action is set to “Primitive”.
Screen Location Type		NR	Whether the location specified below refers to the top-left corner or center of the resource. This setting can be changed at “Screen Preferences”.
Location	.location	Point	The coordinate of the top-left corner or center of the resource. If the Offset is non-zero, the actual screen position where the resource is displayed will be the coordinate set in the .location field plus the offset adjustment.
Width	.width	Float	Intended width of the resource in screen pixels.
Height	.height	Float	Intended height of the resource in screen pixels.
Movement Pattern ¶ *	NR		Movement pattern (sinusoidal or custom) of the resource.
Prebuild to Image # †	.prebuildToImage	Boolean	Whether the resource should be built into an image when the experiment is built (instead of having it created during runtime). Uncheck this option only if you will need to come up with the image file name during runtime (e.g., by using a variable or an equation, instead of referring to a datasource column or using a static image file name).
Use Software Surface †	.useSoftwareSurface	Boolean	If false (unchecked), memory on the video card is used to hold the resource (bitting from the video card memory to the display surface is fast). If true (checked), the system memory is

			used to hold the resource (blitting is slow as it is done by copying from RAM to display surface).
Clipping Location	.clippingLocation	Point	The coordinate of the top-left corner of the clipping region.
Clipping Width	.clippingWidth	Float	Intended width (in pixels) of the clipping region of the resource. Only part of the image within clipping region will be shown.
Clipping Height	.clippingHeight	Float	Intended height (in pixels) of the clipping region of the resource.
Clipping Area is Gaze Contingent †	.clippingAreaAtGazeContingent	Boolean	Whether the clipping region should be contingent on the mouse or gaze position. The default setting is False.
Source File Name ¶	.sourceFileName	String	The name of the image file. Make sure that the file name does not contain space or non-ASCII characters. Note that the images must be first loaded into the resource library.
Use Original Size †	.useOriginalSize	Boolean	If set to true, this will display the image in original size; otherwise, the image may be stretched to the dimension set by “Width” and “Height” fields.

8.1.1.1 Image Displaying Modes

The image resource is flexible enough to accommodate various modes of displaying (e.g., original image size vs. stretched, top-left aligned or centered). The following discusses the option of displaying images in original size or stretching it to a specific dimension.

- 1) To display the image in original size, after the image is added to the display, the user should have “Use Original Size” field of the image checked. Please note that, enabling that field will also make several attributes read-only (“Width”, “Height”, “Clipping Location”, “Clipping Width”, “Clipping Height”, and “Clipping Area is Gaze Contingent”).
- 2) To stretch all images to a fixed width and height (1024 × 768 for example), after the image is added to the display, the user should first make sure that the “Use Original Size” field is unchecked. Check the values of “Width” and “Height” fields of sample image added and adjust them if necessary. In addition, the user may need to check the values of “Clipping Location”, “Clipping Width” and “Clipping Height” attributes, which are used to control the part of the image to be shown. By default, the clipping width and height are the same as the image width and height. Please note that the clipping location is always top-left based and the location is relative to the top-left corner of the image.
- 3) If images are stretched to different dimensions, the user should add two columns in the experiment data source to specify the desired image width and height. After the sample image is added to the display, the user should refer the *width*, *height*, *clip width*, and *clip height* of the image to the two columns created in the data source. See the “PICTURE” template for an example.

The user can also flexibly specify the alignment style of images. The read-only “Screen Location Type” attribute of the image resource indicates the current location coordinate type.

- 1) The easiest way of displaying an image in the center of the screen is to first set the “Location Type” of Screen preferences to “Center Position”. After the image is added to the display, the user can then click on horizontal center alignment and vertical center alignment () buttons on the Screen Editor toolbar. If the image is center aligned to a different position, enter the desired coordinate value in the Location field of the image.
- 2) If the top-left corner of all images is aligned to a specific location (x, y), the user should first set the screen location type preference to “TopLeft Position”. After the image is added to the screen, the user can then set the desired value in the Location field of the image.

Please note that the user should determine the screen type before working on any resources as changing the “Location Type” preference setting in the middle of the experiment generation may cause some undesired behaviors.

8.1.1.2 Gaze-Contingent Window Manipulations

To create a screen with gaze-contingent window manipulation, the user needs to add two full-screen images to the display screen, one as the “foreground” (the part of the image to be displayed in the window) and the other one as “background” (the part of the image to be displayed out side of the window). For the foreground image, the user should also make sure that the “Position is Gaze Contingent” and “Clipping Area is Gaze Contingent” boxes are checked. Please note that these two attributes will only be valid when the display screen is contained in a recording sequence; otherwise, they will be grayed out. The user should also set the “Clipping Width” and “Clipping Height” properties (in pixels) of the foreground image to specify the size of the central window. See the GCWindow template for an example.

It is easier to create a gaze-contingent display with “Center Position” screen location type. After adding each image to the screen, click the horizontal center alignment and vertical center alignment buttons to put the image in the center of the screen (see left panel of Figure 8-4). However, if the user wants to create such a display in a top-left screen coordinate, she/he should also set the “Offset” attribute of the foreground image to be half of the clipping area width and height (see right panel of Figure 8-4).

Property	Value	Property	Value
Label	IMAGE_Foreground	Label	IMAGE_Foreground
Visible	<input checked="" type="checkbox"/>	Visible	<input checked="" type="checkbox"/>
Position is Gaze Contingent	<input checked="" type="checkbox"/>	Position is Gaze Contingent	<input checked="" type="checkbox"/>
Position is Mouse Conting...	<input type="checkbox"/>	Position is Mouse Conting...	<input type="checkbox"/>
Offset	0, 0	Offset	150, 150
Screen Location Type	Center	Screen Location Type	TopLeft
Location	512, 384	Location	0, 0
Width	1024	Width	1024
Height	768	Height	768
Movement Pattern	None	Movement Pattern	None
Prebuild To Image	<input checked="" type="checkbox"/>	Prebuild To Image	<input checked="" type="checkbox"/>
Clipping Location	0, 0	Clipping Location	0, 0
Clipping Width	300	Clipping Width	300
Clipping Height	300	Clipping Height	300
Clipping Area is Gaze Con...	<input checked="" type="checkbox"/>	Clipping Area is Gaze Con...	<input checked="" type="checkbox"/>
Source File Name	Picture 008.jpg	Source File Name	Picture 008.jpg
Use Original Size	<input type="checkbox"/>	Use Original Size	<input type="checkbox"/>

A

B

Figure 8-4. Setting Different Location Types for Images Used in a Gaze-Contingent Window Application.

Finally, the order of the foreground and background images added to the display screen matters. The user must ensure that the foreground image is listed after the background image in the structure list so that the foreground image is drawn in front of the background image (see Section 8.4.5 on setting the order of resources).

8.1.2 Video Resource

The SR Research Experiment Builder supports video clip presentation by using video resources () on a display screen. The Experiment Builder uses a custom developed video display engine for video clip playback. The video display engine was specifically designed to allow access to the msec time that each frame of the video is displayed (the start of the first retrace that contained the frame data on the display). The video display engine also functions in Windows real-time mode. These features provide a timing advantage to researchers using video stimuli because the common timing pitfalls of display packages that use Windows DirectShow© for video presentation have been bypassed.

For optimal video playing performance, the recommended display PC configuration is a Pentium 4 processor with 2.0 Ghz or faster CPU, 512 MB or more RAM, 8× AGP or PCIx video card, and Windows XP Service Pack 2 installed. Experiment Builder supports video files that are compatible with the VFW (video for windows) specification or have been XVID encoded. Our internal tests have shown that XVID encoded files perform much better than VFW files.

To play video clips in Experiment Builder, the user should first convert the original .avi files into XVID or VFW files with the "Split Avi" application that comes with the Experiment Builder software. Following this, the converted XVID or VFW files can be added into the library manager and the target clips can be added into a display screen (Please do not attempt to load the original unconverted .avi files into the video library as this may not work). To add video clips into the resource library, click on "Edit -> Library Manager" from the application menu bar. This will bring up a "Library Manager" dialog box. Select the "Video" tab and click on the "Add" button to load in the desired video clips. To add a video resource onto a display screen, click on the "Insert Video Resource" button () on the Screen Builder toolbar, and then click anywhere in the screen workspace. When a "Select Video" dialog shows up, choose the desired video file. The first frame of the video will now be displayed on the screen.

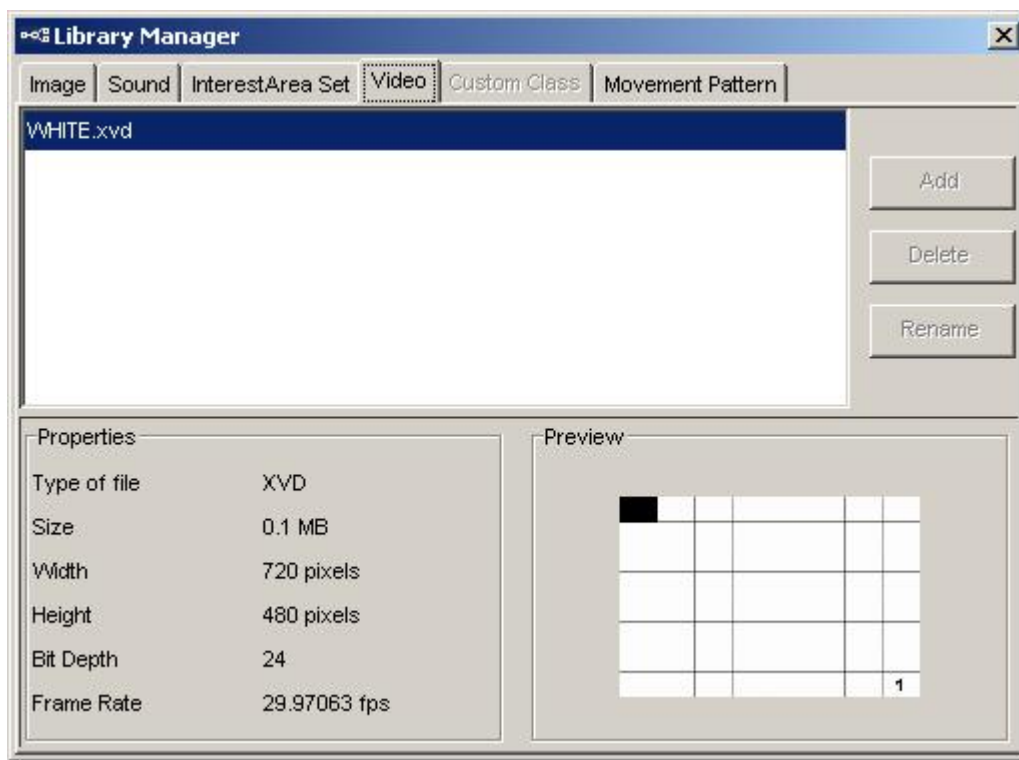

Figure 8-5. Loading Video Clips into Video Library

Field	Attribute Reference	Type	Content
Label *	.label	String	Label of the video resource. The default label is "VIDEO_RESOURCE".
Type #	NR		The type of screen resource ("VideoResource") the current item belongs to.
Visible †	.visible	Boolean	Whether the resource should be visible. The default setting is True (box checked).
Screen Index #	.screenIndex	Integer	Index of the resource in screen resource list (0 - n).
Position is Gaze	.positionAtGazeC	Boolean	Whether the position of the resource is

Contingent †	contingent	Boolean	contingent on the gaze position. The default setting is False. This setting is only available when the display screen is contained in a recording sequence.
Position is Mouse Contingent †	.positionAtMouseContingent	Boolean	Whether the position of the resource is contingent on the mouse position. The default setting is False.
Offset	.offset	Point	Adjustment of the resource position relative to the position of the current gaze or mouse position. The default value is (0.00, 0.00) for a perfect alignment of the resource position with the current gaze or mouse position.
Host Outline Color ¶	.hostOutlineColor	Color	The color of the box drawn on the host screen to show the position and dimension of the current resource. This property is available only if the “Use for Host Display” option of the containing display screen action is enabled and “Draw to EyeLink Host” of the prepare sequence action is set to “PRIMITIVE”.
Screen Location Type #	NR		Whether the location specified below refers to the top-left corner or center of the resource. This setting can be changed at “Screen Preferences”.
Location	.location	Point	The coordinate of the top-left corner or center of the resource. If the Offset is non-zero, the actual screen position where the resource is displayed will be the coordinate set in the .location field plus the .offset adjustment.
Width #	.width	Float	Width of the video stream (in pixels).
Height #	.height	Float	Height of the video stream (in pixels).
Movement Pattern ¶ *	NR		Movement pattern (sinusoidal or custom) of the resource.
Use Software Surface #	.useSoftwareSurface	Boolean	Always true for the video resources
Clipping Location	.clippingLocation	Point	The coordinate of the top-left corner of the clipping region.
Clipping Width	.clippingWidth	Float	Intended width (in pixels) of the clipping region of the resource. Only part of the video image within clipping region will be shown.
Clipping Height	.clippingHeight	Float	Intended height (in pixels) of the clipping region of the resource.
Clipping Area is Gaze Contingent †	.clippingAreaAtGazeContingent	Boolean	Whether the clipping region should be contingent on the mouse or gaze position. The default setting is False.
Play Count	.playCount	Integer	Total number of times the video clip will be played when the display screen is shown. If 0, the clip will be played continuously (looping).
Frame List	.frameList	List	XVID video clips: The intended frames of the video clip to be played. If set to [1--1] (i.e., from the first frame 1 to the last frame -1), the whole clip will be played. Since XVID does not

			<p>support frame seeking, the first value must be 1 whereas the end frame can be configured.</p> <p>VFW video clips: Specifies the frame list (frame number and/or ranges of frames) that should be played for the video. Ranges of frames and frame indexes can be in any order. For example, [1-50,52-100,99-50,50,50] would start to play frames 1 -50, skip frame 51, play frames 52-100, then play frames 99-50 (i.e. backwards), then hold frame 50 for 2 more frames. Note that the performance of presenting non-sequential frames or presenting frames in reverse order will be strongly influenced by the video codec used and the specifications of the display PC. Performance will generally be worse than when playing the video in the standard, first-to-last frame order.</p> <p>Changes from version 1.1: The "End Frame" property have been removed and replaced with the "Frame List" property.</p>
Source File Name ¶	.sourceFileName	String	The name of the video resource file. Note that the video resource must be first loaded into the resource library.
Frame Rate	.frameRate	Integer	Intended number of frames (default is 30.0) to be displayed each second (typically set to 30 frames per second for NTSC or 25 frames per second for PAL formatted video). The actual frame rate of the original video clip is displayed in the property fields of the video clip in the library manager (see the figure above). Please note that a frame rate higher than the screen refresh rate is not possible.
Is Playing #	.isPlaying	Boolean	Whether the video clip is playing. Returns 'True' if the clip playing is still in progress or 'False' if the playing has stopped or hasn't started yet.
Current Frame Number #	.currentFrameNumber	Integer	The currently processed frame number. This may not be the currently visible frame on the screen. This number increases by one for every frame presented.
Current Frame Index #	.currentFrameIndex	Integer	The currently processed frame number. This should be identical to "Current Frame Number" for a non-looping video. For video played in a looping mode, this reports the relative frame position in a clip (i.e., a number between 1 and last frame of the video clip).
Next Frame Number #	.nextFrameNumber	Integer	The index number of next frame to be flipped (shown).

Last Frame Number #	.lastFrameNumber	Integer	The last frame that has been flipped (actually shown on the screen).
Last Frame Time #	.lastFrameTime	Float	The time of the last frame that has been flipped (actually shown).
Next Frame Desired Time #	.nextFrameDesiredTime	Float	Predicted time when the next frame is shown on the screen.
Displayed Frame Count #	.displayedFrameCount	Integer	Reports the number of frames displayed (non-dropped frames).
Dropped Frame Count #	.droppedFrameCount	Integer	Reports the number of dropped frames.
FPS #	.FPS	Float	Frames per second calculated as (displayed frames/(duration played in msec/1000))
Duration #	.FPS	Float	Duration into clip playing. When the play ends, the duration may report as “.displayedFrameCount-1”/@self.frameRate@

8.1.2.1 Reading Frame Time

Experiment Builder can record the time of each frame in the EDF file. For example, if the user adds the following message to the message field of the display screen:

```
= "Display " + str(@self.VIDEO_RESOURCE.lastFrameNumber@) + "**CRT*" +
str(@self.VIDEO_RESOURCE.currentFrameNumber@)
```

The EDF will contain output like: MSG 8046616 -8 Display 30*CRT*31.

This shows that at the message time (8046616), the visible frame should be 30 (last frame number). Frame 31 appears at $8046616 + 8 = 8046624$ - this flip event also updates frame count and index number and associated frame time. After that flip, Experiment Builder processes frame number 32, and next frame to be flipped is frame 32, with the last flipped frame now set to 31.

8.1.2.2 Video Frame Timing

Experiment Builder decodes each frame of the video and attempts to present the frame at a desired time. The desired display time for a frame is calculated as:

```
desired_frame_time = video_start_time + (frameNumber * 1000.0 / frameRate)
```

where `video_start_time` is the millisecond time that the first frame of the video was presented, `frameNumber` is the number of the frame to be presented, and `frameRate` is the number of frames to display per second. For example, assume the first frame of a video was presented at time `T` and the frame rate of the video is 30 frames per second. The desired display time for frame 100 would therefore be $T + 3333.33$ msec.

However, the video frame will likely not be able to be presented at the exact time that is desired, and will instead have an actual display time that is slightly different than the

desired frame time. Two main factors can influence the offset between the desired and actual display time for a video frame:

Interaction between the display's retrace rate and the video's frame rate. Video frames can only be presented at intervals that are a multiple of the monitors retrace rate. If the display retrace rate and video frame rate are not evenly divisible, then the desired and actual frame display times can be offset by up to one display retrace rate.

Duration of decoding and displaying the video frame. If the computer hardware that you are running the video presentation on is not able to decode and display frames fast enough, there may be delays in the frame presentation. If the delay is greater than a frames duration (for example 33.33 msec for a 30 fps video), then a video frame can actually be dropped, increasing the drop frame count for the video resource.

8.1.2.3 Video Frame Rate and Display Retrace Rate

It is important to know how the nominal frame rate of the video file interacts with the monitor video refresh rate to determine the actual time point at which a frame is displayed. As described above a video frame's desired display time is equal to:

$$\text{desired_frame_time} = \text{video_start_time} + (\text{frameNumber} * 1000.0 / \text{frameRate})$$

The video frame's actual display time, assuming the display PC hardware is capable of presenting the video without dropping frames, can be conceptualized as:

$$\text{actual_frame_time} = \text{nearestRetraceTo}(\text{desired_frame_time})$$

where nearestRetraceTo calculates the display retrace start time that is closest to the desired_frame_time provided to the function.

Take the following figure for an example. If a video resource file has a nominal frame rate of 30 fps (one frame every 33.33 ms, blue bars) but the hardware video refresh rate is 85 hz (one refresh every 11.765 ms, green bars) then the two different update intervals are not multiples of each other. Assuming a video start time of 0, the second frame would have a desired display time of 33.33 ms, but the nearest retrace to the desired time is at time 35.29 msec (retrace rate * 3), which would be the actual time that the frame is displayed.

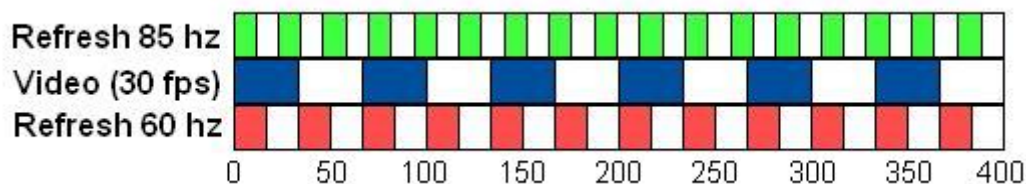

This implies that the best case is one in which the vertical refresh rate is an integer multiple of the frame rate. For practical purposes, that would mean a refresh rate of either

60 hz (see the red bars), 90hz, 120 hz, or 150 hz for a video clip playing at 30 frames per second. Moreover, it implies that refresh rates intermediate between integer multiples of the frame rate (75hz, for example) will cause increased variability in the offset between actual and desired video frame display times.

In reality, the retrace rate of a 60 hz or 120 hz monitor may be slightly off, for example it could be 60.01 hz. This means that even when you use a retrace rate that is a multiple of the frame rate, some small drift between actual and desired frame display times can occur during the course of the video presentation. This is handled by the video display engine by displaying a video frame for a duration less than the full frame duration whenever this small drift between the actual and desired frame display times approaches one display retrace in duration, correcting or resetting the drift.

8.1.2.4 Dropping Frames

The term "dropping frames" refers to the situation where a frame, or a set of frames, were not displayed on the screen. There are several detailed possibilities as to why a frames may be dropped, however they all converge on the higher level reason of the display PC's hardware not being able to keep up with the requested frame rate for the video resource in question. If a display PC is used that meets the specifications we suggest for video presentation, dropped frames should not occur for normal video playback scenarios.

The Experiment Builder decides to drop a frame if the actual frame display time for that frame is estimated to be equal to or greater than the desired display time of the next upcoming frame. If the video playback performance is very poor, this may result in several frames being dropped in a row.

If a frame is dropped, the "Dropped Frame Count" is increased in the video resource object. Furthermore, a warning message is printed to the console and to the warnings.log file indicating a frame was dropped and what the index of that frame was. You can also detect dropped frames by looking at the display screen messages that are saved as a video is being played. If a frame is dropped, no frame display message will be written to the data file, so a discontinuity will be present in the message stream.

8.1.2.5 Frame Caching

To help ensure smooth video presentation, Experiment Builder caches a certain number of video frames in memory. By decoding n frames in advance, the application does not have to wait for the decoding of the next frame before it can be displayed on screen. By decoding frames ahead of time dropping frames becomes less likely.

The maximum number of frames that are cached for each video resource can be changed; go the Display Device to set the desired value of the "Video Frame Cache Size". This should be a value between 5 and 60. Unless there is a specific reason to change the default frame cache size, we suggest that you do not change the frame cache value.

A large frame cache size results in a larger amount of system memory use. This can cause a longer initial preparation time for the video resources, increasing the PrepareSequence

actions duration. A larger frame cache size and increased system memory usage can also cause the overall system performance to degrade if there is not enough physical RAM to hold the frame caches.

8.1.2.6 Video Codec

Experiment Builder supports playing video files that are compatible with VFW (video for windows) and XVID encoded files. In each experiment, the user can load either VFM or XVID video files into the library manager, but not both.

It is important to note that the video quality and playback performance will vary depending on the codec used to compress the video files. Our internal tests have shown that XVID video files perform much better than VFW avi files as the XVID loader runs faster than the VFW loaders.

To play XVID encoded files, the user should convert the original video files with the accompanying Split AVI tool with the video compressor set to "Xvid MPEG-4 codec" (see "Video Experiments" in the html version of this document).

Please note that the "Xvid MPEG-4 codec" is not installed by default. To install the XVID codec, go to the directory where the Experiment Builder software is installed, e.g., "C:\Program Files\SR Research\Experiment Builder". Select the xvid.inf file in the "VideoHandlers" folder and click the right mouse button to bring up a popup menu. Select "Install" option. Click "Yes" button in the following "Digital Signature Not Found" dialog box to continue the installation. This only needs to be done once on a given display computer.

To play VFW video clips, choose other video codecs from the Split AVI compressor list - it is a known issue that the not all VFW files are recognized and loadable into the library. In addition, the performance of video files converted by different video codecs varies. Users may try the Divx (<http://www.divx.com/divx/play/download/>) or MCMP/Mjpeg codecs (<http://www.leadcodecs.com/Codecs/LEAD-MCMP-MJPEG.htm>) for VFW codecs with good performance.

If the user deploys the experiment project and runs it on a different deployment computer, please make sure that codec used to test run the video experiment is also installed on the deployment computer as well; otherwise, the deployed experiment will not run. Please also note that it is a known issue that the AVI converter may drop the last frame during conversion when using the XVID encoder. Therefore, the user may add one extra frame to each clip when authorizing video clips. The user can then set the "Frame List" attribute of the video resource to the intended frame number, regardless whether the last frame is dropped or not.

8.1.2.7 Playing Video Clips with Audio

For those video clips with sound, the "Split Avi" program splits the video stream from the audio stream in the original video file and saves each stream in a separate file. Now the user has two files, one for sound and one for video. To put the sound back into the video

so that the video will have sound during the experiment, the user needs to use a DISPLAY_SCREEN action to show the video stream and a PLAY_SOUND action to play back the audio stream.

To synchronize the playing of the video and audio streams, we recommend the user to use the ASIO driver (click the "Devices" Tab of the structure panel and select the "Audio Device") to play the audio file. To use the ASIO driver, please follow the instructions on installing and configuring the ASIO card and driver available. Once the ASIO driver has been selected, double click on the Display Screen action which is used to show the video and enable the "Synchronize Audio" Option. This will let you select a .wav file from the library manager to play with the video and set the "Sound Offset" to 0 for well synchronized audio and video playback.

If exact audio/video synchronization is not critical to your experiment, or you do not have an ASIO sound card on your display PC, you can also always use a separate Play_Sound action right before the Display_Screen action that displays the video, and have the PlaySound action play the associated .wav file for the video clip. This method will work with any audio card when the Audio device is in DirectX driver mode, but will not give you exact synchronization between the audio and video..

8.1.3 Text Resource

To add a text resource onto a display screen, click on the "Insert Text Resource" button (A) on the Screen Builder toolbar and click at the desired position in the workspace where the text resource will be placed.

To edit the text, double click on the resource. A text-editing caret will appear and the user can type in text from there. Text editing can also be done from the value field of the "Text" property in the property panel. Users can either enter the text in the text editor or click the button on the right end of the value field to bring up an attribute editor dialog box. Various aspects of text appearance can be modified, including color, font name, style, and size.

Field	Attribute Reference	Type	Content
Label *	.label	String	Label of the resource ("TEXT_RESOURCE" by default).
Type #	NR		The type of screen resource ("TextResource") the current item belongs to.
Visible †	.visible	Boolean	Whether the resource should be visible (True by default).
Screen Index #	.screenIndex	Integer	Index of the resource in screen resource list (0 - n).
Position is Gaze Contingent †	.positionAtGazeContingent	Boolean	Whether the position of the resource is contingent on the gaze position (False by default). This setting can only be modified when the display screen is contained in a recording sequence.

Position is Mouse Contingent †	.positionAtMouseContingent	Boolean	Whether the position of the resource is contingent on the mouse position (False by default).
Offset	.offset	Point	Adjustment of the resource position relative to the position of the current gaze or mouse position (0.00, 0.00 by default).
Host Outline Color ¶	.hostOutlineColor	Color	The color of the box drawn on the host screen to show the position and dimension of the current resource. This property is available only if the “Use for Host Display” option of the containing display screen action is enabled.
Screen Location Type #	NR		Whether the location specified below refers to the top-left corner or center of the resource. This setting can be changed at “Screen Preferences”.
Location	.location	Point	The coordinate of the top-left corner or center of the resource.
Width #	.width	Float	Intended width of the resource (in pixels).
Height #	.height	Float	Intended height of the resource (in pixels).
Movement Pattern ¶ *	NR		Movement pattern (sinusoidal or custom) of the resource
Prebuild to Image †	.prebuildToImage	Boolean	Whether the resource should be built into an image when the experiment is built (instead of having it created during the actual execution of the trial). This field is always true when the screen is contained in a recording sequence. IMPORTANT: If this attribute is False, the run-time drawing may not look exactly as it does in the screen editor.
Use Software Surface †	.useSoftwareSurface	Boolean	If false (unchecked), memory on the video card is used to hold the resource (bitting from the video card memory to the display surface is fast). If true (checked), the system memory is used to hold the resource (bitting is slow as it is done by copying from RAM to display surface).
Font Color	.fontColor	Color	Color in which the text is drawn. The default color is Black (0, 0, 0).
Font Name ¶	.fontName	String	String that specifies the typeface name of the font. Font Name can be selected from a dropdown list. The default font is "Times New Roman". When transferring project from one computer to another, please ensure the target computer has this font available.
Font Style ¶	.fontStyle	String	Sets whether the text is to be rendered using a normal, italic, or bold face.
Font Size	.fontSize	Integer	Sets the desired font size (20 by default)
Underline †	.underline	Boolean	Specifies an underlined font if set to True.
Text	.text	String	Text to appear in screen.
Use Runtime	.useRuntimeIAS	Boolean	If enabled, an Interest Area set file will be

Word Segment Interest Area * †		n	created during runtime to contain segment information for individual words in the text.
--------------------------------	--	---	---

8.1.3.1 Non-ASCII characters

If the user intends to use a character that does not fit in the ASCII encoding range (1-127), please make sure that the “Encode Files as UTF8” box of the Build/Deploy Preference settings is checked (see Figure 8-6). In another word, that field should be enabled if the user is using characters that are non-English (eg. à,è,ù,ç) or even special curved quotes, and obviously any non-European language characters (e.g., Chinese characters). In addition, please make sure that the right font for the text is chosen before entering any text.

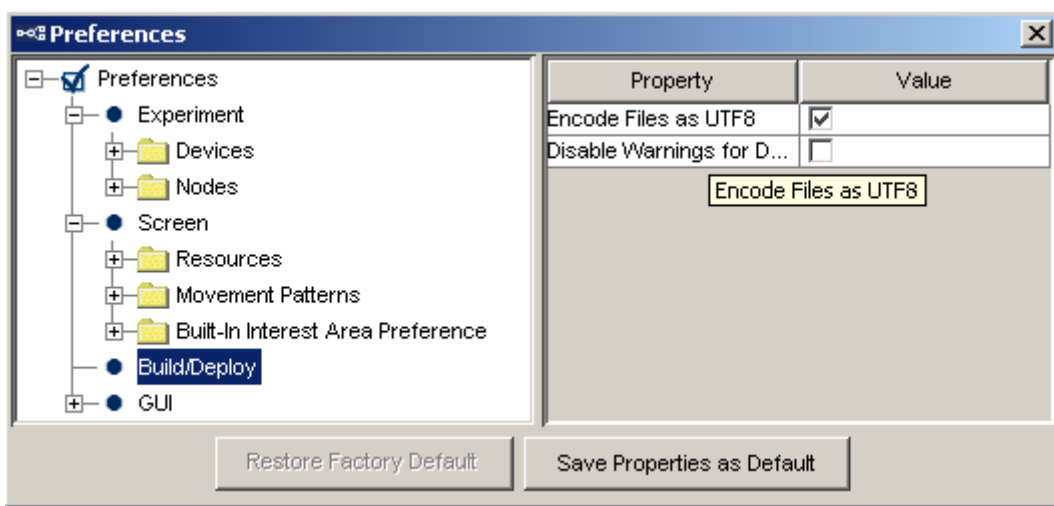

Figure 8-6. Setting UTF-8 Encoding.

8.1.3.2 Anti-aliasing and Transparency

Anti-aliasing is one of the most important techniques in making graphics and text easy to read and pleasing to the eye on-screen. Take the texts in Figure 8-7 for example. Panel A shows an aliased letter, in which all of the curves and line drawing appear coarse whereas Panel C shows an anti-aliased letter, which looks smooth. Anti-aliasing is done by substituting shades of grey (Panel D) around the lines which would otherwise be broken across a pixel (Panel B).

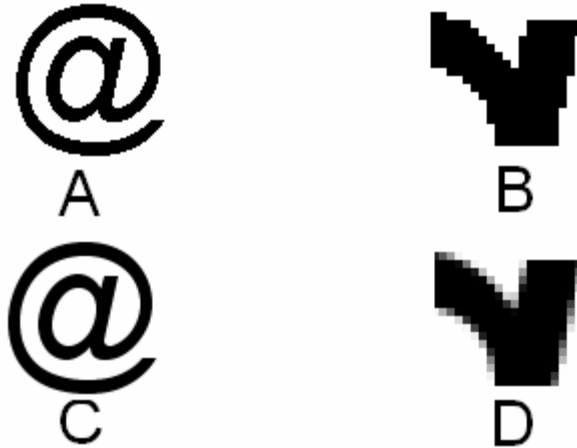

Figure 8-7. Aliased and Anti-aliased Texts

To apply anti-aliasing, the user should first check for the Experiment Builder preference settings. Click Edit -> Preferences. Click on “Screen” node and make sure that the “Anti-aliasing Drawing” box is checked (see Figure 8-8).

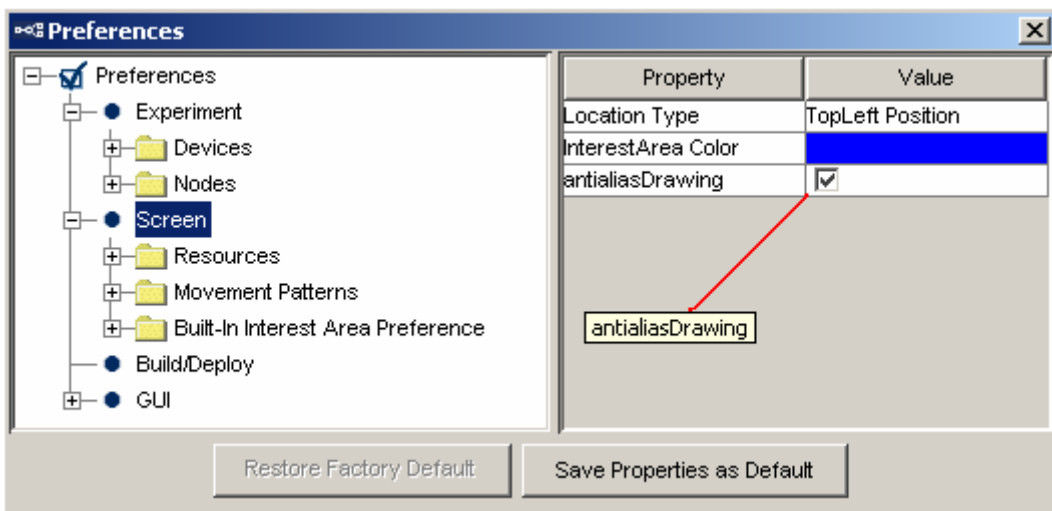

Figure 8-8. Antialiasing Drawing Preference Setting.

In addition, anti-aliasing works well in a uniform background. The user should set the Transparency color of the Experiment close to (but not identical to the background color) in the display. For example (see Figure 8-9), to show black (0, 0, 0) text over white (255, 255, 255) background, the user may set the transparency color to something close to white, for example, (251, 250, 251). Important! Never set the transparency color the same as the display background color – this will cause the display drawn improperly.

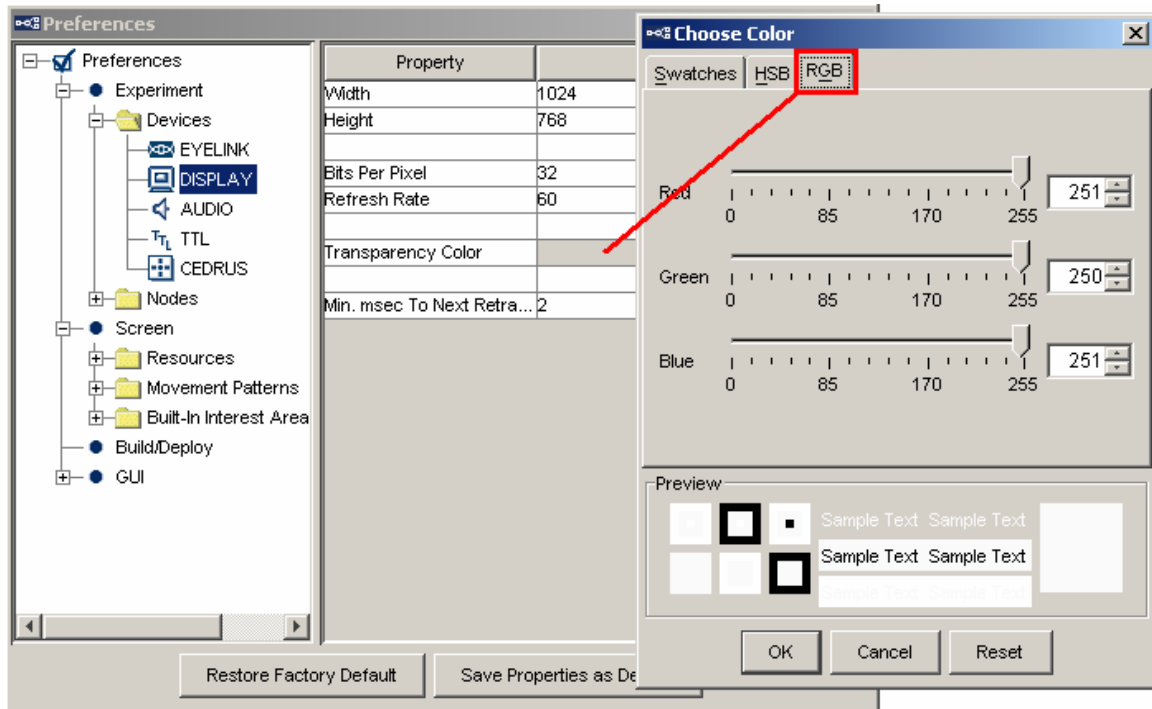

Figure 8-9. Setting the Transparency Color for the Experiment

Generally speaking, anti-aliasing should be applied when using text, multi-line text resources, line, ellipse, and freeform screen resources. The following sample experiments use the anti-aliasing in the resource drawing: Simple, Stroop, TextPage, TextLine, Saccade, and Pursuit.

8.1.4 Multiline Text Resource

The above mentioned text resource allows the user to add one line of text on the screen. To show a full page of text, the user may use the multiline text resource by clicking on the “Insert Multi Line Text Resource” button (EA) on the Screen Builder toolbar and clicking anywhere in the workspace. Only one multiline text resource can be added to each display screen.

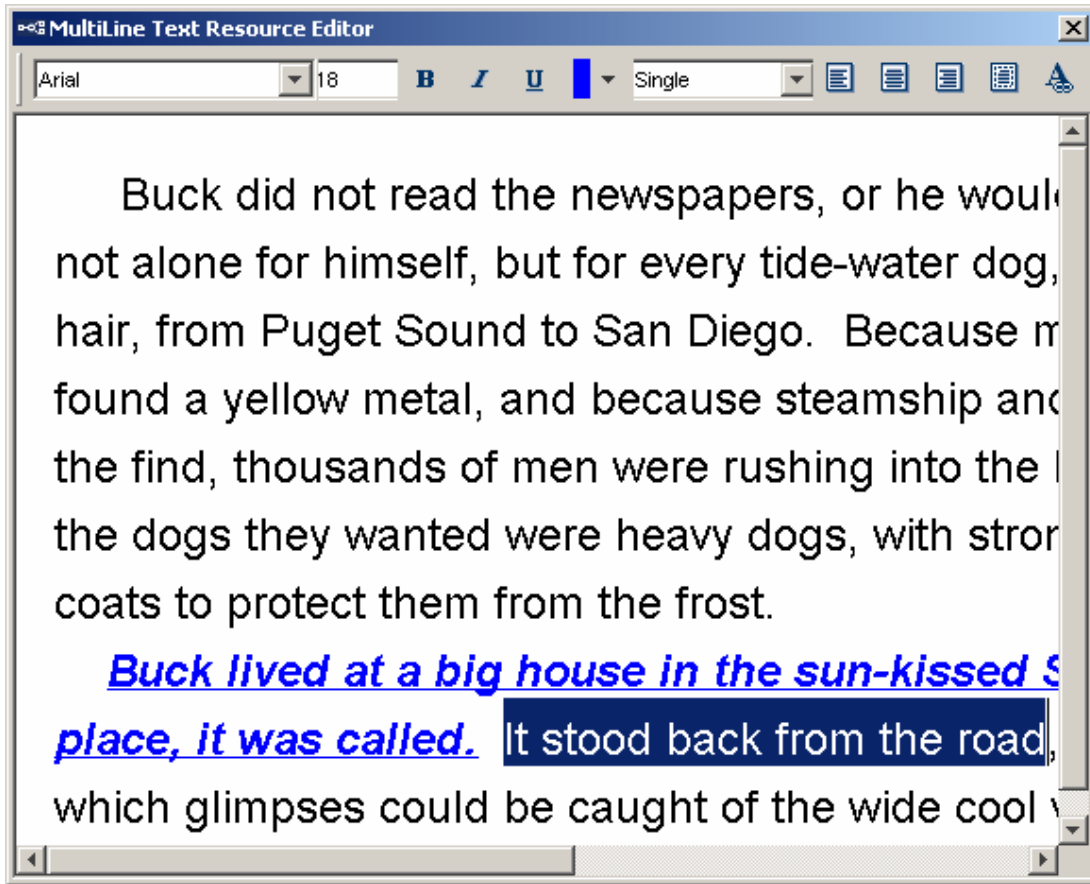

Figure 8-10. Multiline Text Editor.

After a multiline resource is added to the screen, clicking anywhere at the work space will bring up the multiline resource editor (see Figure 8-10). The user can type in text in the editor, or paste text from text files using shortcut keys CTRL + V. Buttons on the toolbar of the text editor allow the user to modify the appearance of text entered. This includes text font, font size, text style (bold, underline, italic), color, line space, alignment style, margin of the text. Note that the user may first set the right text appearance (especially the font) before entering text. If the text has already been entered, the user may select all (by pressing shortcut keys CTRL + A) or part of the text entered before using the toolbar to change text appearance.

The following table lists the properties of a multiline text resource.

Field	Attribute Reference	Type	Content
Label *	.label	String	Label of the resource ("MULTILINE_TEXT_RESOURCE" by default).
Type #	NR		The type of screen resource ("MultiLineTextResource") the current item belongs to.
Visible †	.visible	Boolea	Whether the resource should be visible (True by

		n	default).
Screen Index	.screenIndex	Integer	Index of the resource in screen resource list (0 - n).
Position is Gaze Contingent †	.positionAtGazeContingent	Boolean	Whether the position of the resource is contingent on the gaze position (False by default). This setting can only be modified when the display screen is contained in a recording sequence.
Position is Mouse Contingent †	.positionAtMouseContingent	Boolean	Whether the position of the resource is contingent on the mouse position (False by default).
Offset	.offset	Point	Adjustment of the resource position relative to the position of the current gaze or mouse position (0.00, 0.00 by default).
Host Outline Color ¶	.hostOutlineColor	Color	The color of the box drawn on the host screen to show the position and dimension of the current resource. This property is available only if the “Use for Host Display” option of the containing display screen action is enabled.
Screen Location Type #	NR		Whether the location specified below refers to the top-left corner or center of the resource. This setting can be changed at “Screen Preferences”.
Location #	.location	Point	The coordinate of the top-left corner or center of the resource. Always (0, 0) for top-left screen coordinate and center of screen in the center-position coordinate type.
Width #	.width	Float	Width of the resource (screen width).
Height #	.height	Float	Height of the resource (screen height).
Prebuild to Image # †	.prebuildToImage	Boolean	Always True
Use Software Surface †	.useSoftwareSurface	Boolean	If false (unchecked), memory on the video card is used to hold the resource (blitting from the video card memory to the display surface is fast). If true (checked), the system memory is used to hold the resource (blitting is slow as it is done by copying from RAM to display surface).
Use Runtime Word Segment InterestArea * †	.useRuntimeIAS	Boolean	If enabled, an Interest Area set file will be created during runtime to contain segment information for individual words in the text.

If the user intends to use a character that does not fit in the ASCII encoding range (1-127), please make sure that the “Encode Files as UTF8” box of the General Preference settings is checked.

8.1.5 Line Resource

Line resource creates a line drawing on the screen. Click on the “Draw Line Resource” button () on the toolbar to select the line resource type. Place the mouse cursor at the desired line start location in the work space, click down the left mouse button, keep dragging the mouse cursor until it reaches the desired end location, and then release the

mouse button. The precise location of the line resource can be edited in the property panel. Select the “Start Point” and “End Point” attributes and enter the desired positions in tuples (i.e., two float numbers separated by a comma). The appearance (color and width) of the line resource can also be modified.

Field	Attribute Reference	Type	Content
Label *	.label	String	Label of the resource (“LINE_RESOURCE” by default).
Type #	NR		The type of screen resource ("LineResource") the current item belongs to.
Visible †	.visible	Boolean	Whether the resource should be visible. The default setting is True.
Position is Gaze Contingent †	.positionAtGazeContingent	Boolean	Whether the position of the resource is contingent on the gaze position. The default setting is False. This setting can only be modified when the display screen is contained in a recording sequence.
Position is Mouse Contingent †	.positionAtMouseContingent	Boolean	Whether the position of the resource is contingent on the mouse position. The default setting is False.
Offset	.offset	Point	Adjustment of the resource position relative to the position of the current gaze or mouse position. The default value is (0.00, 0.00) for a perfect alignment of the resource position with the current gaze or mouse position.
Host Outline Color ¶	.hostOutlineColor	Color	The color of the box drawn on the host screen to show the position and dimension of the current resource. This property is available only if the “Use for Host Display” option of the containing display screen action is enabled.
Screen Location Type	NR		Whether the location specified below refers to the top-left corner or center of the resource. This setting can be changed at “Screen Preferences”
Location	.location	Point	The coordinate of the top-left corner or center of the resource.
Width #	.width	Float	Intended width (in pixels) of the resource.
Height #	.height	Float	Intended height (in pixels) of the resource.
Movement Pattern ¶ *	NR		Movement pattern (sinusoidal or custom) of the resource
Prebuild to Image †	.prebuildToImage	Boolean	Whether the resource should be built into an image when the experiment is built (instead of having it created during runtime). This field is always true when the screen is contained in a recording sequence. IMPORTANT: If this attribute is False, the run-time drawing may not look exactly as it does in the screen editor. In addition, images will not be saved to support Data Viewer

			overlay.
Use Software Surface †	.useSoftwareSurface	Boolean	If false (unchecked), memory on the video card is used to hold the resource (blitting from the video card memory to the display surface is fast). If true (checked), the system memory is used to hold the resource (blitting is slow as it is done by copying from RAM to display surface).
Color	.color	Color	Color in which the line is drawn. The default color is medium gray (128, 128, 128).
Stroke Width	.strokeWidth	Integer	Specifies the width (1 pixel by default) of the pen.
Start Point	.startPoint	Point	(x, y) coordinate of the starting point of the line.
End Point	.endPoint	Point	(x, y) coordinate of the ending point of the line.

8.1.6 Rectangle Resource

Rectangle resource creates a filled or framed rectangle on the screen. Click on the “Draw Rectangle Resource” button () on the toolbar to select the resource type. Place the mouse cursor on the location intended for the top-left corner of the rectangle, then click down the left mouse button, and drag the mouse to the desired location for the bottom-right corner of the rectangle resource, and then release the mouse button. The precise location of the resource can be edited in the property panel (the “Location”, “Width”, and “Height” attributes). The appearance (frame color, frame line width, interior color) of the rectangle resource can also be adjusted. If “Filled” property is set to true, the interior of the rectangle will be filled with the filling color; otherwise, only the frames of the rectangle will be drawn and the setting of filling color will be ignored.

Field	Attribute Reference	Type	Content
Label *	.label	String	Label of the resource. The default value is “RECTANGLE_RESOURCE”.
Type	NR		The type of screen resource ("RectangleResource") the current item belongs to.
Visible †	.visible	Boolean	Whether the resource should be visible. The default setting is True.
Screen Index #	.screenIndex	Integer	Index of the resource in screen resource list (0 - n).
Position is Gaze Contingent †	.positionAtGazeContingent	Boolean	Whether the position of the resource is contingent on the gaze position. The default setting is False. This setting can only be modified when the display screen is contained in a recording sequence.
Position is Mouse Contingent †	.positionAtMouseContingent	Boolean	Whether the position of the resource is contingent on the mouse position. The default setting is False.
Offset	.offset	Point	Adjustment of the resource position relative to the position of the current gaze or mouse position. The default offset is (0.00, 0.00).

Host Outline Color ¶¶	.hostOutlineColor	Color	The color of the box drawn on the host screen to show the position and dimension of the current resource. This property is available only if the “Use for Host Display” option of the containing display screen action is enabled.
Screen Location Type #	NR		Whether the location specified below refers to the top-left corner or center of the resource. This setting can be changed at Screen Preferences
Location	.location	Point	The coordinate of the top-left corner or center of the resource.
Width	.width	Float	Width of the resource (in pixels).
Height	.height	Float	Height of the resource (in pixels).
Movement Pattern ¶¶ *	NR		Movement pattern (sinusoidal or custom) of the resource.
Prebuild to Image †	.prebuildToImage	Boolean	Whether the resource should be built into an image when the experiment is built (instead of having it created during run time). This field is always true when the screen is contained in a recording sequence. IMPORTANT: If this attribute is False, the run-time drawing may not look exactly as it does in the screen editor.
Use Software Surface †	.useSoftwareSurface	Boolean	If false (unchecked), memory on the video card is used to hold the resource (blitting from the video card memory to the display surface is fast). If true (checked), the system memory is used to hold the resource (blitting is slow as it is done by copying from RAM to display surface).
Color	.color	Color	Color in which the outline of the resource is drawn. The default color is medium gray (128, 128, 128).
Filled †	.filled	Boolean	Whether the interior of the resource should be filled. The default setting is True.
Fill Color	.fillColor	Color	Color in which the interior of the resource is filled. The default color is medium gray (128, 128, 128).
Stroke Width	.strokeWidth	Integer	Specifies the width (1 by default) of the pen in pixels.

8.1.7 Ellipse Resource

Similar to the preceding rectangle resource, clicking on the ‘Draw Ellipse Resource’ tool button () creates a filled or framed ellipse bound by a rectangle defined by the “Location”, “Width”, and “Height” properties of the resource. Follow the same steps as in the previous section to create an ellipse resource and to modify its appearance.

Field	Attribute Reference	Type	Content
Label *	.label	String	Label of the resource. The default value is

			“ELLIPSE_RESOURCE”.
Type	NR		The type of screen resource ("EllipseResource") the current item belongs to.
Visible †	.visible	Boolean	Whether the resource should be visible. The default setting is True.
Screen Index	.ScreenIndex	Integer	Index of the resource in screen resource list (0 - n).
Position is Gaze Contingent †	.positionAtGazeContingent	Boolean	Whether the position of the resource is contingent on the gaze position. The default setting is False. This setting can only be modified when the display screen is contained in a recording sequence.
Position is Mouse Contingent †	.positionAtMouseContingent	Boolean	Whether the position of the resource is contingent on the mouse position. The default setting is False.
Offset	.offset	Point	Adjustment of the resource position relative to the position of the current gaze or mouse position. The default offset is (0.00, 0.00).
Host Outline Color ¶	.hostOutlineColor	Color	The color of the box drawn on the host screen to show the position and dimension of the current resource. This property is available only if the “Use for Host Display” option of the containing display screen action is enabled.
Screen Location Type	NR		Whether the location specified below refers to the top-left corner or center of the resource. This setting can be changed at “Screen Preferences”.
Location	.location	Point	The coordinate of the top-left corner or center of the resource.
Width	.width	Float	Width of the resource in screen pixels.
Height	.height	Float	Height of the resource in screen pixels.
Movement Pattern ¶ *	NR		Movement pattern (sinusoidal or custom) of the resource.
Prebuild to Image # †	.prebuildToImage	Boolean	Whether the resource should be built into an image when the experiment is built (instead of having it created during the actual execution of the trial). This field is always true when the screen is contained in a recording sequence. IMPORTANT: If this attribute is False, the run-time drawing may not look exactly as it does in the screen editor.
Use Software Surface †	.useSoftwareSurface	Boolean	If false (unchecked), memory on the video card is used to hold the resource (bitting from the video card memory to the display surface is fast). If true (checked), the system memory is used to hold the resource (bitting is slow as it is done by copying from RAM to display surface).
Color	.color	Color	Color in which the outline is drawn. The default color is medium gray (128, 128, 128).

Filled †	.filled	Boolean	Whether the interior of the resource should be filled. If not, this just draws a framed ellipse. This is True by default.
Fill Color	.fillColor	Color	Color in which the interior of the ellipse is filled. The default color is medium gray (128, 128, 128).
Stroke Width	.strokeWidth	Integer	Specifies the width (1 by default) of the pen in pixels.

8.1.8 Triangle Resource

The triangle resource can be used to create an isosceles triangle (to create other types of triangle, use the freeform resource instead). To create a triangle resource on the screen, click on the “Draw Triangle Resource” button () on the toolbar. Place the mouse cursor in the screen builder workspace, click down the left mouse button and drag the mouse cursor to the desired location for the bottom-right corner of the triangle resource, and then release the mouse button.

To adjust the location of the triangle resource, select the resource by clicking on it, hold down the left mouse button, and drag the resource until it is placed at the desired location. The exact location of the resource can also be set from the value field of the “Location” property. To adjust the height and width of the triangle, select the resource and move the cursor to one of the three vertices until the shape of the mouse cursor changes to one of the resizing cursors (e.g., ). Hold down the left mouse button and drag the vertex until it is placed at the desired location. The appearance (frame color, frame line width, interior color) of the triangle resource can also be adjusted. If “Filled” property is set to true, the interior of the triangle will be filled with the filling color; otherwise, only the frames of the triangle will be drawn while the filling color will be ignored.

Field	Attribute Reference	Type	Content
Label *	.label	String	Label of the resource. The default label is “TRIANGLE_RESOURCE”.
Type	NR		The type of screen resource (“TriangleResource”) the current item belongs to.
Visible †	.visible	Boolean	Whether the resource should be visible. This is True by default.
Screen Index #	.screenIndex	Integer	Index of the resource in screen resource list (0 - n).
Position is Gaze Contingent †	.positionAtGazeContingent	Boolean	Whether the position of the resource is contingent on the gaze position. This is False by default. This setting can only be modified when the display screen is contained in a recording sequence.
Position is Mouse Contingent †	.positionAtMouseContingent	Boolean	Whether the position of the resource is contingent on the mouse position. This is False by default.

Offset	.offset	Point	Adjustment of the resource position relative to the position of the current gaze or mouse position. The default offset is (0.00, 0.00).
Host Outline Color ¶	.hostOutlineColor	Color	The color of the box drawn on the host screen to show the position and dimension of the current resource. This property is available only if the “Use for Host Display” option of the containing display screen action is enabled.
Screen Location Type #	NR		Whether the location specified below refers to the top-left corner or center of the resource. This setting can be changed at “Screen Preferences”.
Location	.location	Point	The coordinate of the top-left corner or center of the resource.
Width #	.width	Float	Width of the resource in pixels.
Height #	.height	Float	Height of the resource in pixels.
Movement Pattern ¶ *	NR		Movement pattern (sinusoidal or custom) of the resource.
Prebuild to Image #	.prebuildToImage	Boolean	Whether the resource should be built into an image when the experiment is built (instead of having it created during the actual execution of the trial). This field is always true when the screen is contained in a recording sequence. IMPORTANT: If this attribute is False, the run-time drawing may not look exactly as it does in the screen editor.
Use Software Surface †	.useSoftwareSurface	Boolean	If false (unchecked), memory on the video card is used to hold the resource (blitting from the video card memory to the display surface is fast). If true (checked), the system memory is used to hold the resource (blitting is slow as it is done by copying from RAM to display surface).
Color	.color	Color	Color in which the outline is drawn. The default color is medium gray (128, 128, 128).
Filled †	.filled	Boolean	Whether the interior of the resource should be filled. This is True by default.
Fill Color	.fillColor	Color	Color in which the interior of the resource is filled. The default color is medium gray (128, 128, 128).
Stroke Width	.strokeWidth	Integer	Specifies the width (1 by default) of the pen in pixels.
Point One #	.pointOne	Point	(x, y) coordinate of the first point of the triangle
Point Two #	.pointTwo	Point	(x, y) coordinate of the second point of the triangle
Point Three #	.pointThree	Point	(x, y) coordinate of the third point of the triangle

8.1.9 Freeform Resource

The freeform resource can be used to draw a polygon consisting of two or more vertices connected by straight lines. To create a freeform resource on the screen, first write down on a piece of paper the list of x, y coordinates for all of the intended vertices in order.

Click on the “Draw Freeform Resource” button () on the toolbar, and place the mouse cursor at the intended position for the first vertex in the Screen Builder workspace and click the left mouse button. Next, click on the position for the second vertex and do the same for the rest. To end drawing, simply press the “Enter” key so that the last vertex can be connected back to the first one. To create a curved polygon, the user can simply drag the mouse cursor along the intended shape until the shape is closed.

To move a freeform resource on the screen, as described in the previous sections, the user should simply select the resource and drag it to a desired location. To adjust the position of individual vertices, select the resource and place the mouse cursor on top of the intended vertex until the shape of the mouse cursor changes to one of the resizing cursors (e.g., ). Then hold down the left mouse button and drag the vertex until it is placed at the desired location.

The appearance (frame color, interior color) of the freeform resource can also be adjusted. If the “Filled” attribute is set to true, the interior of the freeform resource will be filled with the filling color; otherwise, only the frames of the resource will be drawn while the filling color will be ignored.

Field	Attribute Reference	Type	Content
Label *	.label	String	Label of the resource. The default label is “FREEFORM_RESOURCE”.
Type	NR		The type of screen resource (“FreehandResource”) the current item belongs to.
Visible †	.visible	Boolean	Whether the resource should be visible. It is True by default.
Screen Index	.screenIndex	Integer	Index of the resource in screen resource list (0 - n).
Position is Gaze Contingent †	.positionAtGazeContingent	Boolean	Whether the position of the resource is contingent on the gaze position. The default setting is False. This setting can only be modified when the display screen is contained in a recording sequence.
Position is Mouse Contingent †	.positionAtMouseContingent	Boolean	Whether the position of the resource is contingent on the mouse position. The default setting is False.
Offset	.offset	Point	Adjustment of the resource position relative to the position of the current gaze or mouse position. The default offset is (0.00, 0.00).
Host Outline Color ¶	.hostOutlineColor	Color	The color of the box drawn on the host screen to show the position and dimension of the current

			resource. This property is available only if the “Use for Host Display” option of the containing display screen action is enabled.
Location	.location	Point	The coordinate of the top-left corner or center of the resource.
Width #	.width	Float	Width of the resource in pixels.
Height #	.height	Float	Height of the resource in pixels.
Movement Pattern ¶ *	NR		Movement pattern (sinusoidal or custom) of the resource
Prebuild to Image †	.prebuildToImage	Boolean	Whether the resource should be saved in an image file when the experiment is built (instead of having it created during run time). This field is always true when the screen is contained in a recording sequence. IMPORTANT: If this attribute is False, the run-time drawing may not look exactly as it does in the screen editor. In addition, images will not be saved to support Data Viewer overlay.
Use Software Surface †	.useSoftwareSurface	Boolean	If false (unchecked), memory on the video card is used to hold the resource (blitting from the video card memory to the display surface is fast). If true (checked), the system memory is used to hold the resource (blitting is slow as it is done by copying from RAM to display surface).
Color	.color	Color	Color in which the outline is drawn. The default color is medium gray (128, 128, 128).
Screen Location Type	NR		Whether the location specified below refers to the top-left corner or center of the resource. This setting can be changed at “Screen Preferences”
Filled †	.filled	Boolean	Whether the interior of the freeform should be filled. The default setting is True.
Fill Color	.fillColor	Color	Color in which the interior of the freeform is filled. The default color is medium gray (128, 128, 128).
Stroke Width #	.strokeWidth	Integer	Specifies the width (1 by default) of the pen in pixels.
Points #	.points	List of points	(x, y) coordinate of the points of the freeform.

8.2 Movement Patterns

A screen resource does not need to be static when shown on the screen. Instead, it may move at a constant speed, oscillate sinusoidally, or jump discontinuously. SR Research Experiment Builder supports the generation of various resource movement patterns. This will be convenient for creating experiments showing moving targets on the screen (e.g., pursuit).

Two types of movement patterns can be created: sinusoidal or custom. To create a movement pattern, click on the “Insert Sine MovementPattern” button (M) or “Insert Custom MovementPattern” button (W) on the Screen Builder toolbar (see Figure 8-11). Following this, the user can assign the created movement pattern to a resource by setting the “Movement Pattern” attribute of the resource.



Figure 8-11. Creating a Movement Pattern

To have Data Viewer automatically integrate the target position information, users may write out a "!V TARGET_POS" message to the DISPLAY_SCREEN action which is used to present the moving screen resource (see EyeLink Data Viewer User Manual, section "Protocol for EyeLink Data to Viewer Integration -> Target Position Commands" or the "Pursuit example"). Target position can be derived from the TARGET_X and TARGET_Y variables of a Sample Report.

8.2.1 Sinusoidal Movement Pattern

Smooth sinusoidal movement pattern is a widely used diagnostic test due to its wide range of velocities and lack of abrupt changes in speed and direction. To review its properties, click on the movement pattern node in the structure panel of the project explorer window. The defining parameters of a sinusoidal movement are the frequency (cycles per second), amplitude of the movement, start phase, and the center X and Y coordinates (see the following table for details of each property). The target will move (in a full cycle) from (Xcenter - Xamplitude, Ycenter - Yamplitude) to (Xcenter + Xamplitude, Ycenter + Yamplitude), and the movement will be centered at (Xcenter, Ycenter).

Field	Attribute Reference	Type	Content
Label *	.label	String	Label of the sinusoidal movement pattern ("SINE_PATTERN" by default).
Type	NR	\	The type of Experiment Builder object ("SinePattern") the current item belongs to.
Screen Location Type #	NR		Whether the locations specified refer to the top-left corner or center of the resource. This setting can be changed at "Screen Preferences".
Start Time	.startTime	Float	Start Time of the movement. Typically set to 0 so that the movement pattern is aligned to the display screen action.
Amplitude X	.amplitude_x	Float	The amplitude of horizontal movement in pixels (341.0 by default).
Amplitude Y	.amplitude_y	Float	The amplitude of vertical movement in pixels (256.0 by default).
Center X	.plot_x	Float	The horizontal center of the movement in pixels. Typically this is the center of the

			screen.
Center Y	.plot_y	Float	The vertical center of the movement in pixels.
Frequency X	.frequency_x	Float	The speed of horizontal movement (in number of cycles per second; Hz).
Frequency Y	.frequency_y	Float	The speed of vertical movement.
Start Phase X	.start_phase_x	Float	The start phase position of horizontal movement. This number should be between 0 and 360.
Start Phase Y	.start_phase_y	Float	The start phase position of vertical movement.

Note: Amplitude X should be set to 0 for a vertical sine movement and Amplitude Y should be 0 for a horizontal movement. X and Y amplitudes must be the same for a circular movement; otherwise this will result into an elliptic movement.

The start point of the movement is specified by the Start Phase X and Start Phase Y. The following table lists the most important landmark positions in a sinusoidal movement.

Dimension	Phase	Position	Direction
Horizontal (x)	0°	Center	Moving right
Horizontal (x)	90°	Right	Stationary
Horizontal (x)	180°	Center	Moving left
Horizontal (x)	270°	Left	Stationary
Vertical (y)	0°	Center	Moving down
Vertical (y)	90°	Bottom	Stationary
Vertical (y)	180°	Center	Moving up
Vertical (y)	270°	Top	Stationary

For a horizontal movement, Start Phase Y should be set to 0°. A Start Phase X of 0° creates a movement which starts at the center of the movement and moves right; a Start Phase X of 90° creates a movement which starts at the right end of the movement and moves left; a Start Phase X of 180° creates a movement which starts at the center of the movement and moves left; and a Start Phase X of 270° creates a movement which starts at the left end of the movement and moves right.

For a vertical movement, Start Phase X should be set to 0°. A Start Phase Y of 0° creates a movement which starts at the center of the movement and moves down; a Start Phase Y of 90° creates a movement which starts at the lower end of the movement and moves up; a Start Phase Y of 180° creates a movement which starts at the center of the movement

and moves up; and a Start Phase Y of 270° creates a movement which starts at the upper end of the movement and moves down.

The sinusoidal movement can be two-dimensional if both Start Phase X and Start Phase Y are non-zero. To create a circular or elliptic movement pattern, make sure that Start Phase X - Start Phase Y = 90° for a clockwise movement and Start Phase Y - Start Phase X = 90° for a counterclockwise movement. The circular or elliptic movement will be reduced to a movement along an oblique axis if Start Phase Y = Start Phase X. All other phase value combinations will result into a complex Lissajou figure.

8.2.2 Custom Movement Pattern

The Experiment Builder also allows the user to create a linear movement at a constant velocity or a set of such linear smooth movements. The underlying mechanism of the custom movement pattern is to process a list of resource positions, which specify the destination movement position and the time in millisecond (since the start of the current trial) when the resource reaches the position. A message can also be sent when the target position is reached.

Property	Value
Label	Resource_Position
Time	0
Screen Location Type	TopLeft
X	512
Y	384
EDF Message	First_point

Figure 8-12. Adding Resource Positions to a Custom Movement Pattern

To make the custom movement patterns really useful, the user needs to either add one or more resource positions and define their x, y coordinates and time values or to specify a

movement pattern file. Following this, the user can select a screen resource on the same DISPLAY_SCREEN action and set its "Movement Pattern" property to the custom movement pattern defined.

- For the first option, the user can add one or more resource positions to the movement pattern. To add a resource position, select the desired custom pattern in the Structure panel and make sure that the "Use Points From File" box is unchecked. Following this, click the button "Insert Resource Position in the selected Custom MovementPattern" () on the Screen Builder toolbar.

When a custom movement pattern is created with this option, a default resource position is automatically generated. This position cannot be deleted unless the custom movement pattern is removed. The time field of this resource position object is set to 0 and is not editable so that this can be viewed as the start position of the movement pattern. The x and y coordinates are initially set to the center of the screen. When the movement pattern is assigned to a resource, the x and y coordinates are then reset to the current position of the resource.

Consider the following custom movement pattern: the first (default) resource position has a time field of 0 and a destination position of (512, 384), the second point has a time of 1000 and a destination position of (100, 384), and the third point has a time of 6000 and an end position of (800, 384). This translates into two segments of movement. The first segment moves from (512, 384) to (100, 384) when the sequence starts; the movement ends in 1000 milliseconds. The second movement starts from time 1000 (since the sequence starts) and ends on time 6000, moving smoothly from position (100, 384) to (800, 384).

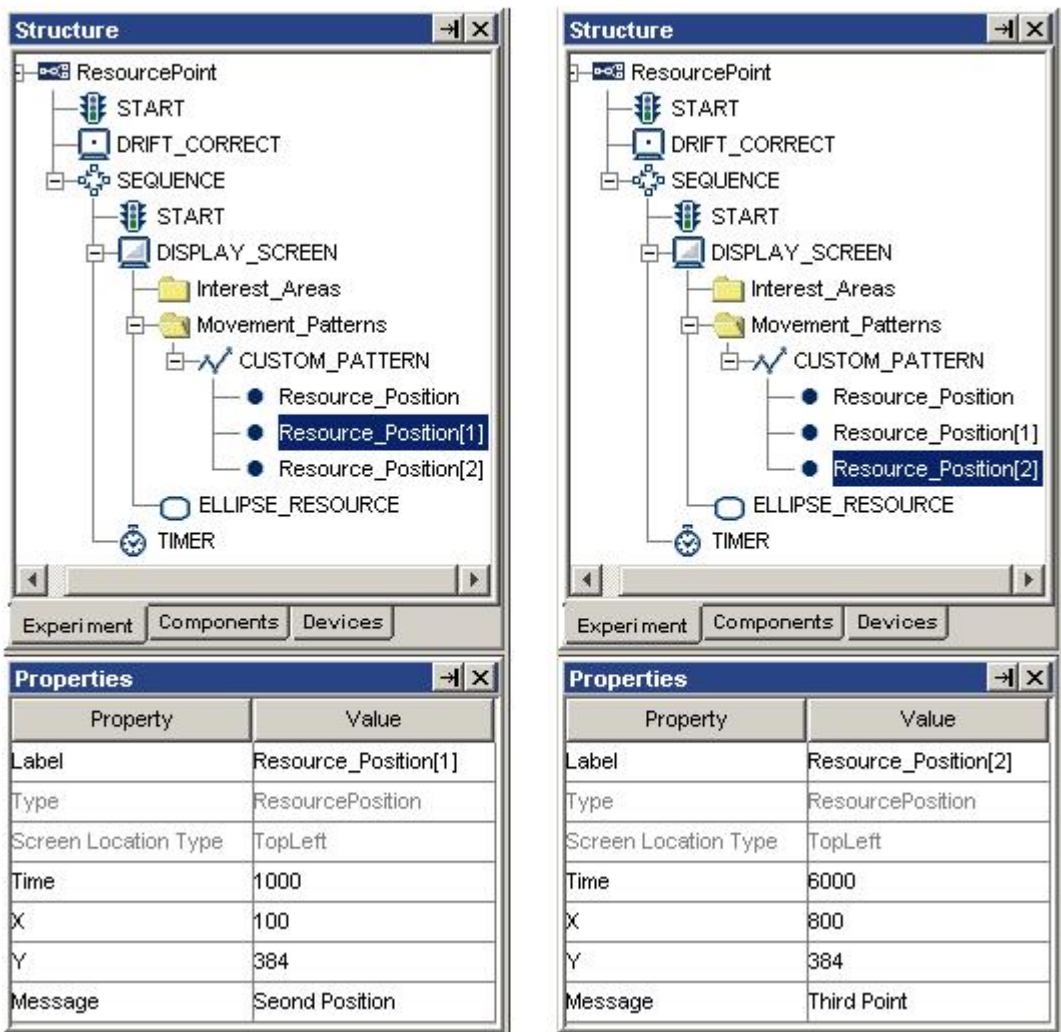

Figure 8-13. Creating a Custom Movement Pattern

- Alternatively, the user can create a movement pattern file (a tab-delimited text file; see the following example) to specify the landmark points in a movement; this is particularly useful when a large number of movement points have to be specified. The movement pattern file should contain time (integer), x (integer), and y (integer) fields, followed by an optional message field (string). Neighboring fields should be separated by a tab.

```

0      512  384  "Start of Movement"
1000   100  384  "Left End"
6000   800  384  "Right End"

```

Add this file to the "Movement Pattern" tab of the library manager. Select the desired custom pattern in the Structure panel and check the "Use Points From File" box. Select the movement pattern file from dropdown list or specify the file with the attribute editor.

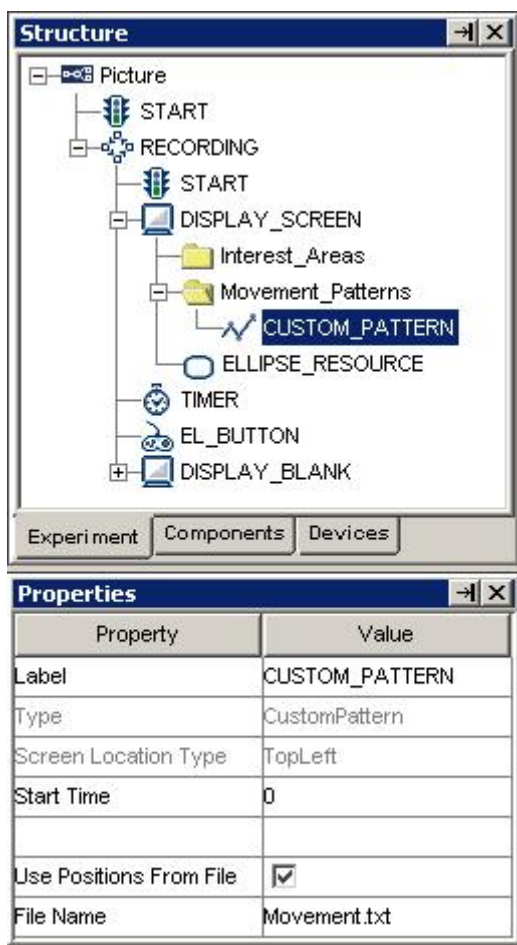

Figure 8-14. Creating a File-based Custom Movement Pattern

The following is a list of properties for a custom movement pattern.

Field	Attribute Reference	Type	Content
Label *	.label	String	Label of the custom movement pattern. The default label is "CUSTOM_PATTERN".
Type	NR		The type of Experiment Builder objects ("CustomPattern") the current item belongs to.
Screen Location Type	NR		Whether the locations specified refer to the top-left corner or center of the resource. This setting can be changed at Screen Preferences.
Start Time	.startTime	Float	Start Time of the movement. Typically set to 0 so that the movement pattern is aligned to the display screen action.
Use Points	.usePositionsFr	Boolea	Whether the movement pattern point list is

From File	omFile	n	specified in a text file. If enabled, a text file must be added into the "Movement Pattern" tab of the library manager and selected either from dropdown list or from the attribute editor. If this box is unchecked, the user must added a list of resource positions to the movement pattern (see the following table).
File Name	.fileName	String	Name of a text file that is used to specify the custom movement pattern.

Each of the individual resource position in the custom movement pattern has the following properties.

Field	Attribute Reference	Type	Content
Label *	.label	String	Label of the resource position in the custom movement pattern. The default label is "Resource Position".
Type	NR		The type of Experiment Builder object ("ResourcePosition") the current item belongs to.
Screen Location Type	NR		Whether the locations specified refer to the top-left corner or center of the resource. This setting can be changed at "Screen Preferences".
Time	.time	Integer	Time (since the start of the sequence) when the resource reaches the destination position.
X	.x	Float	X coordinate of the resource when this segment of movement finishes.
Y	.y	Float	Y coordinate of the resource when this segment of movement finishes.
Message	.message	String	Message text to be sent when the resource is reached to the specified position.

8.3 Interest Areas

Interest areas can be drawn on the Screen Builder workspace and recorded in EDF file for the ease of analysis with EyeLink© Data Viewer. The interest areas created in the Screen Builder will not be visible to the participants during recording. To show interest areas on the workspace, the "Toggle Interest Area Visibility" button should be clicked on the Screen Builder toolbar (see Figure 8-15). In the Structure panel, interest areas are listed under the "Interest_Areas" folder.

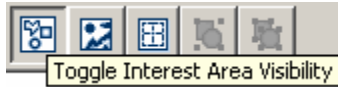

Figure 8-15. Toggling Interest Area Visibility

8.3.1 Manually Creating an Interest Area

SR Research Experiment Builder supports three types of interest areas (rectangular, elliptic, or freeform). The following sections illustrate the use of each type of interest areas.



Figure 8-16 Creating an Interest Area

To create a rectangular interest area, click on the “Insert Rectangle Interest Area Region” button (□). Place the mouse cursor in the workspace at the location intended for the top-left corner of the interest area, press the left mouse button, drag the mouse cursor to the desired location intended for the bottom-right corner of the interest area, and then release the mouse button. The precise location of the rectangular interest area can be edited in the property panel. An elliptic interest area (○) can be created in a similar fashion. A freeform interest area (⏏) can be created in the same way as a freeform resource is created (see Section 8.1.9).

8.3.1.1 Rectangular/Elliptic Interest Area

The following table lists the properties of a rectangular or elliptic interest area. Please note that the precise location of an interest area can be edited with the “Location”, “Width”, and “Height” attributes in property table.

Field	Attribute Reference	Type	Content
Type	NR		The type of Experiment Builder object ("RectangleInterestArea") the current item belongs to.
Label *	.label	String	Label of the Rectangle or Ellipse interest area. The default label is “REACTANGE_INTERESTAREA” or “ELLIPSE_INTERESTAREA”.
ID *	.ID	String	Ordinal ID of the interest area.
Data Viewer Name	.DVName	String	Text associated with the interest area in Data Viewer.
Color *	NR	Color	Color used to draw the interest area in the screen editor.
Screen Location Type	NR		Whether the locations specified refer to the top-left corner or center of the interest area. This global setting can be changed “Screen

			Preferences”.
Screen Location Type	NR		Whether the locations specified refer to the top-left corner or center of the interest area. This global setting can be changed at Screen Preferences
Location	.location	Point	The top-left or center of the interest area, depending on the preference setting of screen location type.
Width	.width	Float	The width of the interest area in pixels.
Height	.height	Float	The height of the interest area in pixels.

8.3.1.2 Freeform Interest Area

The shape of a freeform interest area can be adjusted by moving the vertices individually. To adjust the position of a vertex, select the interest area, place the mouse cursor on top of the intended vertex until the shape of the cursor changes to one of the resizing cursors (e.g., ). Hold down the left mouse button and drag the mouse until it is placed at a desired location. The properties of a freeform interest area are listed in the following table.

Field	Attribute Reference	Type	Content
Label *	.label	String	Label of the Freeform interest area. The default label is “FREEFORM INTERESTAREA”.
Type	NR		The type of Experiment Builder object (“FreehandInterestArea”) the current item belongs to.
ID *	.ID	String	Ordinal ID of the interest area.
Data Viewer Name	.DVName	String	Text associated with the interest area in Data Viewer.
Color *	NR	Color	Color used to draw the interest area in the screen editor.
Screen Location Type	NR		Whether the locations specified refer to the top-left corner or center of the interest area. This global setting can be changed at “Screen Preferences”.
Location	.location	Point	The top-left or center of the interest area, depending on the preference setting of screen location type.
Points #	.points	List of Points	List of points (2-tuple of x, y coordinates) for the vertices of the interest area.

8.3.2 Automatic Segmentation

Interest areas can be automatically created for some screen resources. Click the right mouse button in the workspace to bring up a popup menu. Select "Create Interest Area Set -> Grid Segment". This will create a set of rectangular interest areas, partitioning the

whole workspace into grids. The number of columns and rows created is set in "Rows" and "Columns" of the "GRID_SEGMENT" preference settings (from Edit -> Preferences menu, select Preferences -> Screen -> Built-in Interest Area Preference -> GRID_SEGMENT).

The "Auto Segment" option will create a rectangular or elliptic interest area to contain each of the individual resources created on the screen. The margins and shape of the interest areas can be set in the "AUTO_SEGMENT" preference settings. An interest area created by "Auto Segment" option will be associated with the resource and its location, width and height cannot be modified (but referable). These properties will be changed when resource's properties are changed.

For text resources, you may apply "Word Segment" option from the popup menu. This will create segments for individual words. However, the interest areas created will be static in the sense that the same segments will be carried over to following trials, even if the text materials have changed. To create dynamic interest areas for text and multi-line text resources, you should check "Use Runtime Word Segment Interest Area" option from the resource property table (see the figure below). Note: Interest areas created in this method will not be listed under the "Interest_Areas" folder of the Display Screen action nor will be displayed in the Screen Editor.

By default, the automatic word segmentation is based on the space between words. The users may choose other delimiter options. For example, to see whether the subject detects semantic anomaly in the sentence "The authorities were trying to decide where to bury the survivors", you may group "bury the survivors" into one interest area instead of creating three separate interest areas. To do that, you may set the original sentence as "*The*authorities*were*trying*to*decide*where*to*bury the survivors.*" (replace space with a '*'). In the Word Segmentation preference settings (see the figure below), check the "Enable Interest Area Delimiter" option. Set the "Delimiter Character" as *. Check the "Enable Interest Area Delimiter Replacement" option and set the "Delimiter Replacement Character" as a single space.

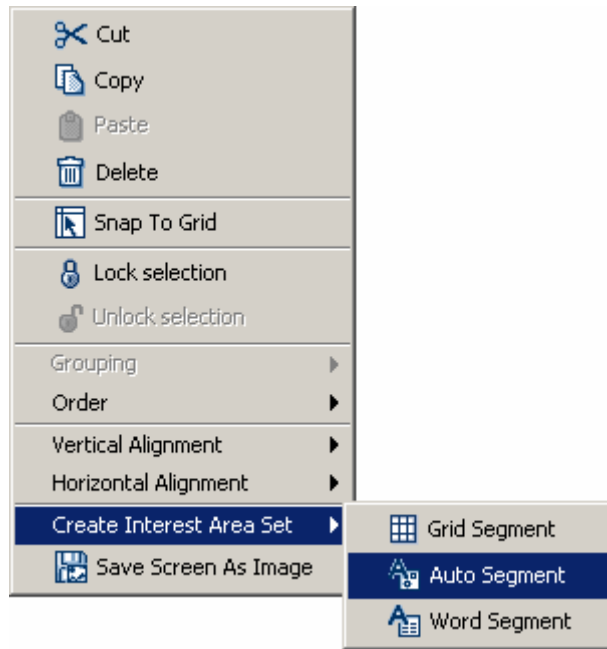

Figure 8-17. Creating Interest Area with Grid Segmentation

8.3.3 Using Interest Area File

For some experiments, it is hard to define interest areas within Experiment Builder. For example, if the experiment presents different images across trials, it is hard to manually create built-in interest areas, or to create runtime interest areas automatically. If this is the case, you may consider the interest area file option. In this approach, you will need to create one interest area file for each of the Display Screen actions. Add the interest area files into the library manager. Select the display screen to which the interest areas are associated and set "Interest Area File Name" field to a desired interest area set file. Please make sure that the interest area file name does not contain space or non-ASCII characters.

Note: Interest areas contained in an interest area file will not be listed under the "Interest_Areas" folder of the Display Screen action nor will be displayed in the Screen Editor.

8.4 Resource Operations

The current section lists miscellaneous operations for adjusting the appearance of display screen and the layout of resource components.

8.4.1 Resource Editing

Similar to triggers and actions, the following operations can be applied to screen resources, interest areas and movement patterns: cut (✂), copy (📄), paste (📄) and delete (🗑) using either application menubar, toolbar, or popup menu.

8.4.2 Resource Alignments

The position of resources and interest areas can be adjusted with alignment buttons on the Screen Builder toolbar (see Figure 8-18). The user needs to select the target resource or interest area and then click on one of the alignment tool buttons. Horizontal alignment buttons determine the relative position of a resource or interest area on the horizontal dimension: left aligned, right aligned, or centered. For example, if a resource is left aligned, the x coordinate of the left edge will be set as 0. The vertical alignment buttons can be used to adjust the resource or interest area position relative to the top and bottom margins: top-aligned, bottom-aligned, or centered. The resource and interest area alignment can also be done from the popup menu invoked by a click on the right mouse button.

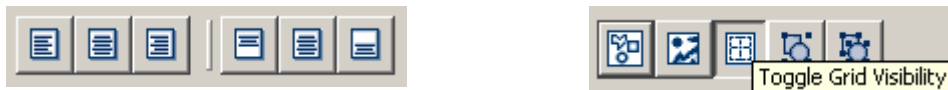

Figure 8-18. Resource Alignment (Left) and Toggling Grid Visibility

A special type of alignment styles is called “Snap to Grid” and is only available to resources (see Figure 8-19). When creating the screen, grids can be visible for alignment reference. To enable grid visibility, click on “Toggle Grid Visibility” button (see Figure 8-18). This will create a set of grids, partitioning the whole workspace into small areas (the actual number of grids to be created is specified by the “Grid Columns” and “Grid Rows” attributes in the Display Screen preference settings). Select the resource to be aligned and then click on the right mouse button. Choose “Snap to Grid” in the popup menu. This will align the top-left corner of the resource with the top-left edge of the grid if the location type is set as “TopLeft Position” or align the center of the resource to the center of the grid if the location type is set as “Center Position” (see the preference settings for Screen).

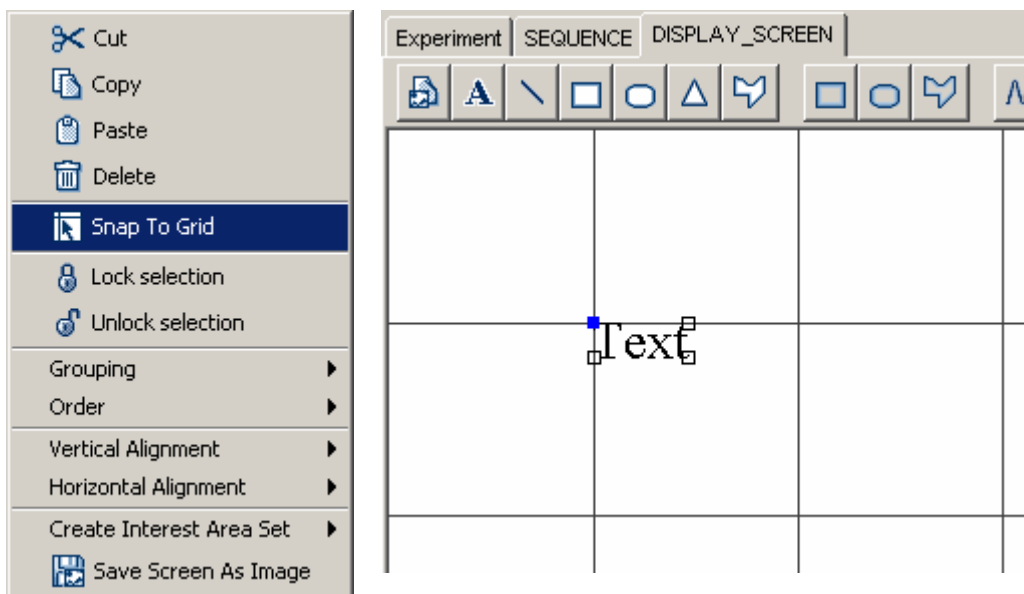

Figure 8-19. Snap to Grid

Please note that position alignments should be re-applied if the properties of the resource have been changed. For example, in a top-left screen coordinate system, changing the font size of the text resource after applying the center alignment will not display the text in the center of the screen.

8.4.3 Resource Locking

When building the screen, the user may want to lock a resource just in case it is moved or resized by accident. To do that, place the mouse cursor over the resource, click the right mouse button and select “Lock Selection”. To unlock the resource, select the “Unlock Selection”.

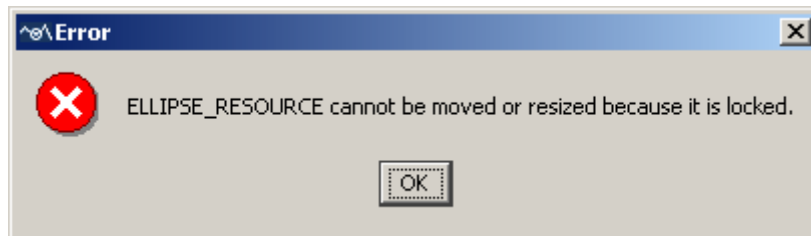

Figure 8-20. Error When Trying to Modified a Locked Resource

When a resource is locked, any attempts to change the resource from the workspace will prompt an error (see Figure 8-20). If the resource appearance should be adjusted, the user can make the modification from the property panel of the resource. Alternatively, the user can first unlock the resource, do the adjustments, and then re-lock the resource.

8.4.4 Resource Grouping

Resource grouping offers a handy tool so that the same operations can be applied to individual component resources together. For example, after a schematic face is created on the screen with several components resources, the user may want to adjust the position of the whole drawing. It will be much easier if all of the components resources are grouped and moved together than the individual resource components are moved one by one. To group several resources together, select the resources and click the right mouse button. In the popup menu, select “Grouping → Group”. To ungroup resources, select “Grouping → Ungroup”. Alternatively, tool buttons on the Screen Builder toolbar (see Figure 8-21) can be used.



Figure 8-21. Resource Grouping

Please note that after several resources are grouped together, a “COMPOSITE_RESOURCE” object is created while the individual component resources

are removed from the Structure panel (see Figure 8-22). The content of the property panel is also updated to reflect this change.

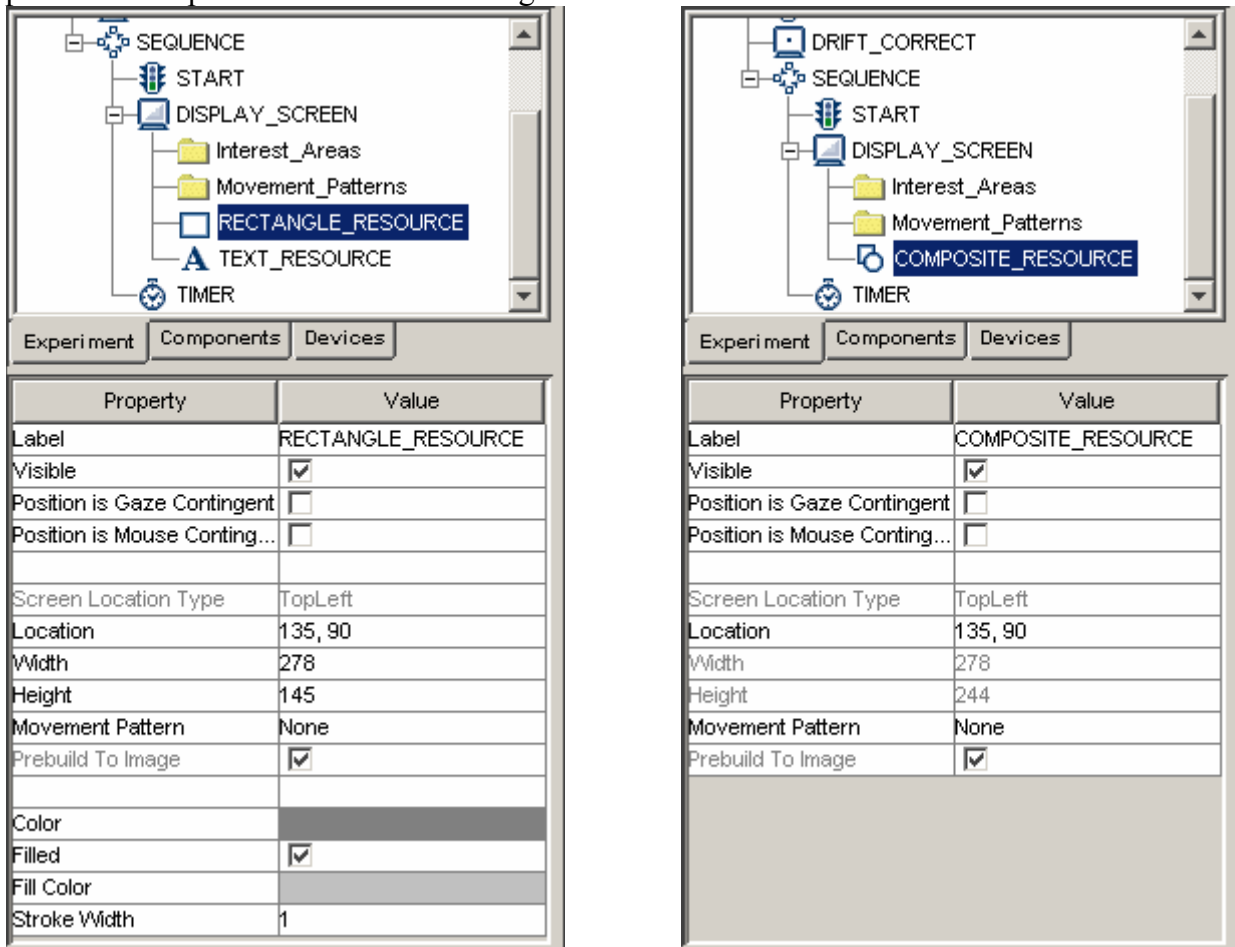

Figure 8-22. Creating a Composite Resource

8.4.5 Resource Order

If several resources are created close to each other spatially, it is possible that some resources created earlier may be partially or entirely occluded by some resources created later (see Figure 8-23; panel A). Therefore, the surface layout of individual resources may be rearranged.

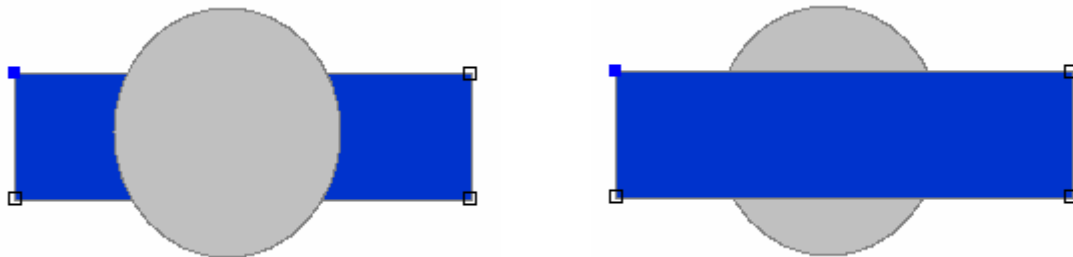

Figure 8-23. Two Resources with Different Resource Order

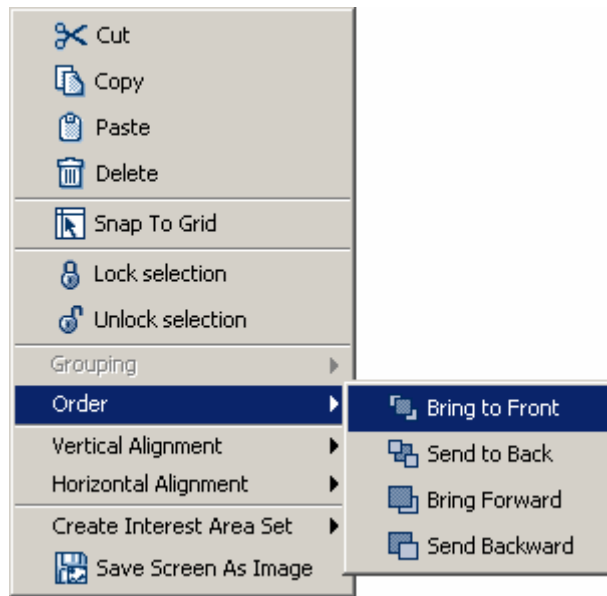

Figure 8-24. Changing the Order of Resources

The order of resources can be changed by clicking the right mouse button and choose different options under the “Order” menu from the popup menu (see Figure 8-24): “Bring to Front” makes the selected resource to appear on the topmost layer (as if the resource was the last item added to the screen), “Send to Back” moves the selected resource to the bottommost layer (and therefore it is most likely to be blocked other resources), “Bring Forward” moves the resource one layer closer to the surface and “Send Backward” moves the resource one layer away from the surface. Please note that changing the resource order on the workspace also modified the order of the resource listed in the structure panel.

8.4.6 Composite Resource

A "COMPOSITE_RESOURCE" object can be created by grouping several individual resources together. The individual component resources are removed from the structure panel.

Field	Attribute Reference	Type	Content
Label *	.label	String	Label of the resource ("COMPOSITE_RESOURCE" by default).
Type #	NR		The type of screen resource ("CompositeResource") the current item belongs to.
Node Path	.absPath	String	The absolute path of the node in the experiment graph
Visible	.visible	Boolean	Whether the resource should be visible. The default setting is True (box checked).
Screen Index #	.screenIndex	Integer	Index of the resource in screen resource list (0 - n).

Position is Gaze Contingent	.positionAtGazeContingent	Boolean	Whether the position of the resource is contingent on the gaze position (False by default). This setting can only be modified when the display screen is contained in a recording sequence
Position is Mouse Contingent	.positionAtMouseContingent	Boolean	Whether the position of the resource is contingent on the mouse position. The default setting is False.
Offset	.offset	Point	Adjustment of the resource position relative to the position of the current gaze or mouse position. The default value is (0.00, 0.00) for a perfect alignment of the resource position with the current gaze or mouse position.
Screen Location Type	NR		Whether the location specified below refers to the top-left corner or center of the resource. This setting can be changed at Screen Preferences.
Location	.location	Point	The coordinate of the top-left corner or center of the resource.
Width	.width	Integer	Width of the resource in pixels.
Height	.height	Integer	Height of the resource in pixels.
Movement Pattern	.	NR	Movement pattern (sinusoidal or custom) of the resource.
Prebuild to Image	.prebuildToImage	Boolean	Whether the resource should be built into an image when the experiment is built (instead of having it created during runtime). This field is always true when the screen is contained in a recording sequence. Important: If this attribute is False, the run-time drawing may not look exactly as it does in the screen editor. In addition, images will not be saved to support Data Viewer overlay.
Use Software Surface	.useSoftwareSurface	Boolean	If false (unchecked), memory on the video card is used to hold the resource (bitting from the video card memory to the display surface is fast). If true (checked), the system memory is used to hold the resource (bitting is slow as it is done by copying from RAM to display surface).

8.4.7 Others

The screen builder also allows the users to adjust the canvas size of the workspace. If “Fit to Screen” option is enabled (see Figure 8-25), the workspace area is scaled to size of the screen to be displayed; otherwise, the workspace area is set to actual size (i.e., one pixel of workspace area corresponds to one pixel of computer desktop).



Figure 8-25. Choosing "Fit to Screen" Option

Finally, the user can save the graphics of the workspace with the “Saving Screen as image” option (see Figure 8-26).

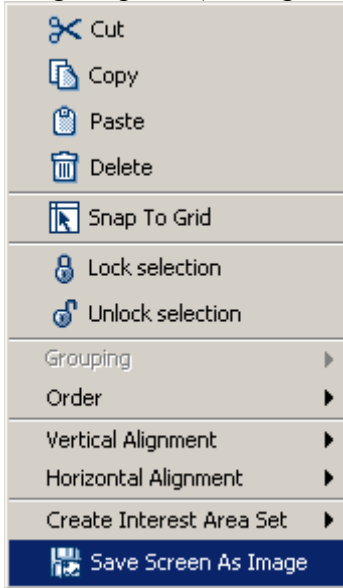

Figure 8-26. Save Screen as Image

9 Data Source

An important issue for most experiments is to specify the actual parameters of the individual trials. For example, which experiment condition should each trial be in? Which display should be presented? To do that, the user may hard code the content of each trial in the experiment. Obviously, this will be extremely time-consuming and error-prone if there are several hundreds of trials involved (unfortunately this is the typical case for a perception or cognition experiment).

The Experiment Builder handles this issue by allowing the user to create prototypical trials for the experiment and to supply the actual parameters for individual trials from a data source (see Figure 9-1). A data source can be created within the Experiment Builder or by loading a text file. The column headings in that file could be variable names and each row contains values for the variables in each trial – the linkage between the two is achieved by attribute reference, which is discussed in next Chapter.

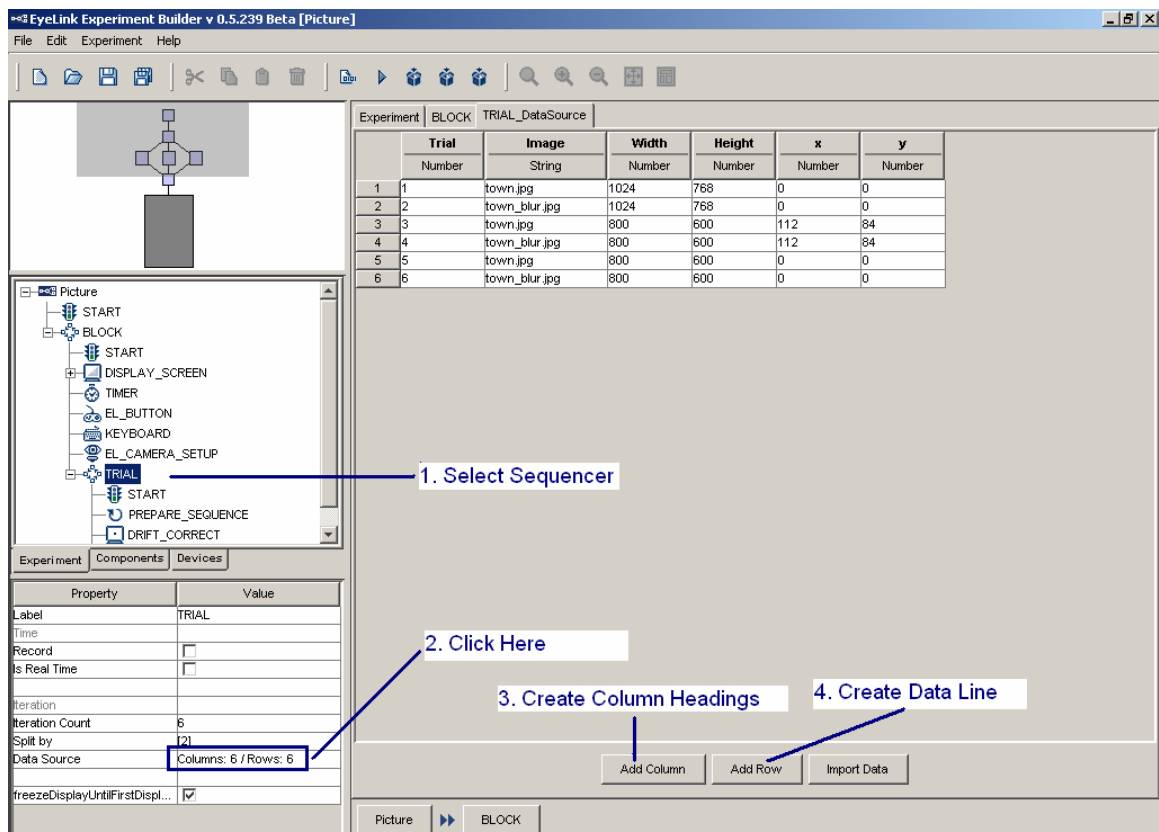

Figure 9-1. Using Data Source in Experiment Builder

9.1 Creating Data Source

A data source is attached to a sequence object given its repetitive nature. To create a data source, select the sequence object and click on the value field of the “Data Source” property (by default, it shows “Columns; 0 / Rows: 0”). This will bring up the Data Source Editor.

9.2 Editing Data Source

To create a new data source or to add new columns to an existing data source, click on the “Add Column” button at the bottom of the project window. This brings up a dialog asking for the column label (see Figure 9-2).

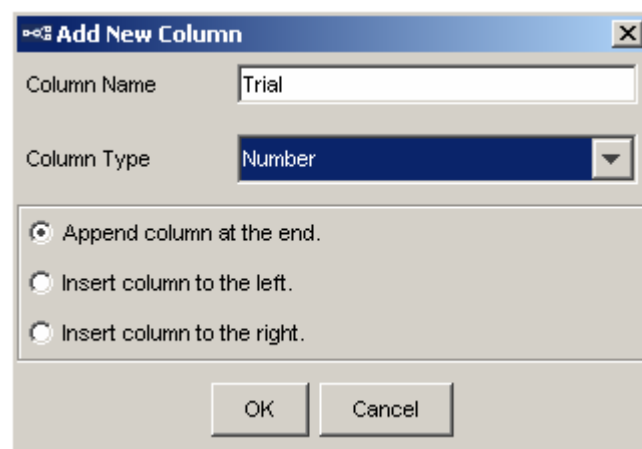

Figure 9-2. Change the Type of Variables

In this dialog, fill in the "Column Name" field. The column name must be a string starting with a letter between 'a' and 'z' or 'A' and 'Z' and consisting of alphanumerical characters ('A' - 'Z', 'a' - 'z', '0' - '9', or '_'); any space entered is converted to an underscore. The new datasource column name shouldn't duplicate the name of any existing datasource columns, variable labels, or any of these reserved words: "EYELINK", "DISPLAY", "AUDIO", "TTL", and "CEDRUS". In the dropdown list of "Column Type", choose the appropriate data type to be used. Select the location where the column should be created (at the end of the data source editor, to the left of the currently selected column, or to the right of the currently selected column) and then click "OK" to finish. This will create a new column heading with specified data type listed underneath.

Following this, click on the “Add Row” button to create lines of empty cells for data input. By default, the empty data source lines will be created at the end of the table. The user can also choose to insert the new row(s) above or below the currently selected data source row(s). To modify the value for a particular cell, double click on the cell, type in the new value (DO NOT include quotes for text strings), and press the ENTER key to register the change.

Experiment	SEQUENCE	TRIAL	RECORDING	TRIAL_DataSource	
	Trial	Text	Location	Color	List
	Number	String	Point	Color	List
1	1	One	(512, 384)	(255, 0, 0)	[1, 2]
2	2	Two	(512, 384)	(0, 255, 0)	[1, 2]
3	3	Three	(200, 100)	(0, 0, 255)	[6, 7]
4	4	Four	(100, 200)	(0, 0, 0)	[6, 7]

Figure 9-3. Data Types Used in Experiment Builder

Currently, the Experiment Builder supports six data types: number, string, point, color, list, and Boolean. For the number data type, the user can enter one integer (1, 2, 3, ...), or float number (0.1, 2.0, 3.14159, ...) in each cell. The user can enter any text in a cell of string type. If the text contains or is flanked by a pair of quotes, the quotes are shown as well. For the point type, the user needs to enter two numbers separated by a comma - a pair of brackets will be added automatically. For the color type, the user needs to enter three integer numbers between 0 and 255, separated by a comma. For the list type, the user needs to enter a list of numbers, string, colors, points, or lists, each separated by a comma. A pair of square brackets will be added automatically. To create a data column of Boolean, the user needs to enter "true" or "false" in the data cell. The above figure illustrates the use of these data types.

To delete one column of data line, click on the column heading of the intended column, click the right mouse button and select "Cut" or "Delete" from the popup menu. To copy one column of data, press "Copy" and then press "Paste". This will append the new column to the end of the data source. Similar operation can be performed on the rows of data source by clicking on the row label of the target lines and choose the desired operations.

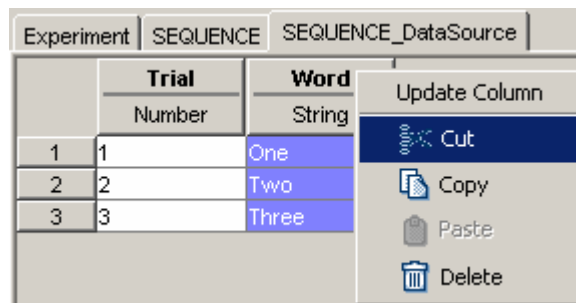

Figure 9-4. Editing Operations for Data Source Columns and Rows

The user can copy, paste, or cut/delete data cells in a similar fashion by selecting the target cells. In addition, the user can copy the current selection to external program such as Microsoft Excel. If you have copied some data from external programs, you may also paste the selection into the current data source editor. Selections can also be copied and pasted between two ongoing Experiment Builder sessions. A "Data type mismatch" error will be given if the data types of the source and target do not match (e.g., copying a column of string data to a column of color type). Please make sure that there are no

empty lines/cells in the datasource editor when you start to test run or deploy your project.

	COLOR	WORD	EXPECTED	COMPATIB...
	Color	String	String	String
1	(0, 0, 255)	Blue	b	Yes
2	(0, 255, 0)	Red	g	No
3	(255, 0, 0)	Red	r	Yes
4	(0, 0, 255)	Green	b	No
5	(255, 0, 0)	Blue	r	No
6	(0, 255, 0)	Blue	g	No
7				
8				
9				
10				
11				
12				
13				
14				
15				
16				



Figure 9-5. Editing Datasource Cells.

[Changes from version 1.3: "External Copy" and "External Paste" options have been removed in version 1.4. These operations can now be done through "Copy" and "Paste".]

9.3 Importing Existing Files as Data Source

For greater flexibility, the user can also generate data source with external text editor software like Wordpad, Notepad, etc and then load the plain-text file into Experiment Builder. In that file, use the first row for column variable labels. Use space or tab to separate neighboring columns. Click on the "Import Data" Button on the data source editor screen. In "Open" dialog, choose the target file. Please note that if your external data source file is encoded with ASCII format, you may leave the "Encoding" field as "default". If the target file was encoded with UTF-8 format, choose the right encoding type before pressing the "OK" button.

If the user has already a data set created, a dialog box will be displayed to allow the user to choose to append the new data after the existing data lines or to overwrite the old data lines (see Figure 9-6).

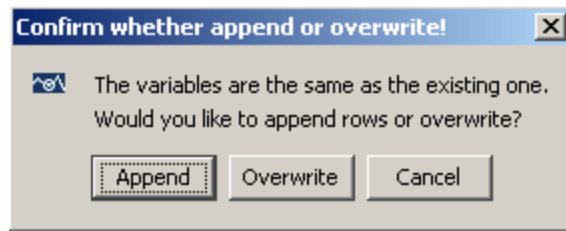

Figure 9-6. Append or Overwrite Confirmation

By default, all of the data columns are imported as string. To change data type for a column, click on that column heading, and then click the right mouse button to bring up a popup menu. Select “Update Column” menu option, and choose the desired data type.

9.4 Datasource Splitby

A data source may contain several hundred of trials. However, under some circumstances, the user may want to run a small portion of the trials. For example, the user may want to run the first ten trials of a data source containing two hundred trials for debugging purpose. In this case, the user may modify the "Split by" property of the sequence node to which the data source is attached. This specifies the actual number of iterations to be executed within each block. This feature can be used to design data source for experiments in which unequal number of trials are tested at different blocks. For example, the user may plan to run 80 trials in total but want to run 32 trials in the first block and 48 trials in the second block. The user may enter [32, 48] in the "Split by" field of the sequence.

Property	Value
Label	TRIAL
Time	
Record	<input type="checkbox"/>
Is Real Time	<input type="checkbox"/>
Iteration	
Iteration Count	80
Split by	[32,48]
Data Source	Columns: 18 / Rows: 80
freezeDisplayUntilFirstDispl...	<input checked="" type="checkbox"/>

Figure 9-7. Using "Split by" Option to Customize the Number of Iterations to Run in a Sequence

9.5 Datasource Randomization

In most experiments, the user may need to randomize trial order so that the experiment materials are not presented in the same sequence across participants. The user can perform data source randomization either internally (during runtime of the experiment) or externally (before running the experiment). These two randomization methods are almost identical except that the external randomizer allows for further counterbalancing

manipulations across subjects. You may experiment both methods out to see which one fits your needs better.

9.5.1 Internal Randomization

To perform an internal randomization, simply check "Enable Run-Time Randomization" check-box on in the data source editor (see the Stroop example). This will enable the 'Randomization Setting' button. By clicking that button will bring up a Randomization Setting dialog box.

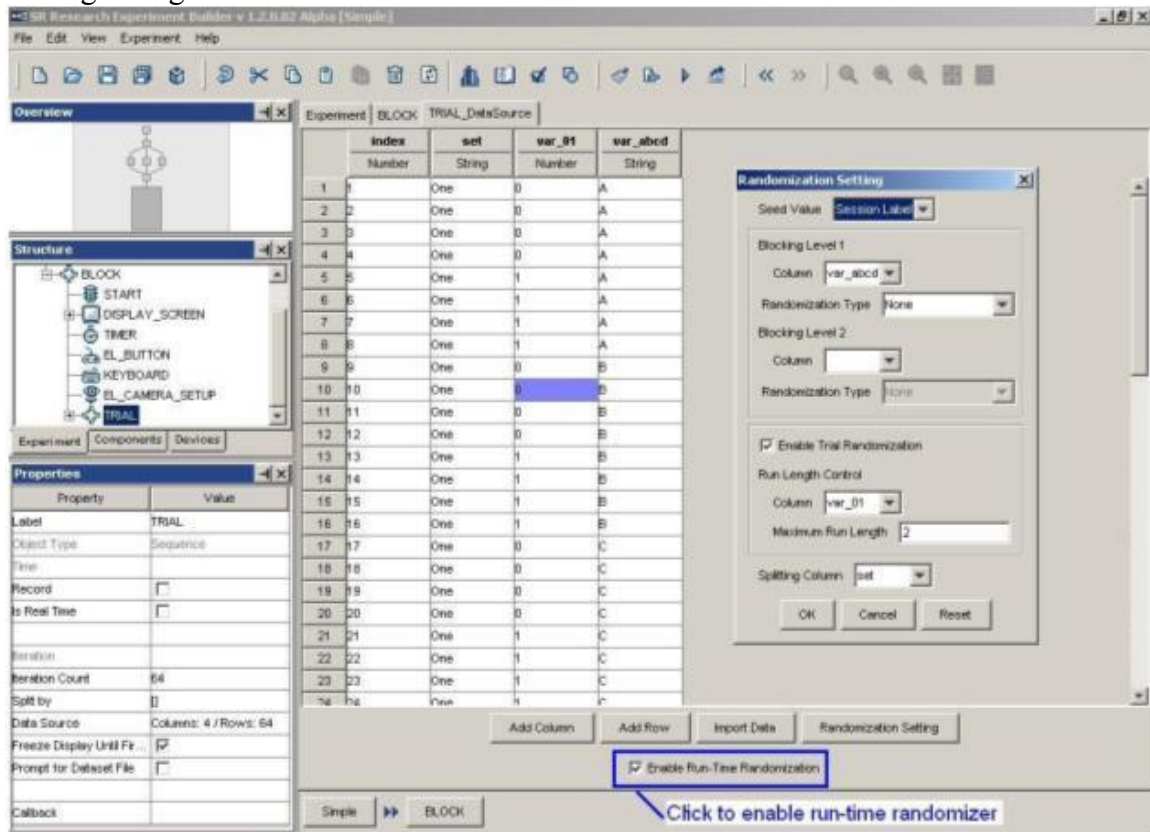
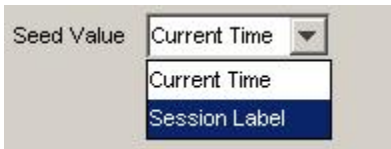

Figure 9-8. Using Internal Randomization.

9.5.1.1 Randomization Seed

If set to "Current Time", the current display PC time is used as the randomization seed. If set to "Session Label", the string you input in the "Session Name" dialog box when running the experiment is used as the randomization seed. Any two runs of randomization with the same seed will generate identical randomization outputs.



9.5.1.2 Blocking

The randomizer supports blocking by up to two variables. You may leave "Block Level 1" and "Block Level 2" fields empty if a blocking manipulation is not required in your experiment design. If blocking is used, all trials with the same value of the blocking variable will appear in a group. The order of the blocking groups (i.e., different values of the blocking variable) to appear in the randomization output can be controlled with one of the two following methods (no randomization, complete randomization).

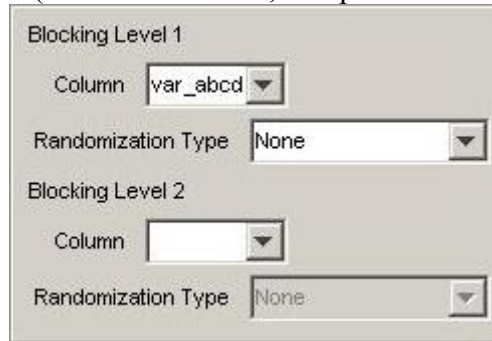

The screenshot shows a dialog box with two sections: "Blocking Level 1" and "Blocking Level 2". Each section has a "Column" dropdown menu and a "Randomization Type" dropdown menu. In the "Blocking Level 1" section, the "Column" dropdown is set to "var_abcd" and the "Randomization Type" dropdown is set to "None". In the "Blocking Level 2" section, the "Column" dropdown is empty and the "Randomization Type" dropdown is set to "None".

- None If the randomization type of the blocking variable is set to "None", the order of the blocking groups will be the same as in the original data file. For example, the four levels of the \$var_abcd variable appear in the order of ABCD in the original file. The \$var_abcd variable in the randomization output also appear in the order of ABCD.
- Random If this is the case, levels of the blocking variable will appear in a random order. For example, blocking by variable "\$var_abcd" with randomization type set to "Random" will create one of the 24 possible orders (ABCD, ABDC, ACBD, ACDB, ADCB, ADBC, BACD, BADC, BCAD, BCDA, BDAC, BDCA, CABD, CADB, CBAD, CBDA, CDAB, CDBA, DABC, DACB, DBAC, DBCA, DCAB, or DCBA).

9.5.1.3 Trial randomization and run length control

If "Enable Trial Randomization" box is checked, the trial order will be randomized. In addition, the run length of trials belonging to the same condition within the data file (or within a block of trials if blocking is involved) can also be controlled. To do that, choose the 'Run Length Control' variable in the dropdown list (currently, only one control variable is supported). Enter the maximum run length in the edit box and press enter to register the change. Note that controlling run length may not be possible for some data files.



The screenshot shows a dialog box with a checked checkbox labeled "Enable Trial Randomization". Below it is the "Run Length Control" section, which includes a "Column" dropdown menu set to "var_01" and a "Maximum Run Length" text input field containing the number "2".

9.5.1.4 Randomize on Roll-Over

If checked, a different randomization sequence will be created for the datasource when it is re-used.

9.5.1.5 Splitting Column

Sometimes the user may want to have randomization done over a subset of the trials in the original data file. This can be achieved by using a splitting variable, with one output for each level of the grouping variable.



9.5.1.6 Running Experiment with Internal Randomizer.

After the experiment is fully tested, you can now create a deployed version of the experiment (Experiment -> Deploy). Click on the {experiment name}.exe in the deployed directory to run your experiment. If you use the randomized versions of the same data source file across subjects, you may uncheck the "Prompt for Dataset file" box of the sequence to which the data source is attached before deploying so that you do not have to choose the data source file at the beginning of the experiment. In addition, if you have specified a variable for splitting the data source, a dialog box will be displayed at the beginning of the experiment, prompting to choose the level of the splitting variable.

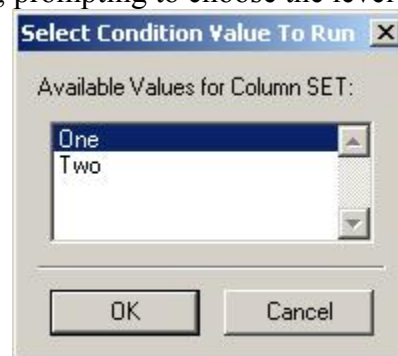

At the end of the experiment, an actually-executed version of the data source will be saved in the results directory.

9.5.2 External Randomization

For experiments created with Experiment Builder, you may rely on the Experiment Builder GUI to "Build" and "Test Run" the experiment to make sure everything is fine. Don't use "Experiment -> Test Run" to collect experiment data. Once you are happy with the experiment, you can now "Deploy" the experiment to a new directory by clicking "Experiment -> Deploy". This will create a new {experiment name}.exe file in the intended deploy directory. There, you will also find a "datasets" directory. Do randomization on the data source file and put the randomized copies in that directory. (Important: Please note that when a project is rebuilt by clicking Experiment -> Build or

Experiment -> Test Run ..., all of the files in the "datasets" directory will be deleted. So please make sure that you have backed up those files in a different folder, for example in "myfiles" directory before rebuilding the project.) The external randomzier (RandomizerW.exe) is located at {Windows Drive:}\Program Files\SR Research\Experiment Builder\Randomizer. There is also an accompanying document (Randomizer.chm) on how to perform randomization.

The user may also create the trial randomization files manually by using programs like Microsoft Excel to create the data source and save it in a tab-delimited file. Please make sure that each and every possible trial instance in the randomization file should be seen in the default data source used when building the experiment. Failing to do so may cause the experiment to crash during run time.

Once the randomization is done, click on the {experiment name}.exe to run your experiment. When you are asked to load a data source file, choose one of the randomized copies from the "datasets" directory. In your experiment project, please make sure that you have checked the "Prompt for Dataset file" box of the sequence to which the data source is attached.

The screenshot displays the SR Research Experiment Builder interface. On the left, the 'Structure' panel shows a sequence of components: START, BLOCK, START, DISPLAY_SCREEN, KEYBOARD, EL_BUTTON, TIMER, EL_CAMERA_SETUP, TRIAL, and START. Below it, the 'Properties' panel lists various attributes for the selected 'TRIAL' component, with 'Prompt for Dataset File' checked. The main area shows the 'Data Source' for the 'TRIAL' component, which is a table with 12 rows and 2 columns: 'trial' (Number) and 'word' (String). Below the table, the 'Enable Run-Time Randomization' checkbox is unchecked. A blue callout box points to this checkbox with the text 'Make sure to leave this box unchecked.' Another blue callout box points to the 'Prompt for Dataset File' checkbox in the Properties panel with the text 'Make sure that this box is checked when using external randomization.'

	trial	word
	Number	String
1	1	One
2	2	Two
3	3	Three
4	4	Four
5	5	Five
6	6	Six
7	7	Seven
8	8	Eight
9	9	Nine
10	10	Ten
11	11	Eleven
12	12	Twelve

Figure 9-9. Using External Randomization.

10 References

The Experiment Builder uses “references” to link or bind an attribute of one experiment component to be equal to the value of another component attribute. References are a critical part of the Experiment Builder, providing much of the flexibility to the application.

As an example, assume a sequence has two components, X and Y, and component X has attribute Ax and component Y has attribute Ay. If attribute Ax was set to reference Ay, then the value of Ax would always be equal to the value of Ay. In this example it is said that Ax is the ‘referencing’ attribute and Ay is the ‘referenced’ attribute. Even if Ay changes value during the experiment, Ax will always reflect the current value of Ay.

10.1 Using References

References have this syntax: “@object_name.attribute_name@”. That is, a reference starts and ends with a ‘@’ sign. A reference can be manually entered in the property value field or more preferably from an attribute editor. To bring up the attribute value editor, place the mouse cursor at the very far right end of the property value field that should be edited (see Figure 10-1). If the field supports attribute referencing, a button with three dots on it will be displayed on the right hand side of the attributes value cell. Double clicking on that button will bring up an “Edit Attribute” dialog with editable area on the top and a node selection tree on the bottom left. In the editable area, the user may enter in a value, a reference, or an equation.

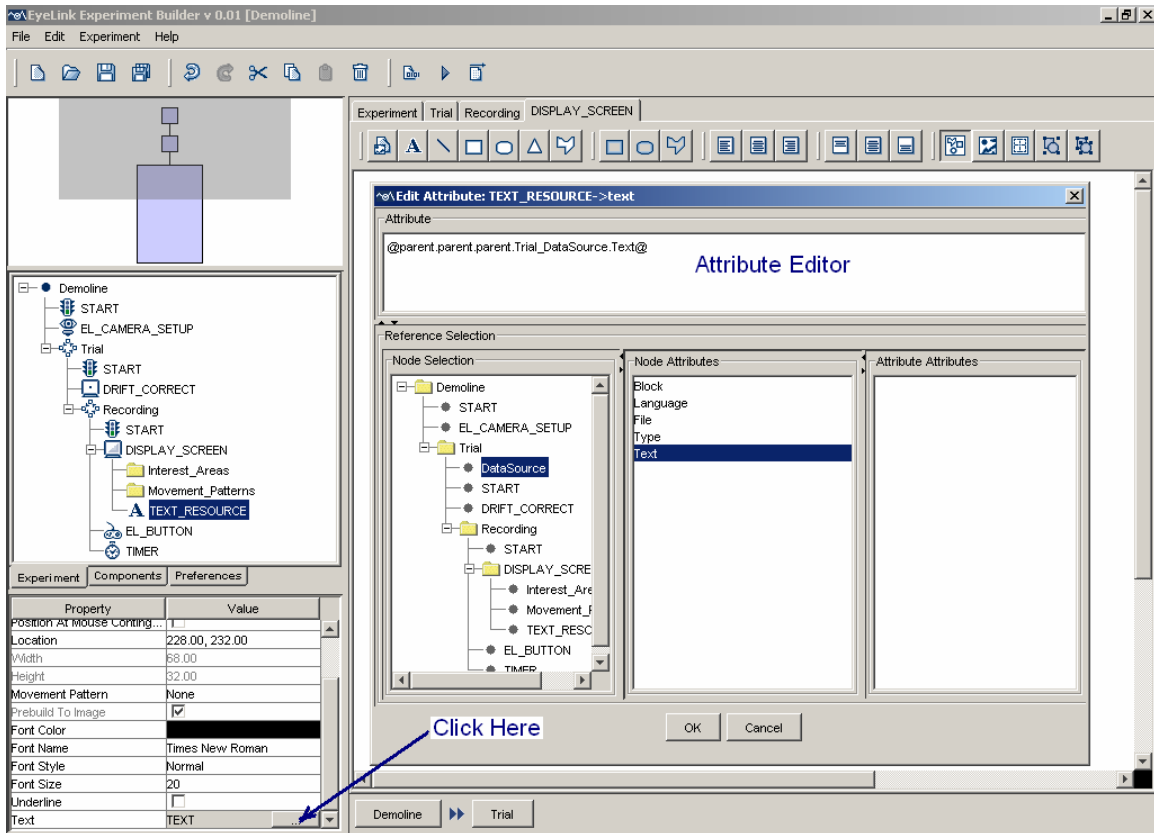

Figure 10-1. Using Attribute References

10.2 Entering in Values

If you want to enter in static values in the attribute editor, just type the value (Do not supply any prefix to the value). Any preceding or trailing white spaces are removed. The following table lists some commonly used data types that can be entered in the attribute editor.

Entered value	Translated type	Translated value	Usage
Hello	String	Hello	Label, Message, Text properties
“Hello”	String	“Hello” (Quotes are preserved).	
Hello	String	Hello (The under scores are representing white spaces, which are trimmed)	
1	Number	1.0	Width, Height, Time
1.0	Number	1.0	Width, Height, Time
True	Boolean	True	Check Boxes (Possible values are “True” or

			"False")
False	Boolean	False	Check Boxes (Possible values are "True" or "False")
(100,100)	Screen Point	(100.0,100.0)	Location
[5, 2, 6]	List	[5.0, 2.0, 6.0]	Buttons, keys, Split-by List
(15, 223, 58)	Color	(15, 223, 58)	Color

Please note that all of the non-string data entries are automatically translated into the appropriate data types, unless the type of the field is already specified as a string.

10.3 Entering in References

The easiest way to enter in a reference is by traversing down the object tree and selecting the node and then double clicking on the target node attribute or sub-attribute (see Figure 10-1). However, the user may always enter in the reference manually without using the object tree. The path of the entered reference is always relative.

References have the following constraints.

1. The referred value should match the assigning field's value type. Suppose you have an object X with attribute p and object Y with attribute q . If the type of attribute $X.p$ is number and if the value of $Y.q$ is string "5", $X.p$ cannot be directly referred to $Y.q$ or vice versa. An "Invalid Value" error dialog box will be displayed if wrong type of data is entered in the attribute editor.
2. One attribute cannot refer to itself. In the above example, $Y.q$ cannot have reference to $Y.q$. A "Recursive/Invalid reference" error message will be reported during build time.
3. Type conversion is only partially supported. Integer can be assigned to a number (floats or non floats) and vice versa. However, assigning numbers directly to a string is not supported and vice versa.

10.4 Entering in Equations

Equations are a combination of values and/or references. Equations can be used to calculate data at runtime based on static or dynamic values, or both. All equations start with a '=' sign followed by references and/or values that are concatenated with operators (+, -, *, /, %). While all of these operators support numerical operations, the only operator that supports string concatenation is the '+' sign. Functions like "str", "int", and "float" can be used to do data type conversion.

Note: Actually, any valid Python equation is a valid equation in the Experiment Builder. For details on Python, the run-time programming environment used by the Experiment Builder, visit <http://www.python.org/>.

Although equations will be evaluated during build time to check for obvious problems, the user should always check for the completeness and validity of the equations herself/himself. In particular, the user should make sure that the type of the equation

created matches the data type required in the attribute field. In the following Example 1 (see Figure 10-2), the “EyeLink© Record Status Message” field of a recording sequence expects a string value. Therefore, the equation created in the Example 1 is also a string type (please note that the “str” function is used in the equation to do data type casting). In Example 2, the equation created is “Point” data type, which matches the data type expected by the “Location” attribute of a screen resource.

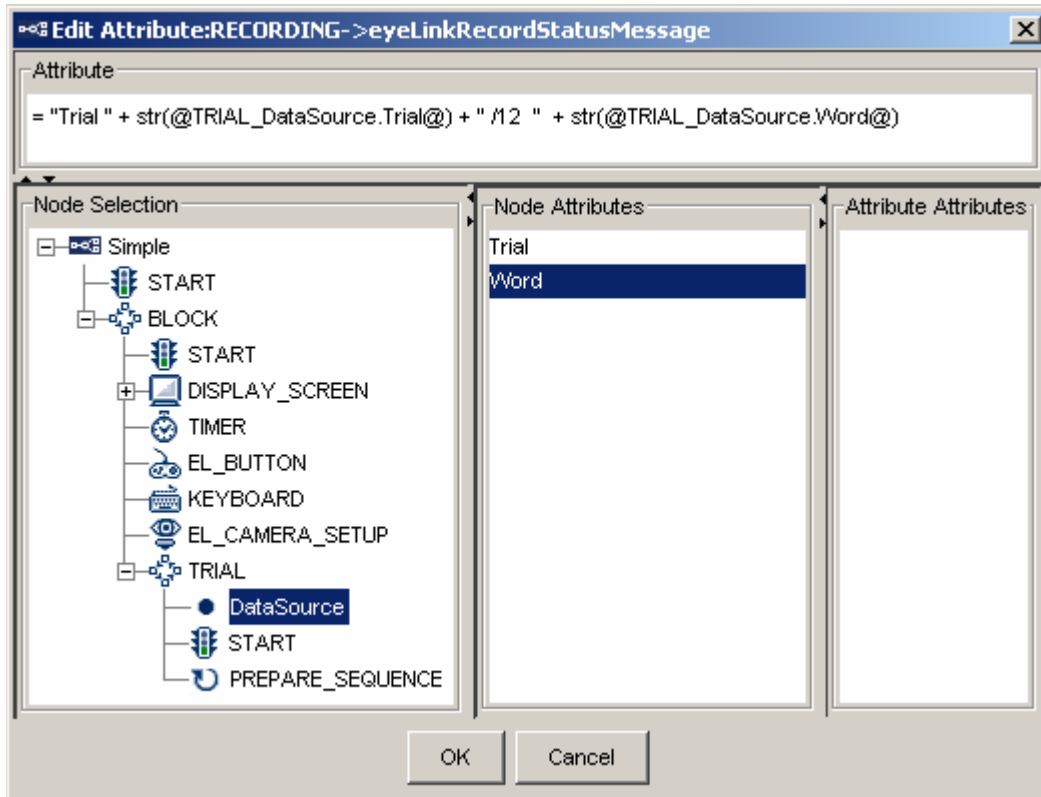

Figure 10-2. Creating Equations in Attribute Editor.

- Example 1: During recording, a text message can be displayed at the bottom of the tracker screen (e.g., like “Trial 1/12 One”) so that the experimenter knows the progress of experiment. To do that, the user should click on the “Recording” sequence node in the structure list to start. Double click on the right end of the value field of the “EyeLink© Record Status Message” property of the sequence to bring up the attribute editor. Enter a reference equation as

```
= "Trial " + str(@TRIAL_DataSource.Trial@) + "/12 "
+ @TRIAL_DataSource.Word@
```

- Example 2: To draw a text resource to the center of the display screen, the location of the text resource can be referred as:

```
= (@parent.width@/2, @parent.height@/2)
```

- Example 3: If to write the position of the text resource (TEXT_RESOURCE) in the data file using an SEND_EL_MSG action which is in the same sequence as the display screen (DISPLAY_SCREEN) that contains the text resource, the message property of the Send Message action can be referred as:

```
= "Text Location " + "x = " +
str(@parent.DISPLAY_SCREEN.TEXT_RESOURCE.location.x@) + " y= " +
str(@parent.DISPLAY_SCREEN.TEXT_RESOURCE.location.y@)
```

This will record a message similar to “MSG 11545029 Text Location x = 512 y= 384” in the EDF file.

- Example 4: This illustrates how to record in a data file the reaction time calculation for a button press (EL_BUTTON) following the onset of the display screen (DISPLAY_SCREEN), assuming that all actions and triggers are contained in the same sequence. The user can enter the following equation in the attribute editor:

```
= "Button pressed time " +
str(@EL_BUTTON.triggeredData.time@-@DISPLAY_SCREEN.time@)
```

This will record a message as “MSG 12818953 Button pressed time 1228.0” in the EDF file.

10.5 Reference Manager

All of the references used in the experiment graph can be reviewed and modified in a reference manager. The reference manager, accessed by clicking "Edit -> Reference Manager" from the application menu bar, tabulates the source, parent of source, property and value for each reference. The value of the reference can be modified with the help of attribute editor.

The Reference Manager can be used to search for/replace any reference entries that contain one particular string. To search for a string, enter the text (e.g., case sensitive) in the "Text to Find" edit box and press the ENTER key. Items that meet the search criterion will be displayed in the list. The user can adjust the search scope by selecting the appropriate sequences from the dropdown list. To replace a string, enter the text to be replaced in the "Text to Find" edit box and the text to replace in the "Replace With" edit box. Place the text insertion caret (the blinking vertical bar) in the "Replace With" edit box and press ENTER key to perform replacement. Press "Undo Replacement" button () to revert to the old references.

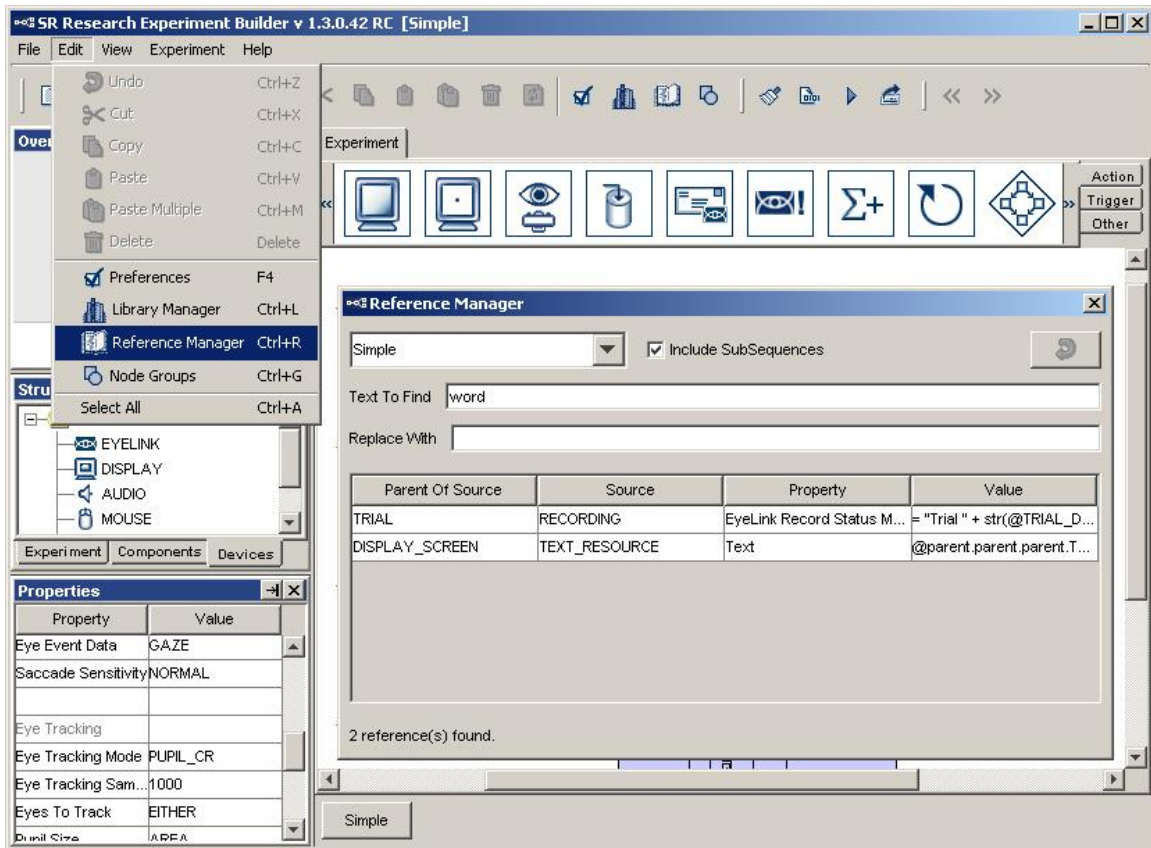

Figure 10-3. Using the Reference Manager.

11 EyeLink© Data Viewer Integration

It's always a good idea to think about data analysis while the experiment is still being designed. The designer may take advantage of the messaging functionality of the tracker and Experiment Builder (e.g., using the send message or log experiment action or using the "Message" property of the triggers and actions) to write out messages for critical events in a display for reaction time calculation, to send a Trial ID message, and so on. For some experiments, the designer may also try to create interest areas. Spending a couple of minutes on these small details may save hours in data analysis later. It's always a good idea to test at least one participant after creating the experiment and collect the recording data to examine timing accuracy and to check whether any critical information is missing.



Figure 11-1. Sending the Recording Status Message to the Tracker

In a similar vein, the user may also try to send a message to the tracker screen (see Figure 11-1). This can be used to show the progress of the experiment so that the experimenter can arrange a break in the middle of the experiment, for example. This message may also contain trial condition information so that the experimenter knows immediately which condition is being tested and therefore may be able to evaluate the performance of the participant. For some experiments, especially those involving a location trigger

(invisible boundary, fixation, saccade, or fast velocity), it might be helpful to draw some simple graphics on the tracker screen for feedback information (with EL_COMMAND action). In a saccade experiment, for example, the user may draw a box on the tracker screen to show the target location.

EyeLink© recording data (.EDF files) can be conveniently analyzed with the Data Viewer application. A set of messages can be written to the data file so that the Viewer can automate configurations for individual trials. Examples of such messages include defining images and simple drawings to be used as background for overlay display, specifying trial variables, creating interest areas, trial grouping, and so on.

11.1 TRIALID Message

For the convenience of data analysis, a trial ID message should be written to each trial so that the actual experiment condition under which the trial was conducted can be easily identified. Although the user may send such a message via the SEND_MESSAGE action, sending trial ID messages can be automated if the user utilizes the “EyeLink© DV Variables” property of the experiment node. When the user clicks on the experiment node, an “EyeLink© Trial ID” dialog box will be shown (see Figure 11-2). The “Available Variables” panel on the left lists all possible column labels in the data source and all newly created variables. The user can use the “Add” button (▶) and “Remove” button (◀) to select variables to be written to the trial ID message. The “Move Up” (▲) and “Move Down” (▼) buttons can be used to configure the order of the variables to be output. If the “Selected Variables” panel is not empty, a “!V TRIAL_VAR” message will be written to EDF data file for each of the condition variables and its corresponding value for each trial.

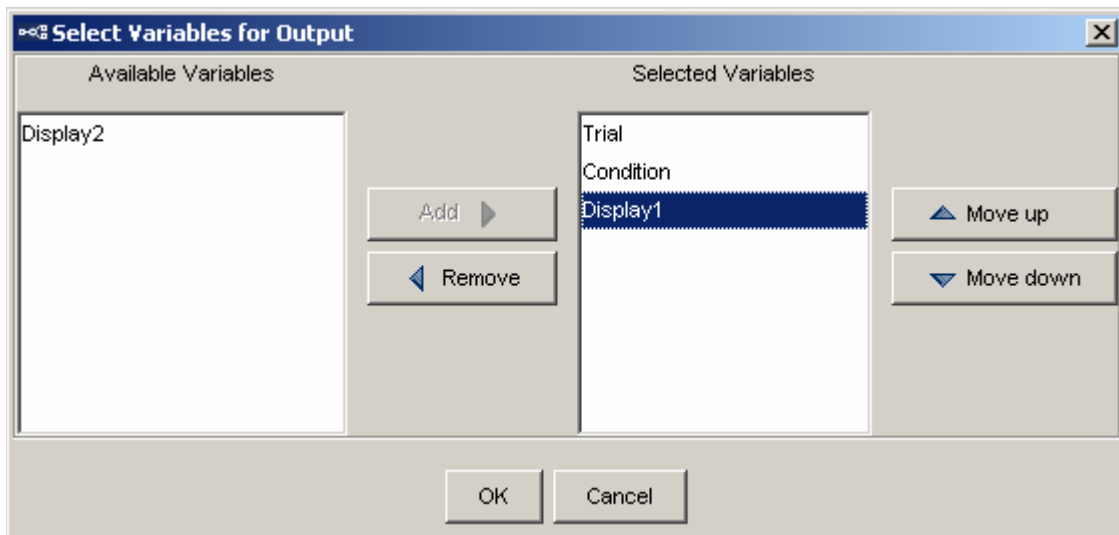

Figure 11-2. Editing Trial ID Message

11.2 Recording Status

During recording, a text message can be displayed at the bottom of the tracker screen so that the experimenter is informed of the progress of the experiment. To send such a

message, click on the recording sequence. Make sure that the “Record” property of the sequence is checked. Click on the right end of the value field of the “EyeLink® Record Status Message” Property. In the following attribute editor dialog, enter the message string (see Figure 11-3). For example, if the user has a data source with the variable list being “Trial Word” and the first line being “1 One”, the record status message can be:

```
= "Trial " + str(@TRIAL_SEQ_DataSource.Trial@) + "/4 "
+ @TRIAL_SEQ_DataSource.Word@
```

This will display a text like “Trial 1/4 One” on the tracker screen for the first trial.

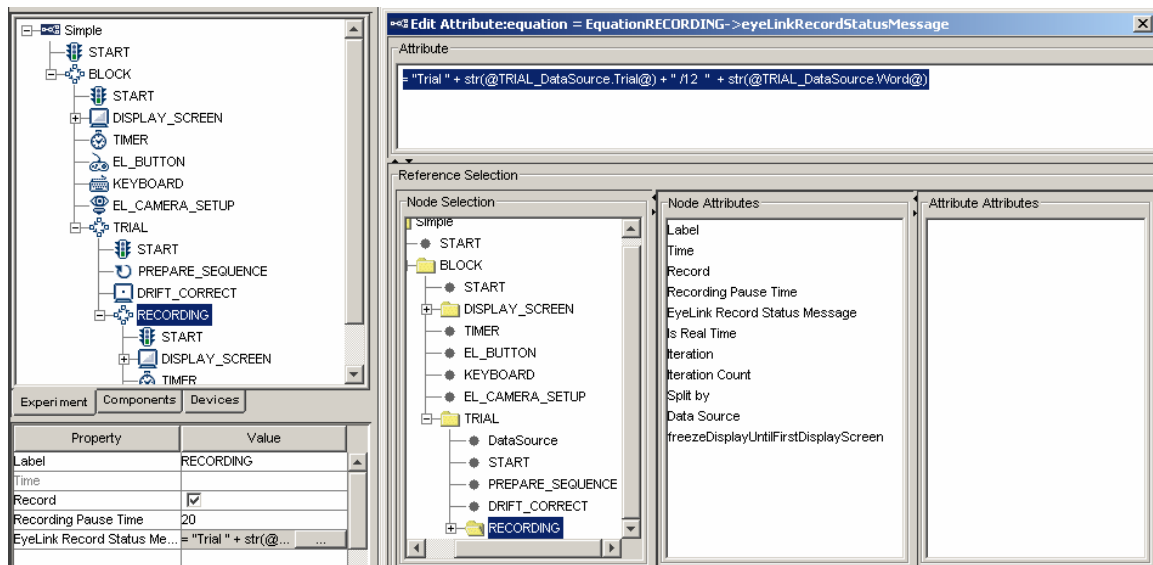

Figure 11-3. Creating Recording Status Message

11.3 Image and Interest Areas

If the "Send EyeLink® DV Messages" checkbox of a DISPLAY_SCREEN action is checked, a "!V DRAW_LIST" message will be recorded in the EDF file, specifying the images and simple drawings to be used as the background for the spatial overlay view of the trial within a viewing session.

```
MSG 12808461 -9 !V DRAW_LIST runtime/dataviewer/graphics/1116546752.vcl
```

Important: Please make sure that the "Prebuild to Image" box of each screen resource is checked. This will build the screen resource into an image and save it in an image file in the "\runtime\images" directory when the experiment is built. This ensures a better runtime performance as well having images available for Data Viewer analysis.

Important: Please note that your data analysis does not have to be limited on the original PC where the data collection was done. You may copy the whole {Experiment Name} folder to your data analysis computer. To make the data transfer easier (give so many files involved), you may first zip up the {Experiment Name} folder (keeping the directory structure) and then unzip the file on your data analysis computer.

If the user adds a blank screen at the end of the trial to clear display screen, please make sure that the "Send EyeLink© DV Messages" checkbox of that action is unchecked.

For some experiments, the user should also create interest areas so that future analyses can be done with ease. If a display screen contains interest areas, an interest area message will be written to the EDF data file to inform the viewer to re-create those interest areas during analysis.

```
MSG 63036 -13 !V IAREA FILE runtime/dataviewer/test/aoi/ias_1021582019659.ias
```

12 Custom Class

In addition to programming through the Graphical User Interface, Experiment Builder also allows the users to do custom scripting using the Python programming language. The current section explains how to create a new custom class, how to define class attributes and methods, how to instantiate a custom class object, and how to use the custom class object in the Experiment Builder GUI.

12.1 Enabling Custom Class Option

To create a custom class in an Experiment Builder project, please first check the project preference settings. Click "Edit -> Preferences", select "Experiment Preferences", and check the "Enable Custom Class" box. This will activate several node types for use in the experiment project: "Custom Class Instance", "Execute Action", and "Custom Class Tab of the Library Manager" (see below).

12.2 Creating a New Custom Class

To create a new custom class, click "Edit -> Library Manager". Select the "Custom Class" tab and click on the "New" button. In the following "File Name" dialog box, enter the intended custom class file name *. You may also create a new custom class by loading a python file (.py). This can be done by clicking the "Add" button.

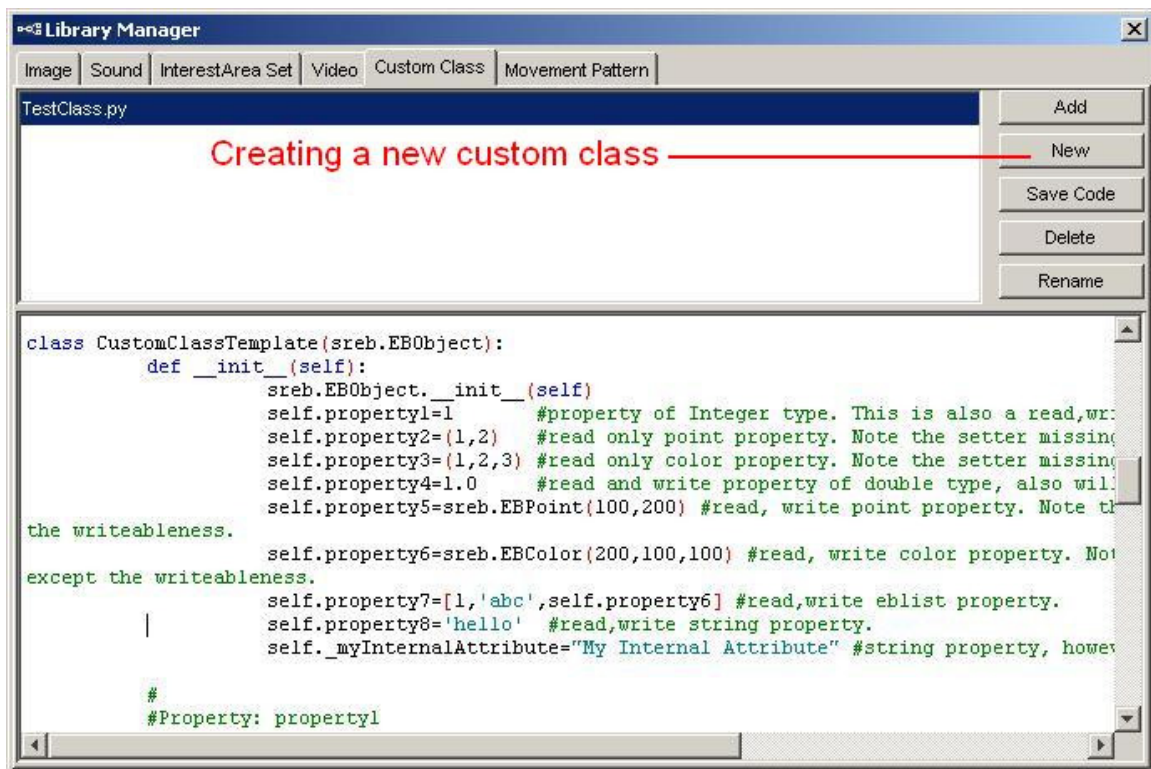

Figure 12-1. Creating a New Custom Class

* There are some restrictions in the file naming.

- 1) The file name cannot use any of the following reserved words (name of a package that already exists in the python library path): ctypes, numpy, py2exe, pyasio, pygame, pylink, pypsi, pythonwin, serial, sreb, win32, and wxPython.
- 2) The file name cannot have spaces or non-ANSI characters.
- 3) The file name cannot contain . other than for the use of extension .py.

12.3 Syntax of Custom Class

Custom Classes are written using the Python programming language. As such, an understanding of the Python programming language is necessary before creating a Custom Class in Experiment Builder. Please refer to the Python documentation if you are not familiar with Python.

While a custom class is written in Python, a set of rules is used by the Experiment Builder GUI to parse the custom class and display the properties of the class in the Experiment Builder GUI. It is critical that these rules, described later in this section, are understood as you define your custom class so that access to class attributes and methods is possible from within the rest of the experiment. The following explains the basics of creating a custom class in Experiment Builder with an example.

12.3.1 Example

Line 001:	import sreb
Line 002:	
Line 003:	class CustomClassTemplate(sreb.EBObject):
Line 004:	def __init__(self):
Line 005:	sreb.EBObject.__init__(self)
Line 006:	self.property1=1
	#property of Integer type. This is also a read,write property. see the getter and setter
Line 007:	self.property2=(1,2)
	#read only point property. Note the setter missing for this property.
Line 008:	self.property3=(1,2,3)
	#read only color property. Note the setter missing for this property.
Line 009:	self.property4=1.0
	#read and write property of double type, also will not accept references or equation.
Line 010:	self.property5=sreb.EBPoint(100,200)
	#read, write point property.
	#Note this property is similar to proprty2 except the writeableness.
Line 011:	self.property6=sreb.EBColor(200,100,100)
	#read, write color property.
	#Note this property is similar to proprty3 except the writeableness.
Line 012:	self.property7=[1,'abc',self.property6]
	#read,write eblast property.
Line 013:	self.property8='hello'
	#read,write string property.
Line 014:	self._myInternalAttribute="My Internal Attribute"
	#string property, however this is hidden from the interface.
Line 015:	
Line 016:	#
Line 017:	#Property: property1

Line 018:	#A read and write integer type property
Line 019:	def setProperty1(self,c):
Line 020:	self.property1=c
Line 021:	
Line 022:	def getProperty1(self):
Line 023:	return self.property1
Line 024:	
Line 025:	#
Line 026:	#Property: property2
Line 027:	#A read only property. The type will be treated as a point(EBPoint)
Line 028:	def getProperty2(self):
Line 029:	return self.property2
Line 030:	
Line 031:	def getProperty3(self):
Line 032:	return self.property3
Line 033:	
Line 034:	#
Line 035:	#Callable method using Execute action.
Line 036:	#Note the default arguments and the doc string
	#to let eb know what is the expected return type.
Line 037:	def myMethod(self,param1,param2=[100,1,1,1], param3=(100,100,50),
	param4=(50,75),param5="hi"):
Line 038:	"""RETURN:[1000,2000,3000]""" #The first line of the doc of method
	is used to get the return type of the method. return [1000,2000,3000]
Line 039:	
Line 040:	
Line 041:	#internal method
Line 042:	def _myInternalMethod(self):
Line 043:	pass
Line 044:	
Line 045:	#
Line 046:	#Property: property4
Line 047:	#A read and write float type property
Line 048:	def setProperty4(self,c=5.7):
Line 049:	self.property4=c
Line 050:	
Line 051:	def getProperty4(self):
Line 052:	return self.property4
Line 053:	
Line 054:	#
Line 055:	#Property: property5
Line 056:	#A read and write EBPoint type property
Line 057:	def setProperty5(self,c):
Line 058:	self.property5=c
Line 059:	
Line 060:	def getProperty5(self):
Line 061:	return self.property5
Line 062:	
Line 063:	#
Line 064:	#Property: property6
Line 065:	#A read and write EBColor type property
Line 066:	def setProperty6(self,c):
Line 067:	self.property6=c
Line 068:	
Line 069:	def getProperty6(self):
Line 070:	return self.property6

Line 071:	
Line 072:	#
Line 073:	#Property: property7
Line 074:	#A read and write list type property
Line 075:	def setProperty7(self,c):
Line 076:	self.property7=c
Line 077:	
Line 078:	def getProperty7(self):
Line 079:	return self.property7
Line 080:	
Line 081:	#
Line 082:	#Property: property8
Line 083:	#A read and write string type property
Line 084:	def setProperty8(self,c):
Line 085:	self.property8=c
Line 086:	
Line 087:	def getProperty8(self):
Line 088:	return self.property8
Line 089:	
Line 090:	

12.3.2 Class Definition

A Python class starts with the reserved word "class", followed by the class name. Each word in a class name is usually capitalized; but this is only a convention, not a requirement. Python functions have no explicit begin or end, and no curly braces to mark where the function code starts and stops. The only delimiter is a colon (:) and the indentation of the code itself. Everything in a class is indented.

```
class ClassName(BaseClasses):
    statement(s)
```

The class name of the above example is CustomClassTemplate (Line 003). In Python, the ancestor of a class is simply listed in parentheses immediately after the class name. All custom classes in Experiment Builder must inherit sreb.EBObject class (Line 003) and import sreb module (Line 001). If a class starts with _ then it is considered internal and will not be treated as a custom class.

12.3.3 Class Initialization

The body of the class is where you normally specify the attributes and methods of the class. An Experiment Builder custom class always starts with a __init__(self) method (Line 004). This method is used to initialize the CustomClassTemplate class. The first argument of every class method, including __init__, is always a reference to the current instance of the class. By convention, this argument is always named self. The custom class __init__ method will only use the default constructor (i.e., a constructor with only self parameter or any other parameter with default arguments. If any default arguments passed in, only the default arguments will be used.).

```

def __init__(self):
    sreb.EBObject.__init__(self)

    #list of attributes
    self.identifier = value

```

12.3.4 Class Attributes

Within the `__init__` method, the constructor must call `sreb.EBObject`'s constructor (Line 005). Following this, all of the possible attributes and methods used in the class should be listed. Attributes of the class are specified by binding a value (1 for Line 006) to an identifier (`self.property1` for Line 006). All of the attributes used in the class must start with "self.". The attribute identifier must be an alphanumeric string and start with a lowercase letter; if the property starts with an `_` (underscore) or an upper-case letter, then the property is treated as internal. For example, "self.thisIsAnExmample" and "self.example2" are valid custom class attributes whereas "self.2Example", and "self.badString\$" are not valid.

The data type of the class attribute is determined by the initial value assigned to the attribute. Known supported data types are `int`, `float`, `str`, `EBPoint`, `EBColor`, `tuple`, and `list`. For example (Line 006), `self.property1` attribute has an initial value of 1. As a result, this class attribute is an integer. The following table lists typical data types used in a custom class.

Attribute Value	Data Type	Usage
'Hello'	String	Example: Line 013
"Hello"	String	<code>self.myString = "This is another string"</code>
1	Number (Integer)	Example: Line 006
1.0	Number (Float)	Example: Line 009
True	Boolean	<code>self.property=True</code>
False	Boolean	<code>self.property=False</code>
(100,100)	Point	Example: Line 007 If an attribute's default value is of tuple type and only has two items, the property will be treated as an <code>EBPoint</code> . The parameter of the <code>setX</code> method and the return type of the <code>getX</code> method is expected to be the same as the attribute type.
<code>sreb.EBPoint(100,200)</code>	Point	Example: Line 010
(1,2,3)	Color	Example: Line 008 If an attribute's default value is a tuple of 3 items, the property will be treated

		as an EBColor. The parameter of the setX method and the output type of the getX method is expected to be the same as the type of the attribute.
sreb.EBColor(200,100,100)	Color	Example: Line 011
[1,'abc',self.property6]	List	Example: Line 012
list()	List	self.myList = list() This creates an empty list.
None	Unknown Type	self.unknownType = None

12.3.5 Class Methods

Methods in a class are defined by a def statement. The def statement is a single clause statement with the following syntax:

```
def function-name(self, [parameter list]):
    statement(s)
```

All of the code within the function is indented. Unlike other python functions, a method defined in a class body always has a mandatory first parameter self. In addition to the first mandatory parameter self, the user can pass a variable comma-separated list of parameters to the functions. Zero or more mandatory parameters may be followed zero or more optional parameters, whereas each optional parameter has the following syntax:

```
identifier = expression
```

The code segment below illustrates a function named doMyCalculations, which takes three parameters, x, y, and items. The last parameter items is optional as it has a default value.

```
def doMyCalculations(self, x, y, items = 2):
    """RETURN: 1 """

    if items == 2:
        return x
    else:
        return y
```

By default, the return type of a method is string unless a doc string with the following constraint is available.

- The doc string is a multi-line string flanked by a triple quotes. Everything between the start and end quotes is part of a single string, which documents what the function does. A doc string, if it exists, must be the first thing defined in a function (that is, the first thing after the colon). You don't technically need to give your function a doc string, but you always should.

- The doc string should start with a "RETURN:" text (case sensitive).
- Following the "RETURN:" text, provide a default value of the type or the `__repr__` value of the class (e.g., str for string).

12.3.6 'setX' and 'getX' Methods

Method name starting with 'set' and 'get' are assumed to operate on the class attributes and are handled differently from regular custom class methods.

```
def __init__(self):
    sreb.EBObject.__init__(self)
    self.myProperty=1

#Property: myProperty
#A read and write integer type property
def setMyProperty(self,c):
    self.MyProperty=c

def getMyProperty(self):
    return self.myProperty
```

To allow the getX and setX methods to operate directly on a class attribute x, the following syntax rules must be followed:

- The class attribute identifier must be an alphanumeric string and start with a lowercase letter (e.g, use `self.myProperty` instead of `self.MyProperty`).
- The getX and setX method name should be composed of 'set' and 'get' string and the attribute identifier, with the first letter of the identifier capitalized (e.g., `getMyProperty` instead of `getmyProperty`). The getX and setX methods that do not follow this rule will be treated as regular class methods.
- The getX method shouldn't take extra parameter except for the mandatory parameter `self`.
- The setX method expects an extra parameter. To support attribute referencing of that property in Experiment Builder, do not give a default value for the parameter. For example,

```
def setEBAttrib(self,value):
```

That is, the attribute `EBAttrib` should be able to be set to a reference. If a default value is assigned to the setX method, this would tell the Experiment Builder that the attribute `nonEBAttrib` should not be able to be set to a reference. For example,

```
def setNonEBAttrib(self,value=0):
```

A class attribute that has a corresponding `getX` method is a readable attribute. A class attribute that has a corresponding `setX` method is a writeable attribute. An attribute is a readable and writeable property if it has corresponding `getX` and `setX` methods.

12.4 Instantiating Custom Class

Once a custom class is defined, users can instantiate the class by creating a concrete instance of that class. To do that, click on the other tab of the component tool box and add a Custom Class Instance node to the experiment graph.

Select the newly added custom class instance node. Click on the value field of the "Custom Class" property. Select the custom class from a dropdown list. Once the class is loaded, attributes and methods are listed in alphabetical order in the property table. The "Attribute" section lists all of the class attributes that has a corresponding `getX` method.

- Those attributes having a `getX` method only but without a corresponding `setX` method will be read-only and is not directly modifiable (see attributes `property2` and `property3` in 3.1 example).
- Those attributes that have both a `getX` method and a `setX` method without a default value for the parameter are both readable and writeable. These attributes should be able to be set to a reference (see attributes `property1`, `property5`, `property6`, `property7`, and `property8` in 12.3.1 example).
- Those attributes that have both a `getX` method and a `setX` method with a default value are readable and writeable. However, these attributes cannot be set to a reference (see attributes `property4` in 12.3.1 example). Those attributes having a `setX` method but not a `getX` method will not be displayed in the attribute section. The `setX` method will be displayed as a regular methods.

The "Methods" section lists all methods available for the class (see `myMethod` of the 12.3.1 example) except for the `__init__`, `getX`, and `setX` methods mentioned above.

Properties	
Property	Value
Label	CUSTOM_CLASS_INST...
Type	CustomClassInstance
Node Path	CUSTOM_CLASS_INST...
Custom Class	TestClass.Custom...
Attributes	
property1	1
property2	1, 2
property3	
property4	1.0
property5	100, 200
property6	
property7	[1,"abc",EBColor(200,1...
property8	hello
Methods	
myMethod	

Figure 12-2. Attributes and Properties of a Custom Class Instance

12.5 Using Custom Class

The interaction between the custom class and the Experiment Builder graph is done through attribute reference, and the Execute, Sequence, and Update_Attribute actions. With these options, the user can set values for the class attributes and pass parameters to the class methods. Conversely, the user can also retrieve the current value of a class attribute and access the return value of a class method.

The bi-directional direct exchange of data between the custom class attributes and experiment builder GUI is supported by the getX and setX methods. For class attributes with a corresponding setX method (without a default value as the function parameter), the user can set a value, an equation, or a reference for the class attribute directly in the custom class instance. Of course, the user can also use an Update Attribute action to set a value/reference for a class attribute. Similarly, if a class attribute has a corresponding getX method, its current value can be retrieved and used directly much like any other EB components (e.g., a variable).

Property	Value
Label	CUSTOM_CLASS_INSTANCE
Type	CustomClassInstance
Node Path	BLOCK.CUSTOM_CLASS_INSTANCE
Custom Class	test.CustomClassTemplate
Attributes	
property1	1
property2	1, 2
property3	
property4	2.0
property5	=(@TRIAL.TRIAL_DataSource.width@, @TRIAL.TRIAL_DataSource.height@)
property6	@Color.value@
property7	[1, "abc", EBColor(200,100,100)]
property8	@TRIAL.TRIAL_DataSource.image@
Methods	
myMethod	

- Assigning a value directly
- Read-only attribute
- Entering an equation
- Referring to other attribute
- Referring to Datasource

Figure 12-3. Assigning Attribute Values through Custom Class Instance

The user can call a class method through the Execute action or the "Callback" property of a Sequence. Values can be passed from the Experiment Builder GUI to the custom class through the argument list of a class method (see the figure below).

4. Pass parameters to the method

Figure 12-4. Data Exchange through Execute Action

In addition, a value can be returned from the custom class to the Experiment GUI through the return value of a class method. Please note that the return type of a method is string by default unless a doc string is used to specify the data type of the return value.

12.6 Using Custom Class Editor

To edit the content of a custom class, users may use the simple text editor in the custom class tab of the library manager. Alternatively, users can edit the custom class code directly by double clicking on a custom class instance and opening a custom class editor tab. The custom class editor provides much more functionality than the simple text editor in the library manager. The following table summarizes the tools available for code editing using the built in custom class editor.

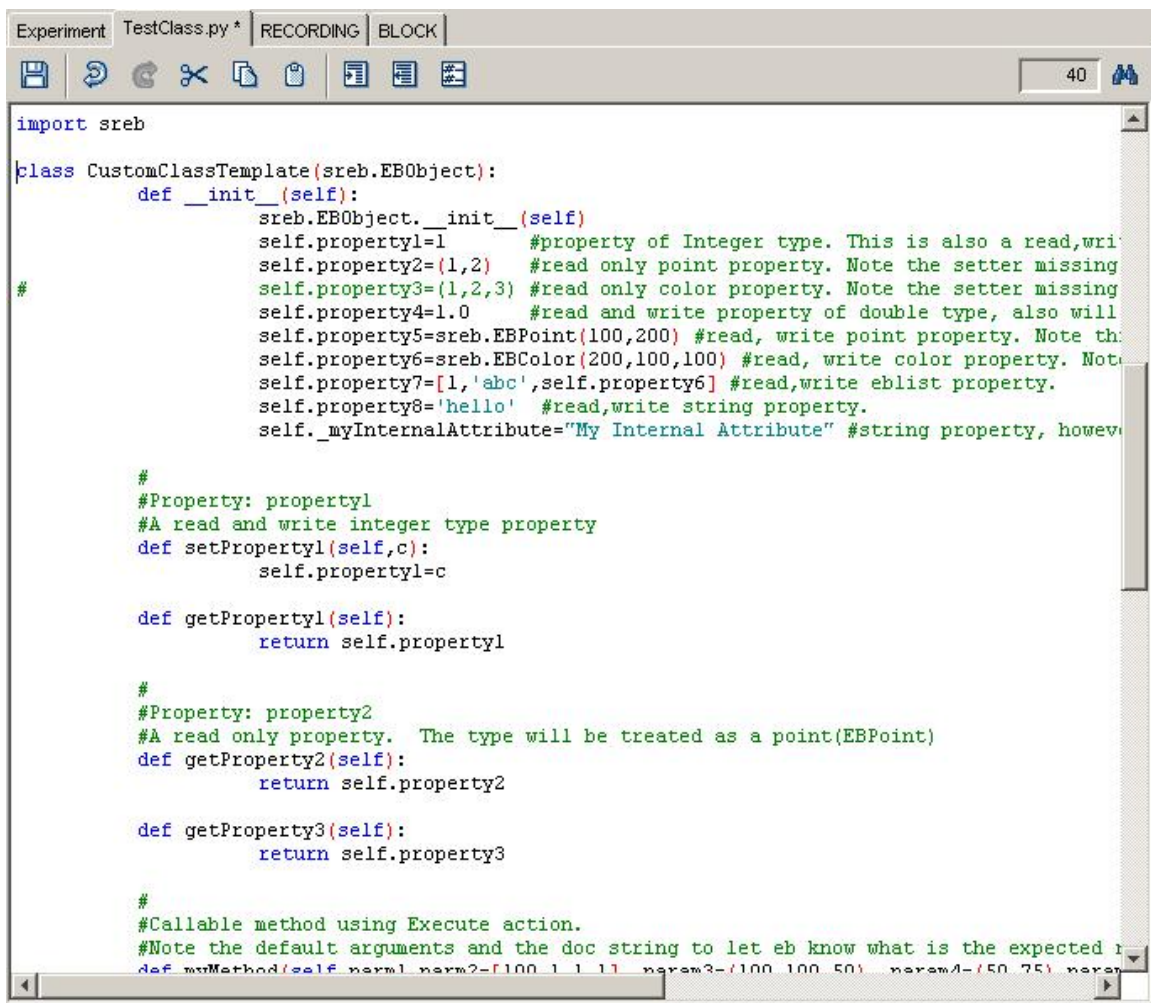













Figure 12-5. Custom Class Code Editor

Custom Class Editor Toolbar

Operation	Short Cut	Function
 Save Code	CTRL + S	Save the custom class code.

 Undo	CTRL + Z	Undo the last change made to the custom class editor.
 Redo		Redo the last change made to the custom class editor.
 Cut	CTRL + X	Removes a selection from the project and place it into the clipboard.
 Copy	CTRL + C	Puts a copy of a selection to the clipboard.
 Paste	CTRL + V	Inserts the previously copied item from the clipboard to the current position.
 Increase Indent		Inserts a tab space before the current code.
 Reduce Indent		Removes a tab space before the current code.
 Comment		Creates comment. This will add a comment symbol "#" in front of the current line of code.
 112 Go to Line		Go to a specified line.
 Find/Replace		Search or replace a specified text string in the custom class code.

13 Creating Experiments: Overview

The easiest way to start developing EyeLink© experiments is to study the supplied templates included with the Experiment Builder kit (installed in a subdirectory of “C:\Program Files\SR Research\Experiment Builder\Examples”). Each of these experiment templates illustrates a typical experimental paradigm. The following table provides a brief description of the experiments.

Experiment	Purpose
Simple	The basic experiment template, displaying a single word in the center of the screen in each trial. This example is used to introduce how to create an experiment with SR Research Experiment Builder step by step.
Stroop	The basic template for creating non-EyeLink experiments. This template illustrates the use of result file, RT calculation, and audio feedback, etc.
Picture	Illustrates various parameter settings for showing an image on the screen (in original size versus stretched, centered versus not centered).
TextLine	Experiment to show a single line of text, illustrating the use of runtime interest area.
TextPage	Experiment to show a full screen of text using a multi-line text resource.
GCWindow	Demonstrates how to use real-time gaze position to display a gaze-contingent window.
Track	Displays the user’s current gaze position during recording and illustrates how to set the resource position contingent on the current gaze position.
Change	Displays several almost identical screens rapidly. It also illustrates the use of the fixation trigger.
Saccade	Illustrates the creation of a simple experiment for saccade/anti-saccade research.
Pursuit	Illustrates several kinds of sinusoidal movement in a pursuit task.

The discussion of the “simple” template must be read before working with any of other templates, as it illustrates most of the shared operations for all experiments. You may go over the “Stroop” example for creating non-eye tracking experiments. In general, you should read through all of the templates before programming your own experiment. When creating your experiment, you may also refer to the check list in Chapter 16.

14 Creating EyeLink Experiments: The First Example

To create an Experiment with SR Research Experiment Builder, the user needs to take the following three steps:

- Create an Experiment
- Build and test run the Experiment
- Deploy the Experiment

Following these, a set of files are generated so that the experiment can be run for data collection without relying on the Experiment Builder application. To illustrate the use of Experiment Builder, we are going to create a very simple eye-tracking experiment which runs three blocks of four trials. In each trial, a single word is displayed in the center of the screen (see the “SIMPLE” template of the EyeLink© C programming API).

14.1 Creating the Experiment

The current section provides a step-by-step tutorial to walk you through the basics of creating an experiment with SR Research Experiment Builder.

14.1.1 Creating a New Experiment Session

Click on the Experiment Builder to start a new session. When the application starts:

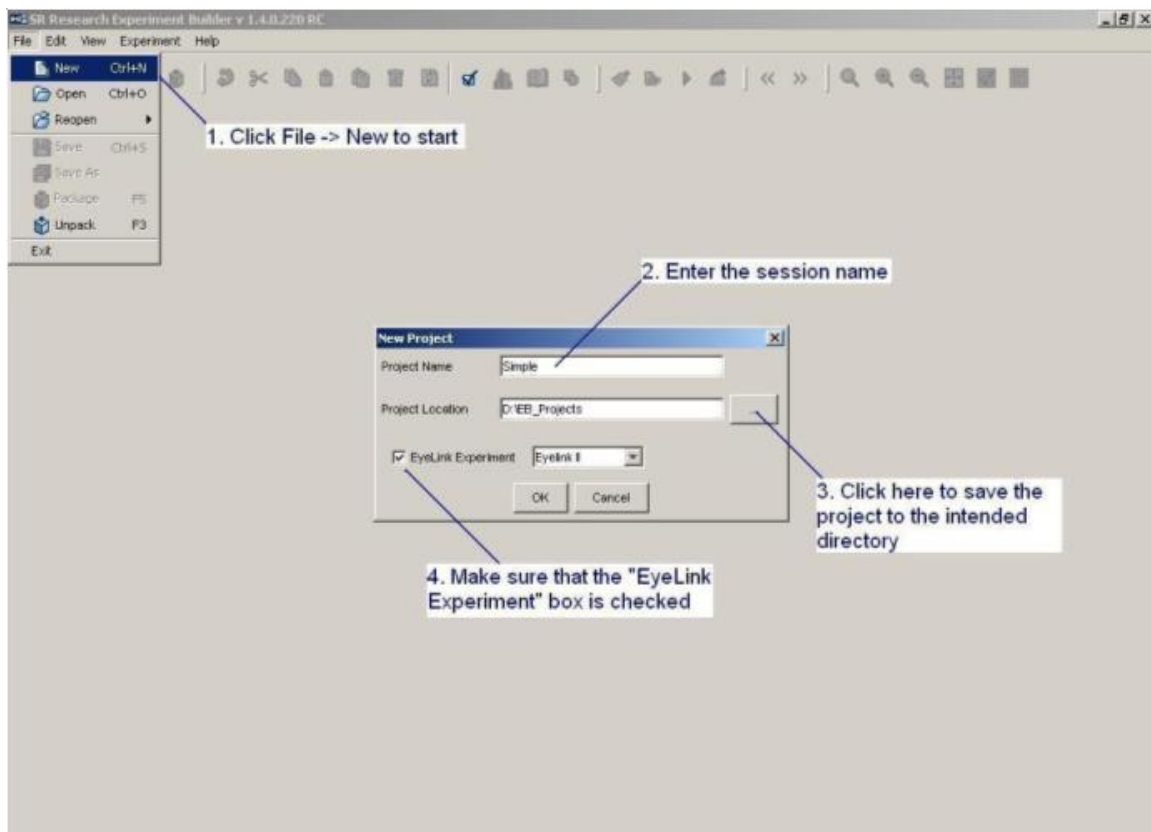
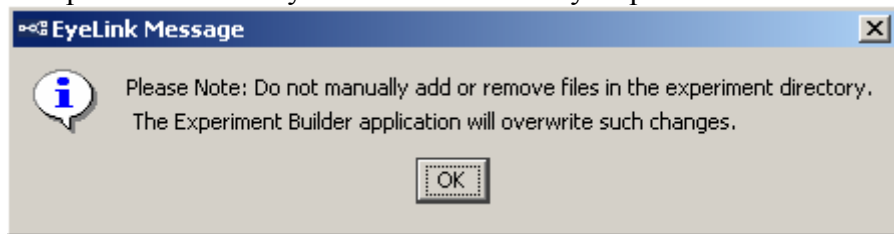

Figure 14-1. Creating a New Experiment Builder Session

- 1) Click on “File → New” on the application menu bar.
- 2) In the following “New Project” dialog box, enter “Simple” in the “Project Name” edit box.
- 3) Click on the button on the right end of the “Project Location” to browse to the directory where the experiment project should be saved. If you are manually entering the “Project Location” field, please make sure that the intended directory already exists.
- 4) Make sure that “EyeLink Experiment” box is checked for an EyeLink experiment.

Please note that the user shouldn't manually add or remove files in the experiment directory. To maintain file integrity for the experiment projects created, any changes made to the experiment directory will be overridden by Experiment Builder.



14.1.2 Configuring Experiment Preference Settings

After a new experiment session is created, the user needs to check whether the default display and screen preference settings are fine for the experiment to be created.

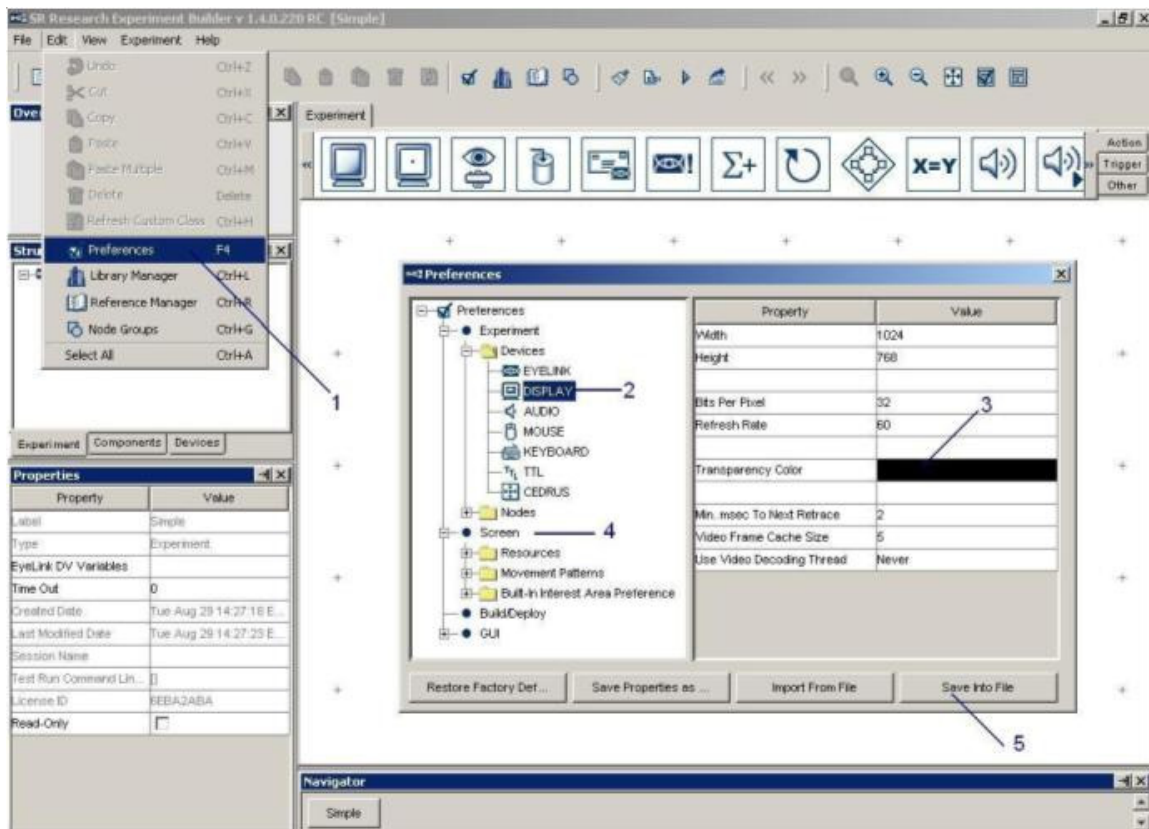

Figure 14-2. Configuring Preference Settings

- 1) Select “Edit → Preferences” from the application menu bar or press shortcut key “F4”.
- 2) Click on “Preferences → Experiment → Devices → Display” to check display settings. Make sure that the settings (Width, Height, Bits per Pixel, and Refresh Rate) used in the current example are supported by your video card and monitor.
- 3) Click on “Preferences → Screen” to check Screen Builder settings. Set the Location Type as “Center Position”.
- 4) To make the text looks better, the user may enable the anti-aliasing function (see Section 8.1.3.2“Anti-aliasing and Transparency”). If this is the case, please click on “Preferences → Screen” to enable “Antialiasing Drawing”. In addition, click on “Preferences → Experiment → Devices → Display” to set the transparency color value to something similar, but not identical, to the background used in the display screen. In the current example, the user may set the RGB value of the transparency color to (251, 250, 251). Anti-aliasing may be enabled in experiments using Text or primitive drawings shown on a uniform background.
- 5) If any of the above settings have been changed and if you want to keep the new settings as defaults for all of your future experiments, click on the button “save properties as default”.

EyeLink I and 1000 users: The default tracker version is set to EyeLink II. EyeLink I and 1000 users should also make sure that the "Tracker Version" setting in the "Preferences -> Experiment -> Devices -> EyeLink" preferences is set to EyeLink I or EyeLink 1000.

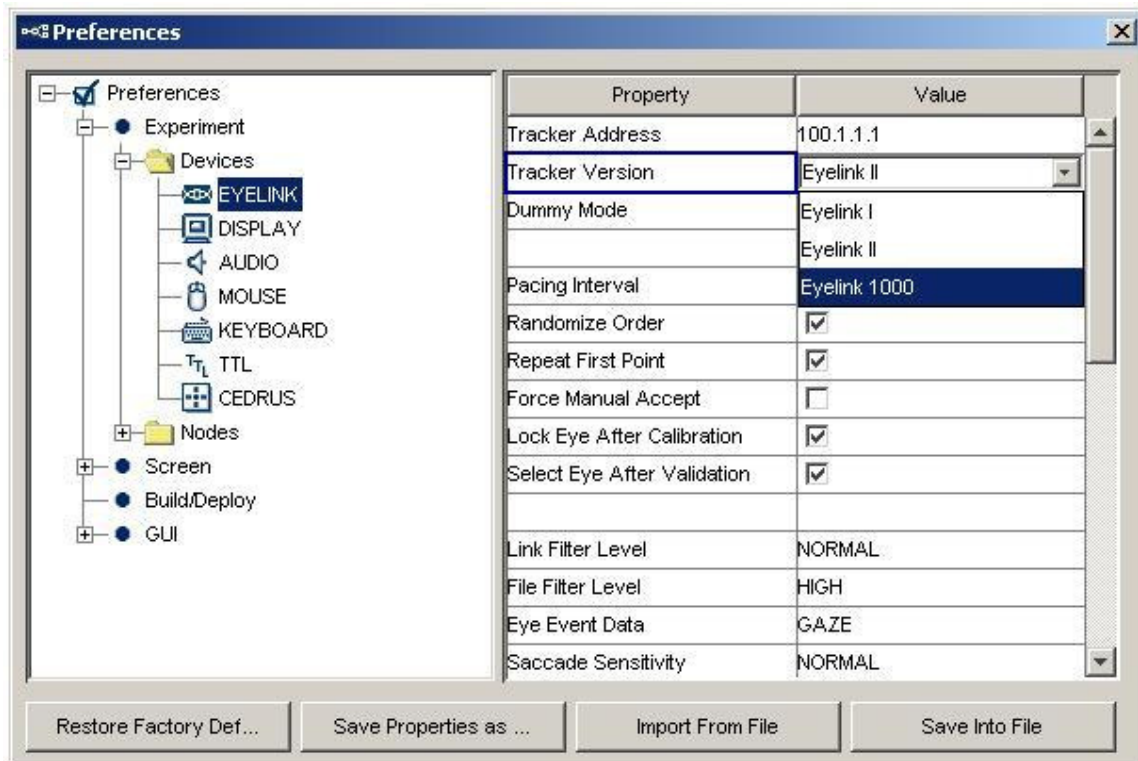

Figure 14-3. Setting the Tracker Version for the Experiment

In addition, the user needs to check whether the intended experiment contains any non-ASCII characters. If this is the case, the “Encode Files as UTF8” setting in “Preferences → Build/Deploy” should also be enabled. Failing to do so will result in the following build/run time warning:

WARNING: warning:2001 You are using characters that ascii encoding cannot handle! Please change your encoding!

Chinese, Japanese and Korean Users: Please make sure that the "Encode Files as UTF8" setting in "Preferences -> Build/Deploy" setting is always enabled; otherwise you may see the following error:

ERROR: error:2070 Internal Error. Could not create script. Please contact SR Research! Sorry: MemoryError: ()

This may have caused by an invalid encoding. Try using UTF8 encoding.

14.1.3 Creating Experiment Block Sequence

In this example, we are going to run three blocks of four trials. The first step is to add a block sequence for repeating blocks (see Figure 14-4).

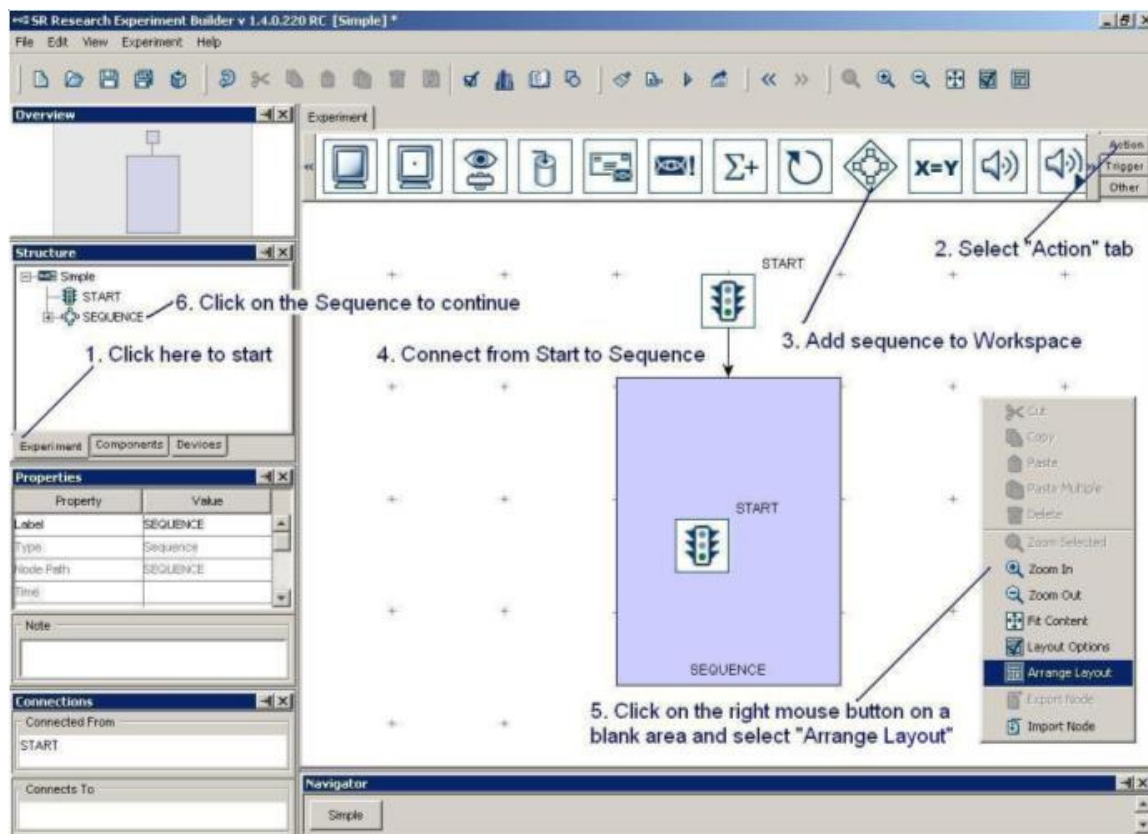

Figure 14-4. Creating Experiment Block Sequence

- 1) Click on the Experiment Tab in the Project Explorer Window to start.

- 2) Click on the “Action” Tab of component toolbox.
- 3) Select the “Sequence” node, hold down the left mouse button and drag it into the work area.
- 4) Place the mouse cursor on top of the “START” node, hold down the left mouse button while moving the mouse cursor on top of the “SEQUENCE” node. This makes the connection from the “START” node to “SEQUENCE” node. (Note: don’t make a single or double click on the “START” node as this will *select* the node instead. If you have done so, place the mouse cursor on a blank area in the work space and make a single click there. Redo the current step again.)
- 5) Click on any blank area in the work window. Click the right mouse button and select "Arrange Layout" in the popup menu. This will re-arrange the nodes in a hierarchical fashion
- 6) Click on the SEQUENCE node in the structure list to continue.

14.1.4 Editing Block Sequence

Next, we will need to edit the properties of the Block Sequence. This involves changing the “Label” of the sequence to make it more meaningful and changing the “iteration count” to the actual number of blocks to be tested (see Figure 14-5). (Please note here, we do not edit the “Split by” field.)

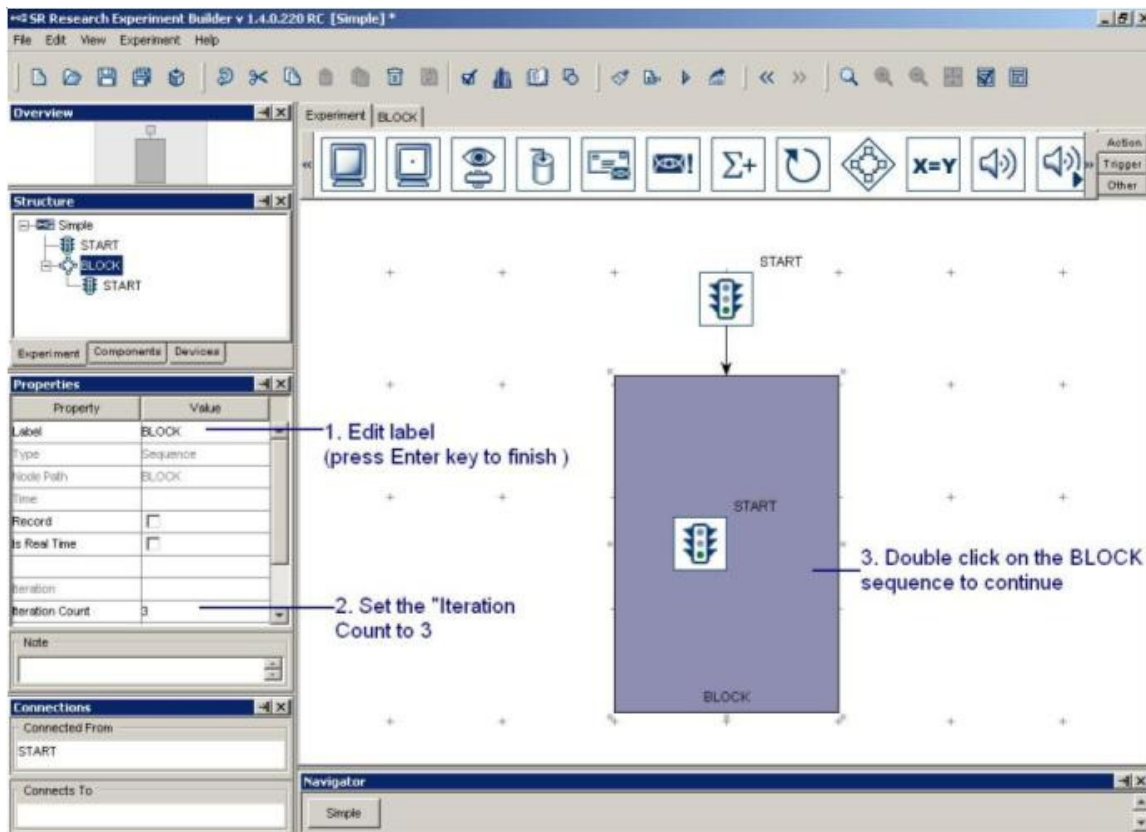

Figure 14-5. Editing Block Sequence

- 1) Click on the value field of the “Label” property of the Sequence created. Write “BLOCK” in the text editor and press the ENTER key to finish.
- 2) Click on the “Iteration Count” value field and enter “3” as the total number of sequence loops.
- 3) In the experiment Work Space, double click on the Sequence object to continue.

In each block, we will first give an instruction, perform a camera setup, calibration, and then run four trials (see Figure 14-6).

- 1) Click on the “Action” Tab of the component toolbox, select the “Display screen” action, hold down the left mouse button and drag the action into the work area.
- 2) Click on the “Trigger” Tab of the component toolbox, select the “Keyboard” trigger, hold down the left mouse button and drag the action into the work area.
- 3) Add an “EyeLink© Button” trigger to the work space.
- 4) Add a “Timer” trigger to the work space.
- 5) Click on the Timer trigger and set the duration to 20000 msec.
- 6) Click on the “Action” Tab of the component toolbox and add a “Camera Setup” action to the work space. Click on the action and set the “Background Color” to white (255, 255, 255).
- 7) Click on the “Action” Tab of toolbox and add a “Sequence” node to the work space. This will be our trial sequence.
- 8) Place the mouse cursor on top of the “START” node. Hold down the left mouse button while moving the mouse on top of the DISPLAY_SCREEN node. This makes the connection from the “start” node to the “DISPLAY_SCREEN” node.
- 9) Similarly, connect from “DISPLAY_SCREEN” to KEYBOARD, EL_BUTTON, TIMER triggers. Note that a number is added to these connections, indicating the evaluation order among the three trigger types.
- 10) Make the connection from the latter three triggers to the “EL_CAMERA_SETUP” node and from “EL_CAMERA_SETUP” to the SEQUENCE node.

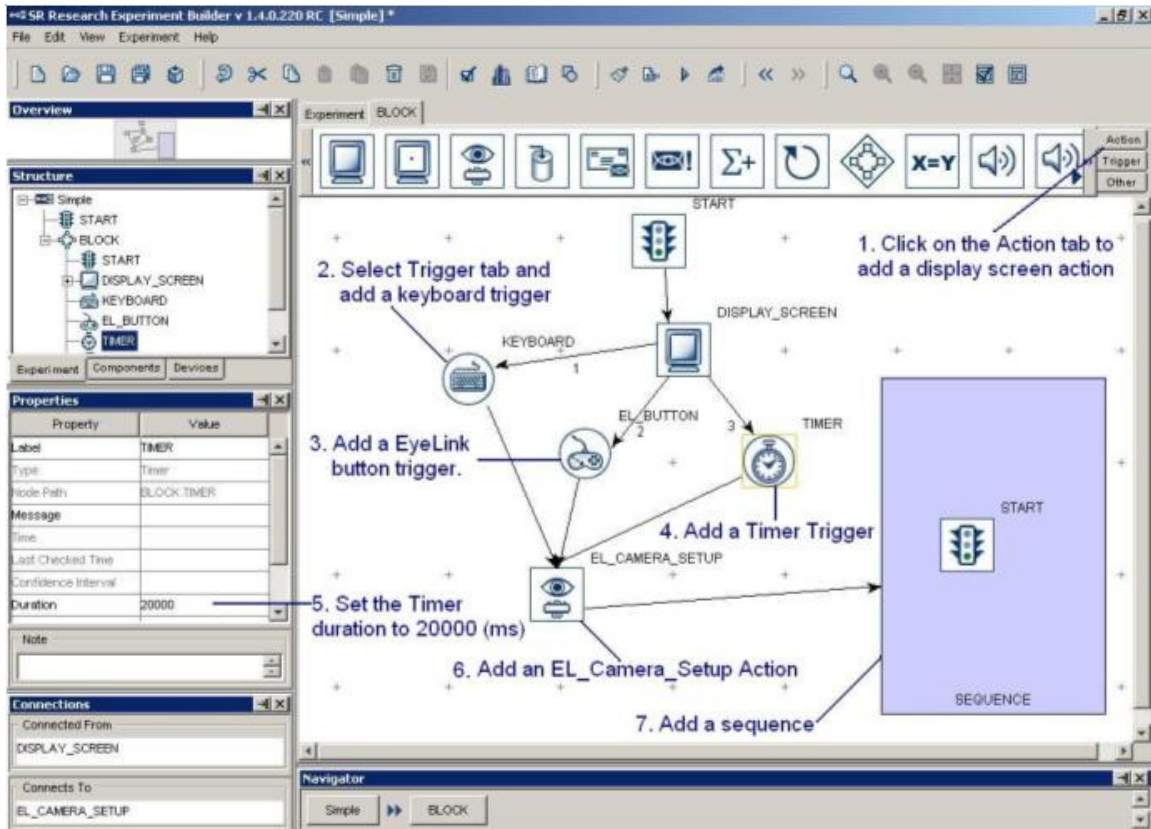

Figure 14-6. Adding Instruction to Block Sequence

- 11) Click at any blank area in the work window. Click the right mouse button and select "Arrange Layout" in the popup menu. This will re-arrange the nodes in an orderly fashion.
- 12) Double click on the "DISPLAY_SCREEN" object in the work space (not from the structure list) until the Screen Builder interface is displayed in the Graph Editor Window.

14.1.5 Creating Instruction Screen

The user may want to provide instruction to the participants at the beginning of the experiment. This can be done by creating an image file containing the experiment instructions and then using DISPLAY_SCREEN action to show the image. The instruction text can also be created with the multiline text resource. In the current example, we illustrate the use of multiline text resource.

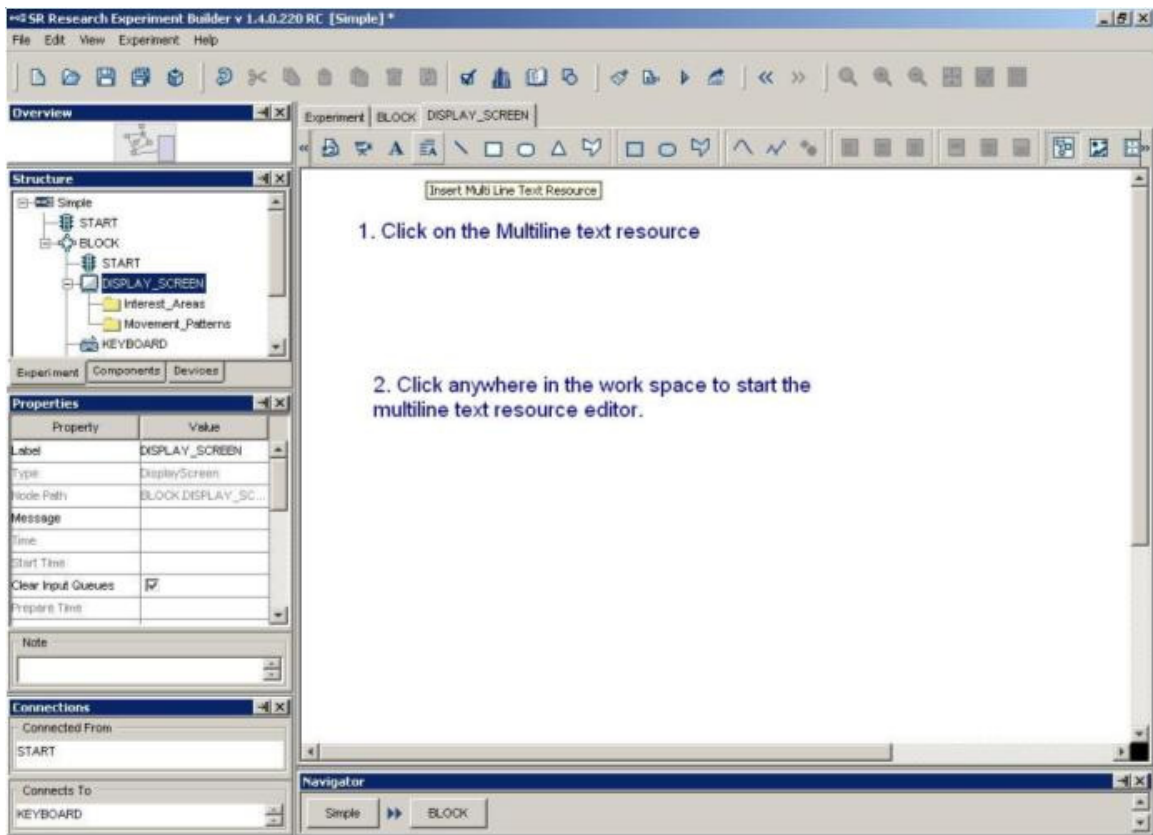



Figure 14-7. Adding Multiline Text Resource onto a Display Screen

- 1) Click on the multiline text resource () button on the screen builder toolbar to select the type of resource to be added.
- 2) Click anywhere on the screen.

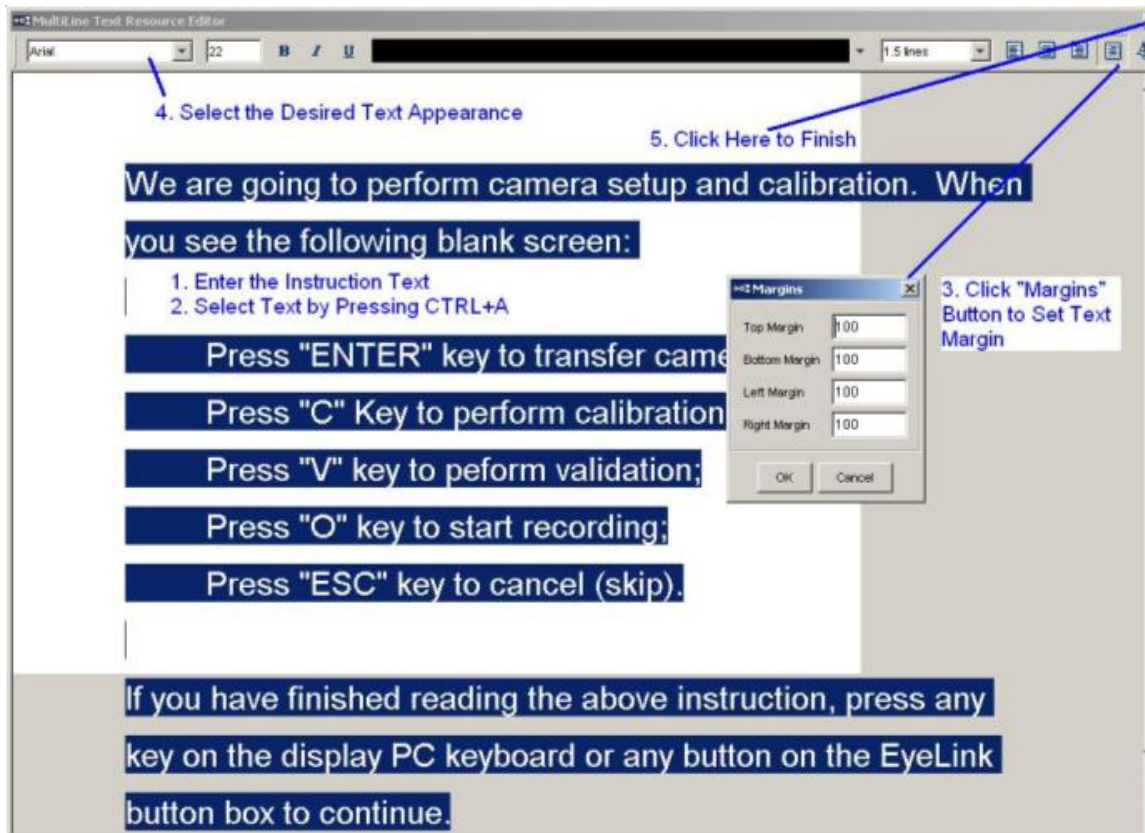

Figure 14-8. Create Instruction Screen

In the following Multiline Text Resource Editor,

- 1) Enter the instruction text.
- 2) Press CTRL + A to select all text entered.
- 3) Click the "Margins" button box to set the text margins. Enter 100 in all fields. Click the "OK" button on the dialog box.
- 4) Make sure that the text is still selected. Now click the buttons on the toolbar to set the desired text appearance (font name, font size, font style, alignment style, line spacing, and text color).
- 5) Click on the "Close" button (X) at the top right corner of the dialog to finish.

Please note that, instead of using multi-line text resource, the user can also create the instruction screen by using an image resource (see Section 8.1.1).

14.1.6 Editing Trial Sequence: Data Source

Next, we will work on the sequence, which will contain all necessary triggers and actions in each trial. We will also need to create a data source to be used for setting parameters in individual trials (see Figure 14-9).

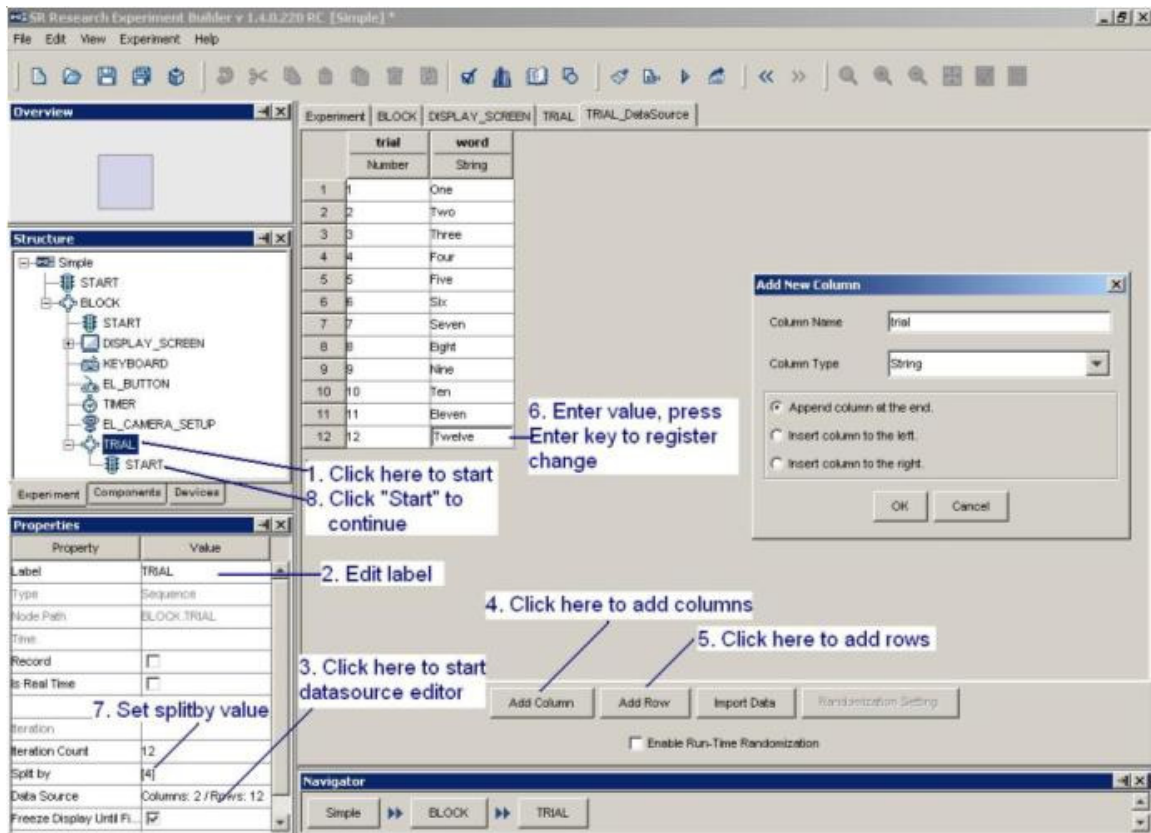

Figure 14-9. Creating Data Set

- 1) Click on the last “SEQUENCE” node on the structure list to start.
- 2) In the property table, click on the value field of “LABEL”. Set it to “TRIAL”.
- 3) Click on the “Data Source” property to bring up Data Source Editor.
- 4) Click on the "Add Column" button. In the following dialog box, type "Trial" (without quotation marks) in the Column Name editor box and set Column type as "Number". Click "OK" button to finish. Click on the "Add Column" button again. Set the Column Name as "Word" and Column type as "String". Click "OK" button to finish.
- 5) Click on the “Add Row” button. Enter 12 in the “Number of Rows” edit box to generate 12 rows of empty cells.
- 6) Click on the empty cells of the table just generated. Set the values of the “Trial” column as 1, 2, 3, 4, 5, 6, 7, 8, 9, 10, 11, and 12. For the “word” column, enter the following strings: “One”, “Two”, “Three”, “Four”, ... and “Twelve”.
- 7) Click on the “Split by” value field. Enter a value [4]. This makes sure that only 4 trials are run in each block.
- 8) Double click on the “TRIAL” sequence node in the structure list. Click on Start node under it to continue.

14.1.7 Editing Trial Sequence: Preparing Sequence and Drift Correction

Each recording trial should begin with a prepare sequence action, followed by a drift correction action, and then by the actual trial recording (see Figure 14-10). The prepare

sequence action allows the user to preload the image files or audio clips for real-time image drawing or sound playing, to draw feedback graphics on the host PC to evaluate participants' performance, and to reinitialize trigger settings. The user should typically call this action before performing a drift correction.

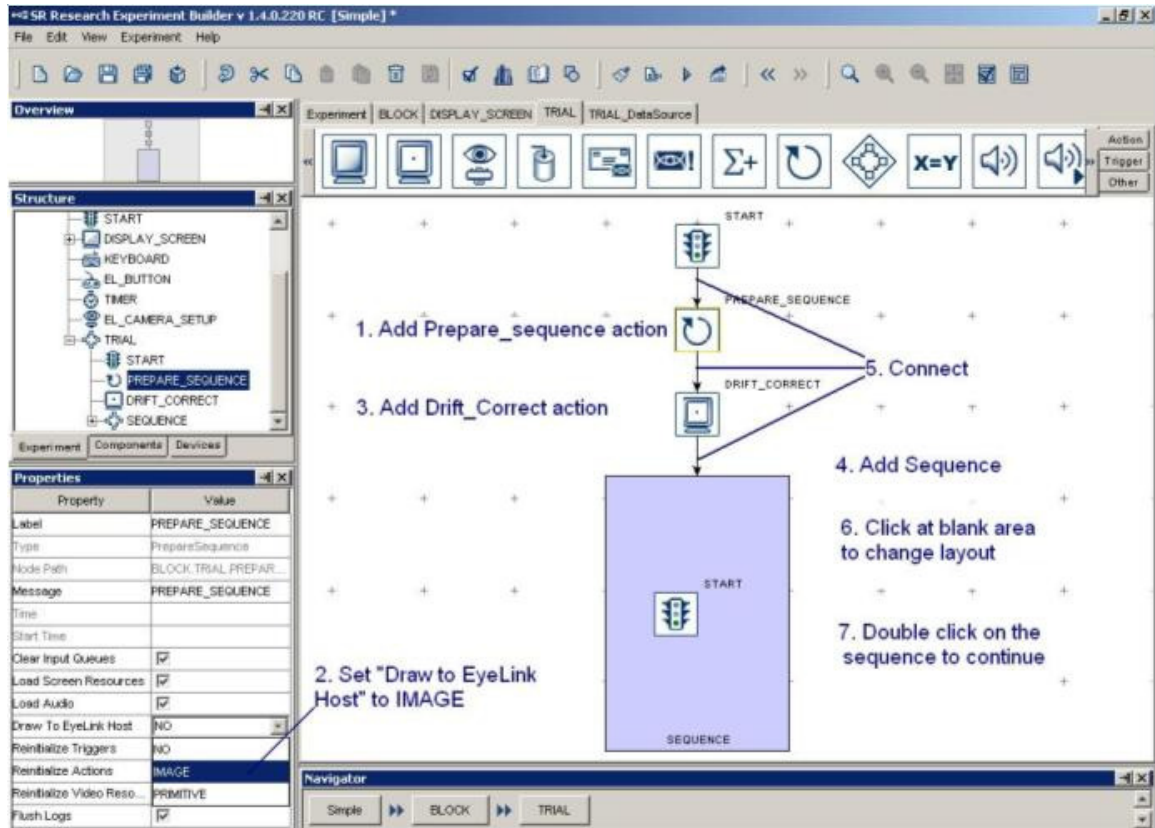

Figure 14-10. Editing Trial Sequence

- 1) Click on the "Action" Tab of the component toolbox, select the "Prepare Sequence" action, hold down the left mouse button and drag the action into the work space.
- 2) Click on the added PREPARE SEQUENCE action and review the settings in the property table. Make sure to check "Draw To EyeLink Host" field is set to "IMAGE" or "PRIMITIVE". This will draw image or simple graphics on the host screen for the purpose of evaluating gaze accuracy.
- 3) Add a "Drift Correction" action from the action tab of the component toolbox.
- 4) Click on the "Action" Tab of toolbox, select the "Sequence" node, hold down the left mouse button and drag it into the work space.
- 5) Make a connection from the "START" node to "PREPARE_SEQUENCE", from "PREPARE_SEQUENCE" to "DRIFT_CORRECTION", and from "DRIFT_CORRECT" to the "SEQUENCE" node.
- 6) Click on any blank area in the Work Space. Click the right mouse button and select "Arrange Layout" in the popup menu to re-arrange the nodes in an orderly fashion.

- 7) Double click on the newly created sequence to fill in the actual events in the recording.

14.1.8 Editing Recording Sequence

In the current step, the properties of the trial recording sequence should be modified (see Figure 14-11). The actual display presentation should also be worked out. In this simple recording sequence, we will display a screen and then wait for a button press response from the participant. The trial times out automatically if no response is made within 10 seconds. The display screen is then cleared.

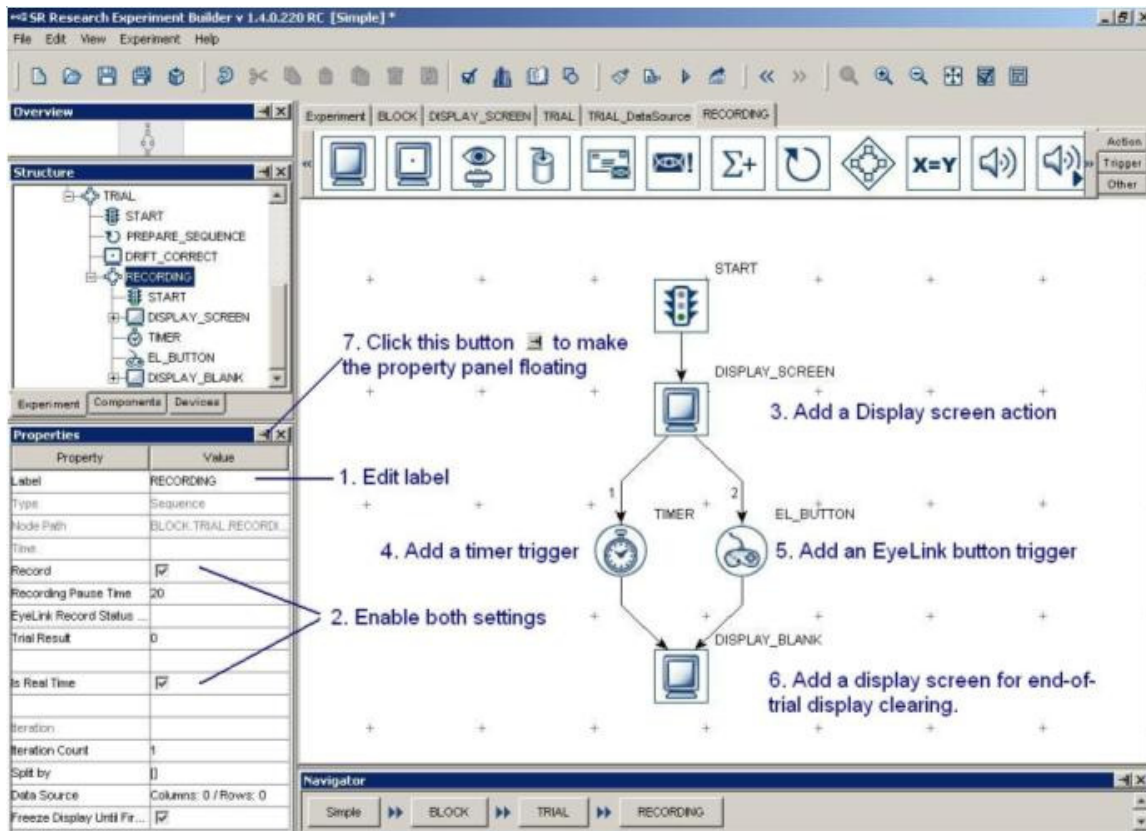



Figure 14-11. Editing Recording Sequence

- 1) Select the newly added “Sequence” node. Rename the label as “RECORDING”.
- 2) Make sure that the “Record” and “Is Real time” checkboxes are checked. Double click on the “RECORDING” node in the structure list until seeing a “START” node under it. As we double click on the “START” node, the content of the work area window is also updated.
- 3) Click on the “Action” Tab of the component toolbox, select the “display screen” action, hold down the left mouse button and drag the action into the work area.
- 4) Click on the “Triggers” Tab of toolbox, select the “TIMER” node, hold down the left mouse button and drag the trigger into the work space. Double click on the Timer object. Enter “Time out” (without quote) in the “Message” value field and 10000 in the “duration” field.

- 5) Add an “EyeLink© Button” trigger.
- 6) Add another “display screen” action. Double click on the action and modify its label as “DISPLAY_BLANK”. Also uncheck the “Send EyeLink DV Message” box.
- 7) Make a connection from the “START” node to “DISPLAY_SCREEN”, from “DISPLAY_SCREEN” to “TIMER”, from “DISPLAY_SCREEN” to “EL_BUTTON”, from “TIMER” to “DISPLAY_BLANK” and from “EL_BUTTON” to “DISPLAY_BLANK”.
- 8) Click at any blank area in the work space, then click the right mouse button and select “Layout ...” in the popup menu. Click ok in the following dialog box. This will re-arrange the nodes in an orderly fashion.
- 9) Click on  button in the properties window to make it a free-floating window.

14.1.9 Modifying Properties of Display Screen

We will first need to check the property settings of the display screen actions (see Figure 14-12). For better Data Viewer integration and for reaction time calculation, a message should be written to the EDF file to indicate the time when the stimulus was visible to the participants. In addition, we may need to draw simple graphics onto the host screen so that the participants’ gaze accuracy during recording can be evaluated.

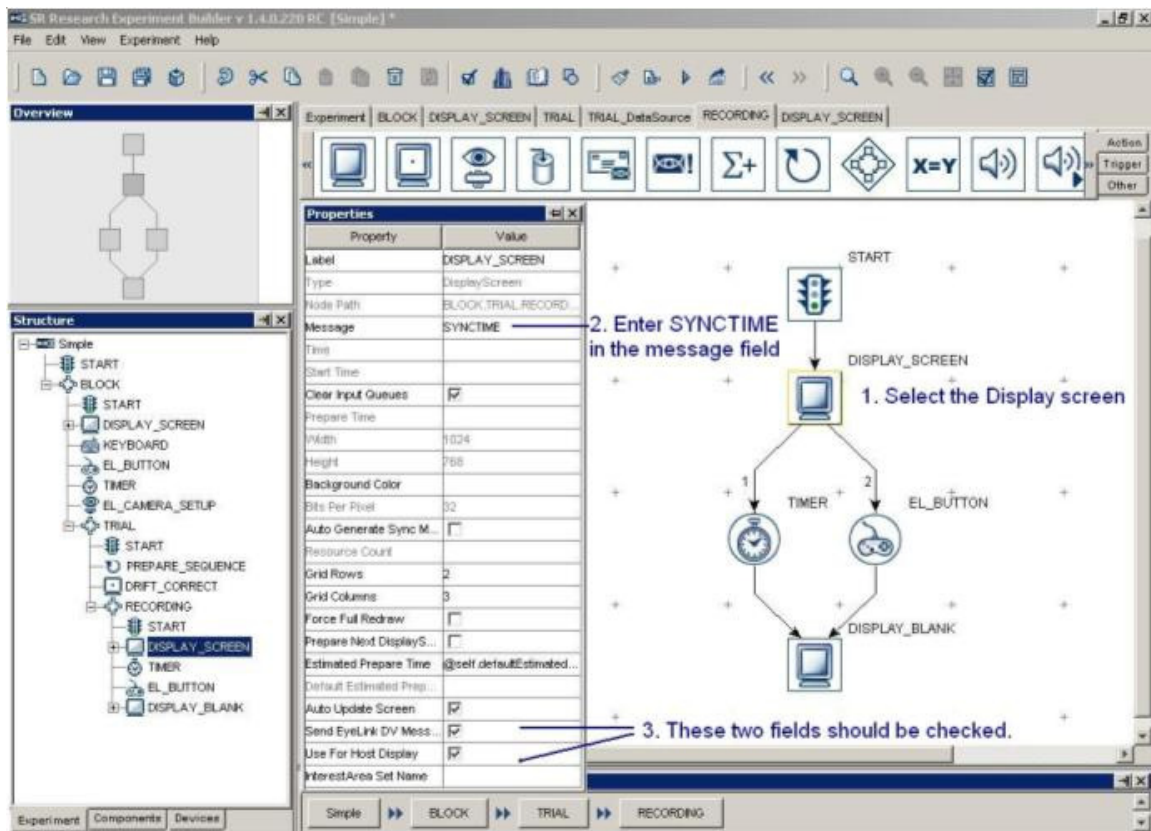

Figure 14-12. Modifying the Properties of DISPLAY_SCREEN Action

- 1) Click on the DISPLAY_SCREEN node. In the property window of the action, double click on the value field of “Message” property. Type in “SYNCTIME” and then press ENTER key to register the change.
- 2) Make sure that the “Send EyeLink© DV Messages” and “Use for Host Display” properties are checked.
- 3) Select the “DISPLAY_BLANK” action. Double click on the value field of “Message” property. Type in “blank_screen” and then press ENTER key to register the change.
- 4) Make sure that both “Send EyeLink© DV Messages” and “Use for Host Display” checkboxes for the “DISPLAY_BLANK” action is unchecked.

14.1.10 Creating Display Screen

We will add a text resource to the display screen and modify the properties of the text resource, such as font name, size, text to be displayed, and alignment style. We will also create an interest area for the text (see Figure 14-13). To do this, first double click on the “DISPLAY_SCREEN” object in the work space (not in the structure list), until the screen builder interface is displayed in the Graph Editor Window.

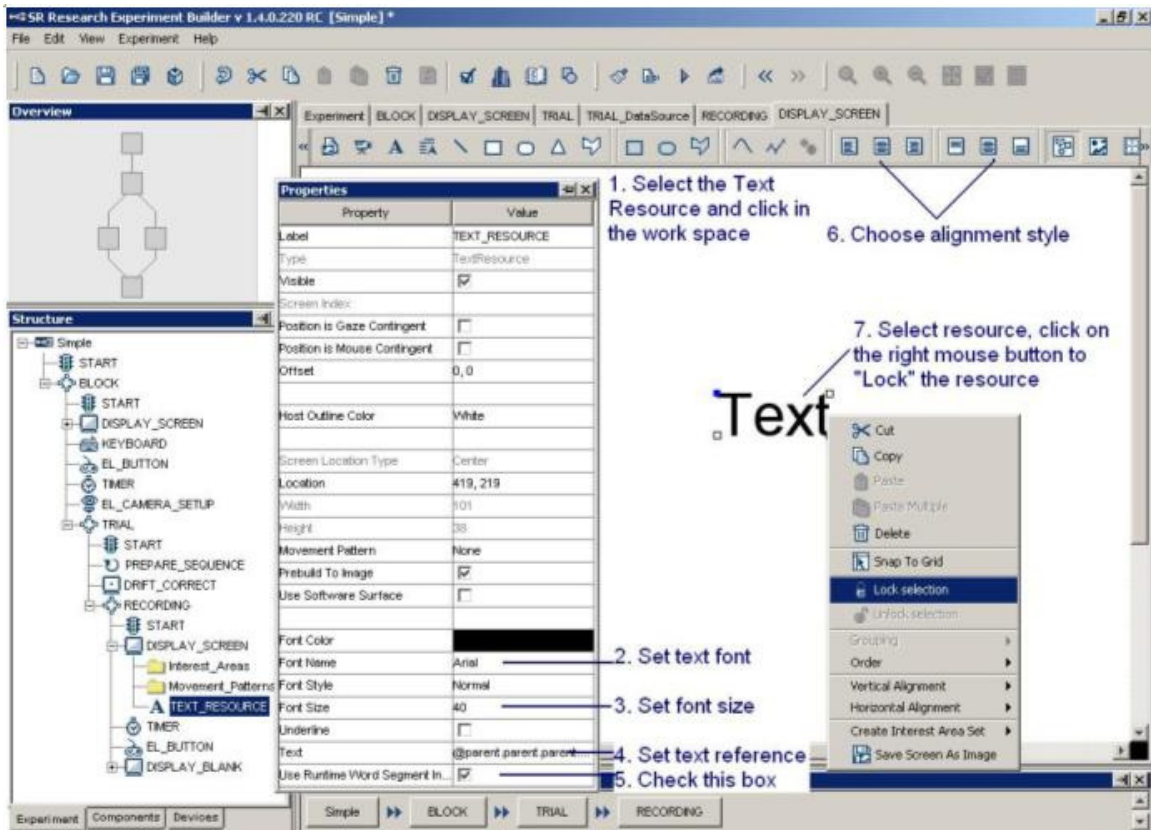

Figure 14-13. Adding Text to Display Screen

- 1) Click on the “Insert Text Resource” button (A) on the Screen Builder tool bar, and click at any position in the work area.

- 2) Double click on the current value of Font Name (“New Times Roman”). This will bring up a dropdown list. Set the new font name as “Arial”.
- 3) Double click on the current value of Font Size (20). Enter the desired text size (40) in the text editor.
- 4) Double click on the far right end of the value field of the “Text” property. This will bring up an attribute editor dialog (see Figure 14-14).
 - a. Click on DataSource node under “TRIAL” sequence on the node selection list.
 - b. Double click on the “word” node in the node attributes window. This will update the contents of “Attribute” editor dialog as “@parent.parent.parent.TRIAL_DataSource.Word@”.
 - c. Click on the “OK” button to finish.

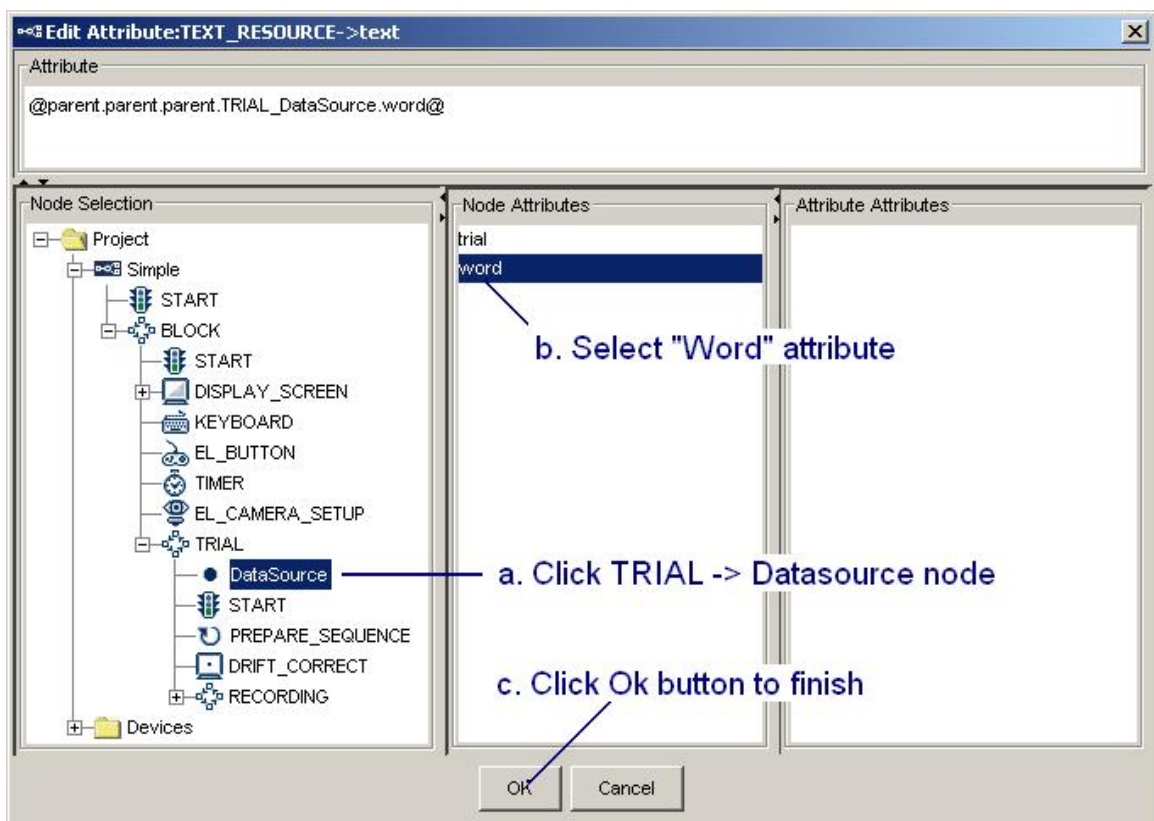



Figure 14-14. Referring Text to Be Shown to Data Source

- 5) Check the “Use Runtime Word Segment” box. This will create interest area automatically for the text used.
- 6) Select the newly added text resource, click on both “Horizontal Center Alignment” and “Vertical Center Alignment” () buttons to place the text in the center of the screen.
- 7) Select the text resource on the work area, click the right mouse button, and select the “Lock Selection” option so that the resource will not be moved accidentally.

14.1.11 Writing Trial ID to EDF file

A “TRIALID” message should be written to the EDF file so that the actual experiment condition under which the trial was conducted can be identified during analysis (see Figure 14-15).

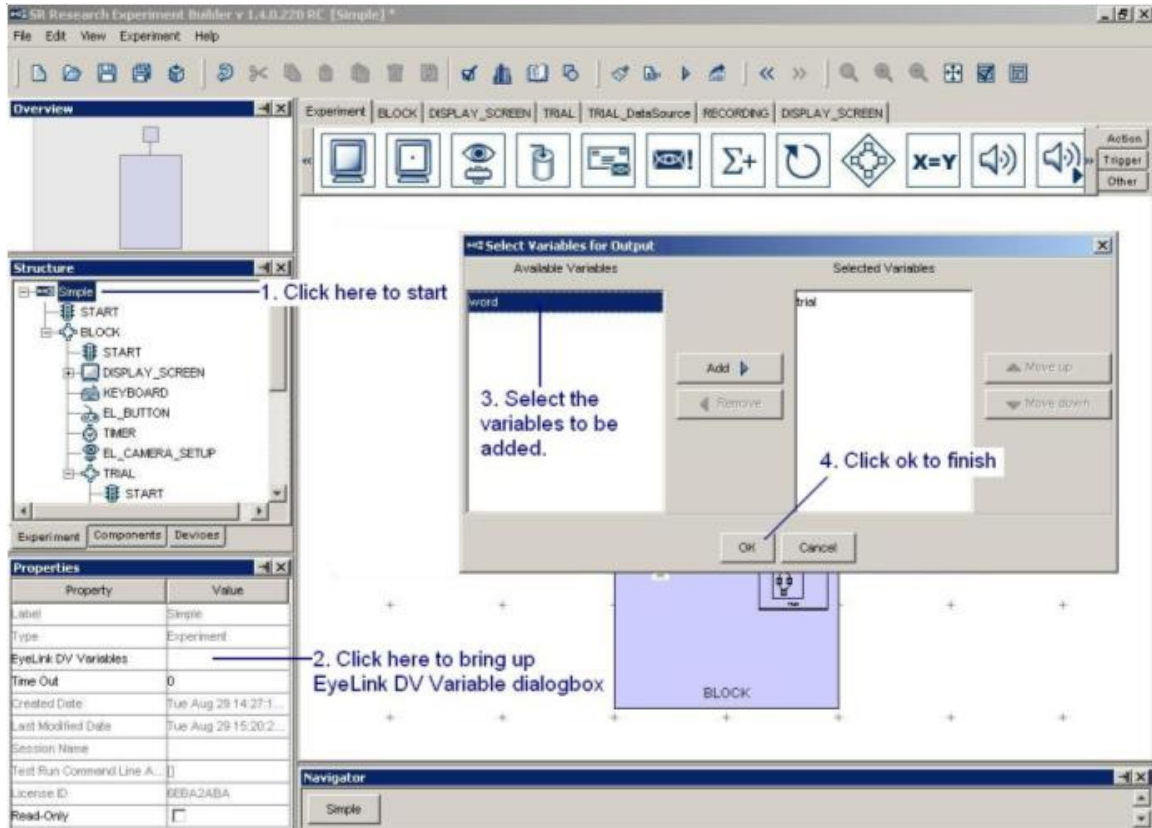

Figure 14-15. Creating Trial ID Message

- 1) Click on the Experiment (the topmost) node in the structure list to start.
- 2) In the property table, click on the value field of the “EyeLink© DV Variables” property.
- 3) In the following dialog box, for each of the variables to be added to the trial ID message, select the variable and click the “ADD” button. The order of the selected variables can be modified with the “Move up” and “Move down” buttons.
- 4) Click on “OK” to finish.

14.1.12 Showing Experiment Progress Message on Tracker Screen

During trial recording, a text message can be displayed at the bottom of the tracker screen so that the experimenter can be informed of the experiment progress (see Figure 14-16). For example, in this experiment, we wanted to show a text message like “Trial 1/12 One” on the tracker screen.

- 1) Click on the “Recording” sequence node in the structure list to start.

- 2) In the property panel, click on the far right end of the value field of the “EyeLink© Record Status Message” property.
- 3) In the attribute editor, enter an equation as:

```
= "Trial " + str(@TRIAL_DataSource.Trial@) + "/12 "
+ str(@TRIAL_DataSource.Word@)
```

- 4) Click on the “OK” button to finish.

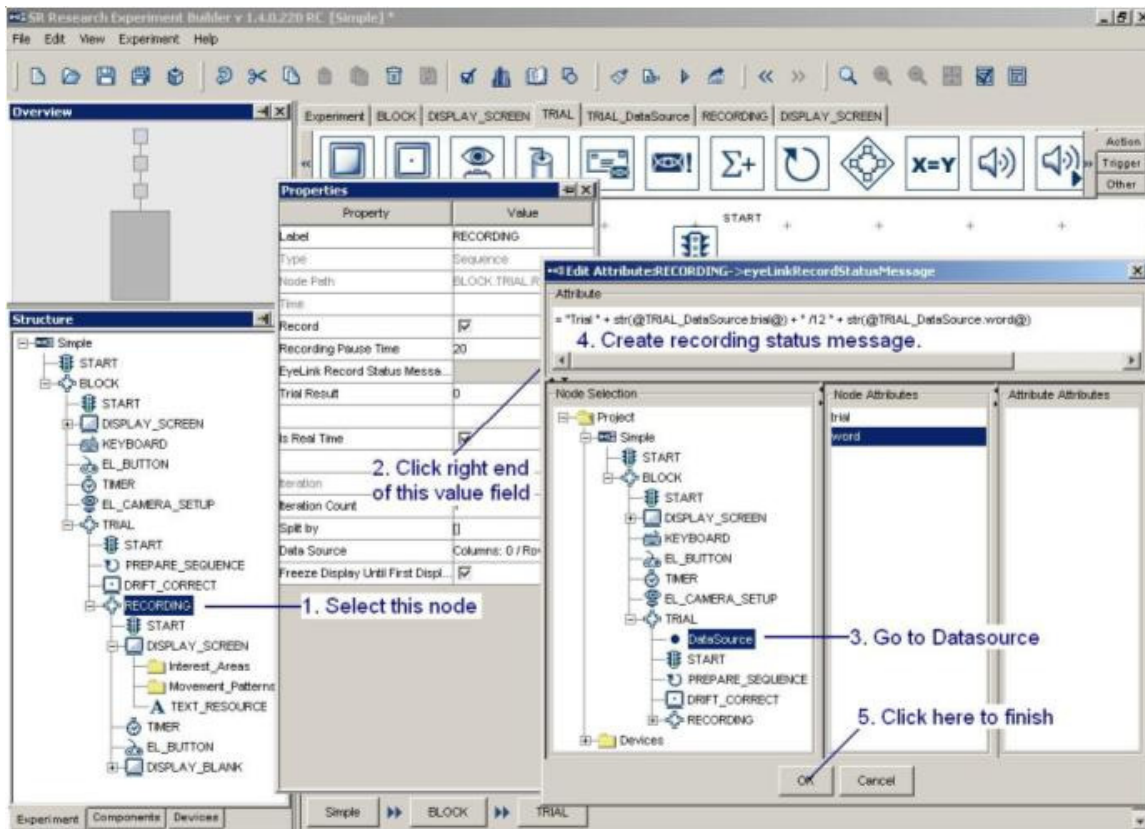



Figure 14-16. Creating Trial Recording Status Message

14.2 Building the Experiment

Now your first experiment is created. If you haven't saved your experiment project yet, click on the save () button on the application tool bar. Click on “Experiment → Build” menu to build the experiment. The Editor Selection Tab in the Graph Editor Window will be set to the “Output” tab and build information will be displayed. Watch out for error (displayed in red) and warning (in brown) messages during building.

The following is a list of common errors during experiment building:

- Image file not found
- No positions are added to the custom pattern
- Use of runtime value with prebuild to image option on
- No value is set at row ... for the column ...

- The node could not be used in the sequence
- Reference to .. not found in the graph.
- No link from node.
- Infinite loop found
- Invalid Reference.
- No recording sequence found in an EyeLink© experiment.

The following is a list of common warnings during experiment building:

- The keyboard trigger and mouse trigger is used in a real-time sequence. If this is the case, check whether these two triggers are indispensable for the experiment design. If so, uncheck the “Is Real-time” box in the recording sequence.
- Default value use in attribute ...

The user may also test the experiment by clicking on “Experiment → Run” from the application menubar. This will try to connect to the tracker PC and execute the experiment code. Please note that this should only be used for the purpose of testing and debugging experiment code. To collect experiment data, the user should use the deployed version of the experiment (see next section) as it does not have to rely on the Experiment Builder application and can be run on a different computer.

14.3 Deploying the Experiment

After the experiment is built, the user must “deploy” the experiment to a new directory (see Section 4.11). This will generate a set of files so that the experiment can be run on a different computer without relying on the Experiment Builder application. If a data source is used, this will create a “datasets” subdirectory with a copy of data set file in it. The user may create several copies of data set files with the randomizer application (see Section 9.5.2).

14.4 Running the Experiment

To run the experiment, open the directory where the experiment is deployed to and click on “simple.exe”. If the EyeLink© host application is already running on the host PC and the Ethernet connection and settings between the host and display PCs are ok, the experiment should now start. This will first popup a dialog box asking for the data source file. Go to the “datasets” directory and select the target data source file. Following this, enter the desired EDF file name (must be in DOS 8.3 format) and click on the “OK” button to continue. Following the initial welcome message, the participant will be shown the camera setup and calibration screen and the recording can be started following calibration, validation, and drift correction. After running three blocks of four trials (blocks are separated by a camera setup procedure), an EDF file will be transferred to the display PC. It may take some time to complete the file transfer, so please be patient.

The following sections list the common errors while running an experiment.

14.4.1 Error in Initializing Graphics

When you start the experiment and see an “Error Initializing Graphics” error, please check whether the display settings (screen resolution, color bits, and refresh rate) specified for the experiment are supported by your video card (see Figure 14-17). If not, please change the “Preferences → Experiment → Devices → Display” settings.



Figure 14-17. Error in Initializing Graphics

14.4.2 Error in Tracker Version

SR Research Experiment Builder works well with both EyeLink and EyeLink II eye trackers. The default tracker version is set to EyeLink II (see “Preferences → Experiment → Devices → EyeLink”). Therefore, EyeLink I users may see such an error message with the default tracker setting (see Figure 14-18). If this is the case, please set the tracker-version in the device settings to “EyeLink I” (see Figure 14-3).

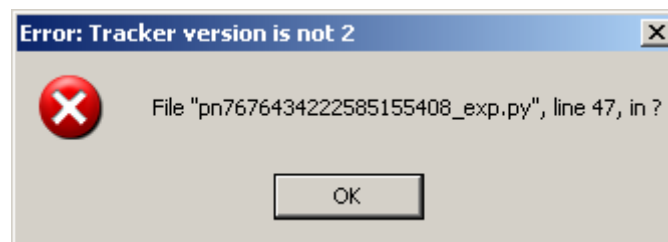

Figure 14-18. Error in Tracker Version

15 Creating Non-EyeLink Experiments: Stroop Effect

The current chapter illustrates the use of SR Research Experiment Builder in creating a non-eye-tracking experiment. This sample experiment demonstrates the Stroop Effect with keyboard response: the subject is asked to respond to the colors of the words as fast and as accurately as possible. For example, for the word **BLUE**, the subject should respond as "RED" instead of "BLUE".

15.1 Creating a New Experiment Session

Click on the Experiment Builder to start a new session. When the application starts:

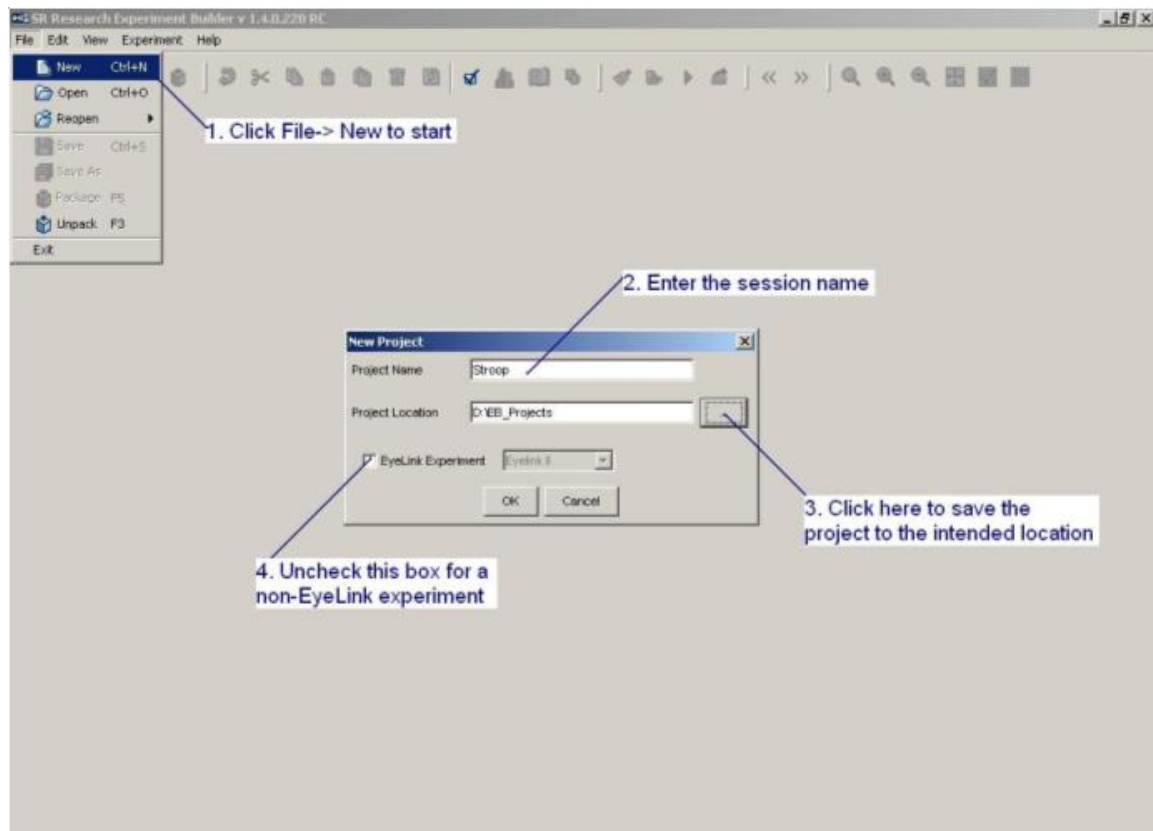

Figure 15-1. Creating a New Experiment Builder Session

- 1) Click on "File → New" on the application menu bar.
- 2) In the following "New Project" dialog box, enter "Stroop" in the "Project Name" edit box.
- 3) Click on the button on the right end of the "Project Location" to browse to the directory where the experiment project should be saved. If you are manually entering the "Project Location" field, please make sure that the intended directory already exists.

- 4) Make sure that "EyeLink Experiment" box is unchecked for a non-EyeLink experiment.

15.2 Configuring Experiment Preference Settings

After a new experiment session is created, the user needs to check whether the default display and screen preference settings are fine for the experiment to be created.

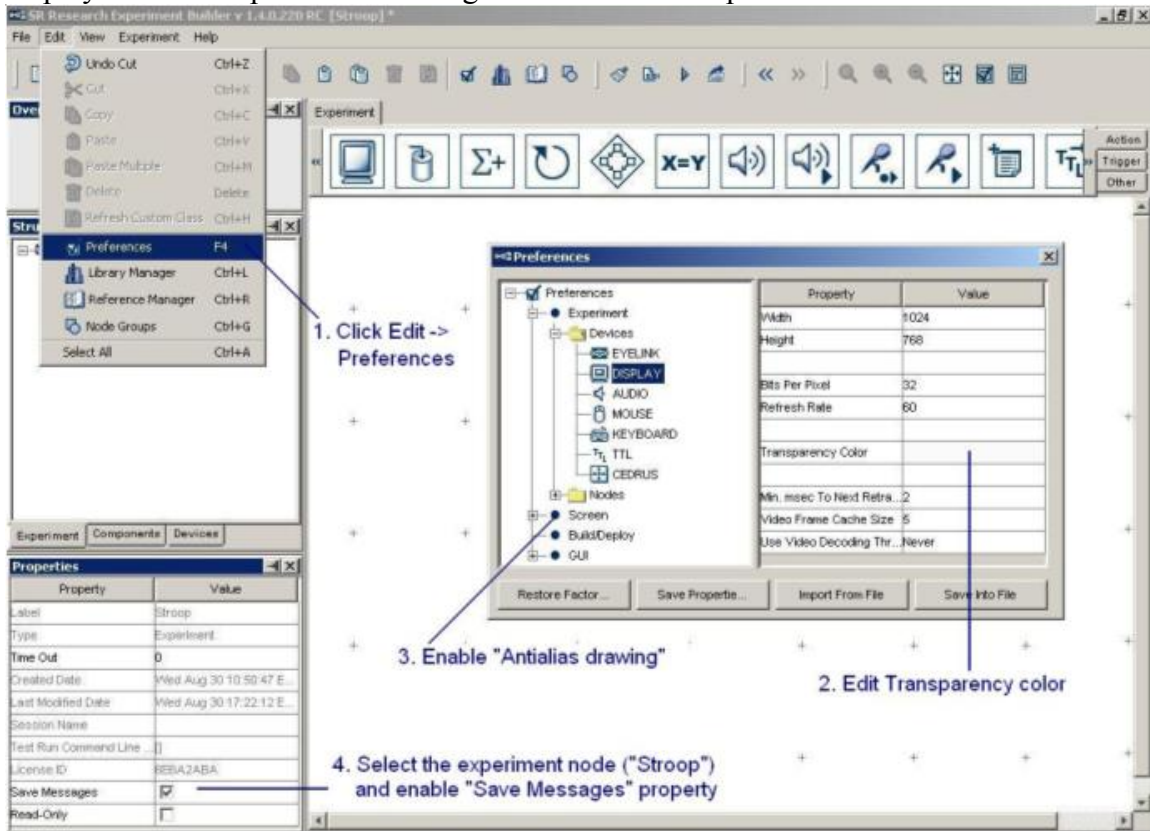

Figure 15-2. Editing Project Preferences.

- 1) Select "Edit -> Preferences" from the application menu bar or press shortcut key "F4".
- 2) Click on "Preferences -> Experiment -> Devices -> Display" to check display settings. Make sure that the settings (Width, Height, Bits per Pixel, and Refresh Rate) used in the current example are supported by your video card and monitor. To make the text presentation look better, the user may enable the anti-aliasing function (see "Anti-aliasing and Transparency"). Set the transparency color value of the Display Device to something similar, but not identical, to the background used in the display screen. In the current example, the user may set the RGB value of the transparency color to (251, 250, 251).
- 3) Click on "Preferences -> Screen" to enable the "Antialiasing Drawing" setting. To complete preference settings, press the close button on the dialog box.
- 4) Select the topmost experiment node ("Stroop"). In the property table, enable the "Save Messages" box so that a message can be written to the "messages.txt" file at the "results\{Session Name}" folder when an action is performed or a trigger fires.

Chinese, Japanese and Korean Users: Please make sure that the "Encode Files as UTF8" setting in "Preferences -> Build/Deploy" settings is always enabled; otherwise you may see the following error:

ERROR: error:2070 Internal Error. Could not create script. Please contact SR Research! Sorry: MemoryError: ()

This may have caused by an invalid encoding. Try using UTF8 encoding.

15.3 Creating Experiment Block Sequence

In this example, we are going to run two blocks of nine trials. The first step is to add a block sequence for repeating blocks (see Figure 15-3). In addition, we add a result file to contain data outputs.

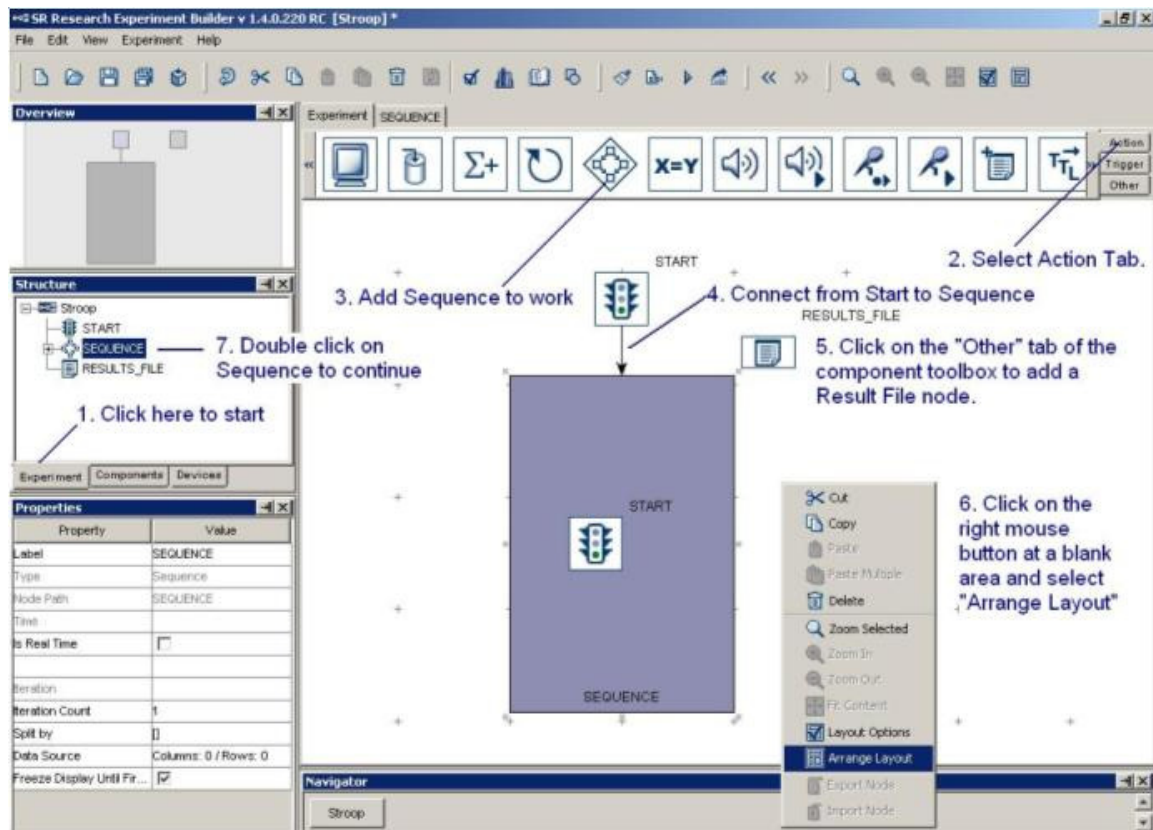

Figure 15-3. Creating Experiment Block Sequence

- 1) Click on the Experiment Tab in the Project Explorer Window to start.
- 2) Click on the "Action" Tab of component toolbox.
- 3) Select the "Sequence" node, hold down the left mouse button and drag it into the work area.
- 4) Place the mouse cursor on top of the "START" node, hold down the left mouse button while moving the mouse cursor on top of the "SEQUENCE" node. This makes the connection from the "START" node to "SEQUENCE" node. (Note: don't make a single or double click on the "START" node as this will *select* the

- node instead. If you have done so, place the mouse cursor on a blank area in the work space and make a single click there. Redo the current step again.)
- 5) Click on the “Other” Tab of the component toolbox and add a “RESULT_FILE” node to the graph.
 - 6) Click at any blank area in the work window. Click the right mouse button and select "Arrange Layout" in the popup menu. This will re-arrange the nodes in a hierarchical fashion.
 - 7) Click on the SEQUENCE node in the structure list.

15.4 Editing Block Sequence

Next, we will need to edit the properties of the Block Sequence. This involves changing the “Label” of the sequence to make it more meaningful and changing the “iteration count” to the actual number of blocks to be tested (see Figure 15-4). Please note here, we do not edit the “Split by” field.

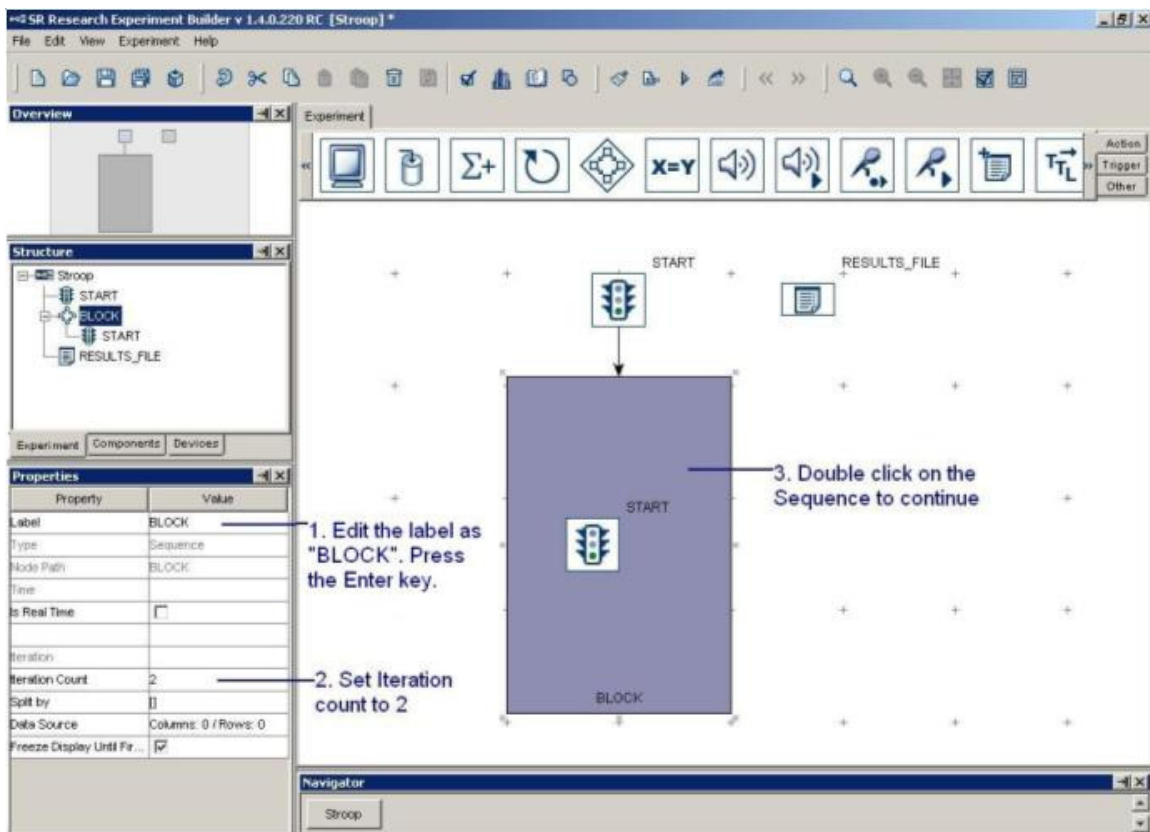

Figure 15-4. Editing Block Sequence

- 1) Click on the value field of the “Label” property of the Sequence created. Write “BLOCK” in the text editor and press the ENTER key to finish.
- 2) Click on the “Iteration Count” value field and enter “2” as the total number of sequence loops.
- 3) In the experiment Work Space, double click on the Sequence object to continue.

In each block, we will first give an instruction and then run nine trials (see Figure 15-5).

- 1) Click on the “Action” Tab of the component toolbox, select the “Display screen” action, hold down the left mouse button and drag the action into the work area.
- 2) Click on the “Trigger” Tab of the component toolbox, select the “Timer” trigger, hold down the left mouse button and drag the action into the work area.
- 3) Click on the Timer trigger and set the duration to 120000 msec.
- 4) Add a “Keyboard” trigger to the work space.
- 5) Click on the “Action” Tab of toolbox and add a “Sequence” node to the work space. This will be our trial sequence.
- 6) Place the mouse cursor on top of the “START” node. Hold down the left mouse button while moving the mouse on top of the DISPLAY_SCREEN node. This makes the connection from the “start” node to the “DISPLAY_SCREEN” node.
- 7) Similarly, connect from “DISPLAY_SCREEN” to KEYBOARD and TIMER triggers. Note that a number is added to these connections, indicating the evaluation order among the two trigger types.
- 8) Make a connection from the two triggers to the SEQUENCE node.

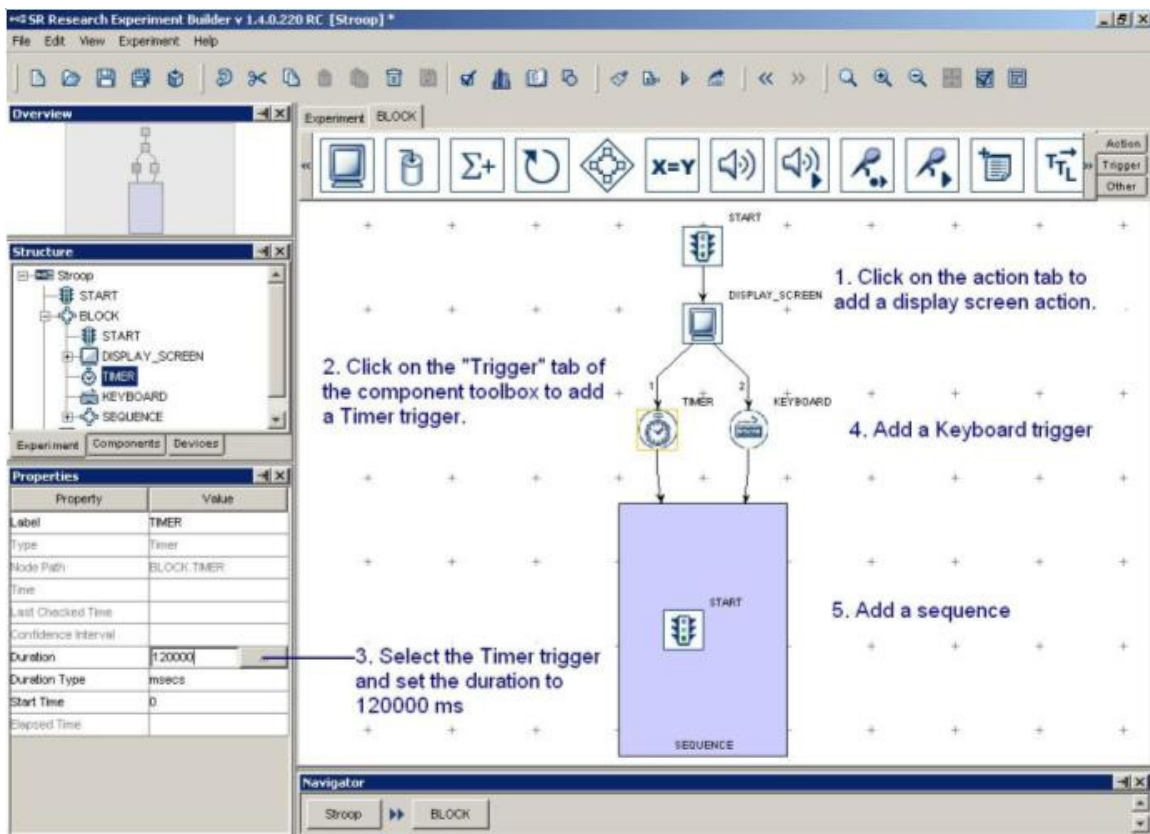



Figure 15-5. Adding Instruction to Block Sequence

- 9) Click at any blank area in the work window. Click the right mouse button and select "Arrange Layout" in the popup menu. This will re-arrange the nodes in an orderly fashion.
- 10) Double click on the “DISPLAY_SCREEN” object in the work space (not from the structure list) until the Screen Builder interface is displayed in the Graph Editor Window (see Figure 15-6).

15.5 Creating Instruction Screen

The user may want to provide instruction to the participants at the beginning of the experiment.

- 1) Click on the multiline text resource () button on the screen builder toolbar to select the type of resource to be added.
- 2) Click anywhere on the screen.

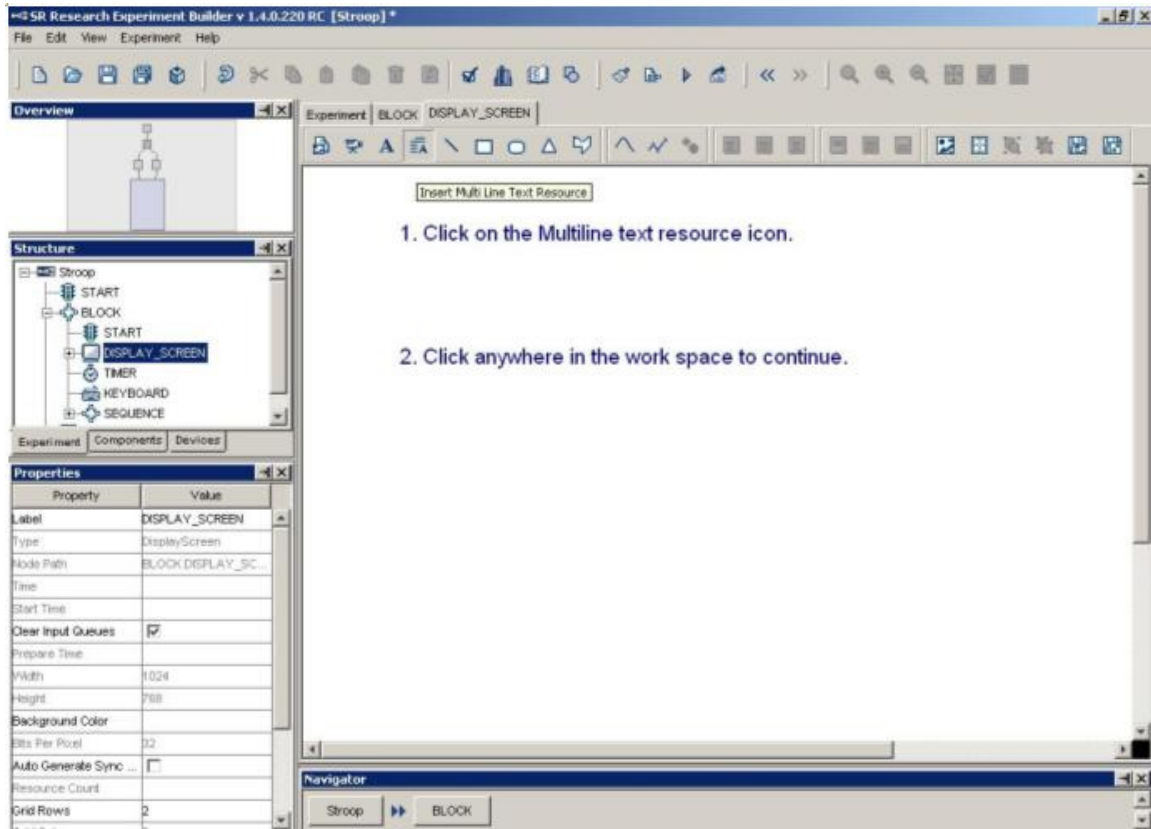



Figure 15-6. Adding Multiline Text Resource onto a Display Screen

In the following Multiline Text Resource Editor,

- 1) Click the "Margins" button box to set the text margins. Enter 100 in all fields. Click the "OK" button on the dialog box.
- 2) Enter the instruction text.
- 3) Press CTRL + A to select all text entered.
- 4) Make sure that the text is still selected. Click the buttons on the toolbar to set the desired text appearance (font name, font size, font style, alignment style, line spacing, and text color).
- 5) Select the target word "Green" and set its color to blue and text size to 50.
- 6) Click on the "Close" button () at the top right corner of the dialog to finish.

Please note that, instead of using multi-line text resource, the user can also create the instruction screen by using an image resource (see Section 8.1.1).

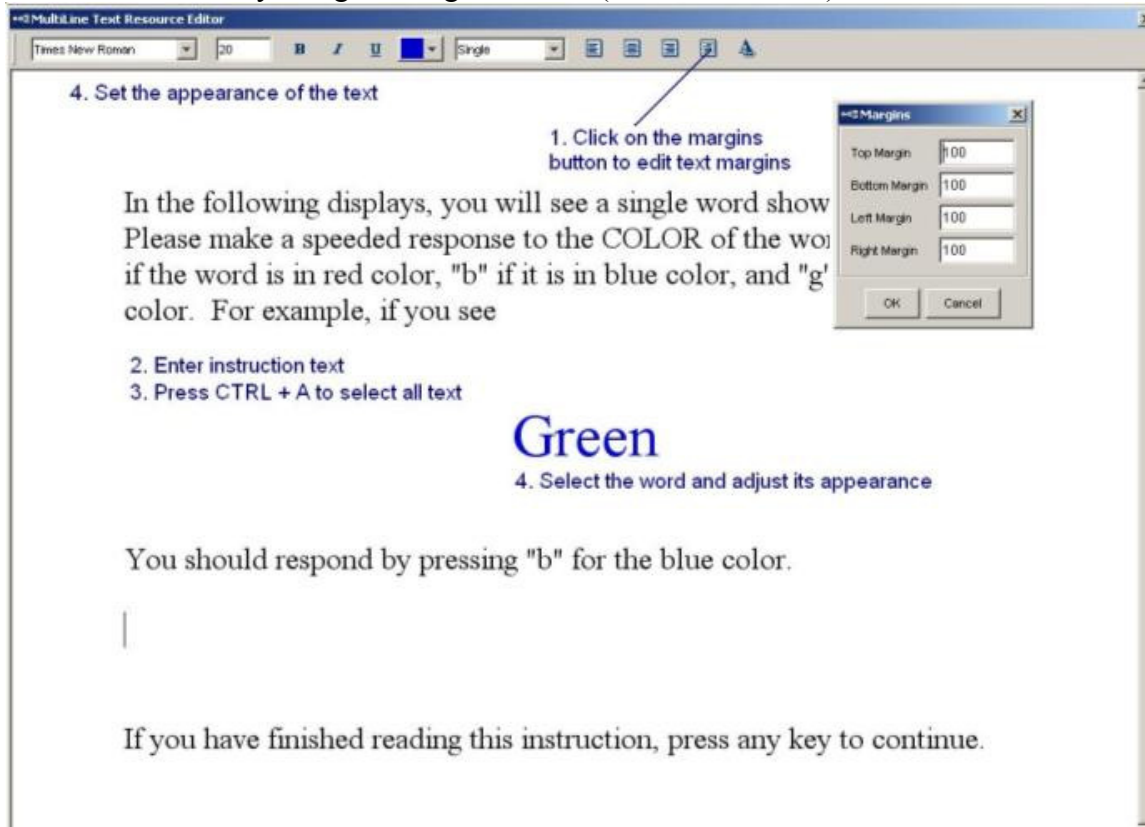

Figure 15-7. Create Instruction Screen

15.6 Editing Trial Sequence: Data Source

Next, we will work on the sequence, which will contain all of the necessary triggers and actions in each trial. We will also need to create a data source to be used for setting parameters in individual trials (see Figure 15-8).

- 1) Click on the last "SEQUENCE" node on the structure list to start.
- 2) In the property table, click on the value field of "LABEL". Set it to "TRIAL".
- 3) Click on the "Data Source" property to bring up Data Source Editor.
- 4) Click on the "Add Column" button. In the following dialog box, type "COLOR" (without quotation marks) in the Column Name editor box. In the Column Type dropdown list, select "Color" and click "OK" button to finish. Click on the "Add Column" button again. Create three more new columns. Set the Column Names as "WORD", "EXPECTED", and "COMPATIBLE" and set the Column Types as "String". **Important:** Your experiment may not run if inappropriate column types are used for the datasource.
- 5) Click on the "Add Row" button. Enter 18 in the "Number of Rows" edit box to generate 18 rows of empty cells.
- 6) Click on the empty cells of the table just generated. Add the values to the table as following.

	Color	WORD	EXPECTED	COMPATIBLE
data type	Color	String	String	String
1	(0, 0, 255)	Blue	b	Yes
2	(0, 255, 0)	Red	g	No
3	(255, 0, 0)	Red	r	Yes
4	(0, 0, 255)	Green	b	No
5	(255, 0, 0)	Blue	r	No
6	(0, 255, 0)	Blue	g	No
7	(0, 0, 255)	Red	b	No
8	(0, 255, 0)	Green	g	Yes
9	(255, 0, 0)	Green	r	No
10	(255, 0, 0)	Red	r	Yes
11	(0, 0, 255)	Green	b	No
12	(255, 0, 0)	Blue	r	No
13	(0, 255, 0)	Green	g	Yes
14	(255, 0, 0)	Green	r	No
15	(0, 0, 255)	Blue	b	Yes
16	(0, 255, 0)	Red	g	No
17	(0, 255, 0)	Blue	g	No
18	(0, 0, 255)	Red	b	No

- 7) Check the "Enable Run time Randomization" box so that internal randomization can be performed.
- 8) Click the "Randomization Setting" button to configure randomization settings. In the following dialog box, set randomization seed value to "Session Label" so that the same trial sequence will be presented when the same recording session label is used. Check the "Enable Trial Randomization" box, set Run Length Control Column to "WORD" and Maximum Run Length to 2 (please press ENTER key to register the value). This ensures that the trial presentation order is completely randomized with a restriction that the same "WORD" value will not be shown on three trials in a row. Press the OK button to finish.

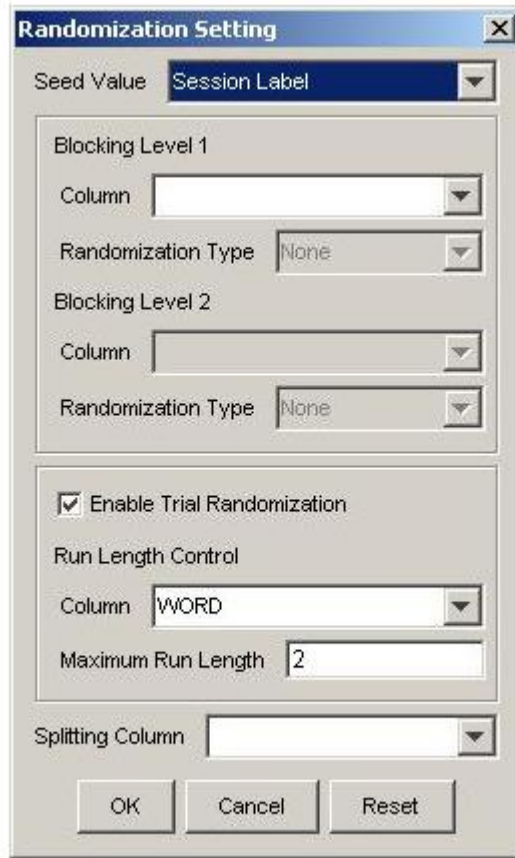

Figure 15-8. Datasource Randomization.

- 9) Uncheck the "Prompt for Dataset File" box so that you will not be asked to select datasource file at the beginning of the experiment.
- 10) Click on the "Split by" value field. Enter a value [9]. This makes sure that only 9 trials are run in each block.
- 11) Double click on the "TRIAL" sequence node in the structure list. Click on Start node under it to continue.

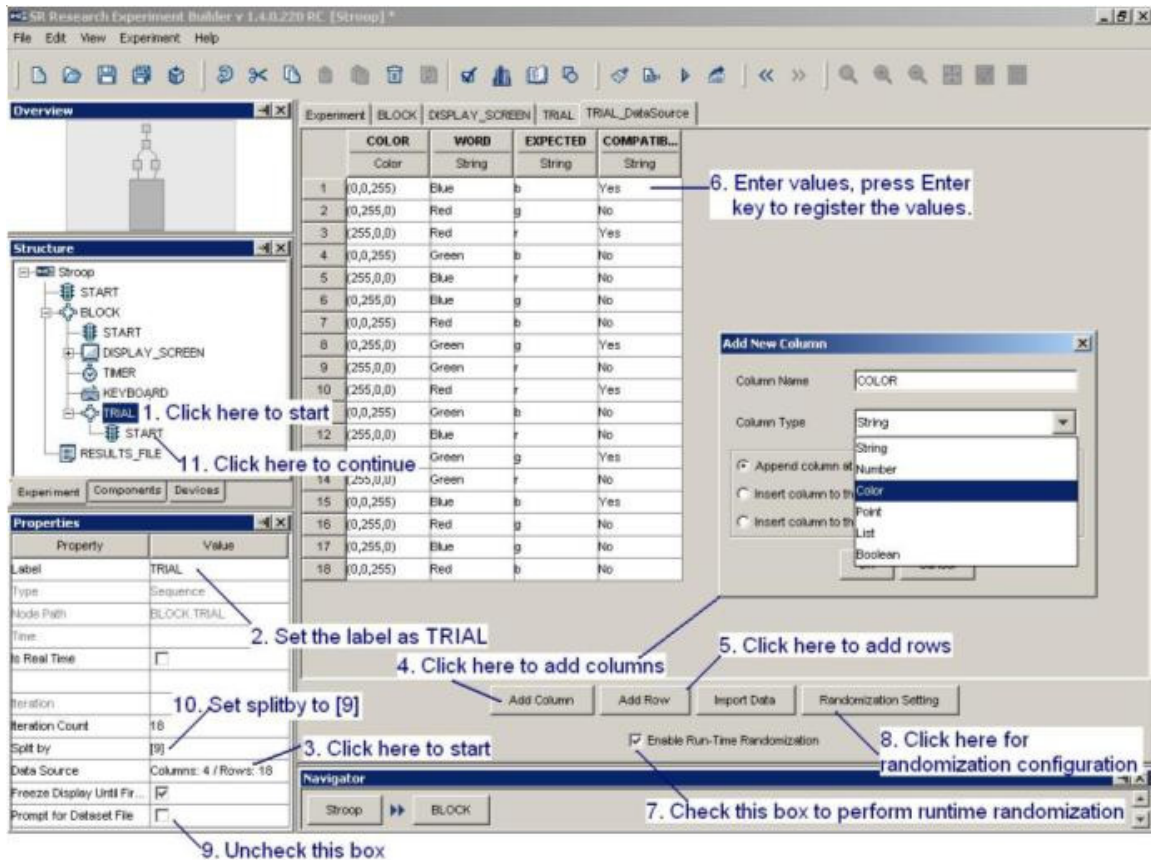

Figure 15-9. Creating Data Set

15.7 Editing Trial Sequence: Setting Initial Values and Preparing Sequence

Each trial should begin with a prepare sequence action, followed by the actual trial recording (see Figure 15-10). The prepare sequence action allows the user to preload the image files or audio clips for real-time image drawing or sound playing, to draw feedback graphics on the host PC to evaluate participants' performance, and to reinitialize trigger settings. In addition, we will add a couple of variables to store data, such as RT, key press, trial response accuracy, for each trial.

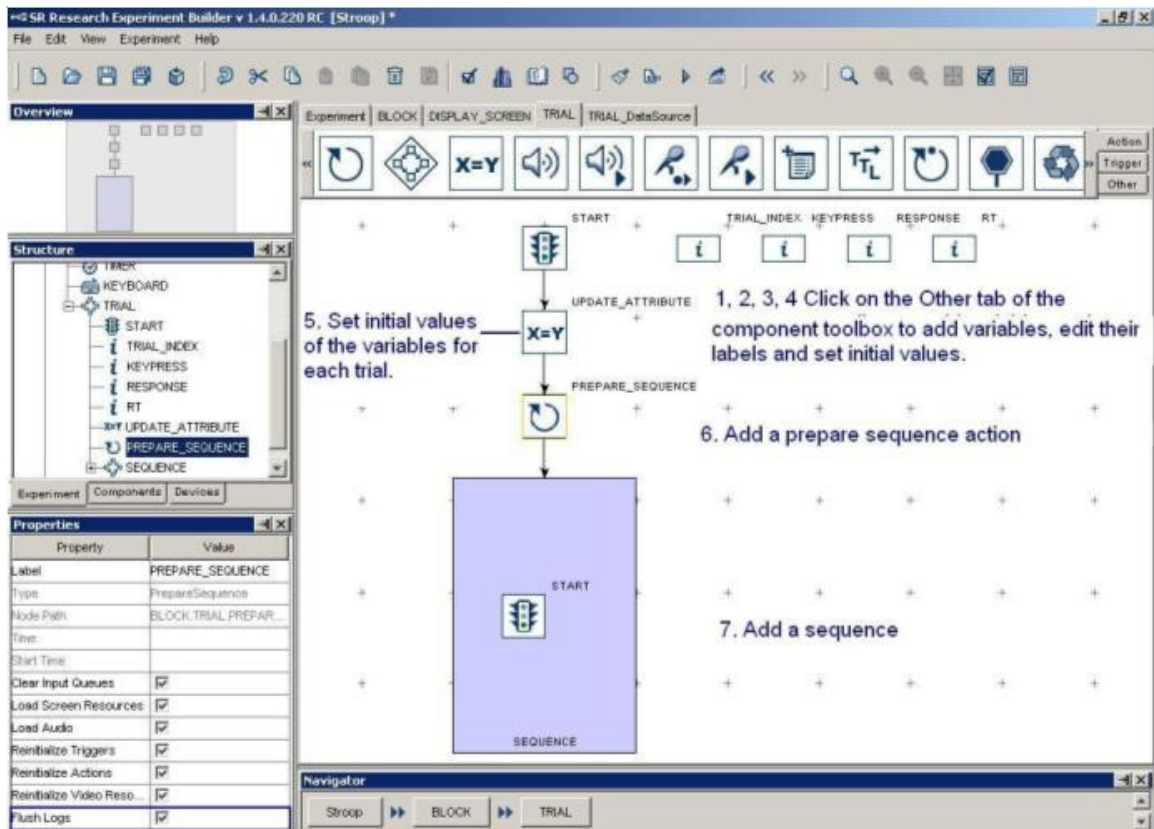

Figure 15-10. Editing Trial Sequence

- 1) Click on the "Other" Tab of the component toolbox, select the "Variable" node, hold down the left mouse button and drag the action into the work space. Click on the VARIABLE node, set its label as "TRIAL_INDEX" and set the initial value as "0". This variable is used to keep track of the current trial index. Please note that the data type is automatically changed to "Integer".
- 2) Add another variable in the graph. Set its label as "KEYPRESS" and initial value as ".". This variable is used to keep a record of key press for the trial.
- 3) Add a third variable. Set the label as "RESPONSE" and initial value as ".". This variable is used to check whether the response recorded is correct or not.
- 4) Add in a fourth variable. Set its label as "RT" and its initial value as 0.0. This variable is used to store reaction time for the trial.
- 5) Click on the "Action" Tab of the component toolbox, select the "UPDATE_ATTRIBUTE" action, hold down the left mouse button and drag the action into the work space. Click on the action (Step A1 of the figure below) and set the initial values of the following four variables, TRIAL_INDEX, RT, RESPONSE, and KEYPRESS.
 - a. Click on the far right end of the value field of the "Attribute-Value List" property (Step A2 of the figure below). This will bring up an "Attribute-Value List" dialog box.
 - b. Click on the right end of the first cell under the "Attribute" column (Step A3 of the figure below). This will bring up an attribute editor dialog. In the left "Node Selection" treview, click on the TRIAL_INDEX node

under the "TRIAL" sequence (Step A4). In the middle "Node Attributes" panel, double click on the "Value" node (Step A5). This will update the contents of the top "Attribute" editor dialog as "@TRIAL_INDEX.value@". Click on the "OK" button to finish (Step A6). This will fill in the first cell of the attribute-value list dialog.

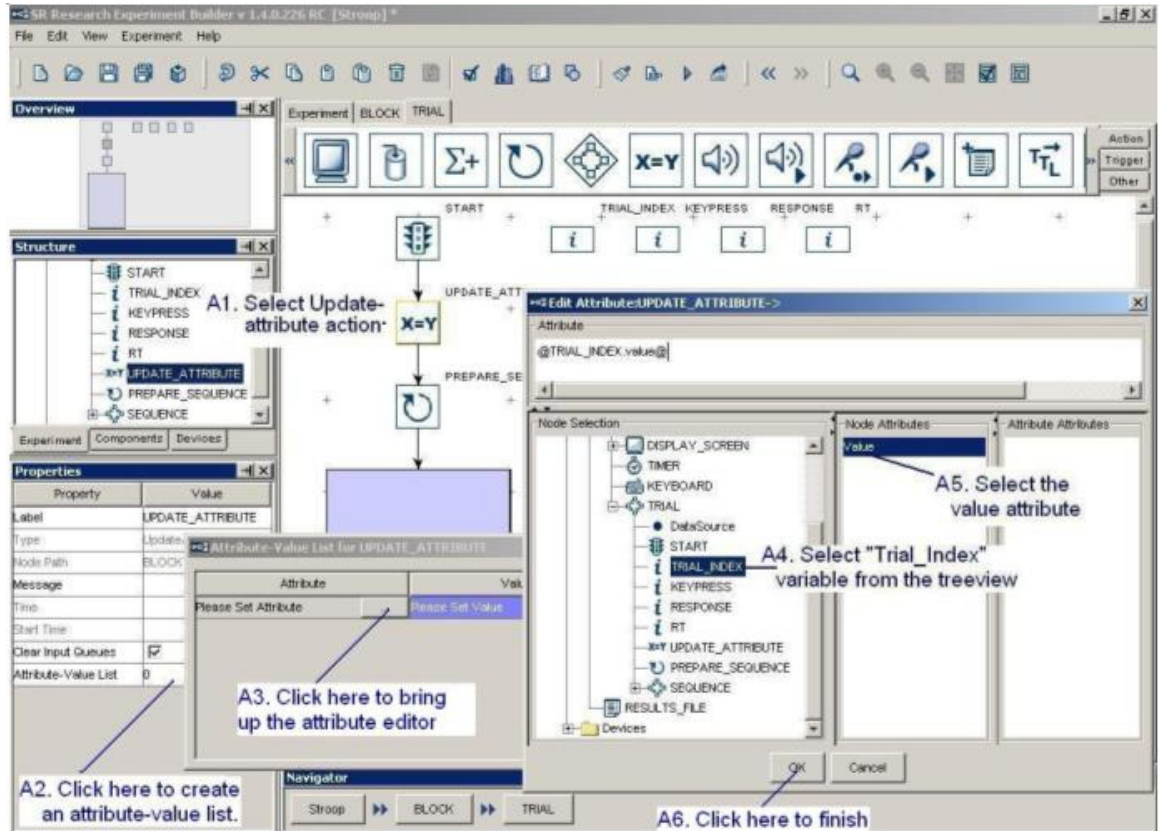

Figure 15-11. Updating Trial Index.

- c. Now, click on the right end of the first cell under the "Value" column (See B1 of the figure below). In the left "Node Selection" treview of the following attribute editor dialog, click on the "TRIAL" sequence (see B2). In the middle "Node Attributes" panel, double click on the "Iteration" node (B3). This will update the contents of the top "Attribute" editor dialog as "@parent.iteration@". Click on the "OK" button to finish (B4).

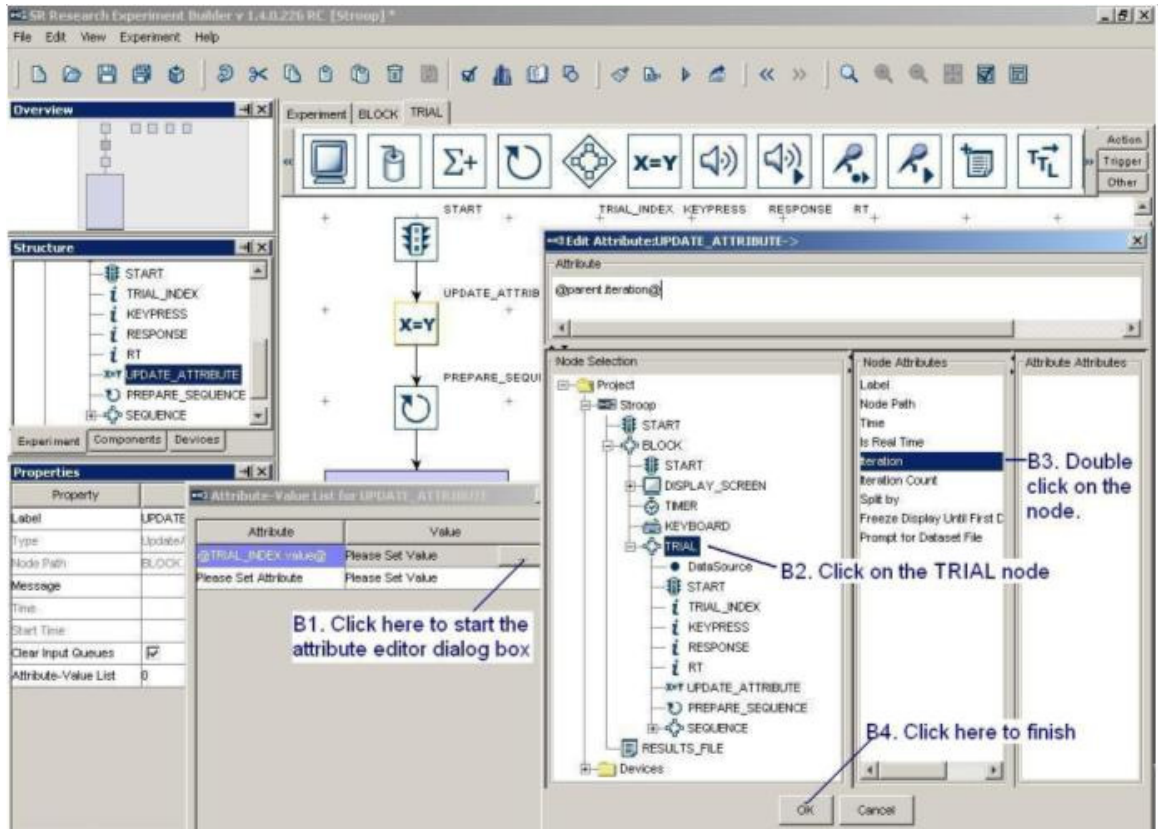

Figure 15-12. Update Trial Iteration.

- d. Similarly, set the second cell of the "Attribute" column to `@RT.value@`. Click the left end of the second cell under the "Value" column, type -32768 and press Enter to register the change.
- e. Set the Attribute 3 to `@KEYPRESS.value@` and value 3 to ".".
- f. Set the Attribute 4 to `@RESPONSE.value@` and value 4 to ".".

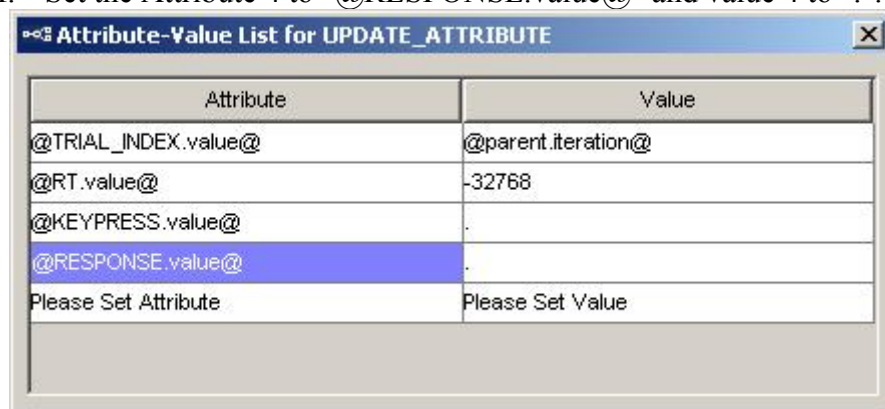

Figure 15-13. Updating the Attribute of RT

- 6) Add a "Prepare Sequence" action into the work space. Click on the added action and review the settings in the property table. Make sure to check the "Flush

- Log” box so that the data output for the previous trial is done before starting a new trial.
- 7) Click on the “Action” Tab of toolbox, select the “Sequence” node, hold down the left mouse button and drag it into the work space.
 - 8) Make a connection from the “START” node to “UPDATE_ATTRIBUTE”, from “UPDATE_ATTRIBUTE” to “PREPARE_SEQUENCE”, from “PREPARE_SEQUENCE” to the “SEQUENCE” node. Please note that the four variables RT, KEYPRESS, RESPONSE, and TRIAL_INDEX should not be connected to other nodes.
 - 9) Click at any blank area in the Work Space. Click the right mouse button and select “Arrange Layout” in the popup menu. Click ok in the following dialog box to re-arrange the nodes in an orderly fashion.
 - 10) Double click on the newly created sequence to fill in the actual events in the recording.

15.8 Editing Trial Event Sequence – Part 1

The next step is to work out the actual display presentation in a trial. In this example, we first show a fixation mark in the center of the screen for one second, followed by the presentation of the Stroop word. Wait for a keyboard response by the subject or the trial times out in eight seconds, and the display is cleared.

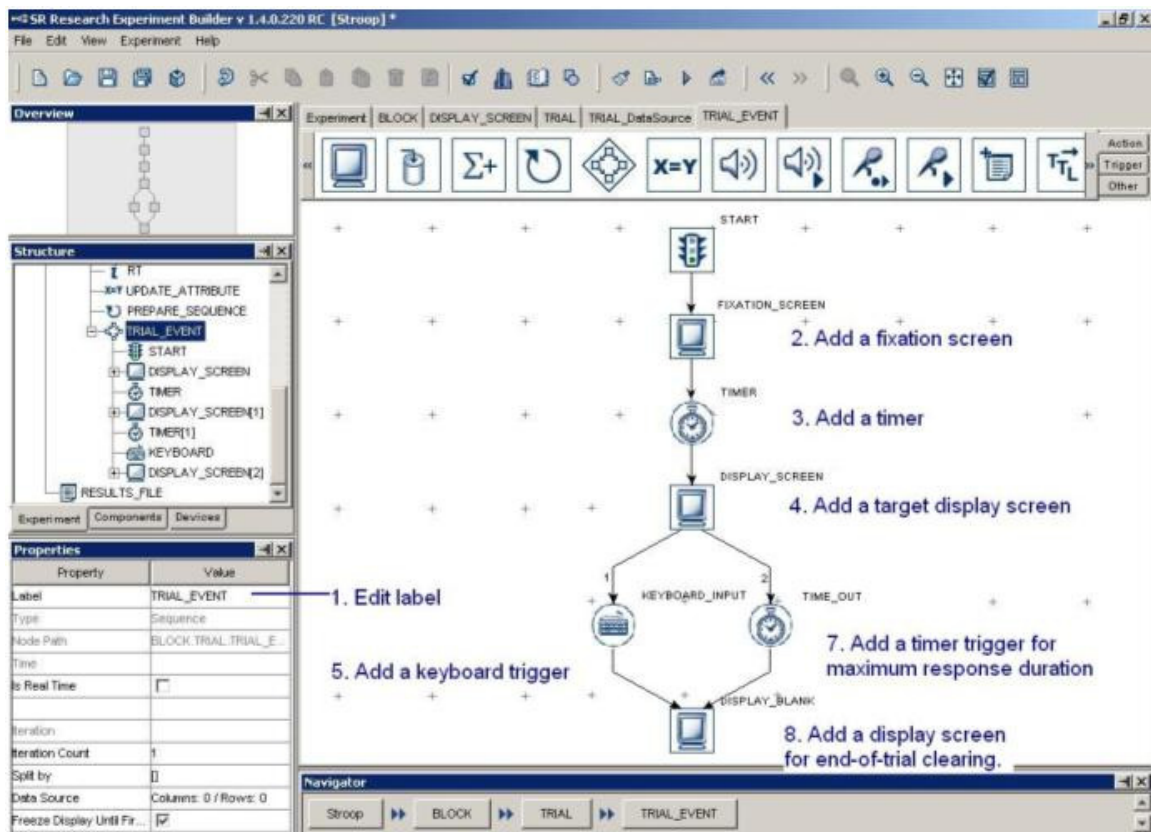

Figure 15-14. Editing Recording Sequence

- 1) Select the newly added “Sequence” node. Rename the label as “TRIAL_EVENT”. Make sure that the “Is Real Time” box is **not checked** as this will make the keyboard dysfunctional.
- 2) Click on the “Action” Tab of the component toolbox, select the “display screen” action, hold down the left mouse button and drag the action into the work area. Select the action and rename it as “FIXATION_SCREEN”. We will add a fixation cross in this screen (see Section 15.8.1).
- 3) Click on the “Triggers” Tab of toolbox, select the “TIMER” node, hold down the left mouse button and drag the trigger into the work space. Click on the Timer object. Enter 1000 in the “duration” field.
- 4) Add another “display screen” action. This will be the screen showing the Stroop word (see Section 15.8.2).
- 5) Add a Keyboard Trigger. Select the trigger and edit the label as “KEYBOARD_INPUT”. Double click on the left part of the value field for the “Keys” attribute. This will bring up a keyboard for choosing the possible response keys. Press the CTRL key while selecting multiple desired keys. In this experiment, choose the following keys: b (for blue color), r (for red color), and g (for green color). Click on the “Close” button (X) at the top right corner of the dialog to finish.

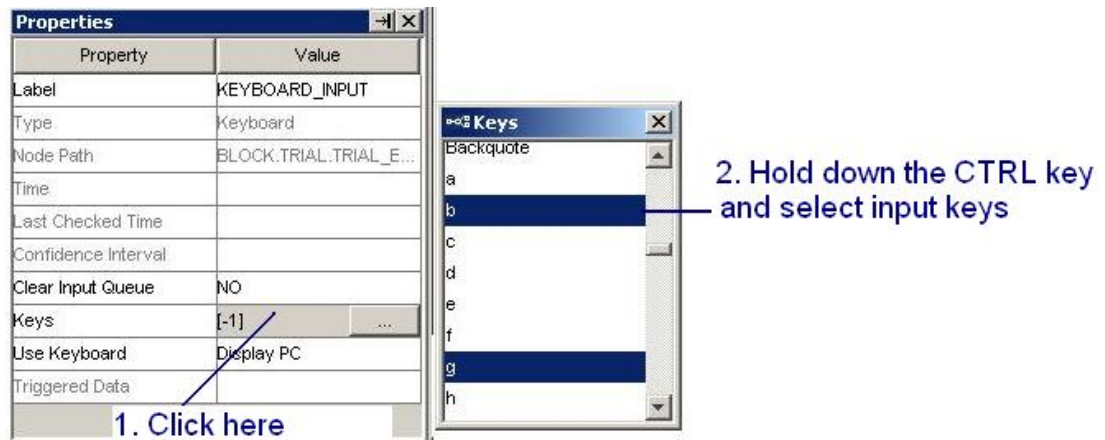





Figure 15-15. Setting Response Keys.

- 6) Add another Timer trigger. Rename it as “TIME_OUT” and set the duration as 8000 msec.
- 7) Add another “DISPLAY_SCREEN” action. Click on the action and modify its label as “DISPLAY_BLANK”. This will be the blank screen to clear the Stroop word.
- 8) Make a connection from the “START” node to “FIXATION_SCREEN”, from “FIXATION_SCREEN” to “TIMER”, from “TIMER” to “DISPLAY_SCREEN”, from “DISPLAY_SCREEN” to “KEYBOARD_INPUT” and “TIME_OUT”, from the last two triggers to “DISPLAY_BLANK”.
- 9) Click at any blank area in the work space, then click the right mouse button and select "Arrange Layout" in the popup menu to re-arrange the nodes in an orderly fashion.

15.8.1 Creating the Fixation Screen.

This section illustrates the creation of the fixation screen. Images must be loaded into the image resource library before they can be used. Follow the steps below to add images to the resource library (see Figure 15-16), assuming that you have already created the image “Fixation.bmp”.

- 1) From the Experiment application menu bar, select “Edit → Library Manager”.
- 2) In the following library manager dialog box, select the “Image” Tab.
- 3) Click on the Add button to load in images. The properties and a preview of the image (size, type of the file, and color bits information) will be displayed in the bottom.
- 4) Click the  button to finish.
- 5) Double click on the FIXATION_SCREEN action in the work space of the Graph Editor Window.
- 6) Click on the image () button on the screen builder tool to select the type of resource to be added and then click anywhere on the screen. In the following “Select Image” Dialog, select “Fixation.BMP” and then click on the “OK” button.
- 7) Select the image resource. Click on both “Horizontal Center Alignment” and “Vertical Center Alignment” () buttons to place it in the center of the screen. Select the resource again and click the right mouse button. Select “Lock Resource” in the following popup menu to prevent the image being accidentally moved in the Screen Editor.

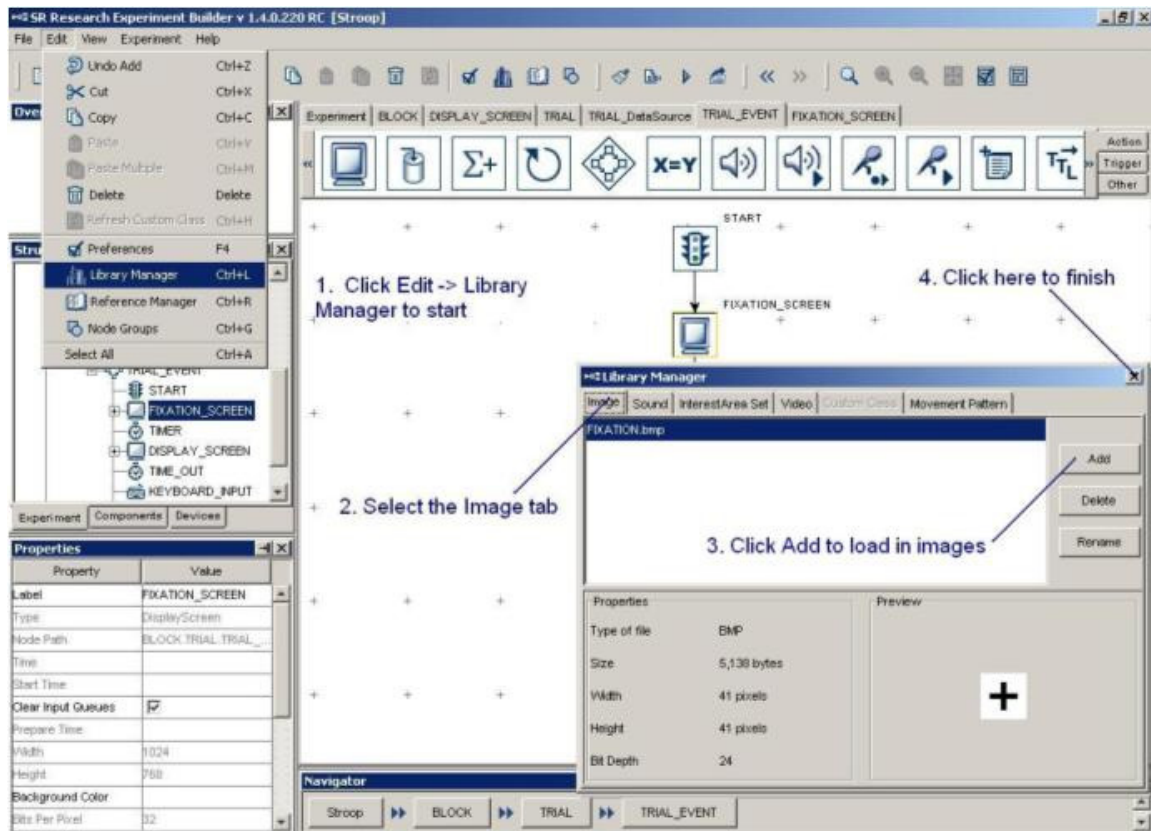

Figure 15-16. Loading Resources to Image Library

15.8.2 Creating the Stroop Display Screen.

Next, we will create a screen containing the Stroop color word. A text resource should be added to the display screen. The properties of the text resource, such as font name, size, text to be displayed, and alignment style, should be modified (see Figure 15-17). To do this, first double click on the “DISPLAY_SCREEN” object in the work space (not in the structure list), until the screen builder interface is displayed in the Graph Editor Window.

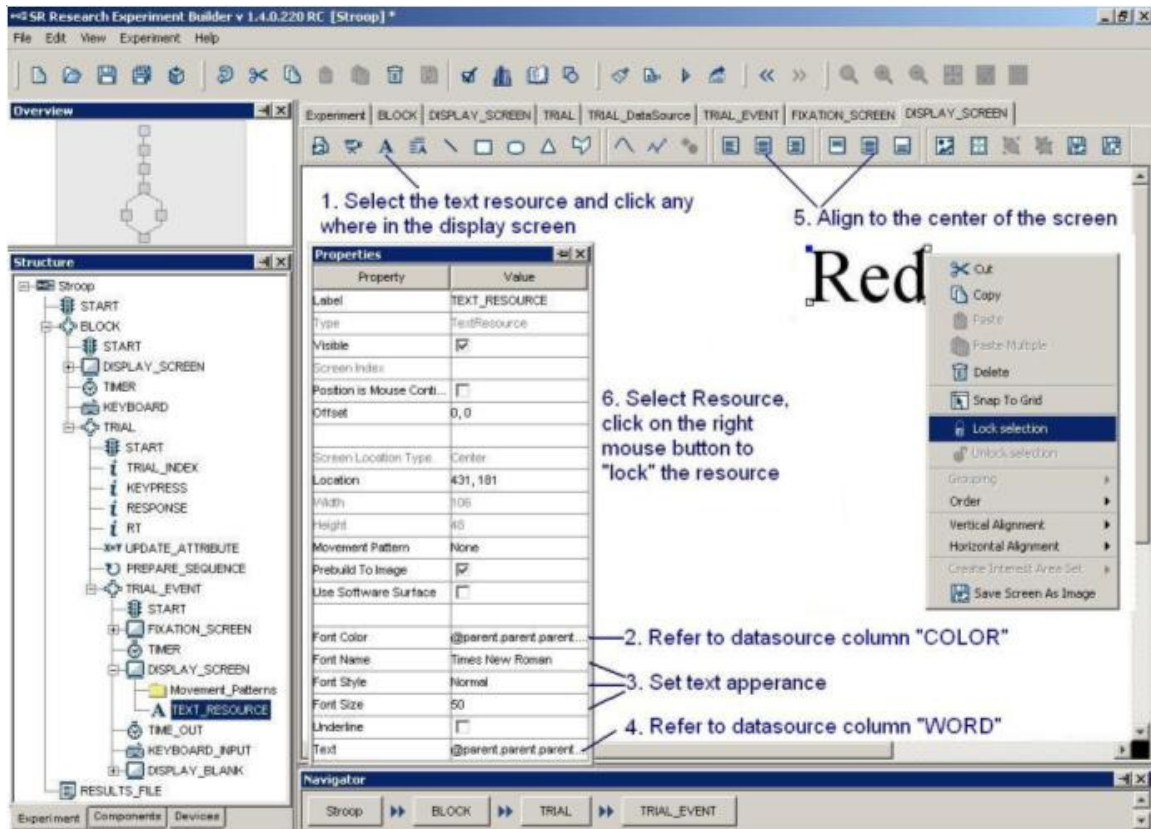

Figure 15-17. Adding Text to Display Screen

- 1) Click on the “Insert Text Resource” button (A) on the Screen Builder tool bar, and click at any position in the work area.
- 2) Set the reference of the Font Color to the “COLOR” column of the Data Source. Double click on the far right end of the value field of the “Font Color” property. This will bring up an attribute editor dialog (see Figure 15-18).
 - a. Click on DataSource node under “TRIAL” sequence on the node selection list.
 - b. Double click on the “COLOR” node in the node attributes window. This will update the contents of “Attribute” editor dialog as @parent.parent.parent.TRIAL_DataSource.COLOR@.
 - c. Click on the “OK” button to finish.

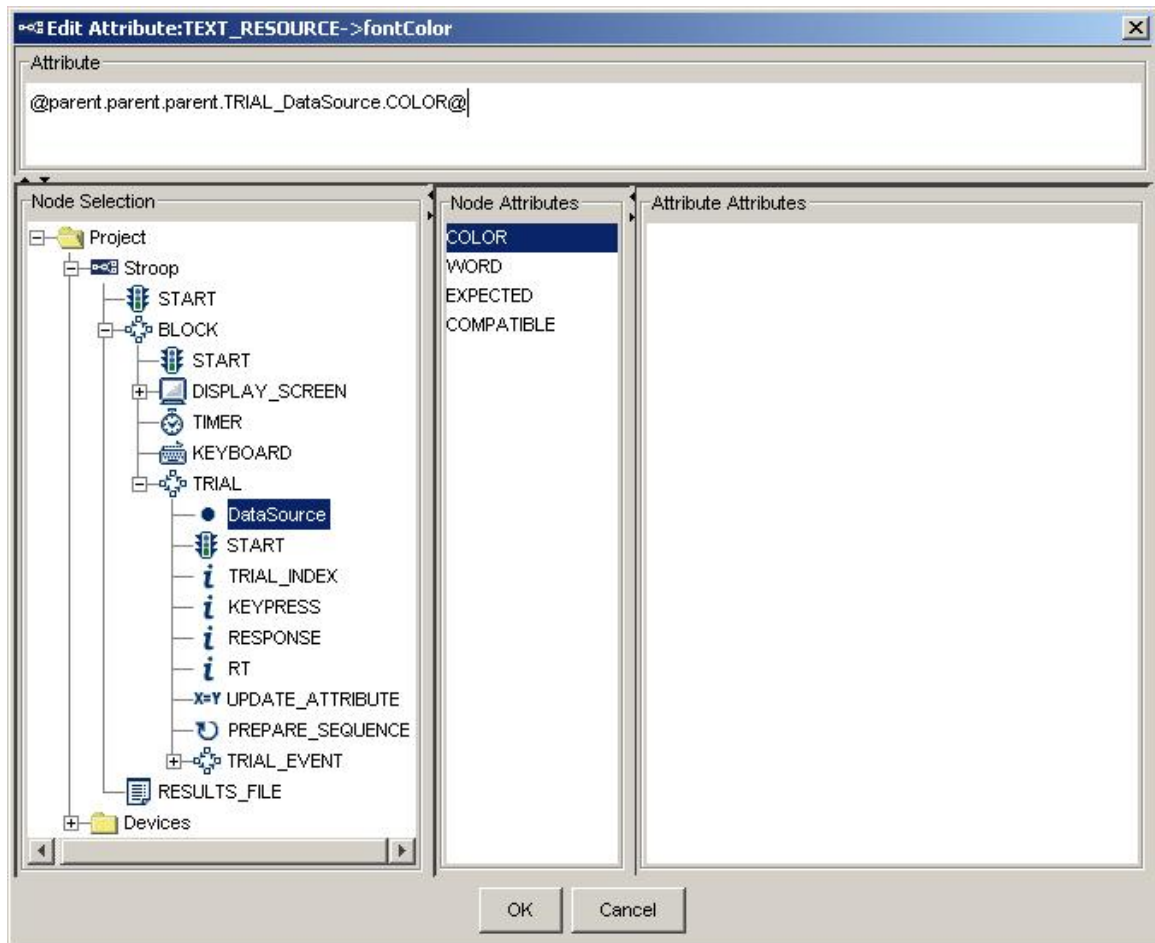



Figure 15-18. Referring Text to Be Shown to Data Source

- 3) Set the appearance of the Text by choosing the desired font name, font style and font size.
- 4) Similar to Step 2, set the reference of the Text to the “WORD” column of the Data Source.
- 5) Select the newly added text resource, click on both “Horizontal Center Alignment” and “Vertical Center Alignment” () buttons to place the text in the center of the screen.
- 6) Select the text resource on the work area, click the right mouse button, and select the “Lock Selection” option so that the resource will not be moved accidentally.

15.9 Editing Trial Event Sequence – Part 2

Following the presentation of the Stroop word, participant’s response should be checked and reaction time for he trial be calculated. The following nodes (see Figure 15-19) are added for checking for response and giving feedback on participant’s performance.

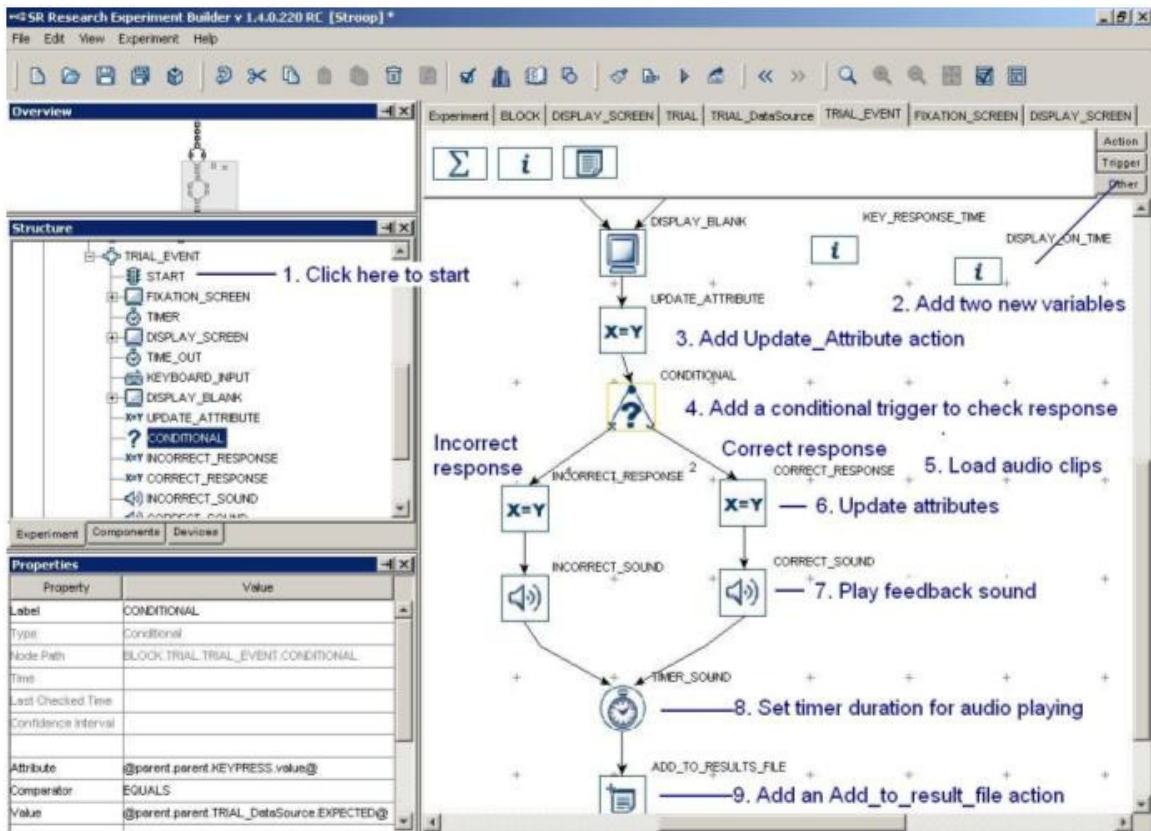

Figure 15-19. Editing Recording Sequence

- 1) Click on the “TRIAL_EVENT” sequence.
- 2) Add two new variables and rename them as “DISPLAY_ON_TIME” and “KEY_RESPONSE_TIME” in the work space. Set the initial values of both variables to 0.0.
- 3) Add an Update Attribute action to get the time for target display onset, and time and response key from the keyboard. Click on the action and modify the following attributes (see Figure 15-20).

Attribute	@parent.parent.KEYPRESS.value@
Value	@KEYBOARD_INPUT.triggeredData.key@
Attribute 2	@DISPLAY_ON_TIME.value@
Value 2	@DISPLAY_SCREEN.time@
Attribute 3	@KEY_RESPONSE_TIME.value@
Value 3	@KEYBOARD_INPUT.triggeredData.time@
Attribute 4	@parent.parent.RT.value@
Value 4	= @DISPLAY_ON_TIME.value@ - @KEY_RESPONSE_TIME.value@

Please note that the actual time when the Stroop display is presented is the @DISPLAY_SCREEN.time@ but not @DISPLAY_SCREEN.startTime@. The former is the time when the display is actually shown whereas the latter is time

when the DISPLAY_SCREEN action starts (i.e., screen is prepared before it can be flipped). The time when the keyboard response is made should be the @KEYBOARD_INPUT.triggeredData.time@ instead of @KEYBOARD_INPUT.time@. Again, the former is the time when the response key is pressed whereas the latter is the time when the KEYBOARD_INPUT trigger fires. Please note that an "=" sign is added before "@DISPLAY_ON_TIME.value@ - @KEY_RESPONSE_TIME.value@" so that an equation can be created in the cell.

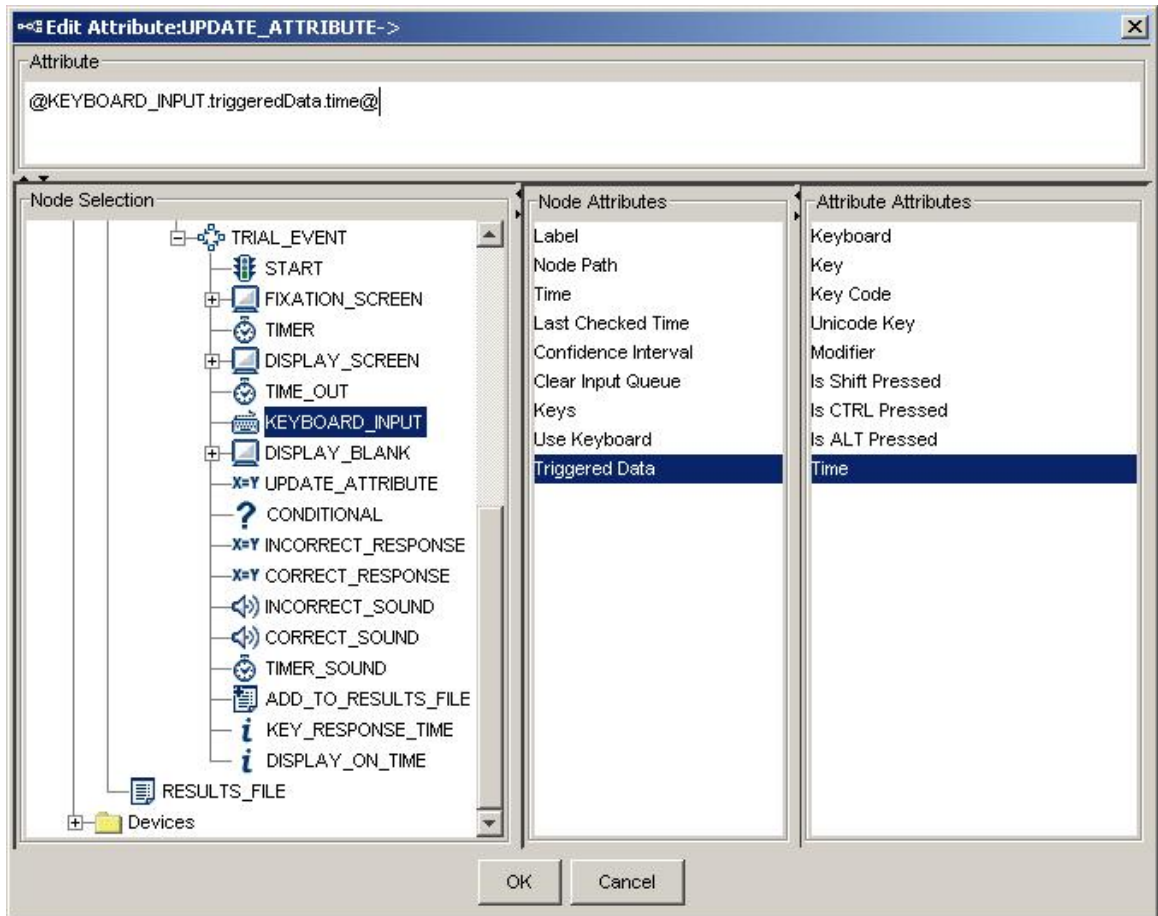

Figure 15-20. Accessing the Subattribute of the TriggeredData Attribute.

- 4) Add a second Update Attribute action to calculate the reaction time for the trial. Click on the action and modify the following attributes.

Attribute	@parent.parent.RT.value@
Value	= @DISPLAY_ON_TIME.value@ - @KEY_RESPONSE_TIME.value@
Attribute 1	@parent.parent.TRIAL_INDEX.value@
Value 1	@parent.parent.iteration@

Please note that an "=" sign is added before "@DISPLAY_ON_TIME.value@ - @KEY_RESPONSE_TIME.value@" so that an equation can be created in the cell.

- 5) Add a conditional trigger to determine whether a correct response has been made by checking whether the key pressed is the desired keyboard response. Select the conditional trigger, set:
 - a. attribute to “@parent.parent.KEYPRESS.value@”.
 - b. comparator to “EQUALS”
 - c. value to “@parent.parent.TRIAL_DataSource.EXPECTED@”.

The conditional trigger yields true result when the key pressed is the same as the expected key response set in the Data source. The user needs to set value for the RESPONSE variable and provide audio feedback for each branch of the conditional trigger separately.

- 6) Before working on each branch of the conditional trigger, the user should load feedback audio clips into the resource library. Click Edit -> Library Manager from the Experiment Builder menu bar. In the library manager dialog box (see Figure 15-21):

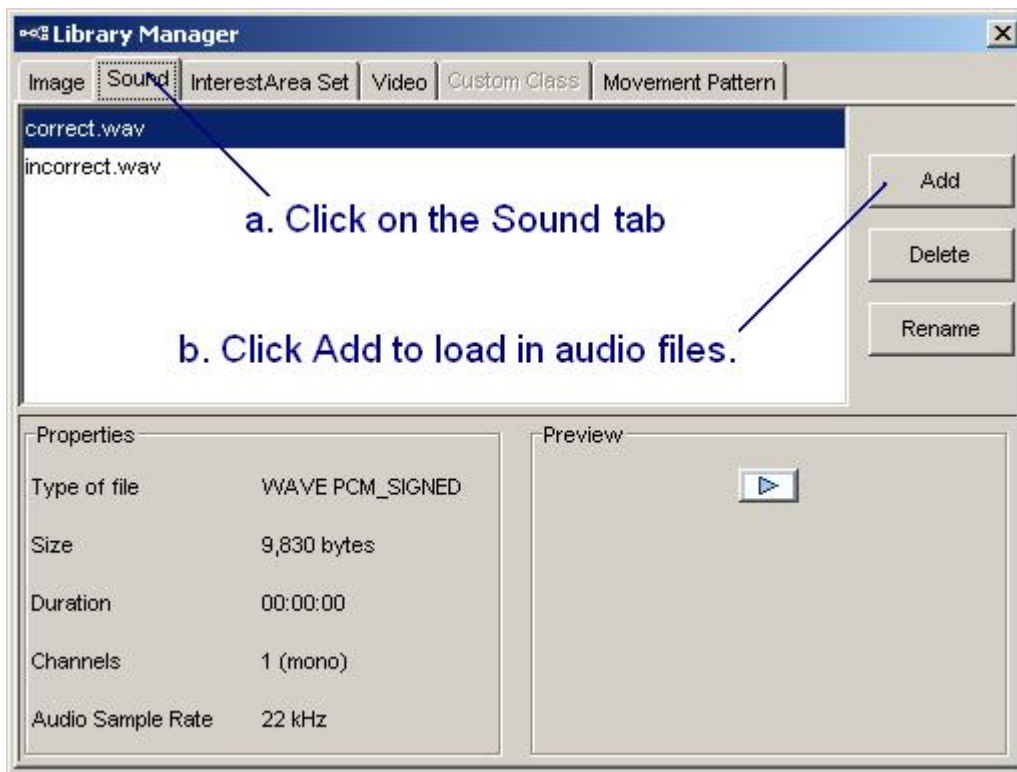

Figure 15-21. Loading Feedback Audio Clips.

- a. Select the “Sound” Tab
- b. Click on the “Add” button and load in the desired audio clips (correct.wav and incorrect.wav).
- c. Click on the “close” button at the top-right corner of the dialog box.

- 7) Add an UPDATE_ATTRIBUTE action and a PLAY_SOUND action.
 - a. Click on the UPDATE_ATTRIBUTE action and rename it as "CORRECT_RESPONSE". Set the Attribute field to "@parent.parent.RESPONSE.value@" and Value Field to "Correct".
 - b. Click on the PLAY_SOUND action and rename it as "CORRECT_SOUND". Select "Correct.wav" from the dropdown list of the "Sound File" property.

- 8) Add another pair of UPDATE_ATTRIBUTE and PLAY_SOUND actions.
 - a. Click on the UPDATE_ATTRIBUTE action and rename it as "INCORRECT_RESPONSE". Set the Attribute field to "@parent.parent.RESPONSE.value@" and Value Field to "Incorrect".
 - b. Click on the PLAY_SOUND action and rename it as "INCORRECT_SOUND". Select "Inorrect.wav" from the dropdown list of the "Sound File" property.

- 9) Add a timer and rename its label as "TIMER_SOUND". Set the timer duration as 500 msec so that the feedback sound can be played complete before the trial ends.

- 10) From the "Action" tab of the component toolbox, add an ADD_TO_RESULTS_FILE action. Set the "Result File" to RESULT_FILE.

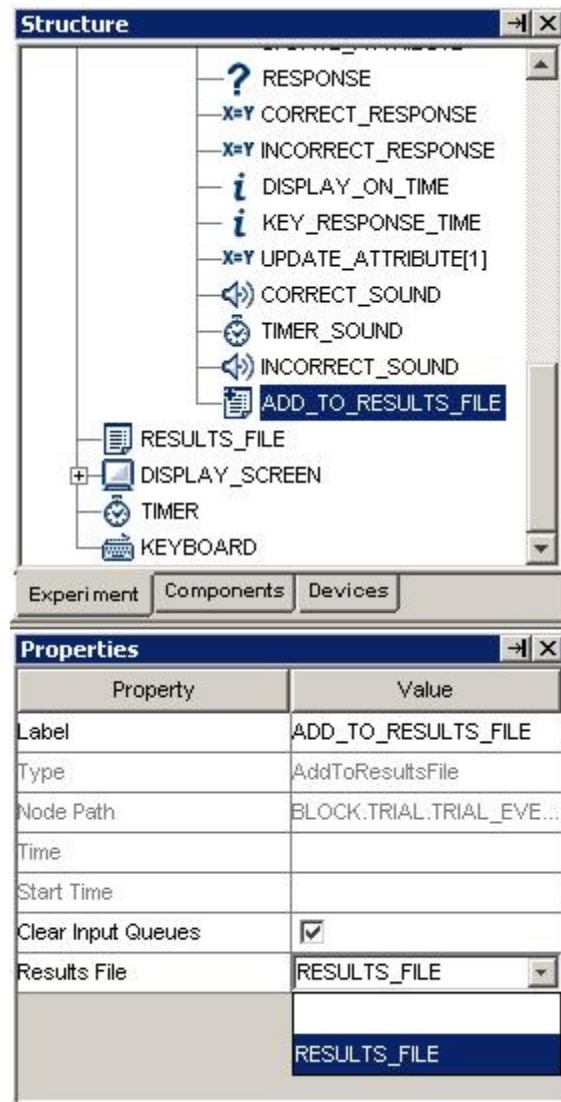

Figure 15-22. Send Results to a Result File.

Make the following connections to the experiment graph:

- a. from the DISPLAY_BLANK to UPDATE_ATTRIBUTE action;
- b. from the UPDATE_ATTRIBUTE to the CONDITIONAL trigger;
- c. from the left branch of the CONDITIONAL trigger to INCORRECT_RESPONSE;
- d. from INCORRECT_RESPONSE to INCORRECT_SOUND;
- e. from INCORRECT_SOUND to TIMER_SOUND;
- f. from the right branch of the CONDITIONAL trigger to CORRECT_RESPONSE;
- g. from CORRECT_RESPONSE to CORRECT_SOUND;
- h. from CORRECT_SOUND to TIMER_SOUND;
- i. from TIMER_SOUND to ADD_TO_RESULTS_FILE.

- 11) Click at any blank area in the work space, then click the right mouse button. Select "Arrange Layout" in the popup menu to re-arrange the nodes in an orderly fashion.

15.10 Outputting Data to the Result File

Finally, variables should be added to the result file (see Figure 15-23).

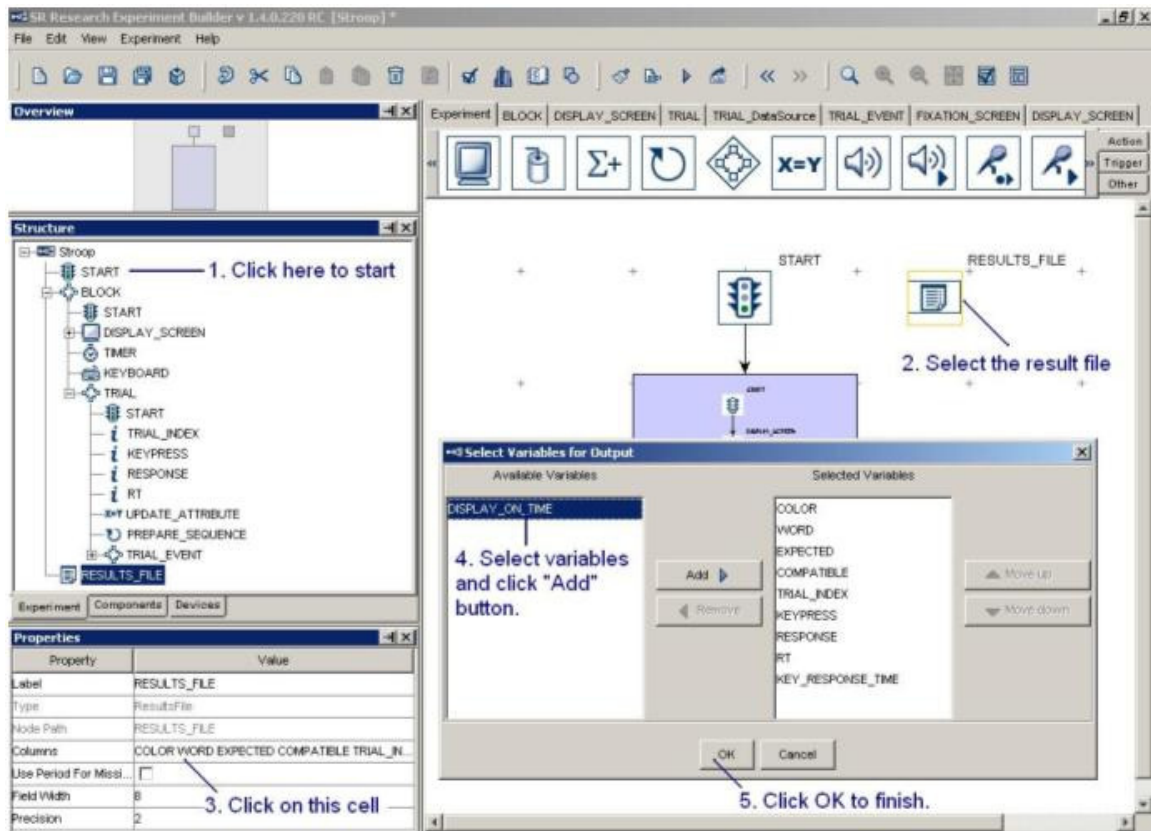

Figure 15-23. Adding Variables to Results File

- 1) From the Structure Window, click on the first "START" node (just underneath the topmost "Stroop" node).
- 2) In the work space, select the RESULTS_FILE node
- 3) Click on the value field of the "Columns" property of the node
- 4) Select the desired variables, click "Add" button to add the variables to the results file. Click OK to finish.
- 5) In the properties window of the Results node, set "Field Width" to 8 and "Precision" to 2. If you want to record the missing values as "." in the result file, make sure the "Use Period for Missing Values" box is checked.

15.11 Running the Experiment

Click on “Experiment → Build” menu to build the experiment. The Editor Selection Tab in the Graph Editor Window will be set to the “Output” tab and build information will be displayed. Watch out for error (displayed in red) and warning (in brown) messages during building. If no errors are found in the Experiment graph, click on “Experiment -> Test Run” to check out whether the experiment runs as designed. Note that test run is not intended for real data collection and should be only used when you are testing your experiment.

To run the experiment for data collection, the user should first deploy the experiment to a different directory and run the experiment without relying on the Experiment Builder GUI and for better timing performance. Simply double click on the executable file Stroop.exe in the deployed directory and then follow the instructions on the screen. The experiment result file should be saved in the “results/{session name}” subdirectory of the experiment directory.

16 Experiment Builder Project Check List

The following checklist was created to summarize some common problems in creating and running an Experiment Builder project. See the .html version of this document for a list of frequently asked questions.

If this is an EyeLink experiment,

- 1) Is there a recording sequence in the project?
[FAQ: How to convert a non-EyeLink experiment to an EyeLink experiment?]
- 2) Does it implement the "hierarchical organization" concept of experiment design? Is the data source attached to the trial sequence, instead of the recording sequence? If the datasource is attached the recording sequence, you will not be able to do image drawing to the host computer, perform a pre-recording drift correction, as well as reset triggers, actions, and resources.
- 3) Have the experiment trial variables been added to the "EyeLink DV Variables" of the Experiment node?
[FAQ: The automatic TRIALID creator doesn't work?]
- 4) Has the 'Message' field of the triggers and actions been filled? Messages will be sent to EDF file to mark important events. For example, you may write a "SYNCTIME" message for the DISPLAY_SCREEN action that shows the target screen.
- 5) Has "Prebuild to Image" button of the screen resources been enabled? This ensures image files will be created in the "runtime\images" directory for Data Viewer overlay.
[FAQ: How to show the images in Data Viewer?]
[FAQ: No image is overlaid under the fixations in Data Viewer.]
- 6) Has the target screen been transferred to the host PC as feedback graphics?
[FAQ: How can we see the text on the host computer?]
[FAQ: Warning:2015 No display screen is selected for PrepareSequence TRIAL->PREPARE_SEQUENCE.]
[FAQ: Tracker screen flashes many times very quickly prior to each trial on the host PC.]
- 7) Has a Recording Status Message been written to the tracker screen to report progress of experiment testing?
- 8) Has a PREPARE_SEQUENCE action been added before a trial-recording SEQUENCE? Is this action called before the trial run-time for EVERY iteration of the trial recording SEQUENCE?

- 9) Has an optimal screen refresh rate been used? Has a proper video card/monitor driver been installed?
[FAQ: The stimuli screen was really flickering during the experiment.]
[FAQ: Could not initialize display.]
- 10) Is the trial-recording sequence running under real-time mode? You should have the "Is Real Time" box of that sequence checked if it does not contain a keyboard, mouse, or Cedrus input trigger.
[Discussion Forum Post: Real time mode, EL_Button box]
[FAQ: Warning:2003 The IO node KEYBOARD is used in realtime Sequence.]
- 11) Does the "background color" property of the calibration and drift correction screens match that of the display screens used in the experiment? Try to match the background color of the screen during calibration and validation to that of the test displays because changes in pupil size caused by large brightness differences can degrade the system accuracy.
- 12) Are you running the deployed version of the experiment?
[FAQ: 'Results file' had disappeared when we cleaned the experiment project.]
[FAQ: File disappears from the folder where it was stored when we got ready to run it.]
- 13) Do you randomize the datasource file for each subject? Typically, the datasource is attached to a TRIAL sequence (not to a recording sequence).
[FAQ: How to modify the data source file to create different trial ordering?]
[FAQ: What do I do with the randomized data source files?]
- 14) Have you taken measures to maximize real-time performance of the display PC when running the experiment?
- 15) Are you viewing your EDF files at the original file locations (i.e., "Results\{Session Name}" directories)?

If this is a non-EyeLink Experiments,

- 1) Please consider the above issues # 2, 5, 8, 9, 10, 12, 11, 13 and the following two extra issues.
- 2) Are you using a result file? If so, have variables and datasource columns been added to the "Columns" field of the result file node? Have you used an ADD_TO_RESULT_FILE action to record data to the result file?
- 3) Are you planning to write out debugging messages for the experiment? If so, check the "Save Messages" attribute of the Experiment node and fill the "Message" field of the triggers and actions.

If this is a reading experiment,

- 1) If using a text or image resource, has the "Prebuild to Image" box of the resource been enabled?
[FAQ: How to show the images in Data Viewer?]
- 2) If using a text or multi-line text resource, have you enabled anti-aliasing drawing?
- 3) Is the drift correction target displayed at the intended location?
[FAQ: How can I draw my own fixation cross and keep it stable at one point during drift correction and stimulus presentation?]
- 4) Are you using non-ASCII characters?
[FAQ: Warning 2001: You are using characters that ascii encoding cannot handle!]
[FAQ: How can I import data file containing "Umlauten" characters?]
- 5) Have you chosen the appropriate font, style, and size for the text or multi-line text resource? You may need to use special fonts to display non-ASCII characters.
- 6) Have you enabled the "Use Runtime Word Segment Interest Area" setting of the text or multi-line text resource? If the above word-based interest areas are not satisfactory or you plan to use an image resources to show the text, you may instead assign a text file to the "Interest Area Set Name" field of the DISPLAY_SCREEN action that contains the screen resource. Leave the rest interest area related work to EyeLink Data Viewer©.
[FAQ: How can I create individual interest areas for every single image in the EB?]

If this is an experiment with eye-based triggers,

- 1) Have you checked out the location type used in the screen editor? Please note that screen resources can be either top-left based or center based whereas the location type of all trigger types (e.g., invisible boundary trigger, mouse trigger, fixation trigger, saccade trigger, and sample velocity trigger) is top-left based.
- 2) If you are running a saccade experiment, which saccade trigger type (saccade trigger vs. sample velocity trigger) should be used?
- 3) If you are using an invisible boundary trigger or sample velocity trigger, is heuristic filter set to a desired setting?

If this is an experiment involving audio playback or recording,

- 1) Do you plan to use ASIO or DirectX driver?
[FAQ: Example for synchronized audio-video presentation.]
- 2) If you are using ASIO driver, have you followed the instructions for Experiment Builder ASIO Installation?
[FAQ: Empty .WAV files created with the RECORD_AUDIO action.]

17 Preference Settings

Many aspects of the SR Research Experiment Builder can be configured in the application preference settings, which can be accessed by clicking on “Edit → Preferences” from the application menu bar (see Figure 17-1). These include the EyeLink® tracker settings, display setup, screen coordinate type, default values for the experiment components (triggers, actions, and screen resources), graph layout, etc. All of the changes can be saved by pressing the “Save Properties as Default” button, allowing them to be used in the future experiment sessions. If the changes are valid only for the current experiment creation session, simply press the close (X) button on the dialog box.

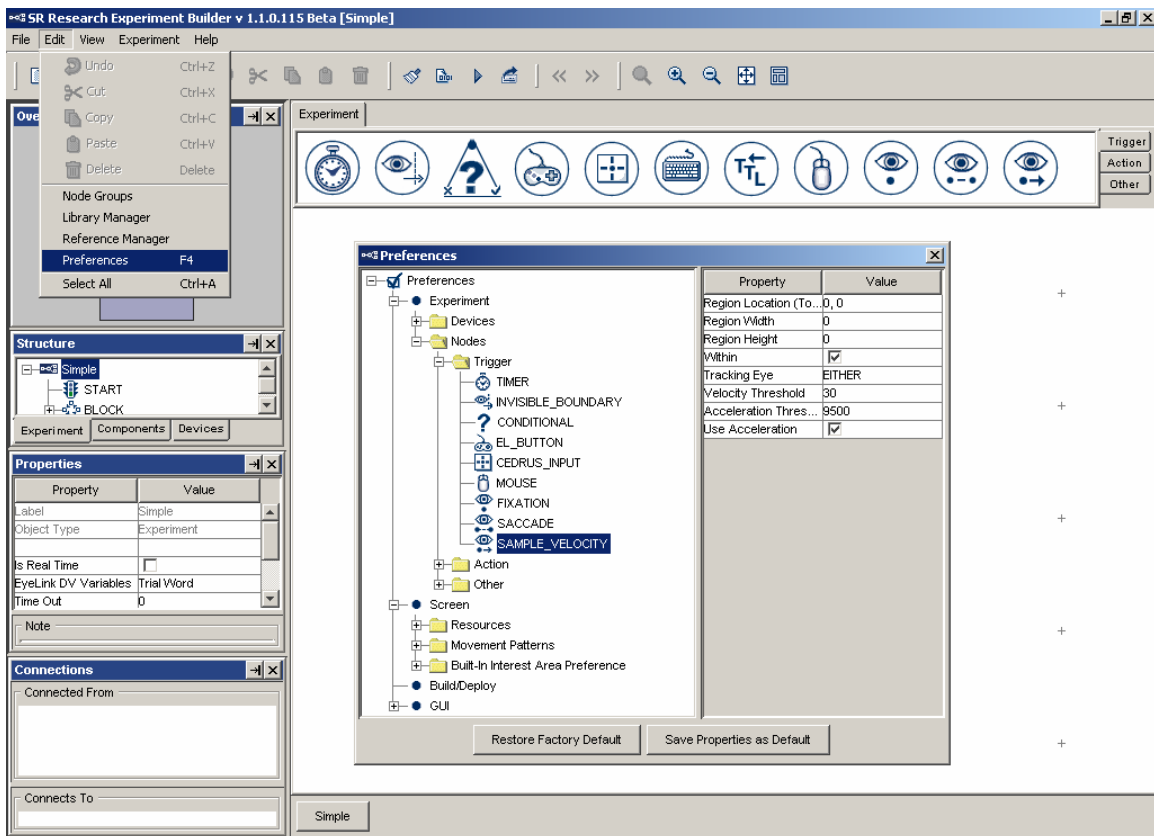
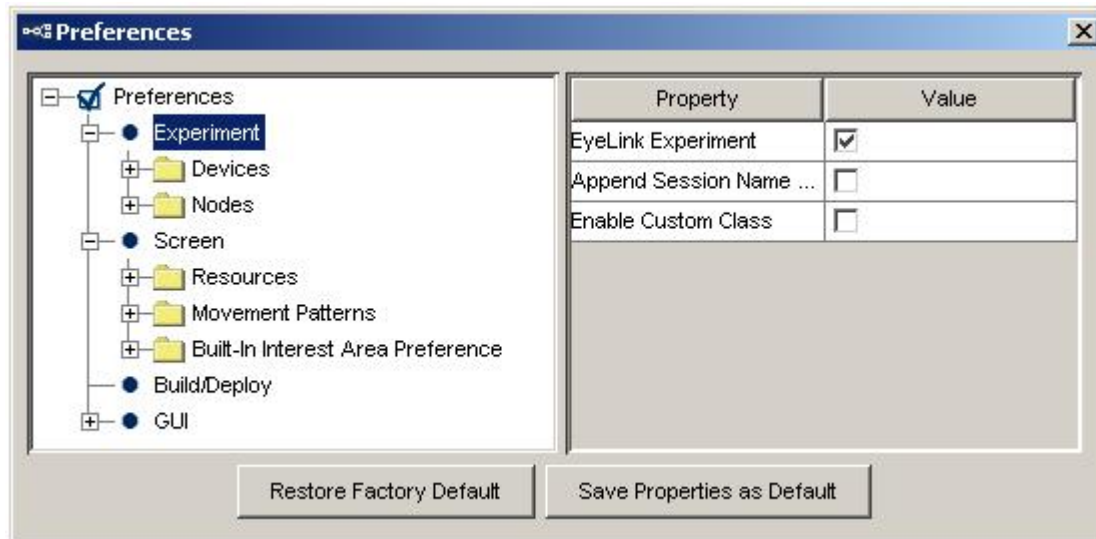

Figure 17-1. Accessing the Experiment Builder Preference Settings.

17.1 Experiment

This section lists preference settings that are related to the Experiment Builder devices and nodes (actions, triggers, etc.).



EyeLink® Experiment: If checked, the experiment projects can be run together with an EyeLink® tracker. All eye-movement related triggers (saccade, fixation, velocity, and boundary triggers) and actions (sending EyeLink® message, sending EyeLink® command, camera setup, and drift-correction actions) will be available for experiment generation. If this field is unchecked, all of the abovementioned actions and triggers will be hidden.

Append Session Name: If checked, Experiment Builder will concatenate the current session name with the output files (warning.log, messages.txt, etc.) in the "results\{session name}" directory.

Enable Custom Class: If this box is checked, additional features (Custom-class instance, Execute method, Custom-class library, Callback attribute for Sequences, etc.) will be available for programming an experiment using custom class. Please note that custom-class related features belong to advanced Experiment Builder functionality that requires knowledge of the Python programming language. If you wish to use this feature, please contact SR Research (eb@sr-research.com) for support.

17.1.1 EyeLink®

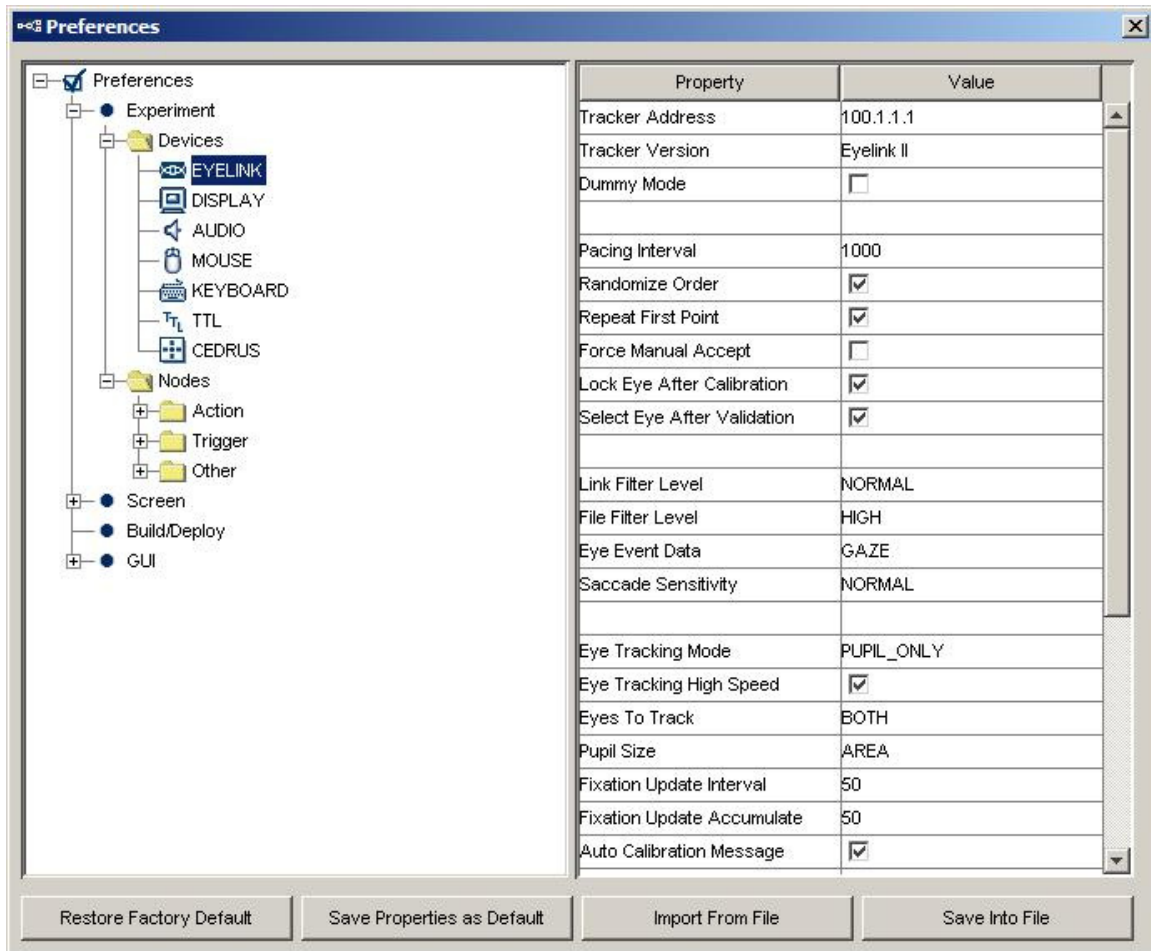

Tracker Address (.trackerAddress): The IP address of the host PC. This must be the same as the "host_address" setting in the eyenet.ini file on the host PC (typically under c:\eyelink2\exe directory for an EyeLink® II tracker, c:\EyeLink\exe directory for an EyeLink® I tracker, and c:\elcl\exe directory for an EyeLink 1000 tracker).

Tracker Version (.trackerVersion): The version of EyeLink eye tracker (EyeLink I, EyeLink II, or EyeLink 1000).

Mount (.mount): The mount type (Tower, Desktop Binocular, or Desktop Monocular) of EyeLink 1000 tracker. This option is only available for EyeLink 1000 eye trackers.

Dummy Mode (.dummyMode): If checked, the experiment can be run without attempting to connect to the EyeLink® tracker. This can be used to simulate EyeLink® link connection for early development work, or when the EyeLink® tracker is not available.

Calibration

Pacing Interval (.pacingInterval): Set the time delay in milliseconds for calibration and validation if calibration triggering is done automatically.

Randomize Order (.randomizeOrder): If checked, randomize the presentation sequence of calibration and validation fixation dots.

Repeat First Point (.repeatFirstPoint): If checked, redisplay the first calibration or validation fixation dot.

Force Manual Accept (.forceManualAccept): If checked, the user has to manually accept each calibration and validation fixation point.

Lock Eye After Calibration (.lockEyeAfterCalibration): If checked, locks the recording eye on the display PC keyboard if performing a monocular recording.

Select Eye After Validation (.selectEyeAfterValidation): Controls whether the best eye is automatically selected as the default after validation. If unchecked, binocular mode is kept by default.

Data Processing

Link Filter Level (.linkFilterLevel): Each increase in filter level reduces noise by a factor of 2 to 3 but introduces a 1-sample delay to the link sample feed. This setting is only available for EyeLink II and 1000 trackers.

File Filter Level (.fileFilterLevel): Selects the file sample filter for data in the EDF file. Each increase in filter level reduces noise by a factor of 2 to 3. Note: By changing the file sample filter from high to another value this will affect EyeLink© Data Viewer and other analysis tool calculations. SR Research Ltd recommends leaving this value set to High. This setting is only available for EyeLink II and 1000 trackers.

Heuristic Filter (.heuristicFilter): Used to set level of filtering on the link and analog output, and on file data. This setting is only available for EyeLink I tracker.

Eye Event Data (.eyeEventData): Sets how velocity information for saccade detection is to be computed. This setting is almost always left to GAZE.

Saccade Sensitivity (.saccadeSensitivity): Defines the sensitivity of the EyeLink© II or 1000 parser for saccade event generation. Normal is intended for cognitive tasks like reading; while High is intended for psychophysical tasks where small saccades must be detected.

Eye Tracking

Eye-tracking Mode (.eyeTrackingMode): Select the tracking mode for recording. EyeLink© II runs either under a pupil-CR (corneal reflection) mode or a pupil-only mode. EyeLink© I only runs under a pupil-only mode.

Eye-tracking High Speed (.eyeTrackingHighSpeed): Sets sampling rate in combination with the Eye-tracking mode setting for EyeLink II trackers. If set to true, it will be 500 Hz in a pupil-only recording and 250 Hz in a pupil-CR mode. This setting is only available for EyeLink II tracker.

Pupil Detection (.pupilDetection): Algorithm used to detect the pupil center position (centroid algorithm vs. ellipse fitting algorithm). This option is only applicable to EyeLink 1000/2k trackers.

Eye-tracking Sampling Rate (.eyeTrackingSamplingRate): Sets sampling rate for EyeLink 1000. The available options are: 1000 (default), 500, and 250. This setting is only available for EyeLink 1000 tracker.

Eyes To Track (.eyesToTrack): Select the eye(s) to track during recording. For a binocular eye tracker (EyeLink I and II), the default is "BINOCULAR". For monocular EyeLink 1000 tracker, the default is "EITHER".

Pupil Size (.pupilSize): Record the participants' eye area or diameter in pixels.

Fixation Update Interval (.fixationUpdateInterval): During fixation, send updates every (m) msec, integrated over (n) msec (max=m, min = 4 msec). These can be used for gaze-controlled software or for pursuit tracking. Intervals of 50 or 100 msec are suggested. Interval of 0 disables.

Fixation Update Accumulate (.fixationUpdateAccumulate): During fixation, send updates every (m) msec, integrated over (n) msec (max=m, min = 4 msec). Normally set to 0 to disable fixation update events. Set to 50 or 100 msec. to produce updates for gaze-controlled interface applications. Set to 4 to collect single sample rather than average position.

Auto Calibration Message (.autoCalibrationMessage): Should the calibration messages be printed in the EDF file?

Velocity/Acceleration Model (.velocityAccelerationModel): EyeLink 1000 only. This allows to choose the model (5-sample, 9-sample, and 17-sample) used to calculate velocity and acceleration data.

Current Time# (.currentTime): Returns the current tracker time in milliseconds. The tracker clock starts with 0 when the EyeLink host program was started.

Sample Rate # (.sampleRate): Returns the actual sampling rate running in the experiment. This may differ from the value *set* at the "Eye-tracking Sampling Rate" property.

CR Mode # (.CRMode): Returns the actual mode ("PUPIL_CR" or "PUPIL_ONLY" string) running on the host computer. This may differ from the value *set* at the above "Eye-tracking Mode" property.

File Filter # (.fileFilter): Returns the actual file filter level ("OFF", "NORMAL", or "HIGH") used in the experiment. This may differ from the value *set* at the above "File Filter Level" property.

Link Filter # (.linkFilter): Returns the actual link filter level ("OFF", "NORMAL", or "HIGH") used in the experiment. This may differ from the value *set* at the above "Link Filter Level" property.

Eye Used # (.eyeUsed): Returns the actual eye(s) used ("LEFT", "RIGHT", or "BOTH") in the experiment. This may differ from the value *set* at the above "Eyes To Track" property.

Pupil Detection Model # (.pupilDetectionModel): Returns the actual algorithm used to detect the pupil center position (centroid algorithm vs. ellipse fitting algorithm). This option is only applicable to EyeLink 1000/2k trackers.

Last Sample #: Possible data that can be retrieved from the last eye sample (see the table below for details).

Data File Contents

Important: SR Research Ltd. does not recommend changing the following default settings as this may have negative impacts on the data file integrity and your data analysis.

Samples: If checked, samples will be recorded in the EDF file.

Fixations: If checked, fixations will be recorded in the EDF file.

Saccades: If checked, saccades will be recorded in the EDF file.

Blinks: If checked, blinks will be recorded in the EDF file.

Buttons: If checked, press or release of the EyeLink button box will be recorded in the EDF file.

Inputs: If checked, input data will be recorded in the EDF file.

Remote Warnings

Note: The following option is only available for EyeLink Remote eye tracker. Giving out warning may not work on some computers running under the real-time mode. If possible, please check the BIOS setting of the display computer so that hyperthreading or multithreading is enabled.

Enable Remote Warning (.enableRemoteWarning): Whether a warning beep should be given when the eye or target is missing.

Minimum Eye Missing Duration (.eyeMissingThreshold): Minimum amount of time (in milliseconds) the eye data is missing before a warning beep will be given.

Eye Missing Beep (.eyeMissingBeep): The audio clip to be played when the eye is missing. A different audio clip may be used if that clip has already been loaded into the library manager ("Edit -> Library Manager", select the "Sound" tab).

Minimum Target Missing Duration (.targetMissingThreshold): Minimum amount of time (in milliseconds) the target is missing before a warning beep will be given.

Target Missing Beep (.targetMissingBeep): The audio clip to be played when the target is missing. A different audio clip may be used if that clip has already been loaded into the library manager ("Edit -> Library Manager", select the "Sound" tab).

Event Queue Size:

Experiment Builder maintains separate event queues for the eye-based triggers. The following sets the size of the event queue and reports the current event count in each queue.

Fixation Queue Size (.fixationQueueSize): Sets the maximum number of fixation events (FIXUPDATE, STARTFIX, or ENDFIX) that can be cached in the fixation event queue.

Saccade Queue Size (.saccadeQueueSize): Sets the maximum number of saccade events that can be cached in the saccade event queue.

Button Queue Size (.buttonQueueSiz): Sets the maximum number of button events that can be cached in the button event queue.

Sample Queue Size (.sampleQueueSize): Sets the maximum number of samples that can be cached in the link sample queue.

Fixation Event Count # (.fixationEventCount): The number of fixation events (FIXUPDATE, STARTFIX, or ENDFIX) cached in the fixation event queue.

Saccade Event Count # (.saccadeEventCount): The number of saccade events cached in the saccade event queue.

Button Event Count # (.buttonEventCount): The number of button press/released events cached in the button event queue.

The following table lists possible data that can be retrieved from the last eye sample:

Reference	Attribute	Type	Content
Time	.time	Integer	Display PC time when the triggering sample occurs.
EDF Time	.EDFTime	Integer	EDF time of the triggering sample.
Eyes Available	.eyesAvailable	Integer	Eyes available in recording (0 for left eye; 1 for right eye; 2 for both eyes).
Triggered Eye	.triggeredEye	Integer	Eye (0 for left eye; 1 for right eye) whose data makes the current invisible boundary trigger fire.
PPD X, PPD Y	.PPDX, .PPDY	Float	Angular resolution at the current gaze position (in screen pixels per visual degree) along the x-, or y-axis
Left Gaze X, Right Gaze X, Average Gaze X	.leftGazeX, .rightGazeX, .averageGazeX ¹	Float	Gaze position of the triggering sample along the x-axis for the left eye, right eye and an average between the two.
Left Gaze Y, Right Gaze Y, Average Gaze Y	.leftGazeY, .rightGazeY, .averageGazeY ¹	Float	Gaze position of the triggering sample along the y-axis for the left eye, right eye and an average between the two.
Left Pupil Size, Right Pupil Size, Average Pupil Size	.leftPupilSize, .rightPupilSize, .averagePupilSize ¹	Float	Left eye, right eye, or average pupil size (in arbitrary units, area or diameter as selected in the EyeLink© device settings)
Left Velocity, Right Velocity, Average Velocity	.leftVelocity, .rightVelocity, .averageVelocity ¹	Float	Left eye, right eye, or average sample velocity (in degrees /second) ²
Left Acceleration, Right Acceleration, Average Acceleration	.leftAcceleration, .rightAcceleration, .averageAcceleration ¹	Float	Left eye, right eye, or average sample acceleration (in degrees /second ²) ²
Angle	.angle	Float	The angle of the eye movements when the trigger fires.
Target Distance	.targetDistance	Integer	Distance between the target and camera (10 times the measurement in millimeters). This option is for EyeLink Remote eye tracker only. Returns "MISSING_DATA" (-32768) if target is missing or if running a non-Remote eye tracker.
Target X,	.targetX,	Integer	X, Y position of the target in camera

Target Y	.targetY		coordinate. This option is for EyeLink Remote eye tracker only. Returns "MISSING_DATA" (-32768) if target is missing or if running a non-Remote eye tracker.
Target Flags	.targetFlags	Integer	Flags used to indicate target tracking status (0 if target tracking is ok; otherwise error code). This option is for EyeLink Remote eye tracker only. Returns "MISSING_DATA" (-32768) if running a non-Remote eye tracker.

Note:

¹ Returns "MISSING_DATA" (-32768) for the untracked eye.

17.1.2 Display

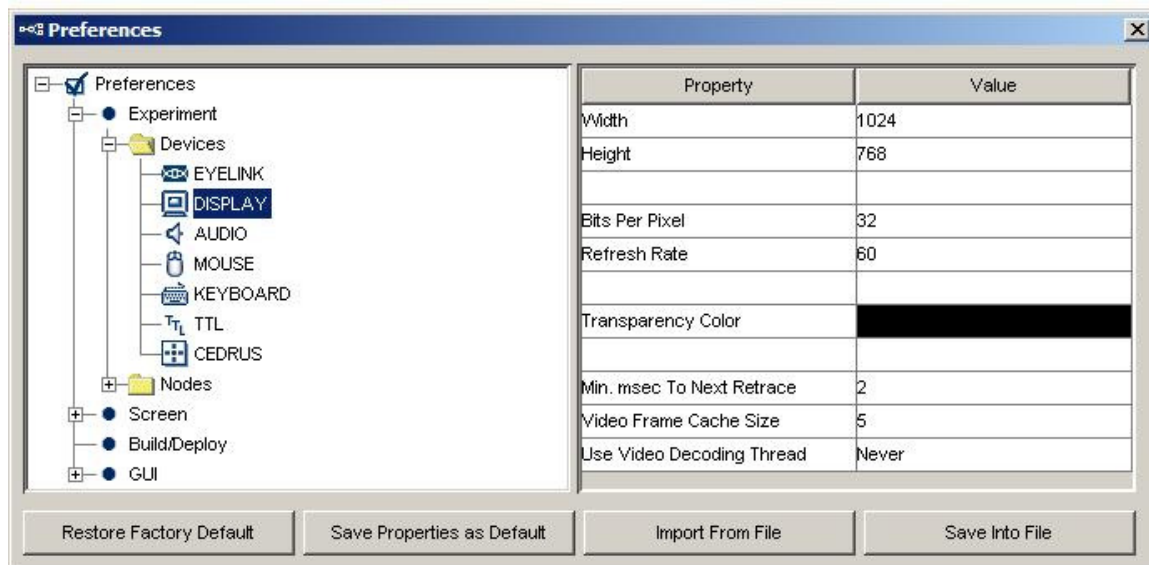

Width (.width): The width of the display screen in pixels.

Height (.height): The height of the display screen in pixels.

Bits Per Pixel (.bitsPerPixel): The number of bits used to represent the luminance and chroma information contained in each pixel.

Refresh Rate (.refreshRate): Sets the refresh rate (Hz) of the monitor.

Transparency Color (.transparencyColor): The setting of transparency color for the display. When you move or copy a selection from an item, any pixels in the selection that match the current background color are, by default, transparent.

Startup Background Color (.startupBackgroundColor): The background color used when experiment starts up.

Minimum msec To Next Retrace (.flipRemainThreshold): The minimum amount of time (in milliseconds) remaining in a retrace before the next flip can be scheduled. In runtime, if the remaining time in a retrace to perform a flip is less than the specified amount of time, the flip will be scheduled to the retrace after to ensure that the flip is done properly.

Video Frame Cache Size (.cacheFrameThreshold): Video frame buffer size. Min should be 5, max should be 60.

Use Video Decoding Thread (.useVideoDecodingThread): Video decoding thread drives the video decoder. Decoding thread continually fills this buffer while video playing thread consumes them.

Current Time # (.currentTime): Reads the millisecond clock running on the display computer; the clock starts with 0 when the EyeLink library is initialized.

Software To Hardware Blit time (.softwareToHardwareBlitTime): Time required to perform a software-based copying of resource from system memory to the display surface.

Hardware To Hardware Blit time # (.hardwareToHardwareBlitTime): Time required to blit resource from the video card memory to the display surface.

Video Memory Size# (.hardwareMemorySize): The total amount of memory found in a video card.

Video Memory Available # (.hardwareMemoryAvailable): The amount of memory in a video card available for graphics operation (e.g., stores images as before they are sent to the display monitor).

Retrace Interval # (.retraceInterval): The duration of one refresh cycle of the monitor, calculated as 1000/refresh rate.

17.1.3 Audio

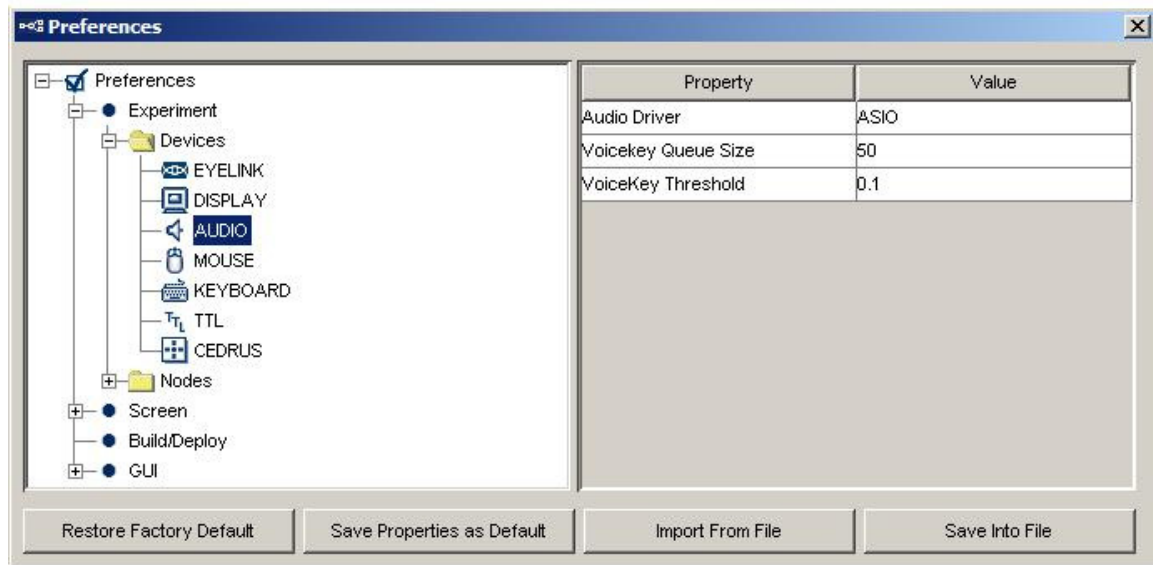

Audio Driver (.driver): The user has two audio drivers to choose from: DirectX or ASIO. If using the ASIO, the user must have ASIO driver and an ASIO-compatible sound card installed.

Output Interval # (.outputInterval): The interval (in milliseconds) between ASIO buffer swaps, which determines how often new sounds can be output.

ASIO Audio driver # (.driverName): The name of the ASIO driver.

Minimum Output Latency # (.minimumOutputLatency): The minimum output latency of the ASIO driver (delay from buffer switch to first sample output).

Voicekey Queue size (.voicekeyQueueSize): Sets the maximum number of voicekey events that can be cached in the voicekey event queue.

Voicekey Event Count # (.voicekeyEventCount): Returns total number of voicekey events cached in the event queue.

Voicekey Threshold (.voicekeyThreshold): Value from 0.0 to 1.0 to set voicekey trigger level, with 1.0 being the maximum audio level. The threshold should be set high enough to reject noise and prevent false triggering, but low enough to trigger quickly on speech. A threshold of 0.05 to 0.10 is typical.

17.1.4 TTL

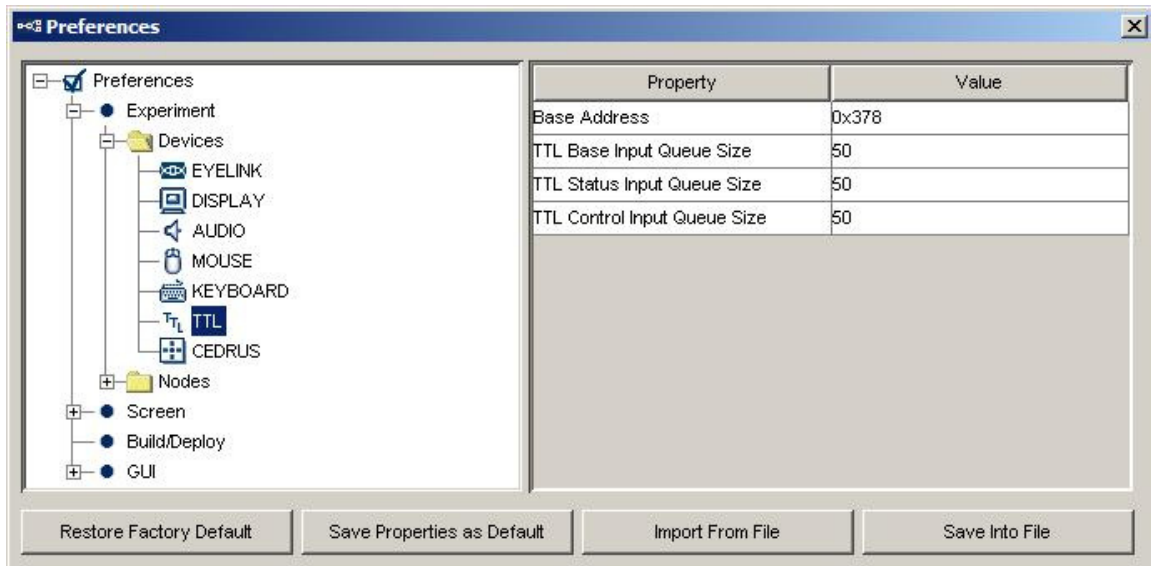

Base Address (.baseAddress): The address of data port or data register for outputting data on the parallel port's data lines. LPT1 is normally assigned base address 0x378, while LPT2 is assigned 0x278. Note this field expects a hexadecimal number (so the user should put in 0x378 instead of 378).

TTL Base Input Queue Size (.TTLBaseInputQueueSize): Sets the maximum number of TTL input events at the base register that can be cached in the event queue.

TTL Status Input Queue Size (.TTLStatusInputQueueSize): Sets the maximum number of TTL input events at the status register that can be cached in the event queue.

TTL Control Input Queue Size (.TTLControlInputQueueSize): Sets the maximum number of TTL input events at the control register that can be cached in the event queue.

TTL Base Event Count # (.TTLBaseEventCount): Total number of TTL input events at the base register cached in the event queue.

TTL Status Event Count # (.TTLStatusEventCount): Total number of TTL input events at the status register cached in the event queue.

TTL Control Event Count # (.TTLControlEventCount): Total number of TTL input events at the control register cached in the event queue.

17.1.5 Cedrus

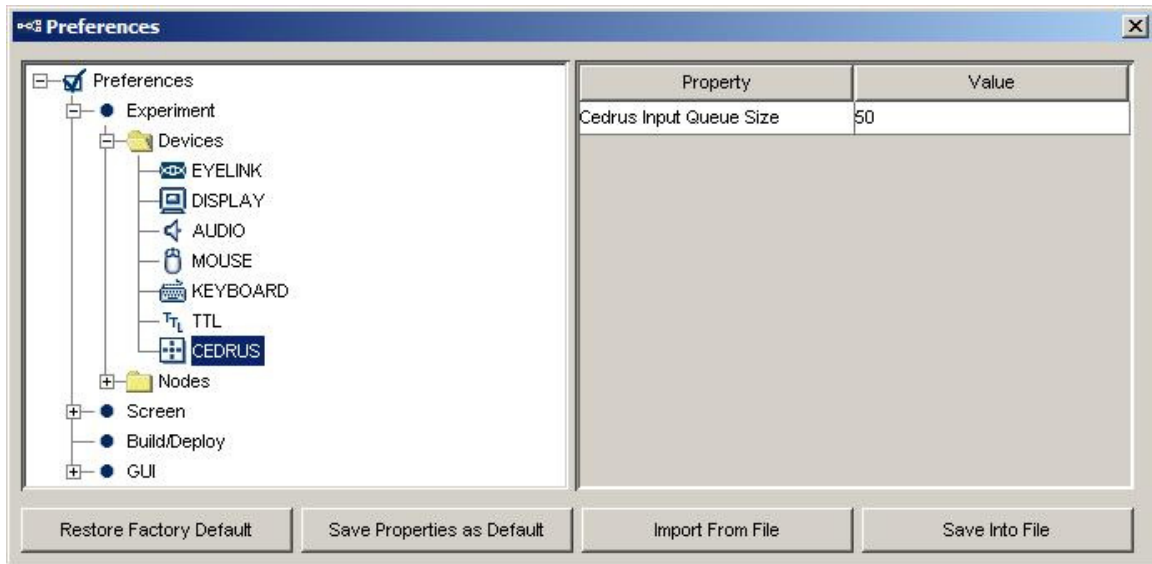

Debounce Time: Sets the Cedrus button debounce time in milliseconds. Button responds immediately to the first change. Any change in button status following this is ignored for the amount of time set in this field.

17.1.6 Keyboard

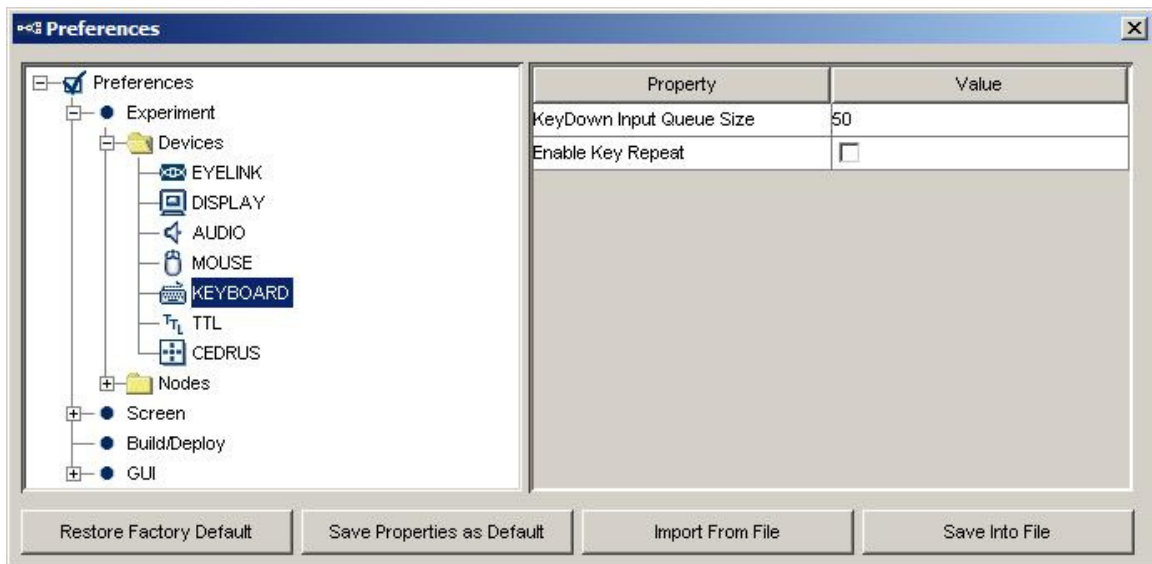

KeyDown Input Queue Size (.keyDownInputQueueSize): Sets the maximum number of key press events that can be cached in the key press event queue.

Key Down Event Count # (.keyDownEventCount): Total number of key press events cached in the key press event queue.

Enable Key Repeat: If this is enabled, supports repeated key inputs when you hold down a key.

Repeat Delay (.repeatDelay): Adjust the amount of time that elapses before characters repeat when you hold down a key.

Repeat Interval (.repeatInterval): Adjust how quickly characters repeat when you hold down a key.

17.1.7 Mouse

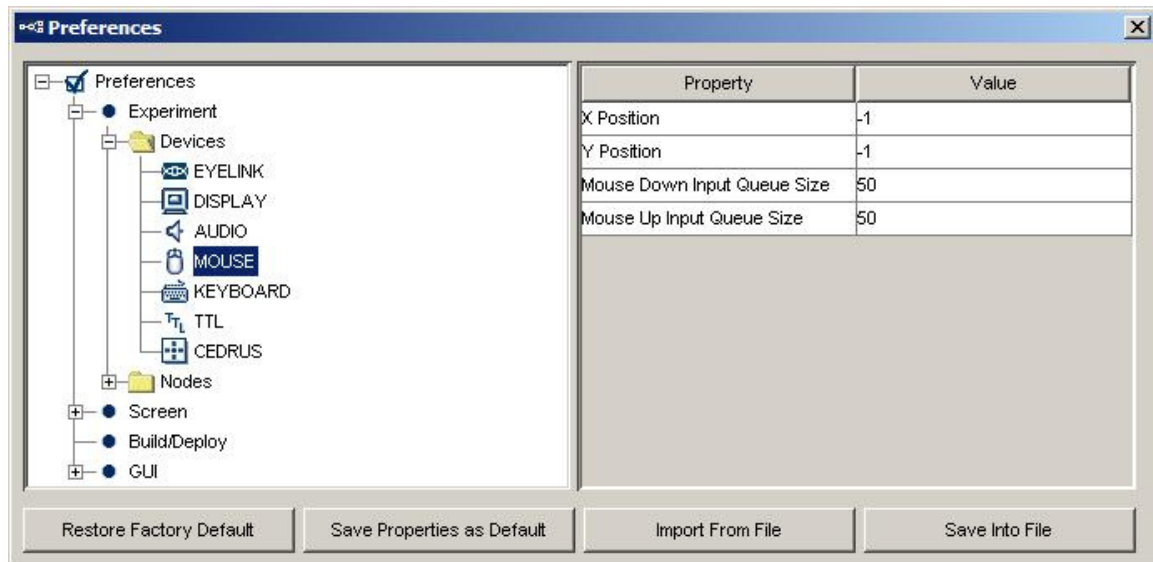

X Position (.xPosition): Default X position of the mouse device.

Y Position (.yPosition): Default Y position of the mouse device.

Mouse Down Input Queue size (.mouseDownInputQueueSize): Sets the maximum number of mouse press events that can be cached in the mouse press event queue.

Mouse Up Input Queue Size (.mouseUpInputQueueSize): Sets the maximum number of mouse release events that can be cached in the mouse release event queue.

Mouse Down Event Count # (.mouseDownEventCount): Total number of mouse press events cached in the mouse press event queue.

Mouse Up Event Count # (.mouseUpEventCount): Total number of mouse release events cached in the mouse release event queue.

17.1.8 Timer

See section 7.10.1 “Timer Trigger”.

17.1.9 Invisible Boundary

See section 7.10.2 “Invisible Boundary Trigger”.

17.1.10 Conditional

See section 7.10.3 “Conditional Trigger”.

17.1.11 EyeLink© Button

See section 7.10.4 “EyeLink© Button Trigger”.

17.1.12 Cedrus Input

See section 7.10.5 “Cedrus© Button Trigger”.

17.1.13 Mouse

See section 7.10.7 “Mouse Trigger”.

17.1.14 Fixation

See section 7.10.9 “Fixation Trigger”.

17.1.15 Saccade

See section 7.10.10 “Saccade Trigger”.

17.1.16 Sample Velocity

See section 7.10.11 “Sample Velocity Trigger”.

17.1.17 Display Screen

See section 7.9.1 “Display Screen”.

17.1.18 Drift Correct

See section 7.9.2 “Performing Drift Correction”.

17.1.19 Camera Setup

See section 7.9.3 “Performing Camera Setup and Calibration”.

17.1.20 Send EyeLink© Message

See section 7.9.4 “Sending EyeLink© Message”.

17.1.21 Send Command

See section 7.9.5 “Sending EyeLink© Command”.

17.1.22 Add to Experiment Log

See section 7.9.7 “Adding to Experiment Log”.

17.1.23 Add to Accumulator

See section 7.9.9 “Adding to Accumulator”.

17.1.24 Prepare Sequence

See section 7.9.11 “Preparing Sequence”.

17.1.25 Play Sound

See section 7.9.13 “Playing Sound”.

17.1.26 Sequence

See section 7.7 “Sequence/Subgraph”.

17.1.27 Set TTL

See section 7.9.6 “Sending TTL Signal”.

17.1.28 Accumulator

See section 7.11.3 “Accumulator”.

17.1.29 Result File

See section 7.11.2 “Result File”.

17.2 Screen

17.2.1 Screen

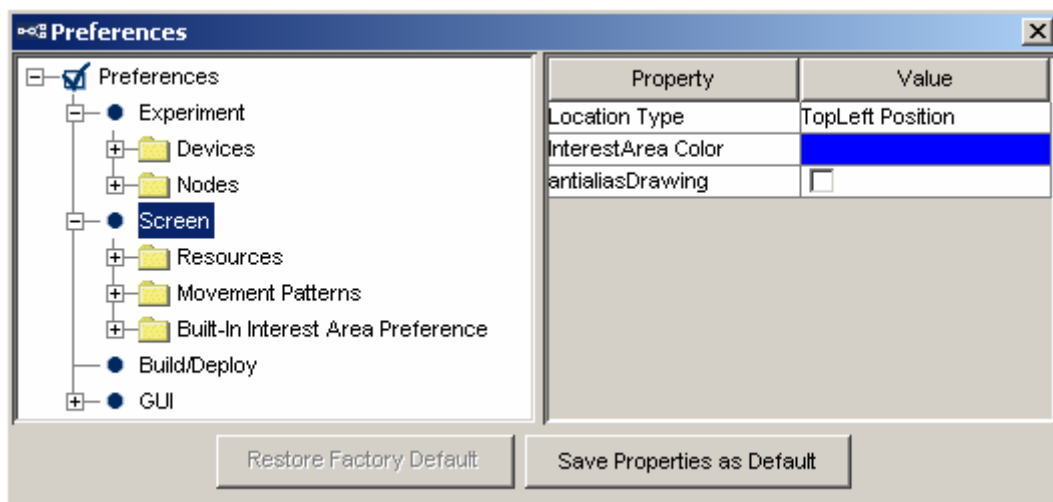

Location Type: For all resources on the screen builder, whether the default location in the settings refers to the top-left corner or center of a resource.

Interest Area Color: Color used to draw the border of interest areas.

Anti-aliasing Drawing: Anti-aliasing is the process of blurring sharp edges in text or line drawings to get rid of the jagged edges on lines. If this preference is set to true, anti-aliasing is applied to resources to make screen drawings appear smoother. To achieve best anti-aliasing result, make sure that the transparency color (Preferences -> Experiment -> Devices -> Display -> “Transparency Color”) is set to close but not

identical to the background color of the display (Preferences -> Experiment -> Nodes -> Action -> Display Screen -> “Background Color”).

17.2.2 Image Resource

See section 8.1.1 “Image Resource”.

17.2.3 Video Resource

See section 8.1.2 “Video Resource”.

17.2.4 Text Resource

See section 8.1.3 “Text Resource”.

17.2.5 Multiline Text Resource

See section 8.1.4 “Multiline Text Resource”.

17.2.6 Line Resource

See section 8.1.5 “Line Resource”.

17.2.7 Rectangle Resource

See section 8.1.6 “Rectangle Resource”.

17.2.8 Ellipse Resource

See section 8.1.7 “Ellipse Resource”.

17.2.9 Triangle Resource

See section 8.1.8 “Triangle Resource”.

17.2.10 Freeform Resource

See section 8.1.9 “Freeform Resource”.

17.2.11 Sine Pattern

See section 8.2.1 “Sinusoidal Movement Pattern”.

17.2.12 Grid Segmentation

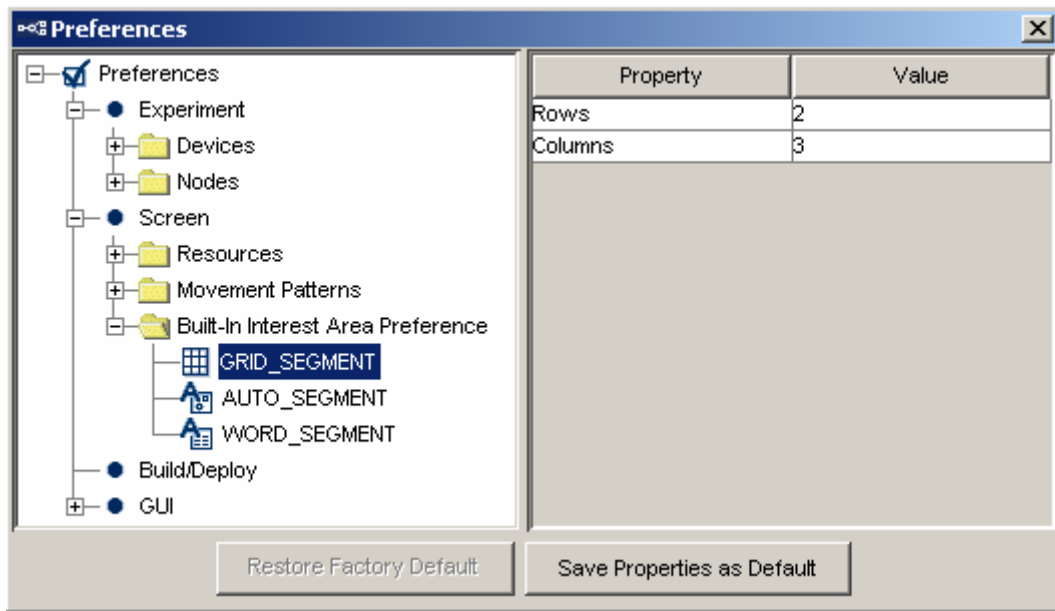

Grid segmentation will divide the whole screen into evenly spaced [Rows] × [Columns] interest areas.

Rows: Number of rows used to create grid segment.

Columns: Number of columns used to create grid segment.

17.2.13 Auto Segmentation

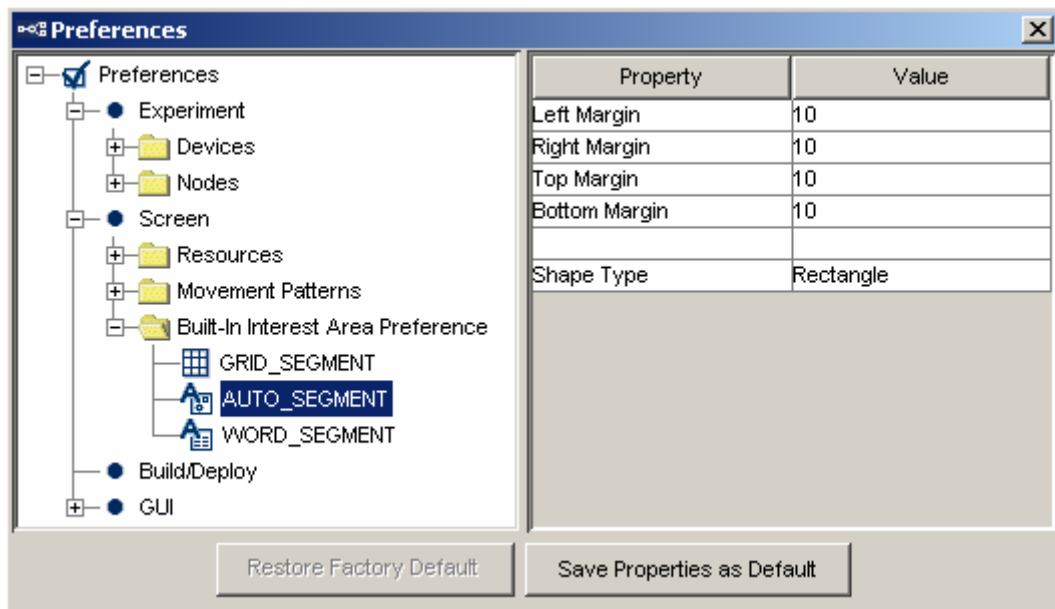

Auto segmentation will create a rectangular or elliptic interest area to contain each of the individual resources created on the display screen.

Left Margin, Right Margin, Top Margin, and Bottom Margin: Number of pixels added to the left, top, right, and bottom of the interest area that bounds the resource.

Shape Type: The type of interest area to be created (either rectangular or elliptic type).

17.2.14 Word Segmentation

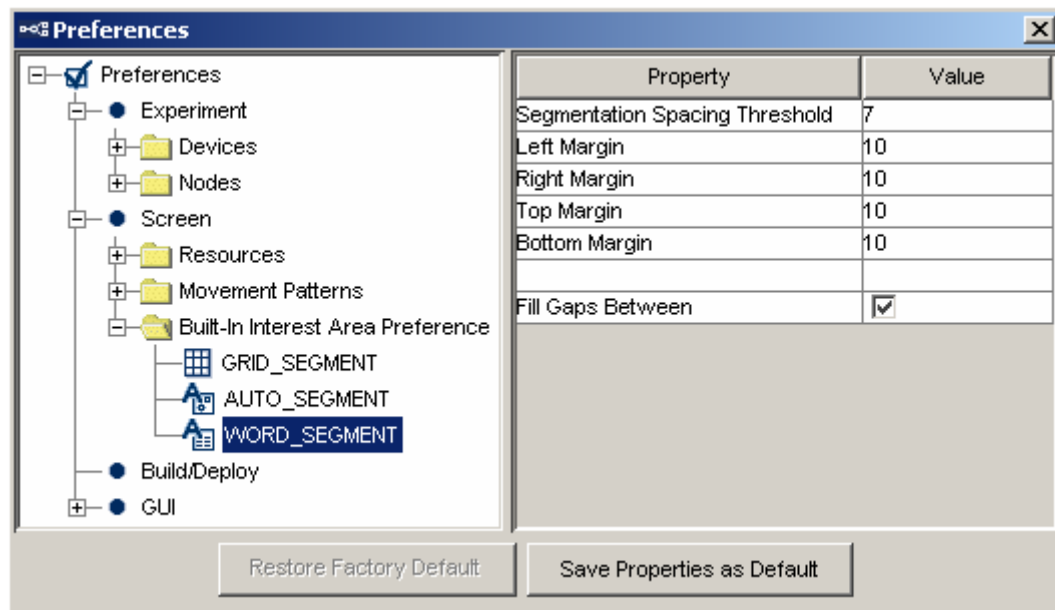

Word segmentation will create a rectangular interest area to contain each of the word in a text or multiline text resource.

Segmentation Spacing Threshold: Number of consecutive pixels below threshold before segment end is identified.

Left Margin, Right Margin, Top Margin, and Bottom Margin: Number of pixels added to the left, top, right, and bottom of the interest area. Note that the *Top Margin* and *Bottom Margin* fields will not have an effect if *Fill Gaps Between* is checked.

Left Margin: Number of pixels added to the left of the interest area.

Right Margin: Number of pixels added to the right of the interest area.

Top Margin: Number of pixels added to the top of the interest area. Note that this field will not have an effect if *Fill Gaps Between* is checked.

Bottom Margin: Number of pixels added to the bottom of the interest area. Note that this field will not have an effect if *Fill Gaps Between* is checked.

Fill Gaps Between: If checked, gaps between consecutive Interest Areas will be filled by expanding the size of each Interest Area.

Enable Interest Area Delimiter: Whether a special delimiter character (instead of the commonly used space) should be used to mark the boundary between segments.

Delimiter Character: Specify the delimiter character (one single character only) used to separate segments.

Enable Interest Area Delimiter Replacement: Whether the delimiter character should be replaced by another character. Please note that the delimiter characters are used to separate string tokens and will not be displayed in the text or multiline text resource. Therefore, if you use space as the delimiter character, you will need to enable the delimiter replacement option and set space as the replacement character.

Delimiter Replacement Character: One single character that is used to replace the delimiter character.

Segmentation Direction: Direction ("Left to Right, Top to Bottom", "Left to Right, Bottom to Top", "Right to Left, Top to Bottom", and "Right to Left, Bottom to Top") in which the text is segmented. Interest areas are numbered consecutively based on the order they are created.

17.3 Build/Deploy

This section lists preference settings that are related to the building and deploying processes.

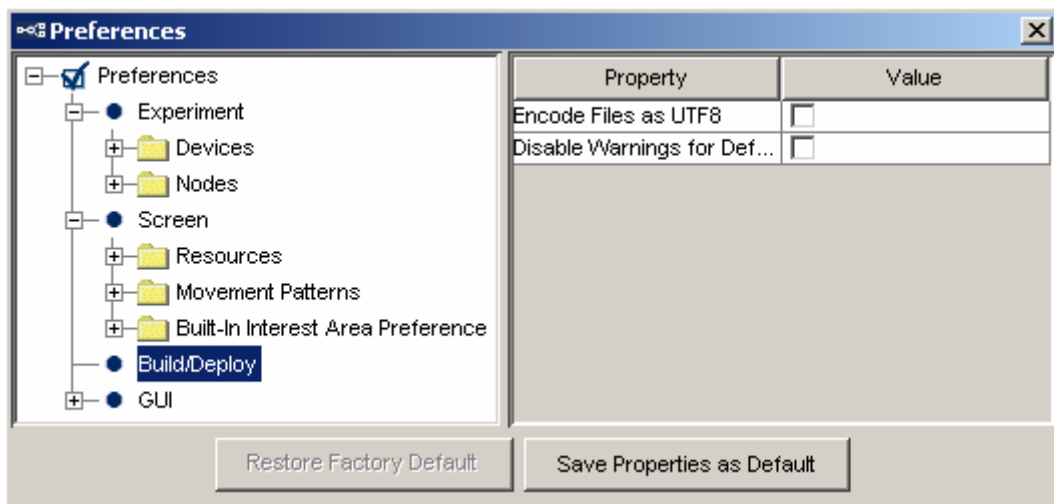

Encode Files as UTF-8: If enabled, the generated experiment code and dataset files are written using UTF-8 encoded (<http://en.wikipedia.org/wiki/UTF-8>) files. This is a must if the user is using a character that does not fit in the ASCII encoding range (1-127). In simple terms, this should be enabled if anyone is using characters that are non-English (e.g., à, è, ù, ç) or even special curved quotes, and obviously any non-European language characters.

Disable warning to default: If unchecked, this will raise a warning whenever a default value is used and if particular property calls for warning. If checked, such warnings are not brought up. For example, in the Timer trigger, the duration calls for a warning whenever a default value is used. The raised warning can be disabled by having this box checked.

Disable Equation Check: A warning message will be given if the value and attribute of an equation are of different data type. Checking this option will hide the type mismatch warning.

External Libraries: Put directory paths here if you will need to use other Python packages in custom code.

Test Run Command Line Arguments: If the deployed experiment runs from the command prompt, additional parameters can be passed to the program. The parameter can be retrieved as ".cmdargs" of the topmost experiment node. Use this preference to set parameters for test run purpose.

Include Packed Project in Deploy Directory: If checked, a copy of the packed experiment project will be included in the "source" folder of the deployed directory; otherwise, only the graph.ebd and preferences.properties files will be included for reconstructing the original project if necessary.

Verbose: If checked, a detailed printout will be shown in the EB output tab when deploying a project.

17.4 GUI

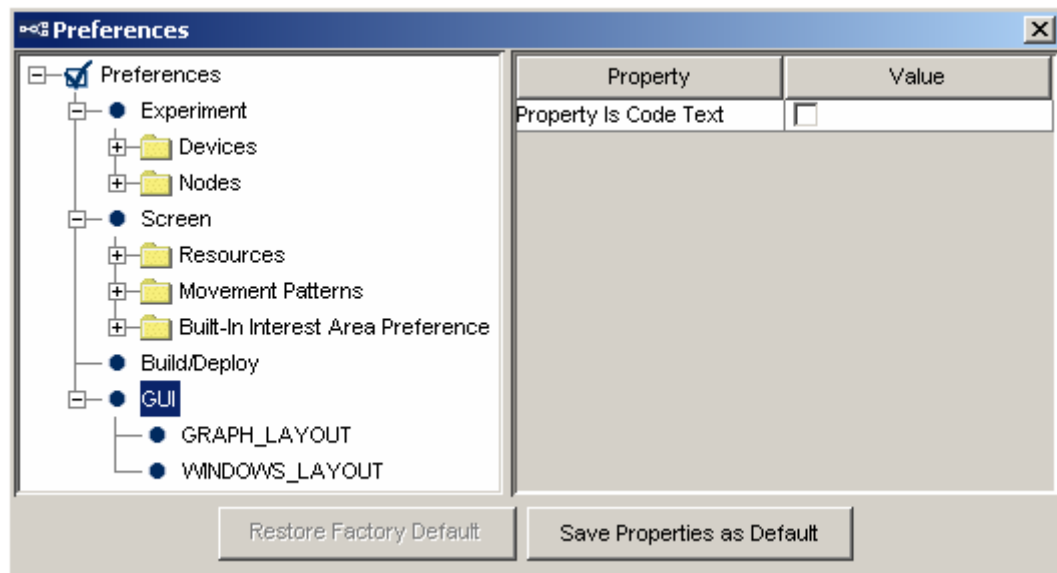

Property is Code Text: Sets the format of labels in the property table. If disabled, the label of the properties will be formatted and/or translated (for internationalization) so that it is understood easily. If enabled, an internal label will be displayed (for ease of references) and no internationalization or formatting will be done.

Show Tooltip: If enabled, a description text will appear beside the item on which the mouse cursor is placed.

17.4.1 Graph_Layout

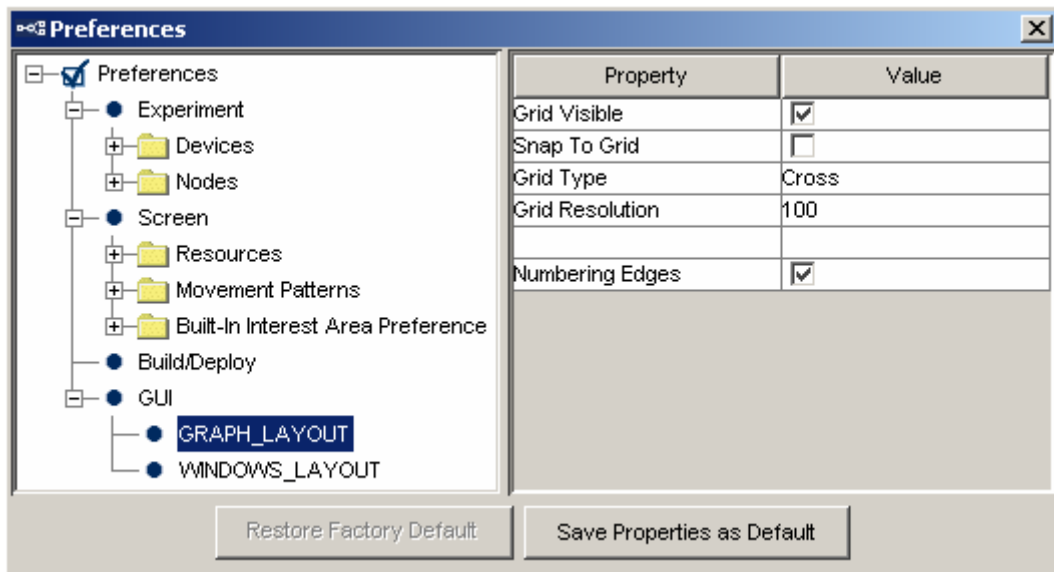

Grid Visible: Whether the grids should be visible in the workspace in the non-screen builder graphs.

Snap to Grid: If checked, this will align the items of the graph to the closest intersection of grids.

Grid Type: The grid can be formed by lines, cross, or points.

Grid Resolution: This draws a grid every 100 pixels.

Numbering Edges: If checked, adds a number to each of the connection between a node and multiple triggers that connect from the node to indicate evaluation priority among the triggers.

Remember Zoom Level: If checked, the current zoom level will be saved and remembered when the project is re-opened later.

17.4.2 CustomClass_Editor

Font Name: Name of the font the custom class editor used to show custom class code.

Font Size: Size of the font the custom class editor used to show code.

Highlight Color Enable: If enabled, the current editing line will be highlighted.

Highlight Color: Color used to highlight the current editing line.