

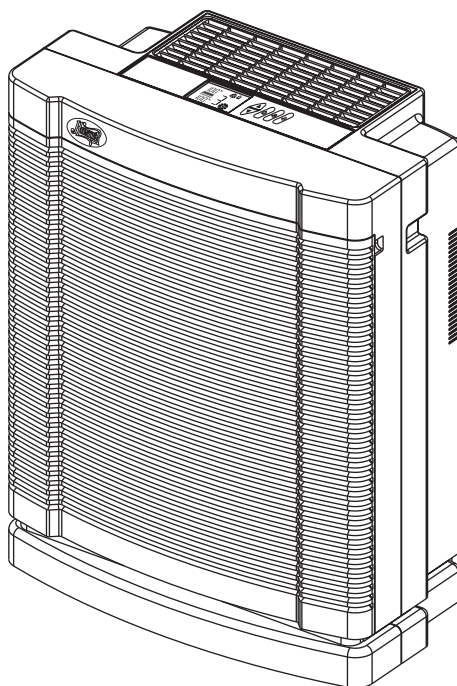

HEPAtech[®]

Air Purification System







Models 30378 & 30379

Replacement Filter Information

<u>Model</u>	<u>Pre-Filter</u>	<u>HEPAtech[®] Filter</u>
30378	30901	30931
30379	30901	30931

www.hunterfan.com

Table of Contents

Safety Instructions	3
Introduction	3
 Description of Air Filtration System	
How the Air Purifier Works	4
Air Purifier Components	4
Display and Control Keys	5
 Operation	
Initial Operation	6
Filter Life Counters	7
Locking/Unlocking the Keypad	7
Resetting the Air Purifier	8
Using the Ionizer	8
 Air Purifier Maintenance	
Cleaning Your Air Purifier	9
Changing the Pre-Filter	9
Changing the Filter	10
Obtaining Replacement Filters	11
 Troubleshooting	
Problem and Solutions	12
Technical Support	12
 Warranty Information	13

SAFETY INSTRUCTIONS

IMPORTANT!

READ ALL INSTRUCTIONS BEFORE USING THIS AIR PURIFIER.

1. This air purifier is designed for use on a flat level floor and may not work properly on an uneven floor. **ALWAYS** place the air purifier on a firm level floor. **ALWAYS** place the air purifier at least six (6) inches away from walls and heat sources such as stoves, radiators, or heaters.
2. Place the air purifier in an area that is out of the reach of children.
3. Before using the air purifier, extend the cord and inspect for any signs of damage. **DO NOT** use the product if the cord has been damaged.
4. This product has a polarized plug (one blade is wider than the other) as a safety feature. This plug will fit into a polarized outlet only one way. If the plug does not fit fully into the outlet, reverse the plug. If the plug still does not fit, contact a qualified electrician. **DO NOT** attempt to defeat or override this safety feature.
5. **ALWAYS UNPLUG** the air purifier while it is being cleaned.
6. **DO NOT** move or tilt the air purifier while it is in operation. Turn off and unplug before moving.
7. **DO NOT** immerse the air purifier in water at any time because permanent damage will occur. To properly clean your air purifier, follow the instructions in the Maintenance section of this manual (pg. 9).

READ AND SAVE ALL INSTRUCTIONS.

Introduction

Thank you for purchasing the **HEPAtech**[®] Air Purification System from Hunter Fan Company. You have purchased our latest development in portable air purification which has been designed to improve the quality of the air that you breathe. The following innovative features are included in your Hunter Air Purifier.

- **High Particulate Efficiency:** The **HEPAtech**[®] filter will remove 99.97% of 0.1 micron particles from the air that passes through the filter.
- **Odor Removal:** The activated carbon pre-filter helps remove odors such as cooking, smoke, and pet smells from the air. It also traps lint, hair, and other large particles to help extend the life and performance of the **HEPAtech**[®] filter.
- **Ionizer:** The ionizer improves the quality of air in the room by releasing negative ions into the air that attract positively charged dust, smoke, and pollen particles.
- **Quiet:** The air purifier has been designed to operate quietly and efficiently. You can choose among three speeds to best meet your needs at different times.
- **Filter Counters:** Filter maintenance is critical to the performance of the air purifier. To help you determine when to change the filters, the pre-filter and **HEPAtech**[®] filter, the unit has built in life counters that keep track of the life remaining of each filter.



Description of Air Filtration System

How the *HEPAtech*[®] Air Purification System Works

As the air is pulled into the purifier, the activated carbon pre-filter absorbs odors and catches large particles. Then, the air travels through the *HEPAtech*[®] filter where the smaller particles are collected. Then, the ionizer releases negative ions into the air that attract positively charged dust, smoke, and pollen particles. Finally, the clean, purified air is released back into the room.

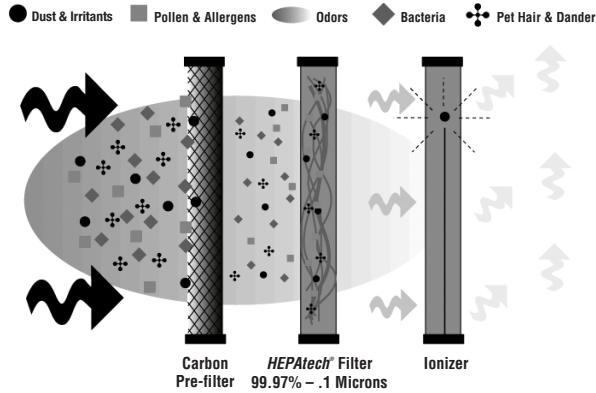

Fig. 1 - Illustration of the Air Filtration System

Air Purifier Components

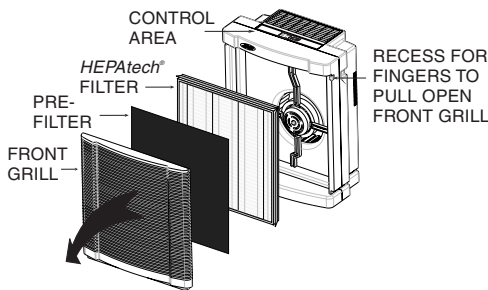

Fig. 2 - Air Purifier Components

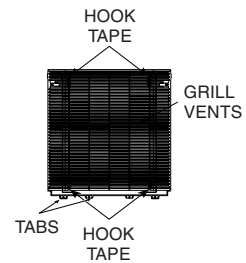

Fig. 3 - Inside Surface of Front Grill

Description of Air Filtration System



Display and Control Keys

The display and control keys allow for easy operation of the air purifier.



UP/DOWN KEYS: Adjusts the blower speed and turns the unit on and off.



PRE-FILTER RESET: Resets the Carbon Pre-Filter Life Counter.



FILTER RESET: Resets the *HEPAtech*® Filter Life Counter.



IONIZER KEY: Turns the ionizer on and off.

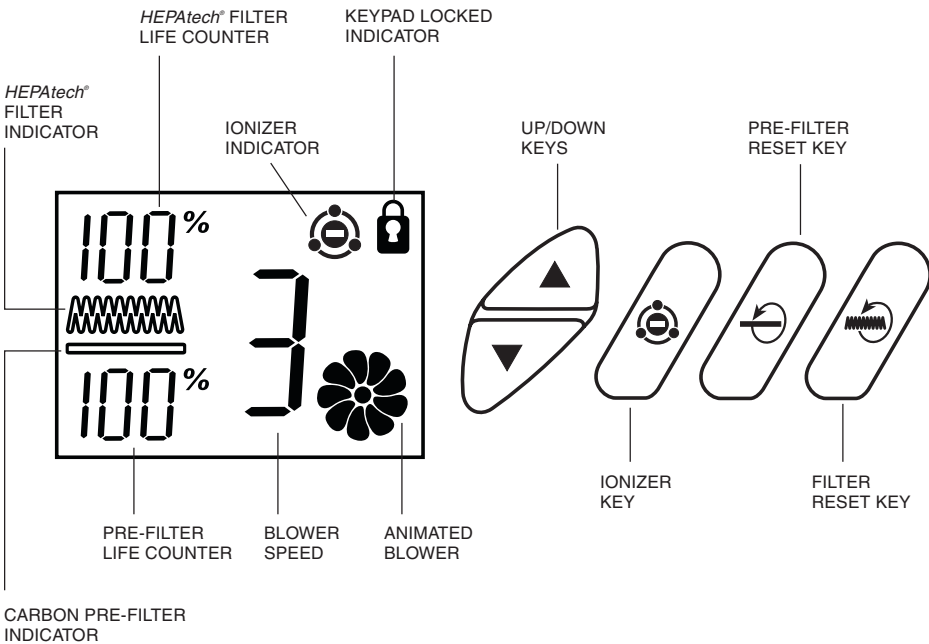

Fig. 4 - Air Purifier Alpha-numeric Display and Control Area



Operation

Initial Operation

This section provides basic instructions on the use of your air purifier. After following these initial directions, please continue reading this booklet to learn how to operate the more advanced features of your air purifier.

Basic Operation of the Air Purifier:

1. Take the air purifier out of the box and remove the clear plastic protective bag. Place the unit on a firm level floor.
2. Before turning on the air purifier, you need to confirm that the filters are firmly in place and have not become loose during shipping. To check the filters, first open the front grill. Release the front grill by placing your fingers behind the tabs and pulling forward. Refer to Figs. 2 and 3 (pg. 4).
3. Next, check the *HEPAtech*[®] filter by pressing firmly on all four corners of the filter to ensure that it is fully inserted into the filter opening.
4. The carbon pre-filter is mounted inside the front grill with hook tape. Confirm that it properly covers the grill vents. You may notice a few black particles coming off the pre-filter. Those particles are part of the odor-removing activated carbon and will be collected on the filter during use.
5. Place the front grill back onto the unit. First, line up the tabs on the bottom of the grill with the openings on the purifier base and then push the top of the grill forward until it is closed. Refer to Figs. 2 and 3 (pg. 4). **NOTE:** This unit will not operate unless the grill is in the correct position.



6. Plug the unit into a 120V electrical outlet and press the UP key. The air purifier will start with a low blower speed.



7. Use the UP/DOWN keys to adjust the blower speed to the desired level (0 = Off, 1 = Low, 2 = Medium, 3 = High). Refer to Fig. 5.

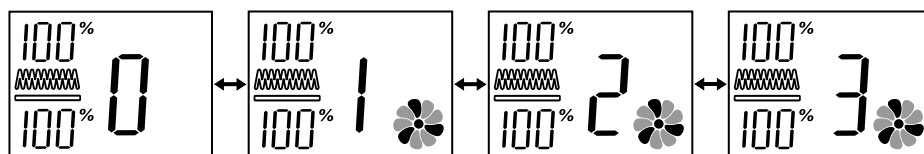

Fig. 5



Filter Life Counters

The pre-filter and filter are critical to the proper operation of the air purifier. To help you know when to change the filters, your Hunter Air Purifier has Filter Life Counters that will monitor the percentage of life your filter has left. Although the exact life of the filters depends on the environment, the table below gives typical usage times of the filters.

Table 2: Typical Usage Times of the Filters

Filter Type	Typical Usage
Activated Carbon Pre-Filter	1400 hours
HEPAtech® Filter	2800 hours

The display shows the percentage of life left since the counter was reset. **NOTE:** The percentage level drops in 5% increments.

The values of the Pre-Filter and Filter Life Counters are stored in the air purifier's memory. **The unit may be unplugged and moved or stored without losing the Pre-Filter and Filter Counter values.**

To properly track filter usage, the Pre-Filter and Filter Life Counters should be reset each time the filters are changed. Refer to Changing the Pre-Filter (pg. 9) or Changing the Filter (pg. 10) for instructions on how to reset the counters.

Locking/Unlocking the Keypad

Once you enter the desired speed, you may want to lock the keypad to prevent accidental changing of the speed. When the keypad is locked, all keys will be disabled. If you press a key, the Keypad Locked Indicator will be displayed on the screen for 1-2 seconds.

To Lock or Unlock the Keypad:



1. To lock the keypad, press and hold the UP/DOWN keys simultaneously for 2-3 seconds. The Keypad Locked Indicator will appear on the display. Refer to Fig. 6. After releasing the keys, the Keypad Locked Indicator will disappear.
2. To unlock the key pad, press and hold the UP/DOWN keys simultaneously for 2-3 seconds. The Keypad Indicator will disappear and the keypad will be functional.

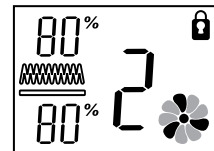

Fig. 6



Operation

Resetting the Air Purifier

In the unusual situation that the unit or the display is exhibiting erratic behavior, you may want to reset the air purifier. If you still have problems after resetting the air purifier, please contact Hunter for additional assistance (refer to Technical Assistance, pg. 12).

To Reset the Air Purifier:

1. Unplug the unit for at least 30 seconds.
2. Plug the unit back in.

Using the Ionizer

Using the ionizer improves the quality of air in the room. Negative ions are released into the air and positively charged dust, smoke, and pollen particles are attracted to the negative ions. These particles settle out of the air and can be vacuumed up during normal cleaning. These particles are also more easily captured by the *HEPAtech*[®] filter as they pass through the *HEPAtech*[®] Air Purification System. To ensure the best air circulation in the room, we recommend that you place your air purifier six (6) inches away from any walls.

To turn the ionizer on or off:



1. To turn the ionizer on, press the IONIZER key. The Ionizer Indicator will appear on the display. Refer to Fig 7.
2. To turn the ionizer off, press the IONIZER key. The Ionizer Indicator will disappear.

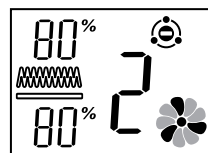

Fig. 7

Air Purifier Maintenance



Cleaning Your Air Purifier

Proper maintenance of your Hunter Air Purifier will help ensure years of trouble free service.

Follow these steps to properly maintain your air purifier:

1. Approximately every 90 days, the outside of the unit should be cleaned with a soft, damp cloth.
2. If needed, the front grill can be removed from the unit and cleaned with soapy water. Simply remove the pre-filter before exposing the grill to water.
3. Follow the instructions in Changing the Pre-Filter and Changing the Filter (pgs. 9 and 10) to determine when and how to replace the filters.

NOTES:

- The air purifier must be unplugged during the cleaning process.
- Be sure the unit is completely dry before plugging in and using.
- Never immerse unit in water.

Changing the Pre-Filter

When the Pre-Filter exceeds 1400 hours (refer to Filter Life Counters for additional information, pg. 7), the Pre-Filter Life Counter will display 0% life remaining and the Pre-Filter indicator will flash as a reminder that you should replace the pre-filter. To maintain proper odor-removing capability and overall filtration performance, the pre-filter should be changed every 1400 hours (approximately 3 months of use). If necessary, the pre-filter can be changed more often. Proper maintenance of the pre-filter will help extend the life of the *HEPAtech*[®] filter. Refer to Obtaining Replacement Filters (pg. 11) if you need help finding replacement filters.

To change the pre-filter and reset the Pre-Filter Life Counter:

1. First, turn off and unplug the air purifier.
2. Next, remove the front grill. Place your fingers in the recesses on either side of the top of the grill and pull firmly. Refer to Figs. 2 and 3 (pg. 4).
3. The pre-filter is attached to the inside of the grill with hook tape. Pull gently on the pre-filter to remove it. Refer to Fig. 3 (pg. 4).
4. If needed, use a soft damp cloth to wipe off the grill.
5. Install the new pre-filter by placing it in the grill and pressing gently on the pre-filter so that it adheres to the hook tape. You may notice a few black particles coming off the pre-filter. Those particles are part of the odor-removing activated carbon and will be collected on the filter during regular use.

Continued



Air Purifier Maintenance

6. Place the front grill back onto the unit. First, line up the tabs on the bottom of the grill with the openings on the purifier base and then push the top of the grill forward until it is closed. Refer to Figs. 2 and 3 (pg. 4). **NOTE:** This unit will not operate unless the grill is in the correct position.
7. Plug in the air purifier.



8. Finally, reset the Pre-Filter Counter by pressing the PRE-FILTER RESET key for 2 seconds. The Pre-Filter Counter will return to 100% and the Pre-Filter indicator will stop flashing.

Changing the Filter

When the filter exceeds 2800 hours (approximately 4 to 6 months of use), the Filter Life Counter will display 0% life remaining and the Filter indicator will flash (refer to Filter Life Counters for additional information, pg. 7). This is a reminder that you should check the filter and replace if necessary. The proper time to change the filter depends on usage and the environment. Use the following list to help determine if the filter should be changed:

- Compare the color of the filter to the color coded chart on the inside of the housing. If the filter color matches the darkest color on the chart, you should replace the filter.
- If you notice a decrease in air output or an increase in noise at any time during normal operation, the filter may be clogged. Replace the filter to return to normal operation.

To change the filter and reset the Filter Life Counter:

1. First, turn off and unplug the air purifier.
2. Next, remove the front grill. Place your fingers in the recesses on either side of the top of the grill and pull firmly. Refer to Figs. 2 and 3 (pg. 4).
3. Gently pull on the filter to remove it from the unit. While removing the filter, note the directional arrows printed on the top of the filter. The new filter will be installed with the same orientation. Once removed, the used filter can be discarded.
4. Remove the new filter from its wrapping and look at the directional arrows printed on the side of the filter. Install the filter with arrows pointing towards the unit. Press the filter firmly into the air purifier. To avoid damaging the filter media, you should press on the frame of the filter only.
5. Place the front grill back onto the unit. First, line up the tabs on the bottom of the grill with the openings on the purifier base and then push the top of the grill forward until it is closed. Refer to Figs. 2 and 3 (pg. 4). **NOTE:** This unit will not operate unless the grill is in the correct position.

Air Purifier Maintenance



6. Plug in the unit.



7. To reset the filter counter, press the FILTER RESET key for 2 seconds. The Filter Counter will return to 100% and the Filter indicator will stop flashing.

Obtaining Replacement Filters

To obtain replacement filters for your air purifier, first determine your model number by looking at the information label on the back of the air purifier. The model number will be listed on the label. Then, call 1-800-4HUNTER for your nearest retailer or Hunter Customer Service at 1-800-313-3326 (CAN 1-888-855-8300) to order directly. To order online, visit our Website at www.hunterfan.com. To ensure that you obtain the correct filters, please find your model number below that specifies the correct replacement filters.

Hunter Air Purifier Model No.:	30378	30379
Pre-Filter Replacement Model No.:	30901	30901
HEPAtech® Filter Replacement Model No.:	30931	30931



Troubleshooting

Problem	Solutions
1. No display or operation.	<ul style="list-style-type: none">• Confirm that the unit is plugged in.• Check the installation of the front grill.• Reset the air purifier. (See Resetting the Air Purifier on pg. 8.)
2. Keypad does not work.	<ul style="list-style-type: none">• Key pad has been locked to prevent accidental changes to the programs. (See Keypad Lock on pg. 7 to unlock the key pad.)
3. Erratic Display or Operation.	<ul style="list-style-type: none">• Reset the air purifier. (See Resetting the Air Purifier on pg. 8.)
4. Filter and/or Pre-filter Indicator is Flashing.	<ul style="list-style-type: none">• The Filter and/or Pre-Filter Life Counters have reached the estimated usage times. Check and replace filters if needed. (Refer to Filter and Pre-Filter Counters on pg. 7.)
5. <i>HEPAtech</i> ® Filter and/or Carbon Pre-Filter Life Counter is flashing 0%.	<ul style="list-style-type: none">• The Filter and/or Pre-Filter Life Counters have greatly exceeded the estimated usage times. Replace the corresponding filters.
6. Unit has reduced air flow or increased noise.	<ul style="list-style-type: none">• The filter is clogged and should be changed. (Refer to Changing the Filter on pg. 10.)

Technical Support

If you have any additional questions or problems with your Hunter air purifier, please call 1-888-830-1326 from 8:00 am to 5:00 pm Central Time or contact us over the Internet at www.hunterfan.com.



Hunter Fan Company **HEPAtech® Air Purification System** **5 YEAR LIMITED WARRANTY**

The Hunter Fan Company makes the following limited warranty to the original residential user or consumer purchaser of the **HEPAtech®** Air Purification System:

If any part of your **HEPAtech®** Air Purification System motor or control panel fails during the first five (5) years from the date of installation due to a defect in material or workmanship, we will provide a replacement Air Purifier free of charge. Installation is deemed to occur at the date of purchase.

If the Air Purifier cord or front grill fails any time within one (1) year after installation due to a defect in material or workmanship, we will replace or, at our option, repair the unit free of charge at our nearest service center or at our Service Department in Memphis, Tennessee. You will be responsible for all parts and labor costs after this one-year period.

USE OF A NON-HUNTER FILTER WILL INVALIDATE THIS WARRANTY. IF THE ORIGINAL RESIDENTIAL USER OR CONSUMER PURCHASER CEASES TO OWN THE AIR PURIFIER, THIS WARRANTY AND ANY IMPLIED WARRANTY WHICH THEN REMAINS IN EFFECT, INCLUDING BUT NOT LIMITED TO ANY IMPLIED WARRANTY OF MERCHANTABILITY OR FITNESS FOR A PARTICULAR PURPOSE, ARE VOIDED.

NO WARRANTY, EXPRESSED OR IMPLIED, INCLUDING ANY WARRANTY OF MERCHANTABILITY OR FITNESS FOR A PARTICULAR PURPOSE, IS MADE IN RESPECT TO THE FILTER MATERIAL OR CARBON FILTER.

THIS WARRANTY IS IN LIEU OF ALL OTHER EXPRESS WARRANTIES. THE DURATION OF ANY IMPLIED WARRANTY INCLUDING BUT NOT LIMITED TO ANY IMPLIED WARRANTY OF MERCHANTABILITY OR FITNESS FOR A PARTICULAR PURPOSE, IN RESPECT TO THE MOTOR IS EXPRESSLY LIMITED TO THE PERIOD OF THE EXPRESS WARRANTY SET FORTH ABOVE.

This warranty is voided if the air purifier is not purchased and used in the USA or Canada.

This warranty excludes and does not cover defects, malfunctions or failures of the Air Purifier which were caused by repairs by persons not authorized by us, use of parts or accessories not authorized by us, mishandling, modifications, or damage to the Air Purifier while in your possession, or unreasonable use, including failure to provide reasonable and necessary maintenance. This warranty does not cover Air Purifiers used in commercial applications. There are no express or implied warranties as to commercial purchasers or users.

To obtain service, contact the nearest Hunter authorized service center or the Hunter Fan Company Service Department, 2500 Frisco Avenue, Memphis, Tennessee 38114, 1-888-830-1326. For the name of our nearest authorized Hunter Fan Company Service Center, write to the Hunter Fan Company at the preceding address. You will be responsible for



Warranty

insurance and freight or other transportation to our factory service center. We will return the Air Purifier freight prepaid. The Air Purifier should be properly packaged to avoid damage in transit since we will not be responsible for any such damage. Proof of purchase is required when requesting warranty service. The purchaser must present sales receipt or other document that establishes proof of purchase.

IN NO EVENT SHALL HUNTER FAN COMPANY BE LIABLE FOR DIRECT, INDIRECT, SPECIAL CONSEQUENTIAL OR INCIDENTAL DAMAGES IN EXCESS OF THE PURCHASE PRICE OF THE AIR PURIFIER. YOUR SOLE REMEDY WILL BE REPAIR OR REPLACEMENT AS PROVIDED ABOVE.

SOME AMERICAN STATES AND CANADIAN PROVINCES DO NOT ALLOW:

- LIMITATIONS ON HOW LONG AN IMPLIED WARRANTY LASTS;
- THE EXCLUSION OR LIMITATION OF DIRECT, INDIRECT SPECIAL, INCIDENTAL OR CONSEQUENTIAL DAMAGES;

SO THE ABOVE LIMITATIONS MAY NOT APPLY TO YOU.

THIS WARRANTY GIVES YOU SPECIFIC LEGAL RIGHTS AND YOU MAY ALSO HAVE OTHER RIGHTS WHICH VARY FROM STATE TO STATE OR PROVINCE TO PROVINCE.



Other Home Comfort Products from Hunter

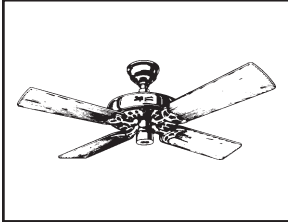

Hunter Original®
Fans

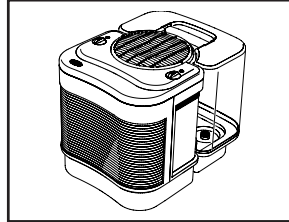

The Care-Free
Humidifier™

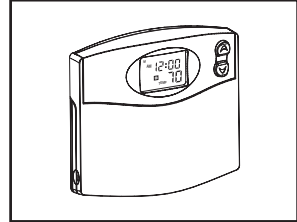

Programmable
Thermostat

To learn more about Hunter Fan Company products, please see our Web page at:

www.hunterfan.com



HUNTER FAN COMPANY
2500 FRISCO AVENUE
MEMPHIS, TN 38114, USA