

System bathroom

Cleaning Guide

LIXIL Corporation

Inquiries concerning product use, cleaning methods, etc. and about products

Customer Consultation Center

TEL ☎ 0120-1794-00

Hours Weekdays 9:00 to 18:00
Saturdays, Sundays, Holidays 9:00 to 17:00
(Excluding summer vacation and the year end/new year vacation)

FAX ☎ 0120-1794-30

* Toll-free numbers could not be available when using cell phones, PHS, and IP telephones.
Call the number below.
TEL 0562-40-4050 FAX 0562-40-4053

To request repairs (Please read the section in this manual "After-sales Service.")

Contact the shop where you purchased your product or
Contact INAX Maintenance Co., Ltd. Repair Reception Center

TEL ☎ 0120-1794-11

Hours 9:00 to 20:00
Requests for repair accepted 365 days a year

FAX ☎ 0120-1794-56

Home Page Address: <http://www.i-mate.co.jp>

LIXIL Co., Ltd. acquires personal information on customers and distributors upon delivery of our products. This information is used for purposes such as ongoing quality assurance and maintenance, as explained in the company's Privacy Policy. For more details on the handling and use of personal information, please refer to the Privacy Policy, which can be accessed from the LIXIL Co., Ltd. website.

Home Page Address: <http://www.lixil.co.jp/>

Dealer



In order to keep your system bathroom clean and comfortable, read this Cleaning Guide thoroughly and get a full understanding how to use the product properly and safely.

* If you do not clean the bathroom regularly, you might not be able to take full advantage of the product.

Please refer to the User's Manual for the following contents.

-Safety caution -Use method -Troubleshooting -Replacement Guide
-After-sales services and -Warranty certificate

Make sure to observe the cautions in this Cleaning Guide and the User's Manual. Please note that the company is not liable for accidents caused by improper cleaning or use.

* Keep this Cleaning Guide and the User's Manual in a place where they can be accessed easily when needed.

* If ownership of this product is transferred, pass this Cleaning Guide and the User's Manual on to the new owner.

Keep your bathroom comfortable with proper care

A bathroom is not just a place for cleaning your body. It also provides you space for family communication and enriches your relaxing time. Would we not like to keep such space always clean? This "Cleaning Guide" informs you of methods to keep your bathroom hygienic for your comfortable bath time.

Read this guide carefully for proper care.



Contents

Before Cleaning	
Cleaning Tips	3
Tools and Detergent to Prepare	5
Types of Grime and Cleaning Methods	7
Daily Cleaning	
Daily Cleaning Methods	9
Regular Cleaning	
Reference for Cleaning	11
Around the Bathtub	
① Bathtub	13
② Bath cover	13
③ Reheater port (circulation port)	14
④ Bathtub drain opening	15
Floor, Ceiling and Walls	
⑤ Floor	17
⑥ Ceiling	18
⑦ Walls	19
⑧ Floor drain trap	20
⑨ Beneath the bathtub	24
Around the Door	
⑩ Door	30
Accessories	
⑪ Mirror	36
⑫ Hand rail, slide bar and towel rod	37
⑬ Storage shelves and counter	37
Faucet	
⑭ Faucet	38
Light	
⑮ Light	41
Ventilation Fan and Heater	
⑯ Ventilation fan and heater	43

Troubleshooting	
Frequently Asked Questions	47
Request Repair under the Following Circumstances	49

Cleaning methods could vary depending on the product series. Check you product series on the front cover of the user's manual.

- System bathroom SOLEO
- System bathroom SOLEO 1822TAGG
- System bathroom Barrier-free bathroom 1116

Before Cleaning
Daily Cleaning
Regular Cleaning
Bathtub
Bath Cover
Reheater Port (Circulation Port)
Bathtub Drain Opening
Floor
Ceiling
Walls
Floor Drain Trap
Beneath the Bathtub
Door
Mirror
Hand Rail, Slide Bar and Towel Rod
Storage Shelves and Counter
Faucet
Light
Ventilation Fan and Heater
Troubleshooting

The following signs indicate important safety information. Make sure to observe the instructions.

<p>Signal Words</p> <ul style="list-style-type: none"> The degree of risk or damage resulting from improper use is classified and indicated by the following signal words. <p> Warning This indicates that improper handling of the product could cause death or severe injury.</p> <p> Caution This indicates that improper handling of the product could cause light injury or property damage.</p>	<p>Safety Alert Symbols</p> <ul style="list-style-type: none"> The following symbols classify and indicate items the user should observe. <p> Caution! This icon is used with the "Warning" and "Caution" on the left to urge caution. Make sure to read and follow the rules and instruction.</p> <p> Prohibited! This symbol is used for general prohibited actions.</p> <p> Do not disassemble!</p> <p> Do not touch the indicated area!</p> <p> Follow the instructions! This symbol indicates general instructions.</p>
---	---

* Please refer to the user's manuals of this product, faucet and ventilator/dehumidifier/heater. Please also read the instructions on the stickers on the product.*Please do not remove the stickers.

Make cleaning effective by "choosing the right cleaner and tools for the type and location of the grime", "cleaning the grime soon after confirming the type of the grime and cleaning method" and "combining daily and regular cleaning in a smart way".

A bathroom is susceptible to grime due to constituents of sebum, soap, tap water and mold. If you leave the dirt, it could adhere and become more difficult to remove. Follow the following instructions to keep your bathroom clean.

Preparation

Cleaning tools

Prepare cleaner and other tools for cleaning. Please note there are tools not to use to avoid damaging the bathroom.

Point
Choose cleaner and other tools depending on the type and location of the grime.



Type of grime and cleaning method

The cleaner and cleaning tools you need depend on the type of grime which varies. Some untreated grime could become impossible to remove.

Point
When you spot grime, read "type of grime and cleaning method" to check the appropriate cleaning method and clean it soon.



Cleaning Everyday and Regularly - Basics of Cleaning

It is important not to create adhering grime for efficient cleaning. Combine daily cleaning and regular cleaning effectively.

Daily cleaning

Remove the grime and the cause of the grime that accumulated on the day.

Point
Remove the grime (including sebum and soap) while the bathroom is still wet.



Regular cleaning

Regularly remove the grime that daily cleaning cannot remove.

To take full advantage of the drain trap, you need to clean it regularly. Make sure to clean it regularly.

Point
Refer to "cleaning guideline" (p.11, 12) to effectively plan cleaning based on the number of the time you take a bath and the conditions of the bathroom.



Moldy Bathroom

Let's learn about mold to prevent it.

Why does it get moldy?

Mold is a type of microbe called fungus. Mold needs warm temperature 20-30°C (68-86°F), humidity (70% or more) and nutrients (sebum, dirt, etc) to grow. A bathroom is susceptible to mold because it meets this condition.



To prevent mold

After taking a bath, wash it with shower (remove the nutrients) and cool the bathroom to a room temperature with cold shower. Then ventilate the bathroom by opening windows or turning on a ventilating fan (lower humidity).



If mold grew

Clean as usual except for the mold. When the bathroom is dry, do the following.

- 1 Wear rubber gloves, a mask, and an eye protector as necessary.
- 2 Close the bathroom door and open the window or turn on the ventilating fan.
- 3 Use a mold killing spray for the mold.
- 4 Leave it for awhile and then wash the spot with water.



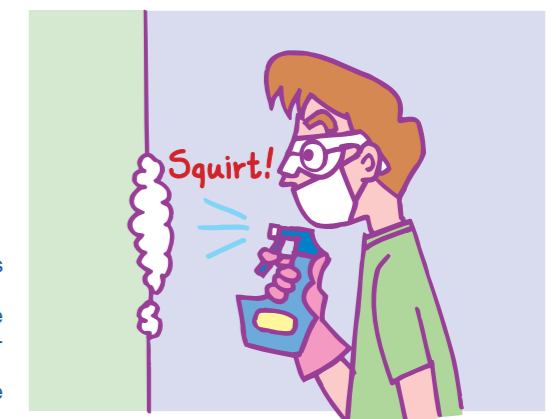









* When you use a mold killing or anti-mold agent, make sure to read the instructions for proper use.
* Do not leave the agent too long on the spot. Wash the agent completely. The trace of the agent could be the cause of discoloring, alteration, rust on metal or deteriorating rubber.
* You could not be able to take full advantage of the agent if there is grime on the mold or spot is wet.
* For the details of the mold and mold killing agents, refer to "Anti-mold and killing mold consociation website" (<http://www.kabikyo.gr.jp/top.html>).











Tools and Detergent to Prepare

Choose cleaners and tools that are best suited to the type and location of the grime.
Try the recommended useful products for easier cleaning.
Please note that cleaners and tools to avoid are also shown.

Equipment





	Type		Places used
 Sponge	A large, soft sponge is recommended. Useful product: melamine foam		Bathtub, bath cover, walls, tile floor, inside drain trap, mirror, storage shelves, counter, faucet, light cover
 Long-handled sponge	A long-handled sponge is useful when cleaning the ceiling.		Hard to reach places, such as the ceiling, walls, etc.
 Soft cloth	Dust-cloth, old T-shirt or towel, etc. Useful products: water wiper, absorbent towel for car washing		Hand rail, towel rod, storage shelves, counter, door, light cover, front cover for the ventilation fan/heater, remote control
 Toothbrush	Use a worn out toothbrush with spread out bristles.		Reheater port cover, bath cover, drain opening hair catcher, inside drain trap, faucet strainer, door lower frame track and hair catcher
 Bathroom brush	Use a split-end type fine brush with resin bristles.		Floor
 Rubber gloves	Wearing cotton gloves inside rubber gloves helps prevent skin roughness.		Beneath the bathtub, the ventilation fan body, when using a mold killing agent or other detergents

Cleaners

	Type	Cleaners(examples)	Notes
 Synthetic bathroom cleaner (neutral)	Mixture of chemicals designed specifically for use against bathroom grime. Useful product: スーパークリーナー万能Jrくん	 お風呂のルック (Lion),マジックリン 泡立ちスプレー (Kao)	* Leaving traces of cleaner could result in spotting or discoloration. * Dilute the detergent when using a condensed type.
 Bathroom cream cleanser	Creamy cleanser containing minute, abrasive particles	 クリームクレンザー ジフ・バスクリナー (Unilever), お風呂のルックみがき洗い (Lion)	* Do not apply excessive force when you clean the bathtub with a bathroom cream cleanser. Doing so could cause scratches or make the surface overly shiny.
 Mold killing agent	Removes mold through decomposition.	 カビキラー (Johnson), ルックヌメリ&カビ速攻バスター(Lion)	* Do not leave the agent on too long and make sure to remove leftover traces. Leaving traces could result in discoloration, alteration, and deterioration of the rubber. * Refer to "moldy bathroom" (P.3) for use of mold-killing agent.
 Bath heater cleaner	Cleans the dust or grime inside the bath heater and pipe with a bubbling foam.	 ジャバ (for one port) (Johnson)	

5 ◆ * Even when using one of the agents shown above, select a cleaner suitable to the type and condition of the grime and use it in the proper way. Incorrect usage could not get the best results from each agent and could damage the bathroom.

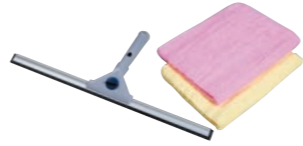
Useful products

Melamine foam (some could come with a handle)		This is used soaked in water for soft scrubbing. * Do not apply excess force when scrubbing. Doing so could cause scratches. * Do not use the melamine foam on the printed part of the faucet. Doing so could cause the printed part to be erased. * Do not use the melamine sponge on glazed resin parts such as the counter.
Brush or sponge for roll-up bathtub cover		Sponges or brushes with an irregular tip will fit the grooved surface of the roll-up cover.
Water wiper (squeegee), car washing towel		These items absorb water well and quickly and are better than re-using a dust-cloth many times.
スーパークリーナー 万能Jrくん (Marushin)		A neutral solid cleaner made from plant sources. It works on stubborn grime and contact corrosion

Do not use

These will scratch surfaces and cause damage.	- Cleaners that could be abrasive such as powdered cleanser, scouring powder, etc. - Hard sponges such as wire wool or nylon scrubbers, or brushes with hard bristles
These will discolor surfaces and cause spots.	- Cleaners such as lacquer or thinner, chemicals such as alcohol or hydrochloric acid, ammonia, caustic soda, or detergents and cleaning agents containing such materials. - Acid or alkaline cleaners (excluding mold killing agent)* - Cleaners containing orange oil (can be applied to non-resin parts and surfaces)

* Cleaners with mild acidity or alkaline can be used. However, they could cause discoloration of the bathtub, floor, metallic parts or coated parts, and metal parts could rust. When using such cleaners, check beforehand on an inconspicuous part of the bathroom for discoloration and other negative effects. Also, do not leave them on for a long time and make sure to rinse them so there is no remaining cleaner.

Warning

- ! During and after use of mold killing agent, ensure that the bathroom door is closed and that there is sufficient ventilation.
- ! When using mold killing agent, do not spray the agent above shoulder height. Also, ensure that it does not splash on your face or clothing.

⊘ Do not mix and use chlorine-based detergents, cleaners and acidic cleaners. (Using these at the same time or even one after the other could result in harm due to the production of chlorine gas.)

! When using mold killing agent, wear a mask, rubber gloves and protective glasses.

Caution

- ! Read the warnings on the cleaner package carefully before use.
- ! When cleaning, protect your hands with rubber gloves.
* There is a danger of injury from protrusions or gaps, etc.
- ! Use a cleaning agent that is suitable for your water heater.

⊘ Do not use bleach or solid and powder types of chlorine-based detergent, or allow these substances to come close to the bathroom's parts.

* Metal and rubber parts could rust or deteriorate, resulting in leaks.

! If cosmetics, aromatic oils or other chemicals adhere to any of the bathroom's parts, wash them off with water immediately.
* Failure to do so could result in leaks, discoloration or breakage.

Please note

- **Do not use**
Do not use solvents or other chemicals marked "Do not use".
- **When using cleaners other than neutral cleaners**
Before using cleaners other than synthetic bathroom cleaner (neutral), test the agent on an inconspicuous part of the bathroom for discoloration and other negative effects.
- **Remove metal objects promptly.**
Do not leave hair pins, razor blades and other metal object in the bathroom for long periods of time.
* Doing so could cause rusting to occur.
- **Do not use items with adhesive discs attached**
Do not use adhesive disc-attached towel racks, soap dishes, etc.
* Doing so could cause discoloration.

Remove cleaner promptly

After applying any type of detergent or cleaning agent, quickly use water to wash off the bathtub, floor, walls and counter, etc.
* Leaving cleaner on for long periods of time could cause surfaces to alter or change color.

When using mold killing agent







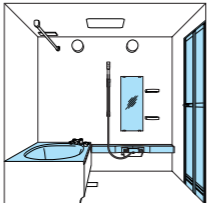

When using mold killing agent, read the warnings carefully before use. Also, after using the mold killing agent, quickly wash off with water.
* Leaving mold killing agent on for long periods of time could cause surfaces to alter or change color. Also, the faucet fittings and door frame could rust and the rubber part of the drain could deteriorate.

Use of cosmetics (hair dye, etc.)

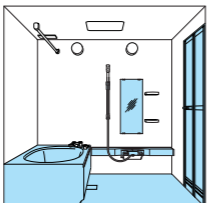
When using hair dye or nail polish remover in the bathroom, make sure to protect the floor and other parts with a sheet, etc.
* Adherence of such substances to the bathroom's surfaces could cause blemishes to appear.

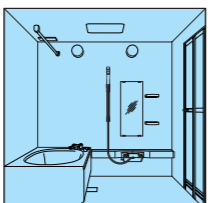
Types of Grime and Cleaning Methods

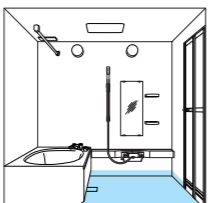
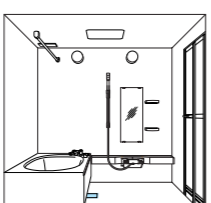
When you spot grime, look up the type of grime and the cleaning method on this page. Do not leave the grime untreated. Untreated grime could become stubborn and hard to remove.

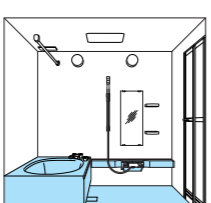
Type	Color	Probable location	Characteristics	Cause	Preventive action	Cleaning methods	Notes
Water stain Hot-water stain	White Brown	Bathtub (bathtub ring), faucet, door, mirror, shower hook, etc. 	Typically rough, whitish surface.	Water stains result from the accumulation of silicic acid, which is in the water supply. <i>* Since it does not dissolve in water, grime could become stubborn when left for long periods of time.</i> Hot-water stains result from a combination of body oils, soap residue, and dust.	Daily cleaning procedures <i>* For details, refer to "daily cleaning" (P.9, 10).</i>	 Apply synthetic bathroom cleaner (neutral), leave for 2 to 3 minutes, scrub the bathtub with a sponge, and rinse off the cleaner. Point  Apply bathroom cream cleanser to grime that cannot be removed with synthetic bathroom cleaner (neutral).	<i>* When using bathroom cream cleanser, take care not to scratch surfaces or make surfaces overly shiny by scrubbing too hard. (Resin and aluminum parts could be easily scratched or become less shiny.)</i> Point Do not scrub hard when using bathroom cream cleanser. After scrubbing a spot four or five times, wash it off with water. Repeat these steps to gradually clean the bathtub. <i>* Copper ion will be dissolved from new copper pipes in newly-built houses or buildings, but this will be normally resolved in several months. (This could take longer, depending on water quality.)</i>
Metallic soap (calcium soap, magnesium soap, etc.) (copper soap, etc.)	White Gray Blue green	Floor, around bathtub, door, mirror, counter, shower hook, etc. 	Typically hard, rough, sticky surface.	Grime which is not dissolved, resulting from metallic ions like calcium, magnesium, or copper in the water supply, combined with soap and body oils.		 Apply mold killing agent and then rinse off thoroughly after leaving it for awhile.	<i>* Do not leave the agent on too long and make sure to remove leftover traces. Leaving traces could cause discoloration, alteration, rust, or deterioration of the rubber.</i> Point Mold killing agent is most effective when used on a dry bathroom that has already been cleaned.
Mold	Black Purple Pink	Entire bathroom 	Grime which grows in places all over the bathtub in black, purple or a pinkish color when the conditions for growing mold are met.	A type of microbe which grows in places which combine warm temperatures (20-30°C (68-86°F)), moisture (70% or higher), and nutrient sources (soap residue, body oils, dust, etc.)		 Apply synthetic bathroom cleaner (neutral) to the bathtub ring, leave for 2 to 3 minutes, scrub the bathtub with a sponge, and rinse off the cleaner. Point Apply mold killing agent to grime that cannot be removed with synthetic bathroom cleaner (neutral). Rinse off thoroughly after leaving it for awhile.	Do not scrub hard! Do not scrub the bathtub or parts in the bathroom forcefully with a hard sponge or a brush with hard bristles. Doing so could leave fine scratches on the surface, to which the fungal thread of mold will get into and become grime that is hard to remove. 
Pink slime	Pink	Around drain opening, floor, wall (lower area) 	Pink colored slime	Results from yeast growing on nutrients such as body oils. <i>* Untreated grime could become hard to remove with pigment deposited.</i>		Once a week Once a month cleaning procedures <i>* For details, refer to "floor drain trap" (P.20-23).</i>	
Slime	—	Around drain opening, etc. 	Slime occurring in places where water accumulates, such as the drain opening.	Slime occurring in places where water accumulates, such as the drain opening. Becomes slimy and emits bad odor when germs adhere and grow, using grime as a nutrient.	 Scrub grime off softly with bathroom cream cleanser, taking care not to scratch the surface beneath.		
Contact corrosion	Reddish brown	Floor, around bathtub, counter, etc. 	Rough surface with a reddish brown color	Result of rust from steel products such as wet hairpins or razors. Also from tiny iron particles in the water or brought in from outside.	Do not leave wet metal objects in the bathroom.		

Combining daily cleaning and regular cleaning is basics of cleaning. Clean grime and dry the bathroom after using it.

Using shower and a sponge or cloth

Daily



1 Wash grime with warmer shower.

- * Start from a highest position.
- * Wall is particularly prone to grime from the floor up to 1-meter level. Carefully clean this part of wall.
- * Do not directly apply water to the door. Otherwise water could splash outside the door.

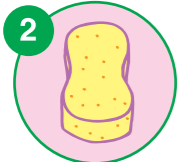

2 Scrub grime off softly with a sponge.



3 Lower the temperature of the bathroom to a normal level with cold shower.

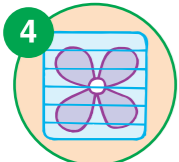

4 Wipe off the remaining water and open the window or turn on the ventilation fan.

- * It is recommended to keep the fan on until the next morning. (If you are using a constant (24-hour) ventilating facility, turn on the strong ventilation function.)



Tips

Cleaning is most effective after taking a bath.



Some grime gets harder and more stubborn when it gets dry. Cleaning is easier when the bathroom is wet after use (except for mold).

- * Please refer to "type of grime and cleaning methods"(P.7-8)for the use of a mold-killing agent.

Faucet and mirror



Grime stands out on these locations. After washing off the grime with shower, dry them with a dry cloth.

Shelves



Wash off shampoo or conditioner on the bottom of the bottles.

Door, light, fan, heater

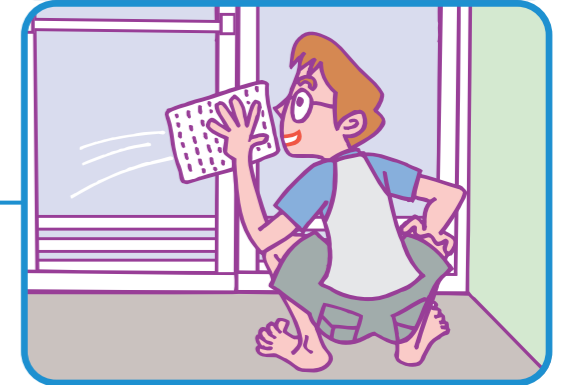

Clean grime with a damp cloth and dry the spot with a dry cloth.

- * Remove dirt in a door frame.
- * Grime stands out on a clear material. Carefully wipe off the grime and dry the spot.

Wall



Softly scrub off stubborn grime with a sponge.

Counter

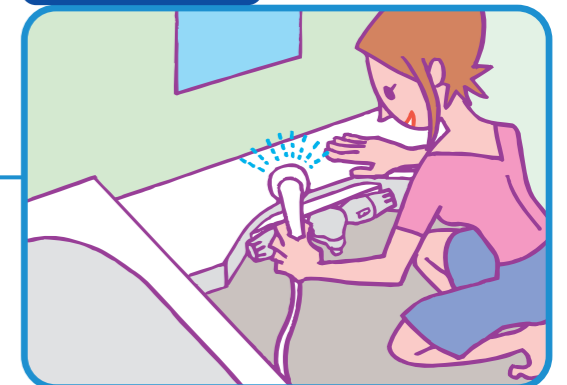

Using hot shower, wash grime off on a counter, between a counter and wall, and between a counter and bathtub.

Bathtub and bath cover



Wash off grime on the bathtub and between the bathtub and wall with hot shower. Scrub off stubborn grime softly with a sponge.

Floor



Scrub stubborn grime with a bathroom brush softly.

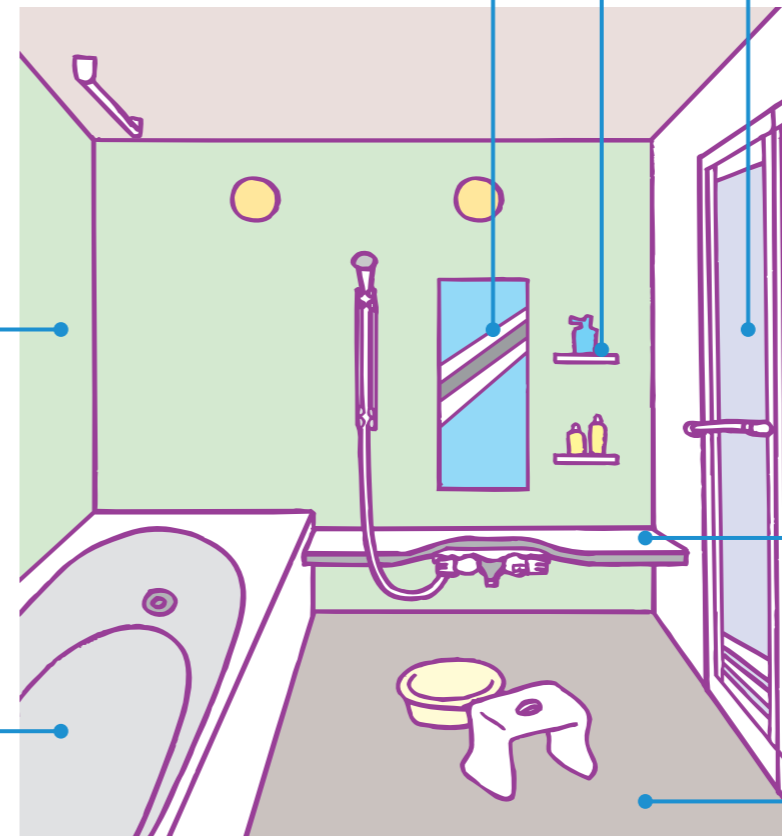

Point

- Use synthetic bathroom cleaner (neutral) for stubborn grime.
- * Use the diluted synthetic bathroom cleaner (neutral) for cleaning door, hand rail, accessories including shelves, light, fan, or heater.

Wipe off the remaining water and grime on places in black or dark color. Grime stands out on these locations.

Reference for Cleaning

Plan your regular cleaning based on the table below. Refer to the reference pages in the right columns for the details of cleaning.



Keep your bathroom clean for your family's health too.

If you clean your bathroom everyday and also regularly, you are unlikely to find stubborn grime. Clean the drain trap and other parts to take full advantage of their functionality.

Please note that you might not be able to take full advantage of functionality of these parts if you do not clean them regularly.

Make sure to clean.

Reference for cleaning

Reference for cleaning		Daily	Once a week	Once a month	Every six months or if grime became noticeable	Notes
Around bathtub	① Bathtub		Clean by rubbing softly.		After scrubbing a spot four or five times with cream cleanser wash it off with water. Repeat these steps to gradually clean it.	P13
	② Bath cover		Use a toothbrush to remove remaining grime on narrow portions.	Recommended It is recommended to dry the cover in the shade about once a month.		* Note 1 P13
	③ Reheater port (circulation port)		Remove grime from the filter.	Wash the inside the bath heater using bath heater cleaner.		P14
	④ Bathtub drain opening		Remove grime from the drain plug and drain core.		Remove grime from pushbutton of the one-way push drain plug.	P15~
Floor, ceiling and walls	⑤ Floor		Scrub the floor joint and caulking material.		Remove mold using mold killing agent. *If mold cannot be removed with the agent, use the bathroom brush.	* Note 2 P17
	⑥ Ceiling			Clean by rubbing softly.		P18
	⑦ Walls		Clean by rubbing softly.		Remove mold using mold killing agent.	* Note 2 P19
	⑧ Floor drain trap		Clean the hair catcher. * It is recommended to clean it everyday.	Remove grime inside the trap and the parts.		P20~
	⑨ Beneath the bathtub					Clean beneath the bathtub by removing the apron. P24~
Door	⑩ Door		Remove the dirt and hair from the lower frame track and the hair catcher.		Remove the stubborn grime and the grime at lower part of the door.	* Note 3 P30~
Accessories	⑪ Mirror		Clean by rubbing softly.		After scrubbing a spot four or five times with cream cleanser wash it off with water. Repeat these steps to gradually clean it.	* Note 1 P36
	⑫ Hand rail, slide bar, towel rod		Wipe off softly.		Wipe off softly using diluted cleaner.	P37
	⑬ Shelves, counter		Wipe off softly using diluted cleaner.		After removing the shelves, wipe off softly using diluted cleaner.	P37
Faucet	⑭ Faucet		Clean by rubbing softly.	After scrubbing a spot four or five times with cream cleanser wash it off with water. Repeat these steps to gradually clean it.	Remove grime from the strainer, flow control unit and spray plate.	P38~
Light and ventilation fan, heater	⑮ Light				Wipe off softly using diluted cleaner.	P41~
	⑯ Ventilation fan, heater			Clean the fan and heater with the front cover and filter removed.	Clean them with diluted cleaner.	P43~

Daily
cleaning procedures
See P.9 and 10.

* Note1: When using bathroom cream cleanser, take care not to scratch surfaces or make surfaces overly shiny by scrubbing too hard.
 * Note2: When using mold killing agent, be sure to read the instructions and use it properly. (Refer to "moldy bathroom" on pages 3 and 4.)
 * Note3: Use synthetic bathroom cleaner only when applying a cleaner to aluminum parts. Grime stands out on a clear material. Carefully wipe off the grime and dry the spot.

- Bathtub
- Bath Cover
- Reheater Port (Circulation Port)
- Bathtub Drain Opening
- Floor
- Ceiling
- Walls
- Floor Drain Trap
- Beneath the Bathtub
- Door
- Mirror
- Hand Rail, Slide Bar and Towel Rod
- Storage Shelves and Counter
- Faucet
- Light
- Ventilation Fan and Heater

- Bathtub
- Bath Cover
- Reheater Port (Circulation Port)
- Bathtub Drain Opening
- Floor
- Ceiling
- Walls
- Floor Drain Trap
- Beneath the Bathtub
- Door
- Mirror
- Hand Rail, Slide Bar and Towel Rod
- Storage Shelves and Counter
- Faucet
- Light
- Ventilation Fan and Heater

1 Bathtub

Once a week 1 Apply a synthetic bathroom cleaner (neutral) on a bathtub and wait for a few minutes. Then scrub it softly with a sponge.



2 Wash the cleaner off with water so that it does not remain on the bathtub.

Please note
Do not use bathroom cream cleanser frequently. It could cause scratches on a bathtub or surface luster could be lost.

If grime became noticeable If the grime such as water stain became too stubborn to clean with a synthetic bathroom cleaner (neutral)

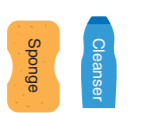

1 Scrub the grime softly with bathroom cream cleanser on a sponge.

2 Wash the cleaner off with water so that it does not remain on the bathtub.

One point tip
Do not apply excessive force when you clean a bathtub with a bathroom cream cleanser. After scrubbing a spot four or five times wash it off with water. If you repeat these steps and gradually clean a bathtub, the bathtub becomes more immune to scratches.

2 Bath cover

Once a week 1 Clean a bath cover with a synthetic bathroom cleaner (neutral) and a sponge. Use a toothbrush for finer areas.



* A brush for a roll-up cover (recommended useful product) can clean both convex and re-entrant areas at the same time.



2 Wash the cleaner off with water so that it does not remain.

If grime became noticeable If the grime such as water stain became too stubborn to clean with a synthetic bathroom cleaner (neutral)

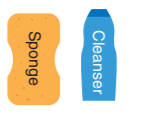

1 Scrub the grime softly with bathroom cream cleanser on a sponge.



2 Wash the cleaner off with water so that it does not remain.

One point tip
You can make your own brush for a roll-up cover by making 1-cm square incisions on the sponge with a hard nylon scrubber. (Do not use the hard nylon scrubber part.)
You can prevent the bath cover from getting moldy by drying it in an airy location in the shade around once a month after you clean it.

3 Reheater port (circulation port)

* If your reheater port is a product of another manufacturer, refer to the user's manual for cleaning.

Once a week * Built-up scum or hair could adversely affect circulation. It could cause heating malfunction.

Make sure to clean.

1 Turn the circulation port cover counter-clockwise until it stops and then pull the cover.

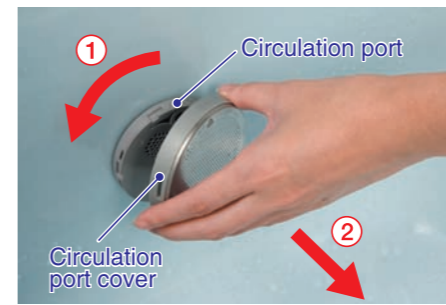

2 Remove hair, scum or grime from the circulation port cover (filter) and the circulation port using a toothbrush or another appropriate brush.



3 Aligning △ on the circulation port cover with △ on the circulation port, put the cover back, and turn the cover clockwise until it clicks.



Please note
Do not remove any part other than the circulation port cover.
* Forcibly removing the cover could prevent the bathtub from being filled or water could be drained from the bathtub.
Read the warnings on the bath heater cleaner package carefully before use.
* For details, refer to the user's manual of your water heater.
After cleaning, secure the circulation port cover in the correct position.
* Failure to secure the circulation port cover in the correct position could result in the water heater being unable to regulate the temperature of the water and the water being heated incorrectly.

* Do not wash waste or other materials removed from the circulation port cover directly down the drain.



Once a month Use a bath heater cleaner.
* Read the instructions for the cleaner to use it properly.



4 Bathtub drain opening

Cleaning a rubber plug

Once a week

1 Lift the rubber plug and then take out the drain core by pulling the knob.



Make sure to clean.

2 Remove grime or scum from the drain core using a toothbrush or another brush.



* Do not wash waste or other materials removed from the drain core directly down the drain or use the bathtub with the drain core removed. The drainage water pipe could become clogged.

3 Put back the drain core to the outlet.



* Push the drain core in firmly. If the drain core is set at an angle and not pushed in firmly, the rubber plug could float and prevent the bathtub from filling up.

Cleaning a one-way push drain plug

Cleaning a drain opening

Once a week

1 Open the drain plug (the plug is lifted) and pull out the plug at a right angle.



Make sure to clean.



Please note

When fitting the drain plug (sealing plug), make sure to insert it correctly.

Before use, check that the drain plug (sealing plug) is not resting on an angle.
* When the drain plug (sealing plug) is set at an angle, there could be a gap which prevents the bathtub from being filled or water could be drained from the bathtub.



2 Remove the drain core and clean it with a toothbrush or a similar tool.



* Do not wash waste or other materials removed from the drain core directly down the drain or use the bathtub with the drain core removed. The drainage water pipe could become clogged.

3 Put back the drain core to the drain opening.

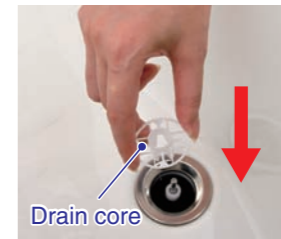

* If the drain plug (sealing plug) is set at an angle, remove it and re-install it by pushing it down until it clicks.

* Improper installation of the drain plug (sealing plug) could prevent the bathtub from being filled.

4 Insert the one-way push plug (the plug is closed) and keep pressing it until it clicks.



5 Press a push button on top of the bathtub a few times to check if the plug opens and closes properly.



Cleaning a push button

If grime became noticeable



Make sure to clean.

1 Take out the push button on top of the bathtub by applying packing tape or a cupule on it, pushing the button and pulling it out.



2 Clean grime or slime on the button.



* Do not wash waste or other materials removed from the push button directly down the drain.
* Water that enters the push button will be drained out through the bottom of the bathtub.

3 Repeatedly pull up and push down the center rod where the button was while applying warm water on it.

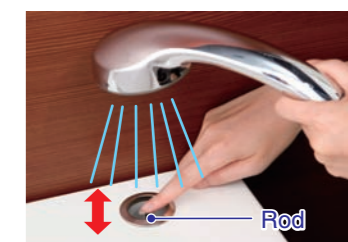

4 Put the push button back and insert it until it clicks.



5 Floor

Once a week

When conditioner and other substances get dry and stick to the mosaic-pattern floor, the floor does not drain as effectively as before.



Make sure to clean.

1 Apply synthetic bathroom cleaner (neutral) and wait for a few minutes.

2 Rub the floor softly. Use a split-end type bathroom brush for the FRP floor, and sponge for the tile floor or caulking material.

* Clean along the grooves.



3 Wash the floor with water so that no cleaner remains on the floor.

Warning

- Do not scrape hard objects with joint sealant or caulking material.
 - * If the joint sealant or caulking material splits or comes off, water leaks could result.
- If the joint sealant or caulking material splits or comes off, have it repaired. (See P.50.)
 - * Leaving it as is could result in water leaks.
- If tiles are broken, chipped or cracked, have them repaired.
 - * Using the bathroom with damaged tiles could result in an injury.

Please note

- If water is left on the floor, the floor will take time to dry.
 - * Wiping the floor with a dry cloth will allow the floor to dry quickly.
- If you plan to use a silver ion compound cleaner, do so after performing the "Daily" cleaning routine.
 - * Cleaner components could change color and become difficult to remove.
- (For the barrier-free bathroom series) After use, quickly use water to wash off mold killing agent.
 - * If cleaner is left for long periods of time a decrease in water drainage performance could result.

If grime became noticeable

Dark colored stain or grime could develop around the corners of the floor and it could be hard to remove with synthetic bathroom cleaner (neutral) or mold killing agent. In such cases, rake it out with a split-end type bathroom brush.



◆ Cleaning a caulking material around the floor (when it got moldy)

If grime became noticeable

Use a mold killing agent if a caulking material gets moldy.



* When you use a mold killing or anti-mold agent, make sure to use the agent properly and keep the following points in mind:

- Read the warnings carefully.
- Wear a mask, rubber gloves and protective glasses. Ensure that a window is open or that the ventilation fan is on.
- Do not spray the mold killing agent above shoulder height. (There is a risk that it could splash on your face or clothing.)
- Do not leave the cleaner on for long periods of time.

6 Ceiling

Once a month

1 Scrub the ceiling softly with a sponge with a long handle using a synthetic bathroom cleaner (neutral).

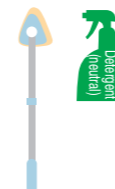

2 Wipe off the cleaner with a damp cloth.

Warning

- Do not scrape hard objects with joint sealant or caulking material.
 - * If the joint sealant or caulking material splits or comes off, water leaks could result.
- If the joint sealant or caulking material splits or comes off, have it repaired. (See P.50.)
 - * Leaving it as is could result in water leaks.

- Bathtub
- Bath Cover
- Reheater Port (Circulation Port)
- Bathtub Drain Opening
- Floor**
- Ceiling
- Walls
- Floor Drain Trap
- Beneath the Bathtub
- Door
- Mirror
- Hand Rail, Slide Bar and Towel Rod
- Storage Shelves and Counter
- Faucet
- Light
- Ventilation Fan and Heater

- Bathtub
- Bath Cover
- Reheater Port (Circulation Port)
- Bathtub Drain Opening
- Floor**
- Ceiling**
- Walls
- Floor Drain Trap
- Beneath the Bathtub
- Door
- Mirror
- Hand Rail, Slide Bar and Towel Rod
- Storage Shelves and Counter
- Faucet
- Light
- Ventilation Fan and Heater

7 Walls

Once a week 1 Apply a synthetic bathroom cleaner (neutral) on the wall, wait for two to three minutes and then softly scrub the spot with a sponge.



2 Wash off the cleaner with water so that the cleaner does not remain on the wall.

Warning

- Do not scrape hard objects with joint sealant or caulking material.
- * If the joint sealant or caulking material splits or comes off, water leaks could result.
- If the joint sealant or caulking material splits or comes off, have it repaired. (See P.50.)
- * Leaving it as is could result in water leaks.



Cleaning a tile joint (when it got moldy)

If grime became noticeable Use a mold killing agent if the tile joint or caulking material gets moldy.



* When you use a mold killing or anti-mold agent, make sure to use the agent properly and keep the following points in mind:

- Read the warnings carefully.
- Wear a mask, rubber gloves and protective glasses. Ensure that a window is open or that the ventilation fan is on.
- Do not spray the mold killing agent above shoulder height. (There is a risk that it could splash on your face or clothing.)
- Do not leave the cleaner on for long periods of time.

8 Floor drain trap

A floor drain trap is a device to prevent odor or pests from entering a bathroom. It normally contains water (which is called seal water).



Warning

- Do not loosen the drain trap's flange.
- * If the drain trap comes loose, water leaks could result.

The cleaning method for a floor drain trap varies depending on the model. Check which model is used on the cover of the user's manual.

For the system bathroom SOLEO / SOLEO 1822TAGG

Cleaning the hair catcher, drain trap and around them

Once a week 1 Remove the floor drain cover. Clean the floor drain cover and drain trap with a sponge while applying shower on them.



Make sure to clean.



2 Remove the hair catcher by using the tab to turn the hair catcher counter-clockwise.



3 Remove hair, slime or grime from the hair catcher.



4 Put back the hair catcher by turning it clockwise and then put back the floor drain cover.



When water drains out of the bathtub, a gurgling sound could be emitted from the drain trap. This sound is not a malfunction but instead a temporary sound resulting from the large amount of water flowing.

* While the gurgling sound is being emitted, the water (sealant water) level in the drain trap will drop and then return to normal once the bathtub is finished draining.

●Cleaning inside the trap

Once a month 1

Remove the floor drain cover and hair catcher. Take out the water-passage pipe by turning it counter-clockwise for 45-degree.

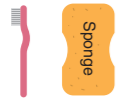

Make sure to clean.

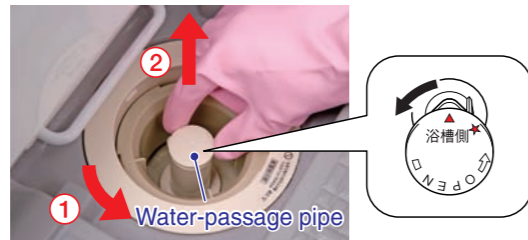

2

Turn the seal-water cylinder counter-clockwise until it stops. Align the groove on the cylinder with the tab of the drain trap and pull the cylinder.

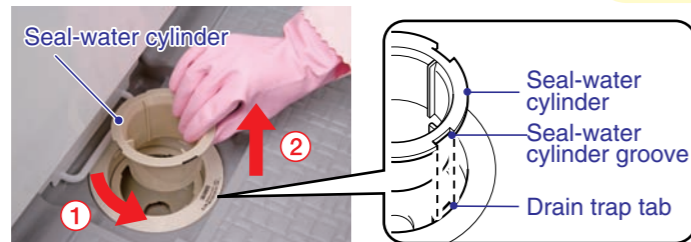

3

Clean the cylinder, water-passage pipe and inside the drain pipe using a toothbrush or sponge.

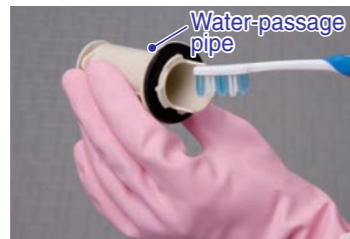

4

Align the groove of the cylinder with the tab of the drain trap and put back the cylinder. Turn the cylinder clockwise until it stops.



5

Arrange ☆ on the water-passage pipe and the side line towards the bathtub. Insert the pipe in the hole on the bottom of the drain opening. Turn the pipe clockwise for 45-degree.

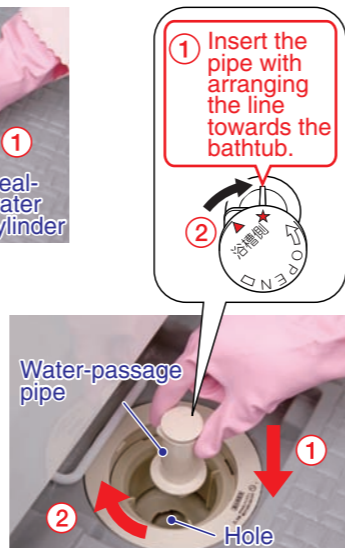

* After installation, ensure that the △ mark on the upper surface of the water-passage pipe faces the bathtub.

Please note

Do not use with the water-passage pipe removed.
* Insect infestation or bad smells could result.

Do not remove the maintenance cap located beside the water-passage pipe.

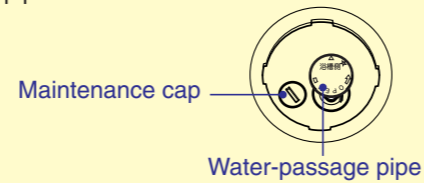

* Do not remove the packing attached to the seal-water cylinder.

◆For the system bathroom Barrier-Free Bathroom 1116

●Cleaning a hair catcher, drain trap and around them

Once a week 1

Remove the floor drain cover. Clean the floor drain cover and drain trap with a sponge while applying shower on them.



Make sure to clean.



2

Remove the hair catcher by using the tab to turn the hair catcher counter-clockwise.



* Do not allow waste to build up in or around the hair catcher and drain trap. Doing so could cause water drainage to become slow and the water drainage pipe to become clogged.

* Do not wash waste or other materials removed from the hair catcher or drain trap directly down the drain trap.

3

Remove hair, slime or grime from the hair catcher.



4

Put back the hair catcher to the drain opening with the "lock" sign pointing towards you. Fix it by turning it clockwise using the tab.



* Make sure that the hair catcher is fixed when using it.

5

Put back the floor drain cover.

- Bathtub
- Bath Cover
- Reheater Port (Circulation Port)
- Bathtub Drain Opening
- Floor
- Ceiling
- Walls
- Floor Drain Trap**
- Beneath the Bathtub
- Door
- Mirror
- Hand Rail, Slide Bar and Towel Rod
- Storage Shelves and Counter
- Faucet
- Light
- Ventilation Fan and Heater

- Bathtub
- Bath Cover
- Reheater Port (Circulation Port)
- Bathtub Drain Opening
- Floor
- Ceiling
- Walls
- Floor Drain Trap**
- Beneath the Bathtub
- Door
- Mirror
- Hand Rail, Slide Bar and Towel Rod
- Storage Shelves and Counter
- Faucet
- Light
- Ventilation Fan and Heater

● Cleaning inside the trap

Clean the trap after removing the apron.
Refer to "Removing and fixing apron" in the user's manual for the details of removing the apron.

Once a month 1



Make sure to clean.

1 Remove the floor drain cover and hair catcher. Turn the seal-water cylinder counter-clockwise until it stops. Align the groove on the cylinder with the tab of the drain trap and pull the cylinder.



Please note

Do not use with the seal-water cylinder removed.
* Insect infestation or bad smells could result.

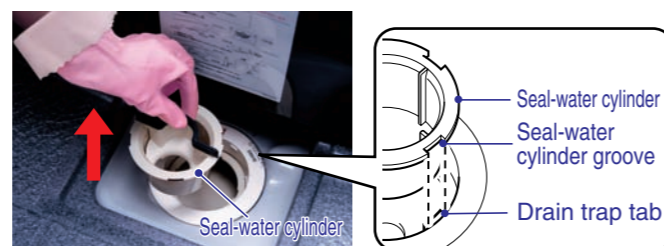

2 Clean the cylinder and inside the drain trap using a toothbrush or sponge.



* Do not remove the packing attached to the seal-water cylinder.
* The internal wall of the seal-water cylinder can be pulled up when cleaning.
After cleaning, insert the internal wall along the slot inside the seal-water cylinder to the deepest position. (If inserted improperly, the strainer cannot be fitted.)

Remove dirt or grime around the opening beneath the partition inside the floor drain trap (closer to the bathtub). If dirt or grime accumulates around the opening, it adversely affects drainage from the bathtub.

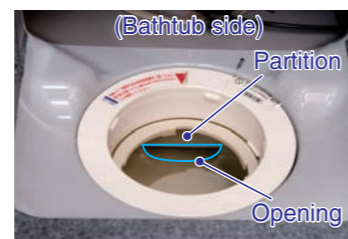

3 Align the groove of the cylinder with the tab of the drain trap and put back the cylinder. Align ▲ on top of the cylinder with ■ on top of the drain trap and push the cylinder in further.

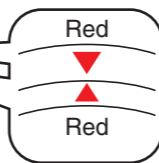
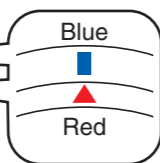
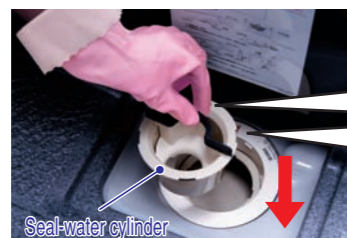

* Do not set the seal-water cylinder at an angle.

4 Turn the cylinder clockwise until ▼ on top of the drain trap is aligned with ▲.

9 Beneath the bathtub

Cleaning method for this location varies depending on the model. Check your model on the cover of the user's manual.

◆ For the system bathroom SOLEO / SOLEO 1822TAGG

⚠ Caution

When cleaning beneath the bathtub, wear rubber gloves and clothes that do not expose your arms.
* Failure to do so could result in an injury.

Do not directly insert your arms or hands beneath the bathtub.
* There are protruding parts etc. that could cause an injury.

● Removing the apron

In the following example, the system bathroom SOLEO is being removed.
If you are using the system bathroom SOLEO 1822TAGG, refer to "Removing and fixing apron" in the user's manual.

1 Remove apron side spacers (on the right and left side).



Pull the tab of the apron side spacer on the wall side.

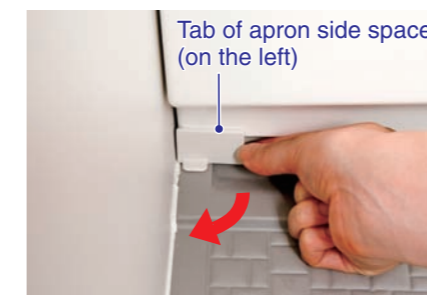

When the center side of the apron side spacer comes out, pinch the center side and remove it by pulling it.

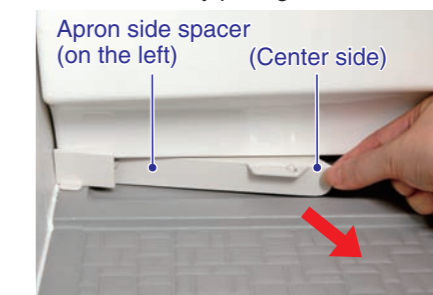

Remove the right side in the same manner.

- Bathtub
- Bath Cover
- Reheater Port (Circulation Port)
- Bathtub Drain Opening
- Floor
- Ceiling
- Walls
- Floor Drain Trap**
- Beneath the Bathtub
- Door
- Mirror
- Hand Rail, Slide Bar and Towel Rod
- Storage Shelves and Counter
- Faucet
- Light
- Ventilation Fan and Heater

- Bathtub
- Bath Cover
- Reheater Port (Circulation Port)
- Bathtub Drain Opening
- Floor
- Ceiling
- Walls
- Floor Drain Trap
- Beneath the Bathtub**
- Door
- Mirror
- Hand Rail, Slide Bar and Towel Rod
- Storage Shelves and Counter
- Faucet
- Light
- Ventilation Fan and Heater

- Bathtub
- Bath Cover
- Reheater Port (Circulation Port)
- Bathtub Drain Opening
- Floor
- Ceiling
- Walls
- Floor Drain Trap
- Beneath the Bathtub**
- Door
- Mirror
- Hand Rail, Slide Bar and Towel Rod
- Storage Shelves and Counter
- Faucet
- Light
- Ventilation Fan and Heater

2 Remove the floor drain cover.



3 Remove the partition by pulling it while holding the apron with the other hand.



4 Pull the lower part of the apron while pushing down the upper part of the apron. Remove the upper part of the apron from the metal hook located at the center of the bathtub.

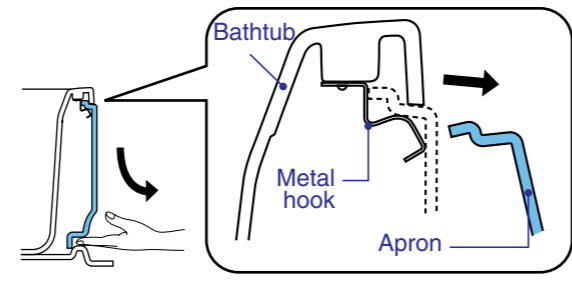

5 When the apron is off the hook, pull the other side of the faucet and then move the apron to the wash area to remove it as shown below.

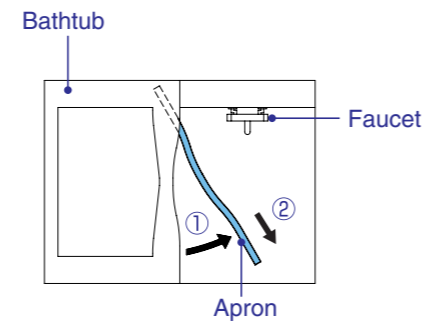

● Cleaning beneath the bathtub

Every six months

Make sure to clean.

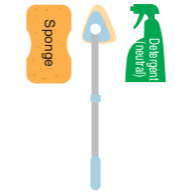

1 Apply a synthetic bathroom cleaner (neutral) on the floor and walls beneath the bathtub and wait for two to three minutes. Softly scrub the area with a sponge with a handle or another tool as far as it can reach.
* Use a mold killing agent if it is moldy.

2 Wash off the area with high-pressure shower so that the agent does not remain.

3 For a thermo bath

If insulating material is used, clean it with a sponge using diluted synthetic bathroom cleaner (neutral). After cleaning, wipe off the cleaner with a damp cloth so that it does not remain on the material.

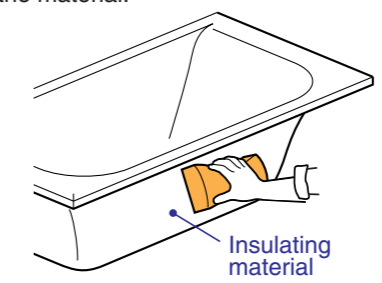

4 Pull the drain opening cover of the drain opening beneath the bathtub and clean it.

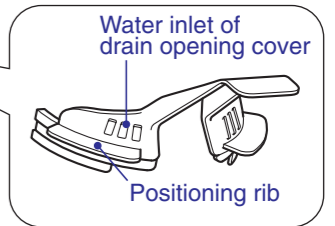
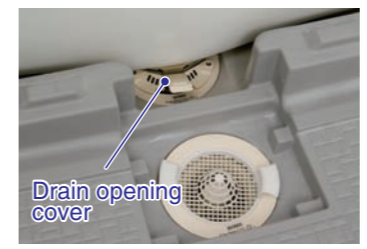

5 Put back the drain opening cover to the drain opening beneath the bathtub.

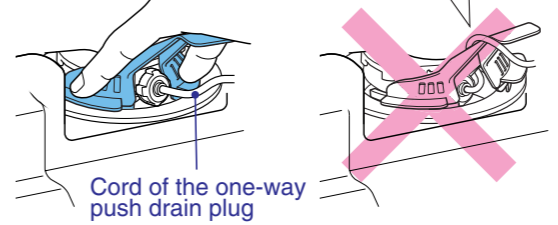

The cord of the one-way push drain plug is over the cover.

* For a thermo bath, do not allow water or cleaner to come into direct contact with the insulating material. (Immediately wipe any liquid that adheres.)

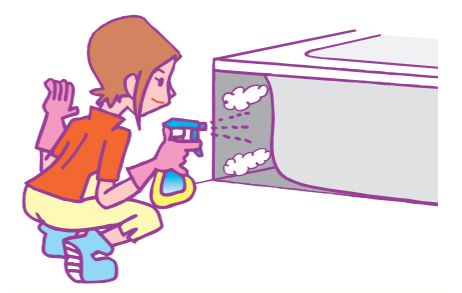

Please note

(For a thermo bath)
 • Do not roughly scrape or peel off insulating material or seams.
 • Do not scrape with hard or sharp objects.
 • Do not use hot water above 50°C (122° F) or steam.
 * Doing so could cause the insulating material to become damaged, wrinkled or dirty.
 (If the insulating material becomes dirty or peels off, insulating performance will be reduced.)

* Clean around the drain opening and water inlet (2 places) of drain opening cover.

* Do not flush waste or other materials directly down the drain opening or use with the cover removed. The drain pipe could become clogged.
 * If using a one-way push drain plug, install the drain opening cover using the cord on top of the one-way push drain plug.

- Bathtub
- Bath Cover
- Reheater Port (Circulation Port)
- Bathtub Drain Opening
- Floor
- Ceiling
- Walls
- Floor Drain Trap
- Beneath the Bathtub**
- Door
- Mirror
- Hand Rail, Slide Bar and Towel Rod
- Storage Shelves and Counter
- Faucet
- Light
- Ventilation Fan and Heater

Fixing the apron

In the following example, the system bathroom SOLEO is being fixed. If you are using the system bathroom SOLEO 1822TAGG, refer to "Removing and fixing apron" in the user's manual.

1 Hold the apron vertically and push the faucet side end, turning the opposite end to rest the apron temporarily.

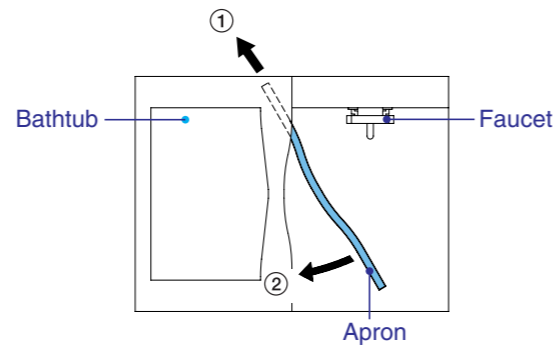
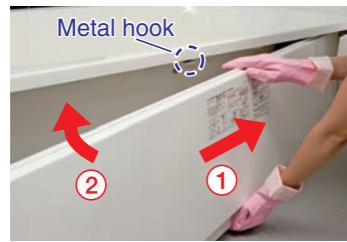

2 Lift the apron to push its upper part in to the metal hook located at the center of the bathtub.

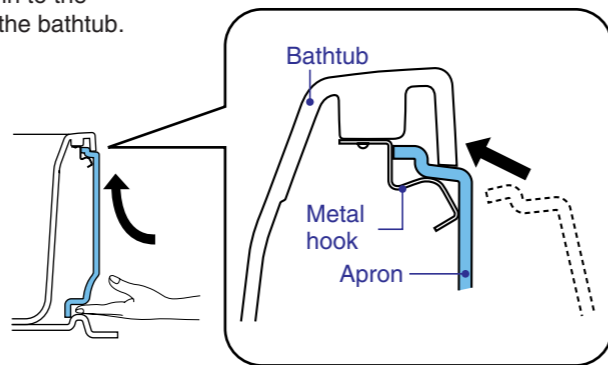

3 While slightly lifting the apron, put the partition in the back of the drain opening.

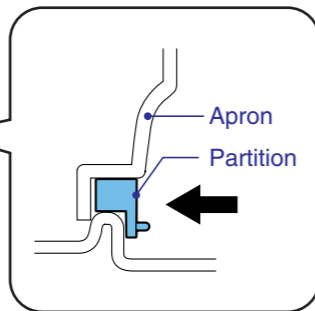

Push the partition in firmly until it fits.

4 Install the floor drain cover.



5 Attach the apron side spacers (on the right and left side).

Push the spacer on the tab side along the wall panel.



Push the spacer on the center side.



One point tip

- On the apron side spacer there are various marks such as "左(left)" and "右(right)".
 - Ensure that the "Left", "Right" and other marks are facing upward.
 - The apron side spacer should face from the wash area toward the bathtub with the "Left" and "Right" marks lined up correctly.
- * When viewed from the top, the "←壁 (wall)" and "→壁 (wall)" arrows should point in the correct directions.



After installation, ensure that the apron side spacer does not rattle.



Make sure you put it back in place neatly, ok?

◆ For the system bathroom Barrier-Free Bathroom 1116

Clean the bathroom after removing the apron.
Refer to "Removing and fixing apron" in the user's manual for the details of removing and fixing the apron.

Every six months



Make sure to clean.

1 Remove the apron to place the hair catcher.
*Do not fix the hair catcher.



2 Apply a synthetic bathroom cleaner (neutral) on the floor and walls beneath the bathtub and wait for two to three minutes. Softly scrub the area with a sponge with a handle or another tool as far as it can reach.
*Use a mold killing agent if it is moldy.



3 Wash off the area with high-pressure shower so that the agent does not remain.

4 For a thermo bath

If insulating material is used, clean it with a sponge using diluted synthetic bathroom cleaner (neutral). After cleaning, wipe off the cleaner with a damp cloth so that it does not remain on the material.

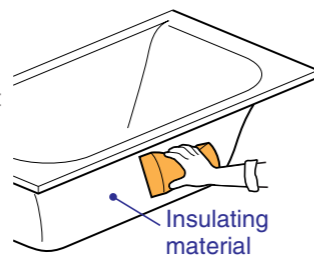

5 Remove the dust and hair from the hair catcher and round the drain trap.



6 Put the apron, partition, hair catcher and floor drain cover back.

* For a thermo bath, do not allow water or cleaner to come into direct contact with the insulating material. (Immediately wipe any liquid that adheres.)

Please note

(For a thermo bath)
• Do not roughly scrape or peel off insulating material or seams.
• Do not scrape with hard or sharp objects.
• Do not use hot water above 50°C (122°F) or steam.
* Doing so could cause the insulating material to become damaged, wrinkled or dirty. (If the insulating material becomes dirty or peels off, insulating performance will be reduced.)

* Do not flush waste or other materials directly down the drain opening or use with the cover removed. The drain pipe could become clogged.

Finish off cleaning by wiping off water with a dry cloth.

10 Door

Caution

Do not splash water directly on the door.
* Doing so could cause water to leak outside the bathroom and get the household goods, etc.

Use only synthetic bathroom cleaner (neutral) to clean the door.
* Using other type of cleaner could damage the draining part at the lower frame, resulting in water leakage or discoloration.



If grime became noticeable



1 Apply diluted synthetic bathroom cleaner (neutral) to a soft cloth. Wipe off grime with the cloth.

* If the grime is hard to remove, clean off using diluted synthetic bathroom cleaner (neutral) with a toothbrush.
Wipe off with a damp cloth so that cleaner does not remain.



2 To prevent clogging, clean the grille area (air entry opening) with a vacuum cleaner.

3 Remove the dirt from the lower part of the door and the rail of the door frame.

* If dirt is accumulated, the door could become difficult to open or close, or it can cause scratches (except for swing doors).
* For how to remove the door, refer to the user's manual.

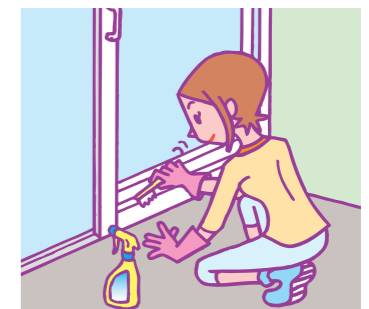

● Cleaning a tempered swing door and FIX window

Cleaning a tempered glass

The transparent faces of tempered swing doors, FIX windows and free select doors are made of tempered glass. Shatter prevention film is attached to the changing room side of tempered glass for safety.

When cleaning the glass surface on its changing room side, lightly wipe with a rubber cleaning spatula or soft wet cloth.



Please note

Do not use a brush, abrasive chemicals, sponge which contain abrasive chemicals, dirty rags, dry cloth, etc.
* Doing so could scratch the shatter prevention film.

Cleaning a grille of tempered swing door

Open the door, and open the grille in the vertical frame on the changing room side as illustrated.

* The grill is in the vertical frame on both sides of the tempered swing door.

To prevent clogging, clean the grille area with a vacuum cleaner.

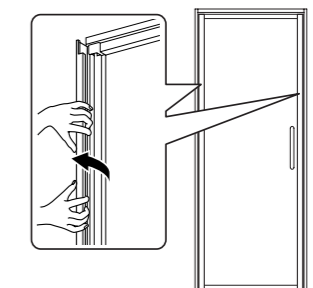

- Bathtub
- Bath Cover
- Reheater Port (Circulation Port)
- Bathtub Drain Opening
- Floor
- Ceiling
- Walls
- Floor Drain Trap
- Beneath the Bathtub
- Door
- Mirror
- Hand Rail, Slide Bar and Towel Rod
- Storage Shelves and Counter
- Faucet
- Light
- Ventilation Fan and Heater

- Bathtub
- Bath Cover
- Reheater Port (Circulation Port)
- Bathtub Drain Opening
- Floor
- Ceiling
- Walls
- Floor Drain Trap
- Beneath the Bathtub
- Door
- Mirror
- Hand Rail, Slide Bar and Towel Rod
- Storage Shelves and Counter
- Faucet
- Light
- Ventilation Fan and Heater

Cleaning method for this location varies depending on the model. Check your model on the cover of the user's manual.

◆ Cleaning a door lower frame track and drain opening under the door (for SOLEO)

● Cleaning a folding door

Once a week 1

Open the door.



Make sure to clean.

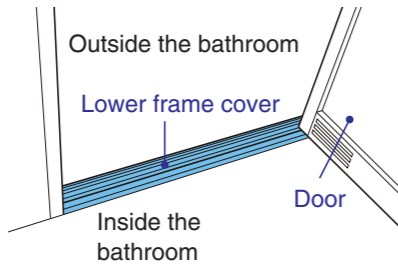

2

Remove the lower frame cover with your fingers by pulling it.

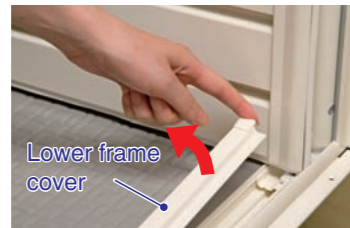

3

Remove dust from the door lower frame track and the hair catcher of the drain opening using a sponge or toothbrush.



4

Install the hair catcher.



5

Install the lower frame cover.



⚠ Warning

Do not open or close the door with the lower frame cover removed.
* Doing so could result in an injury as the door could come off.



One point tip

The part at the side of lower frame cover can slide.



* Water which enters the drain opening under the door flows through the pipe under the floor (water pan) to the drain opening under the bathtub.



● Cleaning a 3-piece sliding door

Once a week 1

Remove the door.

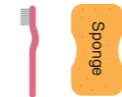

Make sure to clean.

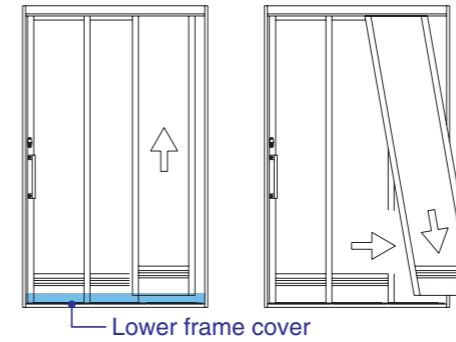

* For how to remove the door, refer to "opening and closing the 3-piece sliding door/removing the door in an emergency" in the user's manual.

2

Pinch the lower frame cover, and lift it to remove.



3

Remove dust from the door lower frame track and the hair catcher of the drain opening using a sponge or toothbrush.

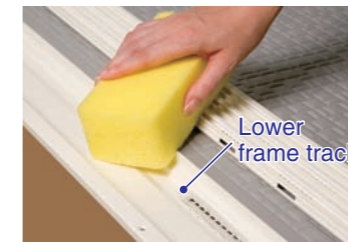

4

Install the hair catcher.

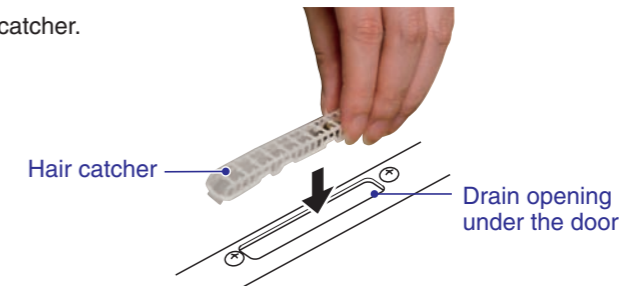

5

Install the lower frame cover and then the door.

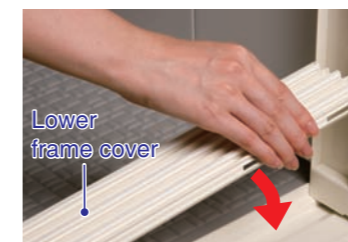

* Water which enters the drain opening under the door flows through the pipe under the floor (water pan) to the drain opening under the bathtub.

- Bathtub
- Bath Cover
- Reheater Port (Circulation Port)
- Bathtub Drain Opening
- Floor
- Ceiling
- Walls
- Floor Drain Trap
- Beneath the Bathtub
- Door
- Mirror
- Hand Rail, Slide Bar and Towel Rod
- Storage Shelves and Counter
- Faucet
- Light
- Ventilation Fan and Heater

- Bathtub
- Bath Cover
- Reheater Port (Circulation Port)
- Bathtub Drain Opening
- Floor
- Ceiling
- Walls
- Floor Drain Trap
- Beneath the Bathtub
- Door
- Mirror
- Hand Rail, Slide Bar and Towel Rod
- Storage Shelves and Counter
- Faucet
- Light
- Ventilation Fan and Heater

● Cleaning a one-way sliding door

Once a week 1 Open the door fully.

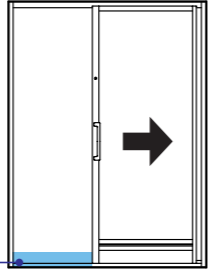

Lower frame cover

Make sure to clean.

2 Remove the lower frame cover with your fingers by pulling it.

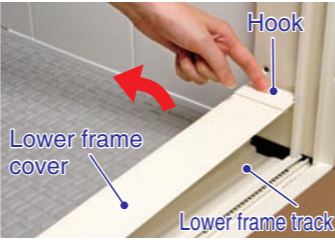

3 Remove dust from the door lower frame track and the hair catcher of the drain opening using a sponge or toothbrush.

* Water which enters the drain opening under the door flows through the pipe under the floor (water pan) to the drain opening under the bathtub.

4 Install the hair catcher.

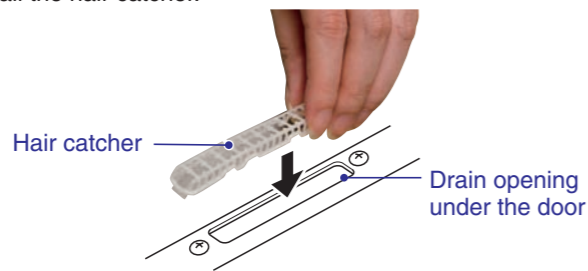

5 Install the lower frame cover.

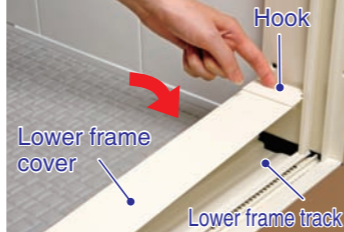

Every six months

1 Remove the door.

2 Remove the lower frame rail by pulling it. Remove dust or dirt from the lower frame rail and the lower frame.

3 Install the lower frame rail as illustrated, and then install the door.

* For how to remove the door, refer to "opening and closing the 3-piece sliding door/removing the door in an emergency" in the user's manual.

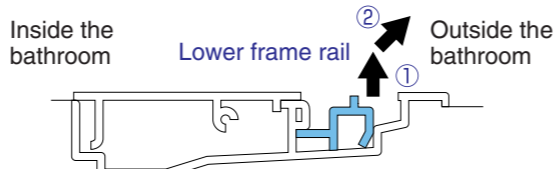
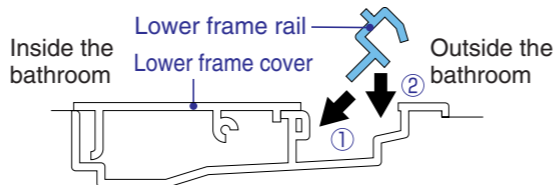
◆ Cleaning a door lower frame cover and lower frame (For the system bathroom Barrier-Free Bathroom 1116)

● Cleaning a swing door

Once a week 1 Shift the lock inward on both ends of the lower frame cover with the door open.

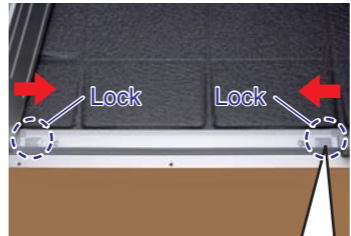

Make sure to clean.

2 Remove the lower frame cover with your fingers by pulling it on both sides of the cover. Then, remove dust from the cover and the door frame.

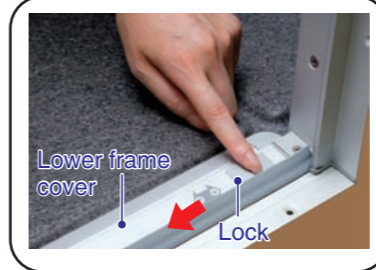

3 Install the lower frame cover and shift the locks outward.



4 Install the lower frame cover and shift the locks outward.

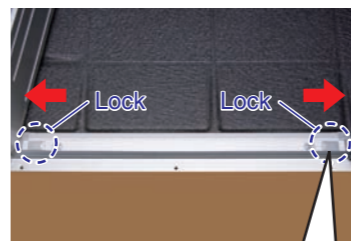

5 Install the lower frame cover and shift the locks outward.

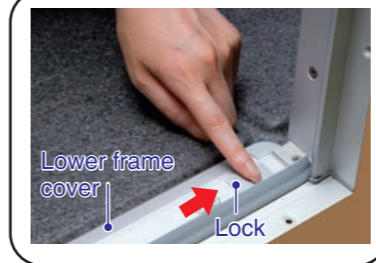

Caution

Install the lower frame cover properly.

* If the cover is unstable, there is a danger of someone tripping and being injured, or water leaking to the outside of the bathroom.

Don't forget to clean them.



* After installation, ensure that the lower frame cover is not floating or rattling.

- Bathtub
- Bath Cover
- Reheater Port (Circulation Port)
- Bathtub Drain Opening
- Floor
- Ceiling
- Walls
- Floor Drain Trap
- Beneath the Bathtub
- Door
- Mirror
- Hand Rail, Slide Bar and Towel Rod
- Storage Shelves and Counter
- Faucet
- Light
- Ventilation Fan and Heater

- Bathtub
- Bath Cover
- Reheater Port (Circulation Port)
- Bathtub Drain Opening
- Floor
- Ceiling
- Walls
- Floor Drain Trap
- Beneath the Bathtub
- Door
- Mirror
- Hand Rail, Slide Bar and Towel Rod
- Storage Shelves and Counter
- Faucet
- Light
- Ventilation Fan and Heater

●Cleaning a folding door

Once a week 1

Shift the lock inward on both ends of the lower frame cover with the door closed.



Make sure to clean.

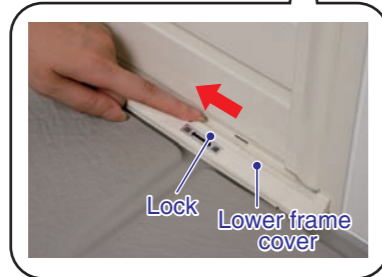
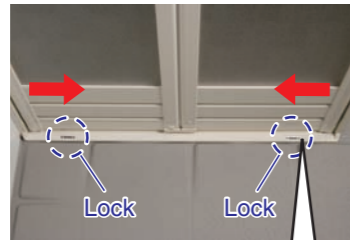

2

Remove the lower frame cover with your fingers by pulling it on both sides of the cover. Then, remove dust from the cover and the door frame.



3

After cleaning, install the lower frame cover and shift the locks outward.



Warning



Install the lower frame cover properly.
* If the cover is unstable, there is a danger of someone tripping and being injured, or water leaking to the outside of the bathroom.

* After installation, ensure that the lower frame cover is not floating or rattling.



Tips



Doesn't stainless steel rust?

Stainless steel is resistant to rust compared to iron because its surface is protected with an oxide film coating. However, even "stainless" steel could rust under certain circumstances, such as when a chlorine mold killing agent is left on or contact corrosion is untreated, where the oxide film coating is not maintained. Do not leave mold killing agent for long periods of time and wash away any remaining traces. Remove any contact corrosion immediately if found.

* For contact corrosion, refer to pages 7 and 8.

Finish off cleaning by wiping off water with a dry cloth.

11 Mirror

Once a week 1

Apply a synthetic bathroom cleaner (neutral) on the mirror, wait for two to three minutes and then softly scrub the mirror with a sponge.



2

Wash off the cleaner with water so that the cleaner does not remain.

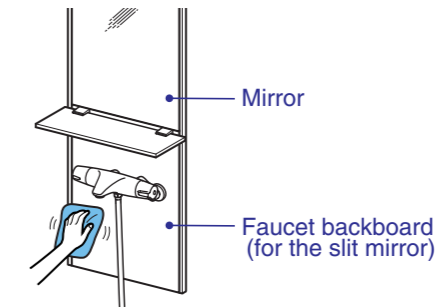

Please note

Do not use scouring powder, nylon scrubbing brushes or other such items as this could result in scratches on the mirror surface.

Please note

If mold killing agent adheres to any of the stainless steel parts (the slit mirror's faucet backboard, the large mirror's sliding bar backboard, etc.), wash it off immediately. Leaving it as is could result in discoloration.

(For the slit mirror's faucet backboard) If the faucet backboard is covered by a protective film (transparent), peel it off before use.

* Using it as is could result in water or cleaner causing the glue of the protective film to adhere permanently.

If grime became noticeable

If the grime such as water stain became too stubborn to clean with a synthetic bathroom cleaner (neutral)

1

Scrub the grime softly with bathroom cream cleanser on a sponge.



2

Wash off the cleaner with water so that the cleaner does not remain.

Please note

Do not use bathroom cream cleanser on any of the stainless steel parts (the slit mirror's faucet backboard, the large mirror's sliding bar backboard, etc.), as this could result in the shine or pattern being lost.



One point tip

Due to the influence of moisture and oxygen, black, blemish-like marks could appear on the mirror's periphery after extended use. (As the temperature in the bathroom is high, such marks could also appear on areas other than the periphery.) These black blemishes cannot be removed.

12 Hand rail, slide bar and towel rod

Once a week

Wipe off the grime softly with a dry, soft cloth.



- * Do not hit or knock with hard objects. Scratches could appear and the chrome could peel off.
- * Keep acidic, alkaline or similar type cleaners away. Failure to do so could damage the chrome.
- * If any streaks remain on the corners of the slide bar, wipe them away with a soft cloth.

If grime became noticeable

Apply diluted synthetic bathroom cleaner (neutral) to a soft cloth. Wipe off grime with the cloth and wash it off.



Slide bar

13 Storage shelves and counter

Once a week

Apply diluted synthetic bathroom cleaner (neutral) to a soft cloth. Wipe off grime with the cloth and wash it off.



Please note

Do not leave any kind of cleaner on for long periods of time. Also, wash well after the use to ensure that the cleaner is completely removed.
* Leaving cleaner on for long periods of time could cause surfaces to alter or change color.

For how to remove the shelves, refer to "Removing and installing the storage shelves" in the user's manual.

If grime became noticeable

After removing the shelves, apply diluted synthetic bathroom cleaner (neutral) to a sponge, and wipe off grime.



After washing off with water, install the shelves.

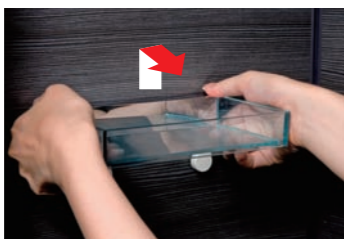

One point tip

"For the luxury storage shelves (width of 180 mm), clean the gap between the metal part and shelf with a toothbrush or similar tool.
* Do not remove the metal part.

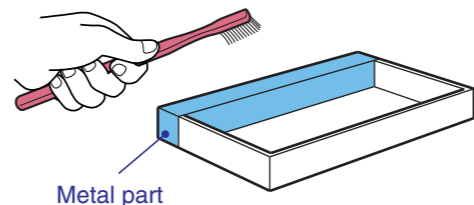

Metal part

14 Faucet

Once a week

1 Apply a synthetic bathroom cleaner (neutral) on the faucet, wait for two to three minutes and then softly scrub the spot with a sponge.



2 Wash off the cleaner with water so that the cleaner does not remain.



Caution

! If there are scratches on the metal-type shower head, request repair or replacement (See P.46)
* Using it as is could result in an injury.

Please note

Do not use melamine foam (See P.8) on the printed parts of the faucet's metal fittings (such as the temperature display or switch display).
* Doing so could cause the printing on the temperature indicator, etc. to disappear.

* For push-type faucets, lock the button before cleaning.
(Refer to the user's manual for details.)

Once a month

If the grime such as water stain became too stubborn to clean with a synthetic bathroom cleaner (neutral)



1 Scrub the grime softly with bathroom cream cleanser on a sponge.

2 Wash off the cleaner with water so that the cleaner does not remain.



Tips

Is it ok to use baking soda or vinegar (citric acid)?

In magazines and such, baking soda and vinegar (citric acid) have been introduced as environmentally-friendly cleaners. Actually, some of these could damage the bathroom. Be careful when using such products for cleaning purposes.

●Baking Soda

When melted in water, baking soda forms a mild alkaline which neutralizes acidic stains (natural oils, hot water stains, etc.) and uses negative ions to make dirt easier to remove.

★ Usage method (example)

Mix one part water with two to three parts baking soda to form a paste that can be used in place of cream cleanser. Or, mix 200 ml of water with one tablespoon of baking soda to use in place of synthetic bathroom cleaner. Wash off thoroughly after use.

●Vinegar/Citric Acid

Vinegar and citric acid are mildly acidic and can be used to neutralizes alkaline stains (soap residue, water stains, etc.). It is also said that they are effective in suppressing bad smells and the growth of bacteria.

* Do not use fruit vinegars or vinegars that contain sugar or Japanese sweet rice wine such as flavored vinegars and sushi vinegar.

★ Usage method (citric acid) (example)

Mix 200 ml of water with one teaspoon of citric acid to use in place of synthetic bathroom cleaner. Wash off thoroughly after use.



●Be careful!

- Do not use on the bathtub, floor, aluminum or other metal and chrome parts. Also, even for other parts, be careful to wash away after use and do not leave on for long periods of time. (Otherwise, color changes and rusting could result.)
- Before using baking soda, vinegar or citric acid, test on an inconspicuous part of the bathroom for color changes and other negative effects.
- As handling baking soda with bare hands could result in skin irritation, wear rubber gloves when using.

- Bathtub
- Bath Cover
- Reheater Port (Circulation Port)
- Bathtub Drain Opening
- Floor
- Ceiling
- Walls
- Floor Drain Trap
- Beneath the Bathtub
- Door
- Mirror
- Hand Rail, Slide Bar and Towel Rod
- Storage Shelves and Counter
- Faucet
- Light
- Ventilation Fan and Heater

Clean the flow control unit, spray plate and strainer when water flow from the spout or shower seems weak.

* If the flow control unit, spray plate or strainer become clogged with dirt, the equipment performance could be deteriorated.

◆ Cleaning a flow control unit

Every
Six Months

Remove the flow control unit by turning the cap by hand. Remove the dirt from the flow control mesh, and wash it with water.

* Some flow control units cannot be removed from the faucet.

Make sure to clean.

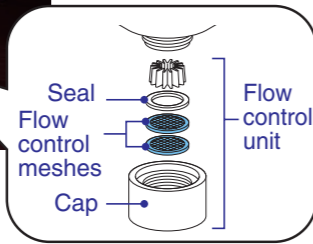
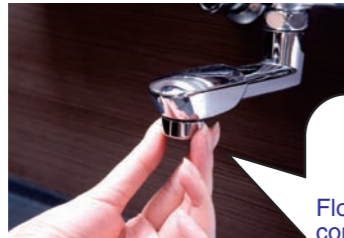

* For Jeweller (the faucet on the bathtub), refer to the user's manual.

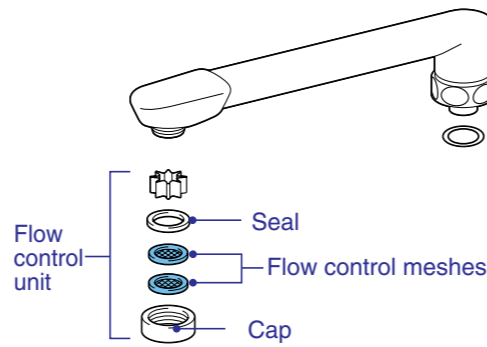

◆ Cleaning a shower spray plate

For details, refer to the shower user's manual.

● When the spray plate can be removed

If **water flow** from **shower** becomes **weak**

Remove the spray plate. Rinse the plate in a bucket with water.

How to remove and install the spray plate

Turn the plate counter-clockwise to remove it. If it is hard to hold the plate, turn the plate while pushing.



* Do not remove the shower head and shower hose with the shower with the switch.

Make sure to clean.

For the metallic spray shower (when the plate is hard to hold)



After cleaning the spray plate, install the mesh metal and spray plate.

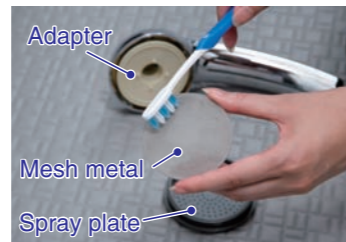

* Install the mesh metal in the proper direction.

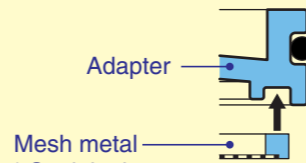

* Set it in the proper direction.

● When the spray plate cannot be removed

If **water flow** from **shower** becomes **weak**

Remove the dirt from the plate using a toothbrush, wire or similar tool.

Shower panel (for body shower)



* Some shower heads have a mesh metal inside. When cleaning the shower head using a wire or sharp-pointed object, be careful not to make a hole on it.

* For the Shower Panel or Shower de Bath, refer to the respective user's manual.

Make sure to clean.

◆ Cleaning a strainer

In the following example, the SSU type counter-integral faucet is being cleaned. For other type of faucets, refer to the respective user's manual.



One point tip

In some cases, the dust in the pipe could flow out when the water shutoff valve is opened or closed, resulting in clogging of the strainer. Before putting back the strainer, slightly open the water shutoff valve to let out the dust and then close the valve. The strainer is used to remove the dust inside the pipe.

● Cleaning a SSU type counter-integral faucet

If **water flow** becomes **weak**

Make sure to clean.

1 Remove the fixing screws (two places) from the counter lower cover using a Phillips screwdriver.

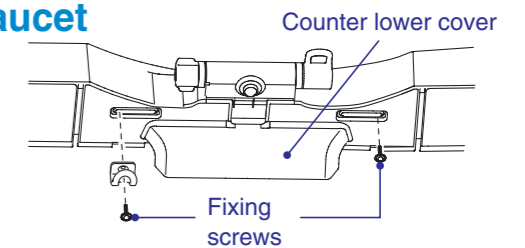

2 Slightly lower the front part of the counter lower cover, and pull it to the front to remove.



3 Using a slotted screwdriver or similar tool, turn the flow adjustment plug for both hot water (on the left) and cold water (on the right) clockwise fully.

4 Turn the shower/bath select or handle to the spout side (lower side).
* Check that the water is shut off.

5 Using a large size slotted screwdriver, turn the strainer holder counter-clockwise to remove it.

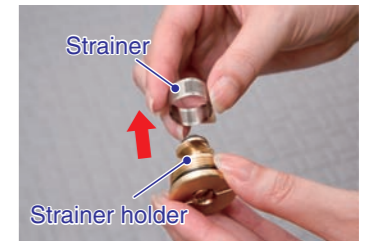
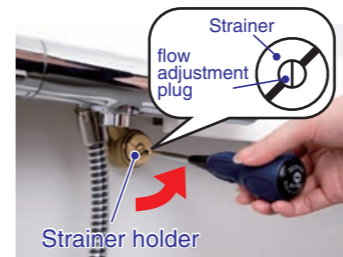

6 Remove the strainer, and remove the dirt from it.



* Clean the strainer on both hot water and cold water sides.

7 Install the strainer in the reverse manner of the removal. Open the flow adjustment plug to the original position.

Bathtub

Bath Cover

Reheater Port (Circulation Port)

Bathtub Drain Opening

Floor

Ceiling

Walls

Floor Drain Trap

Beneath the Bathtub

Door

Mirror

Hand Rail, Slide Bar and Towel Rod

Storage Shelves and Counter

Faucet

Light

Ventilation Fan and Heater

Bathtub

Bath Cover

Reheater Port (Circulation Port)

Bathtub Drain Opening

Floor

Ceiling

Walls

Floor Drain Trap

Beneath the Bathtub

Door

Mirror

Hand Rail, Slide Bar and Towel Rod

Storage Shelves and Counter

Faucet

Light

Ventilation Fan and Heater

15 Light

Warning

- Do not attempt to disassemble or modify the light fixture.
 - * Doing so could cause electric shock, fire, short circuit or breakdown.
- Be sure to use light bulbs of the specified type and watts.
 - * Failure to do so could cause fire.
- Always replace light bulbs with the power switch turned off.
 - * There is a danger of electric shock or short circuit.

- Do not use a light with a light cover or globe removed or damaged.
 - * There is a danger of electric shock, or the bulb could break, resulting in an injury.
- Securely install parts such as a bulb, rubber seal, cap, etc.
 - * Improper installation could cause electric shock, injury, breakdown or malfunction.

Caution

- Replacing a light bulb is performed in a high place. Take adequate precautions of the place you are standing on. Do not do this work by standing on the bathtub or counter.
 - * There is a danger of injury.
- Do not replace a light bulb immediately after it burns out.
 - * There is a danger of burn as the fixture and light bulb could be hot.
- Install a light cover or globe securely.
 - * Failure to do so could cause falling of a cover or globe, resulting in an injury.

- Do not apply excessive force or shock to a socket.
 - * Doing so could cause electric shock, breakdown, or malfunction.
- Do not clean inside a socket with a cloth, or insert your finger into a socket.
 - * Doing so could cause electric shock or malfunction.

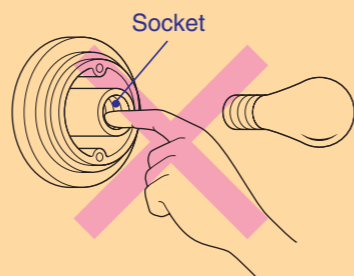

If grime became noticeable

1 Wipe off the dirt on a light cover or globe with a soft cloth or sponge applied with diluted synthetic bathroom cleaner (neutral).



2 Wipe off the cleaner thoroughly with a wet cloth so that the cleaner does not remain.

* Do not hit the globe with something hard or to other objects. Doing so could damage the globe.



Replacing a light bulb

If the light does not come on, the bulb could be burned out. Turn off the power switch, then replace the bulb in the following procedure. If the light does not come on even after it has been replaced, contact the dealer where you purchased the bath system.

In the following example, the incandescent bulb in the wall-mounted light is being replaced. For other type of flights, refer to the user's manual of the system bathroom.

How to replace an incandescent bulb in the wall-mounted light

* This is for the cylindrical light, indirect light, and square light. For the flat light and slice light, refer to the user's manual of the system bathroom.

- 1** Turn off the light switch, then wait until the fixture and bulb are sufficiently cool.
- 2** Turn the globe counter-clockwise to remove it.
- 3** Remove the bulb, and replace it with a new one (incandescent bulb).
- 4** Turn the globe clockwise to securely install it.
- 5** Turn the light switch on and check if the light comes on.

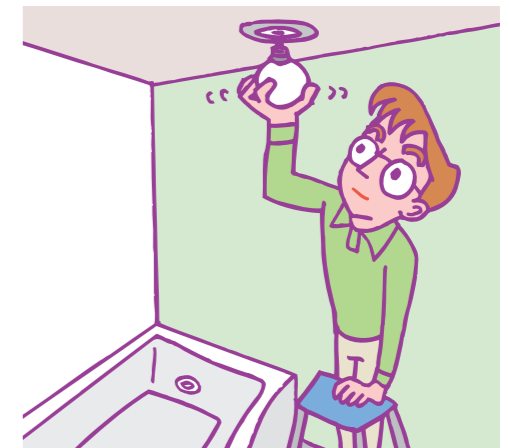
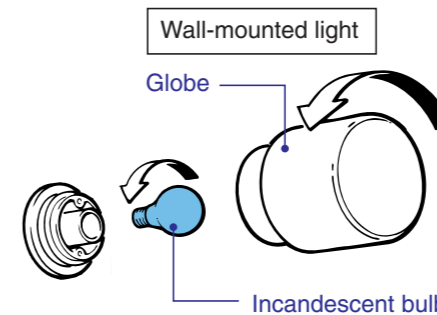

Warning

Do not use a bulb other than specified such as a reflector bulb, etc. Be sure to check the instructions on the body package. * Failure to do so could cause fire.

Bulb	Bulb product no.
Silica light bulb 60W-type 54W	LW100V54W

* In some cases, the appropriate bulb could vary from the above. For the details, refer to the User's Manual of the system bathroom.

- Bathtub
- Bath Cover
- Reheater Port (Circulation Port)
- Bathtub Drain Opening
- Floor
- Ceiling
- Walls
- Floor Drain Trap
- Beneath the Bathtub
- Door
- Mirror
- Hand Rail, Slide Bar and Towel Rod
- Storage Shelves and Counter
- Faucet
- Light
- Ventilation Fan and Heater

- Bathtub
- Bath Cover
- Reheater Port (Circulation Port)
- Bathtub Drain Opening
- Floor
- Ceiling
- Walls
- Floor Drain Trap
- Beneath the Bathtub
- Door
- Mirror
- Hand Rail, Slide Bar and Towel Rod
- Storage Shelves and Counter
- Faucet
- Light
- Ventilation Fan and Heater

16 Ventilation fan and heater

* The shape of ventilation fan and heater could vary depending on the product. The typical cleaning method is explained in the following pages. For details, refer to the user's manual attached with each product.
 * For the products other than the our products, refer to the user's manual attached with the product.

Warning

 Persons other than repair technicians should not attempt to disassemble, repair or modify this equipment in any way.
 * There is a danger of fire or mechanical abnormality that could cause an injury.

 Be sure to turn the power off before cleaning the ventilation fan or heater.
 * There is a danger of electric shock or injury.

Caution

 Do not splash water or apply mold killing agent directly on the ventilation fan or heater.
 * There is a danger of product breakage or current leakage.

 Install the louver and air filter completely.
 * Failure to do so could cause the louver or air filter to fall off, resulting in an injury.



 The operation is performed in a high place. Watch your step. Dust could fall on your head. Do not do this work by standing on the bathtub or counter.
 * There is a danger of falling and injury.

 Do not touch the heater right away after stopping operation.
 * There is a danger of burn.



 Wear rubber gloves when cleaning the louver.
 * There is a danger of injury.



Cleaning a ventilation fan

If a different company's equipment is installed, read the user's manual attached with the product thoroughly and follow the given cleaning instruction.

Once a month



1 After turning off the power (breaker on the distribution board), remove the front cover of the ventilation fan.

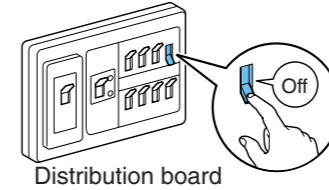

Warning

 Do not apply excessive force to the mechanical parts such as the blade inside the body.
 * Doing so could cause earth leakage or malfunction.



Pull down the front cover, and remove the cover while pinching the springs.

2 Wipe off dirt on the front cover softly with a cloth wrung out with hot water.



3 Wipe off dirt on the body softly with a wrung out cloth applied with appropriately diluted synthetic bathroom cleaner (neutral).
 After that, wipe off the body with a dry cloth so that no cleaner remains.



* When dirt or duct is accumulated on the blade, use a fine brush to remove them. (Be careful not to apply force to the parts such as the blade.)

4 While pinching the springs of the front cover, insert the spring to the spring insertion part, and then push the front cover up to install it.

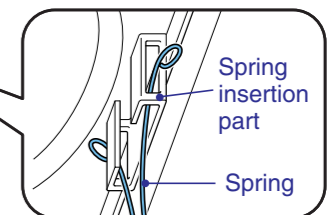
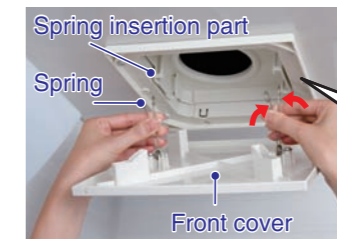

If grime became noticeable



1 Stop the operation, and remove the front cover.

2 Wipe off the dirt on the cover softly with a soft cloth or sponge applied with diluted synthetic bathroom cleaner (neutral).

3 Wipe off the cleaner with a damp cloth.

4 Install the front cover back to the original position.



* Securely install the front cover.

- Bathtub
- Bath Cover
- Reheater Port (Circulation Port)
- Bathtub Drain Opening
- Floor
- Ceiling
- Walls
- Floor Drain Trap
- Beneath the Bathtub
- Door
- Mirror
- Hand Rail, Slide Bar and Towel Rod
- Storage Shelves and Counter
- Faucet
- Light
- Ventilation Fan and Heater

- Bathtub
- Bath Cover
- Reheater Port (Circulation Port)
- Bathtub Drain Opening
- Floor
- Ceiling
- Walls
- Floor Drain Trap
- Beneath the Bathtub
- Door
- Mirror
- Hand Rail, Slide Bar and Towel Rod
- Storage Shelves and Counter
- Faucet
- Light
- Ventilation Fan and Heater

◆ Cleaning a ventilator/dehumidifier/heater and lavatory heater

If a different company's equipment is installed, read the user's manual attached with the product thoroughly and follow the given cleaning instruction.

* Accumulated dirt and dust on the front cover or filter could deteriorate the equipment performance.

Once a month

1 Stop the operation, then wait until the area around the intake and output vents get cool sufficiently.



Make sure to clean.

2 Pull the filter grip to remove the filter.

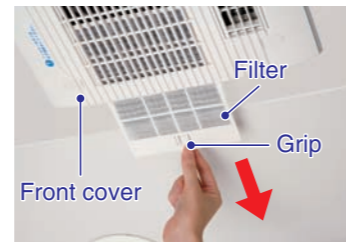
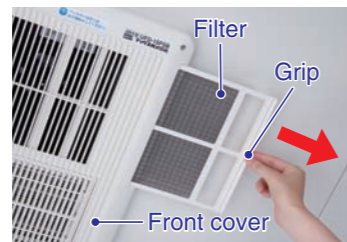

3 Vacuum dust on the filter with a vacuum cleaner.

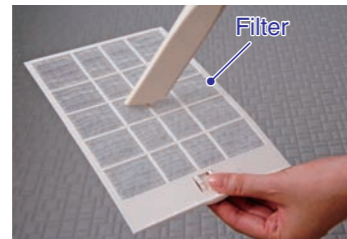

4 Wipe off dirt on the front cover and remote control softly with a cloth wrung out with hot water.



5 Install the filter in its original position.

● Cleaning a sub intake grille (for the 3-room ventilator/dehumidifier/heater)

Once a month

1 Slowly remove the sub intake grille with both hands, and remove the filter.



Make sure to clean.



2 Vacuum dust on the filter with a vacuum cleaner. Wipe off dirt on the sub intake grille softly with a cloth wrung out with hot water.

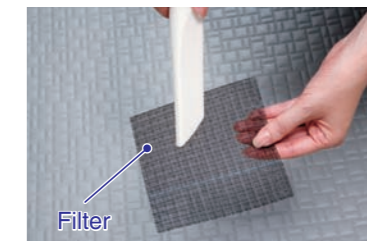

3 Set the filter in the sub intake grille, and attach the sub intake grille.

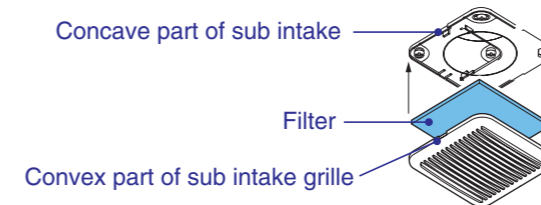

Install in a direction so that the concave part of the sub intake aligns with the convex part of the sub intake grille front to which the filter is set.

If grime became noticeable



1 Stop the operation, then wait until the area around the intake and output vents get cool sufficiently.

2 Pull the filter grip to remove the filter.

3 Dip the filter in the water with diluted synthetic bathroom cleaner (neutral), and rinse it softly.

4 Wipe off dirt on the front cover and remote control softly with a wrung out cloth applied with appropriately diluted synthetic bathroom cleaner (neutral).

5 Wipe off the filter, front cover and remote control with a set cloth so that no cleaner remains.

6 Install the filter in its original position.

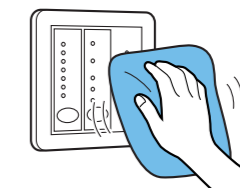
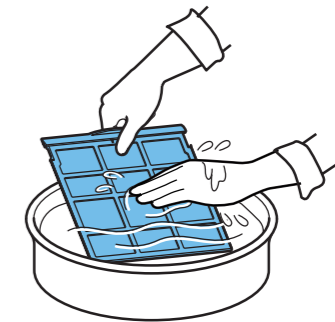

- Bathtub
- Bath Cover
- Reheater Port (Circulation Port)
- Bathtub Drain Opening
- Floor
- Ceiling
- Walls
- Floor Drain Trap
- Beneath the Bathtub
- Door
- Mirror
- Hand Rail, Slide Bar and Towel Rod
- Storage Shelves and Counter
- Faucet
- Light
- Ventilation Fan and Heater

- Bathtub
- Bath Cover
- Reheater Port (Circulation Port)
- Bathtub Drain Opening
- Floor
- Ceiling
- Walls
- Floor Drain Trap
- Beneath the Bathtub
- Door
- Mirror
- Hand Rail, Slide Bar and Towel Rod
- Storage Shelves and Counter
- Faucet
- Light
- Ventilation Fan and Heater

Also see the "Frequently asked questions" in the user's manual.

Reheater port		Reference page
Q Water won't get hot enough. (It takes a long time.)	A Check if the circulation port is not clogged. ▶ Clean the filter in the circulation port.	P14
Q The heated water temperature will not reach the set temperature.	A Check if the circulation port cover is properly fixed. ▶ Fix the circulation port cover in the proper position.	P14
Bathtub drain opening		Reference page
Q Bathtub won't fill up. (Bathwater has decreased by the next morning.)	A Check if the drain plug and drain core are properly set. ▶ Set the drain plug and drain core properly.	P15 ~P16
	A (One-way push drain plug)The drain plug (sealing plug) is set at an angle. ▶ (One-way push drain plug) Remove drain plug (sealing plug) and refit until it clicks.	P15 ~P16
Q Takes a long time to drain.	A Check if dirt is accumulated in the drain plug or drain core. ▶ Clean the drain plug and drain core.	P15 ~P16
Q The one-way push drain plug doesn't work well.	A Check if dirt sticks to or is accumulated to the push button of the one-way push drain plug. ▶ Clean to the push button of the one-way push drain plug.	P16
Floor		Reference page
Q Some water will remain in some areas on the floor.	A There is a possibility that dirt sticks to the floor. ▶ When it is caused due to the mosaic pattern, clean the floor. In other cases, wipe off the large water drops.	P17
Q Black, blemish-like marks appear around the corners of the floor and seem to be hard to remove with cleaner.	A (Mosaic pattern)There is a possibility that the dirt has stuck to the floor. ▶ Clean the corners by raking grimes out with a split-end type bathroom brush.	P17
Floor drain trap		Reference page
Q It takes time that water drains out from the washing area floor.	A Check if the drain trap or hair catcher is not clogged. ▶ Clean the drain trap or hair catcher.	P20 ~P23
	A Check if the water-passage pipe or seal-water cylinder is fitted or that dirt adheres to it. ▶ Set the water-passage pipe and seal-water cylinder correctly, or clean them.	P20 ~P23
Q Bad odors come from the drain trap.	A Check if dirt or dust is accumulated in the drain trap. ▶ Remove the dirt inside the drain trap, and clean it if it is dirty.	P20 ~P23
Q When water drains out of the bathtub, a gurgling sound is emitted.	A This is a temporary sound resulting from the water flowing. ▶ This is not a malfunction.	P20

Door		Reference page
Q The door cannot be closed.	A Check if the lower frame cover is properly installed. ▶ Install the lower frame cover properly.	P30 ~P35
Q Water leaks into the changing room side through the bottom of the door frame.	A Check if there is some dirt or hair in the hair catcher on the door lower drain opening and lower frame track. ▶ Clean the hair catcher on the door lower drain opening and lower frame track	P31 ~P33
Faucet		Reference page
Q Water flow is weak.	A Check if dirt is accumulated in the strainer. ▶ Clean the strainer.	P40
Q Water flow temperature cannot be adjusted properly.	A Check if dirt is accumulated in the strainer. ▶ Clean the strainer.	P40
Shower		Reference page
Q Water flow is weak.	A Check if the spray plate holes of the shower head are not clogged. ▶ Clean the spray plate.	P39
Light		Reference page
Q The light does not come on.	A Check if the bulb is securely inserted into the socket. ▶ Securely install the bulb into the socket.	P42
	A The bulb life could have expired. ▶ Change the bulb.	P42
Ventilation fan		Reference page
Q The ventilation front cover is likely to come off.	A Check if the front cover is properly installed. ▶ Install the front cover properly.	P44 ~P46
Q There is an abnormal sound or vibration.	A Check if the ventilation fan or the front cover is properly installed. ▶ Install the front cover properly. If the ventilation fan rattles, request repair.	P44 ~P46

If the action on the left and above does not work, please contact us or request us to repair. (See "When requesting repairs" on page 50.)



Where to ask concerning product use, cleaning methods, etc. and about products

Contact the customer consultation center.

Customer Consultation Center

TEL ☎ 0120-1794-00

FAX ☎ 0120-1794-30

Hours Weekdays

9:00 to 18:00

Saturdays, Sundays, Holidays

9:00 to 17:00

(Excluding summer vacation and the year end/new year vacation)

Request Repair under the Following Circumstances.

Part	Problem	How to check and respond	Where to contact
Drain plug	Bathtub won't fill up even though the drain plug and drain core are correctly installed. (Bathwater has decreased by the next morning.)	Replace the rubber plug or one-way push drain plug (sealing plug). → Refer to the "Replacement parts guide" in the user's manual.	The dealer * The delivery service by INAX Maintenance Co., Ltd. is also available.
	The attachment for the rubber plug's chain has come off.	Discontinue use and request repair. * If untreated, it could cause water leakage .	The dealer or INAX Maintenance Co., Ltd.
Walls, ceiling, floor	Silicon part is split or stripped.	Discontinue use and request repair. * If untreated, it could cause water leakage, resulting in getting the household goods, etc. wet .	The dealer or INAX Maintenance Co., Ltd.
Tiles on walls and floor	The tile is broken, chipped or cracked.	Discontinue use and request repair. * If untreated, it could cause an injury .	The dealer or INAX Maintenance Co., Ltd.
Door	The transparent face of the door is broken.	Discontinue use and request repair. * If untreated, water could leak to outside the bathroom, resulting in getting the household goods, etc. wet .	The dealer or INAX Maintenance Co., Ltd.
	The door will not open or close even though it is not locked.	Request repair.	
	The hair catcher on the drain opening under the door is lost.	Ask for a hair catcher on the drain opening under the door. → Refer to the "Replacement parts guide" in the user's manual.	The dealer * The delivery service by INAX Maintenance Co., Ltd. is also available.
Accessories	The mirror has broken.	Discontinue use and request repair. * If untreated, it could cause an injury .	The dealer or INAX Maintenance Co., Ltd.
	The hand rail, shower hook, or towel rod is loose.	Discontinue use and request repair. * If untreated, it could cause water leakage, resulting in getting the household goods, etc. wet or an injury .	
Faucet	Water keeps dripping from the spout even the handle is turned.	Discontinue use and request repair.	The dealer or INAX Maintenance Co., Ltd.
Light	The cover, globe or body of the light is broken or changed in shape.	Discontinue use and request repair. * If untreated, it could cause an electric shock or malfunction.	The dealer or INAX Maintenance Co., Ltd.
	The light flickers.		
Ventilation fan and heater	There is a vibration, abnormal noise, or abnormal odor (burnt odor).	Immediately push the stop button to stop the operation and turn the breaker on the distribution panel off , then request repair. (For details, refer to the user's manual attached to the respective equipment.) * If untreated, it could cause fire, electric shock , or an injury .	(For the ventilation fan) The dealer or INAX Maintenance Co., Ltd. (For the heater) The heater manufacturer for the respective product * See the heater user's manual.
	There is an abnormality with the ventilation fan or heater.		

Warning

! If there is an abnormal odor or noise around the bathroom, turn off the switch of the electric equipment and the no fuse breaker of the distribution board. Then, request repair immediately.
* If you continue to use the equipment as it is, it could cause fire or earth leakage.

! If the breaker of the distribution board which is connected to the electrical equipment in the bathroom is activated, stop use and request repair immediately.
* There is a possibility that the electric equipment in the bathroom has some abnormality. If you continue to use the equipment by turning the activated breaker on again, severe malfunction could occur including fire or earth leakage.

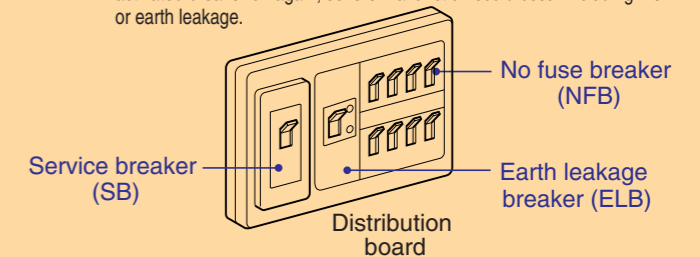
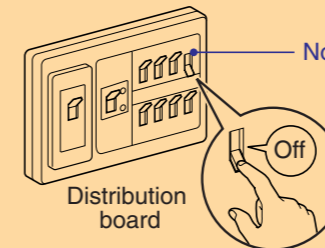

When requesting repairs

Before you request repairs, read through this manual and the user's manual again. If you still have the problem after performing indicated methods, ask the dealer where you purchased the product or INAX Maintenance Co., Ltd. to carry out repairs.

Repairs during the warranty period

During the warranty period, repairs will be performed in accordance with the provisions in the warranty included in the User's Manual.

Repairs after the warranty period has expired

If the product's function can be maintained by repairing, we perform repairs with charge by the customer's request. Repair charges will include technical fees, travel expenses and parts costs.

Required information when requesting repairs

- Your name, address and telephone number
- The product name, product No. ← Refer to "How to read part numbers" inside the cover page in the user's manual.
- The number on the control number sticker ← Refer to "How to find product number" inside the cover page in the user's manual.
- The installation date
- The content of the trouble, the abnormal condition (as detailed as possible) ← See "Troubleshooting" on page 47.
- The date you want the repair man to come
* It is recommended to take a memo for necessities before contact.

Where to request repairs, and where to ask questions concerning after-sales service

Contact the dealer where you purchased the system bathroom, or INAX Maintenance Co., Ltd.

- Dealer where you purchased the product
- INAX Maintenance Co., Ltd. Repair Reception Center Requests for repair accepted 365 days a year

TEL ☎ 0120-1794-11 Hours: 9:00 to 20:00

FAX ☎ 0120-1794-56

Home page address: <http://www.i-mate.co.jp>

How to purchase replacement parts

Specify the name and part No. of the replacement part. * For details, refer to "Replacement parts guide" in the user's manual.

- When purchasing parts from a dealer, etc.
Purchase from a dealer that sells our products.
- When using the home delivery service
Your orders will be received by the home delivery service of INAX Maintenance Co., Ltd. (Payment of separate shipping charges is necessary.)

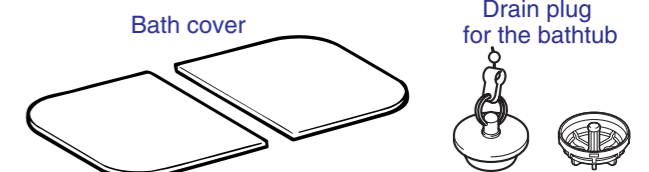

TEL ☎ 0120-00-1794 Hours: 9:00 to 17:00 (except Saturdays, Sundays and holidays)

* For the required part no. or other inquiries, contact Customer Consultation Center indicated on the back cover.