

visual engineering **LIGHTWARE**

DVI-TP-TX200DL DVI-TP-RX100DL

User's Manual



SAFETY INSTRUCTIONS

Class II apparatus construction.

This equipment should be operated only from the power source indicated on the product.

To disconnect the equipment safely from power, remove the power cord from the rear of the equipment, or from the power source. The MAINS plug is used as the disconnect device, the disconnect device shall remain readily operable.

There are no user-serviceable parts inside of the unit. Removal of the top cover will expose dangerous voltages. To avoid personal injury, do not remove the top cover. Do not operate the unit without the cover installed.

The apparatus shall not be exposed to dripping or splashing and that no objects filled with liquids, such as vases, shall be placed on the apparatus.

The apparatus must be safely connected to multimedia systems. Follow instructions described in this manual.

WEEE (Waste Electrical & Electronic Equipment)

Correct Disposal of This Product



This marking shown on the product or its literature, indicates that it should not be disposed with other household wastes at the end of its working life. To prevent possible harm to the environment or human health from uncontrolled waste disposal, please separate this from other types of wastes and recycle it responsibly to promote the sustainable reuse of material resources.

Household users should contact either the retailer where they purchased this product, or their local government office, for details of where and how they can take this item for environmentally safe recycling.

Business users should contact their supplier and check the terms and conditions of the purchase contract. This product should not be mixed with other commercial wastes for disposal.

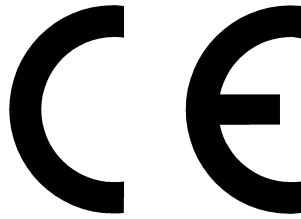

DECLARATION OF CONFORMITY

We,

Lightware Kft. 1071 Budapest Peterdy str. 15 HUNGARY

as manufacturer declare, that the products

DVI-TP-TX200DL
DVI-TP-RX100DL
(Computer Monitor Extender)

in accordance with the EMC Directive 2004/108/EC and the Low Voltage Directive 2006/95/EEC is in conformity with the following standards:

EMI/EMC EN 55022 Class B
Safety..... UL, CUL, GS, CR, RCM, PSE, Class II

Date: 01 December 2009

Name: Gergely Vida (Managing Director)

Signed:

Table of contents

1.	INTRODUCTION	6
2.	GENERAL DESCRIPTION.....	6
2.1.	BOX CONTENTS	6
2.2.	TRANSMITTER FEATURES (DVI-TP-TX200DL)	6
2.3.	RECEIVER FEATURES (DVI-TP-RX100DL).....	7
2.4.	UNDERSTANDING EDID	8
2.4.1.	Basics	8
2.4.2.	Common problems related to EDID	8
2.5.	ADVANCED EDID MANAGEMENT (DVI-TP-TX200DL)	9
2.6.	TMD5 RELOCKING (DVI-TP-RX100DL).....	9
2.7.	DUAL LINK DVI SIGNAL.....	10
2.8.	FIBER CABLE POWERING.....	11
2.9.	APPLICATIONS.....	12
2.10.	FRONT AND REAR VIEW	13
2.10.1.	Front view of DVI-TP-TX200DL	13
2.10.2.	Rear view of DVI-TP-TX200DL	14
2.10.3.	Front view of DVI-TP-RX100DL.....	15
2.10.4.	Rear view of DVI-TP-RX100DL.....	16
2.11.	ELECTRICAL CONNECTIONS.....	17
2.11.1.	DVI inputs and outputs.....	17
2.11.2.	CATx inputs and outputs.....	17
3.	OPERATION OF DVI-TP-TX200DL	18
3.1.	POWER.....	18
3.2.	LEARNING THE EDID	18
3.3.	SWITCHING THE EDID	19
3.4.	FACTORY PRESET EDID LIST	19
4.	OPERATION OF DVI-TP-RX100DL	20
4.1.	POWER.....	20
4.2.	ADJUSTING THE INPUT EQUALIZATION	20
4.3.	MAXIMUM TWISTED PAIR DISTANCES	21
5.	TROUBLESHOOTING	21
5.1.	THERE IS NO PICTURE.....	21
6.	MECHANICAL DRAWINGS	23
6.1.	DVI-TP-TX200DL	23
6.1.1.	Top view	23
6.1.2.	Front view (controls and input).....	23
6.1.3.	Rear view (outputs and power)	24
6.1.4.	Bottom view.....	24
6.2.	DVI-TP-RX100DL.....	25
6.2.1.	Top view	25
6.2.2.	Front view (controls).....	25
6.2.3.	Rear view (inputs, output and power)	26
6.2.1.	Bottom view.....	26
7.	WARRANTY	27
8.	SPECIFICATIONS.....	28

1. Introduction

Dear Customer,

Thank you for choosing Lightware DVI-TP series transmitters and receivers. DVI-TP-TX200DL and DVI-TP-RX100DL are Dual Link DVI over Twisted Pair extenders which allow video signals of up to 3840x2400@30Hz resolution to be transmitted through 50 meters of high quality CAT7 cables.

2. General description

2.1. Box contents

- DVI-TP-TX200DL or DVI-TP-RX100DL
- User's manual
- Quick Start Guide
- +5V wall plug universal AC power adaptor

2.2. Transmitter features (DVI-TP-TX200DL)

- **Advanced EDID Management** – The user can emulate any EDID on the DVI-TP-TX200DL's input, read out and store any monitor's EDID (attached to Monitor Output) in 49 internal memory locations. Green and red EDID status LEDs show whether a valid address is selected.
- **Supports highest resolutions** – 2048x1536p 60 Hz, 2560x1600p 60 Hz, and 3840x2400p 30 Hz are supported including all standard HDTV resolutions (720p, 1080i, 1080p). Unencrypted signals up to 330 MHz pixel clock frequency (up to 165 MHz TMDS clock frequency) regardless of the resolution are passed through.
- **Source and Monitor Connected LEDs** – Two LEDs indicate when a DVI source and display device is connected to the DVI-TP-TX200DL: the source is sending +5V signal and the display is sending Hot Plug signal.
- **Local Monitor Output** – The user can attach a local monitor with a dual link DVI cable to observe the video signal sent through the CATx cables. The resolution and clock frequency are the same on DVI and RJ45 connectors, no internal scaling or conversion is applied.
- **Front panel control** – EDID Address selection with two decimal rotary switches and Learn EDID button are available for Advanced EDID Management.
- **Fiber cable support** – Self powered DVI fiber cables or converters using +5V from DVI sources (VGA cards, etc.) usually consume more than 55 mA, which load is the maximum allowed by DVI 1.0 standard. DVI-TP-TX200DL supports +5V/500 mA constant current output on MONITOR OUTPUT to power long distance fiber optical transmitters.
- **Universal power adaptor** – DVI-TP-TX200DL is equipped with a universal +5V power adaptor, which accepts AC voltages from 100 to 240 Volts with 50 or 60 Hz line frequency.

2.3. Receiver features (DVI-TP-RX100DL)

- **Input Equalization** – Both CATx inputs are compensated for up to 40 dB high frequency cable loss. Automatic and user adjustable modes are available to allow for precise setting of equalization.
- **TMDS reclocking** – (removes jitter caused by long cables) the DVI OUTPUT has a clean, jitter free signal, eliminating signal instability and distortion caused by long cable or connector reflections.
- **Signal Present and Monitor Connected LEDs** – Two LEDs indicate when a valid DVI signal is detected and when a display device is connected and it is sending a Hot Plug signal.
- **Supports highest resolutions** – 2048x1536p 60 Hz, 2560x1600p 60 Hz, and 3840x2400p 30 Hz are supported including all standard HDTV resolutions (720p, 1080i, 1080p). Unencrypted signals up to 330 MHz pixel clock frequency (up to 165 MHz TMDS clock frequency) regardless of the resolution are passed through.
- **Front panel control** – EQ mode selection button and 25-turn potentiometer are available for precise equalization setting. Red and green LEDs on the front panel indicate the actually selected EQ mode.
- **Fiber cable support** – Self powered DVI fiber cables using +5V from DVI sources (VGA cards, etc.) usually consume more than 55 mA, which load is the maximum allowed by DVI 1.0 standard. DVI-TP-RX100DL supports +5V 500 mA constant current output on DVI OUTPUT to power long distance fiber optical transmitters.
- **Universal power adaptor** – DVI-TP-RX100DL is equipped with a universal +5V power adaptor, which accepts AC voltages from 100 to 240 Volts with 50 or 60 Hz line frequency.

2.4. Understanding EDID

2.4.1. Basics

EDID stands for Extended Display Identification Data. Simply put, EDID is the passport of display devices (monitors, TV sets, projectors). It contains information about the display's capabilities, such as supported resolutions, refresh rates (these are called Detailed Timings), the type and manufacturer of the display device, etc.

After connecting a DVI source to a DVI display, the source reads out the EDID to determine the resolution and refresh rate of the image to be transmitted.

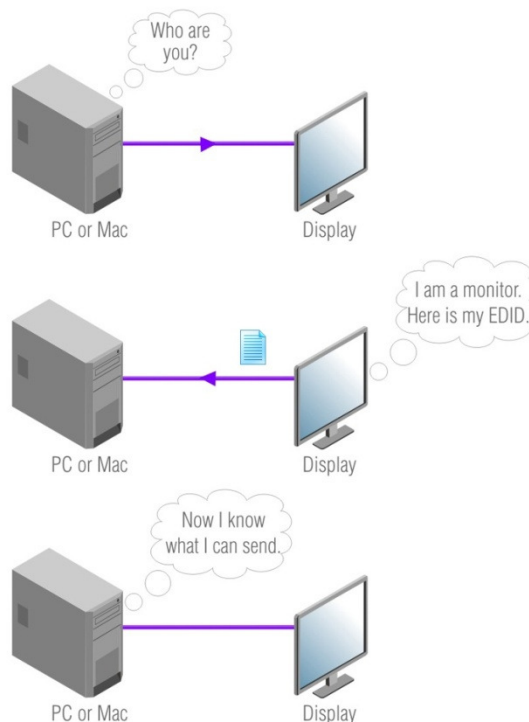

Most DVI computer displays have 128-byte long EDID structure. However, Digital Televisions and HDMI capable displays may have another 128 bytes, which is called E-EDID and defined by CEA (Consumer Electronics Association). This extension contains information about additional Detailed Timings, audio capabilities, speaker allocation and HDMI capabilities. It is important to know, that all HDMI capable devices must have CEA extension, but not all devices are HDMI capable which have the extension.

2.4.2. Common problems related to EDID

Problem: „My system consists of the following: a PC, then a Lightware DVI-TP-TX200DL, a WQXGA (2560x1600) LCD as local monitor, then a DVI-TP-RX100DL connected to a QXGA (2048x1536) projector. I would like to see the same image on the monitor and the projector. What EDID should I chose on the DVI-TP-TX200DL?“ (see typical application in section 2.9)

Solution: If you want to see the image on both displays, you need to select the resolution of the smaller display (in this case QXGA), otherwise the smaller display may not show the higher resolution image.

Problem: „I turned the rotary switches on the DVI-TP-TX200DL to have a different resolution but nothing happens.”

Solution: Some graphics cards and video sources read out the EDID only after power-up and later they don't sense that EDID has been changed. You need to restart your source to make it read out the EDID again.

Problem: „I have a DVI-TP-TX200DL and I'm using a Lightware factory preset EDID. I would like to be able to choose from different resolutions, but my source allows only one resolution.”

Solution: Most Lightware factory preset EDID allow only one resolution, forcing the sources to output only that particular signal. You need to select the Universal EDID (address 49). It supports all common VESA resolutions. Additionally it also features audio support.

2.5. Advanced EDID Management (DVI-TP-TX200DL)

Each DVI sink (e.g. monitors, projectors, plasma displays, and switcher inputs) must support the EDID data structure. Source BIOS and operating systems are likely to query the sink using DDC2B protocol to determine what pixel formats and interface are supported. DVI standard makes use of EDID data structure for the identification of the monitor type and capabilities. Most DVI sources (VGA cards, set top boxes, etc.) will output DVI signal after accepting the connected sink's EDID information. In case of EDID readout failure or missing EDID the source will not output DVI video signal.

DVI-TP-TX200DL provides Lightware's Advanced EDID Management function that helps system integration. It stores and emulates 99 EDID plus the EDID of the display device which is connected to Monitor Output. Memory addresses from 01 to 50 are factory presets, while memories from 51 to 99 are user programmable. DVI-TP-TX200DL stores the EDID of the monitor or projector connected to Monitor Output in a non-volatile memory.

The EDID emulated on the input can be copied from the DVI-TP-TX200DL's memory (static EDID emulation) or from the attached monitor (dynamic emulation). For example, the DVI-TP-TX200DL can be set up to emulate the device, which is connected to MONITOR OUTPUT, and the EDID automatically changes if the monitor is replaced with another display device (as long as it has a valid EDID).

Info

The user is not required to disconnect the DVI cable to change an EDID as opposed to other manufacturer's products. EDID can be changed even if a source is connected to the input and it is powered ON.

2.6. TMDS Reclocking (DVI-TP-RX100DL)

DVI-TP-RX100DL reclocks the signal on its output using Lightware's sophisticated TMDS Reclocking technology. Signal reclocking is an essential important procedure in digital signal transmission. After passing the reclocking circuit, the signal becomes stable and jitter-free, and can be transmitted over more equipment like processors and event controllers. When transmitting the signal through long cables without reclocking on the receiver side, sparkles, noise and jaggies can be seen on the image.

Info

TMDS stands for Transition Minimized Differential Signaling. It is the electrical and encoding specification used by the DVI standard for the transmission of the video signal.

The TMDS Reclocking circuit eliminates the following errors:

Intra-pair skew: skew between the + and - wires within a differential wire pair (e.g. Data2- and Data2+). It's caused by different wire lengths or slightly different wire construction (impedance mismatch) in DVI cable. It results in jitter.

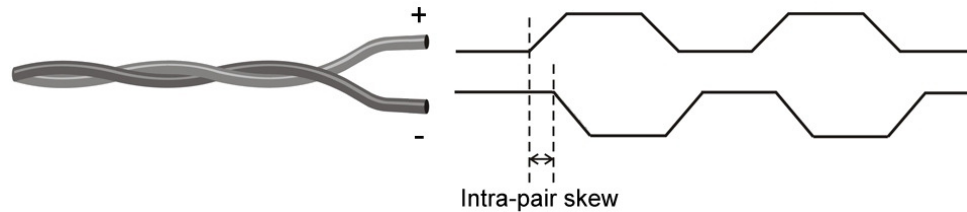

Jitter: signal instability in the time domain. The time difference between two signal transitions should be a fix value, but noise and other effects cause variations.

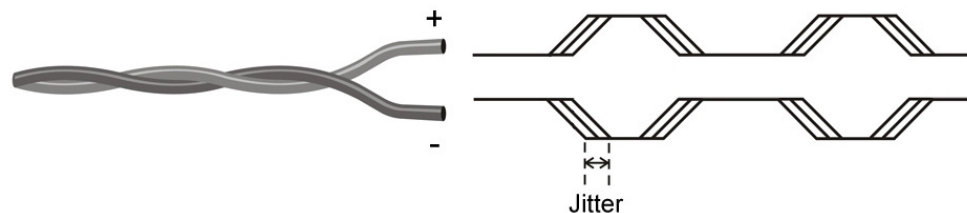

Noise: electromagnetic interference between other electronic devices such as mobile phones, motors, etc. and the DVI cable are coupled onto the signal. Too much noise results in increased jitter.

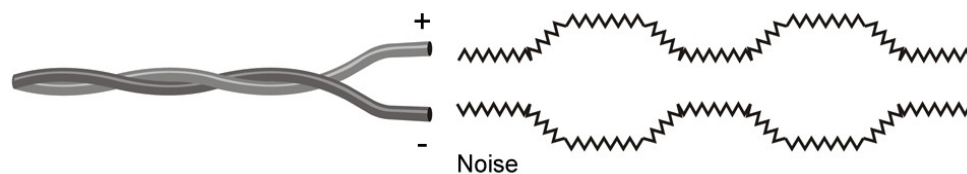

Info

TMDS Reclocking technology does not eliminate Inter-pair skew.

2.7. Dual link DVI signal

The dual link DVI interface can operate in either single link or dual link mode. The chosen mode depends on the pixel clock frequency of the signal and it is selected by the hardware automatically. For pixel clock frequencies lower than 165 MHz, single link mode is selected. For higher pixel clock frequencies (up to 330 MHz), dual link mode is selected. It is important to know that pixel clock frequency is not the same as TMDS clock frequency when it comes to dual link DVI.

The pixel clock frequency in single link transmission is a 10th part of the data rate. The maximum data rate of single link transmission is 1.65 Gbps per TMDS channel and the maximum pixel clock frequency is 165 MHz. In this case the pixel clock frequency equals the TMDS clock frequency.

The pixel clock frequency in dual link transmission (when in dual link mode) is a 5th part of the data rate. The maximum data rate of dual link transmission is still 1.65 Gbps per TMDS channel but the maximum pixel clock frequency is 330 MHz. In this case the pixel clock frequency is two times the TMDS clock frequency.

The DVI standard maximizes the data rate of the TMDS channels in 1.65 Gbps. Dual link DVI interface enables a higher resolution compared to single link transmission by doubling the number of wire pairs to transmit the video signal. In single link cables 3 wire pairs carry the color information (red, green and blue) and one wire pair carries the clock signal (TMDS clock). In dual link cables, 6 wire pairs carry the color information next to the TMDS clock signal. One color component is carried by two wire pairs, where one wire pair carries the odd pixels and the other wire pair carries the even pixels.

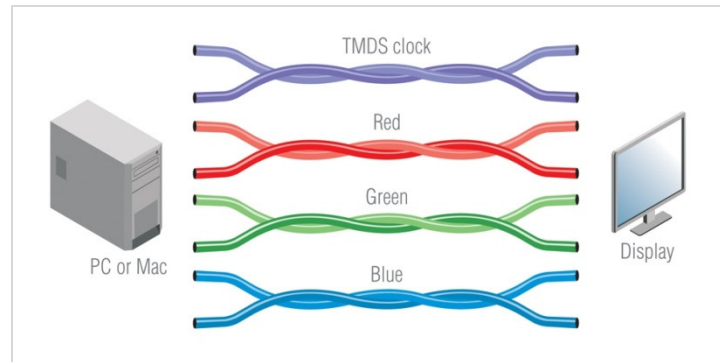

Video lines of the single link interface

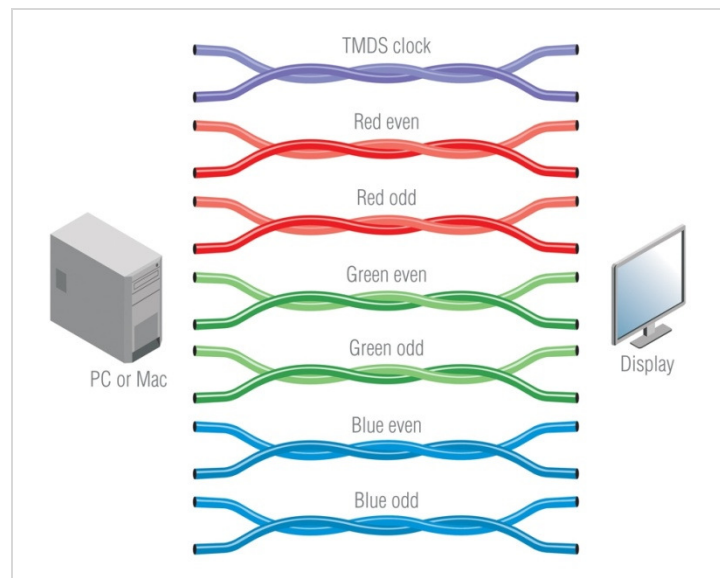

Video lines of the dual link interface

Info

The colors of the wire pairs in the picture represent the color information they carry and not the color of the actual wires inside the cable.

2.8. Fiber Cable powering

As a special feature, both DVI-TP-TX200DL (MONITOR OUTPUT) and DVI-TP-RX100DL (DVI OUTPUT) are able to supply 500 mA current to power fiber optical transmitters like Lightware DVI-OPT-TX100 (Pin 14 on DVI OUT connector). Standard DVI outputs or VGA cards supply only 55 mA current on +5V output, thus unable to directly power a fiber optical transmitter.

Info

DVI-TP-TX200DL and DVI-TP-RX100DL do not check if the connected sink (monitor, projector or other equipment) supports Hotplug or EDID signals but outputs the input signal immediately after it has been applied to the input.

2.9. Applications

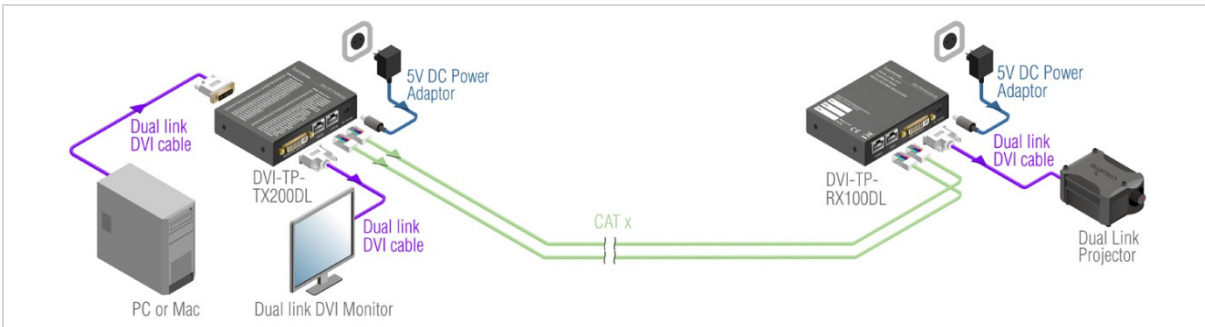

Typical stand-alone application

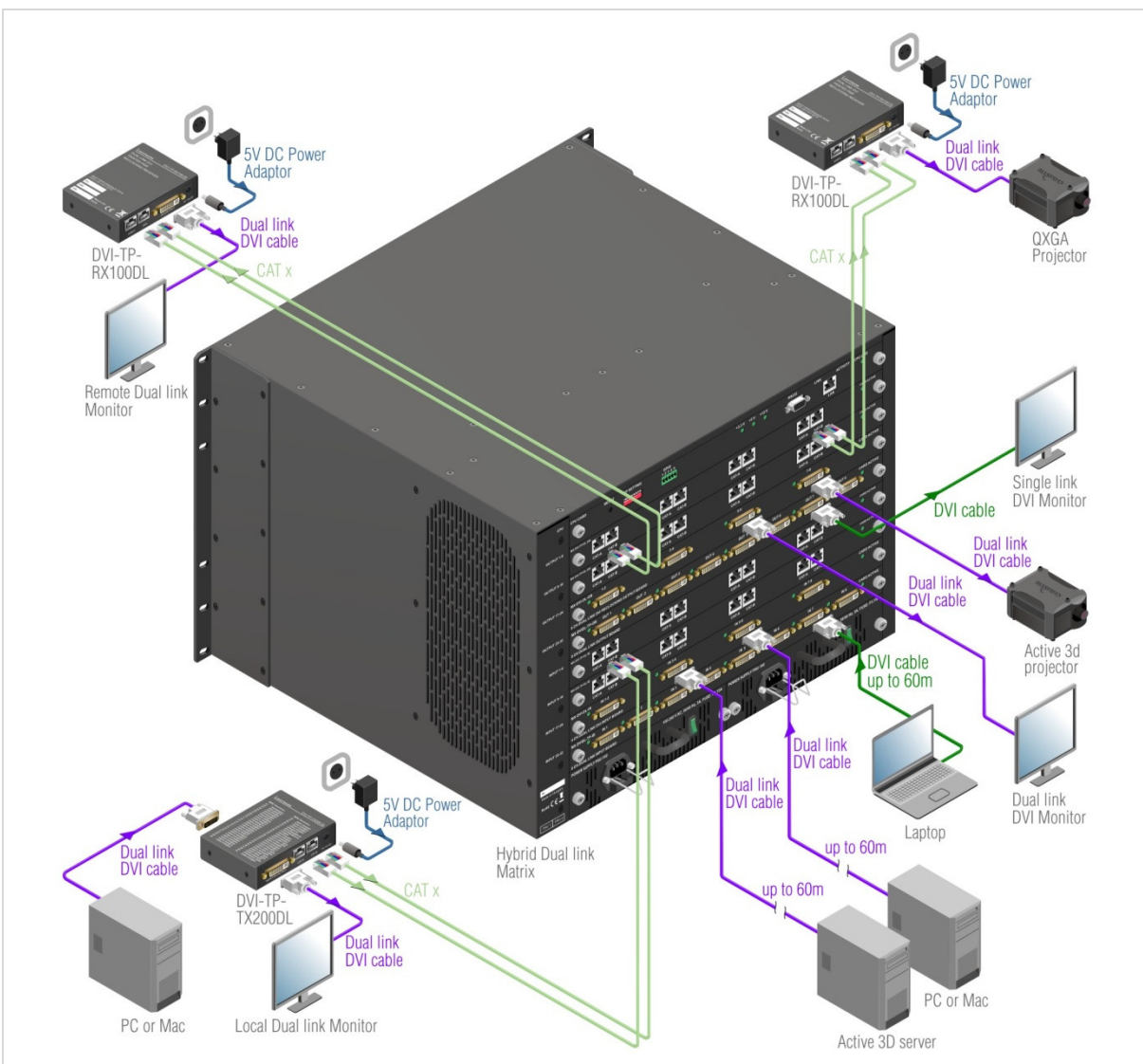

Using with Lightware MX32x32 FR32R frame

(the frame is equipped with single and dual link DVI cards and dual link TP cards)

2.10. Front and rear view

2.10.1. Front view of DVI-TP-TX200DL

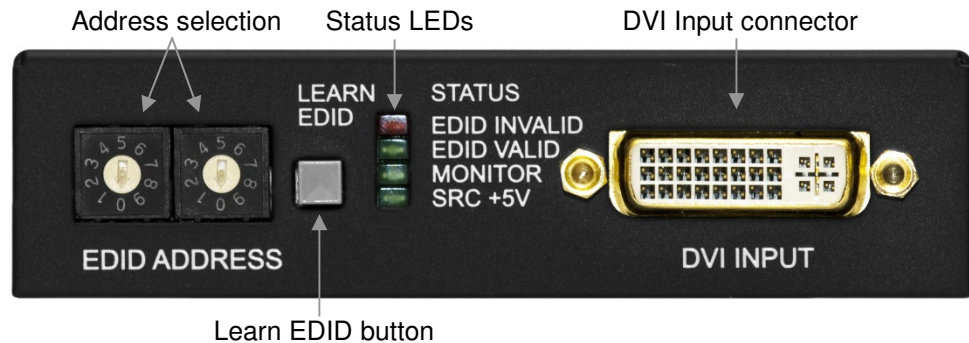

EDID Address	The rotary switches select one of 100 addresses. Addresses 1...50 are factory preset and 51...99 are user programmable. Address 00 enables transparent mode. For more information, see chapter 3.3. Use a flat head screwdriver that fits into the actuator. Avoid the use of keys, coins, knives and other sharp objects because they might cause permanent damage to the rotary switches.
Learn EDID button	Stores the EDID of the display device attached to MONITOR OUTPUT in the selected memory address between 51...99. To learn the EDID, select an appropriate address with the rotary switches and press and hold the Learn button for two seconds.
EDID status LEDs	<p><u>Function 1:</u> display the firmware version of the device. For more information, see chapter 3.1.</p> <p><u>Function 2:</u> after applying a Hot Plug signal to MONITOR OUTPUT, these LEDs indicate that the unit is reading the EDID from the connected display device. If the green LED is blinking then the EDID is valid, if the red LED is blinking, then the EDID is invalid or missing.</p> <p><u>Function 3:</u> (main function) these LEDs indicate whether the selected EDID is valid (green = valid, red = invalid or empty memory selected).</p> <p><u>Function 4:</u> after pressing the LEARN button, these LEDs indicate whether the learn process was successful (green blinking = successful, red blinking = unsuccessful). For more information, see chapter 3.2.</p>
Monitor LED	Indicates if a display device (or matrix switcher, repeater, etc.) is connected to the MONITOR OUTPUT connector and sends a valid Hot Plug Signal on Pin 16 through the DVI cable.
SRC +5V LED	Indicates if a DVI source is connected to the DVI-TP-TX200DL, it is powered on and sends +5V signal to Pin 14 of the input DVI connector.
DVI Input	Connect one dual link DVI-D or DVI-I cable (only digital pins are connected internally) between the DVI source and DVI-TP-TX200DL.

2.10.2. Rear view of DVI-TP-TX200DL

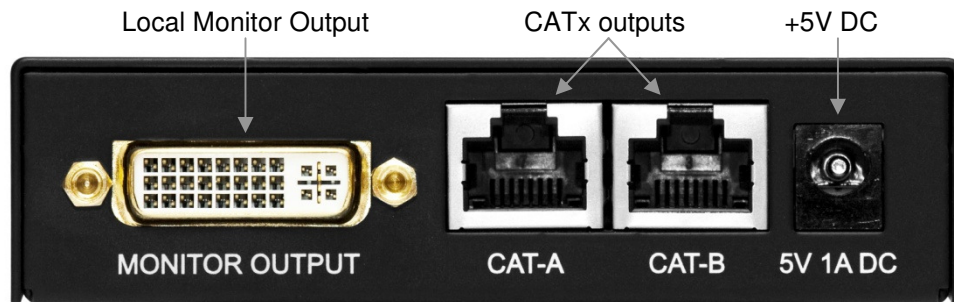

Monitor Output

Connect one dual link DVI-D or DVI-I cable (only digital pins are connected internally) between DVI-TP-TX200DL and local display device. For lower resolutions, with a maximum pixel clock frequency of 165 MHz, a single link cable can be used. For more information, see chapter 2.7.

The output connector is able to supply 500 mA current on pin 14 to power fiber optical DVI extenders like DVI-OPT-TX100.

If a long DVI cable is connected then equalization and reclocking may be necessary at the receiver end of the cable.

CAT A-B Outputs

Connect two CAT5, CAT5e, CAT6a or CAT7 (recommended) cables between DVI-TP-TX200DL and the receiver (DVI-TP-RX100DL or Lightware Hybrid Matrix equipped with dual link twisted pair input cards).

If a lower resolution image is transmitted, with a maximum pixel clock frequency of 165 MHz, then only one CATx cable needs to be connected to CAT-A output.

Accidental connection of the CAT-A output of the DVI-TP-TX200DL to the CAT-B input of a Lightware dual link twisted pair receiver (and vice versa) does not result in damage to the unit but it may result in faulty behavior. Please turn off the devices, disconnect the cables and connect the cables to the appropriate connectors.

The DVI-TP-TX200DL does not have networking capabilities. Do not connect the RJ45 output of the DVI-TP-TX200DL to a Local Area Network device or a PC. Doing so may damage the unit!

+5V DC connector

Connect the output of the supplied +5V power adaptor. CAUTION! Warranty void if damage occurs due to use of a different power source.

2.10.3. Front view of DVI-TP-RX100DL

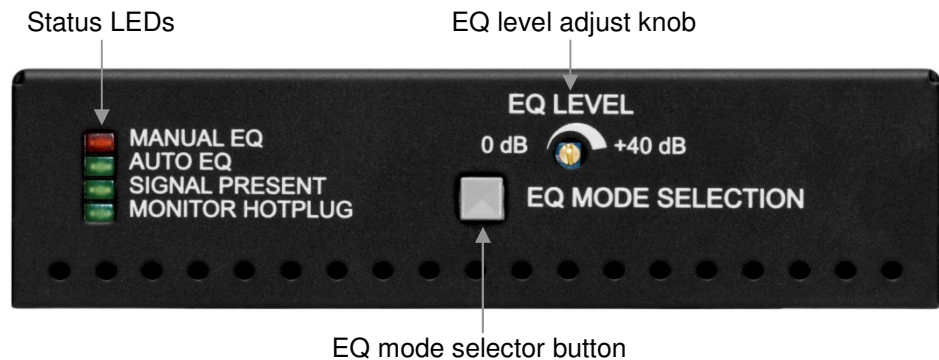

- EQ mode status LEDs** Two LEDs indicate whether the DVI-TP-RX100DL is in auto or manual equalization mode. Automatic mode usually gives a good result, but at long distances, manual equalization may be necessary. For more information, see chapter 4.2.
- Signal Present LED** Indicates if a valid DVI clock signal is present on CAT-A input RJ45 connector. The CAT-A cable carries the clock signal, therefore the unit can operate if only the CAT-A cable is connected, but cannot operate if only the CAT-B cable is connected. The presence of any video signal on the CAT-B input is not indicated.
- Monitor Hotplug LED** Indicates if a display device (or matrix switcher, repeater, etc.) is connected to the DVI OUTPUT connector and sends a valid Hot Plug Signal on Pin 16 through the DVI cable.
- EQ Mode button** Toggles between automatic and manual EQ mode. The EQ mode status LEDs indicate which mode is currently active.
- EQ level adjust** The 25-turn potentiometer can be used to precisely set the right amount of equalization in manual EQ mode. The potentiometer does not stop at the end positions, but rotates indefinitely. After reaching the end position, a clicking sound can be heard at every full turn of the knob.

2.10.4. Rear view of DVI-TP-RX100DL

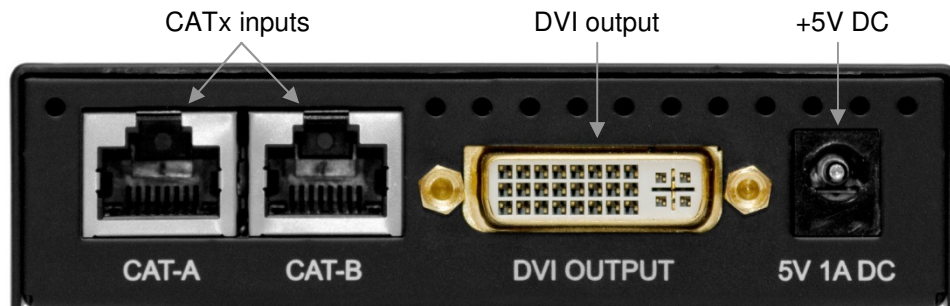

CATx inputs

Connect two CAT5, CAT5e, CAT6a or CAT7 (recommended) cables between DVI-TP-RX100DL and the transmitter (DVI-TP-TX200DL or Lightware Hybrid Matrix equipped with dual link twisted pair output cards).

If a lower resolution image is transmitted, with a maximum pixel clock frequency of 165 MHz, then only one CATx cable needs to be connected to CAT-A input.

Accidental connection of the CAT-A input of the DVI-TP-RX100DL to the CAT-B output of a Lightware dual link twisted pair transmitter (and vice versa) does not result in damage to the unit but it may result in faulty behavior. Please turn off the devices, disconnect the cables and connect the cables to the appropriate connectors.

The DVI-TP-RX100DL does not have networking capabilities. Do not connect the RJ45 input of the DVI-TP-RX100DL to a Local Area Network device or a PC. Doing so may damage the unit!

DVI output

Connect one dual link DVI-D or DVI-I cable (only digital pins are connected internally) between DVI-TP-RX100DL and the display device. For lower resolutions with a maximum pixel clock frequency of 165 MHz (1.65 Gbps TMDS data rate), a single link cable can be used.

The output connector is able to supply 500 mA current on pin 14 to power fiber optical DVI extenders like DVI-OPT-TX100.

+5V DC connector

Connect the output of the supplied +5V power adaptor. CAUTION! Warranty void if damage occurs due to use of a different power source.

2.11. Electrical connections

2.11.1. DVI inputs and outputs

DVI-TP-TX200DL and DVI-TP-RX100DL provide 29 pole „digital only” DVI-I connectors for input and output connections. Always use high quality DVI cable for connecting sources and displays.

Pin	Signal	Pin	Signal	Pin	Signal
1	TMDS Data2-	11	TMDS D1/3 Shield	21	TMDS Data5+
2	TMDS Data2+	12	TMDS Data3-	22	TMDS Clk Shield
3	TMDS D2/4 Shield	13	TMDS Data3+	23	TMDS Clock+
4	TMDS Data4-	14	+5V Power	24	TMDS Clock-
5	TMDS Data4+	15	GND (for +5V)	25	R (not connected)
6	DDC Clock	16	Hot Plug Detect	26	G (not connected)
7	DDC Data	17	TMDS Data0-	27	B (not connected)
8	VSYNC (nc)	18	TMDS Data0+	28	HSYNC (nc)
9	TMDS Data1-	19	TMDS D0/5 Shield	29	Analog GND
10	TMDS Data1+	20	TMDS Data5-		

Table 1. Dual link DVI-I “digital only” connector pin assignment

2.11.2. CATx inputs and outputs

DVI-TP-TX200DL and DVI-TP-RX100DL are equipped with shielded CAT6 RJ45 connectors.

Pin	Signal CAT-A	Pin	Signal CAT-B
1	TMDS Data0+	1	TMDS Data3+
2	TMDS Data0-	2	TMDS Data3-
3	TMDS Clock+	3	nc
4	TMDS Data1+	4	TMDS Data4+
5	TMDS Data1-	5	TMDS Data4-
6	TMDS Clock-	6	nc
7	TMDS Data2+	7	TMDS Data5+
8	TMDS Data2-	8	TMDS Data5-

Table 2. RJ45 connector pin assignment

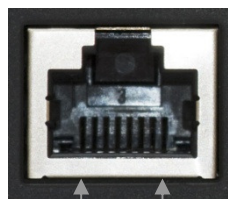

Pin 8 Pin 1

3. Operation of DVI-TP-TX200DL

3.1. Power

When building an electronic system, make sure that all of the devices are powered down before connecting them. Powered on devices may have dangerous voltage levels that can damage sensitive electronic circuits.

1. After the system is complete, connect the output of the +5V Power Adaptor to the DVI-TP-TX200DL (further on TX200DL) The unit is immediately powered ON.
2. After being powered on, the TX200DL displays its firmware version using the EDID Status LEDs.

The following example shows this process for a firmware version of 1.3.7

RED blinks once → Short pause → GREEN blinks three times → Short pause → GREEN blinks seven times → Short pause → The normal function of the LED is in effect.

3. After indicating the firmware version, the red EDID status LED lights up for 2-3 seconds, then turns green if the selected EDID is valid, or remains red, if the selected EDID is invalid (or the selected memory slot is empty).

After the TX200DL is initialized, the attached DVI source and monitor can be powered on.

4. If a display device is connected to MONITOR OUT, the TX200DL reads the EDID from the attached monitor's EDID memory.

If the read process is successful, the GREEN LED blinks several times then the EDID Status LEDs show whether the selected EDID is valid (green) or not (red) on the DVI INPUT connector.

If the read process is unsuccessful, the RED LED blinks several times then the EDID Status LEDs show whether the selected EDID is valid (green) or not (red) on the DVI INPUT connector.

Info

If none of the LEDs light up upon power-up, the unit is most likely damaged and further use is not advised. Please contact support@lightware.hu

3.2. Learning the EDID

The factory preset EDIDs cannot be changed by the user. Only addresses from 51 to 99 are user programmable.

1. After connecting the sink device to MONITOR OUT, use a screwdriver to select an empty memory address. EDID are stored in a multiple programmable non-volatile memory.

If the red EDID status LED is illuminated, then the memory slot is empty and ready to be programmed. If the green EDID status LED is illuminated, the memory was already used before, but still available for programming.

2. Push the LEARN button on the front side of the TX200DL and hold it down for approximately 3 seconds.

Once the button is pushed the EDID status LEDs go dark. If the EDID storing was successful, the green EDID status LED blinks five times and stays illuminated. Now the stored EDID is automatically emulated.

If the storing was unsuccessful, the red EDID status LED blinks five times and either the red or green EDID status LED becomes illuminated, depending on the previous status of the selected EDID address.

3.3. Switching the EDID

1. Use a screwdriver to change the memory address on the front side of the TX200DL.

After either one of the rotary switches has been rotated, the unit waits approximately 2 seconds before the selected EDID becomes active. If the EDID status is unchanged the EDID status LEDs do not blink, but stay continuously lit.

2. The address 00 (zero zero) has a special function. If a monitor is connected to MONITOR OUT, then its EDID is copied to the DVI INPUT connector. If no monitor is connected to the output then the EDID transmitted to the DVI INPUT connector is the EDID of the last connected monitor.

Info If an invalid EDID is selected, the TX200DL does NOT give a HOT PLUG signal to the source connected to DVI INPUT.

Info After every EDID change, TX200DL toggles the HOT PLUG signal for approx. 1 second. Some graphic cards or DVD players do not sense the HOT PLUG signal, and even if EDID has been changed, the set resolution is not affected. In this case the source device must be restarted, or powered OFF and ON again.

3.4. Factory preset EDID list

Lightware factory pre-loaded EDIDs are specially provided to force graphic cards to output only the exact pixel resolution and refresh rate.

Universal EDID (address 49) allows multiple resolutions including all common VESA defined resolutions. In addition, it also features audio support. The use of universal EDID is recommended for fast and easy system setup.

MEMORY	Resolution	MEMORY	Resolution
01	640x480@60 Hz	26	1600x1200@50 Hz
02	640x480@75 Hz	27	1600x1200@60 Hz
03	848x480@60 Hz 16:9	28	1920x1200@60 Hz
04	800x600@50 Hz	29	1920x1200@50 Hz
05	800x600@60 Hz	30	480i@59.94 Hz
06	800x600@75 Hz	31	640x480@59.94 Hz
07	1024x768@50 Hz	32	720x480p@60 Hz
08	1024x768@60 Hz	33	576i@50 Hz
09	1024x768@75 Hz	34	720x576p@50 Hz
10	1152x864@75 Hz	35	1280x720p@50 Hz
11	1280x768@50 Hz	36	1280x720p@60 Hz
12	1280x768@60 Hz	37	1920x1080i1 @50 Hz
13	1280x768@75 Hz	38	1920x1080i2 @50 Hz
14	1360x768@60 Hz	39	1920x1080i@60 Hz
15	1364x768@50 Hz	40	1920x1080p@24 Hz
16	1364x768@60 Hz	41	1920x1080p@25 Hz
17	1364x768@75 Hz	42	1920x1080p@30 Hz
18	1280x1024@50 Hz	43	1920x1080p1 @50 Hz
19	1280x1024@60 Hz	44	1920x1080p2 @50 Hz
20	1280x1024@75 Hz	45	1920x1080p@60 Hz
21	1366x1024@60 Hz	46	2048x1080p1 @50 Hz
22	1400x1050@50 Hz	47	2048x1080p2 @50 Hz
23	1400x1050@60 Hz	48	2048x1080p@60 Hz
24	1400x1050@75 Hz	49	UNIVERSAL EDID
25	1680x1050@50 Hz	50	2560x1600@60 Hz

Table 3. Factory Preset EDID list

4. Operation of DVI-TP-RX100DL

4.1. Power

When building an electronic system, make sure that all of the devices are powered down before connecting them. Powered on devices may have dangerous voltage levels that can damage sensitive electronic circuits.

1. After the system is complete, connect the output of the +5V Power Adaptor to the DVI-TP-RX100DL (further on RX100DL). The unit is immediately powered ON.
2. After being powered on, the RX100DL displays its firmware version using the EQ mode status LEDs.

The following example shows this process for a firmware version of 1.3.7

RED blinks once → Short pause → GREEN blinks three times → Short pause → GREEN blinks seven times → Short pause → The normal function of the LED is in effect.

3. After indicating the firmware version, either the red or green EQ mode status LED stays continuously lit, depending on the last selected mode.

After the RX100DL is initialized, the attached monitor can be powered on.

Info

If none of the LEDs light up upon power-up, the unit is most likely damaged and further use is not advised. Please contact support@lightware.hu

4.2. Adjusting the input equalization

The amplitude of high frequency signals decreases after they pass through long distances in copper cables. To counter-act this phenomenon, RX100DL amplifies the signal while maximizing the amplitude at a certain level, which is defined by the DVI 1.0 standard. This process is called equalization.

The RX100DL offers two equalization modes: automatic and manual. Automatic mode usually provides perfect transmission but at longer distances and higher resolutions, manual equalization may be necessary.

1. Select the equalization mode by pressing and releasing the EQ mode selection button once. The two EQ mode status LEDs show which mode is currently active.
2. Use a 2-3 mm flat head screwdriver to manually adjust the equalization level. Turning the knob clockwise increases the EQ level, turning it counterclockwise decreases the EQ level. The knob of the potentiometer does not stop at the end positions, but rotates indefinitely. After reaching the end position, a clicking sound can be heard at every full turn of the knob.

IMPORTANT! When installing the RX100DL in a system, always check which equalization mode is selected, because a previously set manual equalization level may not be suitable for a different system. It is always advised to use the automatic mode and only adjust the equalization manually if the auto mode does not give a good result.

4.3. Maximum twisted pair distances

The following table shows the maximum twisted pair distances. The actual achievable distances may differ, depending on the topology of the whole system. Unshielded Twisted Pair (UTP) cables are susceptible to EMI coming from surrounding devices (cables, mobile phones, motors, etc.). Noisy environments substantially decrease the usable length of unshielded cables. Hence the use of shielded Category 6 cables or Category 7 cables is always recommended. Category 7 cables are screened and foiled by standard.

Resolution	Vfreq (Hz)	Pixel clk freq. (MHz)	Cat5e UTP	Cat5e FTP	Cat6 UTP	Cat6 FTP	Cat6 S/FTP	Cat7 S/FTP
640x480	60	25,2	60 m	60 m	65 m	70 m	70 m	80 m
800x600	60	40,0	60 m	60 m	65 m	65 m	65 m	75 m
1024x768	60	65,0	55 m	55 m	60 m	60 m	60 m	75 m
1280x720p	60	74,2	55 m	55 m	60 m	60 m	60 m	70 m
1280x1024	60	108,0	50 m	50 m	55 m	60 m	60 m	65 m
1400x1050	60	121,8	45 m	45 m	45 m	55 m	55 m	60 m
1600x1200	60	162,0	30 m	35 m	35 m	45 m	45 m	50 m
1920x1080p	60	148,5	30 m	35 m	35 m	45 m	45 m	50 m
1920x1200p	60	153,0	30 m	35 m	35 m	45 m	45 m	50 m
2048x1536p	60	208,0	50 m	50 m	55 m	60 m	60 m	65 m
2560x1600p	60	268,0	30 m	35 m	35 m	45 m	45 m	50 m
3840x2400p	30	304,0	30 m	35 m	35 m	45 m	45 m	50 m

Table 4. Maximum twisted pair distances

5. Troubleshooting

5.1. There is no picture

Check the cables

Due to the high data rates, the cables must fit very well. DVI connectors have to be locked with screws, no tensions or breaches are allowed. If your source or display has more connectors then make sure that the proper interface is selected.

Check if the CATx cables are connected properly between the transmitter and receiver (CAT-A output to CAT-A input, CAT-B output to CAT-B input).

Accidental connection of the CAT-A output of the DVI-TP-TX200DL to the CAT-B input of DVI-TP-RX100DL (and vice versa) does not result in damage to the unit but it may result in faulty behavior. Please turn off the devices, disconnect the cables and connect the cables to the appropriate connectors.

The length of the two CATx cables must match very closely. If the cable lengths don't match, then the picture may not display or may become noisy.

Check the source equipment

Check the Source Connected LED on the front side of the DVI-TP-TX200DL. This LED indicates the presence of the +5V signal coming from the DVI source. If it is not illuminated, then your DVI source is not working properly. Please refer to the user's manual of your DVI source.

If the source is a computer, then verify that the DVI output is selected and active. Try restarting your computer; if you get a picture during the booting process, you have to review the driver settings.

Check the incoming signal

Check the Signal Present LED on the front side of the DVI-TP-RX100DL. This LED indicates the presence of an active incoming DVI clock signal. If it is not illuminated, then no DVI clock signal is present at the CAT-A input connector.

Make sure that the proper equalization mode is selected and if manual mode is active, the right amount of equalization is set.

Check if there's an outgoing signal on the Monitor Output connector of the DVI-TP-TX200DL (also check the Monitor LED on the front panel). The input signal is always routed to the DVI and RJ45 output connectors. If there is a signal on the Monitor Output connector, then the problem is not EDID related. Check if the CATx cables are connected properly.

Check the display status

Check the Monitor Hotplug LED on the front side of the DVI-TP-RX100DL. This LED indicates the presence of the Hotplug signal coming from the attached display device. If it is not illuminated, then your display is not powered or not configured properly.

Check EDID related problems

Check the EDID Status LEDs on the front side of the DVI-TP-TX200DL. These LEDs indicate whether a valid EDID is selected. If the red LED is illuminated, then an invalid EDID or an empty memory address is selected. Please select a valid EDID.

If the green EDID Status LED is illuminated, then maybe your display device is not capable of receiving the sent video format. Try emulating your display device's EDID to the source. You will find help to this process in section 3.3. If you get a picture now, you have an EDID related issue, please read section 2.4 for more details.

Check the EDID

Maybe the data rate is too high for that type of cable. Try switching another EDID to the inputs with lower resolution. If the source is a computer and you are an expert user, you can try modifying the refresh rate, so you would be able to get it to work at higher resolutions over a noisy connection.

6. Mechanical Drawings

6.1. DVI-TP-TX200DL

6.1.1. Top view

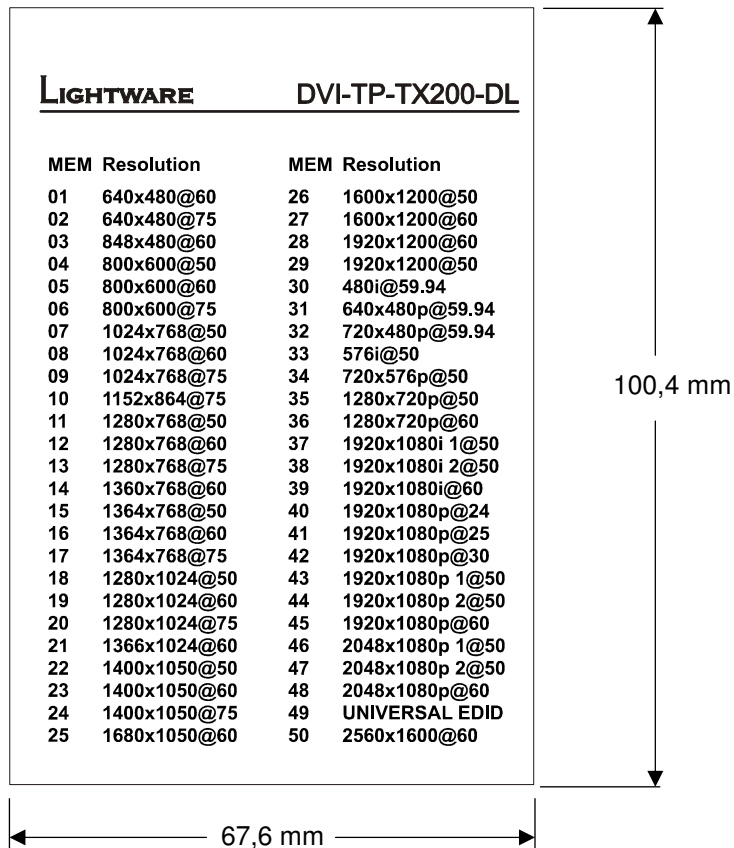

6.1.2. Front view (controls and input)

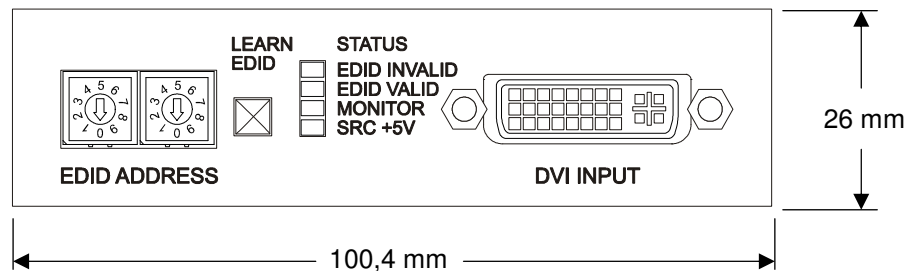

6.1.3. Rear view (outputs and power)

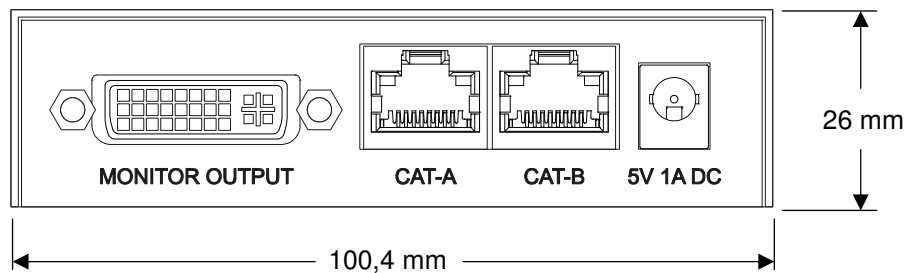

6.1.4. Bottom view

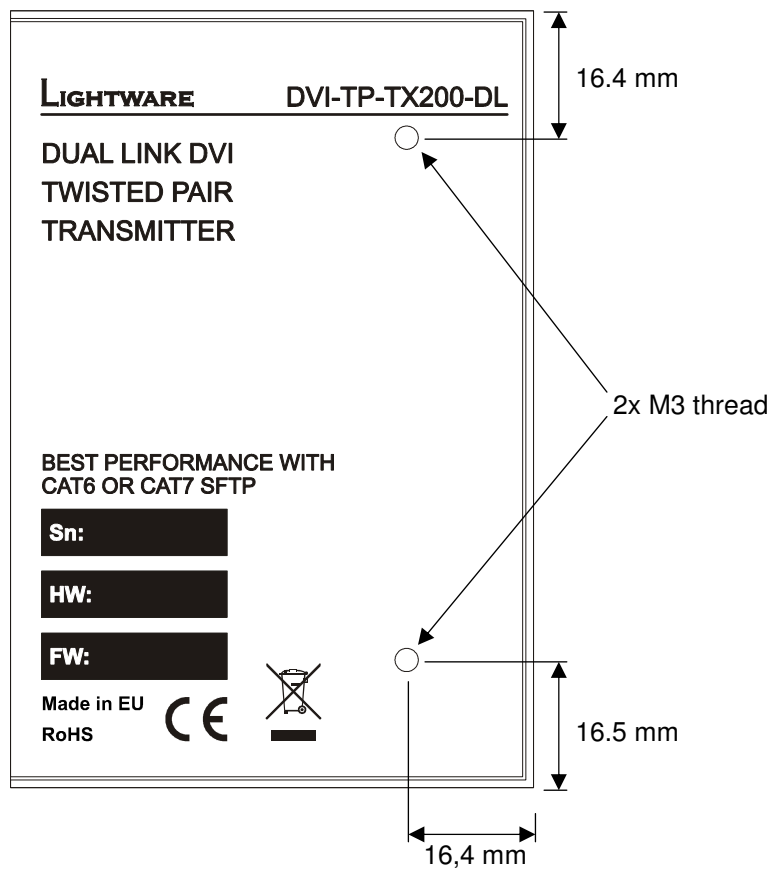

For rack mounting, cross recessed M3 (max. 10 mm long) screws must be used.

6.2. DVI-TP-RX100DL

6.2.1. Top view

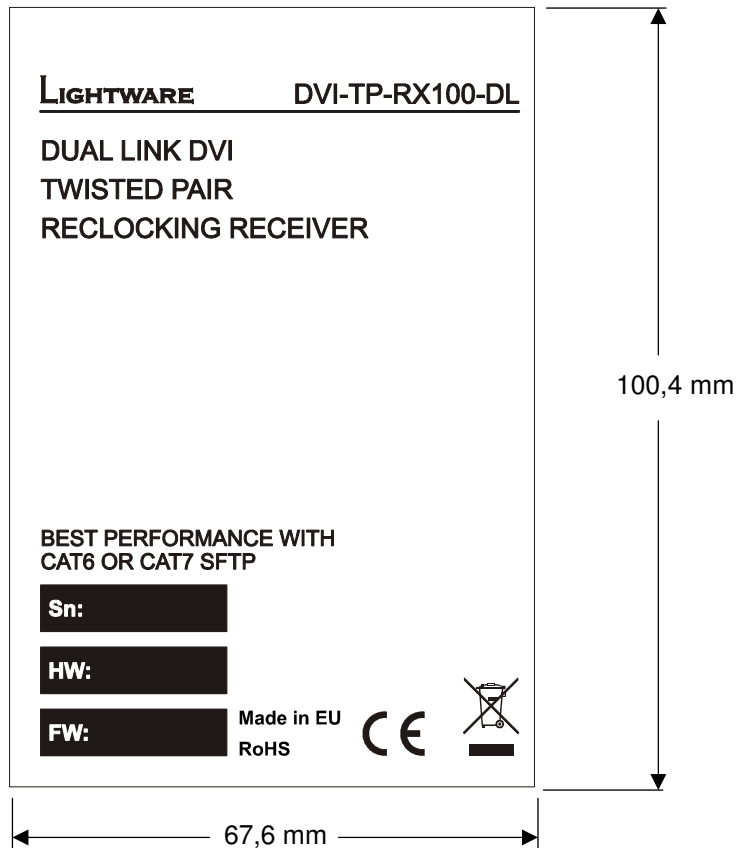

6.2.2. Front view (controls)

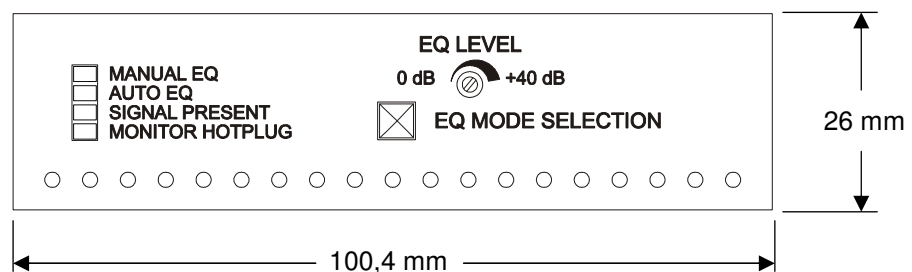

6.2.3. Rear view (inputs, output and power)

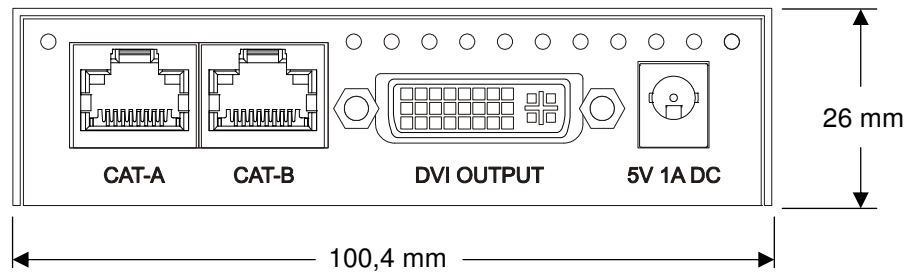

6.2.1. Bottom view

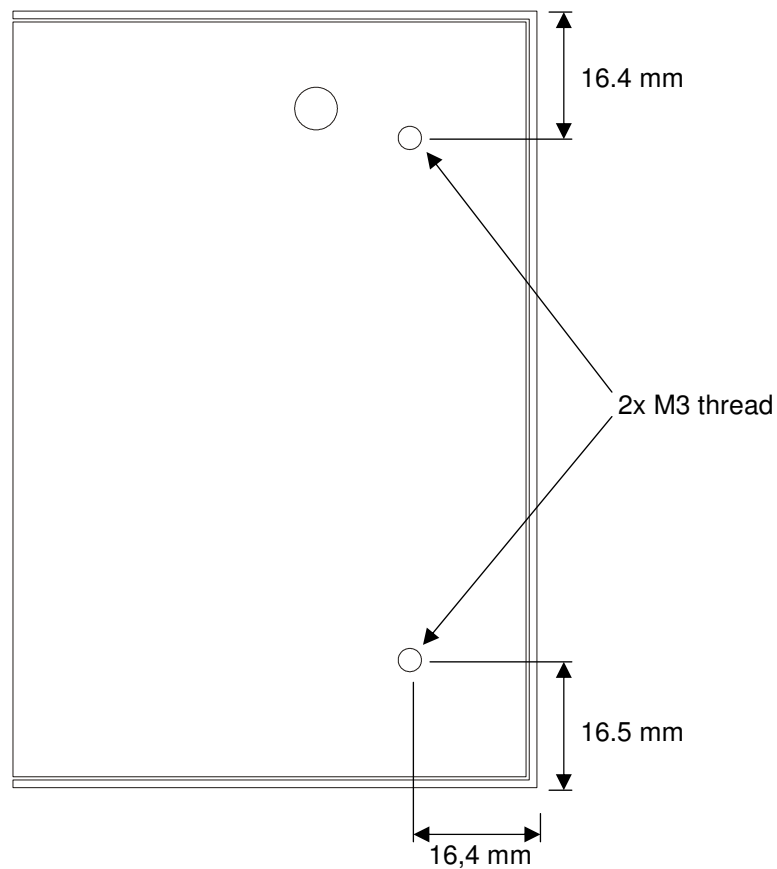

For rack mounting, cross recessed M3 (max. 10 mm long) screws must be used.

7. Warranty

Lightware Visual Engineering warrants this product against defects in materials and workmanship for a period of three years from the date of purchase.

The customer shall pay shipping charges when unit is returned for repair. Lightware will cover shipping charges for return shipments to customers.

In case of defect please call your local representative, or Lightware at

Lightware Visual Engineering
1071. Budapest Peterdy str. 15, HUNGARY

Tel.: +36 1 889 6177

Fax.: +36 1 342 9903

E-mail: support@lightware.hu

8. Specifications

Video

Standard	DVI 1.0 Dual Link
Color depth	24 bits, 8 bit/color
Format.....	RGB only
Data rate	all between 25 Mbps and 1.65 Gbps /TMDS channel
Resolutions	all between 640x480 and 3840x2400@30Hz
HDTV resolutions.....	720p, 1080i, 1080p
HDCP compliant	No
Input equalization (RX100DL).....	+40 dB, automatic, manual
Reclocking (RX100DL)	TMDS Reclocking
EDID Emulation (TX200DL).....	Yes, 50 factory preset, 50 user programmable
EDID Support (TX200DL)	256 Byte Extended EDID

General

Connectors.....	29-pole DVI-I digital only, CAT6 RJ45
Number of DVI inputs (TX200DL).....	1 dual link
Number of DVI outputs (RX100DL)	1 dual link
Number of CATx inputs (RX100DL)	1 dual link (2 connectors)
Number of CATx outputs (TX200DL).....	1 dual link (2 connectors)
+5V output current (DVI).....	500 mA continuous with overcurrent protection
Power adaptor.....	100-240 V AC 50/60 Hz 0.6A to +5V DC 2.6A
Power consumption (TX200DL).....	4 W typical
.....	6 W max when powering a fiber extender on DVI output
Power consumption (RX100DL)	7 W typical
.....	9 W max when powering a fiber extender on DVI output
Compliance	CE
EMI/EMC.....	EN 55022 Class B
Safety.....	UL, CUL, GS, CR, RCM, PSE, Class II
Warranty	3 years

Enclosure

Rack mountable	Yes
Material	1 mm Metal
Dimensions	100,4 mm W x 67,6 mm D x 26 mm H
Net Weight (TX200DL).....	230 g
Net Weight (RX100DL)	230 g

NOTES: