



OWNER'S MANUAL

RET Series



**Read all instructions carefully before use.
For any Customer Support needs please choose the
Customer Support tab on www.royalsovereign.com**

Royal Sovereign International Inc.

www.royalsovereign.com

TOPIC	PAGE
1. INTRODUCTION.....	3
2. SAFETY PRECAUTIONS	3
3. PRODUCT IDENTIFICATION	5
4. INSTALLATION	6
4.1 Electrical requirements	6
4.2 Box contents.....	7
4.3 Assembly	8
5. OPERATION.....	11
6. MAINTENANCE.....	12
7. TROUBLESHOOTING.....	13
8. SPECIFICATIONS	14
9. WARRANTY.....	15

1. INTRODUCTION

Thank you for choosing a Royal Sovereign trimmer. It has been designed and manufactured to provide years of continuous service. For complete operating and maintenance information please read this manual thoroughly. Upon receipt of your trimmer, please inspect the box, the machine and all other contents for shipping damage. Damage should be brought to the immediate attention of the delivering carrier (See page 7 for list of shipment elements).

2. SAFETY PRECAUTIONS

Failure to comply with any of the following safety procedures could result in serious injury. Please read all instructions carefully and keep for future reference. Royal Sovereign International Inc. cannot be held responsible for any damages to people, animals or objects due to noncompliance with the safety norms and recommendations of these documents.

1. Only a licensed electrician should install wiring and outlet for the trimmer.
2. Ensure the unit is plugged into a properly grounded outlet with the correct voltage.
3. Keep hands away from cutting blade when in operation.
4. Keep flammable and wet objects away from the machine.
5. Place machine on a level surface.
6. Avoid excessive sunlight, humidity and extreme temperatures.
7. Ensure the unit is turned off and unplugged from the outlet prior to moving and/or repairing.
8. Keep out of reach of children.
9. Only Royal Sovereign authorized maintenance and service technicians should make repairs.
10. Do not attempt to trim items that exceed total recommended material thickness for the unit.
11. When cleaning the machine, don't use flammable sprays or materials.
12. Do not touch the blade when in use or place foreign objects inside the machine.
13. Tampering with the protections (rear cover, safety cover, protector plate) and safety devices is dangerous for the people using the machine and for those exposed to it. Royal Sovereign International Inc. cannot be held responsible for any damages to people, animals or objects due to tampering with the protections.
14. Pay attention to the danger notices on the trimmer.

Dangerous areas and residual risks

All the areas around the machine in which people are at risk of injuries or health problems are considered dangerous.

Pay close attention to hands when operating the trimmer.

During certain intervention procedures on the machine, which are pointed out each time in this manual, residual risks for the operator may arise. Residual risks can be avoided by carefully complying with the procedures of this manual and using the personal protection devices indicated. such as:

- Carefully positioning the power cord so that it cannot be stepped on or ruined.
- Not putting the power cord where it can easily be damaged.
- Maintenance and service operations must be carried out only by the engineers authorized by the manufacturer.
- Pay attention to the danger notices on the trimmer.

Trimmer should only be operated by trained personnel

DO NOT PLACE HANDS NEAR THE CUTTING BLADE !



3. PRODUCT IDENTIFICATION

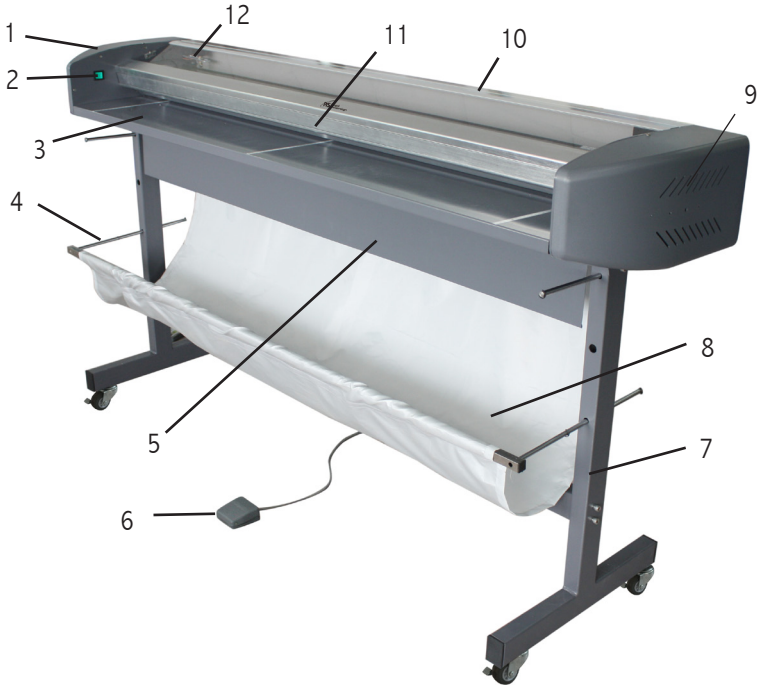

NO	PART NAME
1	Left Side Cover
2	Power Switch
3	Feed Table Front
4	Fabric Holder Rod
5	Protection Plate
6	Foot Pedal
7	Floor Stand
8	Waste Catcher
9	Right Side Cover
10	Rear Cover
11	Activation Bar
12	Safety Cover

4. INSTALLATION

Note: The trimmer should be installed by a trained service technician

The trimmer needs to be assembled by a trained installer.

The trimmer should only be used in an area with the following characteristics:















- Protection from atmospheric agents
- Proper illumination
- Temperatures between 64° F and 95° F
- Amount of humidity from 30% to 80%

4.1 Electrical requirements

Royal Sovereign recommends that a licensed electrician ensures proper power installation to your trimmer in accordance with electrical codes in your area.

4.2 Box contents

Thoroughly inspect the parts and the unit. It is imperative that any missing parts are reported and a claim is filed with the reseller immediately upon receipt of shipment.

	Part Name	Quantity	Picture
Main Box	Main Trimmer Assembly	1	
	Floor Stand Side Frame	2	
	Floor Stand Cross Bar	1	
	Owner's Manual	1	
	Protection Plate (RET-1501/RET-2001)	1	
	Protection Plate (RET-2501)	2	
	Wastecatcher Square Bars	2	
Fabric Holder Bars	4		
Tool Box	L-wrench (4/6)	1 / 1	
	5/16 Hexa head bolt (M8*55mm)	10	
	Star washer (Ø8.2)	6	
	Spring washer (Ø8.2)	4	
	5/32 screw (M4*8mm) (RET-1501/2001/2501)	3/4/6	
Spring washer (Ø4.1) (RET-1501/2001/2501)	3/4/6		
E-ring (Ø8)	8		

4.3 Assembly

1. Open the box carton and remove all parts.
2. Open the tool-box. (Fig. 4-1)

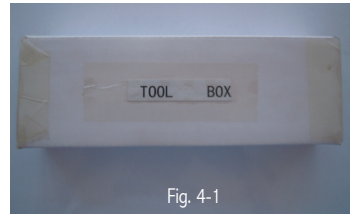

This operation must be carried out by a minimum of two people

3. Attach the lower cross bar to the left floor stand side frame and right floor stand side frame using the supplied screws (M8x55). (Fig. 4-2)



4. Slide the holder rods into the adjacent holes of the assembly in accordance with Fig. 4-3. Using pinchers, place the E-rings into the appropriate mounting slots of the holder rods. (Fig.4-4)

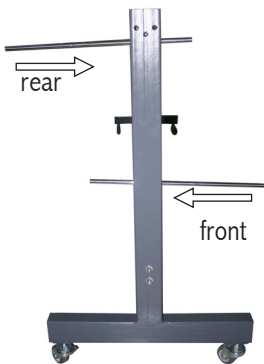

5. Screw the wastecatcher square bars into the previously inserted wastecatcher holder rods, (Fig. 4-5) putting the supplied screws through the largest drilling in the square bar, so that the head of the screw sits flush within the bar itself. (Fig. 4-6)

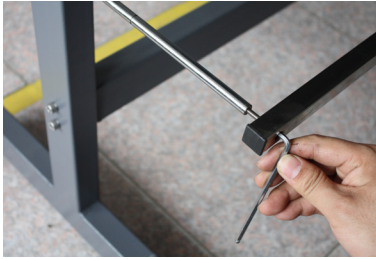

Fig. 4-5



Fig. 4-6

6. Position the main trimmer assembly on top of the floor stand. And properly align the bolt holes. Use bolts (M8x55) to attach the main trimmer assembly to the floor stand. (Fig. 4-7)



Fig. 4-7

7. Attach the protection plate (Fig. 4-8) to the upper cross bar with the supplied screws. The protection plate must be assembled on the front part of the upper cross bar, always keeping the table adjustment pin upward.



Fig. 4-8

8. Connect the power cord in to the AC outlet and turn the Power switch to the ON position.
9. The Trimmer is now ready for Operation. (Fig. 4-9)



Fig. 4-9

5. OPERATION

The trimmer must only be used by trained and qualified personnel.

The trimmer must be used only for trimming material for which it has been designed.

For recommended maximum cutting thickness see page 14.

1. The trimmer should be positioned on a level surface in an area with adequate lighting and enough work space for feeding materials. Connect the power cord to the AC outlet and turn the Power switch to the ON position. The machine should be operated from the front of the machine only.
2. To begin trimming material, position the material to be trimmed on the front feeding table (Fig. 5-1) and measure the cut by using the scales present at either side of the feed table or by the guideline. Do not lean against or put any object on the feeding table during trimming.
3. When the material is properly positioned press the activation bar (Fig. 5-2) anywhere along the length of the trimmer to activate the cutting blade or step on the foot pedal (Fig. 5-3) to activate the cutting blade. The material can now be removed or repositioned for another cut.



Fig. 5-1



Fig. 5-2



Fig. 5-3

6. MAINTENANCE



Standard maintenance

CAUTION: Unplug the trimmer from the power outlet during any maintenance to avoid risk of electric shocks.

Note: Only qualified personnel should attempt standard maintenance on the trimmer.

Maintenance Procedures

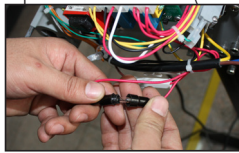
Follow below procedures as needed.

Maintenance	Frequency of execution	Procedure	Precautions
General dusting	At user's discretion	<ul style="list-style-type: none"> • Clean the entire machine with a damp cloth 	Do not use aggressive products
Cleaning the scrap material	If there is a lot of scrap material	<ul style="list-style-type: none"> • Remove the safety-cover • Eliminate the scrap material with an aspirator and/or compressed air 	Wear a pair of protection gloves
Replace the fuse of general wiring	When the fuse is burnt	<ul style="list-style-type: none"> • Remove the left panel • Open the take-fuse connector • Remove the burnt fuse • Replace it with a new one (3.15A) 	Isolate the machine from power supply sources by unplugging the power cord
Replace the fuse on the electronic board	When the fuse is burnt	<ul style="list-style-type: none"> • Remove the left panel • Remove the burnt fuse • Replace it with a new one (2A) 	Isolate the machine from power supply sources by unplugging the power cord
Replace the electronic board	When the electronic board is broken	<ul style="list-style-type: none"> • Remove the left panel • Remove the broken electronic board unscrewing the 3 screws for fixing • Replace it with a new one 	Isolate the machine from power supply sources by unplugging the power cord

7. TROUBLESHOOTING

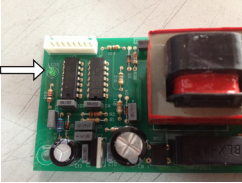
Symptoms	Cause	Possible Solution
Machine won't turn on. Lamp is off, and main switch is off position	<ul style="list-style-type: none"> a. Power cord not plugged in b. Power switch is in "0" off position c. Power fuse is blown out 	<ul style="list-style-type: none"> a. Plug the power cord into appropriate position b. Put power switch back "1" on position c. Replace main power fuse
Though power & lamp is 'ON', but cutter won't move after pressing switch button	<ul style="list-style-type: none"> a. If the 'led3' on the PCB is off, the fuse on the PCB is blown out  <ul style="list-style-type: none"> b. If the 'led3' on the PCB is on, either the right or left limit switch is disconnected 	<ul style="list-style-type: none"> a. Replace the fuse on PCB b. Replace either the right or left micro switch

For more troubleshooting Queries, please contact Royal Sovereign.

8. SPECIFICATIONS

9.1 Technical information

MODEL	RET-1501	RET-2001	RET-2501
Power supply	220V(60Hz),220~240V(50Hz),100V(50/60Hz),110~120V(60Hz)		
Absorbed current	max 0.7A-(max1.2A)		
Max cutting thickness	30mil/1mm		
Usable cutting length	59inch/1500mm	78inch/2000mm	98inch/2500mm
Cutting speed	6.6ft/sec/2m/sec		
Length	77.6inch/1970mm	99.2inch/2470mm	116.9inch/2970mm
Width	18.9inch/480mm		
Height	40.2inch/1020mm		
Working table height	34.3inch/871mm		
Unit weight	106lbs/48kg	131lbs/59kg	155lbs/70kg
Accessories	Roll Holder		

9.2 Recommended Trimming Materials

NO	Material Type	Max.cutting thickness
1	Canvas	20mil/0.500mm
2	Laminate	15mil/0.375mm
3	Lexan	10mil/0.250mm
4	Paper	30mil/1.000mm
5	Styrene	10mil/0.250mm
6	Vinyl	20mil/0.500mm



Trimming any material with a thickness exceeding the maximum may dull or damage the cutting blade.

9. WARRANTY

Royal Sovereign International warrants the equipment sold is free from defects in material and workmanship for a period of One (1) year for Parts and Labor from the date of installation, excluding cutting blades which are warranted for Six (6) months. This warranty is valid only to the original purchaser. This warranty is the only warranty made by Royal Sovereign International and cannot be modified or amended. Royal Sovereign's sole and exclusive liability and the customer's sole and exclusive remedy under this warranty shall be, at Royal Sovereign's option, to repair or replace any such defective part or product. These remedies are only available if Royal Sovereign's examination of the product discloses to Royal Sovereign's satisfaction that such defects actually exist and were not caused by misuse, neglect, attempt to repair, unauthorized alternation or modification, incorrect line voltage, fire, accident, flood or other hazard.

All warranty claims must be filed through Royal Sovereign or the authorized Royal Sovereign dealer or reseller through which the equipment was originally purchased. Model, serial number and date of delivery are required for all claims.

The warranty made herein is in lieu of all other warranties, expressed or implied, including any warranty or merchantability or fitness for a particular purpose. Royal Sovereign will not be liable for personal damage or personal injury (unless primarily caused by its negligence), loss of profit, or other incidental or consequential damages arising out of the use or inability to use this equipment.

LIMITED WARRANTY

This warranty specifically does not cover damage to cutting blade caused by attempted cutting of materials and/or thicknesses of materials other than those specified for use in the user manual, or failure caused by adhesives, or damage caused by lifting, tilting or improper use of the machine. Warranty repair or replacement by Royal Sovereign or its authorized Reseller(s) does not extend the warranty beyond the initial one year period from the date of installation. Unauthorized customer alterations will void this warranty.

ROYAL SOVEREIGN INTERNATIONAL, INC.

2 Volvo Drive Rockleigh, NJ 07647 USA
TEL : +1) 800-397-1025 FAX : +1) 201-750-1022

RS CANADA INC.

1025 Westport Crescent, Mississauga On L5T 1E8 CANADA
TEL : +1) 905-461-1095 FAX : +1) 905-461-1096
TF : +1) 866-961-6673

RS EUROPE LIMITED.

66 Salisbury Road, Worcester Park, Surrey KT4 7DE UK
TEL.: +44) 2082243633

RS INTERNATIONAL AUSTRALIA PTY. LTD.

30 Prime Drive, Seven Hills, NSW 2147, AUSTRALIA
TEL : +61) 2-9674-2127 FAX : +61) 2-9674-2027