



Instructions for:
TTW[®]1 Universal Service
Replacement Blower Kit
P/N 265-47200-00

(To be performed ONLY by qualified service providers)

**The Blowers on the Following Water
Heaters are Serviced by This Kit:**

MITW -10
Series



MITW -12 / -15
Series



M1TW Series
(Normal & High Altitude)



(For full model numbers, see page 2.)

Model Numbers Reference

Water Heater Model Numbers Serviced by This Kit

Water Heater Model Numbers

Original Blower's P/N

MITW -10 Series	MITW40L*LN10 MITW40L*CX10 MITW50L*LN10 MITW50L*CX10	239-39785-00
MITW -12 / -15 Series	MITW40L*EN12 MITW40L*BN12 MITW40L*CX12 MITW50L*EN12 MITW50L*BN12 MITW50L*CX12	239-41605-00
	MITW40L*EN15 MITW40L*BN15 MITW40L*CX15 MITW50L*EN15 MITW50L*BN15 MITW50L*CX15	239-41605-00
M1TW Series	M1TW40S*BN M1TW40S*CX M1TW50S*BN M1TW50S*CX	239-45584-00 243-45987-00 (Hi-Alt)
	M1TW40S*FBN M1TW40S*FCX M1TW50S*FBN M1TW50S*FCX M1TW60T*FBN M1TW60T*FCX	239-45584-00 243-45987-00 (Hi-Alt)

(*) Denotes Warranty Years (Typically “5”, “6”, or “10”)

Kit Components

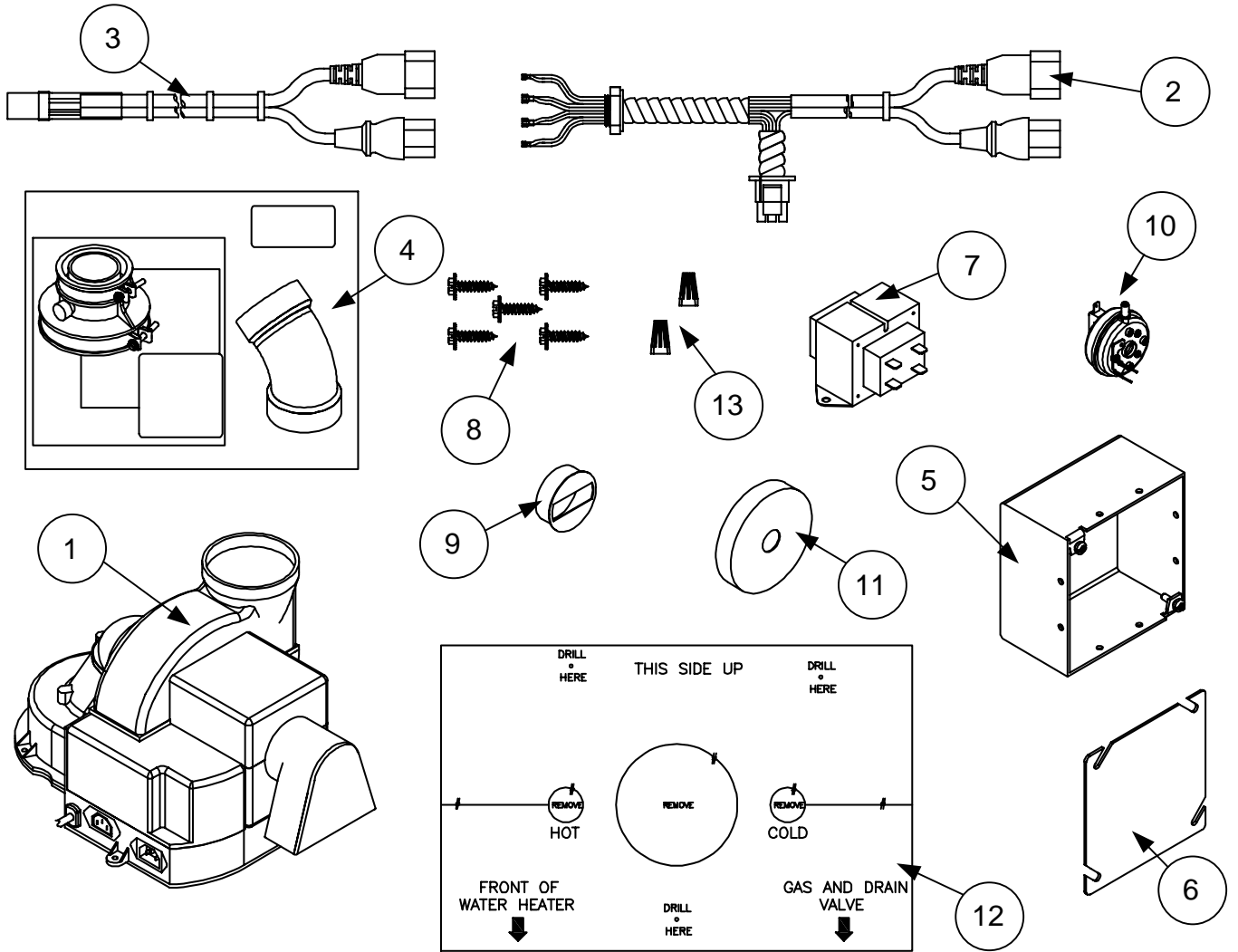

	Part Number	Qty	Description	Models Used On:
1	265-47195-00	1	Universal Blower	All
2	239-47194-00	1	Wire Harness MITW-12/15 Series	MITW -12 / -15 Series
3	239-47193-00	1	Wire Harness MITW-10 Series	MITW -10 Series
4	239-46263-00	1	2" Exhaust Adapter & Vent Terminal Kit	All
5	239-47196-00	1	Transformer Junction Box	MITW -12 / -15 Series
6	239-47199-00	1	Transformer Junction Box Cover	MITW -12 / -15 Series
7	265-44072-01	1	Transformer (120V / 24V)	MITW -12 / -15 Series
8	239-44113-00	5	Screws	All
9	239-47190-00	1	Dilution Air Orifice	MITW Series (normal & high altitude)
10	239-47192-01	1	Pressure Switch (-0.70" wc)	MITW Series (high altitude only)
11	239-47191-00	1	Flue Restrictor	MITW -10 Series & MITW -12 / -15 Series
12	238-47197-00	1	Template	MITW -10 Series & MITW -12 / -15 Series
13	239-47281-00	2	Wire Nuts	MITW -10 Series & MITW -12 / -15 Series

For full model numbers, see page 2 (Model Number Reference Page).

Tools Required

¼" Nut Driver

5/16" Nut Driver

Slotted Screwdriver

Philips Screwdriver

Hammer

1/8" Drill Bit

Drill

Channel Lock Pliers

Needle Nose Pliers

Tape (preferably scotch or masking)

PVC Primer / Cement

Wire Cutters

Wire Strippers

Wire Brush

Hacksaw

Bradford White

TTW®1 Universal Service
Replacement Blower Kit
P/N 265-47200-00

Table of Contents

	<u>Page</u>
Kit Components	3
Tools Required	4
MITW -10 Series Water Heaters:	6
MITW40L*LN10, MITW40L*CX10, MITW50L*LN10, MITW50L*CX10	
MITW -12 / -15 Series Water Heaters:	12
MITW40L*EN12, MITW40L*BN12, MITW40L*CX12, MITW50L*EN12, MITW50L*BN12, MITW50L*CX12, MITW40L*EN15, MITW40L*BN15, MITW40L*CX15, MITW50L*EN15, MITW50L*BN15, MITW50L*CX15	
M1TW Series Water Heaters:	21
M1TW40S*BN, M1TW40S*CX, M1TW50S*BN, M1TW50S*CX, M1TW40S*FBN, M1TW40S*FCX, M1TW50S*FBN, M1TW50S*FCX, M1TW60T*FBN, M1TW60T*FCX	
Notes	27

(* Denotes Warranty Years (Typically “5”, “6”, or “10”))

Notice:	To determine what series water heater is being serviced, please refer to the model numbers shown below each series title. Then, turn to the applicable page for the correct water heater series.
---------	--

**TTW1 Universal Service
Replacement Blower**
MITW -10 Series

Note: This set of instructions is for the following model numbers: MITW40L*LN10, MITW40L*CX10, MITW50L*LN10, and MITW50L*CX10.

Note: The following parts are required to convert the model numbers shown above: Template, Flue Restrictor, Screws, Wire Harness MITW-10 Series, Universal Blower, Wire Nuts, and 2" Exhaust Adapter / Vent Terminal Kit. Please refer to the Kit Components page (Page 3) for a picture of each item.

Step 1. Unplug water heater from wall outlet.

Remove power cord from outlet.

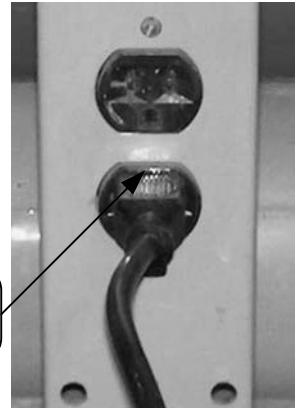

Step 2. Detach blower wire harness from receptacle located in the jacket head.

Unplug blower harness from jacket head receptacle.

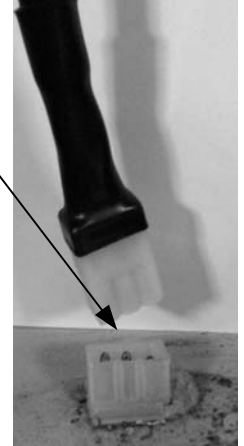

Step 3. Disconnect the vent pipe and adapter that are connected to the outlet of the blower.

Unscrew both clamps that hold the adapter to the blower and vent pipe.

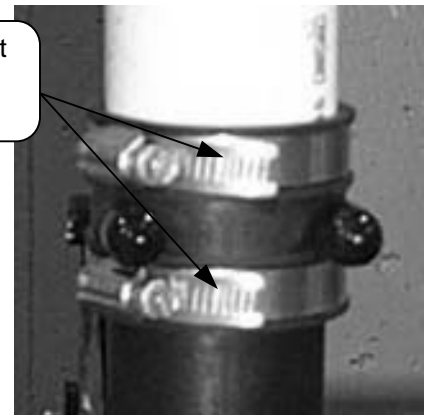

**TTW1 Universal Service
Replacement Blower**
MITW -10 Series

Step 4. Remove the screws, qty. (4), that secure the blower to the jacket head.

Step 5. Remove blower from the top of the water heater. Remove any loose debris and tools from the top of the water heater, including any portion of the blower gasket that still exists.

Unscrew (4) screws that hold blower to the jacket head.

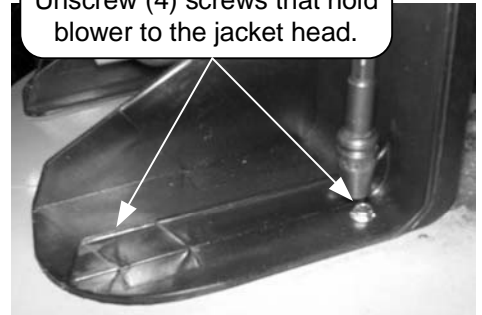

Warning: Failure to locate the blower correctly will result in improper water heater operation.

The (3) circular sections on template have been pre-cut and removed.

Step 6. Create the new mounting hole locations for the new universal replacement blower. Use template supplied with manual.

a.) On the template, P/N 238-47197-00, the (3) circular sections for the water connections and flue have already been removed. Also, the dotted lines from the side of the paper are perforated for easy tearing.

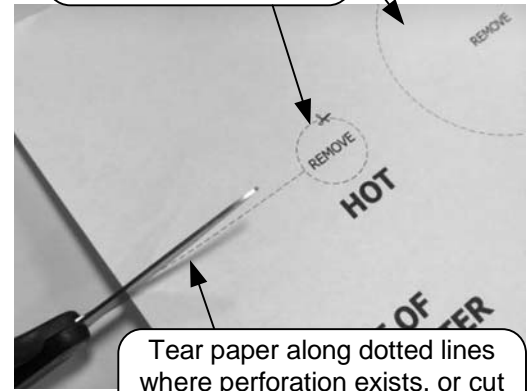

Tear paper along dotted lines where perforation exists, or cut with scissors.

Slip the template over the water connections. It is not necessary to remove the pipes connected to the water heater's inlet and outlet.

b.) Place the template on top of the water heater, being sure to have the arrows point towards the front of the water heater, which is the side where the drain and gas valve are located. Tape the template to the top of the water heater to hold it in place.



Place template on top of water heater in correct orientation.

c.) At each of the (3) "Drill Here" locations on the template, drill a 1/8" diameter hole through the template and the jacket head. Remove the template from the top of the water heater.

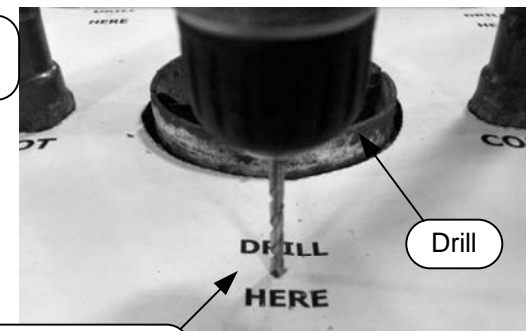

Drill (3) locations on top of water heater, where "Drill Here" is noted on the template.

**TTW1 Universal Service
Replacement Blower**
MITW -10 Series

Warning: Failure to install flue restrictor will result in improper water heater operation.

Step 7. Install the flue restrictor, P/N 239-47191-00, firmly on the flue. It may be necessary to lightly tap down the flue restrictor. Be sure to tap it evenly and straight down. Wire brush the top of the water heater if rust or corrosion exists.

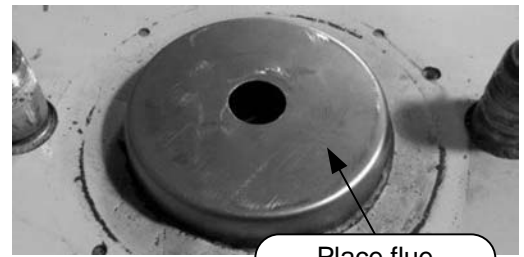

Place flue restrictor on flue.

Warning: Do NOT remove Torx head screws from universal blower.

Step 8. Instructions to remove power cord from new universal blower:
a.) Unscrew the (3) Philips head screws on the blower access cover and remove the cover. Keep the cover and screws for future use.

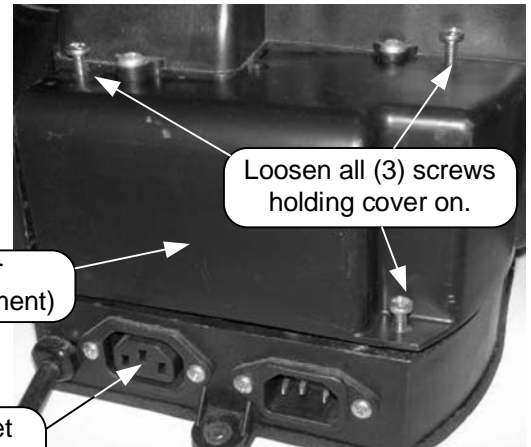

Loosen all (3) screws holding cover on.

Blower access cover (covers access compartment)

Power inlet connector

b.) Inside the access compartment, follow the black wire from the power cord until you reach the flag terminal attached to the end of the wire. Disconnect black wire from the back of the power inlet connector.

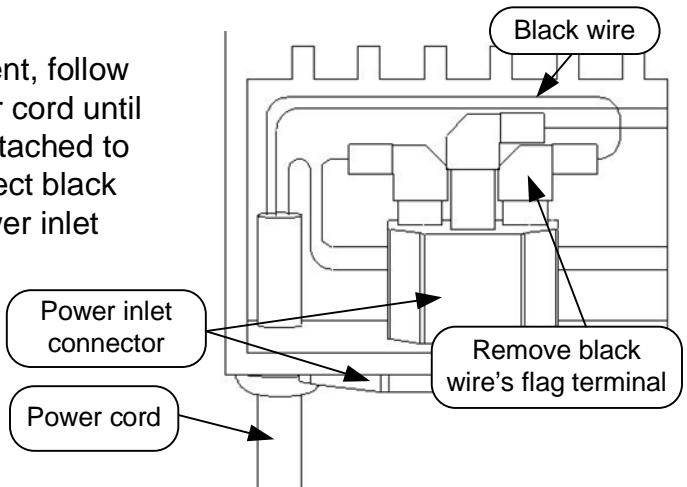

Black wire

Power inlet connector

Power cord

Remove black wire's flag terminal

**TTW1 Universal Service
Replacement Blower**
MITW -10 Series

Step 8.

- c.) Just below the crimp connector, cut the (3) white (neutral) wires. Remove the white power cord lead from the bundle. Then, strip the ends of the (2) remaining white wires and connect them using a wire nut, included with the kit, P/N 239-47281-00, and tuck the wires back into the lower portion of the access compartment.
- d.) Just below the crimp connector, cut the (3) green (ground) wires. Remove the green power cord lead from the bundle. Then, strip the ends of the (2) remaining green wires and connect them using a wire nut, included with the kit, P/N 239-47281-00, and tuck the wires back into the lower portion of the access compartment.

Cut just below these crimp connectors. Then, remove (1) white and (1) green wire from bundles. Trace wires back to power cord.

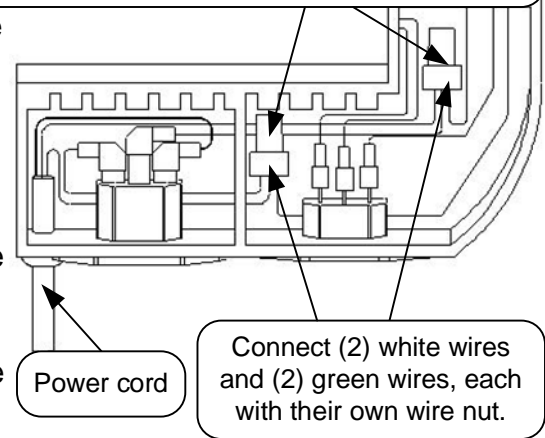

Warning: Make sure that each wire nut is securely tightened and that all wires are making good connection or improper water heater operation will occur.

- e.) Remove the power cord from the blower housing and discard.
- f.) Verify that all electrical connections have been modified, as previously indicated. Also, verify that the pressure switch tubing is connected to the pressure tap on the blower and to the switch itself. Ensure that the tubing is not kinked.

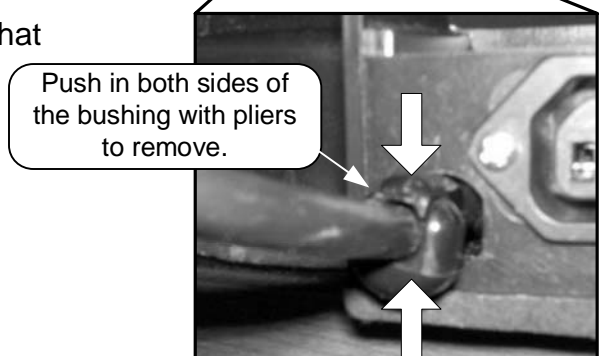
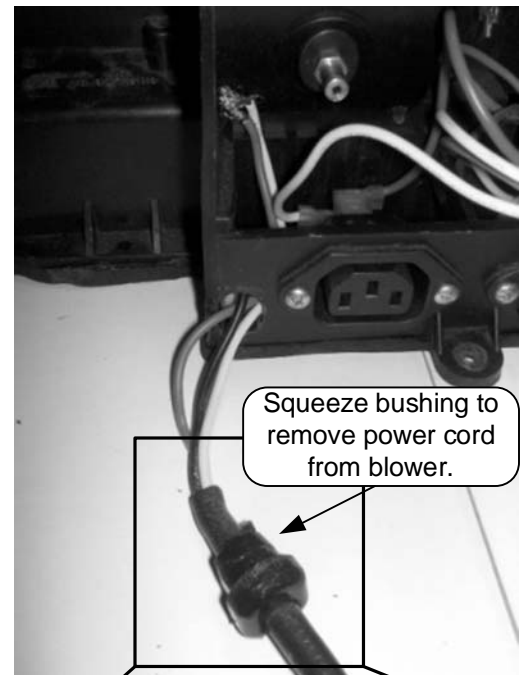

**TTW1 Universal Service
Replacement Blower**
MITW -10 Series

Step 9.

- a.) Ensure that the pressure switch, P/N 239-47192-02, is mounted in the vertical position, as shown. This pressure switch comes standard in the blower from the factory. Its vacuum setting should read -0.80" wc.
- b.) Place the access compartment cover back on the blower and secure with (3) screws from Step 8a. Start the lower screw first, and when doing so, make sure that the hole in the pressure switch's bracket matches up to the hole in the blower housing.

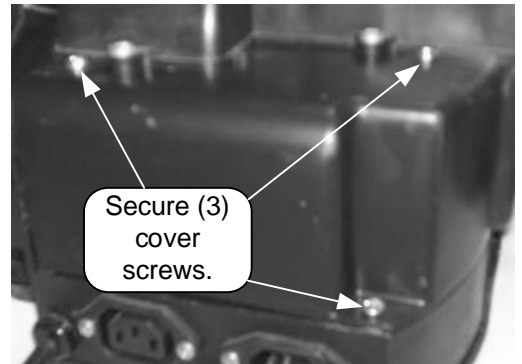
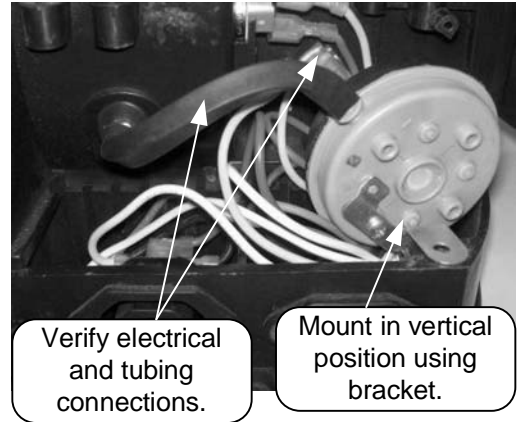

Warning: Do NOT over tighten (3) screws attaching the blower to the water heater.

- Step 10. Now that the universal blower is properly modified for a -10 series water heater, the blower can be properly positioned and secured on top of the water heater. To place the blower on the water heater, feed the blower from around the backside of the water connections. Secure the universal blower using (3) screws, P/N 239-44113-00, provided with the kit, into the pilot holes created in Step 6. Tighten them using a 1/4" nut driver.

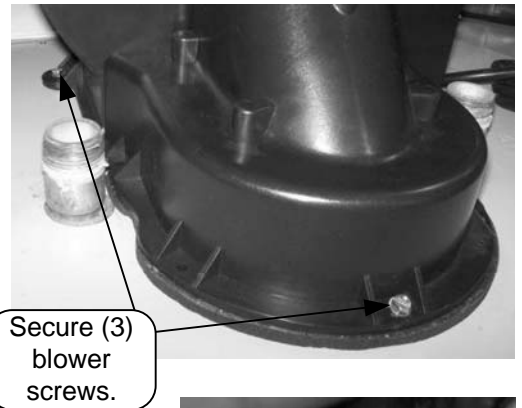

- Step 11. Find the correct universal blower wire harness provided with the kit, P/N 239-47193-00. Connect the wire harness to the receptacle in the jacket head and into the receptacles in the blower housing.

Plug both the blower cord sets into the blower receptacles.

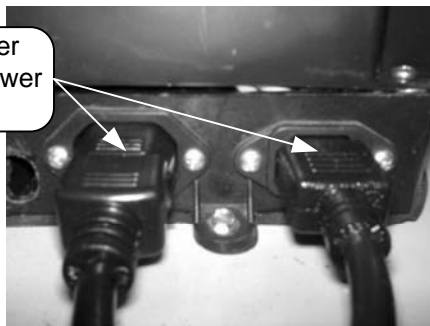

Insert other end of wire harness into receptacle on jacket head.

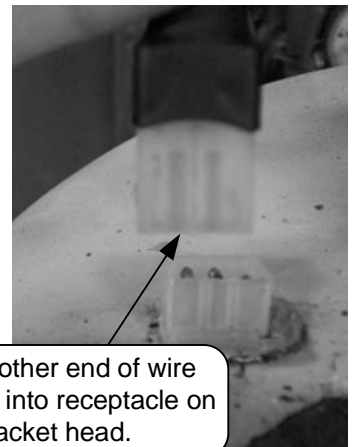

- Step 12. Find the rubber vent adapter kit, P/N 239-46263-00, provided with the blower kit. Install the 2" vent adapter on the exhaust side of the universal blower. Discard the vent terminal included with the vent adapter kit.

Note: In order to prevent condensate from draining back into the blower (vertical or horizontal runs), an optional condensate kit is available as a service part (Condensate kit, P/N 239-45875-00).

- Step 13. If it has not already been done, remove the old vent adapter from the existing vent pipe.
- Step 14. If necessary, re-route the vent pipe such that it can be properly seated in the top portion of the vent adapter.
- Step 15. Be sure that both clamps on the vent adapter are firmly tightened, securing the blower, vent adapter, and vent pipe together.
- Step 16. Double-check all vent connections.
- Step 17. Restore electrical power to the water heater.

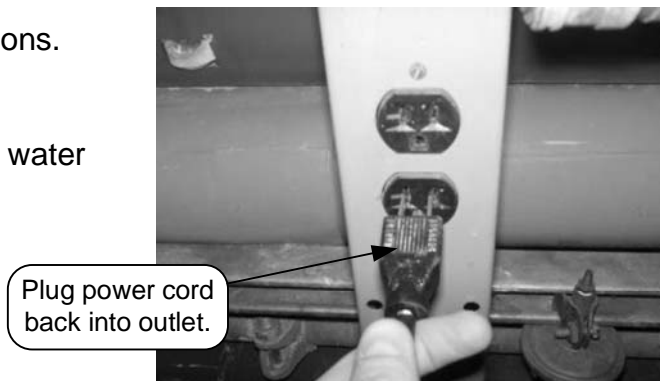
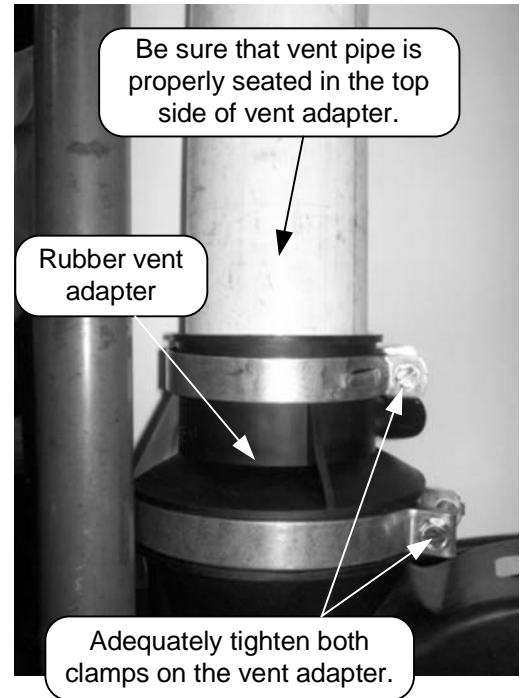

Warning: Check all safety devices to make sure they are working properly. Improper water heater operation could occur if these devices are not functioning properly.

**TTW1 Universal Service
Replacement Blower**
MITW -12 / -15 Series

Note: This set of instructions is for the following model numbers: MITW40L*EN12, MITW40L*BN12, MITW40L*CX12, MITW50L*EN12, MITW50L*BN12, MITW50L*CX12, MITW40L*EN15, MITW40L*BN15, MITW40L*CX15, MITW50L*EN15, MITW50L*BN15, and MITW50L*CX15.

Note: The following parts are required to convert the model numbers shown above: Template, Flue Restrictor, Screws, Wire Harness MITW-12/15 Series, Universal Blower, Transformer, Junction Box & its Cover, Wire Nuts, and 2" Exhaust Adapter / Vent Terminal Kit. Please refer to the Kit Components page (Page 3) for a picture of each item.



Step 1. On the water heater's gas control, turn the power switch to the "Off" position.

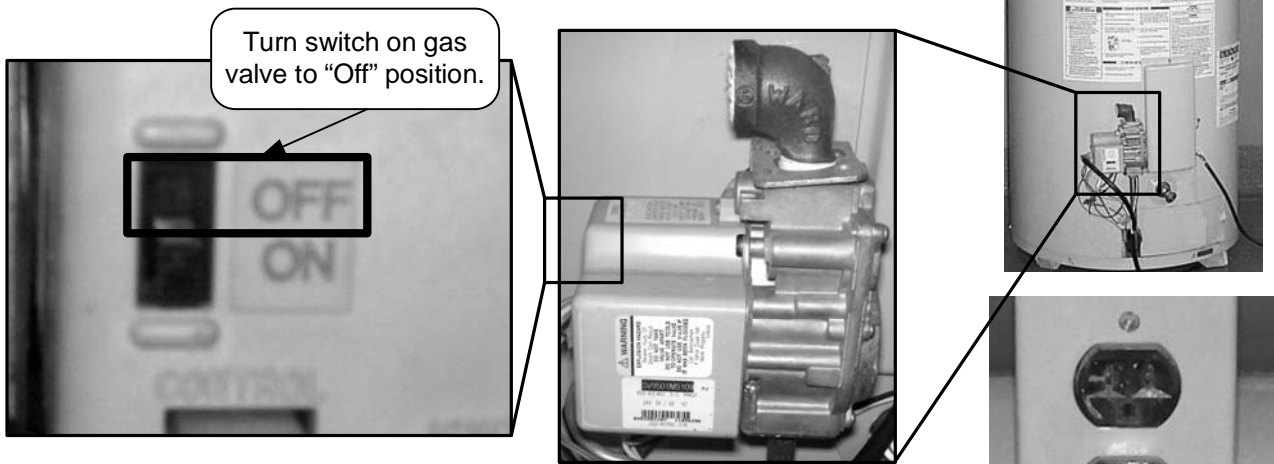

Step 2. Unplug the water heater from wall outlet.

Remove power cord from outlet.

Step 3. Disconnect the vent pipe and adapter that are connected to the outlet of the blower.

Unscrew both clamps that hold the adapter to the blower and vent pipe.

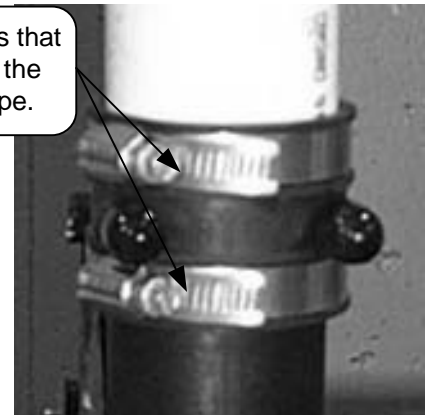

Step 4. Remove the screws, qty. (3), that secure the blower to the jacket head.

Unscrew (3) screws that hold blower to the jacket head.



Step 5. Disconnect blower wire harness from receptacle, located in the jacket head under the blower junction box. The white connector must be pinched to remove.

Blower junction box

Unplug blower harness from jacket head receptacle by pinching the connector.

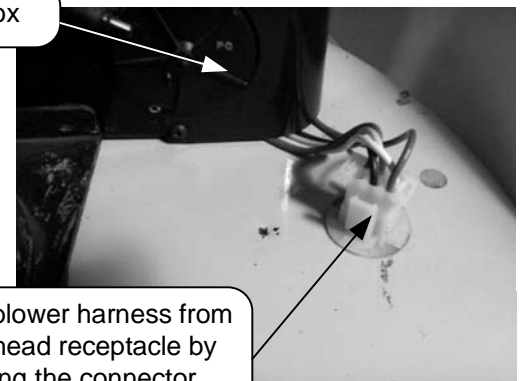

Step 6. Remove the blower from the top of the water heater. Remove any loose debris and tools from the top of the water heater.

Warning: Failure to locate the blower correctly will result in improper water heater operation.

The (3) circular sections on template have been pre-cut and removed.

Step 7. Create the new mounting hole locations for the new universal replacement blower. Use template supplied with manual.
a.) On the template, P/N 238-47197-00, the (3) circular sections for the water connections and flue have already been removed. Also, the dotted lines from the side of the paper are perforated for easy tearing.

Tear paper along dotted lines where perforation exists, or cut with scissors.

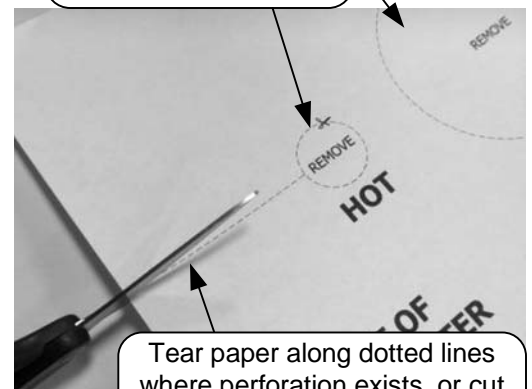

**TTW1 Universal Service
Replacement Blower**
MITW -12 / -15 Series

Step 7.

Slip the template over the water connections. It is not necessary to remove the pipes connected to the water heater's inlet and outlet.

- b.) Place the template on top of the water heater, being sure to have the arrows point towards the front of the water heater, which is the side where the drain and gas valve are located. Tape the template to the top of the water heater to hold it in place.



Place template on top of water heater in correct orientation.

- c.) At each of the (3) "Drill Here" locations on the template, drill a 1/8" diameter hole through the template and the jacket head. Remove the template from the top of the water heater.

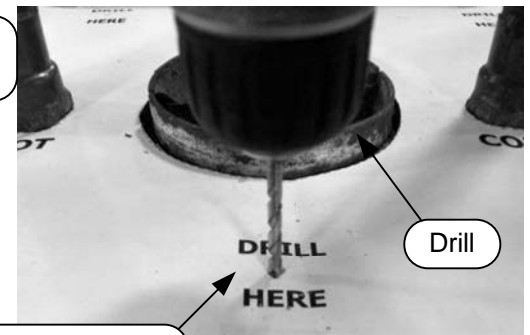

Drill (3) locations on top of water heater, where "Drill Here" is noted on the template.

Warning: Failure to install flue restrictor will result in improper water heater operation.

- Step 8.** Install the flue restrictor, P/N 239-47191-00, firmly on the flue. It may be necessary to lightly tap down the flue restrictor. Be sure to tap it evenly and straight down. Wire brush the top of the water heater if rust or corrosion exists.

Place flue restrictor on flue.

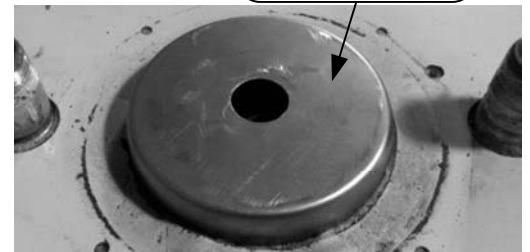

Warning: Do NOT remove Torx head screws from universal blower.

- Step 9.** Instructions to remove power cord from new universal blower:
a.) Unscrew the (3) Philips head screws on the blower access cover and remove the cover. Keep the cover and screws for future use.

Loosen all (3) screws holding cover on.

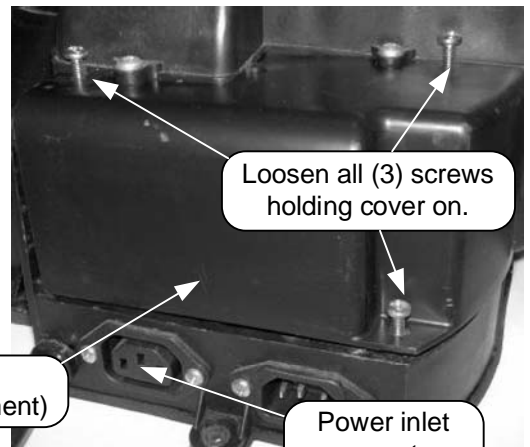

Blower access cover
(covers access compartment)

Power inlet
connector

Step 9.

b.) Inside the access compartment, follow the black wire from the power cord until you reach the flag terminal attached to the end of the wire. Disconnect black wire from the back of the power inlet connector.

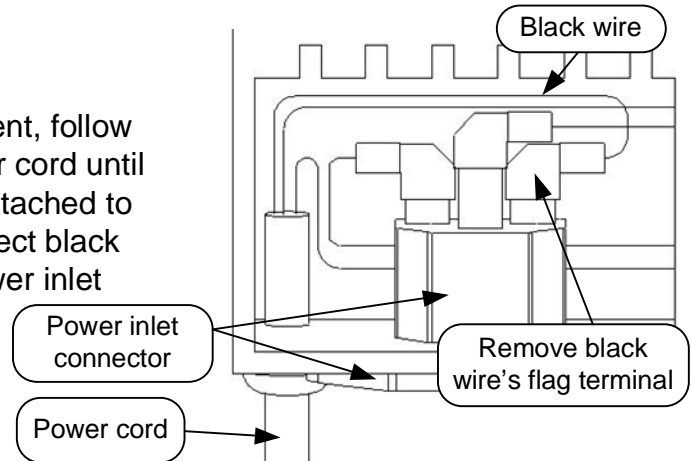

c.) Just below the crimp connector, cut the (3) white (neutral) wires. Remove the white power cord lead from the bundle. Then, strip the ends of the (2) remaining white wires and connect them using a wire nut, included with the kit, P/N 239-47281-00, and tuck the wires back into the lower portion of the access compartment.

Cut just below these crimp connectors. Then, remove (1) white and (1) green wire from bundles. Trace wires back to power cord.

d.) Just below the crimp connector, cut the (3) green (ground) wires. Remove the green power cord lead from the bundle. Then, strip the ends of the (2) remaining green wires and connect them using a wire nut, included with the kit, P/N 239-47281-00, and tuck the wires back into the lower portion of the access compartment.

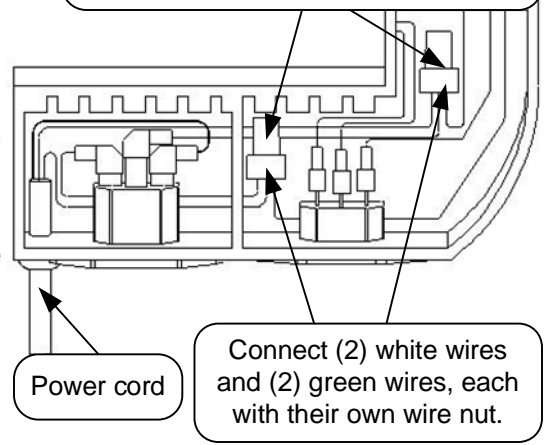

Warning: Make sure that each wire nut is securely tightened and that all wires are making good connection or improper water heater operation will occur.

e.) Remove the power cord from the blower housing and discard.

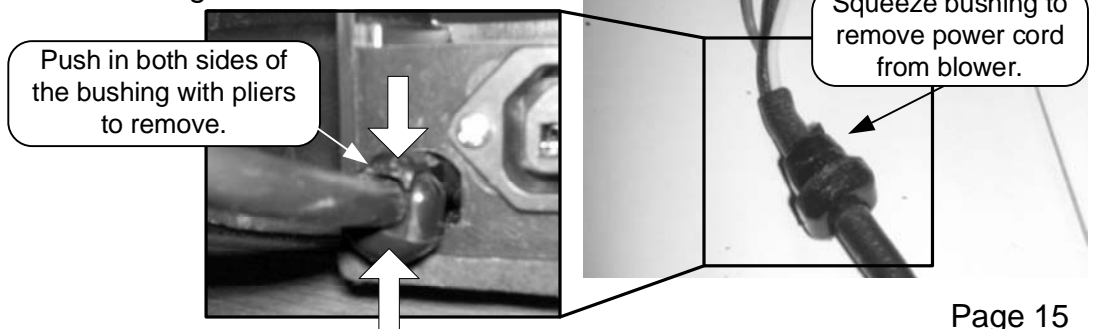

**TTW1 Universal Service
Replacement Blower**
MITW -12 / -15 Series

Step 9.

- f.) Verify that all electrical connections have been modified, as previously indicated. Also, verify that the pressure switch tubing is connected to the pressure tap on the blower and to the switch itself. Ensure that the tubing is not kinked.

Step 10.

- a.) Ensure that the pressure switch, P/N 239-47192-02, is mounted in the vertical position, as shown. This pressure switch comes standard in the blower from the factory. Its vacuum setting should read -0.80" wc.

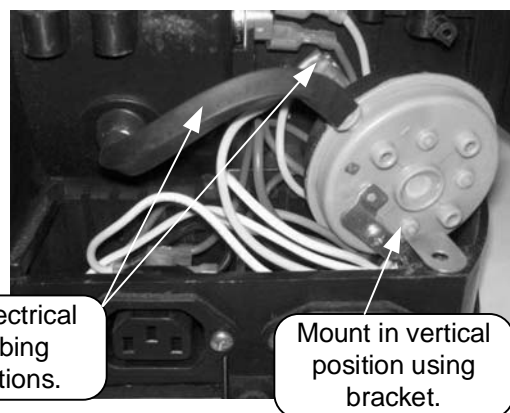

- b.) Place the access compartment cover back on the blower and secure with (3) screws from Step 9a. Start the lower screw first, and when doing so, make sure that the hole in the pressure switch's bracket matches up to the hole in the blower housing.

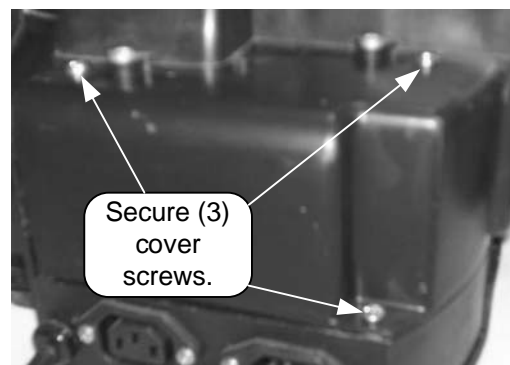

Warning: Do NOT over tighten (3) screws attaching the blower to the water heater.

Step 11.

Now that the universal blower is properly modified for a -12/-15 series water heater, the blower can be properly positioned and secured on top of the water heater. To place the blower on the water heater, feed the blower from around the backside of the water connections. Secure the universal blower using (3) screws, P/N 239-44113-00, provided with the kit, into the pilot holes created in Step 7. Tighten them using a 1/4" nut driver.

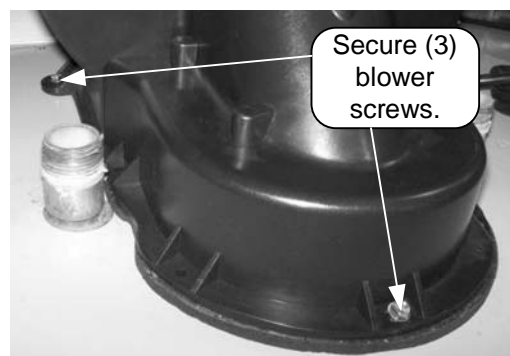

Step 12.

- a.) Position the junction box, P/N 239-47196-00, on top of the water heater, in front of the blower, and on the side nearest the T&P valve.
- b.) Place the transformer, P/N 265-44072-01, inside the junction box such that there is sufficient room between its (4) posts and the sidewalls of the junction box. Determine the side to remove a knock-out. Remove the transformer from the junction box.

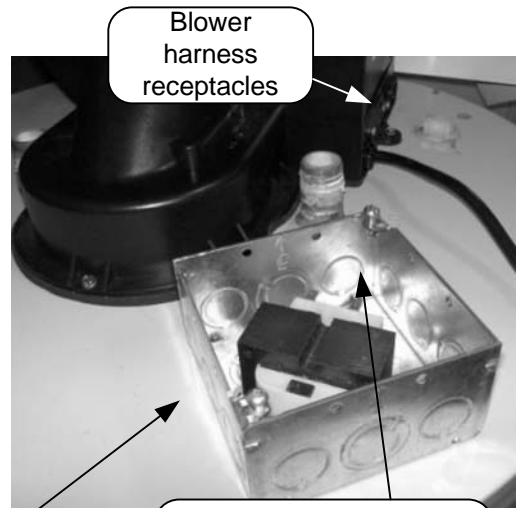

Place junction box on top of water heater and transformer in box.

Leave room in corner closest to blower harness receptacles to attach terminals to transformer.

- c.) On a side opposite the transformer's posts, remove (1) knock-out $\frac{3}{4}$ " in size. Then, place the junction box back on the water heater and the transformer back into the box.

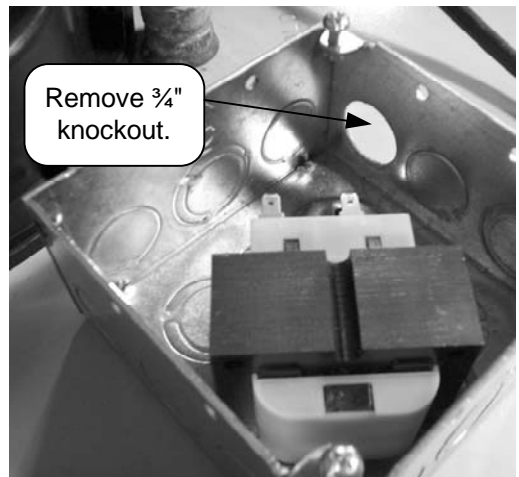

- d.) Mark the location of the mounting holes of the transformer onto the junction box.
- e.) Remove the transformer from the junction box.
- f.) Drill (2) $\frac{1}{8}$ " diameter holes in the locations that were marked in Step 12d. Be sure that the pilot holes are through the junction box and jacket head.

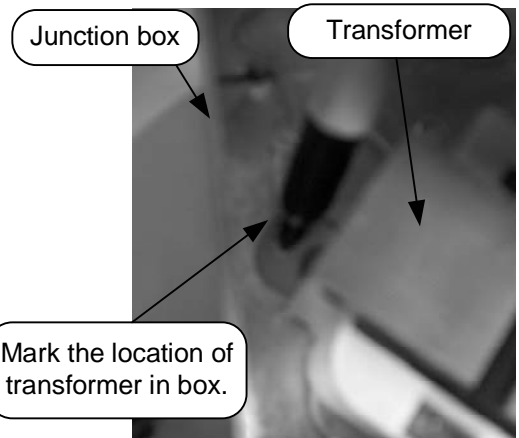

**TTW1 Universal Service
Replacement Blower**
MITW -12 / -15 Series

Step 13. Locate new blower harness, P/N 239-47194-00, provided with the kit. Route loose wire ends (yellow, blue, white, and green) through knock-out opening from Step 12c.

Step 14. Fasten conduit connector to the junction box.

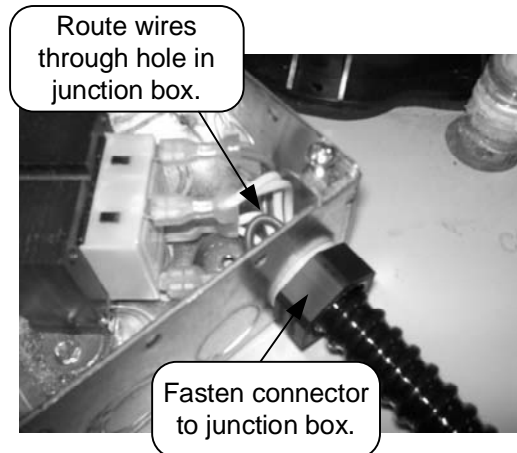

Step 15. Connect the wire terminals to their corresponding locations on the transformer:

- a.) (2) Blue wires and wire terminal to the 120V-Hot post
- b.) (2) White wires and wire terminal to the 120V-Common post
- c.) (2) Yellow wires and wire terminal to the 24V-Hot post
- d.) (2) Green wires and wire terminal to the 24V-Common post

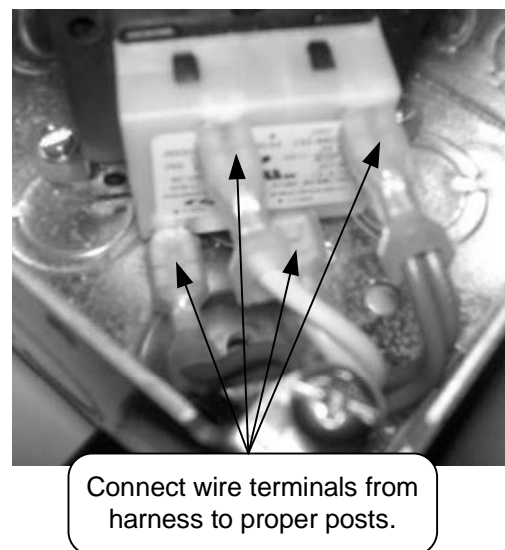

Warning: Do NOT over tighten (2) screws attaching the transformer and junction box to the water heater.

Step 16. Place the transformer all the way back into the junction box and fasten both to the water heater using (2) screws, P/N 239-44113-00, provided with the kit.

Fasten transformer and junction box to jacket head (Second screw not shown).

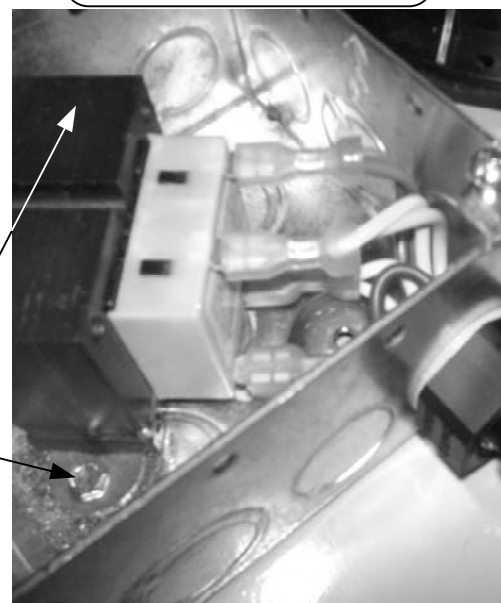

Step 17. Secure the junction box cover, P/N 239-47199-00, to the junction box.

Tighten (2) screws on junction box to secure cover.

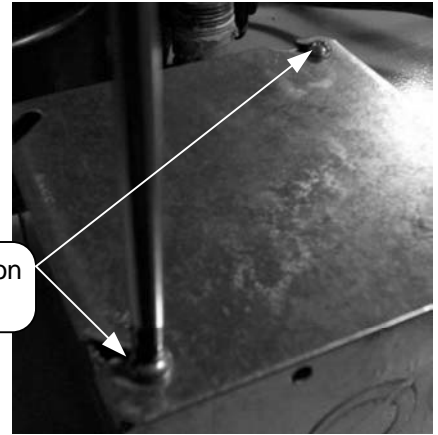

Step 18. With the blower and transformer assembly fastened to the water heater, the remaining ends of the blower wire harness can now be attached with the cord sets to the blower and then the white connector to the receptacle in the jacket head.

Plug cord sets into receptacles in blower.

Plug white connector into receptacle in jacket head.

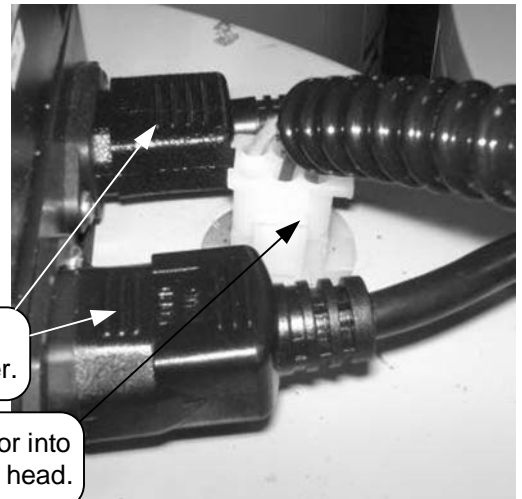

Step 19. Find the rubber vent adapter kit, P/N 239-46263-00, provided with the blower kit. Install the 2" vent adapter on the exhaust side of the universal blower. Discard the vent terminal included with the vent adapter kit.

Note: In order to prevent condensate from draining back into the blower (vertical or horizontal runs), an optional condensate kit is available as a service part (Condensate kit, P/N 239-45875-00).

Be sure that vent pipe is properly seated in the top side of vent adapter.

Rubber vent adapter

Adequately tighten both clamps on the vent adapter.

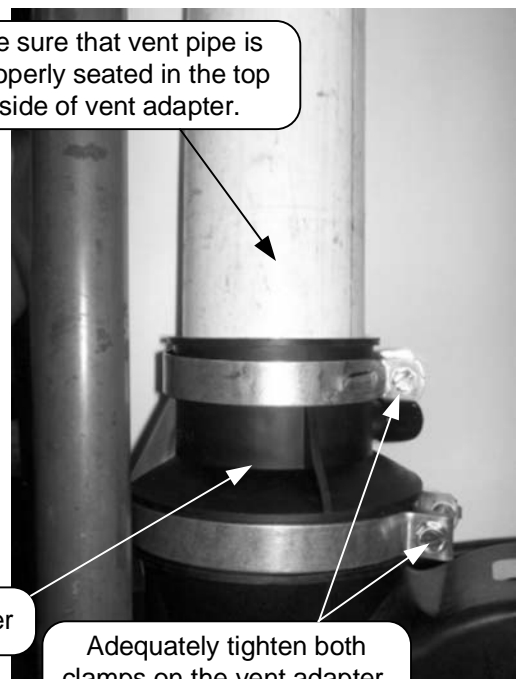

**TTW1 Universal Service
Replacement Blower**
MITW -12 / -15 Series

- Step 20. If it has not already been done, remove the old vent adapter from the existing vent pipe.
- Step 21. If necessary, re-route the vent pipe such that it can be properly seated in the top portion of the vent adapter.
- Step 22. Be sure that both clamps on the vent adapter are firmly tightened, securing the blower, vent adapter, and vent pipe together.
- Step 23. Double-check all vent connections.
- Step 24. Restore electrical power to the water heater.

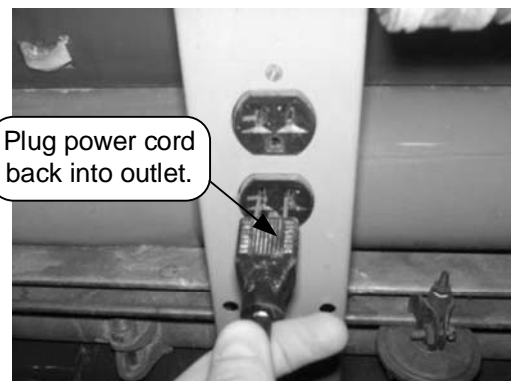

- Step 25. On the water heater's gas control, turn the power switch to the "On" position.

Turn switch on gas valve to "On" position.

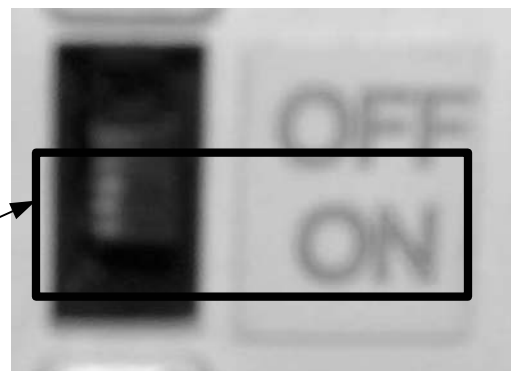

Warning: Check all safety devices to make sure they are working properly. Improper water heater operation could occur if these devices are not functioning properly.

**TTW1 Universal Service
Replacement Blower
MITW Series**

Note: This set of instructions is for the following model numbers:
M1TW40S*BN, M1TW40S*CX, M1TW50S*BN,
M1TW50S*CX, M1TW40S*FBN, M1TW40S*FCX,
M1TW50S*FBN, M1TW50S*FCX, M1TW60T*FBN, and
M1TW60T*FCX.

Note: The following parts are required to convert the model numbers
shown above: Screws, Universal Blower, Dilution Air Orifice,
Pressure Switch (-0.70" wc, for high altitude only), and 2"
Exhaust Adapter / Vent Terminal Kit. Please refer to the Kit
Components page (Page 3) for a picture of each item.



Step 1. On the water heater's gas control, turn the power switch to the "Off" position.

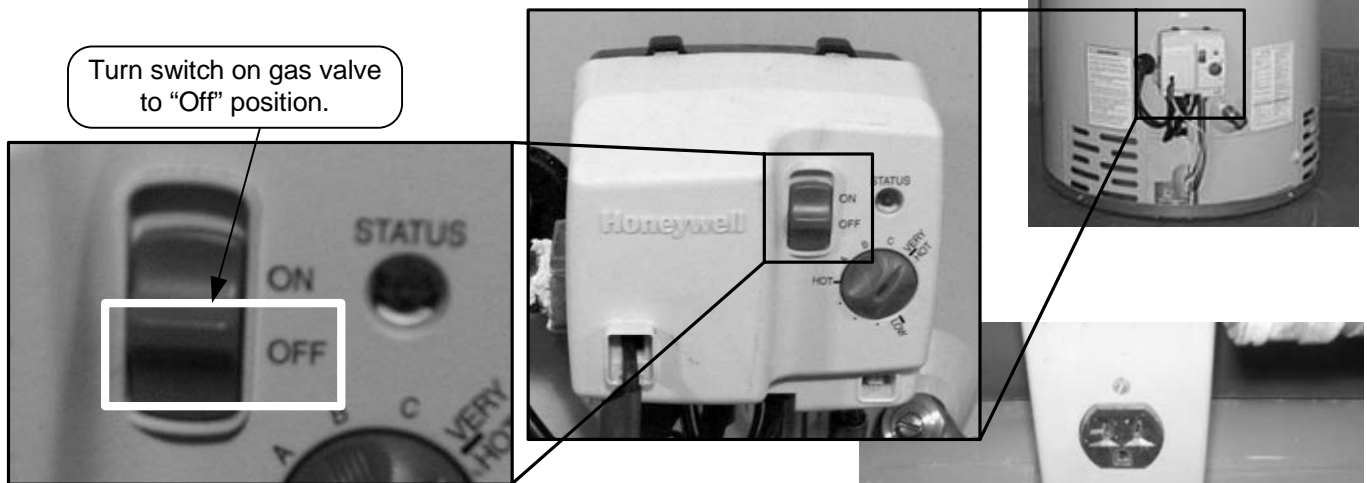

Step 2. Unplug water heater from wall outlet.

Step 3. Disconnect blower cord sets from receptacles located in the blower housing.

**TTW1 Universal Service
Replacement Blower**
MITW Series

Step 4. Disconnect the vent pipe and adapter that are connected to the outlet of the blower.

Unscrew both clamps that hold the adapter to the blower and vent pipe.

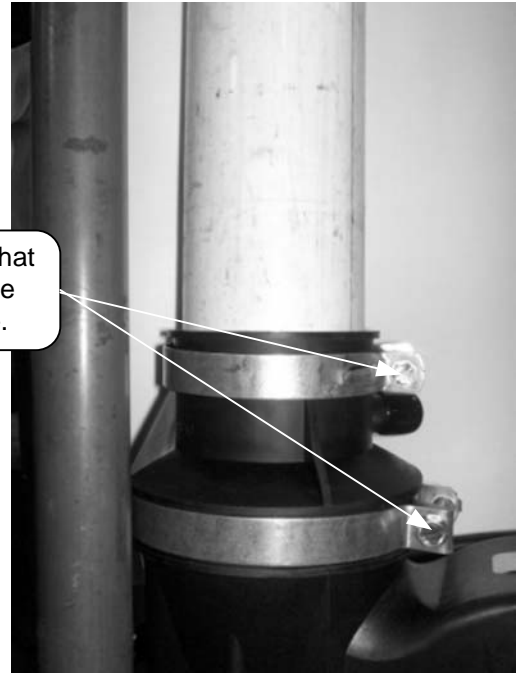

Unscrew (3) screws that hold blower to the jacket head.

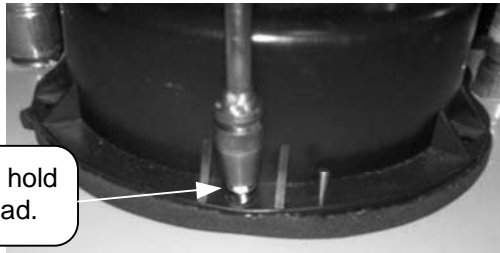

Step 5. Remove the screws, qty. (3), that secure the blower to the jacket head.

Step 6. Remove blower from the top of the water heater. Remove any loose debris and tools from the top of the water heater.

Warning: For normal altitude applications (2000 ft. & below), proceed to Step 8.
Otherwise, for high altitude applications (2001 ft. & above), continue with Step 7.

Step 7. Instructions to replace universal blower pressure switch:

Warning: Only replace the pressure switch if the water heater is being used in high altitude application. Failure to replace universal blower pressure switch will result in improper water heater operation.

a.) Unscrew the (3) Philips head screws on the blower access cover and remove the cover. Keep the cover and screws for future use.

Warning: Do NOT remove Torx head screws from universal blower.

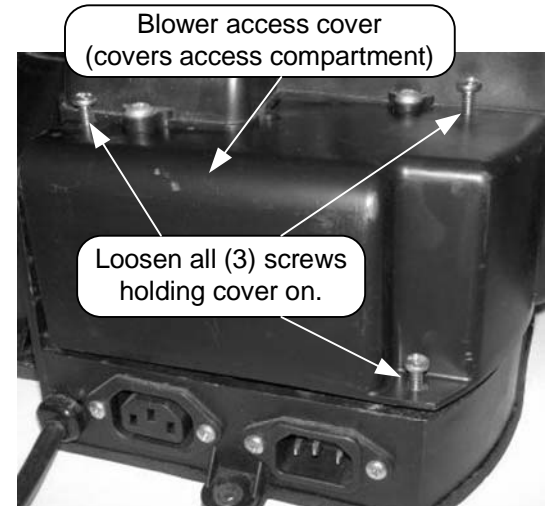

**TTW1 Universal Service
Replacement Blower
MITW Series**

Step 7.

- b.) Replace the current pressure switch ONLY IF the model is for high altitude (2001 ft. & above).

Disconnect (2) flag terminals and tubing from pressure switch to remove.

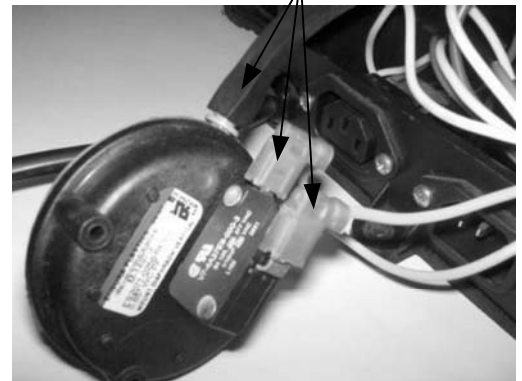

Warning: Failure to replace universal blower pressure switch for high altitude will result in improper water heater operation.

Choose corresponding pressure switch from kit. Verify correct P/N and setting on label to match this model's requirements, as shown in Step 7b.

- i. For high altitude applications, the factory installed pressure switch must be replaced. The correct pressure switch is P/N 239-47192-01 with a setting of -0.70" wc.
- c.) When installing the high altitude pressure switch, be sure to reconnect the pressure switch tubing to both the pressure tap and the switch itself. Also, reconnect the wires for the pressure switch circuit to the new pressure switch. Ensure that the tubing is not kinked.

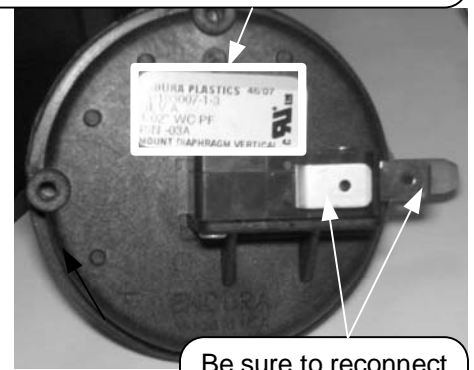

Be sure to reconnect tubing and (2) flag terminals.

Step 8.

- a.) Ensure that once in place, the pressure switch should be mounted such that its diaphragm is in the vertical position.

Verify electrical and tubing connections.

Mount in vertical position using bracket.

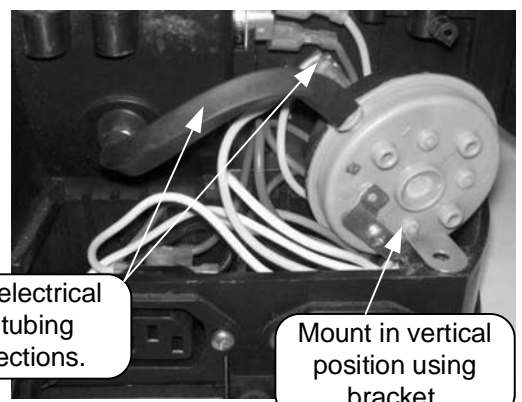

**TTW1 Universal Service
Replacement Blower**
MITW Series

Step 8.

- b.) Place the access compartment cover back on the blower and secure it with its (3) screws from Step 7a. Start the lower screw first, and when doing so, make sure that the hole in the pressure switch's bracket matches up to the hole in the blower housing.

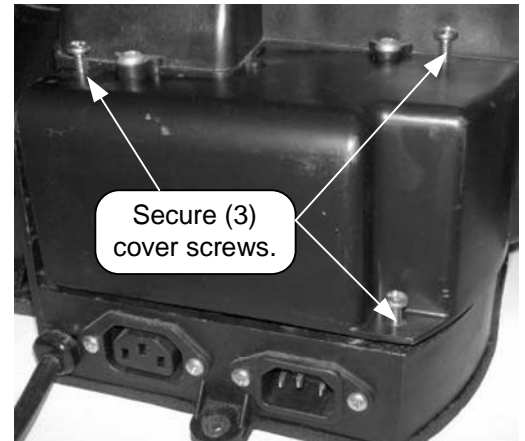

Step 9.

- a.) Remove the intake boot from the rear of the blower.

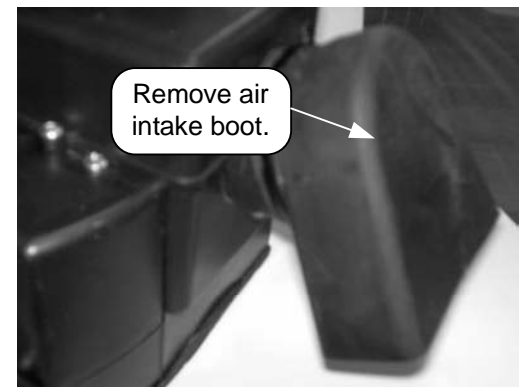

- b.) Place dilution air orifice, P/N 239-47190-00, in the hole, located in the rear of the blower, being sure to adjust the slot in the orifice such that it is horizontal, as shown.

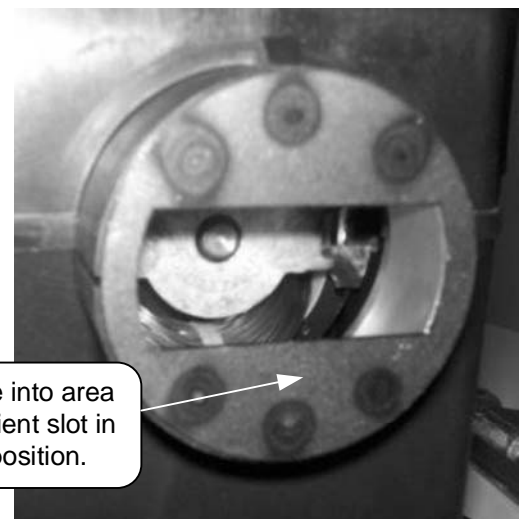

Step 9.

c.) Replace the intake boot back onto the blower. If it is necessary, the cable, or zip, tie can be removed from the boot to allow for easier assembly.

Replace boot on rear of blower.

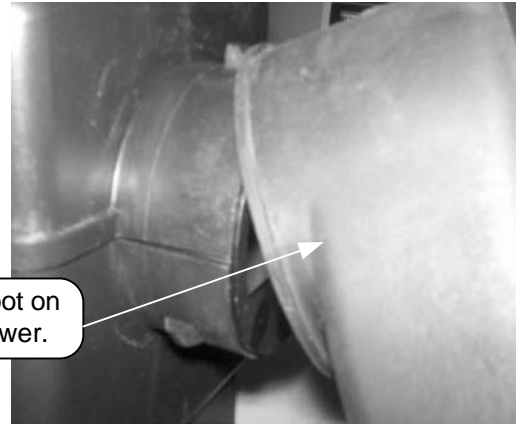

Remove cable tie if boot will not go onto rear of blower easily.

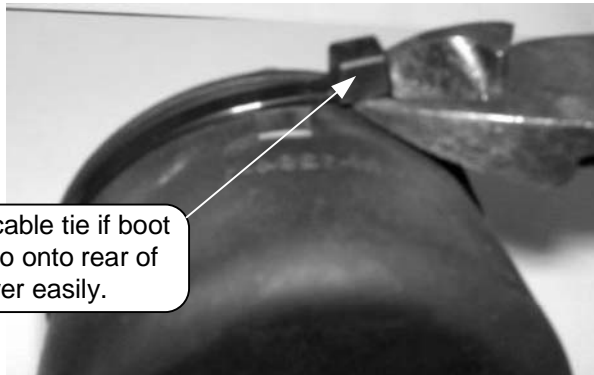

Boot back in place.

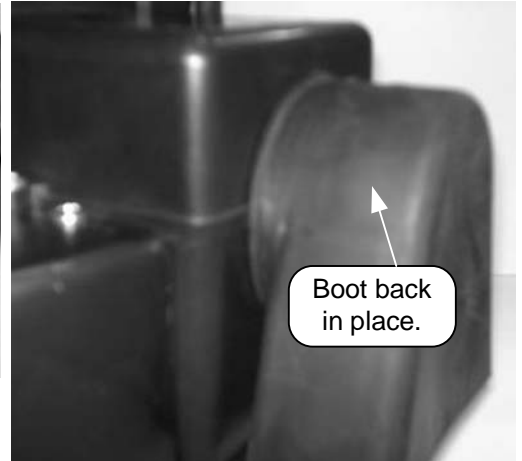

Step 10.

Now that the universal blower is properly modified for a M1TW series water heater, the blower can be properly positioned and secured on top of the water heater. To place the blower on the water heater, feed the blower from around the backside of the water connections. Secure the universal blower using (3) screws, P/N 239-44113-00, provided with the kit, into the pre-existing holes used to fasten the original blower. Tighten them using a ¼" nut driver.

Secure (3) blower screws.

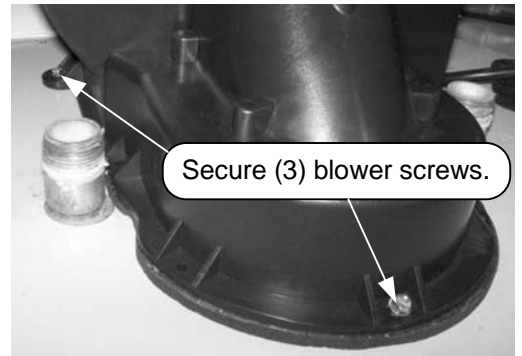

Plug blower harness cord sets into blower housing receptacles.

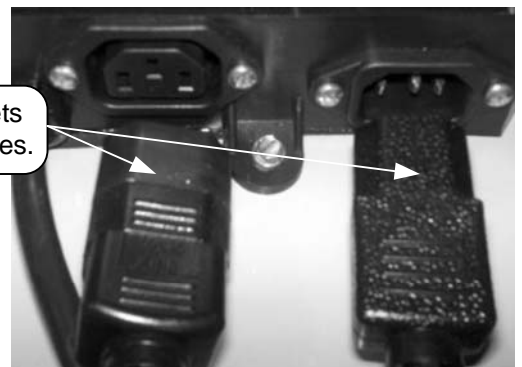

Step 11.

With the blower securely fastened to the water heater, the blower wire harness cord sets can now be re-connected to the blower housing.

**TTW1 Universal Service
Replacement Blower**
MITW Series

Step 12. Find the rubber vent adapter kit, P/N 239-46263-00, provided with the blower kit. Install the 2" vent adapter on the exhaust side of the universal blower. Discard the vent terminal included with the vent adapter kit.

Be sure that vent pipe is properly seated in the top side of vent adapter.

Note: In order to prevent condensate from draining back into the blower (vertical or horizontal runs), an optional condensate kit is available as a service part (Condensate kit, P/N 239-45875-00).

Step 13. If the new adapter is used, remove the old vent adapter from the existing vent pipe.

Step 14. Be sure that both clamps on the vent adapter are firmly tightened, securing the blower, vent adapter, and vent pipe together.

Step 15. Double-check all vent connections.

Step 16. Restore electrical power to the water heater.

Step 17. On the water heater's gas control, turn the power switch to the "On" position.

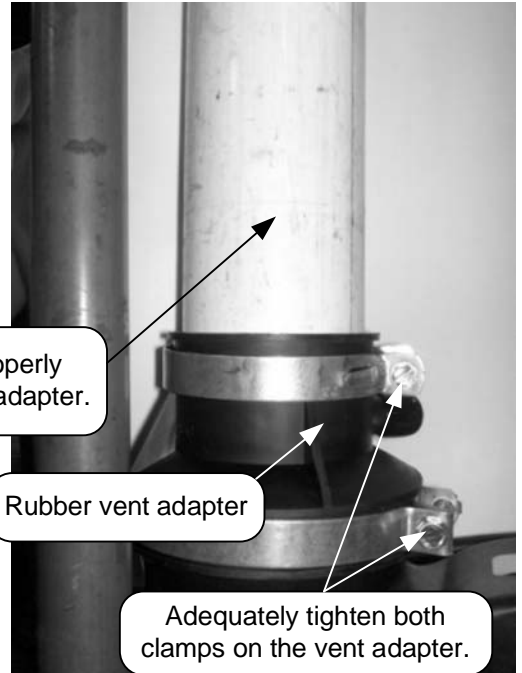

Rubber vent adapter

Adequately tighten both clamps on the vent adapter.

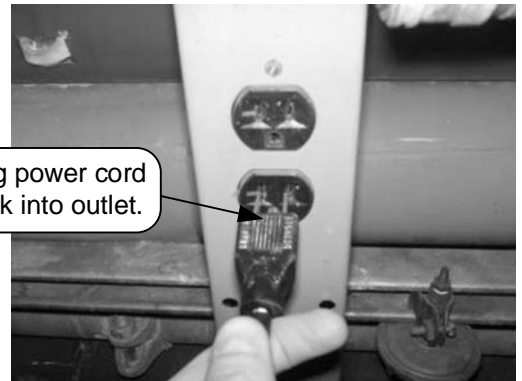

Plug power cord back into outlet.

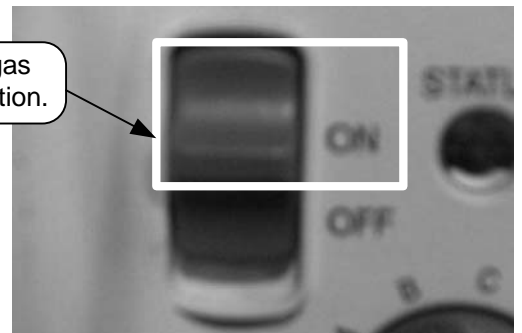

Turn switch on gas valve to "On" position.

Warning: Check all safety devices to make sure they are working properly. Improper water heater operation could occur if these devices are not functioning properly.

