



CX407

SUPER 3 SPEED AIR CLEANER

User Manual



TABLE OF CONTENTS

General Safety Instructions for Machines	3
Specific Safety Instructions	4
CX407 Features.....	5
Un-Packing & Inventory	6
Proper Grounding	7
Mounting	8
Table Top Mount.....	8
Hanging Mounting.....	8
Flush Mount	9
Control Panel	10
Remote Controller.....	11
Filters	11
Changing / Servicing the Filters	12
Parts Breakdown.....	13
Parts List.....	14
Warranty	15

GENERAL SAFETY INSTRUCTIONS FOR MACHINES

Extreme caution should be used when operating all power tools. Know your power tool, be familiar with its operation, read through the user manual and practice safe usage procedures at all times.

- ❖ **ALWAYS** read and understand the user manual before operating the machine.
- ❖ **CONNECT** your machine ONLY to the matched and specific power source.
- ❖ **ALWAYS** wear safety glasses respirators, hearing protection and safety shoes, when operating your machine.
- ❖ **DO NOT** wear loose clothing or jewelry when operating your machine. Wear protective hair covering.
- ❖ **A SAFE ENVIRONMENT** is important. Keep the area free of dust, dirt and other debris in the immediate vicinity of your machine.
- ❖ **BE ALERT! DO NOT** use prescription or other drugs that may affect your ability or judgment to safely use your machine.
- ❖ **DISCONNECT** the power source when changing drill bits, hollow chisels, router bits, shaper heads, blades, knives or making other adjustments or repairs.
- ❖ **NEVER** leave a tool unattended while it is in operation.
- ❖ **NEVER** allow unsupervised or untrained personnel to operate the machine
- ❖ **NEVER** reach over the table when the tool is in operation.
- ❖ **ALWAYS** keep blades, knives and bits sharpened and properly aligned.
- ❖ **ALL OPERATIONS MUST BE** performed with the guards in place to ensure safety.
- ❖ **ALWAYS** use push sticks and feather boards to safely feed your work through the machine.
- ❖ **ALWAYS** make sure that any tools used for adjustments are removed before operating the machine.
- ❖ **ALWAYS** keep bystanders safely away while the machine is in operation.
- ❖ **NEVER** attempt to remove jammed cutoff pieces until the blade has come to a full stop.

CX407 – SUPER 3 SPEED AIR CLEANER

SPECIFIC SAFETY INSTRUCTIONS

- ❖ **ALWAYS** read and understand the user manual before operating the air cleaner.
- ❖ **CX407 IS ONLY** designed to remove very fine wood particles from the air. Do not use it as a dust collector.
- ❖ **ALWAYS** secure any aprons, clothing and long hair away from the intake side of the air cleaner unit and any moving parts.
- ❖ **ALWAYS** research the dangers of the specific species of wood you are working with, as dust from some woods are toxic and can make you sick and lead to long term respiratory problems.
- ❖ **KEEP** your fingers and tools away from the fan output screen during fan operation.
- ❖ **ALWAYS** keep the filters serviced and never attempt to replace filters while the air cleaner is operating.
- ❖ **ONLY** operate this air cleaner in a dry environment.
- ❖ **DO NOT** operate this air cleaner in an environment that has volatile fumes from fuels, paints, pesticides, smoke, etc.
- ❖ **NEVER** operate the air cleaner in an environment that has the particles of silica, metal, asbestos, or hazardous bacteria.
- ❖ **MAKE SURE** before making any adjustments, servicing or installing parts, the switch is in the “OFF” position and the cord is un-plugged from the power source.
- ❖ **DO NOT** place your hands or tools near the open inlet during operation for any reason.
- ❖ **ALWAYS** make sure that the air cleaner is in a stable position, either it is hung from the ceiling or placed on the table.
- ❖ **MAKE SURE** you have read and understood all the safety instructions in the manual and you are familiar with your air cleaner, before operating it. If you fail to do so, serious injury could occur.

WARNING!

The safety instructions given above can not be complete because the environment in every shop is different. Always consider safety first as it applies to your individual working conditions.



CX407 - AIR CLEANER FEATURES

MODEL CX407 - SUPER 3 SPEED AIR CLEANER

As part of the growing line of Craftex woodworking equipment, we are proud to offer the CX407, a Super 3 Speed Air Cleaner. By following the instructions and procedures laid out in this user manual, you will receive years of excellent service and satisfaction. The CX407 is a professional tool and like all power tools, proper care and safety procedures should be adhered to.

- ⊞ Motor 1/5-HP, 120-Volts, Single Phase, 60-Hz
- ⊞ Motor Low Speed 750 RPM
- ⊞ Motor Medium speed..... 960 RPM
- ⊞ Motor High Speed..... 1200 RPM
- ⊞ Fan Low Speed Sound Rating..... 62 dB
- ⊞ Fan Medium Speed Sound Rating.. 67 dB
- ⊞ Fan High Speed Sound Rating 69 dB
- ⊞ Air Flow at Low Speed..... 556 CFM
- ⊞ Air Flow at Medium Speed... 702 CFM
- ⊞ Air Flow at High Speed..... 1044 CFM
- ⊞ Primary Filter 5-Micron
- ⊞ Secondary Filter 1-Micron
- ⊞ Unit Dimensions Length 30-1/4" x Width 24-1/8" x Height 12-1/8"
- ⊞ Weight 56 lbs
- ⊞ Warranty 3 Years

UNPACKING

The machine is properly packaged and shipped completely in box for safe transportation. When unpacking, carefully inspect the box and ensure that nothing has been damaged during transit. Open the box and check that the machine and the parts are in good condition.

WARNING!

CX407 is a heavy machine, do not over-exert yourself.

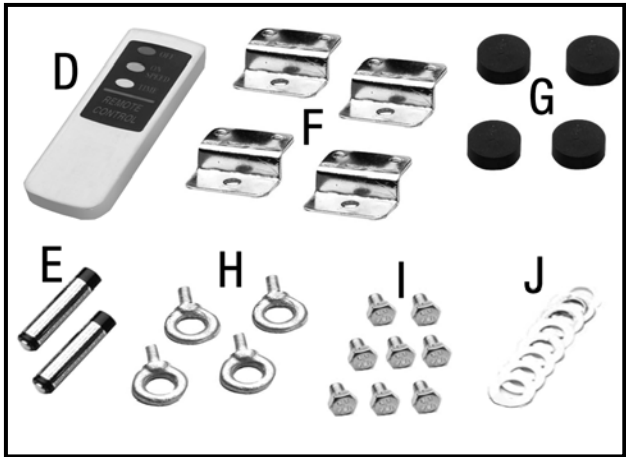

Figure-2 Inventory

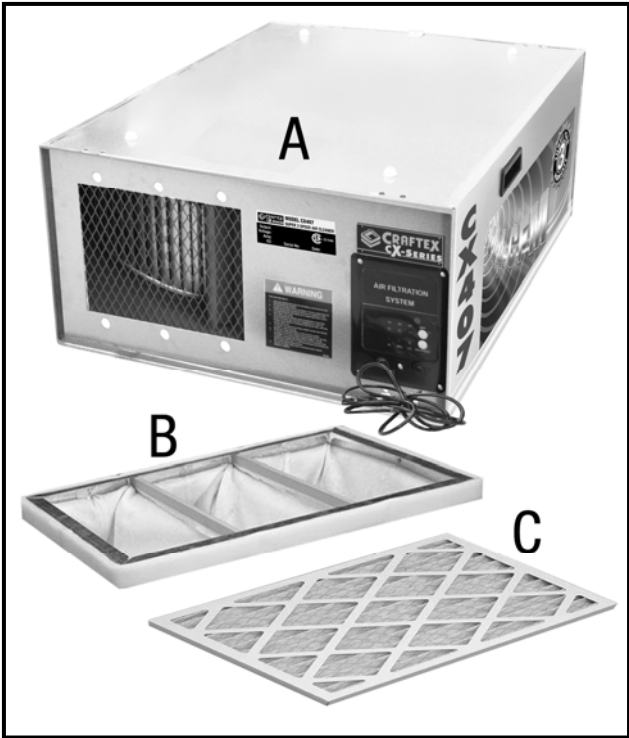

Figure-1 Inventory

LIST OF CONTENTS	QTY
D. Remote Control.....	1
E. AAA Battery	2
F. Flange Bracket.....	4
G. Rubber Feet.....	4
H. Eye Bolts (M10 - 1.5)	4
I. Hex Bolts (M6-1.0 x 8)	8
J. Flat Washers (6 mm)	8

NOTE: While doing inventory, if you can not find any part, check if the part is already installed on the machine.

Some of the parts come preassembled with the machine because of shipping purposes.

LIST OF CONTENTS	QTY
A. Air Cleaner	1
B. Primary Filter (5-Micron).....	1
C. Secondary Filter (1-Micron).....	1



PROPER GROUNDING

Grounding provides a path of least resistance for electric current to reduce the risk of electric shock.

Make sure the cord is plugged into a properly installed and grounded power outlet. To prevent electrical hazards, have a qualified electrician ensure that the line is properly wired.

Make sure that the air cleaner is connected to an outlet having the same configuration as the plug. If an adaptor plug is used, it must be attached to the metal screw of the receptacle.

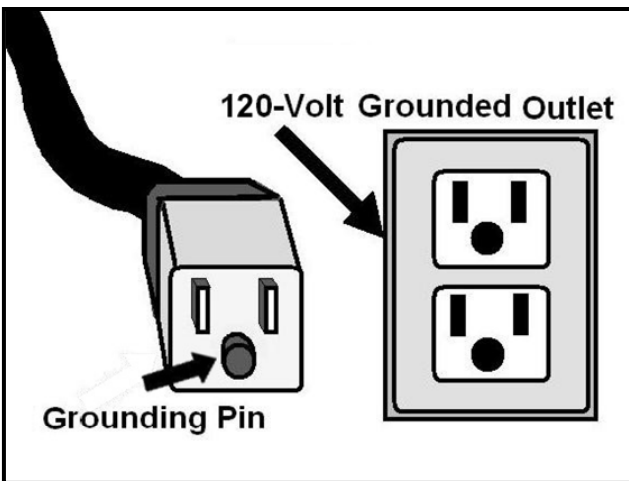

Figure-3 120-Volts Outlet for CX407

It is strongly recommended not to use extension cords with your CX407. Always try to position your machine close to the power source so that you do not need to use extension cords.

If you really find it necessary to use an extension cord, make sure the extension cord does not exceed 50-feet in length and the cord is 14-gauge to prevent motor damage.

WARNING!

Improper connection of the equipment-grounding conductor can result in a risk of electric shock. Check with a qualified electrician if you are in doubt as to whether the outlet is properly grounded.

MOUNTING

The CX407 can be mounted in three ways:

TABLE TOP MOUNT: Using rubber feet and/or the flush mount flange brackets for a table-top application.

HANGING MOUNT: Using the eye bolts for a high ceiling application.

FLUSH MOUNT: Using the flange brackets for a wall or low ceiling application.

WARNING!

Make sure the air cleaner is OFF and the cord is disconnected from the power source while installing, removing, servicing and performing any maintenance job.

TABLE TOP MOUNT

The CX407 can be used as a portable air filtration system by installing the rubber feet and placing the unit on a work-bench or a table.

To set up the air cleaner for table top operation:

Get the help of an assistant and carefully place the air cleaner unit upside down.

The rubber feet feature sticky backing. Attach the rubber feet to the bottom of the air cleaner as shown in figure-4.

For permanent table top mounting, refer to the Flush Mount procedure on page-9 and install the unit on the table top with the flush mount flange brackets.

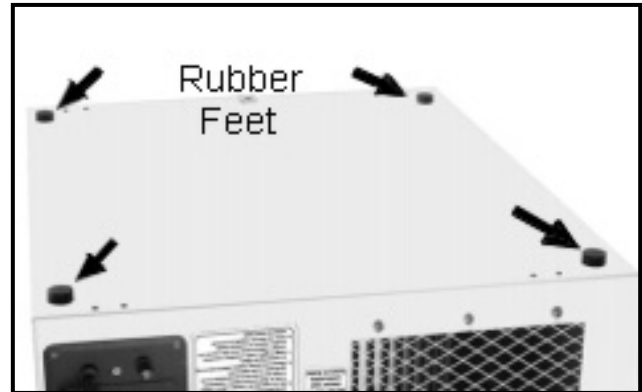

Figure-4 Rubber feet attached to the bottom of the air cleaner unit

HANGING MOUNT

The CX407 can be hung from the ceiling, operating at an optimum height from the floor.

To install the CX407, hung from the ceiling:

Install four chains, cable or steel strapping lines to the ceiling from the support or joist capable of holding 105 lbs.

Remove the plug screws and retain these screws as you will need to reinstall them to seal back the air filter unit when eye bolts are removed.

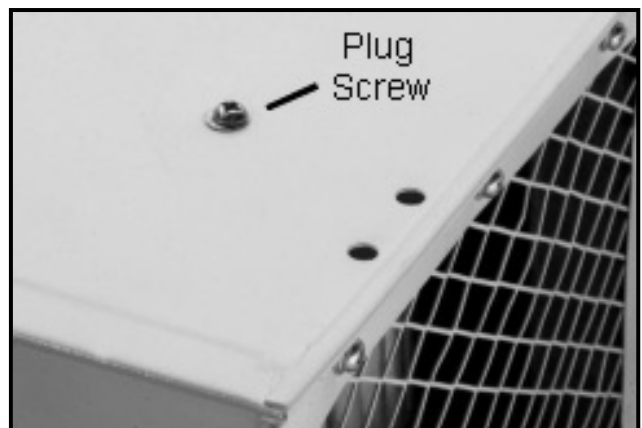

Figure-5 Removing the plug screws

Thread the eye bolts into the hole where plug screws were removed. See figure-6.

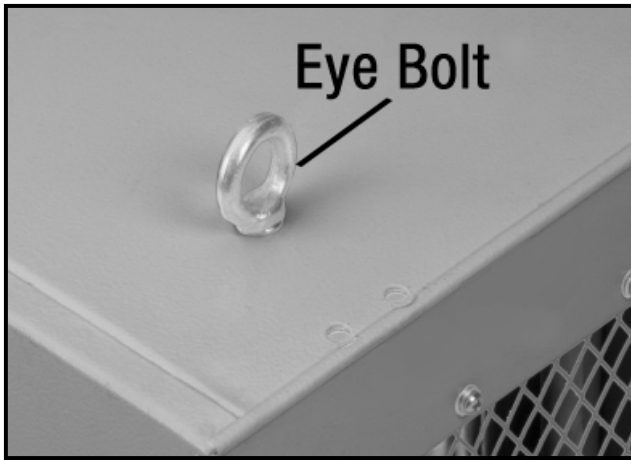

Figure-6 Installing the eye bolt

Tighten the eye bolts until they are snug against the air filter.

Get the help of an assistant or a friend and raise the air cleaner and secure to the four hanging lines through the four eye bolts.

WARNING!

Do not fasten the air cleaner onto sheet rock or dry wall, drop ceiling tile or frame. Do not use a rope or power cord to hang the air cleaner. Do not locate the unit in a corner or near any heating or cooling vents. Do not use chain rated for a less minimum of 150 lbs working load for each support. Do not use fasteners that can tear out and make the air cleaner fall.

Failure to follow these instructions may result in serious damage (to the unit), injury or death.

When the air cleaner is supported by wood structural member:

- ❖ The minimum recommended eye bolt size should be 5/16" -18" x 2" (not supplied)
- ❖ 1/4" pilot holes are recommended to help guide the eye bolts.
- ❖ Ensure the eye bolts penetrate at least 40mm into the wood structure.

When the air cleaner is supported by concrete structure:

- ❖ The minimum recommended expansion eye bolt size is 5/16" – 18" x 2".
- ❖ Drill 12mm pilot holes into the concrete structure and press the expansion eye bolt into hole and tighten the bolt until it is securely held to the ceiling.

FLUSH MOUNT

When the shop is small, the CX407 air cleaner can be installed flush to the ceiling of the shop or to the table top using flange mounts.

Mount the air cleaner ONLY to load bearing supports, wall studs, steel chain or table that can hold 150 lbs of load.

To install the air cleaner:

Locate the supports in the wall or ceiling and mark the air cleaner unit bolt pattern on the wall or ceiling (17-1/4" from left to right and 31" from front to rear)

Drill the holes to accept at least 1/4" shank bolts for studs or use 1/4" nuts, bolts and washers for mounting.

Place the flange bracket under the air cleaner lip at the mounting hole location and secure it using screws and washers provided as shown in figure-7.

Install the other three flange brackets in the same manner.

For permanent table top mounting, use the lower lip holes.

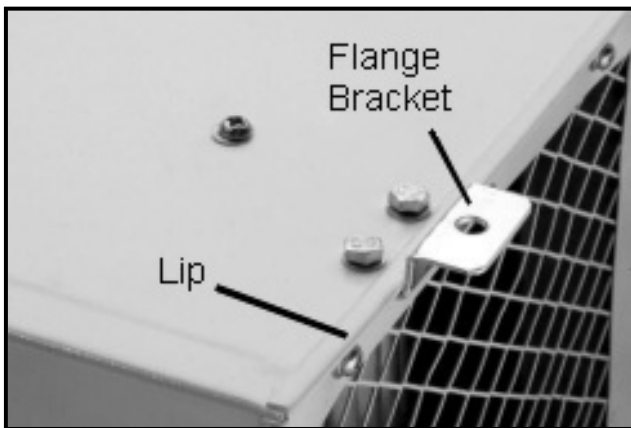

Figure-7 Mounting flange bracket to the air cleaner

Get the help of an assistant or a friend to lift the air cleaner and secure it to the wall or the ceiling using screws and washers (not provided).

WARNING!

Do not use support rated for a less minimum of 150 lbs working load. Do not use fasteners that can tear out and make the air cleaner fall down.

Failure to follow these instructions may result in serious damage (to the unit), injury or death.

CONTROL PANEL

The CX407 control panel allows you turn the air cleaner ON and OFF manually and set the fan speed.



Figure-8 Control panel

The control panel features two buttons: OFF and ON/SPEED.

OFF Button: Allows turning the air cleaner OFF manually.

ON/SPEED Button: Allows turning the air cleaner ON with one push of the button and for every additional push, the fan cycles from Low to Medium to High. The speed selection is indicated by a red LED light.

REMOTE CONTROLLER

The CX407 is provided with a remote controller which enables the operator to operate the air cleaner remotely.

The remote control works within 75 feet range from the air cleaner unit and uses two AAA batteries. See figure-9.

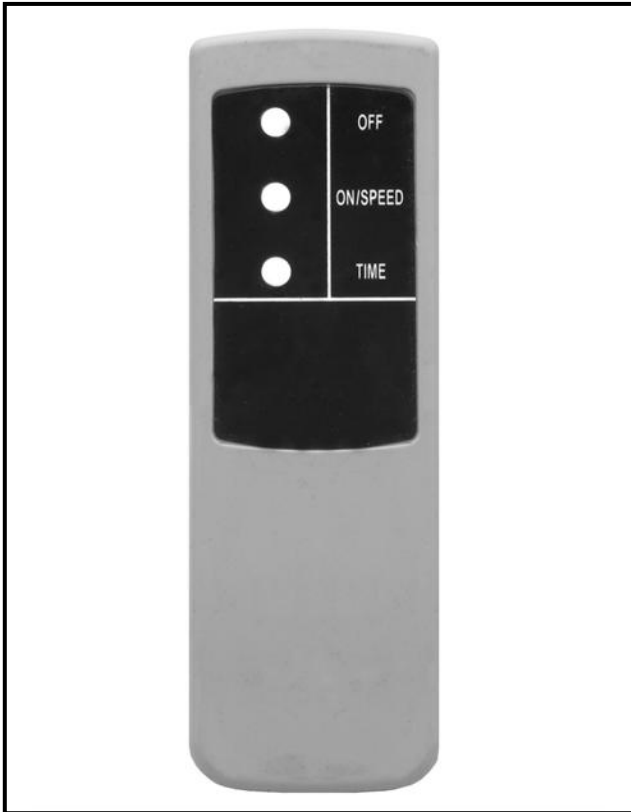

Figure-9 Remote controller for CX407

The remote controller features:

OFF Button: Turns power to the air cleaner OFF.

ON/SPEED Button: Allows turning the air cleaner ON with one push of the button and for every additional push, the fan cycles from Low to Medium to High.

TIME Button: Allows setting the auto shut-off time for the air cleaner in 1 hour, 2 hours, and 4 hours.

FILTERS

When to change the primary filter and when to service the secondary filter, depends upon the usage of the air cleaner.

Checking the filters once a week for small shops is good while checking once a day is very important for heavy use and big shops.

WARNING!

Make sure to wear a dust mask and safety glasses when servicing and changing filters. The tiny dust particles can go into your lungs and cause serious long term illness.

WARNING!

Make sure the unit is OFF and the cord is disconnected from the power source when installing, removing, or servicing any part of the unit.

CHANGING / SERVICING THE FILTERS

Disconnect the unit from the power source.

Move the retainer latch upward and remove the primary filter as shown in figure-10.

Remove the secondary filter and wash it with warm water until it is clean. Let it dry. See figure-11.

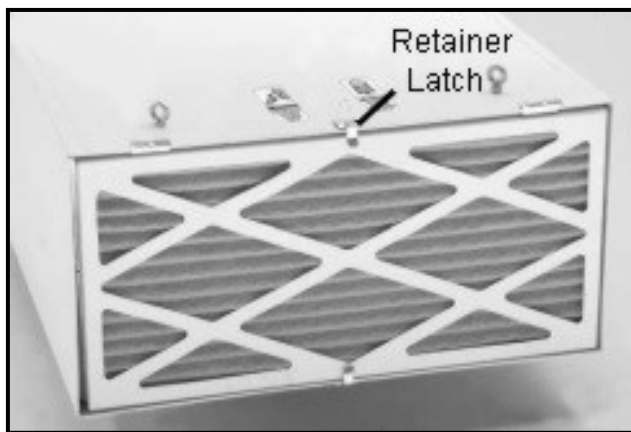

Figure-10 Removing the primary filter

Remember not to clean the secondary filter using compressed air. Doing so, will damage the filter and reduce the filtering quality.

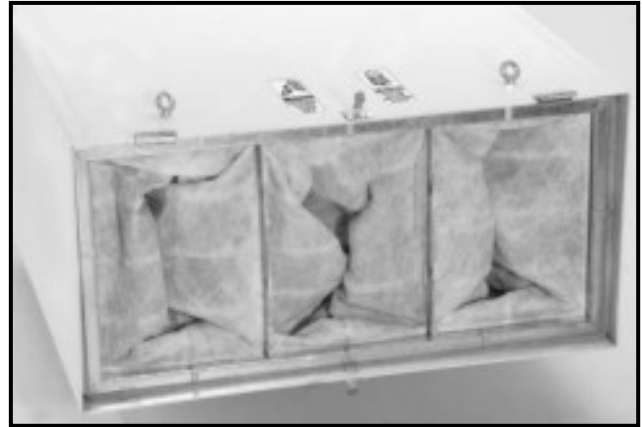
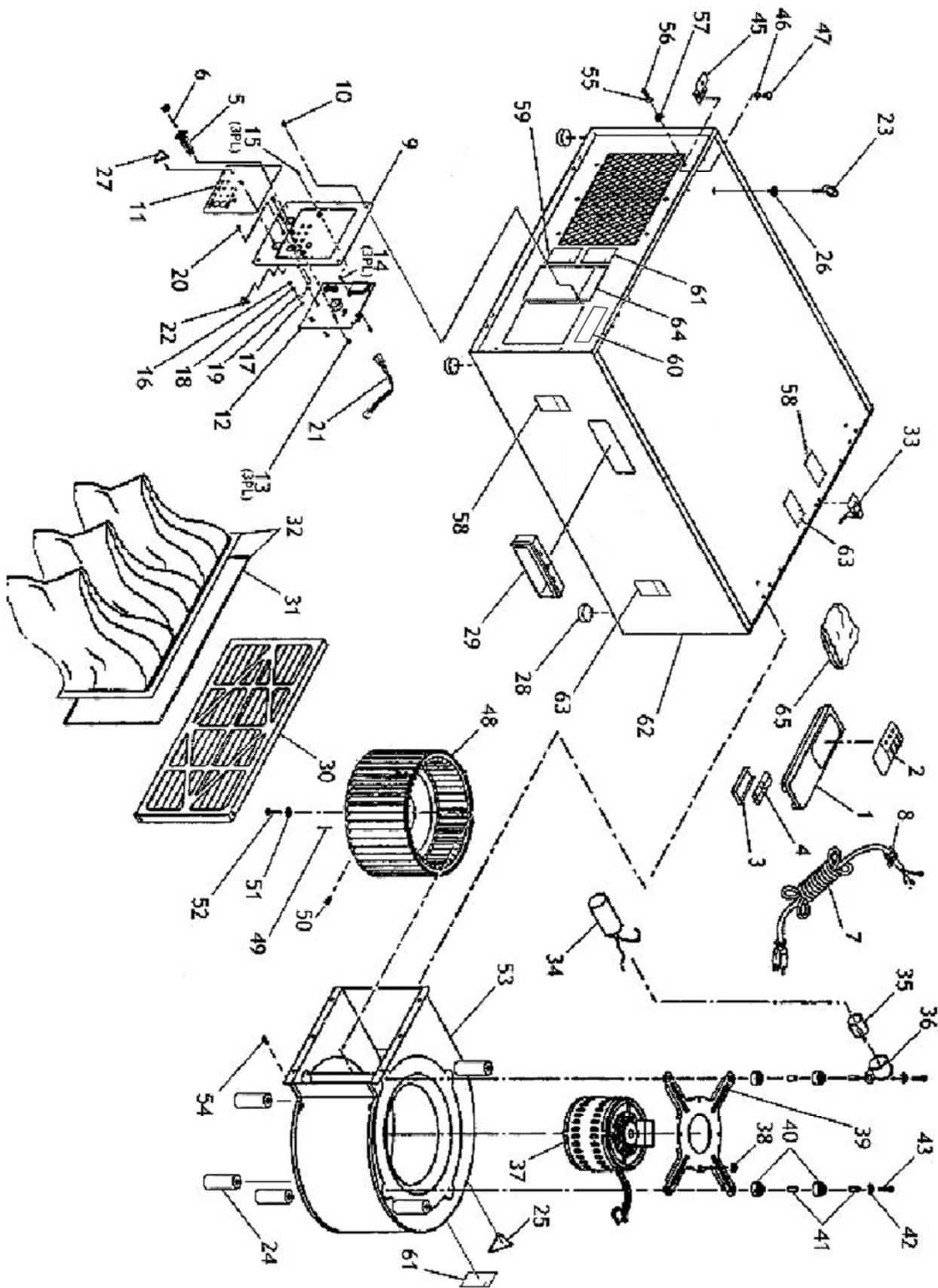

Figure-11 Secondary filter

Vaccum the dust inside the air cleaner and reinstall the secondary filter.

Install a new primary filter and push the retainer latch down to hold the filter.

CX407 PARTS BREAKDOWN



CX407 PARTS LIST

PART#	DESCRIPTION
1	REMOTE CONTROL
2	LABEL (CONTROLS REMOTE)
3	REMOTE CONTROL COVER
4	BATTERY AAA
5	CIRCUIT BREAKER 4 AMP (RESET)
6	FUSE 4A
7	POWER CORD 18 AWG
8	STRAIN RELIEF
9	CONTROL PANEL
10	SCREW - PAN HEAD M4-0.7 X 10
11	LABEL (CONTROLS)
12	PC BOARD
13	SCREW - PAN HEAD M3-0.45 X 6.5
14	SPACER (SPECIAL)
15	SCREW - PAN HEAD (SPECIAL)
16	WASHER - EXT TOOTH M4
17	NUT - HEX M4-0.75
18	WASHER - FLAT M4
19	WASHER - LOCK M4
20	SCREW - PAN HEAD M4-0.75 X 6
21	PC WIRING HARNESS
22	BOLT - SPECIAL M3-0.45 X 6.5
23	EYE BOLT M6-1.0 X 20
24	RUBBER BUSHING
25	LABEL ELECTRICAL LARGE
26	RIVET NUT M6 X 8
27	LABEL ELECTRICAL SMALL
28	RUBBER FOOT
29	HANDLE
30	PRIMARY FILTER 5 MICRON
31	FOAM SEAL 1/4 X 1 X 70
32	SECONDARY FILTER 1 MICRON
33	CLIP SET
34	CAPACITOR 6 MFD 450VAC
35	INSULATOR
36	CAPACITOR CLAMP
37	MOTOR
38	NUT - LOCK M5-0.8
39	FLANGE
40	SPACER
41	SLEEVE
42	WASHER - FLAT M6
43	BOLT - HEX HD M6-1.0 X 30
45	FLANGE BRACKET
46	WASHER - FLAT M6

47	BOLT - HEX HD M6-1.0 X 10
48	FAN SQUIRREL CAGE
49	KEY M4 X 4 X 20
50	BOLT - HEX HD M8-1.25 X 12
51	FLANGE DISK M6.5 X 44
52	SCREW - CAP M6-1.0 X 20 LH
53	FAN HOUSING
54	SCREW - TAPPING
55	WASHER - LOCK M6
56	SCREW - PAN HD M6-1.0 X 16
58	LABEL DUST MASK
59	LABEL EXPLODE
60	CRAFTEX LABEL
61	LABEL HANDS AWAY
62	HOUSING (MAIN BODY)
63	LABEL UNPLUG POWER
64	LABEL MACHINE DATA
65	HARDWARE PACKAGE



WARRANTY

CRAFTEX 3 YEARS LIMITED WARRANTY

Craftex warrants every product to be free from defects in materials and agrees to correct such defects where applicable. This warranty covers **three years** for parts and 90 days for labor (unless specified otherwise), to the original purchaser from the date of purchase but does not apply to malfunctions arising directly or indirectly from misuse, abuse, improper installation or assembly, negligence, accidents, repairs or alterations or lack of maintenance.

Proof of purchase is necessary.

All warranty claims are subject to inspection of such products or part thereof and Craftex reserves the right to inspect any returned item before a refund or replacement may be issued.

This warranty shall not apply to consumable products such as blades, bits, belts, cutters, chisels, punches etceteras.

Craftex shall in no event be liable for injuries, accidental or otherwise, death to persons or damage to property or for incidental contingent, special or consequential damages arising from the use of our products.

RETURNS, REPAIRS AND REPLACEMENTS

To return, repair, or replace a Craftex product, you must visit the appropriate Busy Bee Tools showroom or call 1-800-461-BUSY. Craftex is a brand of equipment that is exclusive to Busy Bee Tools.

For replacement parts directly from Busy Bee Tools, for this machine, please call 1-800-461-BUSY (2879), and have your credit card and part number handy.

- All returned merchandise will be subject to a minimum charge of 15% for re-stocking and handling with the following qualifications.
- Returns must be pre-authorized by us in writing.
- We do not accept *collect* shipments.
- Items returned for warranty purposes must be insured and shipped pre-paid to the nearest warehouse
- Returns must be accompanied with a copy of your original invoice as proof of purchase. Returns must be in an un-used condition and shipped in their original packaging a letter explaining your reason for the return. Incurred shipping and handling charges are not refundable.
- Busy Bee will repair or replace the item at our discretion and subject to our inspection.
- Repaired or replaced items will be returned to you pre-paid by our choice of carriers.
- Busy Bee reserves the right to refuse reimbursement or repairs or replacement if a third party without our prior authorization has carried out repairs to the item.
- Repairs made by Busy Bee are warranted for 30 days on parts and labour.
- Any unforeseen repair charges will be reported to you for acceptance prior to making the repairs.
- The Busy Bee Parts & Service Departments are fully equipped to do repairs on all products purchased from us with the exception of some products that require the return to their authorized repair depots. A Busy Bee representative will provide you with the necessary information to have this done.
- For faster service it is advisable to contact the nearest Busy Bee location for parts availability prior to bringing your product in for repairs.