

## User's Guide

# [Extech EX410-NIST 8 Function Professional MultiMeter](#) [Extech EX410 Professional Multimeter](#)

## Digital Multimeter

### Extech 410

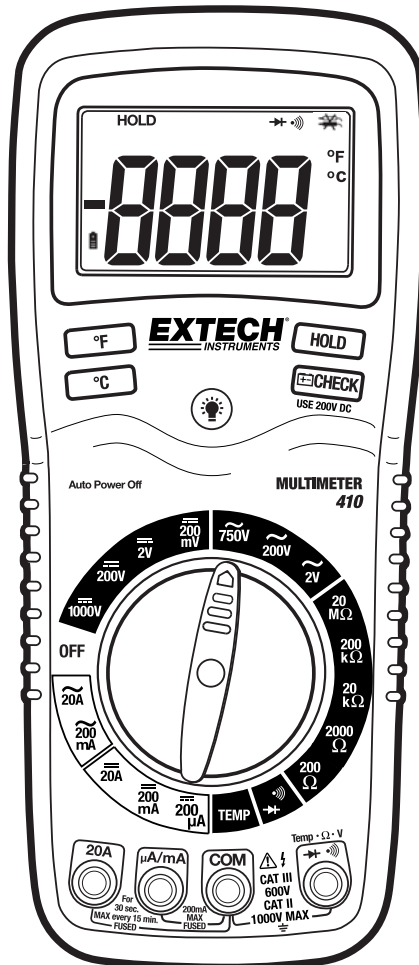

## Introduction

---

Congratulations on your purchase of the Extech EX410 Multimeter. This meter measures AC/DC Voltage, AC/DC Current, Resistance, Diode Test, and Continuity plus Thermocouple Temperature. This device is shipped fully tested and calibrated and, with proper use, will provide years of reliable service. Please visit our website to check for the latest version of this User Guide, Product Updates, and Customer Support.

## Safety

---

### International Safety Symbols



This symbol, adjacent to another symbol or terminal, indicates the user must refer to the manual for further information.



This symbol, adjacent to a terminal, indicates that, under normal use, hazardous voltages may be present



Double insulation



This **WARNING** symbol indicates a potentially hazardous situation, which if not avoided, could result in death or serious injury.



This **CAUTION** symbol indicates a potentially hazardous situation, which if not avoided, may result damage to the product.



This symbol advises the user that the terminal(s) so marked must not be connected to a circuit point at which the voltage with respect to earth ground exceeds (in this case) 600 VAC or VDC.

## CAUTIONS

- Improper use of this meter can cause damage, shock, injury or death. Read and understand this user manual before operating the meter.
- Always remove the test leads before replacing the battery or fuses.
- Inspect the condition of the test leads and the meter itself for any damage before operating the meter. Repair or replace any damage before use.
- Use great care when making measurements if the voltages are greater than 25VAC rms or 35VDC. These voltages are considered a shock hazard.
- Warning! This is a class A equipment. This equipment can cause interferences in the living quarters; in this case the operator can be required to carry out adequate measures.
- Always discharge capacitors and remove power from the device under test before performing Diode, Resistance or Continuity tests.
- Voltage checks on electrical outlets can be difficult and misleading because of the uncertainty of connection to the recessed electrical contacts. Other means should be used to ensure that the terminals are not "live".
- If the equipment is used in a manner not specified by the manufacturer, the protection provided by the equipment may be impaired.
- This device is not a toy and must not reach children's hands. It contains hazardous objects as well as small parts that the children could swallow. In case a child swallows any of them, please contact a physician immediately
- Do not leave batteries and packing material lying around unattended; they can be dangerous for children if they use them as toys
- In case the device is going to be unused for an extended period of time, remove the batteries to prevent them from training
- Expired or damaged batteries can cause cauterization on contact with the skin. Always, therefore, use suitable hand gloves in such cases
- See that the batteries are not short-circuited. Do not throw batteries into the fire.

### OVERVOLTAGE CATEGORY III

This meter meets the IEC 61010-1-2001 standard for OVERVOLTAGE CATEGORY III. Cat III meters are protected against overvoltage transients in fixed installation at the distribution level. Examples include switches in the fixed installation and some equipment for industrial use with permanent connection to the fixed installation.

### SAFETY INSTRUCTIONS

This meter has been designed for safe use, but must be operated with caution. The rules listed below must be carefully followed for safe operation.

1. **NEVER** apply voltage or current to the meter that exceeds the specified maximum:

| Input Protection Limits |  |
|-------------------------|--|
| Function                | Maximum Input  |
| VAC                     | 750V DC/AC   |
| V DC or V AC            | 1000V DC/AC, 200Vrms on 200mV range                        |
| mA DC                   | 200mA 250V fast acting fuse                                |
| A DC                    | 20A 250V fast acting fuse(30 seconds max every 15 minutes) |
| Ohms, Continuity        | 250Vrms for 15sec max                                      |

2. **USE EXTREME CAUTION** when working with high voltages.
3. **DO NOT** measure voltage if the voltage on the "COM" input jack exceeds 600V above earth ground.
4. **NEVER** connect the meter leads across a voltage source while the function switch is in the current, resistance, or diode mode. Doing so can damage the meter.
5. **ALWAYS** discharge filter capacitors in power supplies and disconnect the power when making resistance or diode tests.
6. **ALWAYS** turn off the power and disconnect the test leads before opening the covers to replace the fuse or battery.
7. **NEVER** operate the meter unless the back cover and the battery cover is in place and fastened securely.

## Controls and Jacks

1. Rubber holster (must be removed to access battery)
2. 2000 count LCD display
3. °F button for temperature measurements
4. °C button for temperature measurements
5. Function switch
6. mA, uA and A input jacks
7. COM input jack
8. Positive input jack
9. Battery check button
10. Hold button (freezes displayed reading)
11. LCD backlight button

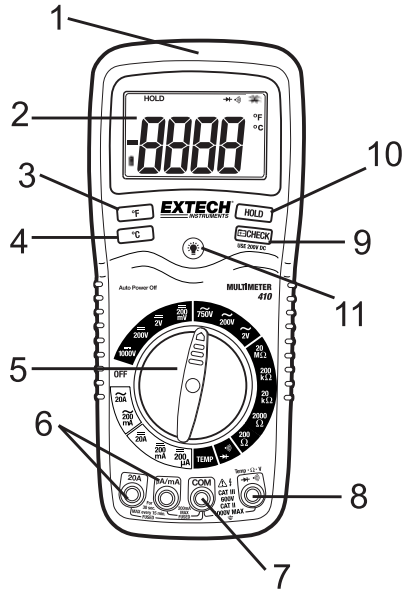

**Note:** Tilt stand, test lead holders, and battery compartment are on rear of unit.

## Symbols and Annunciators

- ))) Continuity
- ▶ Diode test
- 🔋 Battery status
- ✖ Test lead connection error
- HOLD** Display hold
- °F Degrees Fahrenheit
- °C Degrees Celsius

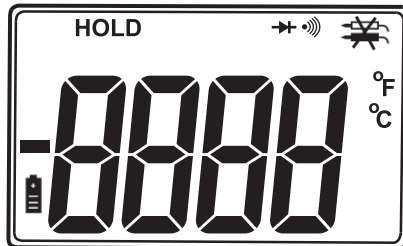

## Operating Instructions

**WARNING:** Risk of electrocution. High-voltage circuits, both AC and DC, are very dangerous and should be measured with great care.

1. ALWAYS turn the function switch to the OFF position when the meter is not in use.
2. If “1” appears in the display during a measurement, the value exceeds the range you have selected. Change to a higher range.

**NOTE:** On some low AC and DC voltage ranges, with the test leads not connected to a device, the display may show a random, changing reading. This is normal and is caused by the high-input sensitivity. The reading will stabilize and give a proper measurement when connected to a circuit.

### DC VOLTAGE MEASUREMENTS

**CAUTION:** Do not measure DC voltages if a motor on the circuit is being switched ON or OFF. Large voltage surges may occur that can damage the meter.

1. Set the function switch to the highest V DC (V<sup>-</sup>) position.
2. Insert the black test lead banana plug into the negative **COM** jack. Insert the red test lead banana plug into the positive **V** jack.
3. Touch the black test probe tip to the negative side of the circuit. Touch the red test probe tip to the positive side of the circuit.
4. Read the voltage in the display. Reset the function switch to successively lower V DC positions to obtain a higher resolution reading. If the polarity is reversed, the display will show (-) minus before the value.

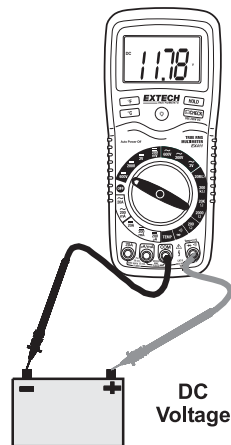

## AC VOLTAGE MEASUREMENTS

**WARNING:** Risk of Electrocution. The probe tips may not be long enough to contact the live parts inside some 240V outlets for appliances because the contacts are recessed deep in the outlets. As a result, the reading may show 0 volts when the outlet actually has voltage on it. Make sure the probe tips are touching the metal contacts inside the outlet before assuming that no voltage is present.

**CAUTION:** Do not measure AC voltages if a motor on the circuit is being switched ON or OFF. Large voltage surges may occur that can damage the meter.

1. Set the function switch to the highest V AC (  $\sim$  ) position.
2. Insert the black test lead banana plug into the negative **COM** jack. Insert red test lead banana plug into the positive **V** jack.
3. Touch the black test probe tip to the neutral side of the circuit. Touch the red test probe tip to the "hot" side of the circuit.
4. Read the voltage in the display. Reset the function switch to successively lower V AC positions to obtain a higher resolution reading.

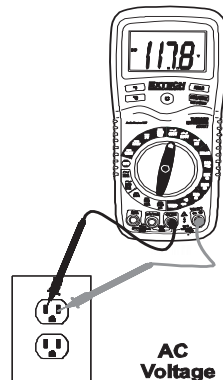

## DC CURRENT MEASUREMENTS

**CAUTION:** Do not make current measurements on the 20A scale for longer than 30 seconds. Exceeding 30 seconds may cause damage to the meter and/or the test leads.

1. Insert the black test lead banana plug into the negative **COM** jack.
2. For current measurements up to 200 $\mu$ A DC, set the function switch to the 200 $\mu$ A DC (  $\overline{\mu A}$  ) position and insert the red test lead banana plug into the  **$\mu$ A/mA** jack.
3. For current measurements up to 200mA DC, set the function switch to the 200mA DC position and insert the red test lead banana plug into the  **$\mu$ A/(mA)** jack.
4. For current measurements up to 20A DC, set the function switch to the 20A DC range and insert the red test lead banana plug into the **20A** jack.
5. Remove power from the circuit under test, then open up the circuit at the point where you wish to measure current.
6. Touch the black test probe tip to the negative side of the circuit. Touch the red test probe tip to the positive side of the circuit.
7. Apply power to the circuit.
8. Read the current in the display.

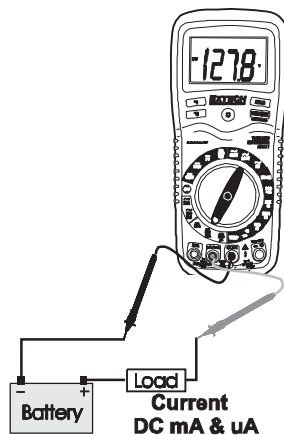

## AC CURRENT MEASUREMENTS

**CAUTION:** Do not make current measurements on the 20A scale for longer than 30 seconds. Exceeding 30 seconds may cause damage to the meter and/or the test leads.

1. Insert the black test lead banana plug into the negative **COM** jack.
2. For current measurements up to 200mA AC, set the function switch to the highest 200mA AC ( $\sim$ ) position and insert the red test lead banana plug into the **mA** jack.
3. For current measurements up to 20A AC, set the function switch to the 20A AC range and insert the red test lead banana plug into the **20A** jack.
4. Remove power from the circuit under test, then open up the circuit at the point where you wish to measure current.
5. Touch the black test probe tip to the neutral side of the circuit. Touch the red test probe tip to the "hot" side of the circuit.
6. Apply power to the circuit.
7. Read the current in the display.

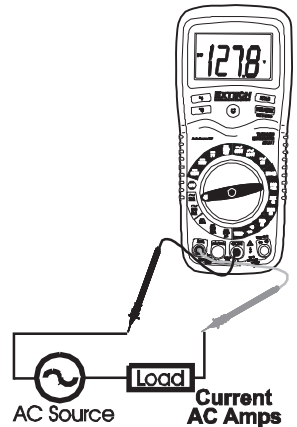

## RESISTANCE MEASUREMENTS

**WARNING:** To avoid electric shock, disconnect power to the unit under test and discharge all capacitors before taking any resistance measurements. Remove the battery and unplug the line cords.

1. Set the function switch to the highest  $\Omega$  position.
2. Insert the black test lead banana plug into the negative **COM** jack. Insert the red test lead banana plug into the positive  $\Omega$  jack.
3. Touch the test probe tips across the circuit or part under test. It is best to disconnect one side of the part under test so the rest of the circuit will not interfere with the resistance reading.
4. Read the resistance in the display and then set the function switch to the lowest  $\Omega$  position that is greater than the actual or any anticipated resistance.

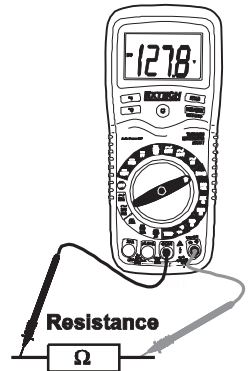





## CONTINUITY CHECK

**WARNING:** To avoid electric shock, never measure continuity on circuits or wires that have voltage on them.

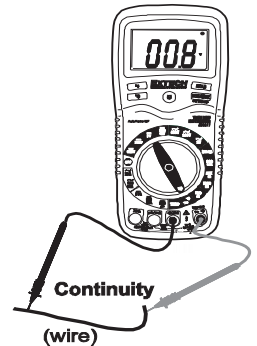
1. Set the function switch to the  position.
2. Insert the black lead banana plug into the negative **COM** jack. Insert the red test lead banana plug into the positive  $\Omega$  jack.
3. Touch the test probe tips to the circuit or wire you wish to check.
4. If the resistance is less than approximately  $150\Omega$ , the audible signal will sound. If the circuit is open, the display will indicate "1".



## DIODE TEST

1. Insert the black test lead banana plug into the negative **COM** jack and the red test lead banana plug into the positive **diode** jack.
2. Turn the rotary switch to the  position.
3. Touch the test probes to the diode under test. Forward bias will typically indicate 400 to 1000. Reverse bias will indicate "1". Shorted devices will indicate near 0 and the continuity beeper will sound. An open device will indicate "1" in both polarities.

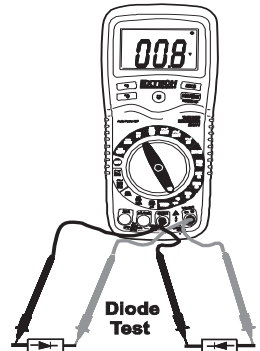

## TEMPERATURE MEASUREMENTS

1. Set the function switch to the TEMP position.
2. Insert the Temperature Probe into the Temperature Socket, making sure to observe the correct polarity.
3. Press the °C or °F button for the desired units.
4. Touch the Temperature Probe head to the part whose temperature you wish to measure. Keep the probe touching the part under test until the reading stabilizes.
5. Read the temperature in the display.

Note: The temperature probe is fitted with a type K mini connector. A mini connector to banana connector adaptor is supplied for connection to the input banana jacks.

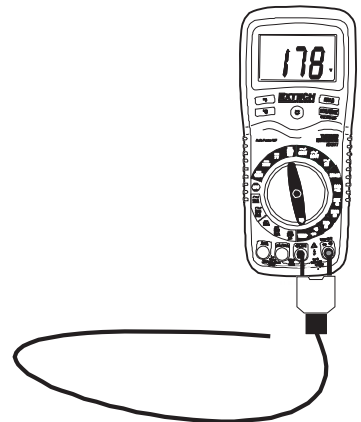

## DISPLAY BACKLIGHT

Press and hold the  button to turn on the display backlight function. The backlight will automatically turn off after 15 seconds.

## BATTERY CHECK

The  CHECK function tests the condition of the 9V battery. Set the function switch to the 200VDC range and press the CHECK button. If the reading is less than 8.5, battery replacement is recommended.

## HOLD

The hold function freezes the reading in the display. Press the HOLD key momentarily to activate or to exit the hold function.

## AUTO POWER OFF

The auto off feature will turn the meter off after 15 minutes.

## LOW BATTERY INDICATION

If the  icon appears in the display, the battery voltage is low and the battery should be replaced.

## WRONG CONNECTION INDICATION

The  icon will appear in the upper right corner of the display and the buzzer will sound whenever the positive test lead is inserted into the 20A or uA/mA input jack and a non-current (green) function is selected. If this occurs, turn the meter off and reinsert the test lead into the proper input jack for the function selected.

## Specifications

| Function             | Range        | Resolution | Accuracy                                  |                             |
|----------------------|--------------|------------|---|-----------------------------|
| DC Voltage<br>(V DC) | 200mV        | 0.1mV      | ±(0.3% reading + 2 digits)                |                             |
|                      | 2V           | 0.001V     | ±(0.5% reading + 2 digits)                |                             |
|                      | 200V         | 0.1V       | ±(0.8% reading + 2 digits)                |                             |
|                      | 1000V        | 1V         | ±(0.8% reading + 2 digits)                |                             |
| AC Voltage<br>(V AC) |              |            | 50 to 400Hz                               | 400Hz to 1kHz               |
|                      | 2V           | 0.001V     | ±(1.0% reading + 6 digits)                | ±(2.0% reading + 8 digits)  |
|                      | 200V         | 0.1V       | ±(1.5% reading + 6 digits)                | ±(2.5% reading + 8 digits)  |
|                      | 750V         | 1V         | ±(2.0% reading + 6 digits)                | ±(3.0% reading + 8 digits)  |
| DC Current<br>(A DC) | 200µA        | 0.1µA      | ±(1.5% reading + 3 digits)                |                             |
|                      | 200mA        | 0.1mA      | ±(2.5% reading + 3 digits)                |                             |
|                      | 20A          | 0.01A      | ±(2.5% reading + 3 digits)                |                             |
| AC Current<br>(A AC) |              |            | 50 to 400Hz                               | 400Hz to 1kHz               |
|                      | 200mA        | 0.1mA      | ±(1.8% reading + 8 digits)                | ±(2.5% reading + 10 digits) |
|                      | 20A          | 0.01A      | ±(3.0% reading + 8 digits)                | ±(3.5% reading + 10 digits) |
| Resistance           | 200Ω         | 0.1Ω       | ±(0.8% reading + 4 digits)                |                             |
|                      | 2000Ω        | 1Ω         | ±(0.8% reading + 2 digits)                |                             |
|                      | 20kΩ         | 0.01kΩ     | ±(1.0% reading + 2 digits)                |                             |
|                      | 200kΩ        | 0.1kΩ      | ±(2.0% reading + 5 digits)                |                             |
|                      | 20MΩ         | 0.01MΩ     | ±(2.0% reading + 5 digits)                |                             |
| Temperature          | -20 to 750°C | 1°C        | ±(3.0% reading + 3 digits)                |                             |
|                      | -4 to 1382°F | 1°F        | (meter only, probe accuracy not included) |                             |

**NOTE:** Accuracy specifications consist of two elements:

- (% reading) – This is the accuracy of the measurement circuit.
- (+ digits) – This is the accuracy of the analog to digital converter.

**NOTE:** Accuracy is stated at 18°C to 28°C (65°F to 83°F) and less than 75% RH.

## General Specifications

|                               |   |
|-------------------------------|---|
| <b>Diode Test</b>             | Test current of 1mA maximum, open circuit voltage 2.8V DC typical   |
| <b>Continuity Check</b>       | Audible signal when resistance is less than approximately 150Ω  |
| <b>Input Impedance</b>        | 10MΩ  |
| <b>AC Response</b>            | Average responding  |
| <b>ACV Bandwidth</b>          | 50Hz to 1kHz  |
| <b>DCA voltage drop</b>       | 200mV   |
| <b>Display</b>                | 3 ½ digit, 2000 count LCD, 0.9" digits  |
| <b>Auto-Power Off</b>         | Meter switches OFF after 15 minutes (approximately) of inactivity   |
| <b>Overrange indication</b>   | "1" is displayed  |
| <b>Polarity</b>               | Automatic (no indication for positive polarity); Minus (-) sign for negative polarity.  |
| <b>Measurement Rate</b>       | 2 times per second, nominal   |
| <b>Low Battery Indication</b> | "  " is displayed if battery voltage drops below operating voltage   |
| <b>Battery</b>                | One 9 volt (NEDA 1604) battery  |
| <b>Fuses</b>                  | mA, μA ranges; 0.2A/250V fast blow<br>A range; 20A/250V ceramic fast blow   |
| <b>Operating Temperature</b>  | 5°C to 40°C (41°F to 104°F)   |
| <b>Storage Temperature</b>    | -20°C to 60°C (-4°F to 140°F)   |
| <b>Operating Humidity</b>     | Max 80% up to 31°C (87°F) decreasing linearly to 50% at 40°C (104°F)  |
| <b>Storage Humidity</b>       | <80%  |
| <b>Operating Altitude</b>     | 2000 meters (7000ft.) maximum   |
| <b>Weight</b>                 | 342g (0.753lb) (includes holster)   |
| <b>Size</b>                   | 187 x 81 x 50mm (7.36" x 3.2" x 2.0") (includes holster)  |
| <b>Safety</b>                 | For indoor use and in accordance with the requirements for double insulation to IEC1010-1 (2001): EN61010-1 (2001) Overvoltage Category III 600V and Category II 1000V, Pollution Degree 2. |

## Maintenance

**WARNING:** To avoid electrical shock, disconnect the meter from any circuit, remove the test leads from the input terminals, and turn OFF the meter before opening the case. Do not operate the meter with an open case.

This MultiMeter is designed to provide years of dependable service, if the following care instructions are performed:

1. **KEEP THE METER DRY.** If it gets wet, wipe it off.
2. **USE AND STORE THE METER IN NORMAL TEMPERATURES.** Temperature extremes can shorten the life of the electronic parts and distort or melt plastic parts.
3. **HANDLE THE METER GENTLY AND CAREFULLY.** Dropping it can damage the electronic parts or the case.
4. **KEEP THE METER CLEAN.** Wipe the case occasionally with a damp cloth. DO NOT use chemicals, cleaning solvents, or detergents.
5. **USE ONLY FRESH BATTERIES OF THE RECOMMENDED SIZE AND TYPE.** Remove old or weak batteries so they do not leak and damage the unit.
6. **IF THE METER IS TO BE STORED FOR A LONG PERIOD OF TIME,** the batteries should be removed to prevent damage to the unit.

### Battery Replacement

1. Remove the Phillips head screw that secures the rear battery door
2. Open the battery compartment
3. Replace the 9V battery
4. Secure the battery compartment



You, as the end user, are legally bound (**EU Battery ordinance**) to return all used batteries, **disposal in the household garbage is prohibited!** You can hand over your used batteries / accumulators at collection points in your community or wherever batteries / accumulators are sold!

**Disposal:** Follow the valid legal stipulations in respect of the disposal of the device at the end of its lifecycle

**WARNING:** To avoid electric shock, do not operate the meter until the battery cover is in place and fastened securely.

**NOTE:** If the meter does not work properly, check the status of the fuses and batteries and ensuring proper insertion.

## REPLACING THE FUSES

**WARNING:** To avoid electrical shock, disconnect the meter from any circuit, remove the test leads from the input terminals, and turn OFF the meter before opening the case. Do not operate the meter with an open case.

1. Disconnect the test leads from the meter.
2. Remove the protective rubber holster.
3. Remove the battery cover (two "B" screws) and the battery.
4. Remove the four "A" screws securing the rear cover.
5. Lift the center circuit board straight up from the connectors to gain access to the fuse holders.
6. Gently remove the old fuse and install the new fuse into the holder.
7. Always use a fuse of the proper size and value (0.2A/250V fast blow (5x20mm) for the 200mA range, 20A/250V fast blow (6.3x32mm) for the 20A range).
8. Align the center board with the connectors and gently press into place.
9. Replace and secure the rear cover, battery and battery cover.

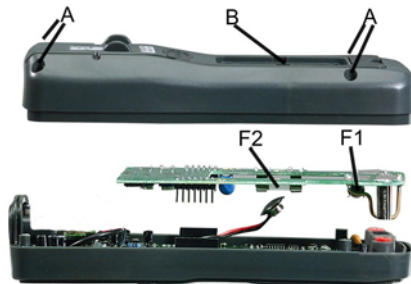

**WARNING:** To avoid electric shock, do not operate your meter until the fuse cover is in place and fastened securely.

### UL LISTED

The UL mark does not indicate that this product has been evaluated for the accuracy of its readings.