



**BRADFORD WHITE**<sup>®</sup>  
W A T E R   H E A T E R S

**UDS / UDH Series**  
**Ultra Low NOx Direct Vent Water Heaters**



# **SERVICE**

# **MANUAL**

Troubleshooting Guide  
and Instructions for Service

(To be performed ONLY by  
qualified service providers)

## **Models Covered by This Manual:**



ECO-Defender Safety System<sup>®</sup> Models  
UDS140S\*FRN  
UDS150S\*FRN  
UDH1504T\*FRN  
UDH165T\*FRN  
UDH175S\*FRN  
UDH50T45FR\*N  
UDH65T45FR\*N  
UDH75T50FR\*N

(\*) Denotes Warranty Years

# *The Bradford White* **UDS/UDH** **Series**

Ultra Low NOx Direct Vent Water Heaters

---

## Table of Contents

	<u>Page</u>	<u>Service Procedure</u>
Introduction	3	---
Trouble shooting Chart	4	---
Inner Door Gasket Removal, Inspection, Replacement and Installation	6	I
Thermopile Testing and Replacement	9	II
Pilot Assembly Inspection Cleaning and Replacement	10	III
Igniter, Electrode Testing and Replacement	11	IV
Honeywell Gas Control Testing, Disassembly, and Replacement	20	V
Burner Operation Inspection, Adjustment, Cleaning and Replacement	21	VI
Dip Tube and Anode Inspection and Replacement	23	VII
Generic Parts List	25	---

## **INTRODUCTION**

The new Bradford White UDS and UDH water heaters are designed to provide reliable performance with enhanced standard features. Design features include reliable standing pilot ignition system, enhanced diagnostics, simplified servicing, certified FVIR technology and Ultra Low NOx emissions.

The UDS and UDH water heaters use a combustion system where combustion air is drawn from the outside of the building. The gas control maintains water temperature and maintains gas flow. If a situation outside of normal operating parameters exists, the gas control diagnostic LED will flash a code to positively identify an operational issue.

This service manual is designed to facilitate problem diagnosis and enhance service efficiency. To further promote quicker service times the gas valve can be removed and replaced without draining the water heater.

Please read the service manual completely before attempting service on this new series of direct vent water heaters.

### **How the Safety System Works**

During normal operation, air for the combustion chamber is drawn into the water heater through the vent pipe from outside your building. The air travels into the closed combustion chamber. The air then mixes in a normal manner with supplied gas and is efficiently combusted, producing Ultra Low NOx emissions.

In the unlikely event trace amounts of flammable vapors are present in the area surrounding the water heater, the sealed combustion system prevents the flammable vapors from reaching the ignition source.

# Honeywell Gas Control Troubleshooting Chart

## Flammable Vapor Ignition Resistant Water Heaters

Observe green LED indicator on Gas Control. Error flash codes are displayed with a three second pause before repeating. Check and repair the system as noted in the troubleshooting table below.



Green LED Indicator

<u>LED Status</u>	<u>Control Status</u>	<u>Probable Cause</u>	<u>Service Procedure</u>
None (LED not on or flashing)	Pilot assembly is not lit	Gas Control is not powered. Light pilot.	If the pilot will not stay lit replace pilot assembly. If problem persists replace Gas Control.
One flash and three second pause	1. If set point knob is in "PILOT" position then pilot flame is detected. Turn set point knob to desired setting. 2. If the set point knob is already at the desired setting, the water heater is satisfied.	1. Gas Control is powered and waiting for the set point knob to be turned to a water temperature setting. 2. Water heater is satisfied and operating normally.	1. Adjust set point knob to desired setting.
Two quick flashes and a three second pause	Gas control is calling for heat (no fault).	Tank temperature below set point of thermostat.	Normal operation.
LED on continuously (Solid)	Set point knob has been recently turned to the "OFF" position. Wait until LED goes out before attempting to relight	Set point knob was turned to "OFF" position.	LED will go out and the control will function normally when the pilot is lit.
Two flashes and three second pause	Weak pilot signal detected. System will reset when pilot flame is sufficient.	1. Thermopile failure 2. Unstable pilot 3. Pilot tube block or restricted.	1. See service procedure II 2. See service procedure III 3. See service procedure III
Four flashes and three second pause	Excessive tank temperature. System must be reset.	1. Temperature sensor out of calibration 2. Faulty Gas Control	1. See service procedure V 2. See service procedure V

# Honeywell Gas Control Troubleshooting Chart

## Flammable Vapor Ignition Resistant Water Heaters

Observe green LED indicator on Gas Control. Error flash codes are displayed with a three second pause before repeating. Check and repair the system as noted in the troubleshooting table below.



Green LED Indicator

<b><u>LED Status</u></b>	<b><u>Control Status</u></b>	<b><u>Probable Cause</u></b>	<b><u>Service Procedure</u></b>
Five flashes and three second pause	Thermostat/well sensor fault.	<ol style="list-style-type: none"> <li>1. Damage to the temperature sensor.</li> <li>2. Temperature sensor resistance out of range.</li> </ol>	<ol style="list-style-type: none"> <li>1. See service procedure V</li> </ol>
Six flashes and three second pause	Water leak detected by accessory module.	Excessive amount of water in drain pan/water dam.	<ol style="list-style-type: none"> <li>1. Check T&amp;P valve</li> <li>2. Check all water fittings.</li> <li>3. Pressurize and leak test tank.</li> </ol>
Seven flashes and three second pause	Gas Control electronic fault detected.	<ol style="list-style-type: none"> <li>1. Control needs to be reset.</li> <li>2. Control is wet or physically damaged.</li> </ol>	<ol style="list-style-type: none"> <li>1. Reset Gas Control</li> <li>2. Replace Gas Control.</li> </ol>
Eight flashes and three second pause	Standing pilot remains on while set point knob is in "OFF" position.	Pilot valve stuck in open position.	Replace Gas Control.

# The Bradford White UDS/UDH Series

## SERVICE PROCEDURE I Inner Door/Gasket Removal, Inspection Replacement and Reinstallation

### Inner Door Removal Procedure

- Step 1. Rotate set point knob of the gas control to the "OFF" position.
- Step 2. Turn off the gas supply to the water heater
- Step 3. Remove the outer door.
- Step 4. Remove the four (4) ¼" hex drive screws holding the right side inner door in place



- Step 5. Remove the three (3) ¼" hex drive screws holding the left side burner door in place.

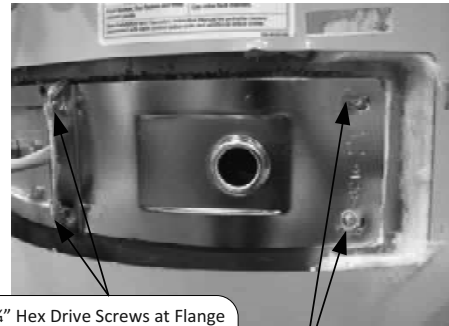

¼" Hex Drive Screws at Flange Area of Inner Door

¼" Hex Drive Screws Right Side Inner Door

¼" Hex Drive Screws on Left Side Inner Door

- Step 6. Disconnect the pilot tube from the gas control using a 7/16" wrench. Remove the main burner feedline from the gas control with a ¾" wrench.
- Step 7. Disconnect the spark igniter wire from the gas control.
- Step 8. Remove the burner assembly from the combustion chamber.



- Step 9. Fully inspect burner and inner door gaskets for the following:
  - >Tears
  - >Missing Material
  - >Cracks
  - >Dirt or debris
  - >Other imperfections that will inhibit proper seal
  - >Gasket adhesion to inner door
  - >Material left on combustion chamber (around opening)

If the gasket is not affected by any of the above, gasket replacement is not required. If replacement is required, proceed to **Inner Door Gasket Replacement Procedure.**

# The Bradford White UDS/UDH Series

SERVICE PROCEDURE I  
Inner Door/Gasket Removal, Inspection  
Replacement and Reinstallation

## Inner Door Gasket Replacement Procedure.

**▲ WARNING**  
If the information in these instructions is not followed exactly, a fire or explosion may result causing property damage, personal injury or death.

- Step 10. After inspection of inner door as noted in step 9, completely remove gasket and adhesive residue from burner and left side inner doors as needed.
- Step 11. Use RTV sealant (recommended bead size 1/8") to secure the inner door gasket to the inner door sections (right & burner). The burner door gasket must be sliced in the location shown on the illustration below in order to slide the gasket over the burner venturi. Refer to illustration below for proper RTV sealant application. Note the overlap configuration in the flange area of the inner door. Set the flange section first, this will help to achieve the proper over lap position.

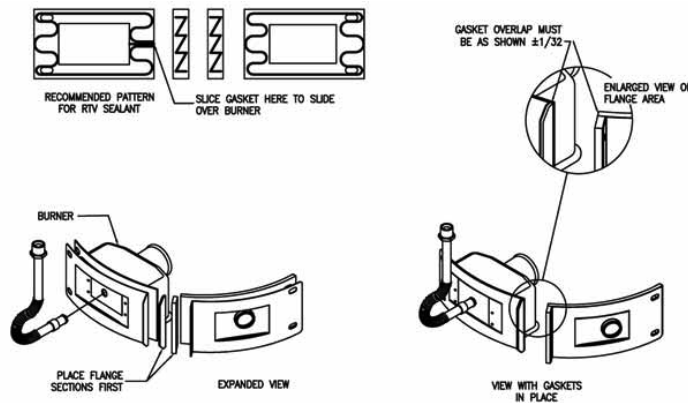

## Installation of Inner Door With Gasket.

- Step 12. Clean any residual gasket residue or other debris from combustion chamber surface before installing the inner door/gasket assembly.
- Step 13. Place the burner door into position first. Tighten the pilot line nut to the gas control. Tighten the main burner feedline to the gas control. Use the 1/4" hex drive screw without the built-in washer to secure the right side of the burner door to the chamber. Use the 1/4" hex drive screws with the built-in washer to secure the left side of the burner door in place. **DO NOT OVER TIGHTEN SCREWS.**
- Step 14. Position the fiberglass sock containing the igniter wire, the pilot tube and the armored thermopile cable against the inner door flange.

**▲ WARNING**  
Stripped fastener connections may allow for seal breach of inner door. A seal breach may result in a fire or explosion causing property damage, personal injury or death. Do not over tighten screws in steps 13, 15 and 16.

If a fastener connection is stripped, contact the manufacturer listed on the water heater rating plate.

# The Bradford White UDS/UDH Series

## SERVICE PROCEDURE I Inner Door/Gasket Removal, Inspection Replacement and Reinstallation

Position fiberglass sock, pilot tube and armored thermopile cable against flange.

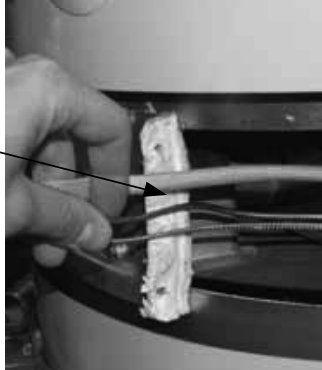

- Step 15. Firmly place right side inner door flange against the burner door flange and secure with two 1/4" drive screws from step 5. **DO NOT OVER TIGHTEN SCREWS.**
- Step 16. Align right side inner door to combustion chamber and verify the fastener holes of the combustion chamber are aligned with the right side inner door slotted opening. Verify seal integrity around combustion opening. Secure right side inner door using 1/4" hex drive screws from step 5. **DO NOT OVER TIGHTEN SCREWS.** Verify both burner and right sides of the inner door are properly positioned and sealed against the combustion chamber.



Secure flange with  
1/4" drive screws.

Verify threaded hole  
alignment with slotted  
openings in inner door.

- Step 17. Reconnect the igniter wire to the gas control
- Step 18. Replace outer jacket burner access door.
- Step 19. To resume operation follow the instructions located on the lighting instruction label or the lighting instructions located in the installation and operation manual.



# The Bradford White UDS/UDH Series

## SERVICE PROCEDURE II Thermopile Testing and Replacement

### OPEN CIRCUIT THERMOPILE TESTING

The following test should be performed while the pilot flame is on.

- Step 1. Turn knob to pilot position and depress.
- Step 2. Continue pressing knob and remove red (+) thermopile wire from the red wire leading from the gas control. Also remove white (-) thermopile wire from the gas control.
- Step 3. Using a multimeter capable of measuring millivolts, connect the positive side of the multimeter to the red (+) thermopile wire connector. Connect the negative side of the multimeter to the white thermopile connector.

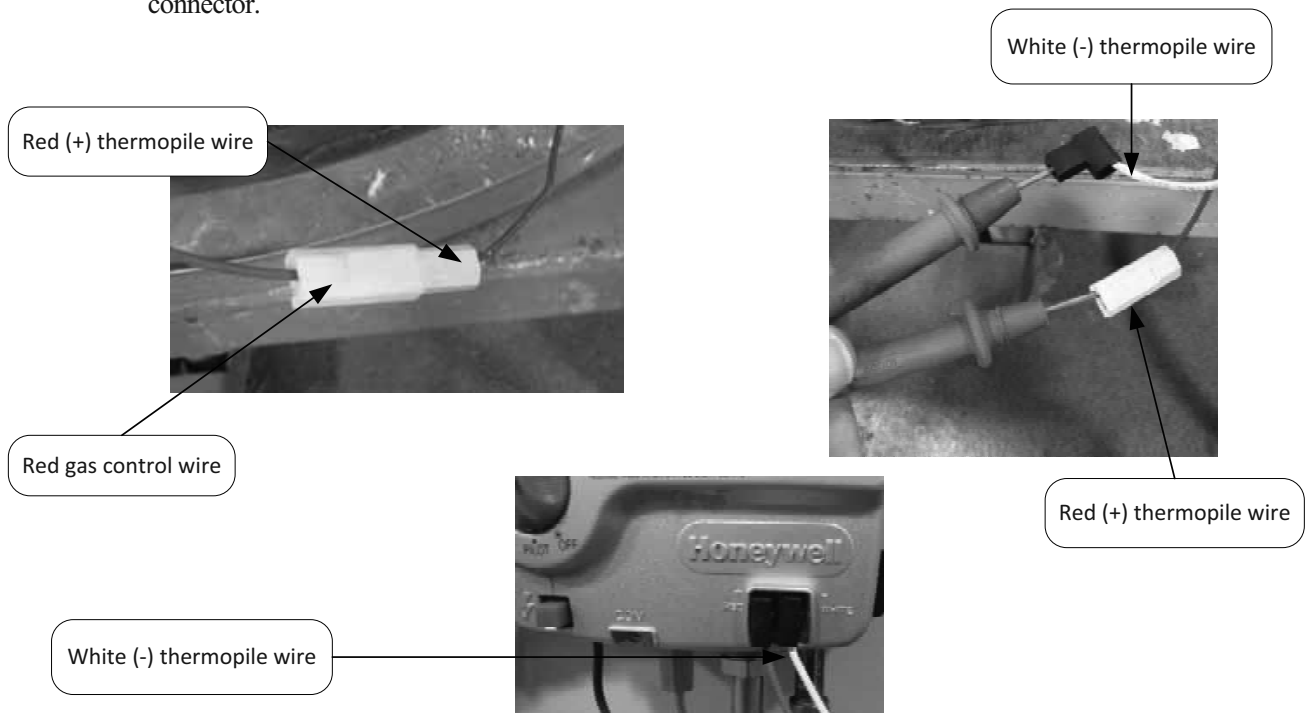

Normal thermopile operation will be between 350mV - 850mV. If reading is less than 350mV, replacement of pilot assembly is recommended following SERVICE PROCEDURE III.

- Step 4. If thermopile reading is between 350mV - 850mV, remove multimeter and reconnect red (+) thermopile wire to red wire leading from the gas control. Reconnect white (-) thermopile wire negative (-) terminal on gas control.
- Step 5. Release Gas Control knob and turn to desired setting to resume normal operation.

# The Bradford White UDS/UDH Series

## SERVICE PROCEDURE III Pilot Assembly Inspection, Cleaning and Replacement

### PILOT/ELECTRODE ASSEMBLY INSPECTION, CLEANING AND REPLACEMENT

- Step 1. Turn off gas supply to water heater. Rotate knob of gas control/gas valve to "OFF" position.
- Step 2. Remove outer jacket door.
- Step 3. Remove burner and right side inner door per SERVICE PROCEDURE I, steps 1 through 8.
- Step 4. Disconnect thermopile, pilot tube, and feedline from gas control.
- Step 5. Disconnect igniter wire from gas control.
- Step 6. Remove pilot/electrode assembly from burner (1/4" drive tool).
- Step 7. Inspect pilot for the following:
- Primary air openings for blockage. Must be free from any debris (dirt, lint, etc).
  - Kinks or cracks in the pilot tube. If found, the pilot must be replaced.
- Step 8. Inspect pilot orifice:
- Remove 1/2" nut from bottom of pilot assembly.
  - Remove pilot tube and pilot orifice.
  - Inspect pilot orifice for blockage, must be cleaned or replaced. (Honeywell pilot orifice not replaceable, replace pilot assembly)
- Step 9. Install pilot/electrode assembly to feedline, secure with screw from step 6.
- Step 10. Re-Install burner assembly and right side inner door per SERVICE PROCEDURE I, steps 9 through 19.
- Step 11. To resume operation follow the instructions located on the lighting instruction label or the lighting instructions located in the installation and operation manual.

For Honeywell Control, rotate knob counter-clockwise to the "OFF" position.

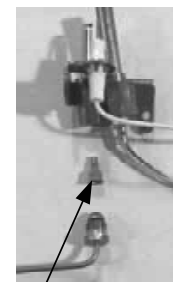
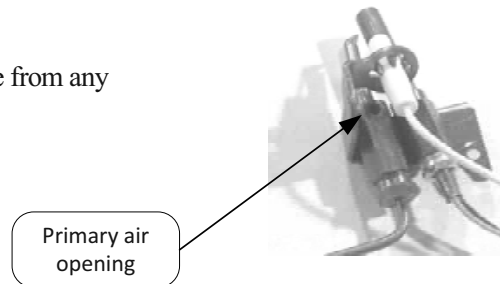
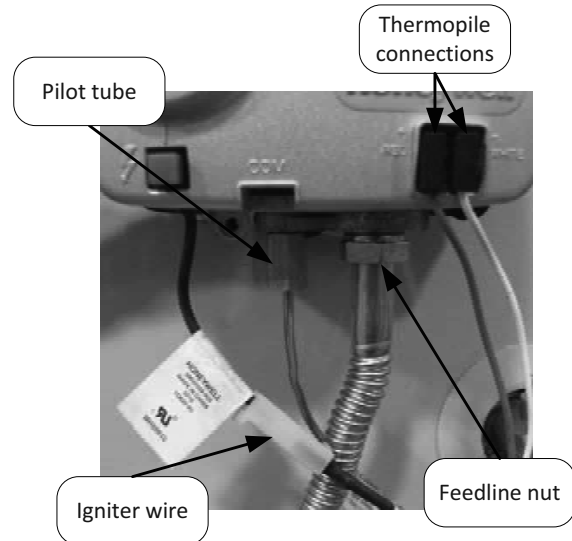

# The Bradford White UDS/UDH Series

## SERVICE PROCEDURE IV Igniter, Electrode Testing and Replacement

### IGNITER, ELECTRODE TESTING AND REPLACEMENT

With the pilot not in operation (no pilot flame) you can check the igniter and electrode circuit by viewing pilot thru the sight glass located on the inner door and observing the spark action.

- Step 1. Remove outer jacket door.
- Step 2. Repeatedly depress the igniter while viewing the pilot thru the sight glass. If a spark is present, the circuit is OK. If there is no spark, proceed to step 3.



Repeatedly  
Depress Piezo  
Igniter



View spark  
Action through  
Sight glass

- Step 3. Remove white wire from igniter and install a jumper wire in its place. Hold the other end of the jumper by the wire insulation or using an insulated tool, next to an unpainted surface such as the feedline and depress the igniter. If there is a spark, the igniter is OK, the pilot is not functioning and must be replaced, see SERVICE PROCEDURE III for pilot replacement. If no spark is present the igniter is not functioning and must be replaced. See SERVICE PROCEDURE V for gas control disassembly/reassembly.



Feedline

Insulated jumper  
wire

# The Bradford White UDS/UDH Series

SERVICE PROCEDURE V  
Gas Control  
Testing, Disassembly & Replacement

## Honeywell Gas Control Testing, Disassembly, and Replacement

The Gas Control is made up of (5) major components; the control cover, the piezo igniter, the valve body, the temperature sensor, and the back plate. The Gas Control is designed so that any of these components may be replaced without replacing the entire Gas Control.

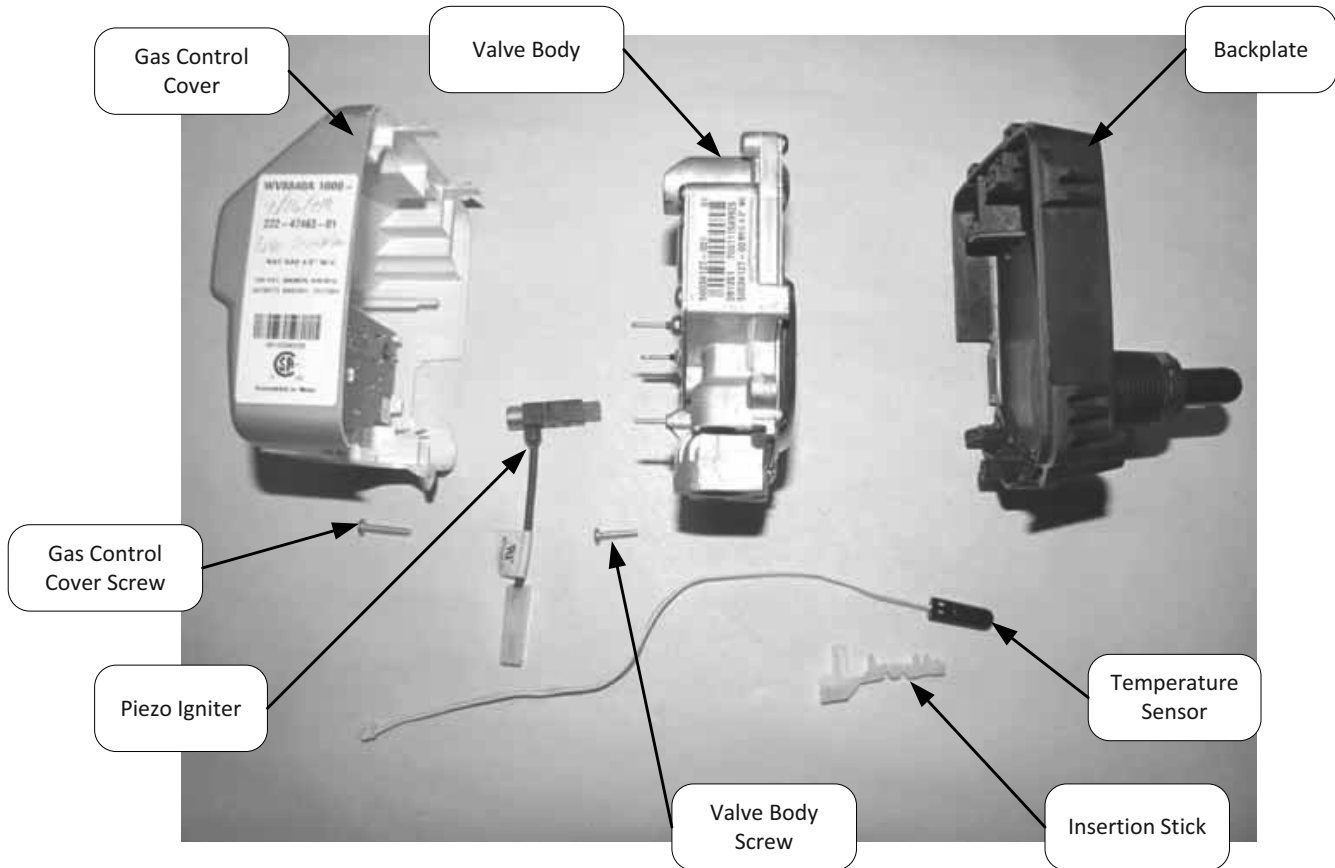

## LINE PRESSURE

The Gas Control is designed for a maximum line pressure of 14.0" w.c. and a minimum line pressure of 1.0" w.c. over the water heater's rated manifold pressure (check rating plate). Line pressure must be checked with the main burner on and off to assure proper readings.

# The Bradford White UDS/UDH Series

## SERVICE PROCEDURE V Gas Control Testing, Disassembly & Replacement

**MANIFOLD PRESSURE TESTING** (this procedure presumes a maximum line pressure of 14.0" w.c.)

- Step 1. Set the Gas Control to the "OFF" position.
- Step 2. Remove pressure tap plug and install 1/8" NPT pipe, coupling, & pressure tap.
- Step 3. Connect manometer to pressure tap.
- Step 4. Follow instructions located on the lighting instructions label and proceed to light the main burner and observe manometer reading.
- Step 5. Proper operating range for natural gas is: 4.0"  $\pm$ 0.5" w.c.  
Proper operating range for LP gas is: 10.0"  $\pm$ 0.5" w.c.
- Step 6. If pressure is within the range specified in the previous step, set Gas Control knob to the "OFF" position, remove manometer and pressure tap, and replace pressure tap plug. Check for gas leaks prior to placing water heater back into operation by following the instructions located on the lighting instruction label or the lighting instructions located in the installation and operation manual.
- Step 7. If gas pressure is outside the specification noted above, refer to "Honeywell Gas Control Testing, Disassembly, and Replacement" to replace Gas Control or valve body.



Gas Control shown in the "OFF" position

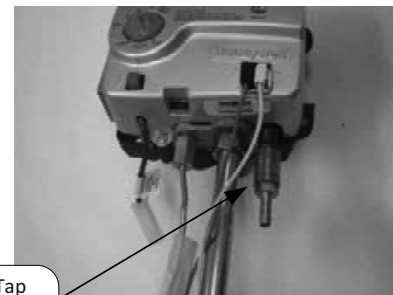

Pressure Tap  
Shown Installed

### **THERMOPILE TESTING**

See SERVICE PROCEDURE II

### **ECO (Energy Cut Off) TESTING**

The Honeywell Gas Control is designed with an ECO device that will reset.

**To reset the Gas Control** after an error code (4), turn the Gas Control knob to the "OFF" position and wait a minimum of (5) minutes before relighting following the instructions located on the lighting instruction label or the lighting instructions located in the installation and operation manual.

# The Bradford White UDS/UDH Series

SERVICE PROCEDURE V  
Gas Control  
Testing, Disassembly & Replacement

## TEMPERATURE SENSOR TESTING

If Control has gone into lockout due to excessive tank temperature (four flash, three second pause) reset control by rotating gas control knob to "OFF" position and wait a minimum of (5) minutes. Then follow lighting instructions and return gas control knob to desired setpoint.

Observe Green LED indicator. Does error code 4 (four flash, three second pause) continue?

**Temperature Sensor Testing**  
Following "Gas Control Disassembly/Reassembly" instructions, disassemble Gas Control to access temperature sensor.

With the temperature sensor still in the back plate, use a multi-meter set to the Ohms setting, determine the resistance of temperature sensor (see caution and photos above)

Once the temperature sensor resistance values are known, the water temperature must also be known to determine if the resistance values are correct. See next page to obtain water temperature.  
Are temperature sensor resistance values correct?

Replace Gas Control

Replace temperature sensor

Resume normal operation.

**CAUTION**  
DO NOT use standard multimeter probes for this test. Doing so will damage connector. Use special pin type electronic probes or small diameter wire pins inserted into connector.



Using a multi-meter set to the ohms setting, insert one meter probe (see caution) into center wire position of thermal well connector, insert the second probe (see caution) into either of the outside wire positions (see photo on left).

Alternate the probe on the outside position to the opposite outside wire position (see photo on right).

# The Bradford White UDS/UDH Series

SERVICE PROCEDURE V  
Gas Control  
Testing, Disassembly & Replacement

**▲ WARNING**  
**Stored water may be HOT when performing the following steps in this procedure.  
 Take necessary precaution to prevent personal injury.**

**DETERMINE WATER TEMPERATURE INSIDE TANK**

**Note:** It is important to understand once the resistance for the temperature sensor is determined from the previous page, water flow through the water heater should not occur. Prior to drawing water from drain valve, turn off the cold water supply to the water heater. This will prevent cold water flow into the tank affecting the resistance value of the temperature sensor.

- Step 1. Set the Gas Control knob to the “OFF” position.
- Step 2. Turn off inlet water supply to water heater.
- Step 3. Draw approximately 4 gallons of water from drain valve into a container, or suitable drain, and discard. Draw an additional gallon and immediately measure water temperature using an accurate thermometer. It may be necessary to open a hot water faucet to allow water heater to drain.
- Step 4. Using the chart below, determine correct resistance value for the water temperature from step 3.

Example: If temperature of water is 84°F, then the resistance through the sensor would be 8449 (see shaded area). NOTE: Sensor resistance increases as the temperature decreases.

**Sensor Resistance at Various Temperatures**

In Degrees F										
°F	0	1	2	3	4	5	6	7	8	9
40	26109	25400	24712	24045	23399	22771	22163	21573	21000	20445
50	19906	19383	18876	18383	17905	17440	16990	16553	16128	15715
60	15314	14925	14548	14180	13823	13477	13140	12812	12494	12185
70	11884	11592	11308	11032	10763	10502	10248	10000	9760	9526
80	9299	9078	8862	8653	8449	8250	8057	7869	7685	7507
90	7333	7165	7000	6839	6683	6531	6383	6238	6098	5961
100	5827	5697	5570	5446	5326	5208	5094	4982	4873	4767
110	4663	4562	4464	4368	4274	4183	4094	4006	3922	3839
120	3758	3679	3602	3527	3453	3382	3312	3244	3177	3112
130	3048	2986	2925	2866	2808	2752	2697	2643	2590	2538
140	2488	2439	2391	2344	2298	2253	2209	2166	2124	2083
150	2043	2004	1966	1928	1891	1856	1820	1786	1753	1720
160	1688	1656	1625	1595	1566	1537	1509	1481	1454	1427
170	1402	1376	1351	1327	1303	1280	1257	1235	1213	1191
180	1170	1150	1129	1110	1090	1071	1953	1035	1017	999
190	982	965	949	933	917	901	886	871	857	842
200	828	814	801	788	775	762	749	737	725	713

# The Bradford White UDS/UDH Series

## SERVICE PROCEDURE V Gas Control Testing, Disassembly & Replacement

### GAS CONTROL DISASSEMBLY/REASSEMBLY

- Step 1. Rotate knob of the Gas Control to the “OFF” position.
- Step 2. Turn off gas supply to water heater.
- Step 3. Disconnect gas supply line from Gas Control.
- Step 4. Disconnect igniter wire.
- Step 5. Disconnect main burner feedline, pilot tube and thermopile wires from gas control.
- Step 6. Remove Gas Control cover screw.



Rotate knob counter-clockwise to the “OFF” position.



- Step 7. Depress both tabs on the top of the Gas Control cover and pull to remove.



### **CAUTION**

Use caution not to bend or damage valve body pins when removing or installing Gas Control cover.

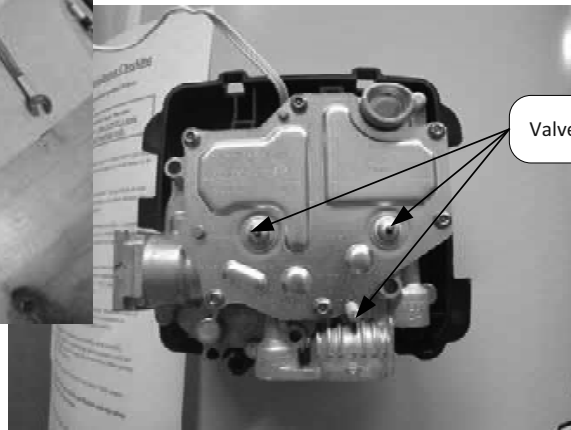



# The Bradford White UDS/UDH Series

SERVICE PROCEDURE V  
Gas Control  
Testing, Disassembly & Replacement

## GAS CONTROL DISASSEMBLY/REASSEMBLY

Step 8. Disconnect temperature sensor from control board and remove wire from the temperature sensor wire routing clip.

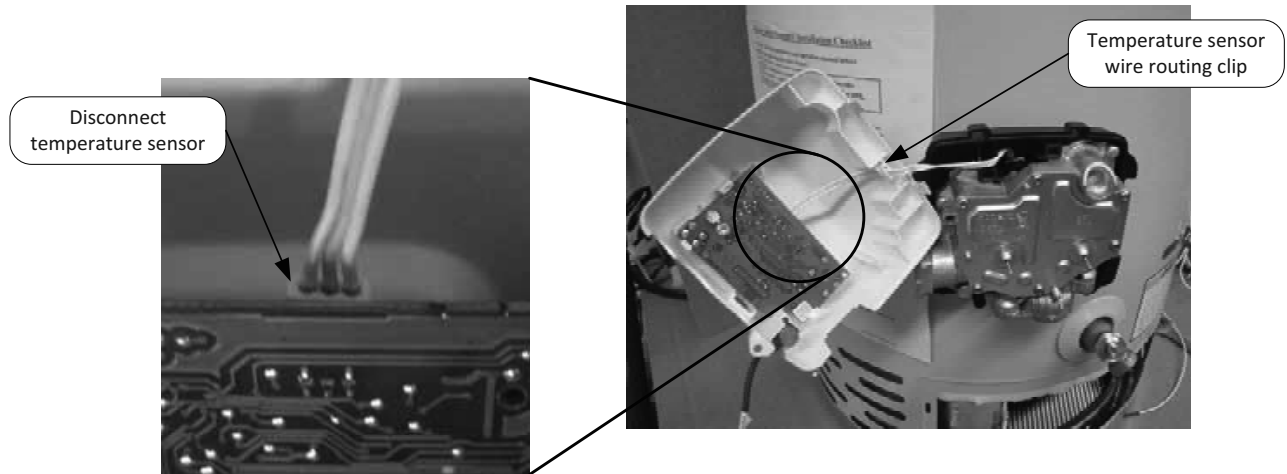

Step 9. Remove the piezo igniter from the control cover by releasing the lock tab on the control cover.

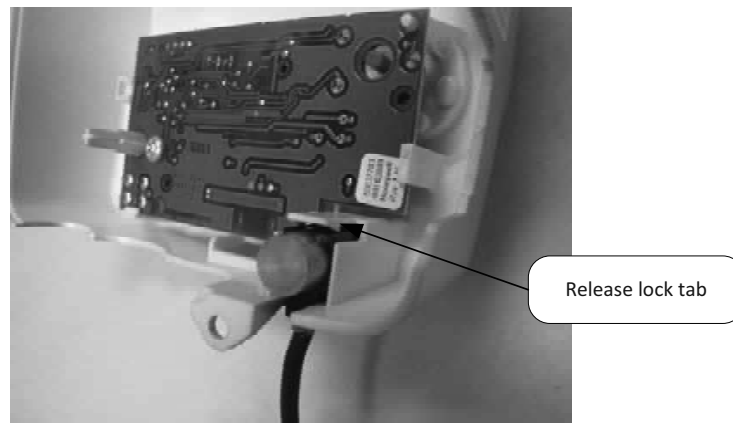

# The Bradford White UDS/UDH Series

SERVICE PROCEDURE V  
Gas Control  
Testing, Disassembly & Replacement

## GAS CONTROL DISASSEMBLY/REASSEMBLY

Step 10. Remove the valve body by removing screw located at the lower left corner then unclipping the lower right side from the backplate first followed by the lower left side using a flat head screwdriver.

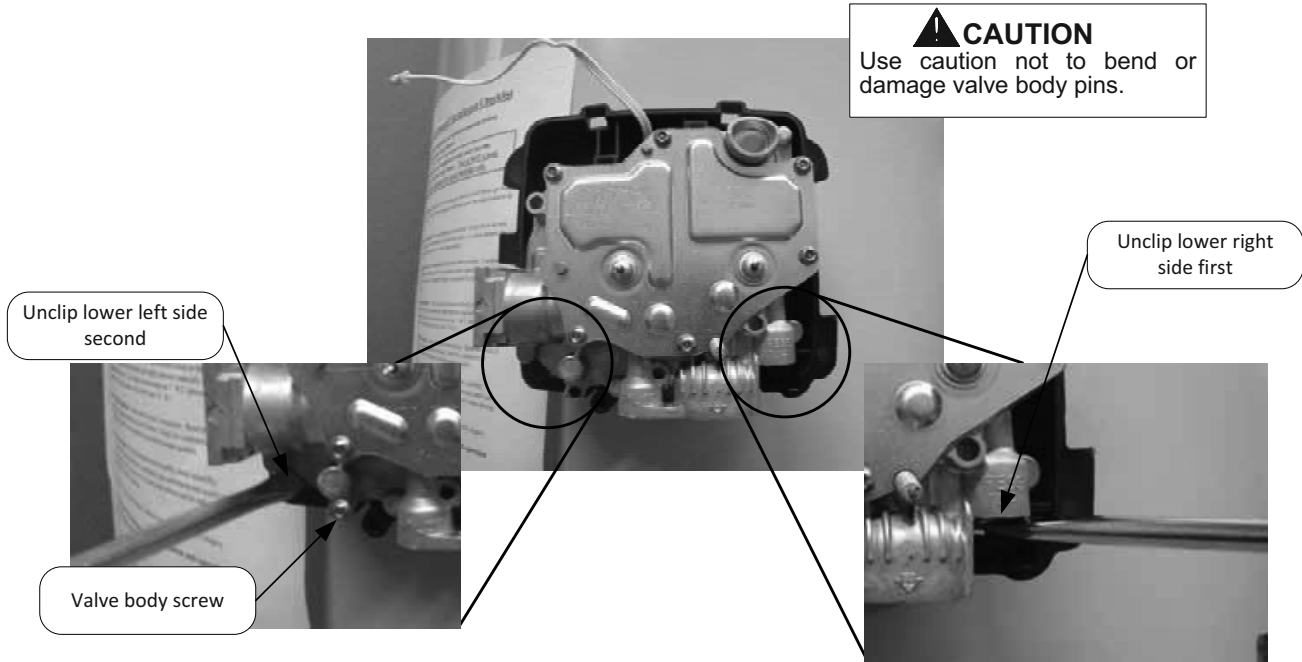

Step 11. Remove temperature sensor and insertion stick from backplate by first removing wire from the temperature sensor wire routing clips located on the backplate. Note the orientation of insertion stick, insertion stick can only be installed in one way.

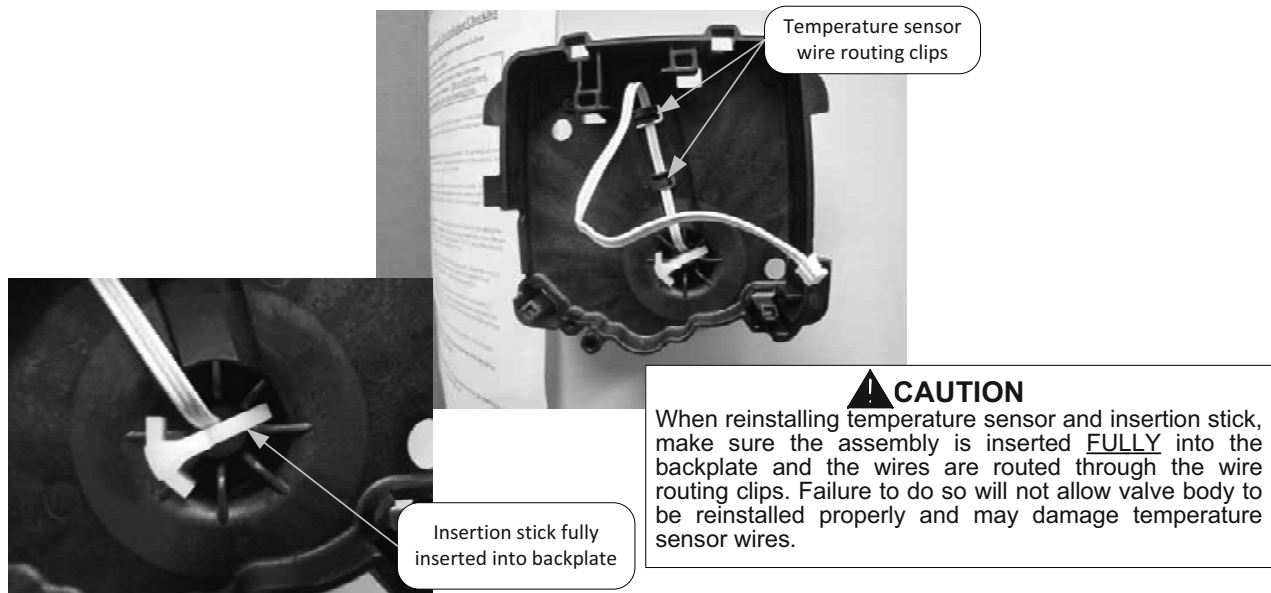

# *The Bradford White* **UDS/UDH** **Series**

SERVICE PROCEDURE V  
Gas Control  
Testing, Disassembly & Replacement

## **GAS CONTROL DISASSEMBLY/REASSEMBLY**

Step 12. Remove temperature sensor from insertion stick by pulling apart as illustrated below.

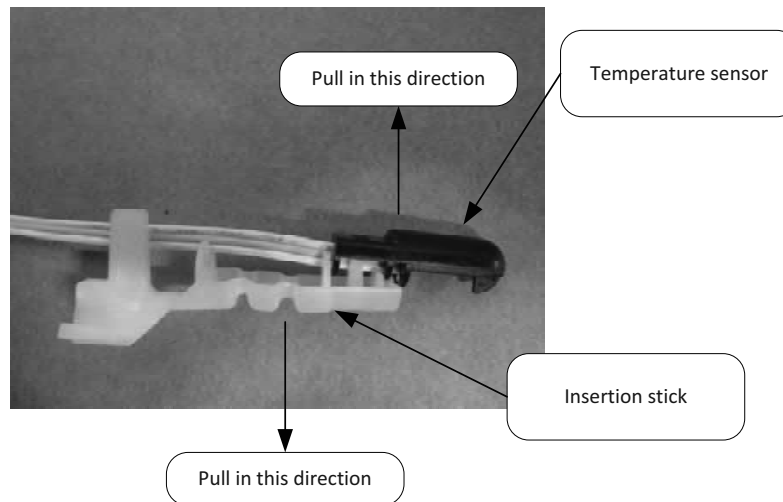

Step 13. To reassemble Gas Control, follow the previous steps in reverse order. Once Gas Control is reassembled, burner assembly is reinstalled, and the gas supply line is reconnected, resume water supply to water heater. Be sure tank is full of water before relighting.

Step 14. To resume operation, follow the instructions located on the lighting instruction label or the lighting instructions located in the installation and operation manual.

# The Bradford White UDS/UDH Series

## SERVICE PROCEDURE V Gas Control Testing, Disassembly & Replacement

### GAS CONTROL REPLACEMENT

Step 1. Rotate knob of the gas control to the "OFF" position.

Step 2. Turn off gas supply to water heater.

Step 3. Disconnect gas supply line from gas control.

Step 4. Turn off water supply and drain water heater completely.

Step 5. Remove the wire clip from the feedline.

Step 6. Disconnect main burner feedline, pilot tube, white thermopile wire and igniter wire from gas control and bend the main burner feedline and pilot tube out of the way. Also disconnect the red wire leading from the thermopile from the red wire leading from the gas control.

Step 7. Remove the gas control from the water heater by rotating counter-clockwise. It may be necessary to use a length of 1/2" NPT pipe threaded into the inlet of the gas control.

Rotate knob counter-clockwise to the "OFF" position.

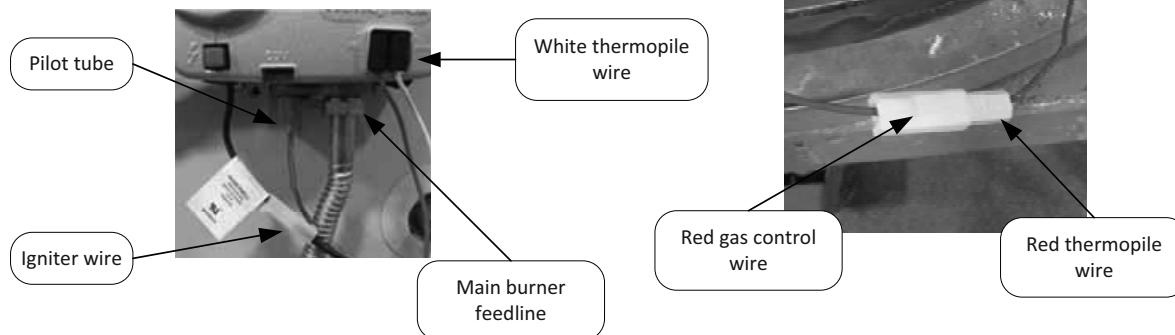

Step 8. Install new gas control into the water heater.

- Install gas control into water heater by rotating clockwise. **DO NOT** use a wrench on the gas control body or damage to the gas control may occur. If necessary, use a length of 1/2" NPT pipe threaded into gas inlet of gas control.
- Bend the main burner feedline and pilot tube back to the gas control and attach to the gas control. Connect the igniter wire and the white thermopile wire to the gas control. Connect the red wire from the gas control to the red wire from the thermopile.
- Gather the igniter wire, white thermopile wire and red thermopile wire near the side of the feedline. Use the clip that was removed in Step 5 to secure the wires to the feedline.
- Connect gas supply to inlet of gas control.

Step 9. Resume the water supply to the water heater. Be sure that the tank is full before operation is resumed.

Step 10. To resume operation follow the instructions located on the lighting instruction label or the lighting instructions located in the installation and operation manual.

# The Bradford White UDS/UDH Series

SERVICE PROCEDURE VI  
Burner Operation Inspection, Adjustment  
Cleaning and Replacement

## **MAIN BURNER: Inspection, Cleaning and Replacement**

At periodic intervals (not more than 6 months) a visual inspection should be made of the main burner for proper operation and to insure no debris is accumulating.

Main burner should light smoothly from pilot and burn with a blue flame with a minimum of yellow tips. After 5 minutes of operation the burner screen will become radiant and the flame will soften and turn orange. If the burner screen does not become radiant after 5 minutes of operation it must be cleaned (see burner cleaning procedure below).

Main burner must be free from any debris accumulation that may effect burner operation (see burner cleaning procedure below).

### **⚠ DANGER**

Under no circumstances shall flammable materials be used or stored in the vicinity of the water heater. With the inner door removed the Bradford White Defender Safety System will be inactivated. If flammable vapors are present, a fire or explosion may result causing property damage, personal injury or death.

### **⚠ WARNING**

Inner door and burner components may be **HOT** when performing this operation. Take necessary precaution to prevent personal injury.

## **BURNER CLEANING**

- Step 1. Remove burner and inner door assembly per SERVICE PROCEDURE I, steps 1 through 9.
- Step 2. Thoroughly inspect burner screen and burner venturi and remove any loose debris accumulation. Inspect burner screen for any openings larger than the normal screen openings.
- Step 3. Use compressed air and/or a vacuum to remove any scale or other debris accumulation from the burner screen and venturi.

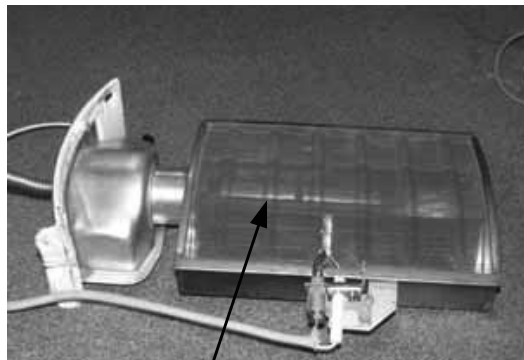

Burner Screen

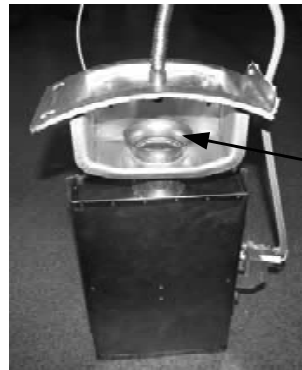

Burner Venturi

# The Bradford White UDS/UDH Series

## SERVICE PROCEDURE VI Burner Operation Inspection, Adjustment Cleaning and Replacement

Step 4. Disconnect (unscrew) feedline from the main burner door.

Step 5. Remove main burner orifice from feed line (3/8" wrench). Inspect and clean if necessary

Step 6. Remove pilot assembly, refer to SERVICE PROCEDURE III for cleaning and inspection.

Step 7. Reassemble burner.

Step 8. Reinstall burner and inner door per SERVICE PROCEDURE I, steps 9 through 19.

Step 9. To resume operation, follow the instructions located on the lighting instruction label or the lighting instructions located in the installation and operation manual.

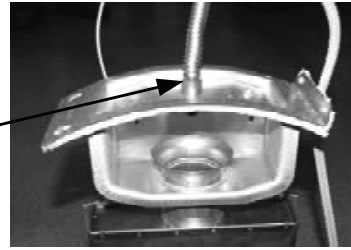

Feedline



Main Burner Orifice

# The Bradford White UDS/UDH Series

SERVICE PROCEDURE VII  
Dip Tube and Anode  
Inspection and Replacement

## DIP TUBE INSPECTION AND REPLACEMENT

### **WARNING**

Heater components and stored water may be **HOT** when performing the following steps in this procedure. Take necessary precaution to prevent personal injury.

Step 1. Rotate knob of gas control to “OFF” position.

For Honeywell Control, rotate knob counter-clockwise to the “OFF” position.



Step 2. Turn off cold water supply to heater. Connect hose to drain spigot of water heater and route to an open drain. Open a nearby hot water faucet to vent heater for draining. Open drain spigot of hot water heater and allow heater to drain to a point below the inlet connection nipple.

Step 3. Disconnect inlet nipple from plumbing system.

Step 4. With an appropriate wrench, remove inlet nipple/dip tube from the water heater. Use caution not to damage pipe threads.

Step 5. Visually inspect inlet nipple/dip tube. Inlet nipple/dip tube should be free of cracks and any blockage. Hydro-jets located near the bottom of the dip tube should be open and free of any blockage. Anti-siphon hole located approximately 6" from the bottom of nipple, should be free of any blockage.

Any damage such as cracks, restriction due to deformation or unintentional holes are not field repairable and the inlet nipple/dip tube must be replaced.

Step 6. Upon completion of inspection or subsequent replacement, reinstall inlet nipple/dip tube into heater. Connect nipple to plumbing system, resume water supply and refill heater with water.

Step 7. To resume operation follow the instructions located on the lighting instruction label or the lighting instructions located in the installation and operation manual.

# The Bradford White UDS/UDH Series

## SERVICE PROCEDURE VII Dip Tube and Anode Inspection and Replacement

### ANODE INSPECTION AND REPLACEMENT

#### **WARNING**

Heater components and stored water may be **HOT** when performing the following steps in this procedure. Take necessary precaution to prevent personal injury.

Step 1. Turn off water supply to water heater. Rotate knob of gas control to “OFF” position.

For Honeywell Control, rotate knob counter-clockwise to the “OFF” position.



- Step 2. Turn off cold water supply to heater. Connect hose to drain spigot of water heater and route to an open drain. Open a nearby hot water faucet to vent heater for draining. Open drain spigot of hot water heater and allow heater to drain to a point below the outlet connection nipple.
- Step 3. Disconnect outlet nipple from plumbing system.
- Step 4. With an appropriate wrench, remove outlet nipple/anode from the water heater. Use caution not to damage pipe threads.
- Step 5. Visually Inspect outlet nipple/anode. Outlet nipple/anode should show signs of depletion, this is normal. If depletion is  $\frac{1}{2}$  of the original anode diameter (approximately  $\frac{5}{8}$ ” diameter), replacement is recommended. If any of the steel core of the anode is exposed, replacement is recommended.
- Step 6. Upon completion of inspection or subsequent replacement, reinstall outlet nipple/anode into heater. Connect nipple to plumbing system, resume water supply and refill heater with water.
- Step 7. To resume operation, follow the instructions located on the lighting instruction label or the lighting instructions located in the installation and operation manual.



# The Bradford White UDS/UDH Series

## Generic Parts List

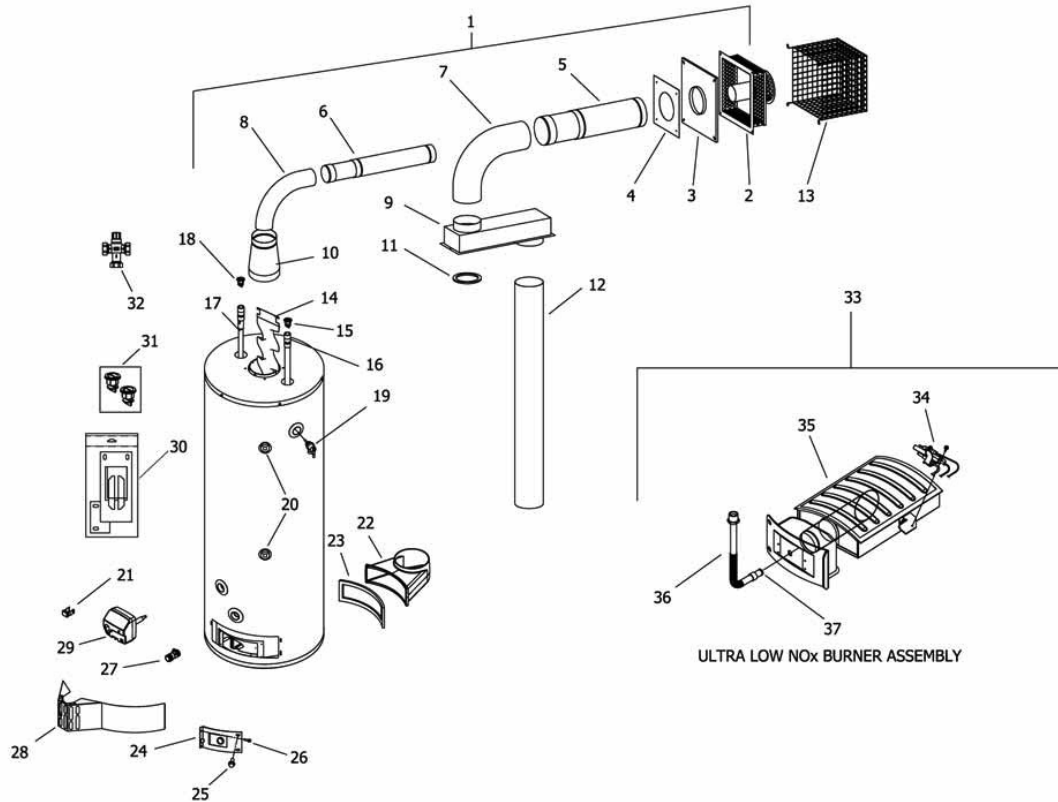

- |    |                                      |    |  |
|----|--------------------------------------|----|--|
| 1  | Vent Package                         | 19 | T&P Relief Valve                             |
| 2  | Air Intake Terminal                  | 20 | $\frac{3}{4}$ " NPT Tank Plug (UDH Models)   |
| 3  | Outer Wall Mounting Plate            | 21 | Feedline Spring Clip                         |
| 4  | Backing Plate                        | 22 | Air Intake Boot                              |
| 5  | Telescopic Air Intake Tube           | 23 | Air Intake Boot Gasket                       |
| 6  | Telescopic Vent Tube                 | 24 | Complete Right Side Inner Door               |
| 7  | Intake Elbow                         | 25 | Screw-#10-12 x $\frac{3}{4}$ Hex Washer Head |
| 8  | Exhaust Elbow                        | 26 | Screw-#8-18 x $\frac{3}{4}$ Hex Washer Head  |
| 9  | Plenum                               | 27 | Brass Drain Valve                            |
| 10 | Flue Reducer                         | 28 | Outer Door                                   |
| 11 | Plenum Gasket                        | 29 | Gas Control                                  |
| 12 | Air Intake Tube                      | 30 | Inner Door Gasket Kit                        |
| 13 | Air Intake Terminal Guard (Optional) | 31 | Heat Trap Kit                                |
| 14 | Flue Baffle                          | 32 | ASSE Approved Mixing Valve (Optional)        |
| 15 | Heat Trap (Inlet)                    | 33 | Ultra Low NOx Burner Assembly                |
| 16 | Cold Water Inlet Tube                | 34 | Pilot Assembly                               |
| 17 | Hot Water Outlet/Anode               | 35 | Ultra Low NOx Burner                         |
| 18 | Heat Trap (Outlet)                   | 36 | Main Burner Feedline                         |
|    |                                      | 37 | Main Burner Orifice                          |







# **BRADFORD WHITE®**

W A T E R H E A T E R S

Ambler, PA

For U.S. and Canada field service,  
contact your professional installer or  
local Bradford White sales representative.

**Sales/800-523-2931**  
**Fax/215-641-1670**  
**Parts Fax/215-641-2180**

**Technical Support/800-334-3393**  
**Fax/269-795-1089**

**Warranty/800-531-2111**  
**Fax/269-795-1089**

**International:**  
**Telephone/215-641-9400**  
**Telefax/215-641-9750**



# **BRADFORD WHITE-CANADA® INC.**

Mississauga, ON

**Sales/866-690-0961**  
**905-238-0100**

**Fax/905-238-0105**

**Technical Support/800-334-3393**

**Email**

**parts@bradfordwhite.com**  
**techserv@bradfordwhite.com**

**www.bradfordwhite.com**