

Fahrenheit

TID-893/TID-893B

In-Dash 7" Monitor
Touch Screen
DVD/CD/MP3/MP4
AM/FM Radio
With Bluetooth

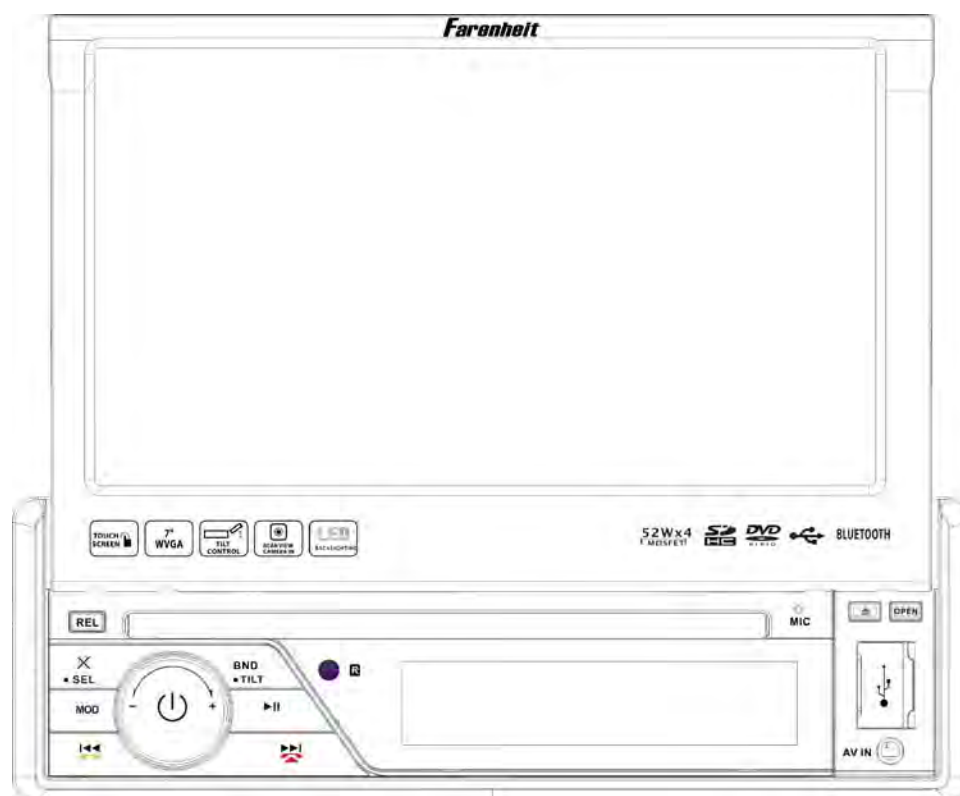

Owner's Manual

Take the time to read through this owner's manual.
Familiarity with installation and operation procedures will help you obtain the best
Performance from your new DVD-receiver.

WARNING!

To promote safety, certain functions are disabled unless the parking brake is on. The Unit is designed to detect parked status and must be connected to the power supply side of the parking brake switch. Improper connection or use of this connection may violate applicable law and may result in serious injury or damage. To avoid the risk of damage and injury and the potential violation of applicable laws, this unit is not for use with a video screen that is visible to the driver.

- To avoid the risk of accident and the potential violation of applicable laws, the front Video image feature should never be used while the vehicle is being driven. Also, other video displays should not be in a location where it is a visible distraction to the driver. In some countries or states the viewing of images on a display inside a vehicle even by persons other than the driver may be illegal. Where such regulations apply, they must be obeyed and this unit's DVD features should not be used.
- Please remember to wear your seat belt at all times while operating your vehicle. If you are ever in an accident, your injuries can be considerably more severe if your seat belt is not properly buckled.
- The supplier waves any and all liability when these warnings are not followed.

OPERATION PRECAUTIONS





- Only connect to a 12Vdc battery and negative grounding.
- Avoid placing the product in direct sunlight, in areas with high levels of dust, high temperatures (over 40°C) or high humidity (over 90%). In case of high temperatures, cool down the car interior by means of ventilation or air-conditioning.
- Operate in well ventilated areas.
- Do not turn on or off the product in short intervals. When turning the unit off, wait for at least 10 seconds prior to turning the unit on again. Do not operate the player with scratched, bended or broken discs and when a disc is not loaded properly, do not force it into the player.
- Do not watch video playback while driving which will cause serious danger and risks of traffic accident. It may violate the laws and regulations.
(There may be exceptional case, i.e., using rear view camera and navigation system)
- Do not install the unit where the operation for safety driving is restrained.
- Do not disassembly the unit by yourself, if need repairing, please take the unit to the after service center.
- Do not open and close the monitor manually, it may damage the monitor tilt system.
- Do not touch the LCD screen by hard objects, it may damage or give scratch to the LCD screen.
- If the back of monitor touches dashboard or air-conditioner inlet etc after open the monitor , then setup TILT level in monitor TILT menu to prevent damage from repeat touching.
- Car parking under direct sunlight may increase the temperature inside the car and the unit may not be in proper operation, please try it again after the temperature returns to normal.
- Do not replace the fuse on the power cable without professional guidance, using improper fuse may cause damage to the unit or even cause burn the unit.
- Do not use irregular shaped Disk.
- IR remote control operation may be hindered by monitor when the monitor is opened, thus please use the remote control at the similar level of remote control receiver.
- Do not install the unit where the cooling fan is blocked.

CONTENTS

WARNING!	2
OPERATION PRECAUTIONS	2
Accessories	4
INSTALLATION / UN-INSTALLATION.....	4
WIRING CONNECTIONS	6
Front panel.....	8
REMOTE CONTROL	10
REMOVE BATTERY.....	13
MAIN MENU	14
◆ RADIO PLAYER.....	14
◆ DVD PLAYER	15
◆ Insert USB/SD/MMC and play track will display as follows:	16
◆ TV Mode.....	16
◆ AV-IN Mode.....	17
◆ SETTING CONTROL	17
SOUND CONTROL	17
DISPLAY CONTROL	18
RADIO CONTROL.....	18
GENERAL CONTROL	18
DVD SET UP MENU.....	19
SYSTEM INFORMATION	20
CALIBRATION.....	20
Other functions	20
BLUETOOTH SECTION (FOR TID-893B ONLY)	21
NOTES ON DISC	23
TROUBLESHOOTING.....	24
TROUBLESHOOTING.....	25
TECHNICAL SPECIFICATIONS.....	26

Accessories

Package contains the following accessories for installation and operation of the unit.

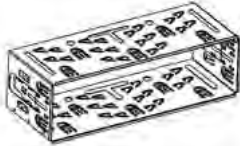
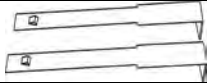
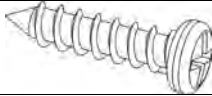
(1) Washer, Spring Washer, M5 Nut	1 each	
(2) Mounting Strap	1	
(3) Blot	1	
(4) Screw 4*6	4	
(5) Mounting Collar	1	
(6) Release Key	2	
(7) Screw 5*20	1	



Remote Control



Warranty card

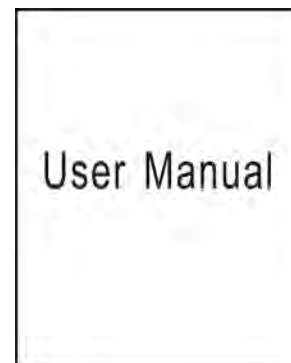

User Manual

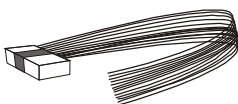

Power Cable

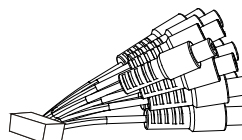

RCA Cable



Trim ring

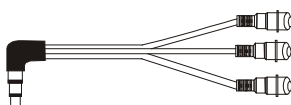

1x AV-IN Cable

Note:
Product image may vary from the actual delivery.

INSTALLATION / UN-INSTALLATION

Note

Before starting installation of the unit, make sure the wiring is connected properly.

Use only the parts provided with the unit to ensure proper installation.

The use of unauthorized parts may cause malfunction.

Install the unit where it does not get in the driver's way and will not injure the passenger in case there is a sudden stop, like an emergency stop.

◆ INSTALLATION (Figure 1)

- ✧ Insert Half Sleeve into dash-board hole and bend mount tabs outwards to fix it
- ✧ If necessary, place the mount strap at the rear of the unit and fix it with provided washer as figure 2.
- ✧ Push the unit into the Half Sleeve until you hear a click sound
- ✧ Place Trim Ring over the unit and installation is completed as figure 3. (Some vehicle may not need Trim Ring)

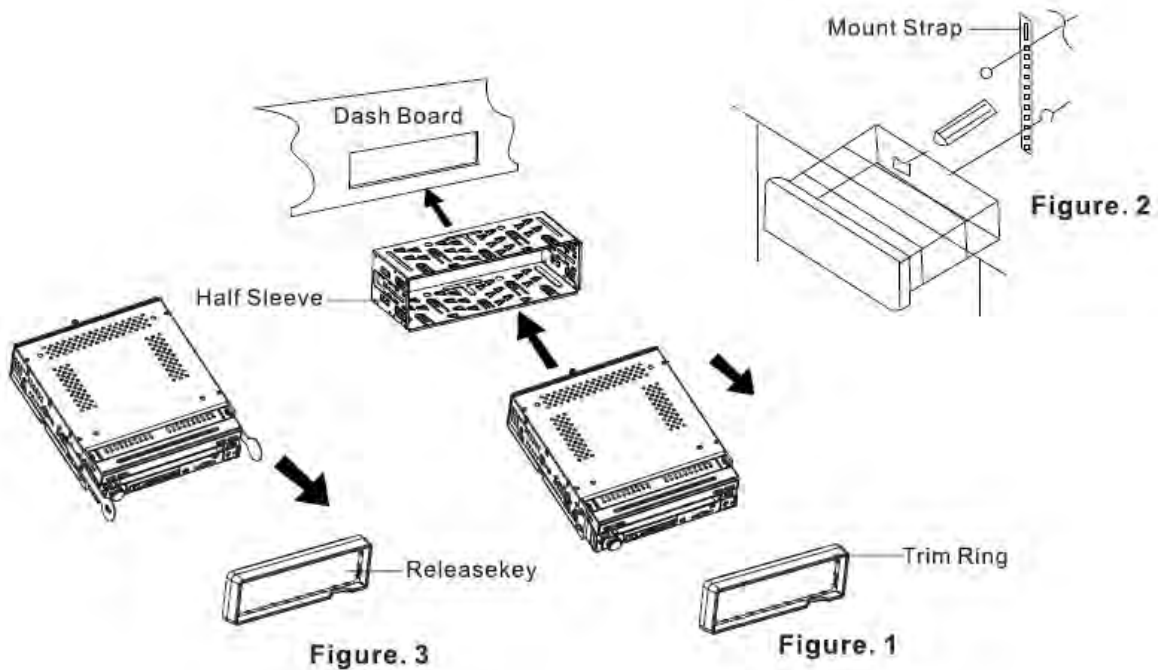

◆ UN-INSTALLATION

Insert the supplied extraction keys into the unit and pull the unit out with keeping the extraction keys. (as Figure. 4)

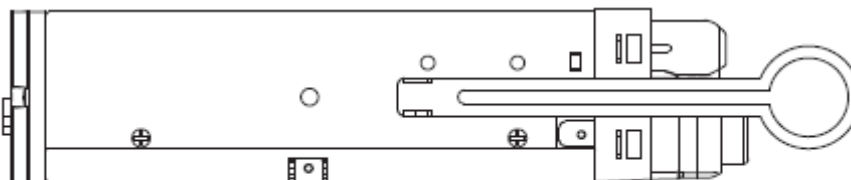
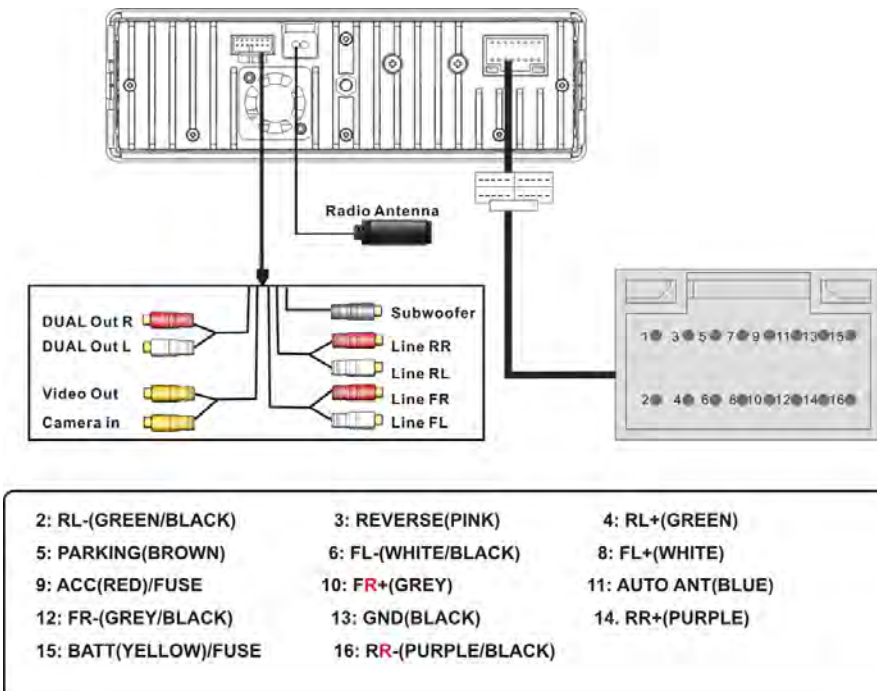

Figure. 4

WIRING CONNECTIONS



NOTE: Never connect cable to the system while it is connected to the battery power. Whenever the unit is disconnected from the battery, the preset memory will be erased and the unit will go back to its factory defaults.

Note: To watch video the parking wire should be connected to brake signal. 2 cables are connected to a Hands-Free device (not included).

Parking wire

Note: The parking wire is connected with brake signal; for safety, the programs can be seen on the monitor after braking the car.

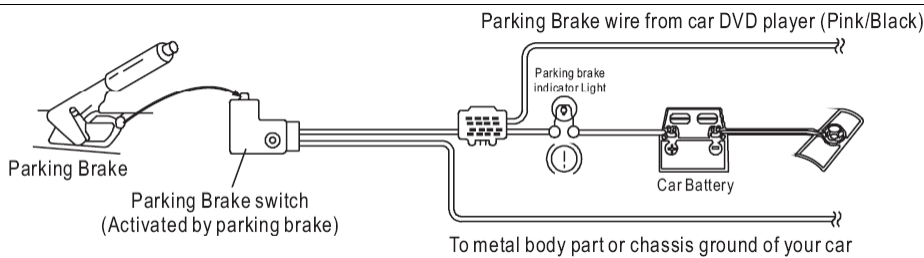

Connecting the reversing line to taillight on the

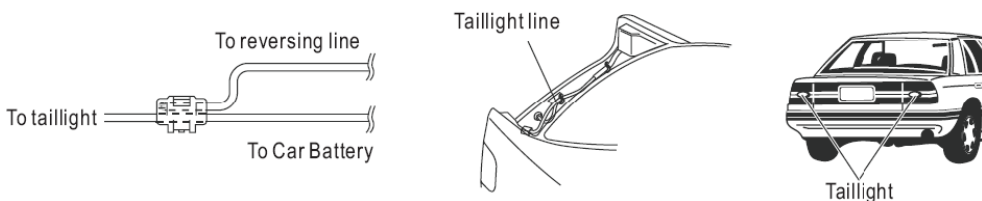

car

After connecting, when you start up the reverse gear, the unit will receive the picture from car rear view camera.

Note:

- Only use groundless loudspeakers.
- Use only loudspeakers of minimal 40Watt, using fewer watts may result in damaging your loudspeakers at higher volumes.
- Use 4~8 Ω (Ohm impedance) loudspeakers only; using higher or lesser impedance may damage the unit.
- Do not use 3-cable loudspeakers and do not connect the loudspeakers minus to the car body (GND). The unit is using a BTL circuit and each loudspeaker must be connected with insulated cables according the diagram.
- Loudspeaker cables and/or optional external power amplifiers must always be about 30cm away from the antenna and/or antenna extension parts.

Connect the speakers according the following diagram, incorrect connections will damage the unit or your loudspeakers

Correct connection

Left front - Right front | Left rear - Right rear

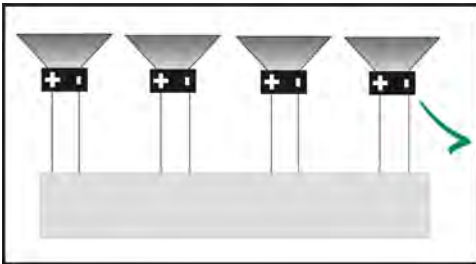

Incorrect connections

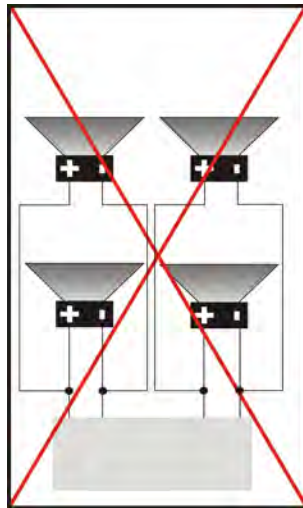
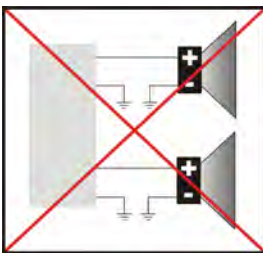
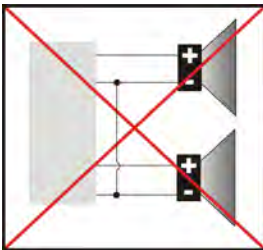

Front panel

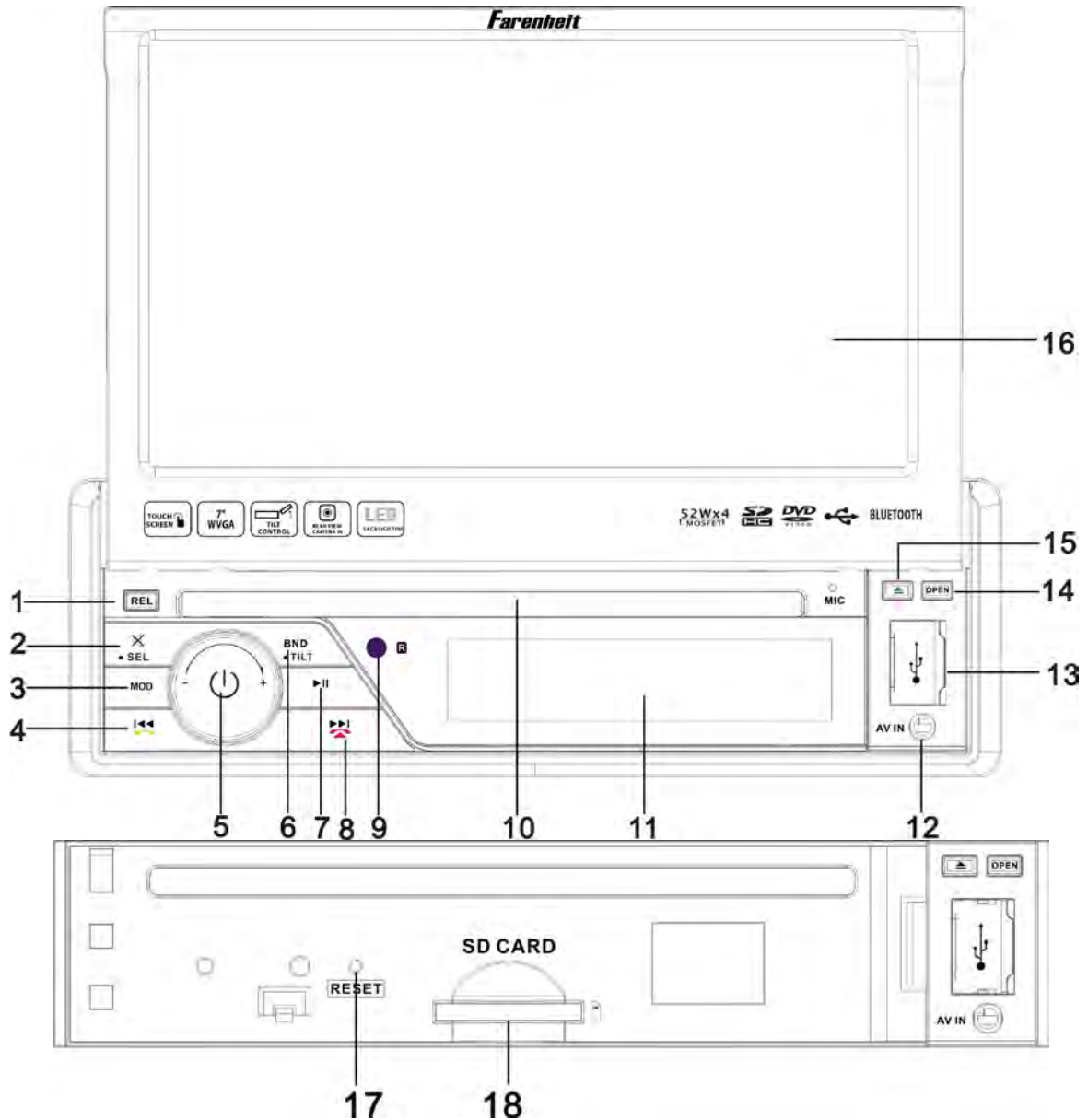

1. Release Button

Press to detach and release the front panel. When released the unit will switch off automatically after a few second. **Detach/Attach the Panel:** Press REL button and pull out the left side to detach the panel. To attach it, insert the right side first and then press the left side until hear a click sound.

2. SEL/MUTE Button

SEL : Long press it to enter SOUND SETTING menu to adjust the sound settings; EQ => BASS => TREBLE => BALANCE => FADER => EQ. Adjust the level by click touch screen to increase or decrease.



Short press it to MUTE the volume output, press it again to resume volume when the power is on.

3. MODE Button

Press it to select the mode: Radio, DISC (if there is a disc in unit), USB (if there is a USB device in the unit), CARD (if there is a SD/MMC card in the unit), Bluetooth (For TID-893B) and AV IN.

4. Button/ Button

In RADIO mode, press to start automatic searching, press and hold for two seconds to start manual searching, then press to tune each frequency step downward.

In DVD / SD / USB mode, press  button to skip to the previous track. Press  button and hold for two seconds to activate fast reverse (REW) search in a track.

In Bluetooth mode, press to make a call after inputted a phone number or accept an incoming call.

5. VOL Knob / POWER Button

Press it to turn on the unit, press it again to turn the unit off.

(* Press any button to turn on the unit except REL button and EJECT button on panel, and EJECT button on remote control)

VOL Knob: Adjust the volume level by turning the knob clockwise to increase or counterclockwise to decrease.

DUAL KEY setting: Long press it to choose C-DUAL/D-DUAL (Buttons on panel and RC control radio only), D-DAUL (Buttons on panel and RC control DVD only)

6. BAND/TILT Button

In Radio mode, press to change radio band in sequence of FM4 → FM2 → FM3 → AM1 → AM2.



Press and hold for 2 second to adjust the Monitor tilt angle: TILT ANGLE 1 => TILT ANGLE 2 => TILT ANGLE 3 => TILT ANGLE 4.

7. / PLAY / PAUSE / Button

In Disc, USB, SD CARD mode, press it to pause / play. Press it again to resume playback

8. Button/ button

In Radio mode, press to start automatic searching, press and hold for two seconds to start manual searching, then press them to tune each frequency step upward.

In DVD / SD / USB mode, press  button to skip to the next track. Press  button and hold for two seconds to activate fast forward (FF) search in a track.

In BLUETOOTH mode, press to reject a coming call or hang up while calling.

9. IR Sensor

IR Remote control signal receiving window. Max distance is 6-8 meters, 45 angles.

10. DISC slot

11. Info Display

Information Display LCD when operation the unit.

12. AV-in Jack

Put the AV plug into the AV-IN jack which was marked on front panel.

13. USB slot

14. OPEN Button

Press this to open and close the TFT monitor. WARNING: Do not obstruct the monitor while in the opening or closing cycle, this may cause damage to the monitor mechanism and is **NOT** covered under warranty.

15. EJECT Button

Press to eject a disc. If the disc is not removed for about 10 seconds after eject, the disc is reinserted automatically.

16. TFT display

17. RESET Button

Press it with a thin, sharp object. The device will then be reset to factory default settings.

18. SD/MMC CARD slot

SD/MMC card slot, for Multimedia playback files only. Insert a SD/MMC CARD into this slot and the unit will automatically start reading and playback the card. * Supported Music File Format: MP3, WMA Files.

REMOTE CONTROL

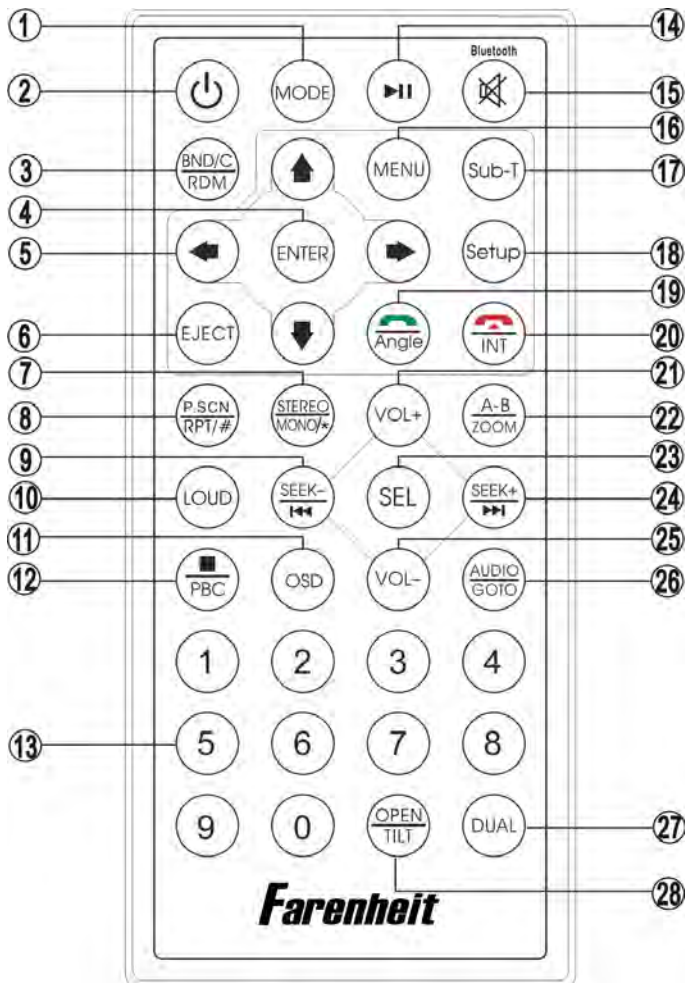

- 1: MODE
- 2: POWER
- 3: BAND/RANDOM/Clear
- 4: ENTER
- 5: UP/DOWN/LEFT/RIGHT
- 6: EJECT
- 7: STEREO/MONO/*
- 8: P.SCN/RPT/#
- 9: BACKWARD/SEEK-
FAST BACKWARD
- 10: LOUD
- 11: OSD
- 12: PBC/STOP
- 13: Digit numbers
- 14: Play/Pause
- 15: Mute/Bluetooth
- 16: MENU
- 17: SUBTITLE
- 18: SETUP
- 19: ANGLE/Accept
- 20: INT/Eject
- 21: VOLUME PLUS
- 22: A-B/ZOOM
- 23: SEL
- 24: FORWARD/SEEK+
FAST FORWARD
- 25: VOLUME MINUS
- 26: AUDIO/GOTO
- 27: DUAL
- 28: OPEN/TILT

1. MODE button

Press it to select the mode: Radio, DISC (if there is a disc in unit), USB (if there is a USB device in the unit), CARD (if there is a SD/MMC card in the unit), Bluetooth (For TID-893B) and AV IN.

2. POWER

power on or off

3. BAND/ RDM/Clear

In Radio mode, press to change radio band in sequence of FM4 → FM2 → FM3 → AM1 → AM2 .In DVD mode, press to play randomly .In Bluetooth mode ,press briefly it to clear single wrong number .long press it to clear all the wrong number.

4. ENTER button

Press it to confirm selection or setting.

5: Cursor buttons

Use the buttons to select the menu item. the title, track or to show next frame.

6. EJECT button

Press it to eject the disc.

7. STEREO/MONO/*

Press STEREO button to select STEREO or MONO.
In BLUETOOTH mode, press it to make a * symbol.

8. P.SCN/ RPT /#

In SD CARD/ USB mode, press to repeat REP 1 => REP DIR => REP ALL

In DVD mode, press to start repeat REP OFF=>REP Chapter=>REP Title=>REP Off.

In Radio mode: PS (Preset Scan): Press to scan all preset stations in the memory of the current band and stay on each memory stations for about 5 seconds.

AS (Auto Save): Long press to save the stations with good reception automatically.

In BLUETOOTH mode, press it to make a # symbol.

9. ⏮ / seek- buttons

In DVD mode, Press ⏮ button to skip to the previous track. Press and hold ⏮ button for two seconds to activate fast reverse (REW) search in a track.

In RADIO mode, press ⏮ button to start searching automatic, press and hold for two seconds to start manual searching. ⏮ button Frequency down.

10. LOUD

Press to set LOUD on or OFF.

11. OSD button

In DVD mode press it to enter the OSD menu, press and hold for 2 seconds to set video setup. (HUE / SATURATION / COLOR RESET / BRIGHT / CONTRAST / SHARP / BACK)

12. STOP/PBC button

Press it to Stop playback from the current position, press it again to final stop to the very beginning. Press PLAY/PAUSE button to play.

Press and hold for two seconds to set PBC on/ off in VCD mode.

13. Digit 0-9 buttons

In radio mode, select 1-6 the desired band; In DVD mode, select track.

In BLUETOOTH mode, press it to input phone number, long press 0 number to make a + symbol

14. PLAY/PAUSE button

In DVD mode, press it to pause playback, press again to resume.

15. Mute button/Bluetooth button

✖ : Short press this button to mute the volume output, press it again to resume volume.

Long press this button to enter into Bluetooth mode.

16. MENU button

Press it to show main menu, in DVD mode, long press it to enter TITLE MENU (Enable only if the DVD disc with title menu).

17. SUBTITLE button

Press it to select the subtitle language (Available only if the disc with subtitle function).

18. SETUP button

In DVD mode press it to enter the setup menu.

19. ANGLE Button/Accept Button

In DVD mode, press it repeatedly to change the viewing angle (Available only with a recorded DVD file or DVD disc that has this function).

In BLUETOOTH mode, press to make a call after inputted a phone number or accept an incoming call.

20. INT Button /Reject Button

Press it to activate the intro function. You can play the beginning of every track for 10 seconds in sequence.

In BLUETOOTH mode, press to reject a coming call or hang up while calling

21. VOL+ button

Press to increase volume level.

22. A-B/ZOOM button

During playback, press it at the starting point of section you want to repeat(A), press this button again at the ending point of the section you want to repeat (B), section A-B repeating starts. Press it again to cancel the A-B repeat function.

Press it and hold for two seconds in DVD mode to zoom the image in or out in the sequence of ZOOM 2-> ZOOM 3-> ZOOM 4-> ZOOM 1/2-> ZOOM 1/3-> ZOOM 1/4.

23.SEL button

Press it to enter the SOUND SETTING menu, and press Cursor UP/DN buttons to choose an item and press cursor left/right buttons to set the item. Press SEL button again to exit the menu.

24. ►► / seek + buttons

In DVD mode, Press ►► button to skip to the next track. Press and hold ►► button for two seconds to activate fast forward (FF) search in a track.

In RADIO mode, press ►► button to start searching automatic, press and hold for two seconds to start manual searching. ►► button Frequency up.

25. VOL- button

Press to decrease volume level.

26. AUDIO/GOTO button

In DVD mode press it to select the audio language.

In VCD mode, press it to select the sound track in the sequence of MONO L =>MONO R =>STEREO.

Go to: in DVD mode, press and hold for 2 seconds to show TIME SEARCH menu, select number and confirm to go to certain position directly. When press ▲ button to enter TITLE/CHAPTER selection mode, select number and confirm to go to certain TITLE or CHAPTER position directly.

27. DUAL button

Activating Dual Zone Mode

- Access GENERAL setup in the SETTINGS menu and press the icon for DUAL mode and select ON.
- Insert a DVD or begin playing a movie from SD card or USB.

Controlling the Front Zone (C-DUAL)

- Press and hold the front panel POWER button, or the DUAL button on the remote control, until C-DUAL appears on the screen.
- Press the ARROW icon in the top right corner of the screen to return to the main menu. Select the mode you wish to use in the front zone.
- The units screen will change to the selected mode. The DVD or SD/USB movie will continue to play only on the VIDEO OUT and DUAL OUT audio outputs, while the selected mode audio is played through the front and rear LINE outputs. All front panel and remote controls will affect only the selected mode activated for the front zone.

Controlling the Rear Zone (D-DUAL)

- Press and hold the front panel POWER button, or the DUAL button on the remote control again, until D-DUAL appears on the screen.
- All front panel and remote control functions for DVD, USB, or SD, including volume, will control only the media playing for the rear zone.

Press and hold the front panel POWER button, or DUAL button on the remote control until D-DUAL disappears to return to normal unit operation. Press and hold the front panel POWER button, or DUAL button on the remote control again to reactivate Dual Zone Mode.

27. OPEN/TILT button:

Short press it open or closed the monitor; long press it to adjust the tilt angle of monitor.

REMOVE BATTERY

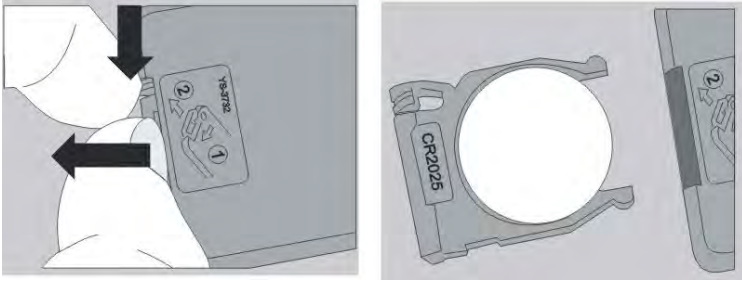

Note:

- The distance may vary according to the brightness of ambient light.
- If the remote is not used for an extended period of time, remove the battery to prevent possible damage from battery leakage and corrosion.
- Do not place any objects between the remote control unit and the sensor on the unit.
- Do not drop the remote control onto the floor; it will damage it beyond repair.
- Do not use the remote control unit, while simultaneously operating the remote control unit of any other equipment; they may interfere resulting in improper operation.
- The battery normally last for about one year although depending how often the remote control is used. If the remote control unit isn't working even when it is operated near the unit, replace the battery with a new battery of the same make and use only a lithium cell battery type: CR2025 (3V).
- Dispose empty batteries in accordance with your local governmental regulations.
- Do not short-circuit, disassemble, heat or dispose of fire or flames the battery.
- Keep the battery out of reach of children, should the battery be swallowed, immediately consult a doctor.

MAIN MENU

The best way to discover the program is to explore each screen in detail, and to find out how to move from one to another. Read this chapter for a guided tour.

Unit starts by displaying the Main menu.

This is the root of the screen hierarchy, and you can simply access all features by tapping on the touch screen buttons.

Tap the icons to enter a desired mode.



◆ RADIO PLAYER



To start Radio, tap RADIO button on main menu screen.



Mute the sound



VOL increase or decrease by touch the button accordingly



Touch this button can choose FM1, FM2, FM3, AM1, AM2.



Touch this button can scan the stations from 1-6, Long Touch it to save the stations with good reception automatically and scan each station for about 5 seconds



Touch this button to search stations



Touch this button to open manual select station backward



Touch this button to open manual select station forward



Touch this button to search stations.



Touch this button to select stereo or mono sound reception.



Touch this button to select reception of local station or DX for distance station.

◆ DVD PLAYER

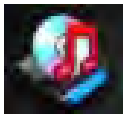

To start DVD Player, tap on DVD button from main menu screen.

TOUCH SCREEN MENU

You will not see any buttons while DVD is played. Buttons will appear when you tap on TFT screen. Tap the screen again to hide the buttons.



Insert DVD disc



insert VCD disc

NOTE

1. DVD Player will automatically start playing when you insert any DVD disc, MEMORY card or USB device.
2. Warning displays if the vehicle is moving for driver's safety.
3. DVD Player will not only play video, but also picture and music files as well.

File Management

DVD mode plays files in a) Disc b) USB c) MEMORY card (main MEMORY card slot in inner panel).



Pause playback. Press it again to continue playback.



Stop playback. Press it to Stop playback from the current position, press it again to final stop to the very beginning.



Start fast rewind or fast forward. Press one of the keys again to change the spooling speed. Press the Play key to regain normal playback.



In DVD mode, touch it can choose Repeat chapter =>repeat title =>repeat off.
In VCD mode, touch it can choose Repeat REP 1 => REP DIR => REP ALL.



Touch it to select the subtitle language (Available only if the disc with subtitle function).



in DVD mode touch it to select the audio language (Available only if the disc with subtitle function); In VCD mode touch it can choose MONO L---MONO R---STEREO.



In VCD mode touch it can choose PBC ON or OFF

MENU

In DVD mode touch it to enter TITLE MENU (Enable only if the DVD disc with title menu).



Touch it to select previous or next track.



Select the viewing angle of the touch-screen.

◆ Insert USB/SD/MMC and play track will display as follows:

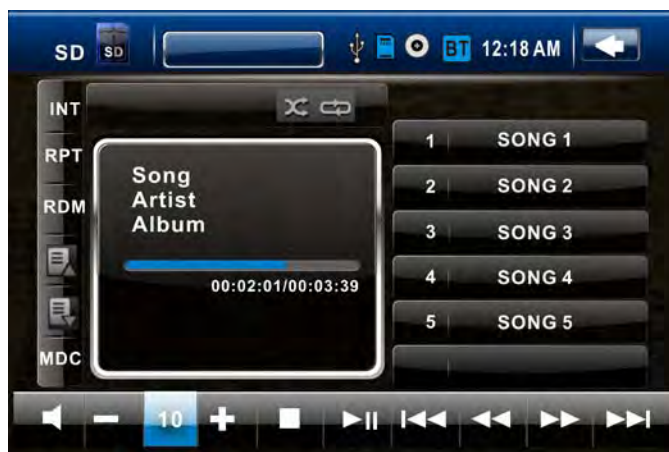
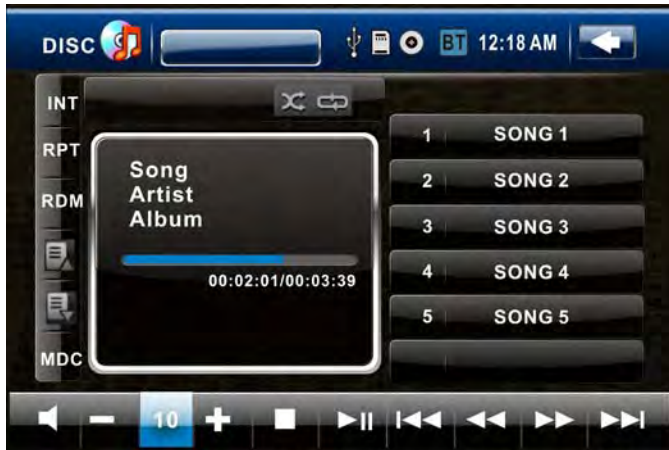

Mute the sound.



Decrease the volume.



Increase the volume.



Stop button. Press it to Stop playback from the current position, press it again to final stop to the very beginning



Play/pause button. Press it to pause the track, press again to resume.



Press it button to restart a track, FRx2x4x8x20-play will be display.



Press it button to skip to the next track. FFx2x4x8x20-play will be display.



Press it to skip to the previous track.



Press it to skip to the next track.



Press it to activate the intro function. You can play the beginning of every track for 10 seconds in sequence.



Press it to repeat REP 1 => REP DIR => REP ALL



Press it to play track randomly.



Press it to enter previous page.



Press it to enter next page.



Press it to go to folder selection.

◆ TV Mode



To start TV Mode, tap TV icon on the main menu screen.

◆ AV-IN Mode



To start AV-IN Mode, tap AV-IN icon on the main menu screen.

Connect the external audio/video signal source to this unit. Select AV-IN mode in the main menu or by pressing Mode on the front panel.

Note: If there is no external video input, the TFT displays “NO SIGNAL”.

1. Press the \triangle / ∇ icon to adjust TFT angle.
2. Press the \leftarrow icon to be back to main menu.

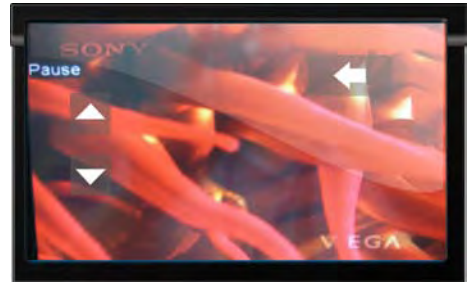

◆ SETTING CONTROL

Your device has default system settings. You can customize the settings to suit your personal needs. Once you change settings, your new settings will remain until you change it again. To start SETTING, tap SETTING icon on the main menu screen.

SOUND CONTROL

Tap SOUND button to show SOUND 1 menu.



EQUALIZER	Select EQ mode
BASS	Bass up/down
TREBLE	Treble up/down
BALANCE	Left/Right Balance Control
FADER	Front/Back Fader Control

Tap ∇ button to show sound 2 menu.



BEEP	Keypad sound setting
LOUDNESS	Set LOUD ON/OFF
SUBWOOFER	Set SUBWOOFER ON or OFF

DISPLAY CONTROL

Tap DISPLAY button to show DISPLAY menu.

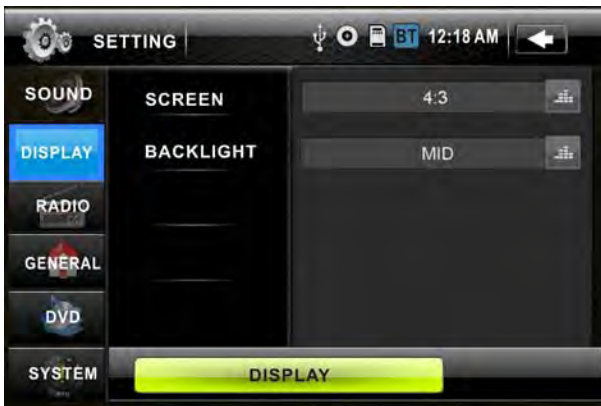

SCREEN	Screen setting 16:9, 4:3,FULL
Backlight	Backlight setting LOW, MID, HIGH

RADIO CONTROL

Tap RADIO button to show RADIO menu.



AREA	Set AREA:EUROPE-U.S.A-SOUTH AMERICA-RUSSIA
STEREO	Set STEREO ON or OFF
LOCAL	Set LOCAL ON or OFF

GENERAL CONTROL

Tap GENERAL button to show GENERAL 1 menu.



DUAL	Set DUAL ON/OFF
KEY	Key CURRENT
TILT MODE	Set TILT MODE auto or manual
TILT ANGLE	adjust monitor tilt angle
CLOCK DISPLAY	Set CLOCK display time ON or OFF

Tap  button to show GENERAL 2 menu.



CLOCK HOUR	Set 24Hour format or 12Hour format
CLOCK SETTING	Set CLOCK ADJUST time
AUTO CONNECT	Set the mobile telephone be connected automatically or manually with car radio.

DVD SET UP MENU

During the DVD playback, press the SETUP button to enter into the system settings main menu; press the up or down arrow buttons to move to the highlighted menu item and select one of the Setup Pages:



[1]. Subtitle Lang setting:

With this option you can select the preferred language for the subtitles. When the selected language is recorded on the disc then this language will automatically be shown. If not, the first language recorded on the disc is displayed.

[2]. Audio Lang setting:

With this option you can select the preferred language for the audio output. When the selected language is recorded on the disc (not all discs have multiple languages recorded) then this language will automatically be played. If not, the first language recorded on the disc is played.

[3]. DVD Menu Lang setting:

With this option you can select the preferred language for the disc menu. When the selected language is recorded on the disc then this language will automatically be selected. If not, the first language recorded on the disc is displayed.

[4] Password:

The password for this unit is initially set to factory default 0000. If you want to change your password, you need to enter the old password first and confirm it, and enter a new password and confirm. **WARNING:** if you forget your password, there is no possibility to reset the password again. Do not forget your password and write it down or store the password in a safe place.

[5] Rating / PARENTAL SETUP.

For DVD discs which support the USA rating system, setting up rating control can prevent children from watching content that might not be suitable for their age. You are asked to enter the password when you change the rating setting. The default password is 0000.

Code	Description
1.NONE	Kid safe
2.G	General Audiences – ALL ages admitted
3.PG	PARENTAL GUIDANCE SUGGESTED-Some material may not be suitable for children
4.PG-13	PARENTS STRONGLY CAUTIONED-Some material may be inappropriate for children under 13
5.PG-R	Restricted, under 17 requires accompanying parent or adult guardian.
6.R	RESTRICTED-Under 17 requires accompanying parent or adult guardian
7.NC-17	NO ONE 17 AND UNDER ADMITTED
8. Adult	Above 17 Admitted

[6] TV SHAPE:

Set TFT screen mode to the correct ratio:

Three screen ratio modes are available, Normal/PS (4:3 Pan Scan), Normal/LB (4:3 Letterbox) and Wide (16:9). Different disc formats will display different images depending this setting and the screen size used.

[7] NTSC/ PAL:

Select this menu item to set up your preferred video output format. PAL is commonly used in Europe, NTSC is commonly used in the USA and Japan. Auto is commonly used.

[8] DEFAULT:

Factory reset. Set all values to Factory default values including memory and preset stations.

SYSTEM INFORMATION

Press SYSTEM button to show the information of the system. You can view detail system information including serial number of the software.



CALIBRATION

CALIBRATION of the touch screen. CALIBRATION screen is described as below.

When the target moves to another position, tap and hold at the center of the new target. Repeat each time to complete the calibration process. When completed, tap anywhere in screen to go back to menu screen.

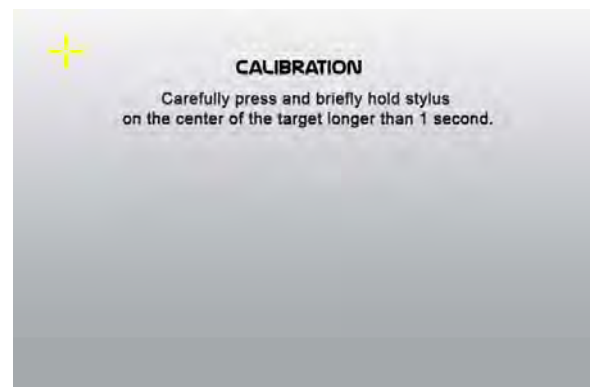

Other functions

Subwoofer

Connect the subwoofer to the unit using sub output (see electrical diagram). Tap MENU on screen enter into main menu setting choose setting menu. choose SOUND and set subwoofer ON to enable subwoofer.

Parking

When the car is stopped and the parking brake is working, the screen can display the video image, otherwise the screen can't display the video image

Back View Camera

This unit is equipped with back view camera output. The camera is used to observe the situation behind the vehicle when you are backing the car.

Please connect your back view camera with the back car video input. And connect the reverse wire for back a car with the rear gear light. Rear view camera picture will be enabled when you are backing the car.

BLUETOOTH SECTION (FOR TID-893B ONLY)

Warning: Driving and having a Telephone conversation at the same time is dangerous, please park your car before having a telephone conversation. The supplier waves any and all liability when this warning is not followed.

To enter Bluetooth mode, you can tap Bluetooth icon on Main menu or long press the mute/Bluetooth button on the Remote Control or press mode button on remote or on front panel.

BT Main Menu



Bluetooth disconnect mode



Bluetooth connect mode

A user can make own choice by tap the buttons.

Tap CALLING button to use phone functions.

Tap MUSIC button to start BLUETOOTH music player .

Tap HISTORY button to check dialed, received, missed calls .

Tap PHONEBOOK button to use phone book functions.

Pairing Mode

At the 1st time when using BLUETOOTH, you need to pair the mobile phone first.

When a phone have not been paired with the unit, the BT icon and Pairing mark will blink continually on the panel.

When the unit have connect with phone ,the BT icon will turn on and the Mobile phone name (if available) will be display on the panel.

According to mobile pairing device manual, after searching new device (Fahrenheit), select it, input password "0000" and confirm ok, device paring is finished.



The text 'Enter Number' will shows on the panel after the pairing is completed. It means device is connected and ready for BLUETOOTH communication.

Auto-connect - Disconnect

When power on the unit, the last paired phone will be connected to the device via Bluetooth automatically, after searching about one minute, if the device cannot find the paired phone, it will stop searching. When in standby mode (unconnected), long press Bluetooth button on remote control to active auto-connect function and the device will search the last paired phone. If you want to disconnect the Bluetooth connection, tap the Pairing icon PAIRING button on Bluetooth main menu, and select phone book paring.

1.CALLING BUTTON

Tap on CALLING button to enter call mode.

In Call mode, the unit can be used as your phone. Making and receiving calls are possible with BLUETOOTH. Simply tap phone number and tap  button to make a call, and tap  button to hang up.

1.) Tap CLEAR button shortly to delete a wrong digit, tap the CLEAR button or press RDM/C button on remote for 3-4 seconds to delete all the numbers at once.

2) Tap the  button for 3-4 seconds, the device automatically makes a call to the latest call in its call log .

Voice Transfer

During a call, you can change a call from Bluetooth mode to phone by tapping Transfer button. To have a call in Bluetooth mode again, tap Transfer button.

NOTE: the phonebook only supports Western Characters. Any difference in character will be shown such as “ + , * or # ”.

2. BT PHONE BOOK

The unit can downloading the data from phone automatically when the pairing between a phone and the unit be completed.

The unit displays the data which have been downloading from a phone.

Select a number and tap Send button to make a calling. Press the PB-DOWN button, phonebook will be updated and downloaded with new phonebook. .

3. Call history mode

Tap HISTORY button to see history mode.

The unit can download automatically all the date from the mobile Phone.

Dialed /Received/Missed calls are saved In History mode .Tap Up/Down arrow load previous/next history record.

The calls in each category are orderly saved from the latest one to the final one..

Select a number and tap Send button to enter calling mode.

4. (A2DP) Music Mode

Tap MUSIC button to listen music in Bluetooth mode.

Tap the button for ‘music’ in Bluetooth main menu.

You can select the function with the key for previous, play / pause, stop, and next.

A2DP (Advanced Audio Distribution Profile) Music Player

A2DP is a function which can receive the audio frequency signal from the mobile phone, amplified by the car audio and played out by the car speakers.

Notice: your mobile phone need to support A2DP.

Tap the buttons on the screen as shown, or press corresponding buttons (PAUSE/PLAY, STOP, PREVIOUS/NEXT) on remote control to play, pause, play previous, or next music file.

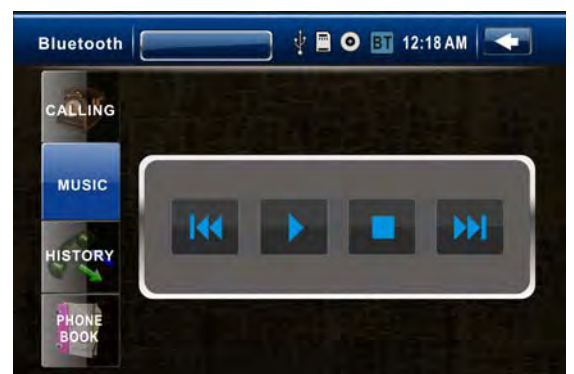
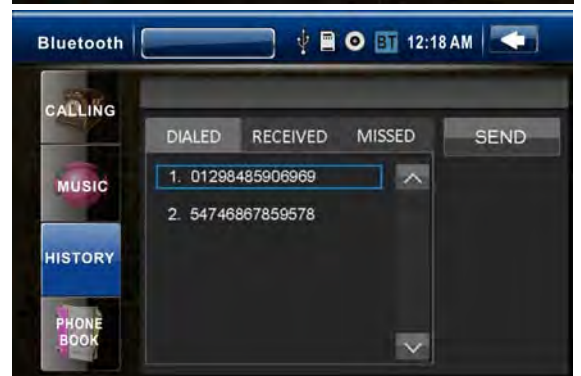
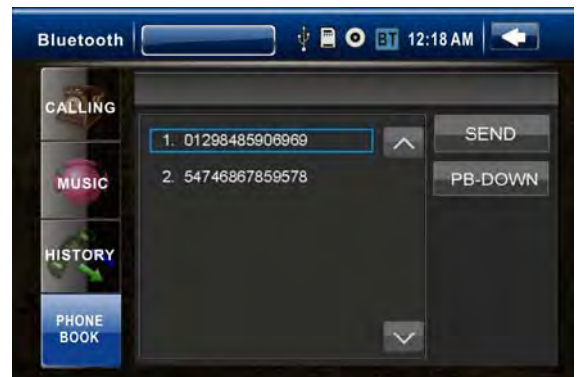

NOTES ON DISC

- ✧ Only use groundless loudspeakers.
- ✧ Use only loudspeakers of minimal 40Watt, using fewer watts may result in damaging your loud speakers at higher volumes.
- ✧ Use 4~8 Ω (Ohm impedance) loudspeakers only; using higher or lesser impedance may damage the unit.
- ✧ Do not use 3-cable loudspeakers and do not connect the loudspeakers minus to the car body.
- ✧ (GND). using a BTL circuit and each loudspeaker must be connected with insulated cables according the diagram.
- ✧ Loudspeaker cables and/or optional external power amplifiers must always be about 30cm. away from the antenna and/or antenna extension parts.
- ✧ If want to display for 7" TFT, parking wire must be connected to ground.

Handling discs

Handling

When holding
With both hands



When holding
with one hand



- Do not use damaged (cracked or warped) discs.
- Do not scratch the signal surface or let it get dirty.
- Do not attach paper or seals to discs. The player may be damaged if there is any exposed glue, etc., On discs. For rental discs in particular, extra labels are often attached to the discs. Check carefully for any exposed glue before using such discs.



Storing discs

- Always place discs in their case and store them vertically. Avoid storing discs in hot or humid places, places exposed to direct sunlight and places in which the temperature is extremely low.
- Read any cautions included with the discs carefully.

Cleaning discs

- Fingerprints or dust on discs may reduce sound or picture quality. Remove them by gently wiping the disc from the center toward the edges using a soft cloth.



- Do not use benzene, thinner or other volatile chemicals. Do not use record spray or antistatic spray either.
- We recommend using the separately sold cleaning set to clean discs.
- For tough dirt, apply some water to a soft cloth, wring out thoroughly, wipe off the dirt, then wipe the disc with a dry cloth.

Irregular shaped discs
Irregular shaped discs (heart-shaped discs, hexagonal discs, etc.) cannot be played on this player. Doing so could damage the player. Never use such discs.



TROUBLESHOOTING

	Symptom	Cause	Remedy
General	Power does not turn on. (No sound is produced.)	Fuse is blown	Replace with fuse of the same amperage. If the fuse blows again, consult your store of purchase
		In correct wiring	Consult your local retailer.
	No sound output when operating the unit with amplifiers or power antenna attached.	Power antennal lead is shorted to ground excessive current is required or remote on the amplifiers or power antenna.	1. Turn off the unit. 2. Remove all wires attached to the power antenna lead. Check each wire for a possible short to ground using an ohm meter. 3. Turn on the unit. 4. Reconnect each amplifier remote wire to the power antenna lead one by one. If the amplifiers turn off before all wires are attached, use an external replay to provide remote-on voltage (excessive current required).
			Nothing happens when buttons are pressed. Display is not Accurate
CD	Sound is bad directly after power is turned on.	Panel or main unit Connectors are dirty	Wipe the dirt off with a soft cloth moistened with cleaning alcohol.
		Compact disc is dirty	Clean the compact disc without scratches
	Sound is bad directly after power is turned on.	Compact disc is heavily scratched or warped	Replace with a compact disc without scratches.
LCD	Small LCD display error massage	Water droplets may form on the internal lens when the car is parked in a humid place	Let it dry for about 1 hour with the power on.
		When deck mechanism error, show ERROR 1	Reset the unit.
		When disc or servo error, it show ERROR 2	Change the disc or reset the unit.
		When USB error, t show ERROR 3 When SD error, it show ERROR 4	1.Remove the USB/SD and insert it again 2. File error, please check the file. 3. Reset the unit.

TROUBLESHOOTING

SYMPTOM	CAUSE	SOLUTION
NO POWER	THE CAR IGNITION IS NOT ON.	IF THE POWER SUPPLY IS PROPERLY CONNECTED TO THE CAR ACCESSORY SWITCH THE IGNITION KEY TO "ACC".
	THE FUSE IS BLOWN.	REPLACE THE FUSE.
DISC CANNOT BE LOADED.	PRESENCE OF DISC INSIDE THE PLAYER	REMOVE THE DISC IN THE PLAYER THEN PUT A NEW UPWARD.
DISC CANNOT BE READ.	INSERTING THE DISC IN UPSIDE DOWN.	INSERT THE COMPACT DISC WITH THE LABEL FACING UPWARD.
	COMPACT DISC IS EXTREMELY DIRTY OR DEFECTIVE.	CLEAN THE DISC OR TRY TO PLAY A NEW ONE.
	TEMPERATURE INSIDE THE CAR IS TOO HIGH.	COOL OFF UNTIL THE AMBIENT TEMPERATURE RETURNS TO NORMAL.
NO SOUND	VOLUME IS IN MINIMUM.	ADJUST VOLUME TO A DESIRED LEVEL.
	WIRING IS NOT PROPERLY CONNECTED.	CHECK WIRING CONNECTION.
THE OPERATION KEYS DO NOT WORK.	THE BUILT-IN MICROCOMPUTER IS NOT OPERATING PROPERLY DUE TO NOISE.	PRESS THE POWER BUTTON FOR ABOUT 10 SECONDS TO RESET THE UNIT.
	FRONT PANEL IS NOT PROPERLY FIX INTO ITS PLACE.	
SOUND SKIPS.	THE INSTALLATION ANGLE IS MORE THAN 30 DEGREES.	ADJUST THE INSTALLATION ANGLE TO LESS THAN 30 DEGREES.
	THE DISC IS EXTREMELY DIRTY OR DEFECTIVE.	CLEAN THE COMPACT DISC/TRY TO PLAY A NEW ONE.
THE RADIO DOES NOT WORK, THE RADIO STATION AUTOMATIC SELECTION DOES NOT WORK.	THE ANTENNA CABLE IS NOT CONNECTED THE SIGNALS ARE TOO WEAK.	INSERT THE ANTENNA CABLE FIRMLY SELECT A STATION MANUALLY.

TECHNICAL SPECIFICATIONS

General	
Power supply:	11~16V DC
Current consumption:	max. 10 A
Maximum power output:	52W x 4 channels (max)
Compatible formats:	DVD/SVCD/VCD/HDCD/MP3/MP4/VIDEO/CDDA/Picture CDCD-R/-RW/DVD±R/±RW playback
Dimensions (W x D x H) / weight:	165*178*50 mm/2 kg
Working temperature range:	-10°C - +60°C
ESP function:	10 sec. for Audio CD, 120 sec. for MP3
TFT display	
Screen size:	7 inch
Resolution:	480*243 dot
Aspect ratio:	4:3/16:9
Brightness:	400 cd/m ²
FM Stereo Radio	
Frequency range(EUROPE AREA):	87.5 – 108MHz(Step 50KHz)
Frequency range(SOUTH AMERICA AREA)	87.5 – 108MHz(Step 100KHz)
Frequency range(RUSSIA AREA)	87.5 – 108MHz(Step 50KHz) 65-74MHz(Step 10KHz)
Frequency range(U.S.A AREA)	87.5 – 107.9MHz(Step 200KHz)
Preset memory stations:	18
AM/MW Radio	
Frequency range(EUROPE AREA):	522kHz - 1620 KHz(Step 9KHz)
Frequency range(SOUTH AMERICA AREA)	520kHz - 1710 KHz(Step 10KHz)
Frequency range(RUSSIA AREA)	522kHz - 1620 KHz(Step 9KHz)
Frequency range(U.S.A AREA)	530kHz - 1710 KHz(Step 10KHz)
Preset memory stations:	12
Audio specification	
Frequency response:	20 Hz-20 KHz

Specifications are subject to change without notice. Mass and dimension are approximate.

Manual version: Mar 2012