

Harmonic filters FN 3416 / FN 3418

ECOsine™ Compact economy line of passive harmonic filters

SCHAFFNER
energy efficiency and reliability



- Help to comply with IEEE-519, table 10-3 (TDD)
- Help to comply with EN61000-3-12, table 3 (THD)
- Support an efficient utilization of electrical system capacity
- Ideal for motor drives with 6-pulse rectifier front-end
- Same filter for both diode and thyristor (SCR) rectifiers

Approvals

UL US LISTED
(in preparation) **CE**

ROHS

Technical specifications

Nominal operating voltage:	3x 380 to 500 VAC ±10% (FN 3416) 3x 380 to 480 VAC ±10% (FN 3418)
Operating frequency:	50 Hz ± 1 Hz (FN3416) 60 Hz ± 1 Hz (FN3418)
Nominal motor drive input power rating:	4 to 200 kW (FN3416) 5 to 250 HP (FN3418)
Total harmonic current distortion THID*:	According to EN61000-3-12, table 3 <10% @ rated power (with L _{dc}) <15% @ rated power (without L _{dc})
Total demand distortion TDD:	According to IEEE-519, table 10-3
Efficiency:	>98% @ nominal line voltage and power
High potential test voltage:	P → E 2500 VAC (2 sec)
Protection category:	IP20
Cooling:	Internal fan cooling, unregulated
Overload capability:	1.6x rated current for 1 minute, once per hour
Ambient temperature range:	-25°C to +45°C fully operational +45°C to +55°C derated operation** -25°C to +70°C transport and storage
Flammability corresponding to:	UL 94 V-2 or better
Design corresponding to:	UL508, EN61558-2-20, CE (LVD2006/95/ EC)
MTBF @ 45°C/500V (Mil-HB-217F):	200 000 hours
SCCR***:	100 kA

* System requirements: THVD <2%, line voltage unbalance <1%

Note: performance specifications in this datasheet refer to six-pulse diode rectifiers. SCR rectifier front-end will produce different results, depending upon the firing angle of the thyristors.

** I_{derated} = I_{nominal} * √((70°C - T_{amb}) / 25°C)

*** External UL-rated fuses required.

Features and benefits

FN3416 (50Hz) and FN3418 (60Hz) models of the ECOsine™ product family represent the very compact "economy line" of load-applied passive harmonic filters.

They are ideal for non-linear three-phase equipment with B6 rectifier front-end that do not require the industry leading performance provided by Schaffner ECOsine™ FN3410/12 filters.

The performance, however, is still sufficient to comply with EN61000-3-12 (for THD) or with IEEE-519, table 10-3 (for TDD).

Schaffner ECOsine™ filters help to unburden the electrical infrastructure from excess loading and heat caused by current harmonics, and therefore support a better utilization of electric system capacity.

Lower harmonics also reduce the risk of system resonances and potential downtime of sensitive electronic equipment.

FN3416/18 filters upgrade standard motor drives to "low-harmonic drives" quickly and easily.

Typical electrical schematic

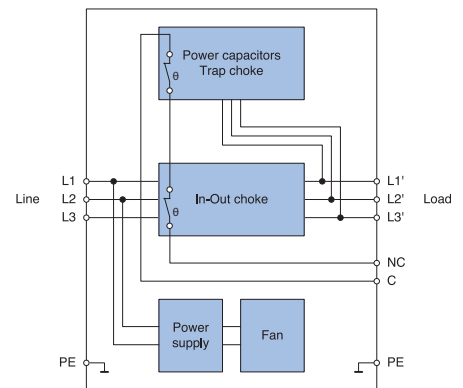

Typical applications

- Three-phase power conversion equipment with front-end six-pulse rectifier (diode or SCR)
- Motor drives, like those used e.g. in pump and fan applications
- Battery chargers, incl. DC fast chargers for e-cars

Filter application

ECOsine™ filters are best installed directly at the input of 6-pulse rectifiers. It is possible to connect several non-linear loads (e.g. motor drives) in parallel. In this case the rating of the filter must match the sum of the power ratings of drives connected to it. The use of a (built-in) DC-link choke is recommended for best harmonics mitigation performance. If the expected input power exceeds the rating of the largest available filter, and a custom solution is not desired, then two or more filters can be wired in parallel. In this mode of operation, it is recommended to use filters with equal power ratings to ensure proper current sharing.

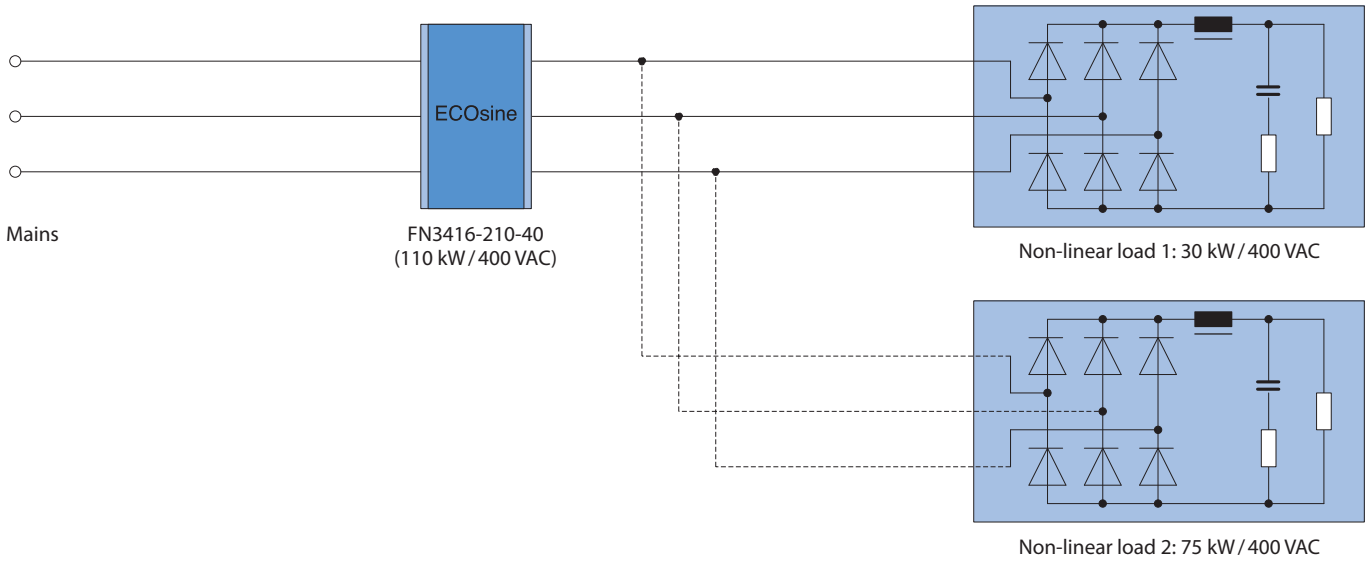

Typical filter performance

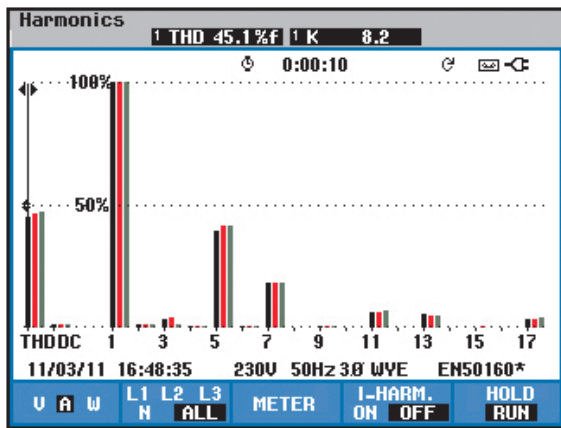

Motor drive with L_{dc} without harmonic filter

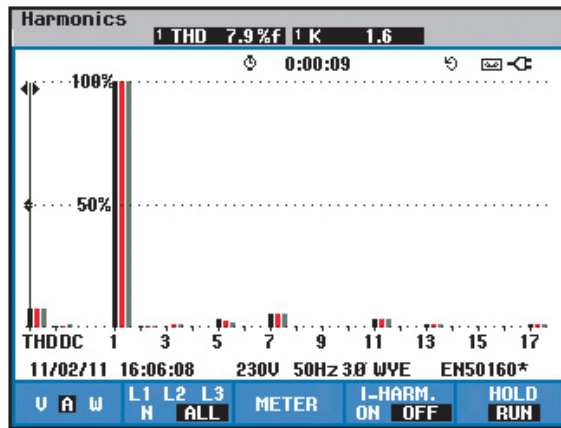

Motor drive with L_{dc} with ECOsine™ FN3416

Filter selection table FN3416

Filter*	Rated load power @ 400 VAC / 50 Hz	Rated load power @ 500 VAC / 50 Hz	Power loss** @ 25 °C / 50 Hz	Input/output connections	Weight
	[kW]	[kW]	[W]		[kg]
FN3416-10-44	4	5.5	63	-44	10
FN3416-13-44	5.5	7.5	82	-44	10
FN3416-16-44	7.5	11	105	-44	15
FN3416-24-33	11	15	153	-33	20
FN3416-32-33	15	18.5	294	-33	22
FN3416-38-33	18.5	22	256	-33	25
FN3416-45-33	22	30	306	-33	29
FN3416-60-34	30	37	408	-34	37
FN3416-75-34	37	45	410	-34	43
FN3416-90-35	45	55	493	-35	47
FN3416-110-35	55	75	546	-35	50
FN3416-150-40	75	90	784	-40	86
FN3416-180-40	90	110	817	-40	92
FN3416-210-40	110	132	887	-40	100
FN3416-260-99	132	160	947	-99	125
FN3416-320-99	160	200	988	-99	135

* Filter to be selected by system voltage and load (motor drive) power. Note: the harmonic filter will reduce RMS input current. Therefore, filter selection by current rating, as it is common for EMC/EMI filters, is not recommended.

** Calculated power loss at rated load power.

Filter selection table FN3418

Filter*	Rated load power @ 460 VAC / 60 Hz	Power loss** @ 25 °C / 60 Hz	Input/output connections	Weight
	[HP]	[W]		[kg]
FN3418-8-44	5	41	-44	10
FN3418-11-44	7.5	81	-44	10
FN3418-15-44	10	72	-44	16
FN3418-21-33	15	152	-33	20
FN3418-28-33	20	214	-33	22
FN3418-35-33	25	277	-33	25
FN3418-41-33	30	289	-33	28
FN3418-53-34	40	383	-34	38
FN3418-65-34	50	393	-34	42
FN3418-80-35	60	493	-35	45
FN3418-105-35	75	514	-35	54
FN3418-130-40	100	741	-40	78
FN3418-160-40	125	832	-40	87
FN3418-190-40	150	873	-40	100
FN3418-240-99	200	876	-99	126
FN3418-310-99	250	984	-99	135

* Filter to be selected by system voltage and load (motor drive) power. Note: the harmonic filter will reduce RMS input current. Therefore, filter selection by current rating, as it is common for EMC/EMI filters, is not suitable.

** Calculated power loss at rated load power.

Mechanical Data:

FN3416-10 to -110
FN3418-8 to -105

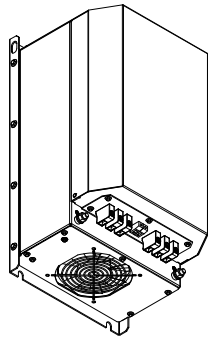
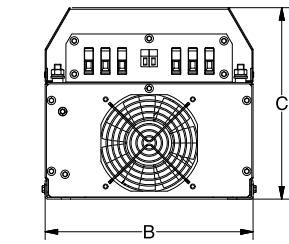

FN3416-150 to -210
FN3418-130 to -190

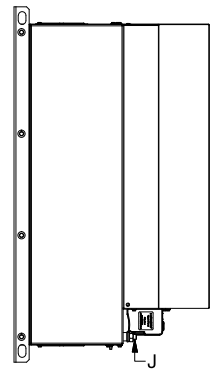
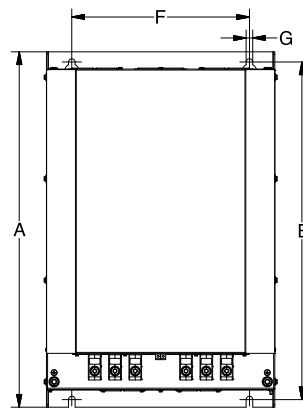
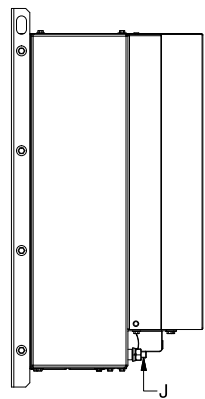
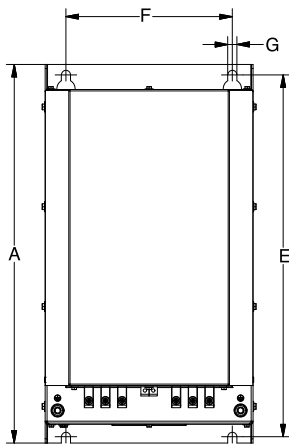
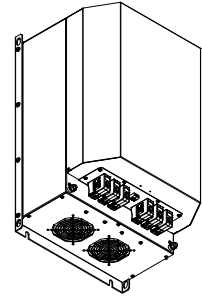
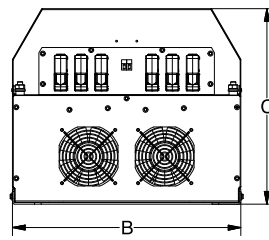

FN3416-260 to -320
FN3418-240 to -310

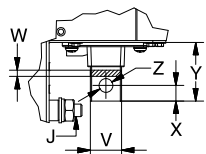
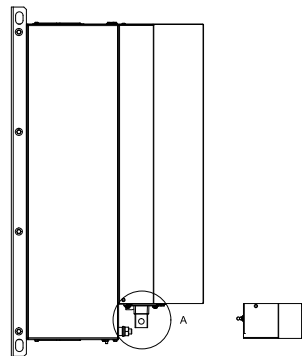
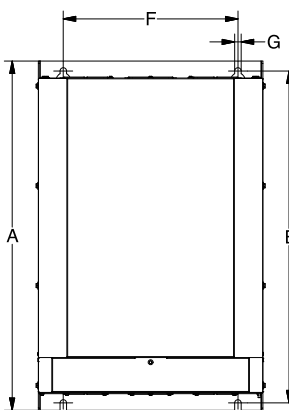
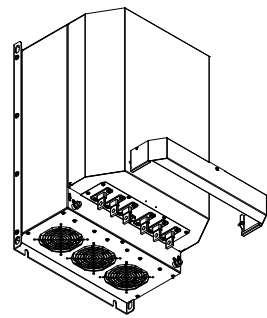
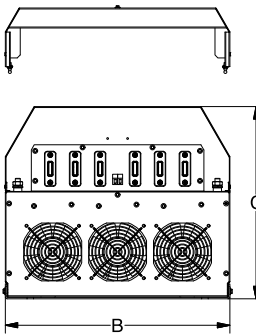





Dimensions

FN3416-...	10	13	16	24	32	38	45	60	75	90	110	150	180	210	260	320
FN3418-...	8	11	15	21	28	35	41	53	65	80	105	130	160	190	240	310
A	390	390	390	455	455	455	455	520	520	580	580	700	700	700	700	700
B	185	185	185	250	250	250	250	280	280	280	280	450	450	450	450	450
C	190	190	190	230	230	230	230	248	248	248	248	385	385	385	385	385
E	370	370	370	435	435	435	435	500	500	555	555	665	665	665	665	665
F	140	140	140	200	200	200	200	225	225	225	225	350	350	350	350	350
G	9	9	9	11	11	11	11	11	11	11	11	13	13	13	13	13
J	M6	M6	M6	M8	M8	M8	M8	M8	M8	M10	M10	M10	M10	M10	M10	M10
V																25
W																6
X																12.5
Y																47
Z																11

All dimensions in mm; 1 inch = 25.4 mm

Tolerances according to: ISO 2768-m / EN 22768-m

Filter connector cross sections

	-33	-34	-35	-40	-44
					
Solid wire	16 mm ²	35 mm ²	50 mm ²	95 mm ²	10 mm ²
Flex wire	10 mm ²	25 mm ²	50 mm ²	95 mm ²	6 mm ²
AWG type wire	AWG 6	AWG 2	AWG 1/0	AWG 4/0	AWG 8
Recommended torque	1.5–1.8 Nm	4.0–4.5 Nm	7–8 Nm	17–20 Nm	1.0–1.2 Nm

Please visit www.schaffner.com to find more details on filter connectors.

Installation

For more detailed information and step by step installation guidelines, please consult the user manual at www.schaffner.com or the installation instructions (delivered with each filter).

**Headquarters, global innovation
and development center**

Schaffner Group

Nordstrasse 11
4542 Luterbach
Schweiz
T +41 32 681 66 26
F +41 32 681 66 30
info@schaffner.com
www.schaffner.com

To find your local partner within
Schaffner's global network, please go to
www.schaffner.com

© 2012 Schaffner Group
Specifications are subject to change
within notice. The latest version of the
data sheets can be obtained from the
website. All trademarks recognized.

Schaffner is an ISO-registered company.
Its products are designed and
manufactured under the strict quality
and environmental requirements of
the ISO 9001 and ISO 14001 standards.

This document has been carefully
checked. However, Schaffner does not
assume any liability for errors or
inaccuracies.

Sales and application centers

China

Schaffner EMC Ltd. Shanghai
T20-3, No 565 Chuangye Road
Pudong New Area
Shanghai 201201
T +86 21 3813 9500
F +86 21 3813 9501 / 02
cschina@schaffner.com
www.schaffner.com

Finland

Schaffner Oy
Tynninkuja 7
08700 Lohja
T +358 19 35 72 71
F +358 19 32 66 10
finlandsales@schaffner.com

France

Schaffner EMC S.A.S.
112, Quai de Bezons
95103 Argenteuil
T +33 1 34 34 30 60
F +33 1 39 47 02 28
francesales@schaffner.com

Germany

Schaffner Deutschland GmbH
Schoemperlenstrasse 12B
76185 Karlsruhe
T +49 721 56910
F +49 721 569110
germanysales@schaffner.com

Italy

Schaffner EMC S.r.l.
Via Galileo Galilei, 47
20092 Cinisello Balsamo (MI)
T +39 02 66 04 30 45/47
F +39 02 61 23 943
italysales@schaffner.com

Japan

Schaffner EMC K.K.
Mitsui-Seimei Sangenjaya Bldg. 7F
1-32-12, Kamiuma, Setagaya-ku
Tokyo 154-0011
T +81 3 5712 3650
F +81 3 5712 3651
japansales@schaffner.com
www.schaffner.jp

Singapore

Schaffner EMC Pte Ltd.
Blk 3015A Ubi Road 1
05-09 Kampong Ubi Industrial Estate
T +65 6377 3283
F +65 6377 3281
singaporesales@schaffner.com

Spain

Schaffner EMC España
Calle Caléndula 93
Miniparc III, Edificio E
El Soto de la Moraleja
Alcobendas
28109 Madrid
T +34 618 176 133
spainsales@schaffner.com

Sweden

Schaffner EMC AB
Turebergstorg 1, 6
19147 Sollentuna
T +46 8 5792 1121 / 22
F +46 8 92 96 90
swedensales@schaffner.com

Switzerland

Schaffner EMV AG
Nordstrasse 11
4542 Luterbach
T +41 32 681 66 26
F +41 32 681 66 41
sales@schaffner.ch

Taiwan

Schaffner EMV Ltd.
6th Floor, No 413
Rui Guang Road
Neihu District
Taipei City 114
T +886 2 87525050
F +886 2 87518086
taiwansales@schaffner.com

Thailand

Schaffner EMC Co. Ltd.
Northern Region Industrial Estate
67 Moo 4 Tambon Ban Klang
Amphur Muang P.O. Box 14
Lamphun 51000
T +66 53 58 11 04
F +66 53 58 10 19
thailandsales@schaffner.com

UK

Schaffner Ltd.
5 Ashville Way
Molly Millars Lane
Wokingham
Berkshire RG41 2PL
T +44 118 9770070
F +44 118 9792969
uksales@schaffner.com
www.schaffner.uk.com

USA

Schaffner EMC Inc.
52 Mayfield Avenue
Edison, New Jersey 08837
T +1 732 225 9533
F +1 732 225 4789
usasales@schaffner.com
www.schaffner.com/us