

Energy systems

## Control system EnergyLogic Wireless control Touchline

User manual



© Roth UK Ltd.

Taunton, Somerset TA4 2 RL

Telephone: +44 (0) 19 84/62 39 82

Telephone: +44 (0) 19 84/62 39 15

E-Mail: [sales@roth-uk.com](mailto:sales@roth-uk.com)

[www.roth-uk.com](http://www.roth-uk.com)



(address sticker installer)

Revision number: C

Revision date: April 2013

## Table of Content

<b>1</b>	<b>General</b> .....	<b>7</b>
1.1	Information regarding this user manual .....	7
1.2	Explanation of symbols .....	8
1.3	Limitation of liability .....	9
1.3.1	Information in case of failure of the radio system .....	9
1.4	Copyrights .....	10
1.5	Scope of supply .....	10
1.6	Customer service .....	10
1.7	Area of application radio system .....	11
<b>2</b>	<b>Safety</b> .....	<b>12</b>
2.1	Intended use .....	12
2.2	Changes and modifications .....	12
2.3	Requirements for professionals .....	13
2.4	Safety and health hazards .....	13
2.4.1	Warning sign .....	13
2.4.2	Risk and safety .....	14
<b>3</b>	<b>Identification</b> .....	<b>15</b>
3.1	Name plate .....	15
3.2	Part numbers of product range .....	15
3.2.1	Wireless connection module .....	15
3.2.2	Wireless room thermostat .....	16
3.2.3	Accessories .....	16
<b>4</b>	<b>Design and function</b> .....	<b>17</b>
4.1	Design .....	17
4.1.1	Wireless connection module .....	17
4.1.2	Wireless room thermostat .....	18
4.2	Function .....	18
4.3	Operating and monitoring elements .....	21
4.3.1	Wireless connection module .....	21
4.3.2	Wireless room thermostat .....	23

## Table of Content

---

<b>5</b>	<b>Installation .....</b>	<b>26</b>
5.1	Wireless connection module .....	26
5.2	Wireless room thermostat.....	27
5.3	Wireless room thermostat with 230 V connection .....	30
<b>6</b>	<b>Electrical connections.....</b>	<b>32</b>
6.1	Safety.....	32
6.2	General wiring notes.....	32
6.3	Wireless connection module .....	34
6.3.1	Connection diagram .....	34
6.3.2	Electrical connections .....	34
<b>7</b>	<b>Commissioning and operation.....</b>	<b>44</b>
7.1	Addressing.....	44
7.1.1	Address one wireless room thermostat to one radio channel.....	45
7.1.2	Address one wireless room thermostats to several radio channels .....	45
7.1.3	Address several wireless room thermostats to one radio channel (sensor mode) .....	46
7.1.4	Test addressing.....	48
7.1.5	Delete addressing .....	48
7.1.6	Address up to 3 wireless connection modules to each other .....	49
7.2	Zones.....	50
7.2.1	Zone building, assign radio channels to one zone.....	51
7.2.2	Delete assignment of a radio channel or several radio channels to a zone .....	52
7.3	Change setpoints.....	53
7.3.1	Set room temperature .....	53
7.3.2	Set floor temperature .....	53
7.4	Select mode of operation .....	54
7.5	Set time and date .....	56
7.6	Time programs .....	57
7.6.1	Overview of the three time programs”.....	57
7.6.2	Definition "switched-on period" and "switching points" ..	57
7.6.3	Factory settings time program.....	58
7.6.4	Select time program .....	59
7.6.5	Change time program .....	60
7.6.6	Reset time programs to factory settings .....	63

7.7	"eco" - Indicator .....	64
7.8	Lock / unlock operation of wireless room thermostat.....	64
7.9	Reset to factory settings.....	65
7.10	Software-Update with mini SD-card .....	66
<b>8</b>	<b>Parameter descriptions .....</b>	<b>67</b>
8.1	Parameter overview .....	67
8.2	User menu.....	69
8.3	Service menu .....	72
8.3.1	Enter service menu .....	72
8.3.2	Select parameter group .....	72
8.3.3	P-20 "General parameters".....	73
8.3.4	P-30 "Parameters for all wireless room thermostats" .....	75
8.3.5	P-40 "Parameters for individual wireless room thermostats".....	78
8.3.6	P-50 "Plant- and topology related parameter" .....	82
8.3.7	P-60 "Control parameters" .....	84
<b>9</b>	<b>Cleaning and maintenance.....</b>	<b>89</b>
<b>10</b>	<b>Troubleshooting .....</b>	<b>90</b>
10.1	Wireless connection module .....	90
10.2	Wireless room thermostat .....	90
10.2.1	Procedure for ▲ Err1 or ▲ Err2 .....	92
10.2.2	Procedure when "radio signal lost" .....	92
10.2.3	Replace batteries of wireless room thermostat .....	92
10.3	FAQs .....	93
10.4	Tips and tricks .....	94
<b>11</b>	<b>Waste disposal .....</b>	<b>94</b>
<b>12</b>	<b>Accessories .....</b>	<b>95</b>
12.1	Active Antenna .....	95
12.2	Repeater.....	96
12.2.1	Assign a room thermostat to the repeater .....	97
12.2.2	Test the repeater's radio connection .....	98
12.2.3	Delete the repeater's radio connection .....	98
12.2.4	Assign the repeater to a wireless connection module .....	99
12.2.5	Test addressing of the wireless connection modules "Slave" and "Master" .....	99
12.2.6	Check repeater assignment.....	100

**Table of Content**

---

12.2.7 Repeater and radio connection to the wireless connection module .....	100
12.2.8 Deactivate LEDs at the repeater .....	100
<b>13 Technical data .....</b>	<b>101</b>
13.1 Radio system .....	101
13.2 Wireless connection module .....	101
13.2.1 Construction and dimensions .....	101
13.2.2 Electrical connections .....	102
13.2.3 Inputs .....	102
13.2.4 Outputs .....	103
13.2.5 Performance data .....	103
13.2.6 Environmental conditions .....	103
13.3 Wireless room thermostat .....	104
13.3.1 Construction and dimensions .....	104
13.3.2 Power supply – Battery .....	104
13.3.3 Power supply – 230 V AC .....	104
13.3.4 Performance data .....	105
13.3.5 Environmental conditions .....	105
<b>14 Menu structure .....</b>	<b>106</b>
<b>15 Plant examples and communication .....</b>	<b>108</b>
15.1 Plant examples with one wireless connection module .....	108
15.2 Plant examples with up to three wireless connection modules .....	111
<b>16 Reset radio system to factory settings .....</b>	<b>112</b>
<b>Index .....</b>	<b>113</b>
<b>Factory settings parameters .....</b>	<b>119</b>
<b>Factory settings time program .....</b>	<b>121</b>

# 1 General

## 1.1 Information regarding this user manual

This user manual provides important instructions with respect to the use of the Wireless Connection Module and the Wireless Room Thermostat Touchline. Compliance with all safety and installation instructions is the basis for safe working.

Read this manual carefully before the start of any work! It is a part of the product and need to be made accessible to the user at any time.

## General

---

### 1.2 Explanation of symbols

#### Warnings

In this user manual warnings are indicated by symbols. The notes are preceded by signal words that express the extent of the risks caused expression. Always comply with the instructions and act prudently to avoid accidents, and damages to people and property.

**▲ DANGER**

... points to an immediate hazardous situation, which leads to death or serious injury if not avoided.

---

---

**▲ WARNING**

... points to a possible dangerous situation that can result in death or serious injury if not avoided.

---

---

**▲ CAUTION**

... points to a possible dangerous situation that can lead to minor injuries, if not avoided.

---

---

**ATTENTION**

*... points to a possible adverse situation that can lead to property damage, if not avoided.*

---

---

#### Tips and recommendations

**NOTE**

*... highlights useful tips, information and recommendations for efficient and trouble-free operation.*

---

---



## 1.3 Limitation of liability

All information and instructions in this manual are in accordance with applicable standards and regulations, the state of art technology as well as our many years of knowledge and experience.

The manufacturer assumes no liability for damages due to:

- Failure to follow the user manual
- Improper use
- Use of untrained personnel
- Unauthorized modifications
- Technical changes.

In addition the following applies: the duties as agreed in the contract, the "General Terms and Conditions" and the "Terms of Supply" of the manufacturer and the at time of the contract applicable statutory regulations.

### 1.3.1 Information in case of failure of the radio system

The radio system is not failsafe.

The radio system is equipped with an emergency function in which the system continues to function in a reduced mode. In this emergency mode, the LED of the channel blinks and the display of the wireless room thermostat shows a warning symbol.

For the correct operation of the emergency mode following conditions must be met:

- The wireless connection module must be powered.
- The wireless connection module can not by external influences such as lightning to be destroyed.
- Thermal actuators must be connected and functional.

---

**ATTENTION****Possible damage to property due to failure of the system!**

The radio system is not failsafe. Note the points above to ensure that the system is operating properly.

---

## 1.4 Copyrights

The transfer of user manual to third parties without written permission of the manufacturer is prohibited.

**NOTE**

---

*All content, texts, drawings, pictures and other illustrations are copyrighted and are subject to intellectual property rights. Any improper exploitation is punishable.*

---

Reproduction in any shape or form - even partially - as well as the exploitation and / or notification of the content without written consent of the manufacturer is not allowed.

## 1.5 Scope of supply

**Wireless room thermostat** The scope of supply of the wireless room thermostat comprises of:

- Wireless room thermostat
- Installation material
- Battery version: 2 Batteries 1.5 V AAA
- Brief installation instructions wireless room thermostat: P100007455
- Brief installation instructions wireless room thermostat 230 V: P100008290

**Wireless connection module** The scope of supply of the wireless connection module comprises of:

- Wireless connection module
- Transformer 230 V AC / 24 V
- DIN-rail
- Brief installation instructions wireless connection module P100007749
- DVD with user manual, multi languages.

## 1.6 Customer service

For additional technical information please contact your dealer or installer. Address, see invoice, delivery note or the second page of this manual.

**NOTE**

---

*For efficient support please note the data on the name plate(s) before calling.*

---

## 1.7 Area of application radio system

NOTE

---

*The bidirectional radio system EnergyLogic Touchline with 868 MHz radio transmission is only approved for use in Europe.*

*In particular the radio system may not be used in the following countries:  
USA, Canada, Australia and Japan*

---

## 2 Safety

### 2.1 Intended use

The wireless connection module Touchline is intended solely for the comfort control of surface heating and cooling systems.

The wireless room thermostat Touchline is intended solely for the operation and configuration of the wireless connection module.

The wireless connection module and the wireless room thermostat are approved for use in households and industry.

---

**⚠ CAUTION****Risk of injury and/or property damage from improper use!**

Any non-intended use may cause personal and property damage.

- Use the wireless room thermostat and wireless connection module only for their intended use.
  - All instructions mentioned in the user manual have to be observed.
- 

Claims of any kind for damage from improper use are excluded. The responsibility for all damages from improper use lies solely with the operator.

### 2.2 Changes and modifications

Changes and modifications to the wireless connection module and wireless room thermostat can cause unexpected hazards and are therefore expressly forbidden.

## 2.3 Requirements for professionals

**▲ WARNING****Risk of injury due to insufficient qualifications!**

Improper handling can result in personal injury and property damage.

- Any activity needs to be performed by qualified persons only.

The following qualification requirements for the various activities are identified in this user manual:

- Professionals  
Because of their specialized training, knowledge, experience and knowledge of the relevant provisions, professionals are in the position to execute their assigned tasks and identify potential hazards on their own.
- Electricians  
Because of their specialized training, knowledge and experience, as well as knowledge of relevant standards and regulations, electricians are in the position to carry out work on electrical systems and identify potential hazards on their own.  
The electrician needs to observe the provisions of the local accident prevention regulation.

## 2.4 Safety and health hazards

Observe the safety instructions listed here and the warnings in subsequent chapters of this manual to reduce health hazards and avoid dangerous situations.

### 2.4.1 Warning sign

**Danger from electrical voltage!**

... identifies life-threatening situations due to electrical voltage. Failure to observe the safety instructions can result in severe injury or death. The work may be performed only by a qualified electrician.

A warning sign is located on the following components:

- Wireless connection module
- Wireless room thermostat with 230 V power connection.

## 2.4.2 Risk and safety

The following instructions should be observed to ensure your own safety and that of the devices:

**⚠ DANGER**



---

### **Danger from electrical voltage!**

Contact with live parts is an immediate danger to life.

Damage to the insulation or individual components can be life threatening.

- When insulation is damaged turn off power immediately and arrange for repair.
  - Only a qualified electrician should perform work on the electrical system.
  - Prior to any work on the system, shut off the power supply and secure against restart. Check for the absence of power!
  - Fuses should never be bridged or put out of service.
  - When changing fuses check the correct amperage specification.
  - Moisture and dust should be kept away from energized parts. Moisture or dust can cause a short circuit.
-

### 3 Identification

#### 3.1 Name plate

The name plate of the wireless connection module on the left side. The name plate of the wireless room thermostat is at the backside and on the inside of the front panel.

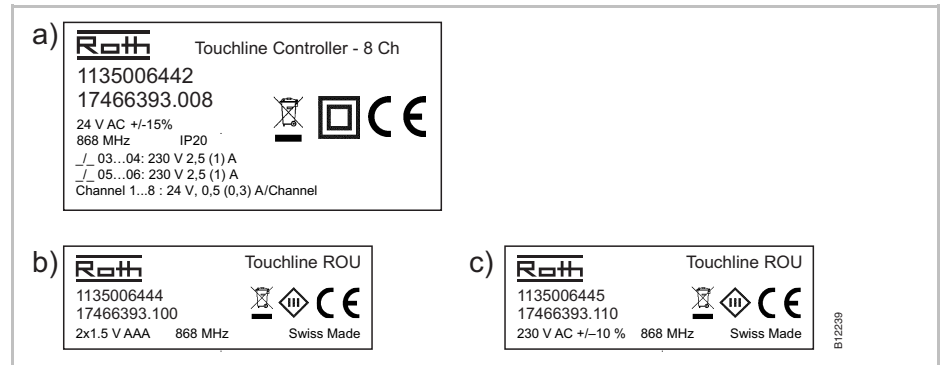

Fig. 1: Name plate a) wireless connection module, b) wireless room thermostat, c) wireless room thermostat

#### 3.2 Part numbers of product range

##### 3.2.1 Wireless connection module

Type	Material numbers					
	Europe	Nordic	Denmark	Sweden	Norway	Finland
4 Channel	1135006441	17466393.004	466393.004	2420667	8357507	2070885
8 Channel	1135006442	17466393.008	466393.008	2420668	8357508	2070886
12 Channel	1135006443	17466393.012	466393.012	2420669	8357509	2070887

Table 1: Material numbers wireless connection module

## Identification

### 3.2.2 Wireless room thermostat

Type	Material numbers					
	Europe	Nordic	Denmark	Sweden	Norway	Finland
Battery, white	1135006444	17466393.100	466393.100	2420579	8357544	2070875
230V, white	1135006445	17466393.110	466393.110	2420580	8357545	2070876
Battery, with IR Sensor, white	1135006446	17466393.120	466393.120	2420581	8357546	2070877
Battery, black	1135006447	17466393.102	466393.102	2420582	8357547	2070878
230V, black	1135006448	17466393.112	466393.112	2420583	8357548	2070879
Battery, with IR Sensor, black	1135006449	17466393.122	466393.122	2420584	8357549	2070880

Table 2: Material numbers wireless room thermostat

### 3.2.3 Accessories

Type	Material numbers					
	Europe	Nordic	Denmark	Sweden	Norway	Finland
Active antenna	1135006922	17466393.130	466393.130	2420697	8357646	2070888
Repeater	1135006921	17466393.135	466393.135	2420698	8357647	2070889

Table 3: Material numbers accessories



## 4 Design and function

### 4.1 Design

#### 4.1.1 Wireless connection module

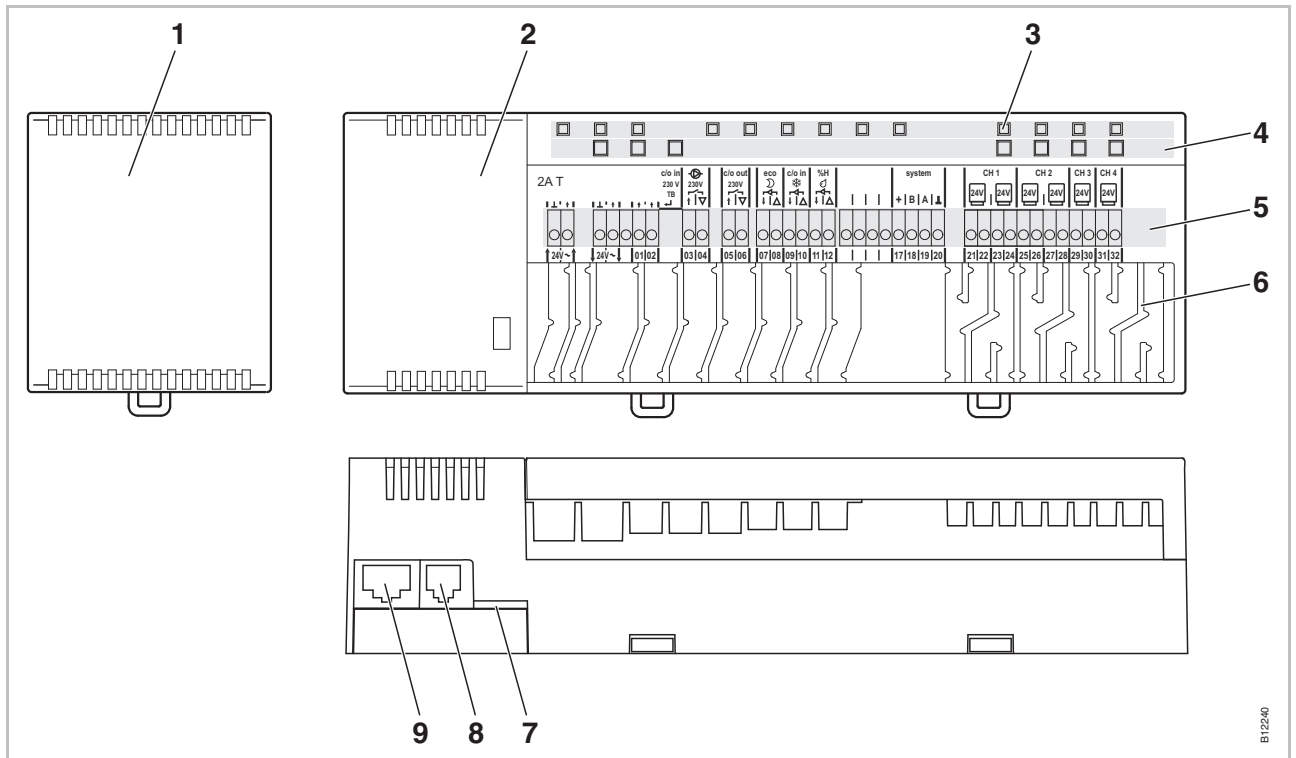

Fig. 2: Design wireless connection module, 4-channel version shown.

- |                              |                                     |
|------------------------------|-------------------------------------|
| 1 Transformer 230 / 24 V AC  | 6 Strain reliefs                    |
| 2 Wireless connection module | 7 mini SD-card for Software-Update  |
| 3 LEDs                       | 8 RJ-12 for external active antenna |
| 4 Push buttons               | 9 RJ-45 for LAN                     |
| 5 Terminals                  |                                     |

### 4.1.2 Wireless room thermostat

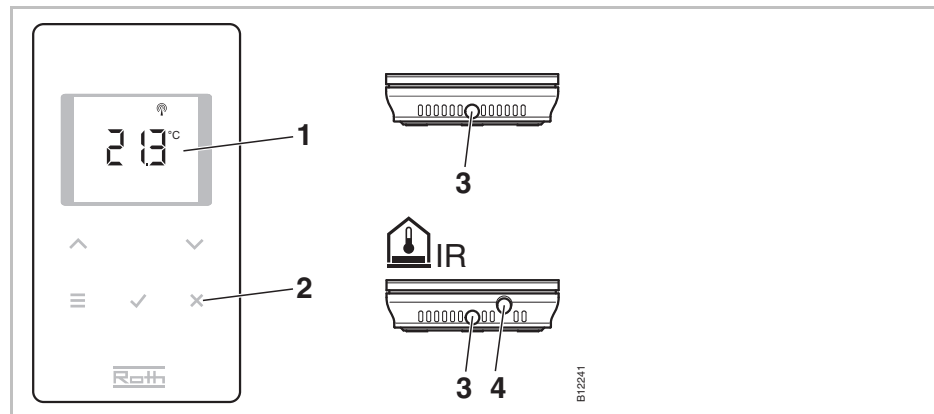

Fig. 3: Design wireless room thermostat

- 1 Display
- 2 Sensor buttons
- 3 Opening, to open the wireless room thermostat
- 4 IR-Sensor

## 4.2 Function

The bi-directional wireless connection module Touchline and the wireless room thermostat Touchline are components of a control system for comfort control of surface heating and cooling systems. The wireless connection module and the wireless room thermostat communicate securely via wireless transmission.

The wireless room thermostat measures the room temperature with an internal nickel-temperature sensor. Setpoints, mode of operation and parameters such as setpoint limits and time programs can be changed and configured with sensor buttons.

The wireless connection module equipped with short-circuit protected outputs, a stand-by mode and separate relays for the pump and burner control. The control of the actuators is either on / off control or pulse width modulation (PWM).

The system is equipped with a self-diagnostics and error display. Radio link tests can be performed easily ensuring the correct function.

There are various possibilities for addressing of the wireless room thermostats and wireless connection module. For example, it is possible to assign several wireless room thermostats to a wireless connection module and it is possible to combine to 3 wireless connection modules.

### Pump connection

The integrated pump logic with anti-blocking function provides for an appropriate control of the pump.

**Time program and energy saving mode (reduced mode)**

The optimal comfort with minimal energy consumption is guaranteed by the selection of an individual temperature profile for each day provided by the time program. In the wireless room thermostat three different time programs can be selected and customized.

The temperature setpoint should be automatically lowered by 3 K (factory settings) in reduced mode or lifted in cooling mode. The display shows the symbol  $\mathcal{D}$ .

In addition, it is possible to connect an external time switch to the input "Eco (N/R)". The signal of this time switch reduces the setpoint of the wireless room thermostats also by 3 K or more when active.

**Cooling**

Cooling can be activated through an external signal from e.g. a heat pump or an external switch. For this function two inputs are available: "C/O" and the "hot" input "24 ... 230 V TB/C/O". In addition it is possible to provide a signal to a cooling unit with the potential free output C/O.

Depending on the configuration of the wireless room thermostat, the cooling mode can be activated with the wireless room thermostat with master function, or with any wireless room thermostat.

**Anti-blocking function for pump and valves**

To prevent blocking of the pump and valves, once per week the anti-blocking function is activated. The function is started when one of the outputs was not active for a week. In this anti-blocking function, the pump is turned on for 3 minutes. The actuators are controlled per channel and will be switched on for 20 minutes. The pump and the actuators run independently without warning.

**Emergency mode**

When the radio signal between the wireless room thermostat and the wireless connection module is lost for more than 30 minutes, then the addressed channels switch over into emergency mode. During the emergency mode the thermal actuators are in a 30%-on / 70%-off mode of the standard time. The standard time is determined by the selected control algorithm. The channel LED(s) is (are) blinking. A warning symbol is shown on the display of the wireless room thermostat indicating that the emergency function is active. For a proper functioning of the emergency mode the wireless connection module must be provided with power not be destroyed by external influences such as a lightning strike.

**Temperature control**

The wireless room thermostat measures the room temperature. The temperature setpoint is specified via the wireless room thermostat. Every 10 minutes the measured room temperature setpoint and the actual temperature are transmitted to the wireless connection module. After a change of the setpoint the new setpoint and the actual value are sent immediately to the wireless connection module.

For an efficient temperature control, three different control algorithms and an optimized thermal actuator control are available. For the temperature control one can select between one on/off and two PWM control algorithms.

With the on / off control the heating will be switched on or off when the temperature difference is greater than 0.5 K. If the setpoint is higher than the measured temperature, the valves are opened. If the setpoint is lower than the measured temperature, the valves are closed.

## Design and function

---

During PWM control, the opening and closing time of the valves is calculated from the temperature difference between the setpoint and the actual value. The higher this difference, the higher the opening or the closing time.

The optimized actuator control is a specially developed control for thermal actuators to save energy. At start, the thermal actuator becomes a constant signal for a defined period. Then, the actuator is controlled with a pulse-/pause-signal, so less energy is needed.

Each channel has its own control loop. If a wireless room thermostat is addressed to multiple radio channels, then radio channels are grouped in one control loop.

### **Temperature control with IR Floor temperature Sensor**

The wireless room thermostat with integrated IR floor temperature sensor measures the room temperature and the floor temperature.

The heating goes on when the set floor temperature or room temperature is undercut. The set value for the minimum or maximum floor temperature has highest priority at all times.

The floor temperature measurement ensures that a comfortable floor temperature is retained.

## 4.3 Operating and monitoring elements

### 4.3.1 Wireless connection module

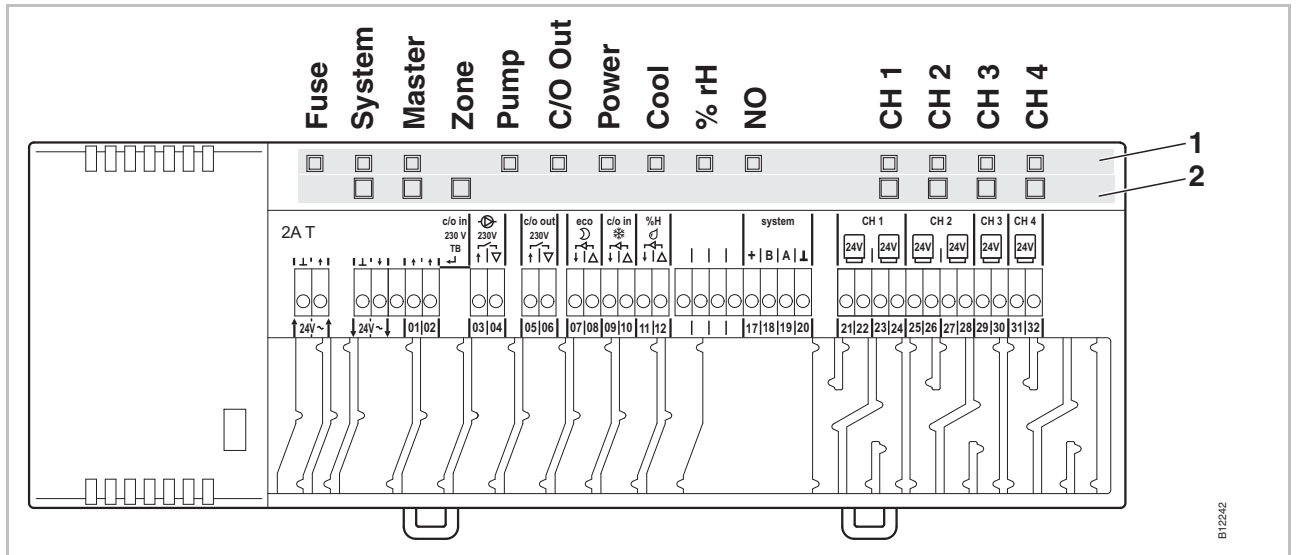

Fig. 4: Overview wireless connection module: push buttons and LEDs

- 1 LEDs
- 2 Push buttons

#### Push buttons

Push buttons	Description
System	Several (up to 3) wireless connection modules combined into one system. In addition, also I / O boxes and outdoor temperature sensors can be integrated into one system.
Master	Define a wireless connection module as master in a system with multiple wireless connection modules. Each system must have one master. As factory settings, the wireless connection modules are configured as slaves. → See also page 49, chapter 7.1.6.
Zone	Combine multiple radio channels in one zone up to a maximum of three zones.
Channels	<ul style="list-style-type: none"> <li>• Address wireless room thermostat and wireless connection module.</li> <li>• Delete addressing.</li> </ul>

Table 4: Push buttons wireless connection module

## Design and function

### LEDs

LEDs	Description
Fuse: Red LED	<ul style="list-style-type: none"> <li>On: Fuse 2 A T of power supply defect</li> </ul>
System: Yellow LED	<ul style="list-style-type: none"> <li>On: communication between two or three wireless connection modules</li> </ul>
Master: Green LED	<ul style="list-style-type: none"> <li>On: wireless connection module is configured as master</li> <li>Off: wireless connection module is configured as slave</li> </ul>
Zone, LED Power (blinking simultaneously)	<ul style="list-style-type: none"> <li>Blue (Cool): Zone 1</li> <li>Red (% rH): Zone 2</li> <li>Yellow (NO): Zone 3</li> </ul>
Pump: Green LED	<ul style="list-style-type: none"> <li>On: Pump on</li> <li>Off: Pump off</li> </ul>
C/O Out: Green LED	<p>The function of the LED "C/O Out" is depending on the settings of parameters P-51. → See also parameter description, page 82.</p> <ul style="list-style-type: none"> <li>Function "Burner" active: On: heating demand</li> <li>Function "C/O" active: On: cooling demand</li> </ul>
Power: Green LED	<ul style="list-style-type: none"> <li>On: power supply on</li> <li>Off: power supply off</li> </ul>
Cool: Blue LED	<ul style="list-style-type: none"> <li>On: C/O-input contact closed (cooling mode active)</li> <li>On: TB-C/O 24...230V input active (as C/O-input configured)</li> <li>On: switch over heating/cooling by wireless room thermostat (C/O-Output active)</li> <li>Off: wireless connection module in heating mode</li> </ul>
% rH: Red LED	<ul style="list-style-type: none"> <li>On: Dew-point active only in cooling mode</li> <li>Blinking: TB active in heating or cooling mode</li> </ul>
NO: Yellow LED	<ul style="list-style-type: none"> <li>On: Actuator NO (normally open)</li> <li>Off: Actuator NC (normally closed)</li> </ul>
CH 1...CH 12: Green LEDs	<ul style="list-style-type: none"> <li>On: Addressing completed and output active</li> <li>Blinking: ready for addressing</li> <li>Blinking, followed by rapidly blinking: warning before deleting, respectively deleting</li> <li>Blinking fast: channel in emergency mode</li> </ul> <p>The number of channels (CH) depends on the version.</p>

Table 5: LEDs wireless connection module

### 4.3.2 Wireless room thermostat

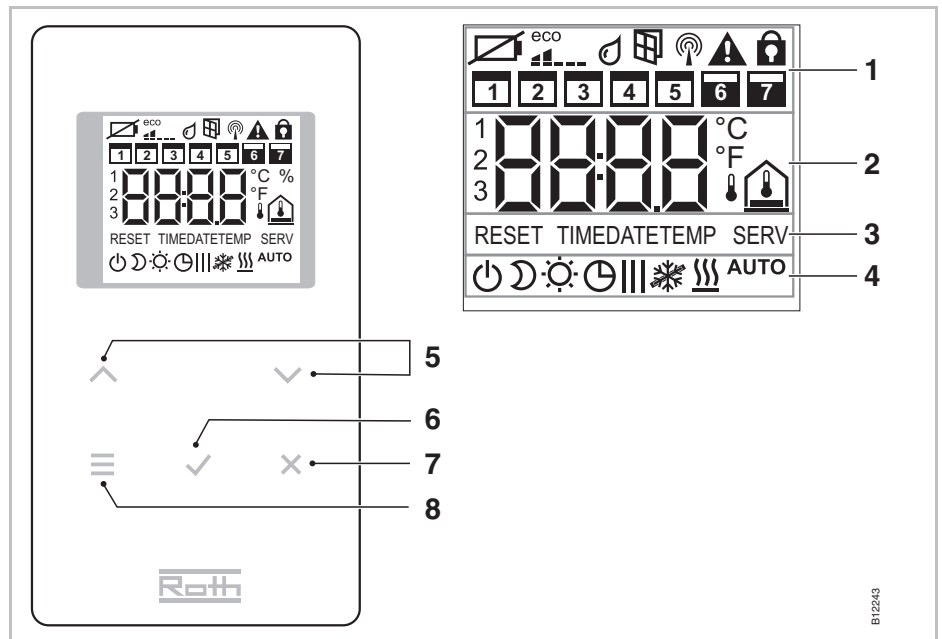

Fig. 5: Overview display and sensor buttons wireless room thermostat

- 1 General information such as battery status, energy saving mode, alarms for window contact and dew point, wireless connection, general alarm, key lock, weekdays for time programs
- 2 Temperature setpoint and actual value, time, time program, outdoor and floor temperature
- 3 Help text for configuration
- 4 Modes of operation
- 5 Select setpoints, time and date and other values change, time programs
- 6 Confirm changed value, confirm selection
- 7 Cancel: exit current parameter or menu
- 8 Select mode of operation, activate menu mode, select parameter

#### Sensor buttons

Sensor buttons	Description
2 s: 	Activate operation with any button.
	Menu button: <ul style="list-style-type: none"> <li>• Activate menu mode.</li> <li>• Select mode of operation. Possible modes of operation: frost protection (off), reduced, normal, time program, heating or cooling.</li> <li>• Select parameter (menu mode).</li> </ul>
	Change value.
	<ul style="list-style-type: none"> <li>• Save value</li> <li>• Confirm selection.</li> </ul>

## Design and function









Sensor buttons	Description
10 s: 	Change time and date.
	Cancel
5 s:  + 	<ul style="list-style-type: none"> <li>Addressing</li> <li>Test addressing.</li> </ul>
5 s:  + 	Disable/enable operation (key-lock)
10 s:  + 	Activate/deactivate sensor mode

Table 6: Sensor buttons wireless room thermostat

## Symbols























Symbols	Description
	Battery nearly empty
	Relative energy consumption
	Dew-point alarm (only when dew-point sensor is connected)
	Window contact (only with accessory)
	Wireless signal
	Loss of wireless connection
	General alarm
	Operation disabled
	Working days
	Weekend
	<ul style="list-style-type: none"> <li>Time and date</li> <li>Time program</li> </ul>
	Actual temperature
	Room temperature
	Floor temperature (only IR-version)
	Outdoor temperature (only with accessory)
	Off (frost protection)
	Reduced operation
	Normal operation
	Time program with external clock
	Time program 1, 2 and 3
	Cooling mode
	Cooling lock
	Heating mode
AUTO	Auto mode: heating and cooling mode controlled by wireless connection module.



Table 7: Symbols wireless room thermostat

**Display modes**

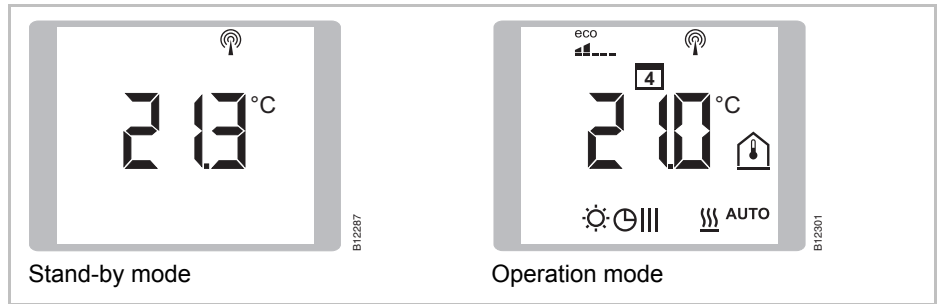

Fig. 6: Display modes wireless room thermostat

## 5 Installation

### 5.1 Wireless connection module

→ Information on dimensions, see page 101, chapter 13.3.1.

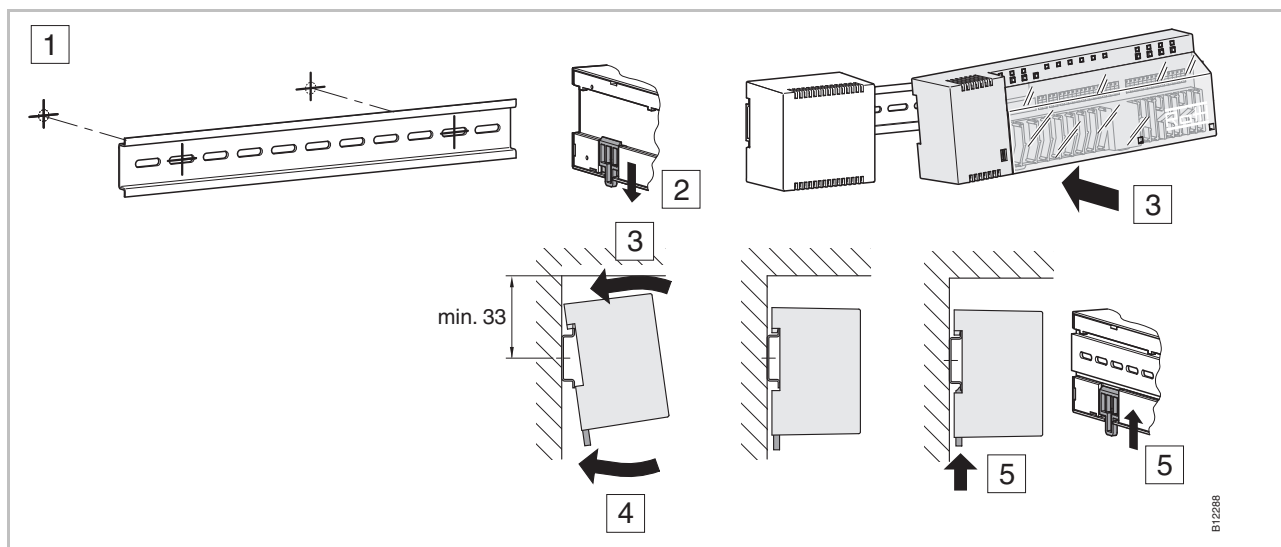

Fig. 7: Installation wireless connection module

**NOTE**

If LAN communication over PowerLAN is planned, then a double socket should be provided for the connections of the wireless connection module and the PowerLAN.

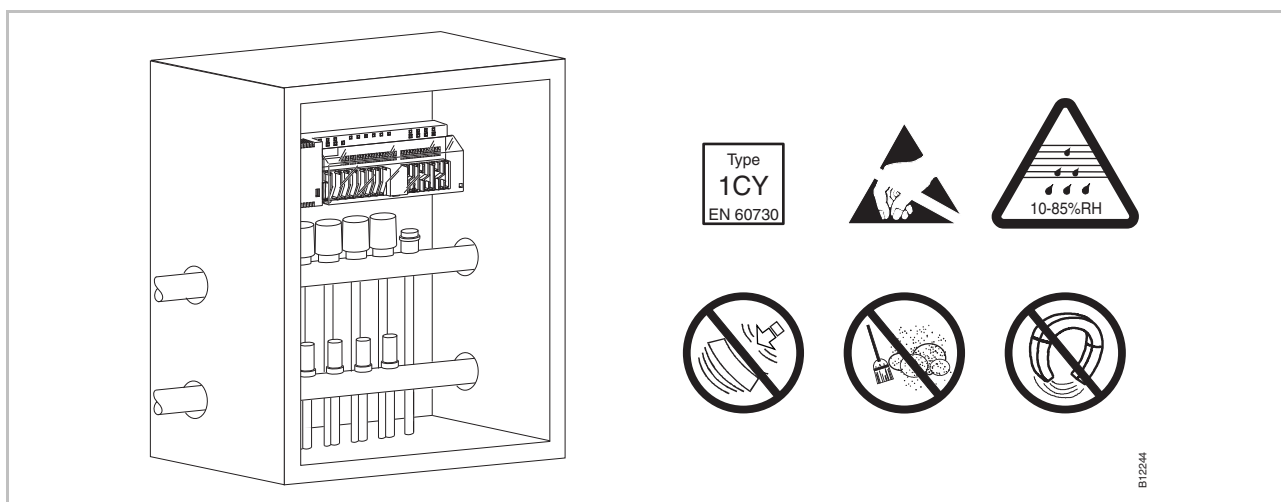

Fig. 8: Wireless connection module in distribution box

## 5.2 Wireless room thermostat

→ Information on dimensions, see page 104, chapter 13.3.1.

### Conditions for place of installation

The place of installation for the wireless room thermostat must meet the following conditions:

- Interior wall
- Not in direct sunlight
- Not directly beside the entrance door
- Away from sources of moisture
- Away from splashing water
- Away from heat sources such as fireplaces, heaters, televisions or other electronic devices.

### Installation instruction

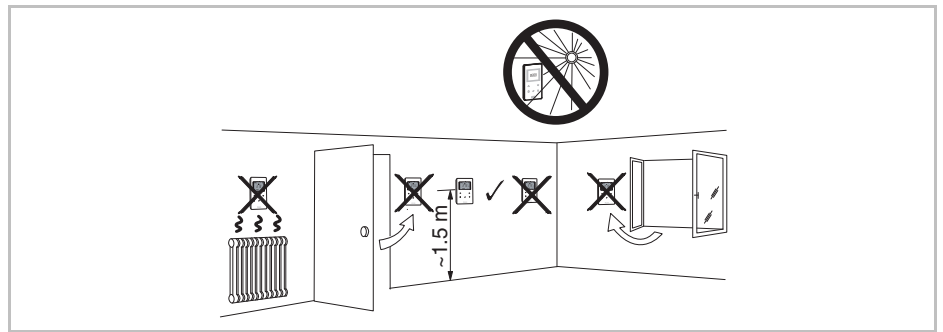

Fig. 9: Installation instruction

### Wireless room thermostat with IR sensor

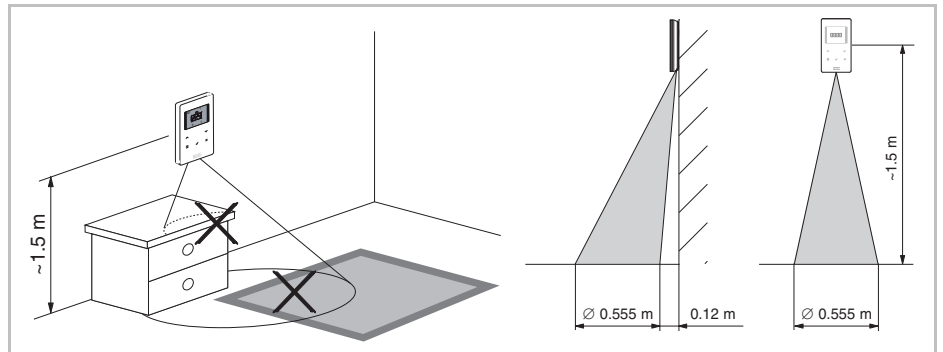

Fig. 10: Area of influence of IR sensor

### Open wireless room thermostat

- ▶ Hold the cover of the wireless room thermostat with one hand.
- ▶ Open the cover by applying a 5 mm Phillips-tip screwdriver in the hole.
- ▶ Remove the cover.

## Installation

**ATTENTION**

**Damage due to improper opening!**

- Please hold the cover tight while opening the wireless room thermostat.
- Use the correct hole for opening the wireless room thermostat with IR sensor as shown below.

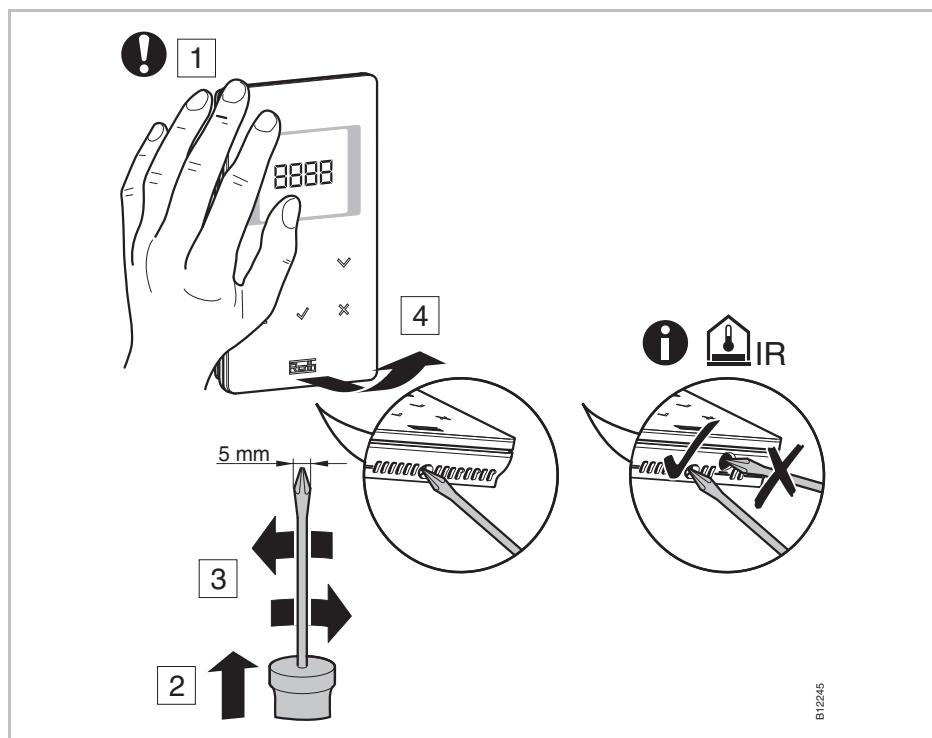

Fig. 11: Open the wireless room thermostat

**Install bottom part**

- ▶ Install the bottom part of the wireless room thermostat with the 2 included screws and plugs.

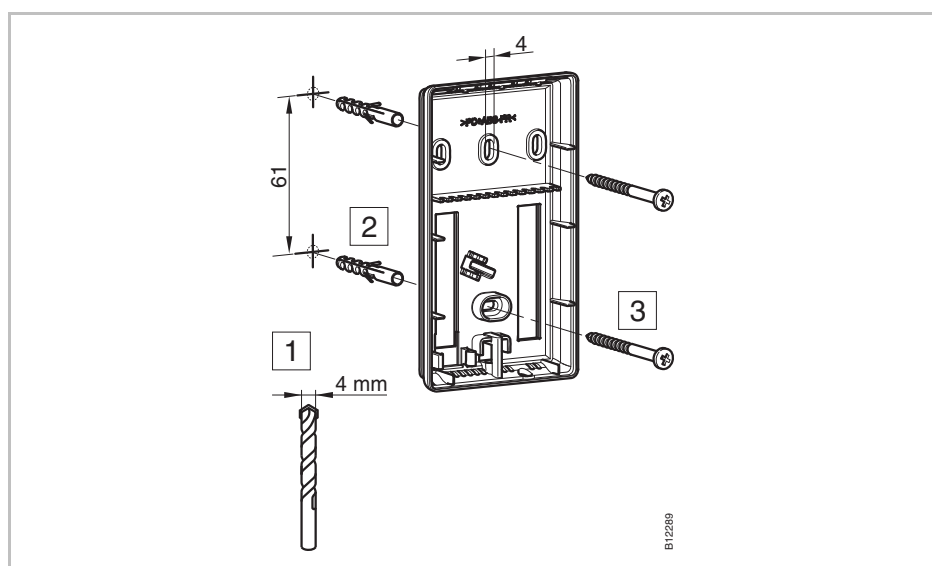

Fig. 12: Installation bottom part of wireless room thermostat

**Insert batteries**

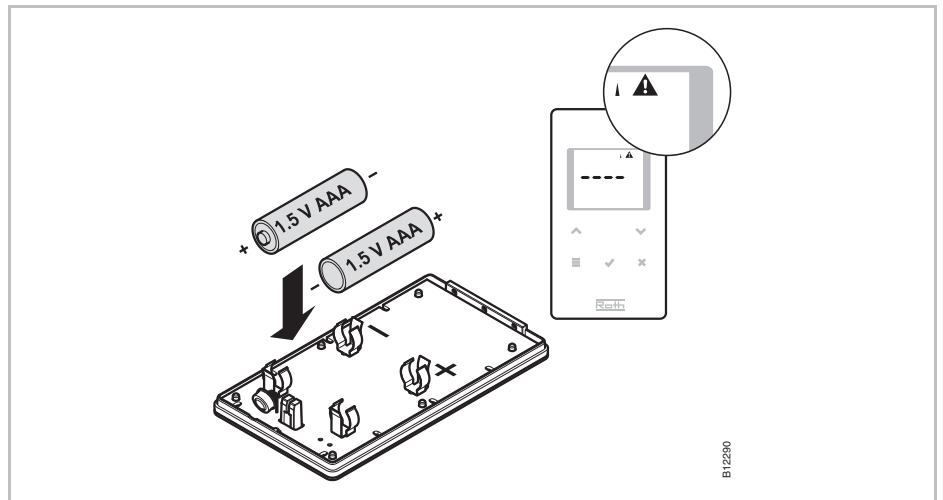

Fig. 13: Insert batteries

**ATTENTION**

**Possible malfunction of the sensor buttons!**

After inserting the batteries the sensor buttons are automatically calibrated on the surface.

- Do not touch the sensor buttons when inserting the batteries.
- If a sensor button does not work, remove the battery and insert it again.

**Close wireless room thermostat**

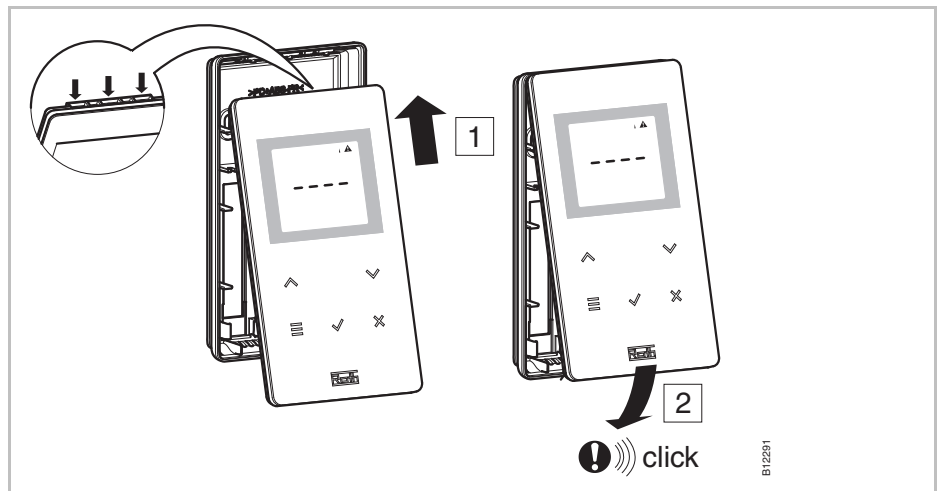

Fig. 14: Close the wireless room thermostat

### 5.3 Wireless room thermostat with 230 V connection

**⚠ DANGER**



#### Danger from electrical voltage!

Contact with live parts is an immediate danger to life.

Damage to the insulation or individual components can be life threatening.

- When insulation is damaged turn off power immediately and arrange for repair.
- Only a qualified electrician should perform work on the electrical system.
- Prior to any work on the system, shut off the power supply and secure against restart. Check for the absence of power!
- Fuses should never be bridged or put out of service.
- When changing fuses check the correct amperage specification.
- Moisture and dust should be kept away from energized parts. Moisture or dust can cause a short circuit.

► Open the cover of the wireless room thermostat. → See page 28.

► Install the bottom part of the wireless room thermostat with the 2 included screws and plugs.

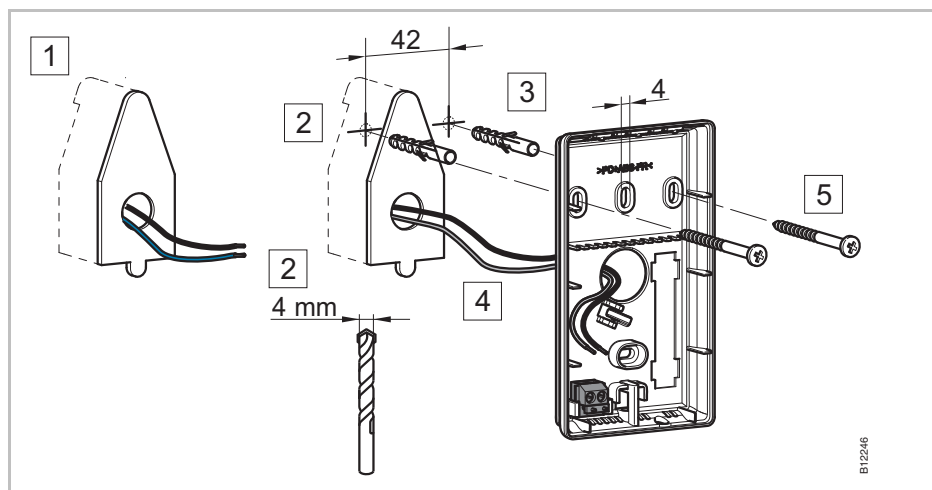

Fig. 15: Installation bottom part of wireless room thermostat

- ▶ Connect the wireless room thermostat.

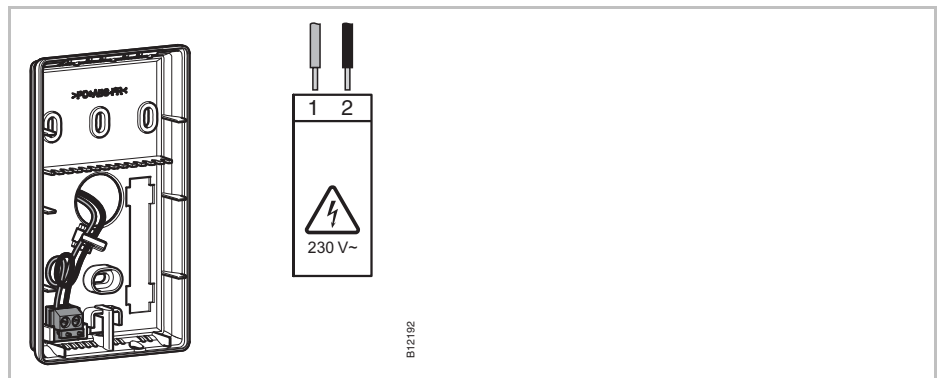

Fig. 16: Close the wireless room thermostat

- ▶ Close the cover of the wireless room thermostat. → See page 29.

## 6 Electrical connections

### 6.1 Safety

**▲ DANGER**



---

#### **Danger from electrical voltage!**

Contact with live parts is an immediate danger to life.

Damage to the insulation or individual components can be life threatening.

- When insulation is damaged turn off power immediately and arrange for repair.
  - Only a qualified electrician should perform work on the electrical system.
  - Prior to any work on the system, shut off the power supply and secure against restart. Check for the absence of power!
  - Fuses should never be bridged or put out of service.
  - When changing fuses check the correct amperage specification.
  - Moisture and dust should be kept away from energized parts. Moisture or dust can cause a short circuit.
- 

### 6.2 General wiring notes

**▲ DANGER**



---

#### **Danger from electric shock!**

Improper wiring may be potentially fatal.

- Perform wiring according to connection chart.
  - Insert wires into the terminals completely to the stop.
  - Only use the prescribed core cross-sections.
  - Observe the prescribed dimensions for stripping.
  - If wire-end ferrules with plastic collar are used, observe the prescribed dimensions for plastic collars.
  - Do not use twin wire-end ferrules.
-



**Fine-wire conductor**

Fine-wire conductors must only be used with wire-end ferrules.

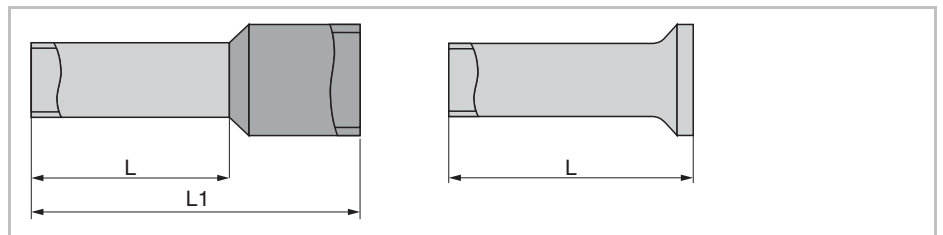

Fig. 17: Left: Wire-end ferrules with plastic collar  
right: Wire-end ferrules without plastic collar

Strand cross-section [mm <sup>2</sup> ]	L [mm]	L1 [mm]
0.25 to 0.34	6 to 8	10.5 to 12.5
0.5	6 to 8	11.5 to 13.5
0.75	6 to 8	12 to 14
1	8	14

Table 8: Dimensions for fine-wire conductors, wire-end ferrules with plastic collar

Strand cross-section [mm <sup>2</sup> ]	L [mm]
0.25 to 0.34	5 to 7
0.5	6 to 8
0.75	6 to 8
1	6 to 8
1.5	6 to 8

Table 9: Dimensions for fine-wire conductors, wire-end ferrules without plastic collar

**Single-wire or multi-wire conductors**

Single-wire or multi-wire conductors must not be used without wire-end ferrules.

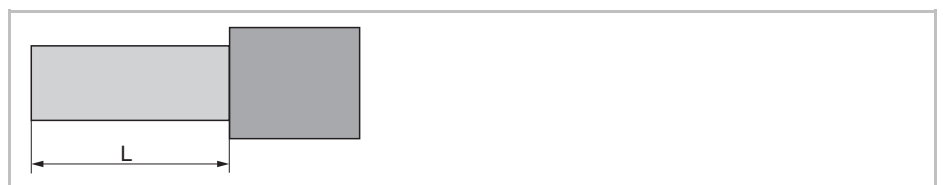

Fig. 18: Single-wire or multi-wire conductors

Strand cross-section [mm <sup>2</sup> ]	L [mm]
0.5 to 1.5	8 to 9

Table 10: Dimensions for single-wire or multi-wire conductors

## Electrical connections

### 6.3 Wireless connection module

#### 6.3.1 Connection diagram

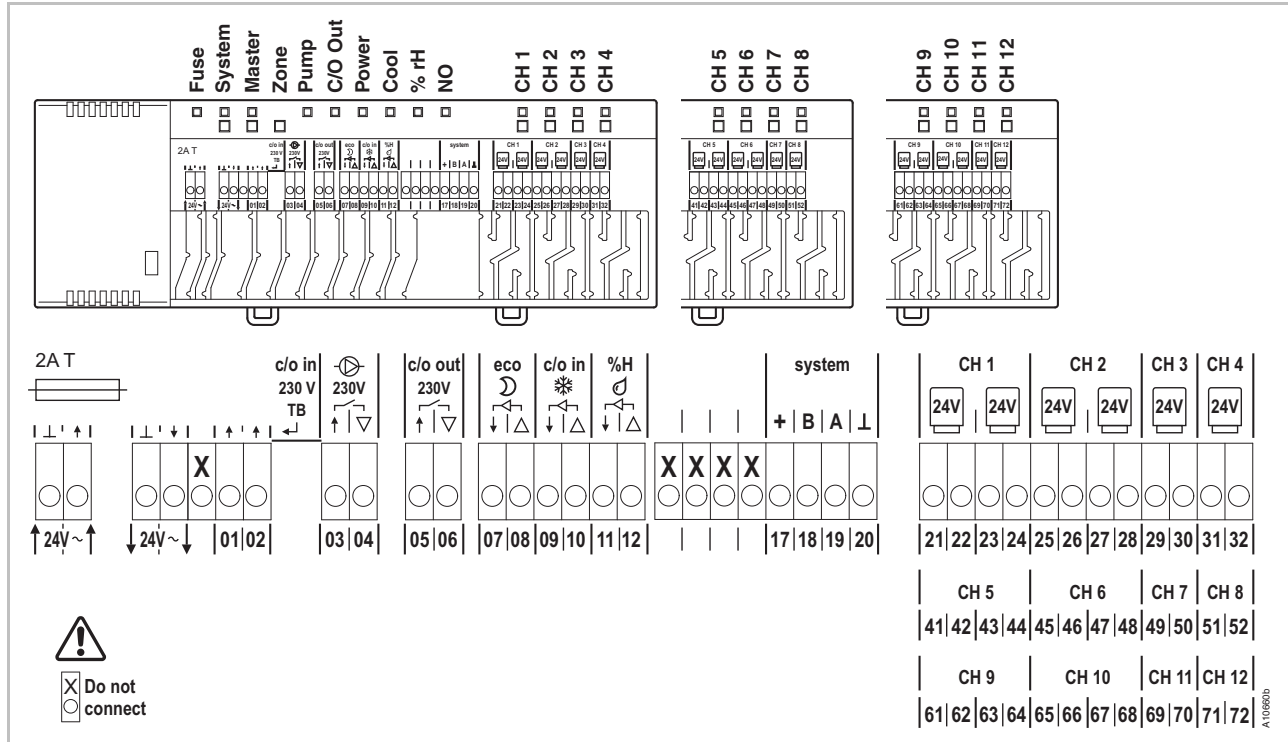

Fig. 19: Connection diagram

#### 6.3.2 Electrical connections

**Remove cover** ► Remove the cover as shown below.

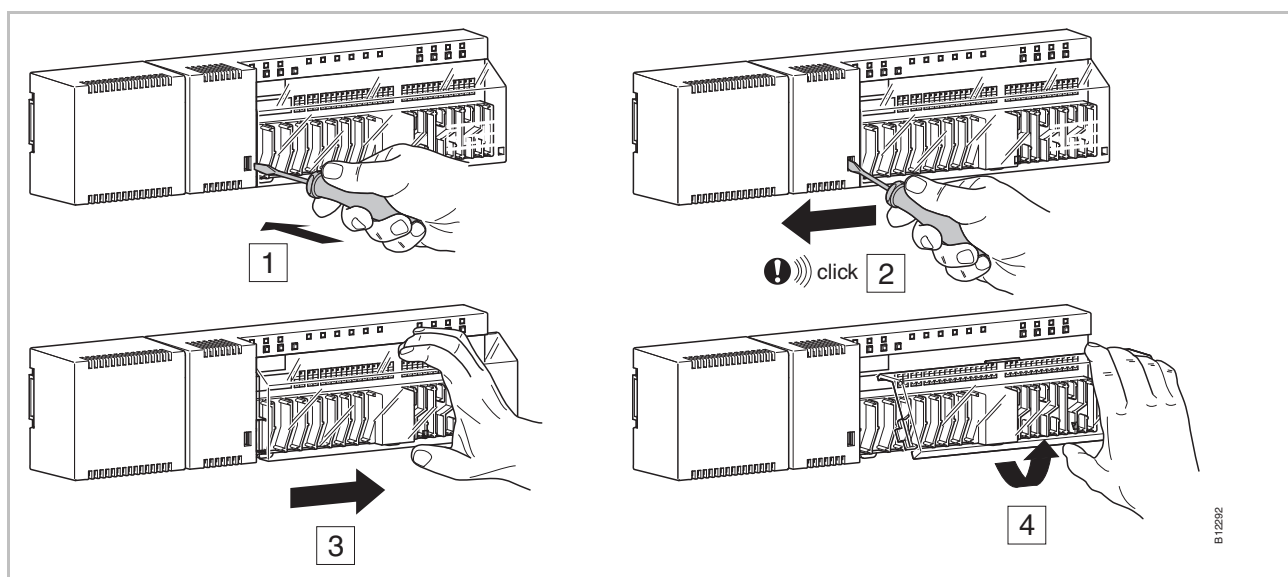

Fig. 20: Remove cover

### Connect wires

**⚠ DANGER**



#### Danger from electrical voltage on terminals 1 to 6!

Contact with live parts is an immediate danger to life

- Shut off the power supply and secure against restart. Check for the absence of power!

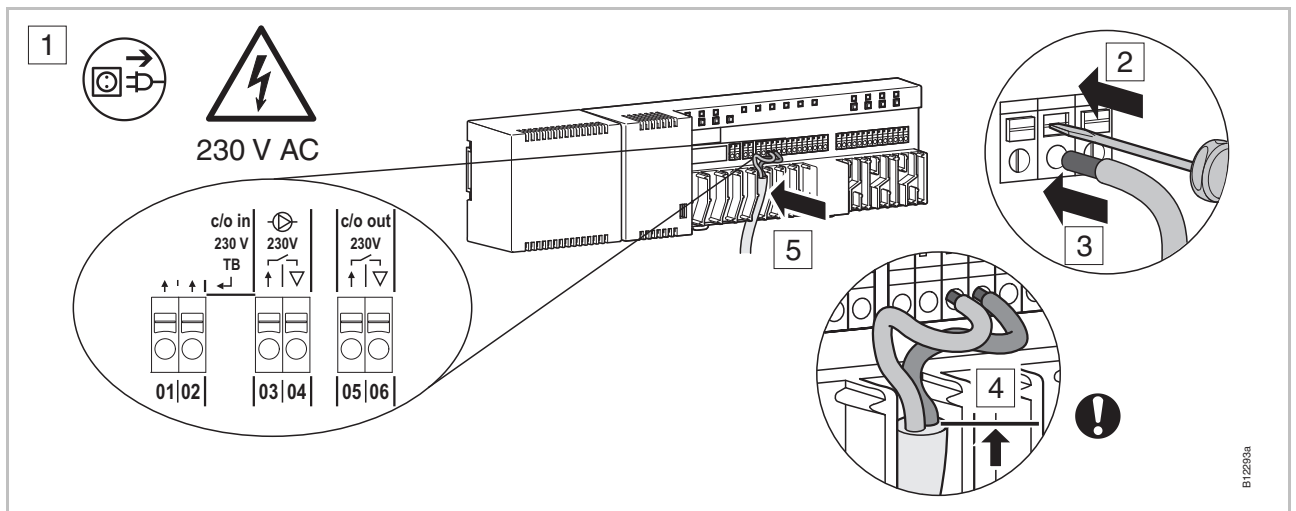

Fig. 21: Connect wires

### Connect wires

- ▶ Press down the terminal pin with a screwdriver. See step 2.
- ▶ At the same time put the wire into the terminal opening. See step 3.
- ▶ Press the cable into the matching strain relief. See step 5. Observe that the line jacket should be as close as possible to the connection terminal. This keeps the individual conductors well in their position. See step 4. This must be performed specifically at the following terminals for the 230 V-lines:
  - **01 and 02:** c/o in 230 V TB
  - **03 and 04:** pump out 230 V
  - **05 and 06:** c/o out 230 V

## Electrical connections

### Connect transformer

► Connect the transformer to the 24 V input terminals.

**ATTENTION**

**Malfunctioning due to improper connection!**

Improper connection may cause malfunction of the system.

- Each wireless connection module must have a separate transformer.



Abb. 22: Connect transformer

**NOTE**

The 24 V output is used only as support voltage for a dew-point sensor or as a voltage signal to the TB input (temperature limit).

- Connect thermal actuators** ▶ Connect the thermal actuators to the following terminals:
- 4-channel version: terminals **21** to **32** for max. 6 actuators
  - 8-channel version: terminals **21** to **52** for max. 12 actuators
  - 12-channel version: terminals **21** to **72** for max. 18 actuators

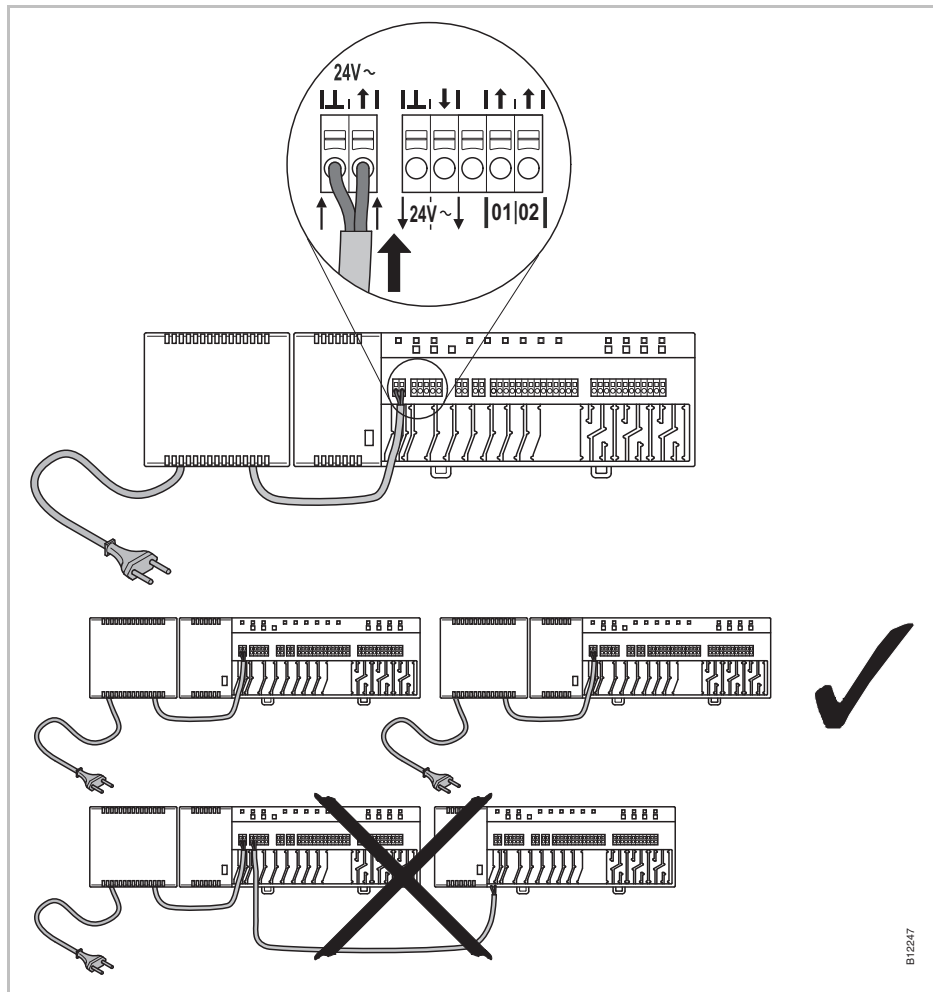
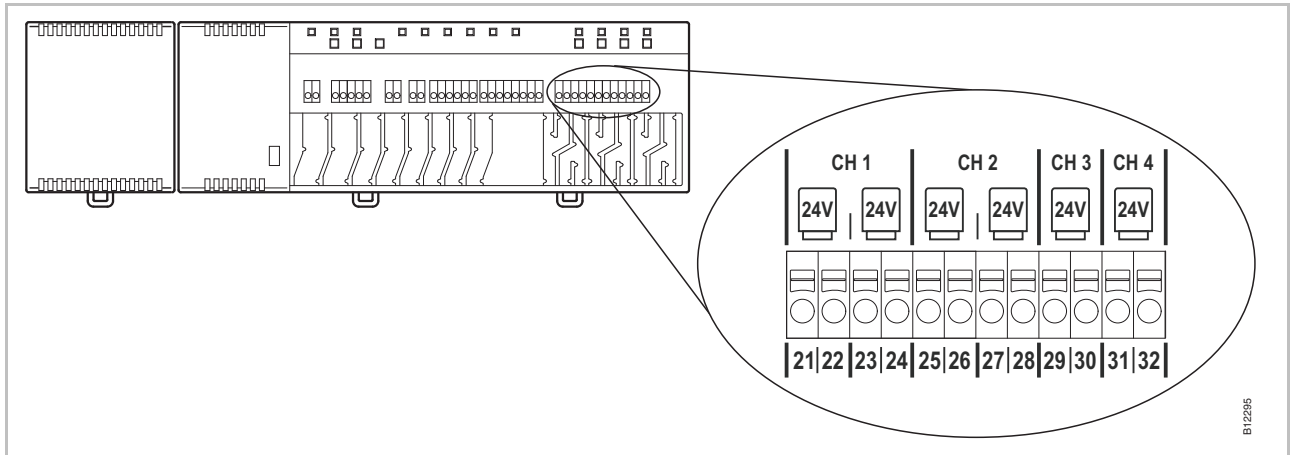

Fig. 23: Connect thermal actuators

- Connect 230 V pump** ▶ Connect the pump to terminal **04** and an external neutral conductor (N).
- ▶ Connect an external phase (L) to the terminal **03**.
- Contact rating: 230 V, 2.5 A, 1 A inductive switchable.

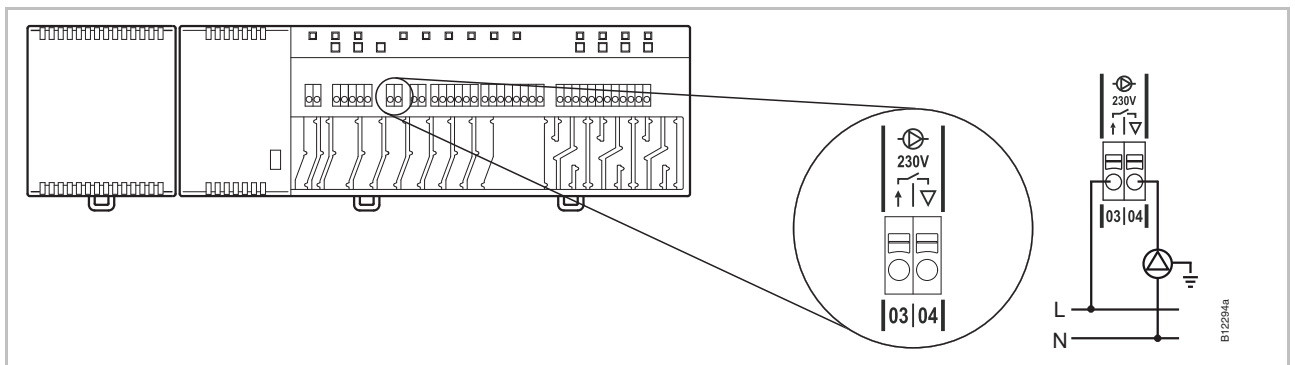

Fig. 24: Connect pump, 230 V

## Electrical connections

### C/O, TB-input for activation cooling mode

The TB input is a configurable input for a C / O-signal of 24 V or 230 V to switch from heating to cooling mode.

- ▶ Connect the C/O-Signal to terminals **01** and **02**.

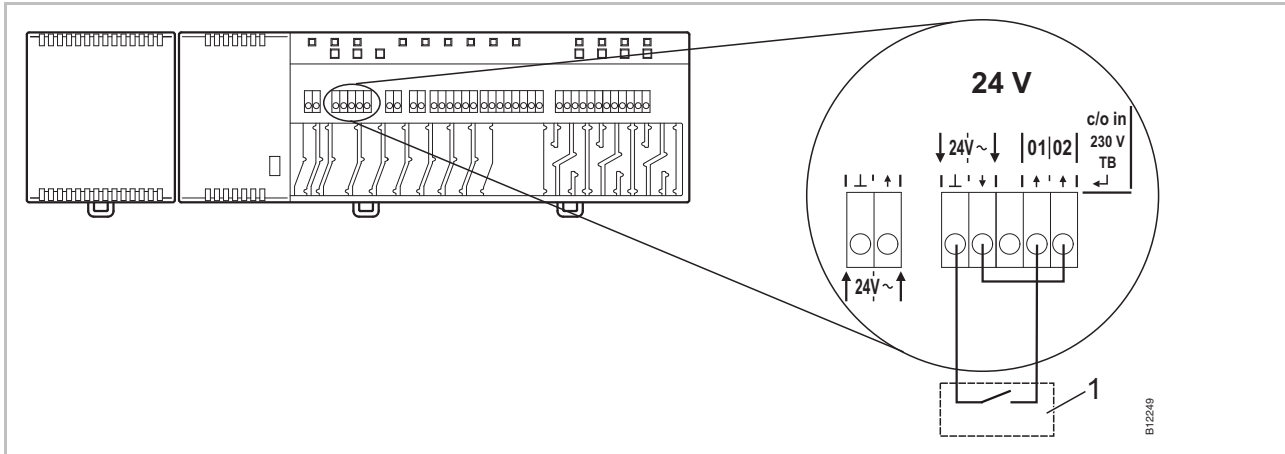

Fig. 25: TB-input, control with 24 V voltage from wireless connection module

Terminal 01 Voltage ON: cooling ON  
Voltage OFF: cooling OFF

1 e.g. heat pump

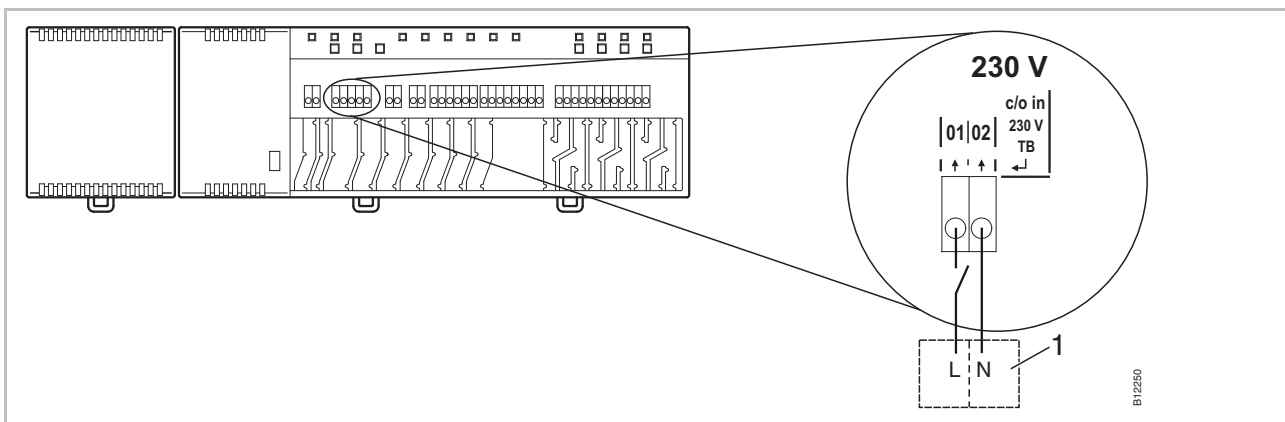

Fig. 26: TB-input, control with 230 V

Terminal 01 Voltage ON: cooling ON  
Voltage OFF: cooling OFF

1 e.g. Roth heat pump Terra Compact

**ATTENTION**

**Do not interchange the connection to terminals 01 (L) and 02 (N)!**

Improper connection may cause malfunctioning of the system.

- Connect the phase and neutral wires correctly. Phase (L) to terminal **01** and neutral (N) to terminal **02**.

**TB-input for temperature monitoring**

The TB-input can be used for temperature monitoring by an external maximum temperature limiter.

- ▶ Connect the signal of the external temperature limiter to terminals **01** and **02**.

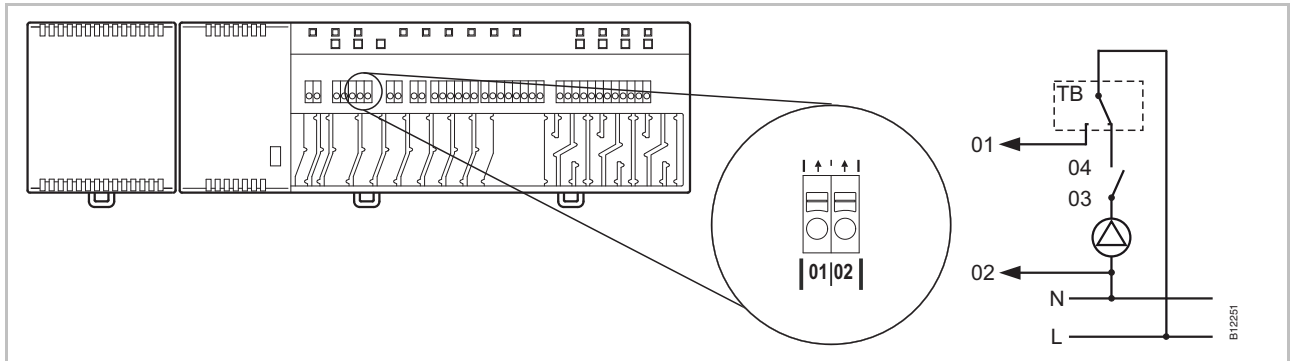

Fig. 27: TB-input for temperature monitoring

Voltage on terminal 01    ON: all valves closed  
                                   OFF: all valves are controlled by demand.

**ATTENTION**
**Limitation of liability for safety function!**

The safety function of the maximum floor temperature is provided by the separate, external temperature limiter by switching the pump off. The signal on terminal 01 triggers the additional closure of all valves; however, this does **NOT** replace the security function.

- Use only an approved temperature limiter
- Use the information regarding the maximum allowed water supply temperature provided by the manufacturers of the floor respectively the floor covering.

## Electrical connections

### C/O- or burner output, potential free contact

The output "c/o out" is a configurable output for cooling (C/O: Change-Over) or burner start.

- ▶ Attach a refrigeration unit or a burner on the terminals **05** and **06**. The radio system must be configured for either application.
- ▶ Contact rating: 230 V, 2.5 A, 1 A inductive switchable.

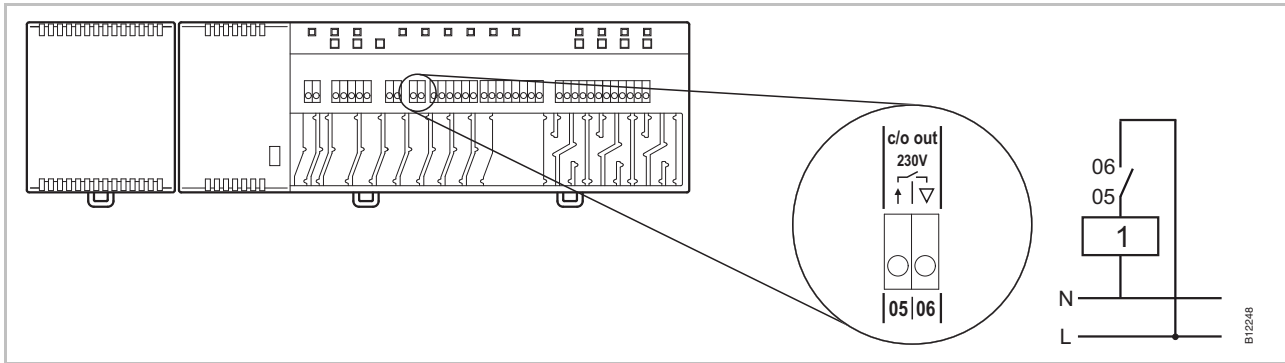

Fig. 28: C/O- or burner output, 230 V

Contact 05 / 06 closed: cooling or burner start ON  
 open: cooling or burner start OFF

1 Cooling device or burner

### Eco-input, for reduced mode with contact recognition

- ▶ Connect the contact of an external clock or modem to terminals **07** and **08**.

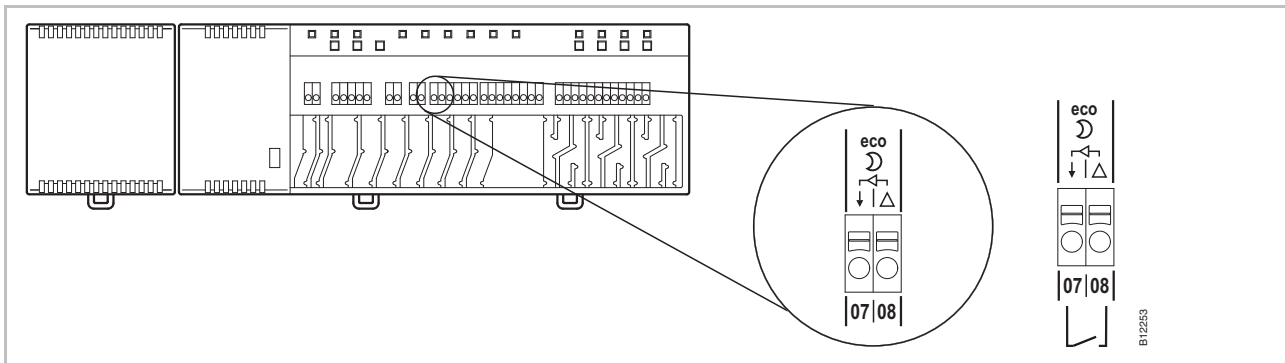

Fig. 29: Eco-input, contact recognition

Terminal 07 / 08, external contact: closed: reduced mode  
 open: normal mode



**C/O-input, for activation cooling mode by contact recognition**

- ▶ Connect a heat pump or another cooling device to terminals **09** and **10**.

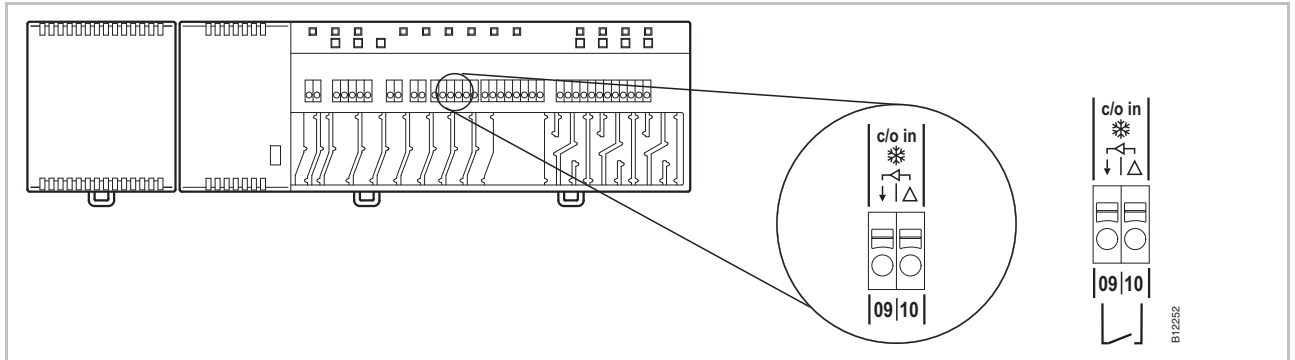

Fig. 30: C/O-input, contact recognition

Terminal 09 / 10, external contact    closed:    cooling ON  
    open:    cooling OFF

**%rH-input for optional humidity control during cooling mode**

- ▶ Connect terminal **1** and **2** of the dew-point sensor to the 24 V support voltages terminals of the wireless connection module.
- ▶ Connect the switching output of the dew-point sensor, terminal **4** and **6** to the terminals **11** and **12** of the wireless connection module.

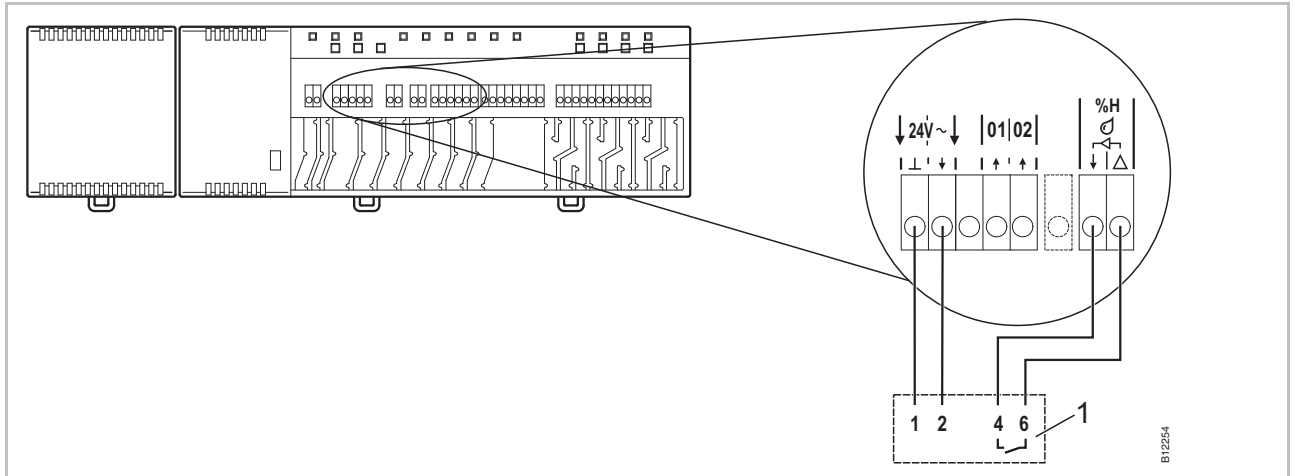

Fig. 31: Humidity input

Terminal 11 and 12,    contact closed:    maximum allowable humidity exceeded, cooling OFF  
    contact open:    maximum allowable humidity not exceeded, cooling at demand ON

1 Roth dew-point monitor (material number: 1135000327)

## Electrical connections

**Connection LAN-network** ▶ Connect the LAN-network as show below.

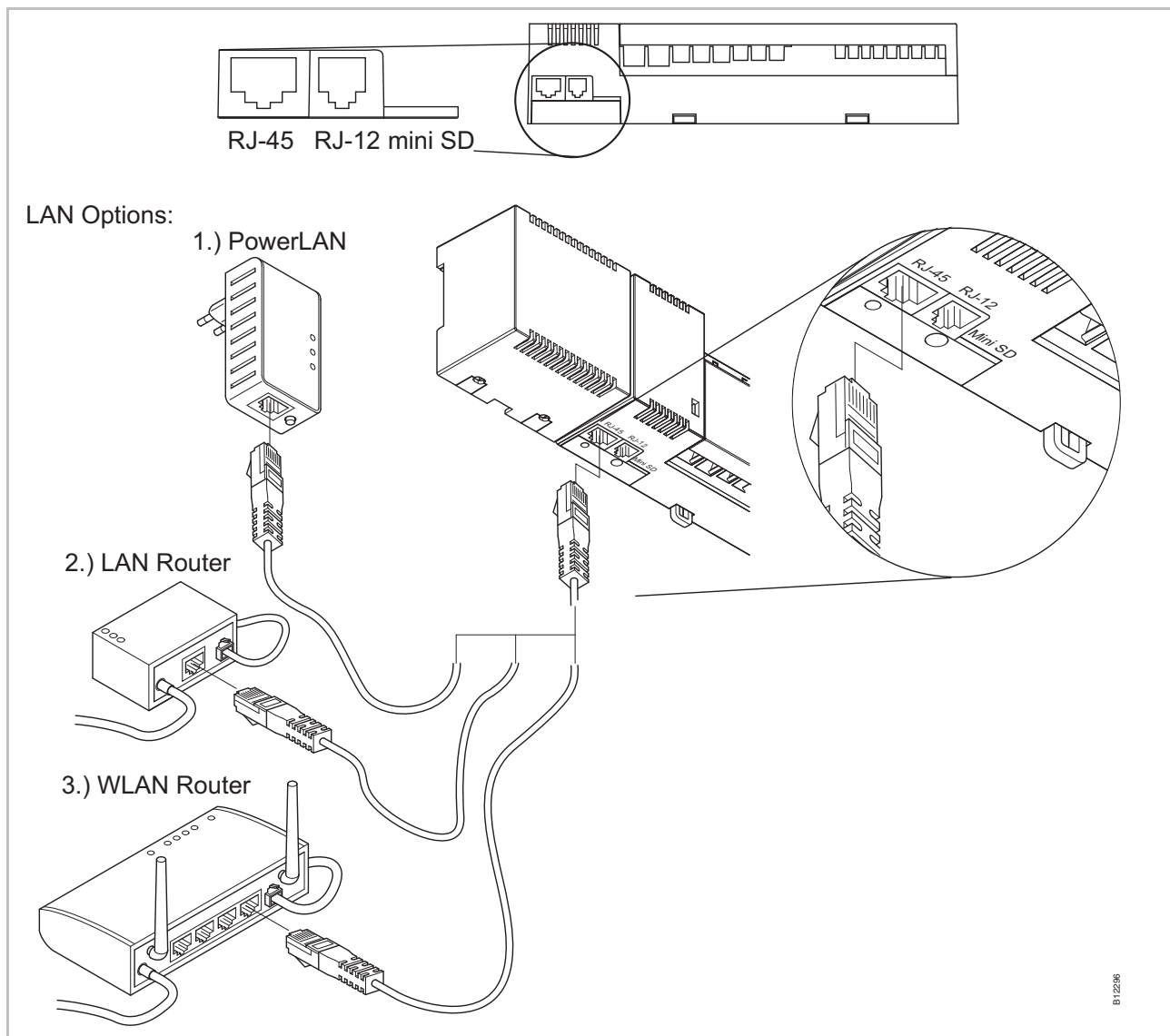

Fig. 32: LAN-network

**Install cover**

- ▶ Put on the cover as shown below
- ▶ Insert the plug from the transformer into the outlet.
- ▶ At the wireless connection module the **Power** LED must light.

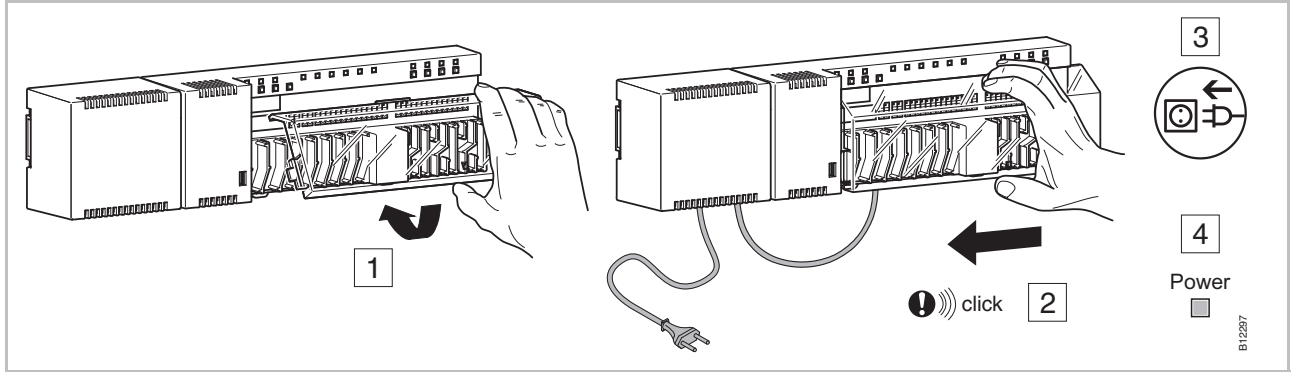

Fig. 33: Install cover and connect power supply

## 7 Commissioning and operation

### Steps during commissioning

The commissioning of the control system comprises the following steps:

- ▶ Execute the addressing between wireless connection module and wireless room thermostats.
- ▶ Test addressing.
- ▶ If applicable: set time and date with one wireless room thermostat.
- ▶ Configure wireless connection modules and wireless room thermostats.

### 7.1 Addressing

During addressing a wireless room thermostat is assigned to a radio channel.

The following combinations between a wireless connection module and a wireless room thermostat are possible:

- Address one wireless room thermostat to one radio channel.
- Address one wireless room thermostat to several radio channels.
- Address one wireless room thermostat or several wireless room thermostats to one radio channel (sensor mode)
- Address up to 3 wireless connection modules to each other.
- Combine several radio channels into one zone.
  
- Up to 20 wireless room units can be addressed to one wireless connection module, 4-, 8- or 12 channel version.
- One wireless room thermostat and up to four wireless room thermostats in sensor mode can be addressed to one channel. The additional wireless room thermostats have to be set into sensor mode before addressing to the channel.
- Each wireless connection module can be divided into up to 3 zones.

NOTE
------

---

*If for example 12 channels are needed for one installation, but the number of wireless room units (thermostats, window contacts, etc.) is exceeding the maximum of 20 pieces, then one 4- and one 8-channel wireless connection module should be selected in order to be able to incorporate up to 40 wireless room units.*

---

### 7.1.1 Address one wireless room thermostat to one radio channel.

**Example**

One wireless room thermostat shall be addressed to radio channel CH 1.

- ▶ Press push button **CH 1** of the wireless connection module.
- ▶ The corresponding LED **CH 1** blinks.
- ▶ Press the sensor buttons  and  of the wireless room thermostat for 5 seconds simultaneously.
- ▶ LED **CH 1** of the wireless connection module lights.
- ▶ After 5 seconds LED **CH 1** goes off. If a demand is present, then LED **CH 1** would continue to light.
- ▶ The display of the wireless room thermostat is activated (operation mode) The symbol  will be shown and the setpoint is blinking. The setpoint can be changed.

One wireless room thermostat is addressed to radio channel CH 1.

### 7.1.2 Address one wireless room thermostats to several radio channels

**Example**

Radio channel CH 1 and CH 2 shall be addressed to one wireless room thermostat.

- ▶ Press push button **CH 1** of the wireless connection module.
- ▶ The corresponding LED **CH 1** blinks.
- ▶ Press push button **CH 2** of the wireless connection module.
- ▶ The corresponding LED **CH 2** blinks.
- ▶ Press the sensor buttons  and  of the wireless room thermostat for 5 seconds simultaneously.
- ▶ LED CH 1 and **CH 2** of the wireless connection module light.
- ▶ After 5 seconds LEDs **CH 1** and **CH 2** go off.
- ▶ The display of the wireless room thermostat shows the symbol .

Radio channel CH 1 and CH 2 are addressed to one wireless room thermostat.

NOTE
------

---

*The radio channels can be selected and addressed in any sequence.*

---

**Commissioning and operation**

**7.1.3 Address several wireless room thermostats to one radio channel (sensor mode)**

When several wireless room thermostats in sensor mode are addressed to one channel, then all actual measured temperatures will be used to calculate the average room temperature.

**NOTE**

*Before addressing more than one wireless room thermostats to one radio channel, the additional wireless room thermostats have to be set into sensor mode.*

*In addition to one wireless room thermostat it is possible to add up to five wireless room thermostats in sensor mode.*

*When a wireless room thermostat will be addressed to a radio channel that is addressed already with another wireless room thermostat, then the address of the firstly addressed wireless room thermostat will be overwritten.*

*With parameter P-24 it is possible to put a wireless room thermostat back to factory settings. → See parameter description P-24, Option "4", page 74.*

**Activate sensor mode**

- ▶ Press the sensor buttons and of the wireless room thermostat for 10 seconds simultaneously.

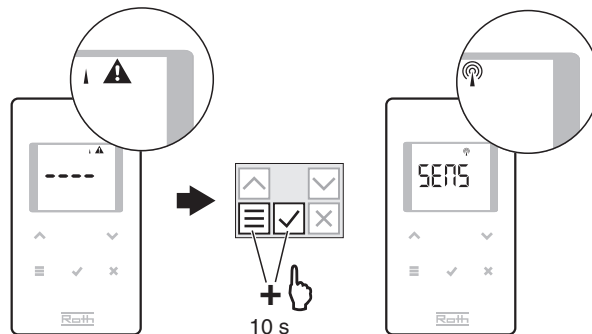

B12709

**Deactivate sensor mode**

- ▶ Press the sensor buttons and of the wireless room thermostat for 10 seconds simultaneously.

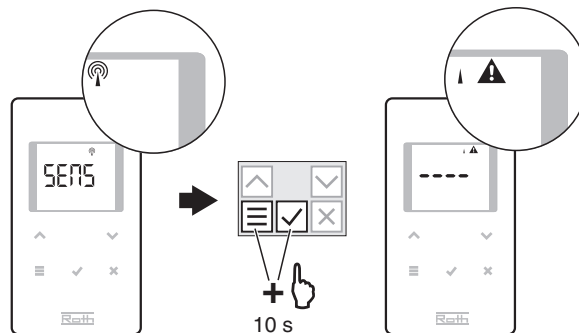

B12710



**Example**

Assign several wireless room thermostats to radio channel CH 1 for average temperature building.



**Address the first wireless room thermostat**

- ▶ Assign the first wireless room thermostat to a radio channel in accordance with chapter 7.1.1. → See page 45, chapter 7.1.1.

**Second wireless room thermostat, set sensor mode**



- ▶ Press the sensor buttons  and  of the wireless room thermostat for 10 seconds simultaneously.
- ▶ The display shows "— — —" first permanently for 5 seconds and then blinks for another 5 seconds.
- ▶ The display shows **SENS**.

NOTE

*Sensor buttons  and  are inactive when the wireless room thermostat is set in sensor mode. The setpoint can only be changed at the wireless room thermostat which is in operation mode.*

*However, configuration of parameters can still be done by pressing the sensor button .*

**Address second wireless room thermostat as temperature sensor**

- ▶ Press push button **CH 1** of the wireless connection module.
- ▶ The corresponding LED **CH 1** blinks.
- ▶ Press the sensor buttons  and  of the second wireless room thermostat for 5 seconds simultaneously.
- ▶ LED **CH 1** of the wireless connection module lights.
- ▶ After 5 seconds LED **CH 1** goes off.
- ▶ The display of the second wireless room thermostat shows the symbol .



A second wireless room thermostat has been addressed to radio channel CH 1, the first which is in sensor mode. Up to 5 units in sensor mode can be assigned to one radio channel.

NOTE

*It is possible to configure a wireless room thermostat with IR sensor also in the "temperature sensor" mode. In the "temperature sensor" mode the measured room temperature of the internal sensors are averaged. The measured floor temperatures of the IR sensors are not averaged. Only the value of the wireless room thermostat with IR sensor is processed.*

**Revoke sensor mode**

If the wireless room thermostat has not been assigned to any wireless controller yet, revoke sensor mode as follows:

- ▶ Press the sensor buttons  and  of the wireless room thermostat simultaneously for 10 seconds.

If the wireless room thermostat has already been assigned to a wireless controller, revoke sensor mode according to either version A or B.

NOTE





*In order to be able to reset the wireless room thermostat in sensor mode to the function "room operating unit", this wireless room thermostat must be assigned to a radio channel.*

**Version A**

- ▶ Select parameter P-24, Option 4 of the service menu. → See parameter description P-24, page 74.
- The wireless room thermostat will be reset to factory settings. The assignment of the wireless room thermostat in sensor mode will be deleted.

## Commissioning and operation



### Version B

- ▶ Delete the connection of the wireless room thermostat according to page 48, chapter 7.1.5.
- ▶ Press sensor button  of the wireless room thermostat 5 seconds.
- ▶ The display shows "**SENS**" and symbol .
- ▶ Press the sensor buttons  und  of the wireless room thermostat for 10 seconds simultaneously.
- ▶ The display shows "-- -- --".

The wireless room thermostat can be used again.

### 7.1.4 Test addressing

Execute the following steps to check if the wireless thermostat room are properly assigned to the wireless connection module.

- ▶ The display of the wireless room thermostat shows the symbol . The wireless room thermostat is assigned to a wireless connection module.
- ▶ Press sensor buttons  and  of the wireless room thermostat for 5 seconds simultaneously. The display of the wireless room thermostat shows "Pair" – "Test" as long as the LED of the wireless connection module lights.
- ▶ On the wireless connection module the LED of the assigned channel lights. If the wireless room thermostat is assigned to more than one channels then all assigned channel LEDs light.
- ▶ The LED/LEDs goes/go off after 5 seconds.

The addressing has been tested.

**NOTE**

*When the display shows the symbol , then the radio connection between the wireless room thermostat and the wireless connection module is interrupted.*

*→ For possible causes see page 90, chapter 10.2.*

### 7.1.5 Delete addressing

#### Example

A wireless room thermostat, which is assigned to the radio channel CH 1 has to be deleted.

- ▶ Press channel button **CH 1** of the wireless connection module 12 seconds without interruption.
- ▶ After 2 seconds LED **CH 1** blinks 5 seconds.
- ▶ LED **CH 1** blinks fast another 5 seconds.
- ▶ LED **CH 1** goes off.
- ▶ After the next radio refreshing cycle the display of wireless room thermostat shows  and "-- -- --". As this may take up to 10 minutes, press any button on the wireless room thermostat to check immediately if the channel has been deleted.

The addressing has been deleted.



## 7.1.6 Address up to 3 wireless connection modules to each other

Up to three wireless connection modules can be combined into one system. One of the wireless connection modules have to be defined as master. Ex factory all wireless connection modules are configured as slave.

**NOTE**

*The wireless connection module has to be configured as master before any wireless room thermostats are assigned. When the wireless connection module is configured as master afterwards, then it is possible that certain parameter settings are lost.*

### Configure wireless connection module as "Master"

- ▶ Press push button **Master** of the wireless connection module at least 10 seconds.
- ▶ After a short time the LED **Master** blinks 5 seconds.
- ▶ The LED **Master** blinks fast another 5 seconds.
- ▶ After 2 seconds the LED **Master** lights.

### Address wireless connection module "Slave" to "Master"

- ▶ The LED **Master** lights.
- ▶ Press push button **System** of the wireless connection module "Master" until the LED **System** blinks.
- ▶ Press push button **System** of the wireless connection module "Slave" until the LED **System** blinks.
- ▶ At successful addressing:
  - the LED **System** of the wireless connection module "Slave" lights.
  - the LED **System** of the wireless connection module "Master" changes from blinking to off.
  - the LED **System** of the wireless connection module "Master" lights as soon as the first communication with the wireless connection module "Slave" has been built up.

### Test addressing of wireless connection modules "Slave" and "Master"

The wireless connection module "Slave" is connected to the wireless connection module "Master" when at both the LED **System** lights.

**NOTE**

*Further testing is not required. If desired the proper assignment can be tested by installing a bridge at terminals 09 and 10 (C/O-Input) of the wireless connection module "Master". The wireless connection module "Master" will switch into cooling mode and will send this signal to the wireless connection module "Slave". After max. 3 minutes the LED "Cool" of the "Slave" also lights blue.*

### Delete addressing of wireless connection modules "Master" and "Slave"

- ▶ Press push button **Master** wireless connection module for 10 seconds
- ▶ After a short time the LED **Master** blinks 5 seconds.
- ▶ The LED **Master** blinks fast another 5 seconds.
- ▶ At the wireless connection module "Master" the LEDs **Master** and **System** go off and at the "Slave" the LED **System** goes off.

**NOTE**

*All central plant devices such as a central pump, burner control, C/O-signal for a heat pump etc. are connected to the wireless connection module "Master". To a wireless connection module "Slaves" only a local pump, if any, is connected.*

*→ For the configuration of the relevant parameters P-51, P-61, P62 und P-63 see parameter description page 82, chapter 8.3.6 and page 84, chapter 8.3.7.*

---

## 7.2 Zones

### Applications for zoning

Each wireless connection module can be divided in up to 3 zones.

Zones can be used for the following applications:

- Within one zone the modes of operation, "Off (frost protection)", "Eco", "Normal Operation" or the same time program will be shared. The mode or operation can be changed at each wireless room thermostat.
- One wireless room thermostat will have the highest priority for heating and cooling. The change of mode will be transferred to all wireless room thermostats within the zone. → See parameter description P-51, page 82.
- One wireless room thermostat will be assigned as master. With this wireless room thermostat there are following possibilities available:
  - Changing the mode of operation.
  - Changing the time program for the wireless connection module.
  - Selecting the mode of operation heating/cooling for the entire plant.→ See parameter description P-48, page 81.
- All wireless room thermostats share the same setpoint within the zone. → See parameter description P-46, page 80.

## 7.2.1 Zone building, assign radio channels to one zone

**NOTE**

*In the following example three zones are built. However, it is also possible to build one or two zones only, and to keep certain channels outside the zone(s).*

*Zoning building can be done only after the assignment of the wireless room thermostats to radio channels. After zoning building it is possible to add any wireless room thermostat to a zone.*

### Build first zone

- ▶ Press **Zone** button of the wireless connection module
- ▶ The green **Power** LED blinks.
- ▶ The blue LED indicating the first zone and the **CH** LEDs for channels not yet assigned to a zone blink.
- ▶ Press the **CH** buttons for the radio channels that need to be assigned to the first zone.
- ▶ The LEDs of the assigned channels light.

### Build second zone

- ▶ Press **Zone** button for the second time.
- ▶ The red LED indicating the second zone and the **CH** LEDs for channels not yet assigned to a zone blink.
- ▶ Press the **CH** buttons for the radio channels that need to be assigned to the second zone.
- ▶ The LEDs of the assigned channels light.

### Build third zone

- ▶ Press **Zone** button for the third time.
- ▶ The yellow LED indicating the third zone and the **CH** LEDs for channels not yet assigned to a zone blink.
- ▶ Press the **CH** buttons for the radio channels that need to be assigned to the third zone.
- ▶ The LEDs of the assigned channels light.

### End zone building

- ▶ Press **Zone** button for the fourth time.
- ▶ The LEDs for zoning go off. The green **Power** LED lights.

The wireless connection is in operation. Zones are built.

## 7.2.2 Delete assignment of a radio channel or several radio channels to a zone

Delete the assignment of a radio channel to a zone in reverse order compared to the addressing

- ▶ Press the **Zone** button of the wireless connection module repeatedly until the LED for the zone from which the radio channel must be deleted lights.
  - Zone 1: blue LED
  - Zone 2: red LED
  - Zone 3: yellow LED.
- ▶ The **CH** LEDs that are assigned to the selected zone light.
- ▶ Press the **CH** button of the radio channel that needs to be deleted from the zone.
- ▶ The relevant LED blinks. The radio channel is no longer assigned to the zone.
- ▶ Repeat this procedure in case further or all assignments need to be deleted.

---

NOTE
------

*When all CH LEDs blink after the first press of the **Zone** button, then no zones are built.*

---

## 7.3 Change setpoints

### 7.3.1 Set room temperature

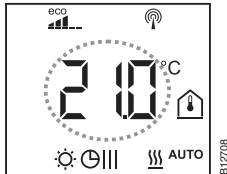

The wireless room thermostat is in stand-by mode.

- ▶ Press any button on the wireless room thermostat for 2 seconds.
- ▶ The display changes into operation mode. The setpoint blinks.
- ▶ Press sensor button or , to change the setpoint.
- ▶ Press sensor button to confirm the new setpoint.
  - If no sensor button is pressed, then the new setpoint will be automatically saved after 5 seconds.
  - To interrupt this procedure press the sensor button . The new setpoint will **not** be saved.
- ▶ If no sensor button is pressed, the wireless room thermostat returns into stand-by mode.

### 7.3.2 Set floor temperature

The setting of the floor temperature is only available for the type with IR floor temperature measurement.

The wireless room thermostat is in stand-by mode.

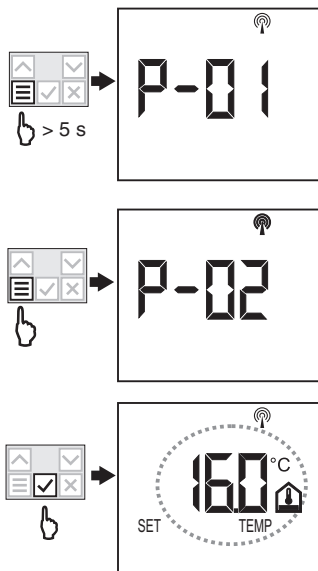

- ▶ Press any button on the wireless room thermostat for 2 seconds.
- ▶ The display changes into operation mode. The room temperature setpoint blinks.
- ▶ Press sensor button 5 seconds to enter the user menu. The display shows **P01**.
- ▶ Press sensor button . The display shows **P02**.
- ▶ Press sensor button . The display shows the setpoint for the floor temperature and the symbol .
- ▶ Press sensor button or , to change the setpoint.
- ▶ Select one of the following options:
  - Press sensor button to confirm the new setpoint. The display shows **P03**.
  - Press sensor button , to interrupt the procedure. The new setpoint is **not** saved. The display shows **P02**.
  - If no sensor button is pressed, the wireless room thermostat returns into stand-by mode after 1 minute. The new setpoint is **not** saved.
- ▶ To leave the user menu press sensor button . The display shows the operation mode.

## Commissioning and operation

**NOTE**

If for the stand-by mode for the parameter P-01 the option "Actual value" is selected, the actual value of the IR sensor (floor temperature) will be displayed for the first four seconds. Afterwards the actual value of the room temperature sensor is displayed. If for the parameter P-01 the option "IR sensor" (floor temperature) is selected, the display is in reverse order.

The floor temperature is measured every three minutes. The value shown and the value used in the wireless connection module is the average of the last three measurements.

**NOTE**

The IR floor temperature control is not active in cooling mode.

### 7.4 Select mode of operation



With the wireless room thermostat the following modes of operation can be selected:

Symbol	Description
⏻	Off (frost protection)
☾	Reduced operation
☀	Normal operation
⌚ III	Time program I "Pro 1", II "Pro 2" and III "Pro 3"
❄	Cooling mode (only selectable if the wireless room thermostat has priority over the heating/cooling device)
🔥	Heating mode (only selectable if the wireless room thermostat has priority over the heating/cooling device)
❄ <b>AUTO</b>	Auto cooling mode (can not be changed by wireless room thermostat as the mode is determined by the cooling device through a C/O input)

Table 11: Modes of operation

#### Select mode of operation

The wireless room thermostat is in stand-by mode.

- ▶ Press any button on the wireless room thermostat for 2 seconds.
- ▶ The display changes into operation mode. The room temperature setpoint blinks.
- ▶ Press shortly the sensor button . The ⏻ symbol blinks.
- ▶ Press shortly the sensor button , to change to the next mode of operation symbol. The symbol of the next mode of operation blinks.
- ▶ Press the sensor button  repeatedly, until the symbol of the desired mode of operation blinks.

- ▶ Press the sensor button , to confirm the new mode of operation.
  - If no sensor button is pressed, the selection is interrupted after 10 seconds and the wireless room thermostat returns into stand-by mode. The new mode of operation is **not** saved.
  - Press the sensor button , to interrupt the procedure. The new mode of operation is **not** saved.

**NOTE**

*The modes of operation heating and cooling are only selectable if the wireless room thermostat has the priority over the C/O input.*

*If a wireless room thermostat has been defined as master, then heating and cooling can only be selected with the master wireless room thermostat.*

*→ For the configuration of the relevant parameters P-48 and P-51 see parameter description page 81 and page 82.*

**NOTE**

*When the operating mode "Off (frost protection)" was selected, the display switches from sleep mode to operating mode and the display shows the set value for parameter P-32. In cooling operation, the display shows "OFF" when switching from sleeping mode to operating mode. The buttons  and  are not active.*

**Select and change time program**

→ See page 57, chapter 7.6.

**NOTE**

*If a time program is activated it is possible to manually override the mode of operation determined by the time program. At the next switching point of the time program, the manual override is deactivated again by the time program. However, if "Off (frost protection)" has been selected, the mode of operation will remain "Off (frost protection)" at any time.*

*In order to permanently operate the wireless room thermostat manually, the time program must be deactivated.*

## 7.5 Set time and date

### At commissioning

For proper functioning of the plant it is necessary to set the time and date of each wireless connection module.

During addressing of the first wireless room thermostat to a wireless connection module, the setting of the time and date is automatically prompted. If this procedure is skipped, then it will be repeated when the next wireless room thermostat is assigned.

- ▶ The value for the hour blinks.
- ▶ Press sensor button  or , to set the actual value for the hours.
- ▶ Press sensor button  to confirm. The value for the minutes blinks.
- ▶ Set minutes, year, month and day as described for the hours.
- ▶ When time and date have been set press sensor button . The display shows the operation mode.

### Check and adjust time and date, when needed

If necessary the time and date can be checked and adjusted directly at the wireless room thermostat.

The wireless room thermostat is in stand-by mode.

- ▶ Press any button on the wireless room thermostat for 2 seconds.
- ▶ The display changes into operation mode. The room temperature setpoint blinks.
- ▶ Press sensor button  5 seconds. The value for the hours blinks.
- ▶ Press sensor buttons  or , to set the actual value for the hours.
- ▶ Press sensor button  to confirm. The value for the minutes blinks.
- ▶ Set minutes, year, month and day as described for the hours.
- ▶ When time and date have been set press sensor button . The display shows the operation mode.



## 7.6 Time programs

### 7.6.1 Overview of the three time programs”

The wireless connection module has three different types of time programs that can be changed. The time programs are the same for all room thermostats.

- I: One profile for all weekdays (one profile)  
 Profile symbol:   
 Time program I has just one profile with three switched-on periods that are the same for every day.
- II: One profile for working days and one profile for the weekend (2 profiles)  
 Profile symbols: working days: , weekend:   
 With time program II one can distinguish between "working days" and "weekends", each with three switched-on periods.
- III: One profile for each weekday (7 profiles)  
 Profile symbols: Monday , Tuesday , ... Saturday , Sunday   
 The most advanced time program can be made with time program III: it is possible to create different profiles for every weekday, each with three switched-on periods.

### 7.6.2 Definition "switched-on period" and "switching points"

**NOTE**

A switching point comprises of two switching points at all times. Specify a time for each switching point. Set the time for the change from "reduced operation" to "regular operation" for the first switching point. The display shows this switching point by the following symbol . Set the time for the change from "regular operation" to "reduced operation" for the second switching point. The display shows this switching point by the following symbol .

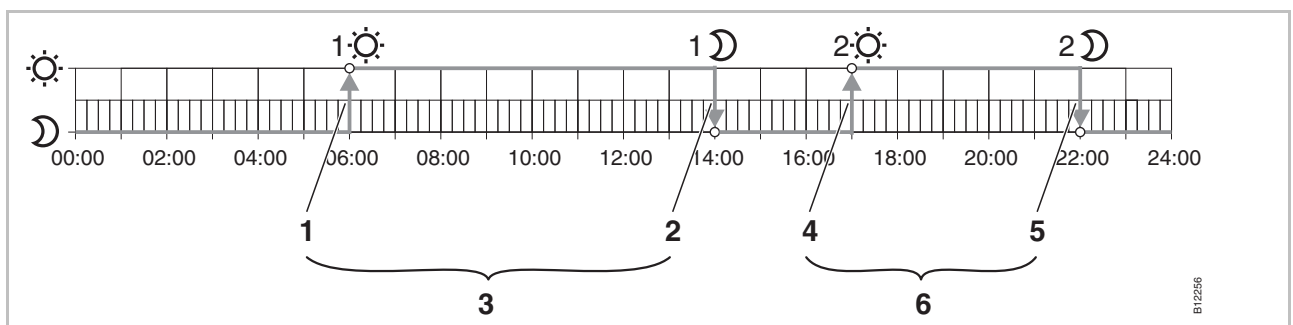

Fig. 34: Explanation "switched-on period" and "switching point"

- 1 First switching point "reduced" → "normal"
- 2 First switching point "normal" → "reduced"
- 3 First switched-on period
- 4 Second switching point "reduced" → "normal"
- 5 Second switching point "normal" → "reduced"
- 6 Second switched-on period

Commissioning and operation

7.6.3 Factory settings time program

	☰						☱						☷							
	1:☉	1:☽	2:☉	2:☽	3:☉	3:☽	1:☉	1:☽	2:☉	2:☽	3:☉	3:☽	1:☉	1:☽	2:☉	2:☽	3:☉	3:☽		
1													A	06:00...08:30	11:30...13:30	16:30...23:00				
2													B	06:00...08:30	11:30...13:30	16:30...23:00				
3							A	06:00...08:30	16:30...23:00	OFF			C	06:00...08:30	11:30...13:30	16:30...23:00				
4	A	06:00...23:00	OFF			-							D	06:00...08:30	11:30...13:30	16:30...23:00				
5													E	06:00...08:30	11:30...13:30	16:30...23:00				
6							B	06:00...23:00	OFF	OFF			F	06:00...23:00	00:00...00:00	00:00...00:00				
7													G	06:00...23:00	00:00...00:00	00:00...00:00				
1													A							
2													B							
3							A						C							
4	A	e.g. 06:00...14:00	e.g. 17:00...22:00										D							
5													E							
6							B						F							
7													G							

Fig. 35: Factory settings time programs

NOTE

It is possible to enter one to three switched-on periods. If only one switched-on period is entered, then during programming the second period is shown at the display as "OFF" and the third is not shown at all. When a second period is entered, then the third period will appear as "OFF", and can be programmed too.

NOTE

The temperature difference between "normal" and "reduced" can be adjusted individually for each wireless room thermostat. Factory setting is 3 K.







During "reduced operation" the display in operation mode shows the setpoint of "normal operation". If the setpoint has to be changed during "reduced operation", please note that the wireless connection module is actually controlling with the shown setpoint MINUS the set reduction.

→ See parameter description P-44, page 79.

## 7.6.4 Select time program

In the mode of operation "time program" one of the three time programs I, II, or III can be selected. The time programs are shown with the symbols  $\odot$ I,  $\odot$ II, or  $\odot$ III. If the symbol  $\odot$  and the message **OFF** is shown, then no time program is active. If only the symbol  $\odot$  without the message **OFF** is shown, then the "ECO" input of the wireless connection module is active.

The wireless room thermostat is in stand-by mode.

- ▶ Press any button on the wireless room thermostat for 2 seconds.
- ▶ The display changes into operation mode. The room temperature setpoint blinks.
- ▶ Press shortly the sensor button  in order to enter the mode of operation selection. The  $\odot$  symbol blinks.
- ▶ Press the sensor button  repeatedly, until the symbol of the time program blinks:  $\odot$ . The display shows **OFF**.
- ▶ Press the sensor buttons  or , to select time program **I, II, III, or OFF**. Corresponding to the symbols the display also shows **Pro1, Pro2 or Pro3**.
- ▶ Press sensor button , to confirm the selected time program.
  - If no sensor button is pressed, the selection is interrupted after 10 seconds and the wireless room thermostat returns into stand-by mode. The new mode of operation is **not** saved.
  - Press the sensor button , to interrupt the procedure. The new mode of operation is **not** saved.

**Commissioning and operation**

**7.6.5 Change time program**

**NOTE**

The sequence of the switching points has to be fix and ascending:

	Switching point
Switched-on period 1	☀ reduced ⇒ normal
	☾ normal ⇒ reduced
Switched-on period 2	☀ reduced ⇒ normal
	☾ normal ⇒ reduced
Switched-on period 3	☀ reduced ⇒ normal
	☾ normal ⇒ reduced

The switching points can be shifted in any direction. However, they should not overlap each other. For example the second switching point reduced ⇒ normal should not lie before the first switching point reduced ⇒ normal.

The switching points of a switched-on period may not lie between the switching points of another switched-on period.

At midnight "00:00" means begin of day and "24:00" end of day.

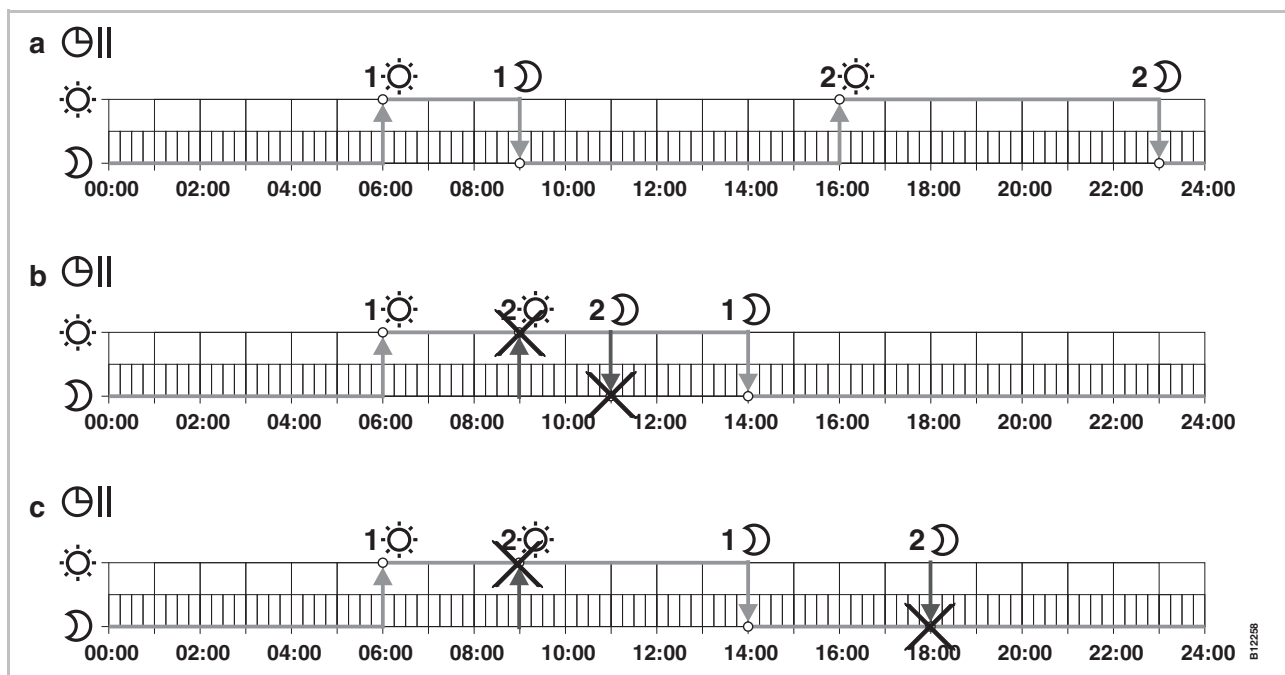

Fig. 36: Right and wrong settings of the time program

- a Right setting: The switching points are configured in ascending order.
- b Wrong setting: The switching points of the second switched-on period lie between the switching points of the first switched-on period.
- c Wrong setting: Switched-on period 1 and 2 overlap.

**Change an existing time program**

Time program **Pro1** has to be changed.

The wireless room thermostat is in stand-by mode.

- ▶ Press any button on the wireless room thermostat for 2 seconds.
- ▶ The display changes into operation mode. The room temperature setpoint blinks.
- ▶ Press sensor button 5 seconds to enter the user menu. The display shows **P01**.
- ▶ Press sensor button shortly 3 times until the display shows **P04**.
- ▶ Press sensor button . The display shows message **Prd 1**. The symbol blinks and all weekdays are shown.
- ▶ Press sensor button or , to select time program 2 (**Pro2**) or time program 3 (**Pro3**).
- ▶ Press sensor button , to confirm the selection of the time program.

**Example**

The default value of the first time program has to be changed.

Switching points	Factory settings	Change
Switched-on period 1 "reduced" ⇒ "normal"	06:00	06:00 (unchanged)
Switched-on period 1 "normal" ⇒ "reduced"	23:00	09:00
Switched-on period 2 "reduced" ⇒ "normal"	OFF	16:00
Switched-on period 2 "normal" ⇒ "reduced"	OFF	22:00

Table 12: Example change of time program 1

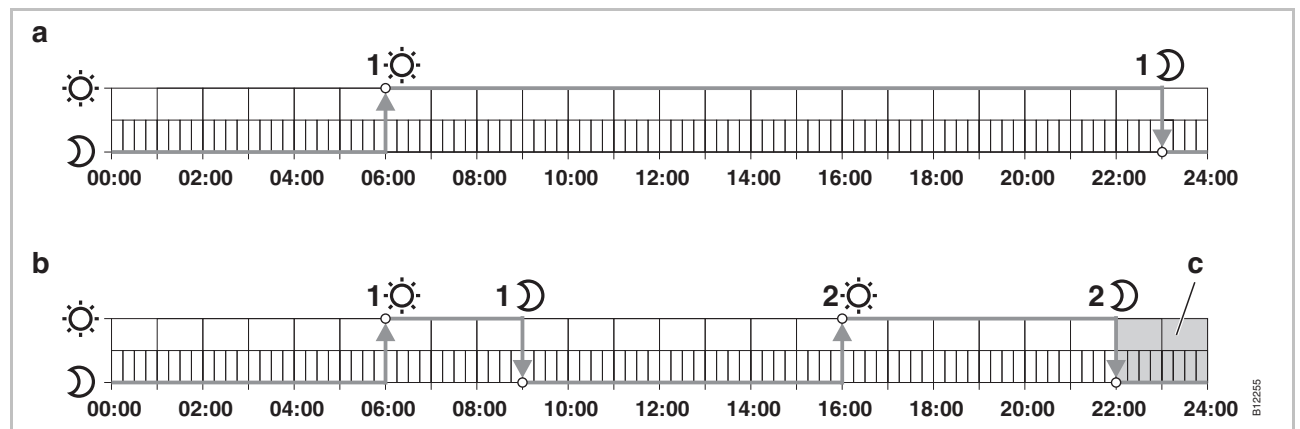

Fig. 37: Change of time program 1

A Factory settings







B New settings according to example

C In this example a third switched-on period can only lie in the grey area.







## Commissioning and operation

### Time program Pro1 – change first switched-on period

Time program **Pro1** is selected. The factory settings need to be changed.

-  → 
  - ▶ Press sensor button . The display shows the time of the first switching point for "reduced to normal". Time **06:00** blinks. Symbol  is shown.
-  → 
  - ▶ Press sensor button  to confirm the default time **06:00**. The display shows the time of the first switching point "normal to reduced". Time **23:00** blinks. Symbol  is shown.
  - ▶ Press sensor button , to set the new time at **09:00**.
  - ▶ Press sensor button , to save the changes of the first switch-on period. The time for the first switching point "reduced to normal" has not been changed. The time for the first switching point "normal to reduced" has been changed to 09:00.



### Set second switched-on period

- ▶ The display shows the message **OFF**. The second switched-on period is not used.
-  → 
  - ▶ Press sensor button , to set the new time at **16:00**.  
The time for the second switching point "reduced to normal" has been set at 16:00. Symbol  is shown.
-  → 
  - ▶ Press sensor button . The display shows the time of the second switching point "normal to reduced". Time **16:00** blinks. Symbol  is shown.
  - ▶ Press sensor button , to set the new time at **22:00**.
  - ▶ Press sensor button , to save the changes of the second switch-on period.  
The time for the second switching point "normal to reduced" has been set at 23:00. Symbol  is shown.

### Set third switched-on period

**NOTE**

*The second switched-on period must first be set in time program Pro1 in order to enable the message OFF of the third switched-on period. If the second switched-on period is not set, the message OFF is not shown.*

- ▶ The display shows the message **OFF**. The third switched-on period is not used.
- ▶ Select one of the following options:
  - Press sensor button , to set the time of the third switching point "reduced to normal". As the last switching point of the second switched-on period is set at 23:00, the time of the third switching points "reduced to normal" and "normal to reduced" have to be set between 23:00 and 24:00. Otherwise the second switched-on period has to be shifted.
  - Press sensor button . The display shows **Pro2**. Symbol  blinks and all working days  are shown.

**Time program Pro2**

- ▶ Select one of the following options:
  - Press sensor button , to skip time program **Pro2** and to go to time program **Pro3**.
  - Press sensor button , to leave the time program Pro2. The display shows **P-04**.
  - Press sensor button , to configure time program **Pro2**.
- ▶ After pressing the sensor button , the display shows the symbol for working days     .
- ▶ Set all switching points of the desired switched-on periods for the working days as described for **Pro1**.
- ▶ Repeat this procedure for the weekend. The display shows the symbol for the weekend  .

Time program **Pro2** has be set.

**Time program Pro3**

- ▶ Procedure as described for time program **Pro 2**.

With time program **Pro3** all switching points of the desired switched-on periods are set per individual day of the week.

NOTE
------

*To remove a switched-on period set the time of both switching points at the same value. First remove the third switched-on period, then the second switched-on period. When the second of three switched-on periods is removed, then also the third is deleted.*

*Please note that if sensor buttons are not pressed for more than one minute the wireless room thermostat return to its battery saving mode before the time program is completed.*

## 7.6.6 Reset time programs to factory settings

The three time programs can be reset to factory settings individually with parameter **P-05**.

## Commissioning and operation

### 7.7 "eco" - Indicator



The "eco"- indicator displays the relative energy consumption of the plant. The "eco"- indicator has five levels.

The "eco"- level is depending on the following factors:

- Setpoint
- Actual room temperature
- Mode of operation
- Duration of the control deviation
- At heating and cooling plants: settings of the dead-zone.



Symbol	Description
eco 	"eco"- level 1: low relative energy consumption, high energy efficiency
eco 	"eco"-level 5: high relative energy consumption, low energy efficiency

Table 13: "eco"- indicator



#### Energy efficiency

The energy efficiency can be increased by the following measures:



- ▶ Reduce the setpoint of the room temperature and if applicable the minimum floor temperature.
- ▶ Use the time program and adapt this program to the end-user's daily schedule.
- ▶ For plants with heating and cooling: increase the dead-zone between heating and cooling.
- ▶ Use the optional accessory "Universal I/O Box" for an optimized control of the heat pump.

### 7.8 Lock / unlock operation of wireless room thermostat

#### Lock operation

- ▶ Press sensor buttons  and  of the wireless room thermostat simultaneously for at least 5 seconds.
- ▶ The display shows symbol . Operation is locked.

#### Unlock operation

- ▶ Press sensor buttons  and  of the wireless room thermostat simultaneously for at least 5 seconds.
- ▶ Symbol  is no longer shown at the display. Operation is unlocked.



## 7.9 Reset to factory settings

→ See parameter description P-24, page 74.

### **Reset values to factory settings via wireless connection module**

- ▶ Press push buttons **Master** and **System** of the wireless connection module simultaneously for 10 seconds.
- ▶ After a short time the LEDs **Master** and **System** blink 5 seconds.
- ▶ The LEDs **Master** and **System** blink fast another 5 seconds.
- ▶ At the wireless connection module "Master" the LEDs **Master** and **System** go off.

## 7.10 Software-Update with mini SD-card

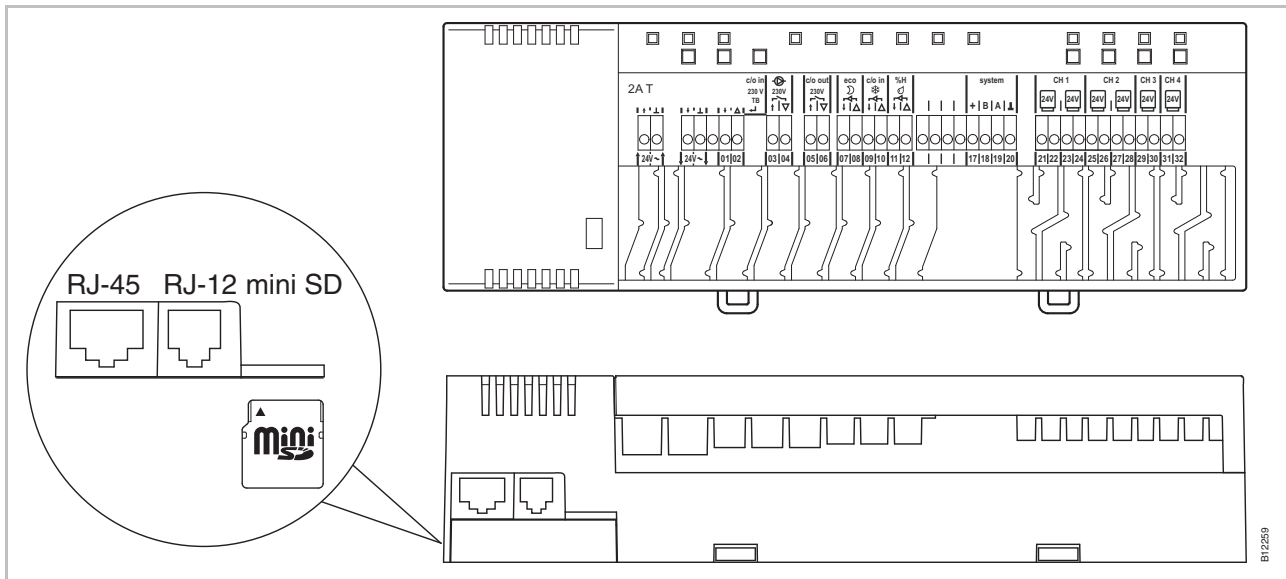

Fig. 38: mini SD-card

- 1 LAN connection, RJ-45
- 2 Active antenna connection, RJ-12
- 3 Slot for mini SD-card

- ▶ Disconnect power supply. Power LED off.
- ▶ Change SD-card.
- ▶ Reconnect power supply. Power LED on.
- ▶ The software update is automatically flashed into the micro controllers of the wireless connection module with the integrated boot loader.

**NOTE**

*For the proper function of the plant it is normally not necessary to update the software.*

*However, if a plant extension is made some time after the installation and commissioning of the first wireless connection module and for example a second wireless connection module that should communicate with the existing wireless connection module is added, then it is appropriate that the software release of both wireless connection modules are the same.*

*As it is not possible to downgrade the software of the added wireless connection module, the software of the already installed wireless connection module should be updated with the software release of the added wireless connection module. The latest software release can be obtained at any time from the Roth webpage. Please read the accompanying instructions before executing the software update.*

## 8 Parameter descriptions

The menu is divided in a user menu and a service menu. The user menu is freely accessible. The service menu can only be entered through a service code.

**NOTE**

*Parameters can only be set by a wireless room thermostat at the same time. Once an attempt is made to set parameters via another room thermostat at the same time, the display shows the following symbol .*

### 8.1 Parameter overview

#### User menu

Parameter	Description
P-01	Set display in stand-by-mode: actual value or time.
P-02	Set setpoint for the minimal floor temperature. (only for versions with integrated IR-sensor)
P-03	Set upper and lower limits for room temperature setpoint.
P-04	Change time programs.
P-05	Reset time programs to factory settings.
P-06	Set display for stand-by-mode. (max. battery saving mode)
P-07	Activate or deactivate sound of sensor button.
P-08	Show ID-number of wireless room thermostat
P-09	Show ID-number of wireless connection module

#### Service menu

##### P-20 General parameters

Parameter	Description
P-SE	Access only with service code, factory settings "1234"
P-21	Show software-version of wireless room thermostat
P-22	Show software-version of wireless connection module
P-23	Show actual status of wireless connection module and I/O-Box
P-24	Reset parameter to factory settings.

## Parameter descriptions

### P-30 Parameters for all wireless room thermostats

Parameter	Description
P-31	Set increment for room temperature setpoint adjustment.
P-32	Set temperature for frost protection function.
P-33	Set unit for temperature.
P-34	Set dead-zone for change-over between heating and cooling.
P-35	Change service code for service menu.
P-36	Change access code for public spaces.
P-37	Activate or deactivate "summer-/wintertime".

### P-40 Parameters for individual wireless room thermostats

Parameter	Description
P-41	Set wall temperature correction of wireless room thermostat.
P-42	Set floor temperature correction of wireless room thermostat with integrated IR-sensor.
P-43	Set maximum floor temperature of wireless room thermostat with integrated IR-sensor.
P-44	Set reduction of room temperature for "Eco" function.
P-45	Activate or deactivate cooling lock and/or bypass, e.g. for a heat pump.
P-46	Activate or deactivate "setpoint sharing within one zone"
P-47	Activate or deactivate lock for public spaces or hotels.
P-48	Activate or deactivate master function of a wireless room thermostat.

### P-50 Plant and topology related parameters

Parameter	Description
P-51	Set priorities for change-over of heating/cooling and configure output for heating/cooling or burner start.
P-52	Activate or deactivate "optimized time program".
P-53	Set communication between wireless connection modules radio frequency, BUS or LAN.









**P-60  
Control parameters**

Parameter	Description
P-61	Configure ECO or N/R input.
P-62	Configure C/O in-/TB-input.
P-63	Select control of pump "local" or "Master-wireless connection module" (only with activated communication between wireless connection modules).
P-64	Select NC or NO function of thermal actuators.
P-65	Select control algorithm.
P-66	Activate or deactivate function "optimized actuator control".
P-67	Select controlled first start-up of floor heating.



## 8.2 User menu

**Enter user menu**

The wireless room thermostat is in stand-by mode.

- ▶ Press any button on the wireless room thermostat for 2 seconds.
- ▶ The display changes into operation mode. The room temperature setpoint blinks.
- ▶ Press sensor button  5 seconds to enter the user menu. The display shows **P01**.
- ▶ Select one of the following options:
  - Press sensor button , to confirm the parameter selection.
  - Press sensor button , to select parameter **P02**.
- ▶ Press sensor button  or , to change the settings of the selected parameter.
- ▶ Select one of the following options:
  - Press sensor button  to save the parameter change. The display shows the next parameter **Pxx**.
  - Press sensor button , to interrupt the procedure. The parameter change is **not** saved. The display shows the actual selected parameter.
  - If no sensor button is pressed, the wireless room thermostat returns into stand-by mode after 1 minute. The changed parameter is **not** saved.
- ▶ To leave the user menu press sensor button . Any confirmed parameter setting will be sent to the wireless connection module. The display shows the operation mode.

## Parameter descriptions

Parameter	Description
P-01	<p>Set display in stand-by-mode.</p> <ul style="list-style-type: none"> <li>• Factory settings: room temperature</li> </ul> <p><b>Operation</b></p> <ul style="list-style-type: none"> <li>▶ Press sensor button <input checked="" type="checkbox"/> or <input checked="" type="checkbox"/>, to select the displayed value change: room-, floor-, outdoor temperature or time. Floor and outdoor temperature are only available with certain versions and accessories.</li> <li>▶ Press sensor button <input checked="" type="checkbox"/> to confirm selection. The display shows <b>P-02</b>.</li> </ul>
P-02	<p>  IR</p> <p>Set setpoint for the minimal floor temperature.</p> <ul style="list-style-type: none"> <li>• Factory settings: 15 °C</li> <li>• Setting range: 15...30 °C</li> <li>• Increment: 0.5 °C</li> </ul> <p><b>Operation</b></p> <ul style="list-style-type: none"> <li>▶ Press sensor button <input checked="" type="checkbox"/> or <input checked="" type="checkbox"/>, to adjust the setpoint.</li> <li>▶ Press sensor button <input checked="" type="checkbox"/> to confirm the setpoint. The display shows <b>P-03</b>.</li> </ul>
P-03	<p>Set upper and lower limits for room temperature setpoint.</p> <ul style="list-style-type: none"> <li>• Factory settings: <ul style="list-style-type: none"> <li>– Maximal setpoint temperature: 30 °C</li> <li>– Minimal setpoint temperature: 5 °C</li> </ul> </li> </ul> <p><b>Operation</b></p> <ul style="list-style-type: none"> <li>▶ Press sensor button <input checked="" type="checkbox"/>. The display shows <b>Hi30</b>. (Hi: high).</li> <li>▶ Press sensor button <input checked="" type="checkbox"/> or <input checked="" type="checkbox"/>, to set the upper limit.</li> <li>▶ Press sensor button <input checked="" type="checkbox"/>. The display shows <b>Lo05</b>. (Lo: low).</li> <li>▶ Press sensor button <input checked="" type="checkbox"/> or <input checked="" type="checkbox"/>, to set the lower limit.</li> <li>▶ Press sensor button <input checked="" type="checkbox"/> to confirm the changed limits. The display shows <b>P-04</b>.</li> </ul>
P-04	<p>Change time programs.</p> <p><b>Operation</b></p> <p>→ See page 56, chapter 7.5.</p>
P-05	<p>Reset time programs to factory settings.</p> <p><b>Operation</b></p> <ul style="list-style-type: none"> <li>▶ Press sensor button <input checked="" type="checkbox"/>. The display shows <b>Pro1</b> for time program 1.</li> <li>▶ Press sensor button <input checked="" type="checkbox"/> or <input checked="" type="checkbox"/>, to select between time programs <b>Pro1</b>, <b>Pro2</b> or <b>Pro3</b>.</li> <li>▶ Press sensor button <input checked="" type="checkbox"/>. The display shows <b>no</b>.</li> <li>▶ Press sensor button <input checked="" type="checkbox"/> or <input checked="" type="checkbox"/>, to select between options <b>no</b> and <b>yes</b>.</li> <li>▶ Press sensor button <input checked="" type="checkbox"/> to confirm the selection. The display shows <b>P-06</b>.</li> </ul>

Parameter	Description
P-06	<p>Set display for stand-by-mode. (max. battery saving mode)</p> <p>To minimize battery consumption the display can be switched off in stand-by- mode. Only the symbol "low battery" will be shown when applicable.</p> <ul style="list-style-type: none"> <li>• Factory settings: option "On"</li> <li>• Options           <ul style="list-style-type: none"> <li>– On: normal, as defined with parameter P-01.</li> <li>– Off: no symbols are shown (max. battery saving mode)</li> </ul> </li> </ul> <p><b>Operation</b></p> <ul style="list-style-type: none"> <li>▶ Press sensor button <input checked="" type="checkbox"/>. The display shows shortly <b>diSP</b> and then <b>On</b>.</li> <li>▶ Press sensor button <input checked="" type="checkbox"/> or <input checked="" type="checkbox"/>, to select option <b>On</b> or <b>OFF</b>.</li> <li>▶ Press sensor button <input checked="" type="checkbox"/> to confirm selection. The display shows <b>P-07</b>.</li> </ul>
P-07	<p>Activate or deactivate sound of sensor button.</p> <ul style="list-style-type: none"> <li>• Factory settings: Option "On"</li> <li>• Options           <ul style="list-style-type: none"> <li>– On: activate</li> <li>– OFF: deactivate</li> </ul> </li> </ul> <p><b>Operation</b></p> <ul style="list-style-type: none"> <li>▶ Press sensor button <input checked="" type="checkbox"/>. The display shows <b>On</b>.</li> <li>▶ Press sensor button <input checked="" type="checkbox"/> or <input checked="" type="checkbox"/>, to select option <b>On</b> or <b>OFF</b>.</li> <li>▶ Press sensor button <input checked="" type="checkbox"/> to confirm selection. The display shows <b>P-08</b>.</li> </ul>
P-08	<p>Show ID-number of wireless room thermostat.</p> <p>This ID-Number is needed to configure a smart phone web-application!</p> <p><b>Operation</b></p> <ul style="list-style-type: none"> <li>▶ Press sensor button <input checked="" type="checkbox"/>. The display shows the ID-number.</li> <li>▶ Press sensor button <input checked="" type="checkbox"/>. The display shows <b>P-09</b>.</li> </ul>
P-09	<p>Show ID-number of wireless connection module.</p> <p>This ID-Number is needed to configure a smart phone web-application!</p> <p><b>Operation</b></p> <ul style="list-style-type: none"> <li>▶ Press sensor button <input checked="" type="checkbox"/>. The display shows the ID-number.</li> <li>▶ Press sensor button <input checked="" type="checkbox"/>. The display shows <b>P-SE</b> (enter service menu).</li> </ul>

Table 14: User menu







## 8.3 Service menu

### 8.3.1 Enter service menu













#### P-SE

The service menu is protected with a service code. → This service code can be changed with parameter P-36. → See parameter description P-36, page 77.

The wireless room thermostat is in stand-by mode.

- ▶ Press any button on the wireless room thermostat for 2 seconds.
- ▶ The display changes into operation mode. The room temperature setpoint blinks.
- ▶ Press sensor button  5 seconds to enter the user menu. The display shows **P01**.
- ▶ Press sensor button  repeatedly until the display shows **P-SE**.
- ▶ Press sensor button . The display shows **0000**.
- ▶ Press sensor button  and  to enter the service code. The factory setting of the service code is **1234**. Confirm each selected digit with sensor button .
- ▶ If the service code is correct then the display shows **P-20**, otherwise the display shows **P-SE**.

### 8.3.2 Select parameter group

- ▶ Press sensor button , to select parameter group P-20, P-30, P-40, P-50 or P-60, e.g. **P-30**.
- ▶ Press sensor button , to confirm the selected parameter group P-30. The display shows parameter **P-31**.
- ▶ Press sensor button , repeatedly to select a parameter of the parameter group P-30. Press sensor button  e.g. twice. The display shows **P-33**.
- ▶ Select one of the following steps:
  - Press sensor button , to confirm selection.
  - Press sensor button . The display shows **P-34**.
- ▶ Press sensor button  or , to change the settings of the selected parameter.
- ▶ Select one of the following steps:
  - Press sensor button , to save the changed settings. The display shows the next parameter **Pxx**.
  - Press sensor button , to interrupt the procedure. Any changed settings are not saved. The display shows the actual selected parameter.
- ▶ Press sensor button , to leave the parameter group. The display shows the next parameter group, here e.g. **P-40**.
- ▶ To leave the user menu press sensor button . Any confirmed parameter setting will be sent to the wireless connection module. The display shows the operation mode. The room temperature setpoint blinks.



### 8.3.3 P-20 "General parameters"

For the following parameter descriptions the relevant parameter was already selected. The display shows **P-xx**.

Parameter	Description
P-21	<p>Show software-version of wireless room thermostat.</p> <p><b>Operation</b></p> <ul style="list-style-type: none"> <li>▶ Press sensor button <input checked="" type="checkbox"/>. The display shows the Software-Version.</li> <li>▶ Press sensor button <input checked="" type="checkbox"/>. The display shows <b>P-22</b>.</li> </ul>
P-22	<p>Show software-version of wireless connection module</p> <p><b>Operation</b></p> <ul style="list-style-type: none"> <li>▶ Press sensor button <input checked="" type="checkbox"/>. The display shows the Software-Version.</li> <li>▶ Press sensor button <input checked="" type="checkbox"/>. The display shows <b>P-23</b>.</li> </ul>
P-23	<p>Show actual status of wireless connection module and I/O-Box.</p> <ul style="list-style-type: none"> <li>• Options           <ul style="list-style-type: none"> <li>– 0: no errors detected.</li> <li>– 1: Alarm wireless connection module, TB-input active</li> <li>– 2: Alarm external signal I/O-Box</li> <li>– 3: Error wireless connection module and I/O-Box</li> </ul> </li> </ul> <p><b>Operation</b></p> <ul style="list-style-type: none"> <li>▶ Press sensor button <input checked="" type="checkbox"/>. The display shows <b>0</b> if no error is detected. If an error is detected, then <b>1</b>, <b>2</b> or <b>3</b> and the warning symbol  are shown.</li> <li>▶ Press sensor button <input checked="" type="checkbox"/>. The display shows <b>P-24</b>.</li> </ul>

## Parameter descriptions









Parameter	Description
P-24	<p>Reset parameter to factory settings.</p> <p>Parameters are partly stored in the wireless connection module and partly in the wireless room thermostat. Which parameters can be reset under which conditions is defined in chapter 15.3.</p> <ul style="list-style-type: none"> <li>• Options <ul style="list-style-type: none"> <li>– 0: Not active, no reset will be executed.</li> <li>– 1: Reset wireless connection module to factory settings. The addressing of wireless room thermostat and wireless connection module will not be deleted.</li> <li>– 2: Reset wireless connection module to factory settings. The addressing of wireless room thermostats, wireless connection module and accessories will be deleted.</li> <li>– 3: Reset wireless room thermostat to factory settings. The addressing of a wireless room thermostat or temperature sensor (sensor mode) will not be deleted.</li> <li>– 4: Reset wireless room thermostat to factory settings. The addressing of wireless room thermostat or temperature sensor (sensor mode) will be deleted.</li> </ul> </li> </ul> <p><b>Operation</b></p> <ul style="list-style-type: none"> <li>▶ Press sensor button . The display shows <b>0</b>.</li> <li>▶ Press sensor button  or , to select an option.</li> <li>▶ Press sensor button . The display shows <b>no</b>.</li> <li>▶ Press sensor button  or , to select between options <b>no</b> or <b>yes</b>.</li> <li>▶ Select one of the following options: <ul style="list-style-type: none"> <li>– Press sensor button , to save the changed settings. The display shows the next parameter <b>P-21</b>.</li> <li>– Press sensor button , to interrupt the procedure. The display shows the selected parameter.</li> </ul> </li> </ul>

Table 15: Service menu – P-20 "General parameter"

### 8.3.4 P-30 "Parameters for all wireless room thermostats"

Any change of the following parameters will be transmitted to all wireless room thermostats that are assigned to the wireless connection module.

It can take up to 10 minutes before all wireless room thermostats that are in stand-by-mode have received the transmitted data. If the wireless room thermostat is manually changed from stand-by-mode to operation-mode, the new data is immediately collected from the wireless connection module.

Parameter	Description
P-31	<p>Set increment for room temperature setpoint adjustment.</p> <ul style="list-style-type: none"> <li>• factory settings: option "0"</li> <li>• Options:               <ul style="list-style-type: none"> <li>– 0: 0.5 K (1 F)</li> <li>– 1: 0.1 K (0.2 F)</li> <li>– 2: 0.2 K (0.5 F)</li> </ul> </li> </ul> <p><b>Operation</b></p> <ul style="list-style-type: none"> <li>▶ Press sensor button <input checked="" type="checkbox"/>. The display shows <b>0</b>.</li> <li>▶ Press sensor button <input type="checkbox"/> or <input type="checkbox"/>, to select option <b>1</b> or <b>2</b>.</li> <li>▶ Select one of the following options:               <ul style="list-style-type: none"> <li>– Press sensor button <input checked="" type="checkbox"/>, to save the changed settings. The display shows the next parameter <b>P-32</b>.</li> <li>– Press sensor button <input type="checkbox"/>, to interrupt the procedure. The display shows the selected parameter.</li> </ul> </li> </ul>
P-32	<p>Set temperature for frost protection function.</p> <p>The frost protection function will be activated as soon as the measured room temperature is below the set frost protection temperature.</p> <ul style="list-style-type: none"> <li>• Factory settings: 8.0 °C</li> <li>• Setting range: 3...13 °C</li> </ul> <p><b>Operation</b></p> <ul style="list-style-type: none"> <li>▶ Press sensor button <input checked="" type="checkbox"/>. The display shows <b>8.0</b>.</li> <li>▶ Press sensor button <input type="checkbox"/> or <input type="checkbox"/>, to change the value.</li> <li>▶ Select one of the following options:               <ul style="list-style-type: none"> <li>– Press sensor button <input checked="" type="checkbox"/>, to save the changed settings. The display shows the next parameter <b>P-33</b>.</li> <li>– Press sensor button <input type="checkbox"/>, to interrupt the procedure. The display shows the selected parameter.</li> </ul> </li> </ul>

## Parameter descriptions













Parameter	Description
P-33	<p>Set unit for temperature.</p> <ul style="list-style-type: none"> <li>• Factory settings: Option "0"</li> <li>• Options:                             <ul style="list-style-type: none"> <li>– 0: °C</li> <li>– 1: F</li> </ul> </li> </ul> <p><b>Operation</b></p> <ul style="list-style-type: none"> <li>▶ Press sensor button <input type="checkbox"/>. The display shows <b>0</b>.</li> <li>▶ Press sensor button <input type="checkbox"/> or <input type="checkbox"/>, to select option <b>1</b>.</li> <li>▶ Select one of the following options:                             <ul style="list-style-type: none"> <li>– Press sensor button <input type="checkbox"/>, to save the changed settings. The display shows the next parameter <b>P-34</b>.</li> <li>– Press sensor button <input type="checkbox"/>, to interrupt the procedure. The display shows the selected parameter.</li> </ul> </li> </ul>
P-34	<p>Set dead-zone for change-over between heating and cooling.</p> <p>The dead-zone will be applied by the wireless connection module as soon as the mode of operation changes over from heating to cooling and visa versa. The value of the dead-zone will be added to the setpoint "heating". The dead-zone is incorporated in the displayed room temperature setpoint.</p> <p>Calculation: Setpoint "cooling" = Setpoint "heating" + dead-zone</p> <p>Example: Setpoint "heating" = 21°C (shown setpoint during heating) Dead-zone = 2 K,</p> <p>Result: Setpoint "cooling" = 21 + 2 = 23°C. (shown setpoint during cooling)</p> <div style="border: 1px solid black; padding: 2px; margin: 10px 0;"> <p style="text-align: center;"><i>NOTE</i></p> </div> <p>The value for the "dead-zone" may only be changed if the mode of operation is set at "heating". If this value is set during "cooling", the value will be doubled!</p> <ul style="list-style-type: none"> <li>• Factory settings: Option "0"</li> <li>• Options:                             <ul style="list-style-type: none"> <li>– 0: 2 K</li> <li>– 1: 4 K</li> <li>– 2: 6 K</li> <li>– 3: 0 K, dead-zone deactivated</li> </ul> </li> </ul> <p><b>Operation</b></p> <ul style="list-style-type: none"> <li>▶ Press sensor button <input type="checkbox"/>. The display shows <b>0</b>.</li> <li>▶ Press sensor button <input type="checkbox"/> or <input type="checkbox"/>, to select option <b>1, 2, or 3</b>.</li> <li>▶ Select one of the following options:                             <ul style="list-style-type: none"> <li>– Press sensor button <input type="checkbox"/>, to save the changed settings. The display shows the next parameter <b>P-35</b>.</li> <li>– Press sensor button <input type="checkbox"/>, to interrupt the procedure. The display shows the selected parameter.</li> </ul> </li> </ul>













Parameter	Description
P-35	<p>Change service code for service menu.</p> <ul style="list-style-type: none"> <li>• Factory settings: 1234</li> </ul> <p><b>Operation</b></p> <ul style="list-style-type: none"> <li>▶ Press sensor button <input checked="" type="checkbox"/>. The display shows <b>1234</b>.</li> <li>▶ Press sensor button <input checked="" type="checkbox"/> or <input type="checkbox"/>, to change the service code. Confirm each selected digit with sensor button <input checked="" type="checkbox"/>.</li> <li>▶ Select one of the following options:                             <ul style="list-style-type: none"> <li>– Press sensor button <input checked="" type="checkbox"/>, to save the changed settings. The display shows the next parameter <b>P-36</b>.</li> <li>– Press sensor button <input checked="" type="checkbox"/>, to interrupt the procedure. The display shows the selected parameter.</li> </ul> </li> </ul> <p><b>ATTENTION</b></p> <p>In order to avoid unwanted access to the service parameters, the service code should be changed and safely documented by the installer.</p>
P-36	<p>Change access code for public spaces.</p> <p>The access code for public spaces is independent from the service code protecting the service menu. The access code is only active if parameter P-47 is activated.</p> <ul style="list-style-type: none"> <li>• Factory settings: 1234</li> </ul> <p><b>Operation</b></p> <ul style="list-style-type: none"> <li>▶ Press sensor button <input checked="" type="checkbox"/>. The display shows <b>1234</b>.</li> <li>▶ Press sensor button <input checked="" type="checkbox"/> or <input type="checkbox"/>, to change the access code. Confirm each selected digit with sensor button <input checked="" type="checkbox"/>.</li> <li>▶ Select one of the following options:                             <ul style="list-style-type: none"> <li>– Press sensor button <input checked="" type="checkbox"/>, to save the changed settings. The display shows the next parameter <b>P-37</b>.</li> <li>– Press sensor button <input checked="" type="checkbox"/>, to interrupt the procedure. The display shows the selected parameter.</li> </ul> </li> </ul> <p><b>ATTENTION</b></p> <p>The access code has to be changed in order to avoid unwanted access.</p>
P-37	<p>Activate or deactivate "summer-/wintertime".</p> <p>If time and date are synchronized through the LAN-connection, then the automatic summertime / wintertime adaptation must be deactivated.</p> <ul style="list-style-type: none"> <li>• Factory settings: Option "0"</li> <li>• Options:                             <ul style="list-style-type: none"> <li>– 0: activate</li> <li>– 1: deactivate</li> </ul> </li> </ul> <p><b>Operation</b></p> <ul style="list-style-type: none"> <li>▶ Press sensor button <input checked="" type="checkbox"/>. The display shows <b>0</b>.</li> <li>▶ Press sensor button <input checked="" type="checkbox"/> or <input type="checkbox"/>, to select option <b>0</b> or <b>1</b>.</li> <li>▶ Select one of the following options:                             <ul style="list-style-type: none"> <li>– Press sensor button <input checked="" type="checkbox"/>, to save the changed settings. The display shows the next parameter <b>P-31</b>.</li> <li>– Press sensor button <input checked="" type="checkbox"/>, to interrupt the procedure. The display shows the selected parameter.</li> </ul> </li> <li>▶ Press sensor button <input checked="" type="checkbox"/>. The display shows <b>P-40</b>.</li> </ul>

Table 16: Service menu –P-30 "Parameters for all wireless room thermostats"

## Parameter descriptions

### 8.3.5 P-40 "Parameters for individual wireless room thermostats"

Parameter	Description
P-41	<p>Set wall temperature correction of wireless room thermostat. The compensated temperature will be shown at the display as actual value.</p> <ul style="list-style-type: none"> <li>• Factory settings: 0 K</li> <li>• Setting range: -3...+3 K</li> <li>• Increment: 0.1 K</li> </ul> <p><b>Operation</b></p> <ul style="list-style-type: none"> <li>▶ Press sensor button . The display shows <b>0</b>.</li> <li>▶ Press sensor button  or , to change the value.</li> <li>▶ Select one of the following options: <ul style="list-style-type: none"> <li>– Press sensor button , to save the changed settings. The display shows the next parameter <b>P-42</b>.</li> <li>– Press sensor button , to interrupt the procedure. The display shows the selected parameter.</li> </ul> </li> </ul>
P-42   IR	<p>Set floor temperature correction of wireless room thermostat with integrated IR-sensor.</p> <ul style="list-style-type: none"> <li>• Factory settings: Option "0"</li> <li>• Options: <ul style="list-style-type: none"> <li>– 0, standard setting: suitable for wood floors</li> <li>– 1, average compensation: suitable for plastic floorings</li> <li>– 2, high compensation: suitable for ceramic floors</li> </ul> </li> </ul> <p style="border: 1px solid black; padding: 2px; display: inline-block;">NOTE</p> <ul style="list-style-type: none"> <li>• The specified settings apply at a room temperature of 22 °C.</li> <li>• For dark floorings or if the room temperature is at approx. 25 °C, you need to switch up the compensation factor one level for all floors except for ceramic floors.</li> <li>• No obstacles such as carpets, floorings or furniture must be placed in the measuring range of the IR sensor.</li> <li>• <b>Glossy floorings, e.g. due to sun irradiation, may cause measuring errors at the IR sensor.</b></li> </ul> <p><b>Operation</b></p> <ul style="list-style-type: none"> <li>▶ Press sensor button . The display shows <b>0</b>.</li> <li>▶ Press sensor button  or , to select option <b>1</b> or <b>2</b>.</li> <li>▶ Select one of the following options: <ul style="list-style-type: none"> <li>– Press sensor button , to save the changed settings. The display shows the next parameter <b>P-43</b>.</li> <li>– Press sensor button , to interrupt the procedure. The display shows the selected parameter.</li> </ul> </li> </ul>

Parameter	Description
P-43   IR	<p>Set maximum floor temperature of wireless room thermostat with integrated IR-sensor.</p> <p>This parameter avoids that the floor temperature exceeds a maximum temperature level.</p> <p><b>ATTENTION</b></p> <p>This function is not designed as a safety limiter. Therefore any liability for damages to the floor construction or plant components is expressly excluded. If a safety temperature limiter function is required then this has to be provided by an external hardwired safety temperature limiter (STB).</p> <ul style="list-style-type: none"> <li>• Factory settings: 35 °C</li> <li>• Setting range: 26...35 °C</li> <li>• Increment: 1 K</li> </ul>
P-43 (continued)	<p><b>Operation</b></p> <ul style="list-style-type: none"> <li>▶ Press sensor button . The display shows <b>35</b>.</li> <li>▶ Press sensor button  or , to change the value.</li> <li>▶ Select one of the following options:             <ul style="list-style-type: none"> <li>– Press sensor button , to save the changed settings. The display shows the next parameter <b>P-44</b>.</li> <li>– Press sensor button , to interrupt the procedure. The display shows the selected parameter.</li> </ul> </li> </ul>
P-44	<p>Set reduction of room temperature for "Eco" function.</p> <p>The frost protection function has a higher priority than the Eco function. → See parameter description P-32, page 75.</p> <p>Independently of the set value, the reduced temperature can not lower than 11 °C and not higher than 21 °C. This limitation will be selected automatically.</p> <ul style="list-style-type: none"> <li>• Factory settings: 3 K below the actual setpoint.</li> <li>• Setting range: 0...+10 K</li> <li>• Step size: 1 K</li> </ul> <p><b>Operation</b></p> <ul style="list-style-type: none"> <li>▶ Press sensor button . The display shows <b>3</b>.</li> <li>▶ Press sensor button  or , to change the value.</li> <li>▶ Select one of the following options:             <ul style="list-style-type: none"> <li>– Press sensor button , to save the changed settings. The display shows the next parameter <b>P-45</b>.</li> <li>– Press sensor button , to interrupt the procedure. The display shows the selected parameter.</li> </ul> </li> </ul>

## Parameter descriptions

Parameter	Description
P-45	<p>Activate or deactivate cooling lock and/or by-pass, e.g. for a heat pump.</p> <div style="border: 1px solid black; padding: 2px; margin: 5px 0;">NOTE</div> <ul style="list-style-type: none"> <li>• For applications that can lead to high temperatures, like solar heating, we strongly advise not to activate the function "By-pass heating" as the radio channel of the "by-pass heating" is not closed by the alarm of the TB-input.</li> <li>• When a heat pump is not equipped with a pressure overload by-pass, we advise to configure one or more heating loops (depending on the minimum load requirements), as by-pass.</li> <li>• Factory settings: Option "0"</li> <li>• Options:             <ul style="list-style-type: none"> <li>– 0: By-pass inactive, cooling lock inactive</li> <li>– 1: By-pass "heating" active, cooling lock inactive</li> <li>– 2: By-pass "cooling" active, cooling lock inactive</li> <li>– 3: By-pass "heating" and by-pass "cooling" active, cooling lock inactive</li> <li>– 4: By-pass inactive, cooling lock active</li> <li>– 5: By-pass "heating" active, cooling lock active</li> </ul> </li> </ul> <p><b>Operation</b></p> <ul style="list-style-type: none"> <li>▶ Press sensor button <input checked="" type="checkbox"/>. The display shows <b>0</b>.</li> <li>▶ Press sensor button <input type="checkbox"/> or <input type="checkbox"/>, to select option <b>1, 2, 3, 4 or 5</b>.</li> <li>▶ Select one of the following options:             <ul style="list-style-type: none"> <li>– Press sensor button <input checked="" type="checkbox"/>, to save the changed settings. The display shows the next parameter <b>P-46</b>.</li> <li>– Press sensor button <input type="checkbox"/>, to interrupt the procedure. The display shows the selected parameter.</li> </ul> </li> </ul>
P-46	<p>Activate or deactivate "setpoint sharing within one zone". → Refer to also page 108, chapter 15.</p> <p>Setpoint sharing is typically used for large rooms that have different temperature profiles for different parts of the room. The room is divided into several heating zones each with its own wireless room thermostat. Each heating zone will control the part of the room according to its own control loop. However, all setpoints are the same. A change of the setpoint at one wireless room thermostat initiates a change of all relevant wireless room thermostats. All relevant room thermostats need to be within one zone of the wireless connection module and enabled for setpoint sharing by the settings of parameter P-46.</p> <ul style="list-style-type: none"> <li>• Factory settings: Option "0"</li> <li>• Options:             <ul style="list-style-type: none"> <li>– 0: deactivate</li> <li>– 1: activate</li> </ul> </li> </ul> <p><b>Operation</b></p> <ul style="list-style-type: none"> <li>▶ Press sensor button <input checked="" type="checkbox"/>. The display shows <b>0</b>.</li> <li>▶ Press sensor button <input type="checkbox"/> or <input type="checkbox"/>, to select option <b>0 or 1</b>.</li> <li>▶ Select one of the following options:             <ul style="list-style-type: none"> <li>– Press sensor button <input checked="" type="checkbox"/>, to save the changed settings. The display shows the next parameter <b>P-47</b>.</li> <li>– Press sensor button <input type="checkbox"/>, to interrupt the procedure. The display shows the selected parameter.</li> </ul> </li> </ul>



















Parameter	Description
P-47	<p>Activate or deactivate lock for public spaces or hotels.</p> <ul style="list-style-type: none"> <li>• factory settings: Option "0"</li> <li>• Options:               <ul style="list-style-type: none"> <li>– 0: deactivate lock.</li> <li>– 1: activate lock for public spaces. All sensor buttons are locked. When pressing sensor button  the access code for public spaces is prompted. → See parameter description P-36, page 77.</li> <li>– 2: activate lock for hotels. All sensor buttons except for sensor buttons  and  are locked. With sensor buttons  and  it is possible to change the room temperature setpoint. When pressing sensor button  the access code for public spaces is prompted. → See parameter description P-36, page 77.</li> </ul> </li> </ul>
P-47 (continued)	<p><b>Operation</b></p> <ul style="list-style-type: none"> <li>▶ Press sensor button . The display shows <b>0</b>.</li> <li>▶ Press sensor button  or , to select option <b>0</b>, <b>1</b> or <b>2</b>.</li> <li>▶ Select one of the following options:               <ul style="list-style-type: none"> <li>– Press sensor button , to save the changed settings. The display shows the next parameter <b>P-48</b>.</li> <li>– Press sensor button , to interrupt the procedure. The display shows the selected parameter.</li> </ul> </li> </ul>
P-48	<p>Activate or deactivate master function of a wireless room thermostat.</p> <p>One wireless room thermostat per wireless connection module or per zone can be defined as master. With this master wireless room thermostat the modes of operation "Off (frost protection)", "reduced operation", "normal operation" and the time programs can be changed for the complete plant.</p> <p>Modes of operation can be changed locally with every wireless room thermostat. However, if the mode of operation is changed with the master wireless room thermostat then all local modes of operation are overridden.</p> <p>With parameter P-51 it is possible to provide any wireless room thermostat with the priority to change also the mode "heating/cooling", either centrally or locally (but valid for the entire plant). → See parameter description P-51, page 82.</p> <p>The master function of a wireless room thermostat is permanently shown in the display with <b>1</b> (left of the actual value).</p> <ul style="list-style-type: none"> <li>• factory settings: Option "0"</li> <li>• Options:               <ul style="list-style-type: none"> <li>– 0: deactivate</li> <li>– 1: activate</li> </ul> </li> </ul> <p><b>Operation</b></p> <ul style="list-style-type: none"> <li>▶ Press sensor button . The display shows <b>0</b>.</li> <li>▶ Press sensor button  or , to select option 0 or 1.</li> <li>▶ Select one of the following options:               <ul style="list-style-type: none"> <li>– Press sensor button , to save the changed settings. The display shows the next parameter <b>P-41</b>.</li> <li>– Press sensor button , to interrupt the procedure. The display shows the selected parameter.</li> </ul> </li> <li>▶ Press sensor button . The display shows <b>P-50</b>.</li> </ul>

Table 17: Service menu – P-40 "Parameters for individual wireless room thermostats"

**Parameter descriptions**

**8.3.6 P-50 "Plant- and topology related parameter"**

Parameter	Description
<p>P-51</p>	<p>Set priorities for change-over of heating/cooling and configure output for heating/cooling or burner start.</p> <p><b>ATTENTION</b></p> <p>If communication between wireless connection modules has been selected, then the settings of P-51 must be the same at all wireless connection modules with a wireless room thermostat. Otherwise the plant will not function properly.</p> <p>If option "0" or "1" has been selected, then the heating/cooling unit performs the master function and determines the heating/cooling mode. The mode of operation for heating/cooling can not be set by any wireless room thermostat nor be influenced by the wireless connection module.</p> <p>If option "2" has been selected, then the mode of operation for heating/cooling is determined by any wireless room thermostat. The heating/cooling unit has no influence on the mode of operation for heating/cooling. In addition it is possible to set one wireless room thermostat as master for heating/cooling. → See parameter description P-48, page 81.</p> <ul style="list-style-type: none"> <li>• Factory settings: Option "0"</li> <li>• Options:                     <ul style="list-style-type: none"> <li>– 0: C/O-Input and C/O-Output of the wireless connection module have priority.</li> <li>– 1: Burner start and C/O-Input of the wireless connection module have priority. The C/O-Output is configured as burner start and switches off immediately when heating demand is not required. In cooling mode this output is inactive.</li> <li>– 2: The change-over between heating and cooling can only be done with the wireless room thermostat. In cooling mode the C/O-Output of the wireless connection module is active.</li> </ul> </li> </ul> <p><b>Operation</b></p> <ul style="list-style-type: none"> <li>▶ Press sensor button <input checked="" type="checkbox"/>. The display shows <b>0</b>.</li> <li>▶ Press sensor button <input type="checkbox"/> or <input type="checkbox"/>, to select option <b>0</b>, <b>1</b> or <b>2</b>.</li> <li>▶ Select one of the following options:                     <ul style="list-style-type: none"> <li>– Press sensor button <input checked="" type="checkbox"/>, to save the changed settings. The display shows the next parameter <b>P-52</b>.</li> <li>– Press sensor button <input type="checkbox"/>, to interrupt the procedure. The display shows the selected parameter.</li> </ul> </li> </ul>
<p>P-52</p>	<p>Activate or deactivate "optimized time program".</p> <p>If the function "optimized time program" is activated then the time of switching point "reduced to normal" shall be the time that the setpoint "normal operation" is reached. Hence, the wireless connection module will calculate an early start of the heating or cooling mode in order to do so.</p> <ul style="list-style-type: none"> <li>• Factory settings: Option "0"</li> <li>• Options:                     <ul style="list-style-type: none"> <li>– 0: deactivated</li> <li>– 1: activated</li> </ul> </li> </ul>

Parameter	Description
P-52 (continued)	<p><b>Operation</b></p> <ul style="list-style-type: none"> <li>▶ Press sensor button <input checked="" type="checkbox"/>. The display shows <b>0</b>.</li> <li>▶ Press sensor button <input checked="" type="checkbox"/> or <input type="checkbox"/>, to select option <b>0</b> or <b>1</b>.</li> <li>▶ Select one of the following options:               <ul style="list-style-type: none"> <li>– Press sensor button <input checked="" type="checkbox"/>, to save the changed settings. The display shows the next parameter <b>P-53</b>.</li> <li>– Press sensor button <input checked="" type="checkbox"/>, to interrupt the procedure. The display shows the selected parameter.</li> </ul> </li> </ul>
P-53	<p>Set communication between wireless connection modules radio frequency, BUS RS485 or LAN.</p> <p>Defines the communication between wireless connection modules: via radio frequency and/or via BUS RS 485 or via LAN. Within one system either up to 3 wireless connection modules can communicate via radio frequency, or up to 16 units via BUS RS485. The communications versions RS485 and LAN must not be used together within a system. → See page 108, chapter 15.</p> <ul style="list-style-type: none"> <li>• Factory settings: Option "0"</li> <li>• Options:           <ul style="list-style-type: none"> <li>– 0: Communication via radio frequency and BUS RS485 active, communication via LAN inactive</li> <li>– 1: Communication via LAN active, communication via BUS RS485 inactive</li> <li>– 2: Communication via radio frequency, BUS RS 485 and LAN inactive</li> </ul> </li> </ul> <p><b>Operation</b></p> <ul style="list-style-type: none"> <li>▶ Press sensor button <input checked="" type="checkbox"/>. The display shows <b>0</b>.</li> <li>▶ Press sensor button <input checked="" type="checkbox"/> or <input type="checkbox"/>, to select option <b>0</b>, <b>1</b> or <b>2</b>.</li> <li>▶ Select one of the following options:           <ul style="list-style-type: none"> <li>– Press sensor button <input checked="" type="checkbox"/>, to save the changed settings. The display shows the next parameter <b>P-51</b>.</li> <li>– Press sensor button <input checked="" type="checkbox"/>, to interrupt the procedure. The display shows the selected parameter.</li> </ul> </li> <li>▶ Press sensor button <input checked="" type="checkbox"/>. The display shows <b>P-60</b>.</li> </ul>

Table 18: Service menu – P-50 "Plant- and topology related parameters"

## Parameter descriptions

### 8.3.7 P-60 "Control parameters"

Parameter	Description
P-61	<p>Configure ECO or N/R input.</p> <p>With the ECO-input it is possible to override the actual mode of operation of all wireless room thermostats with an additional main switch or SMS-modem. Depending on the selected option this function can either switch between "normal" and "reduced" or between "normal" and "frost protection (off)".</p> <p>If the ECO-Input is activated, then the display shows the symbol ☺.</p> <ul style="list-style-type: none"> <li>• Factory settings: Option "0"</li> <li>• Options: <ul style="list-style-type: none"> <li>– 0: N/R-Input is inactive. If at the wireless room thermostats a time program is selected, then this time program has priority.</li> <li>– 1: The ECO-Input has the highest priority, switches to "reduced". ECO-Input active: time program wireless room thermostat deactivated, mode of operation and setpoint can be changed. ECO-Input inactive: all functions of wireless room thermostat available, including time program.</li> <li>– 2: The ECO-Input has the highest priority, switches to "reduced". ECO-Input active: time program wireless room thermostat deactivated, mode of operation and setpoint can be changed. ECO-Input inactive: all functions of wireless room thermostat available, excluding time program. Symbol ☺ is fix.</li> <li>– 3: The ECO-Input has the highest priority, switches to "frost protection". ECO-Input active: time program wireless room thermostat deactivated, mode of operation and setpoint can be changed. ECO-Input inactive: all functions of wireless room thermostat available, including time program. Symbol ☺</li> <li>– 4: The ECO-Input has the highest priority, switches to "frost protection". ECO-Input active: time program wireless room thermostat deactivated, mode of operation and setpoint can be changed. ECO-Input inactive: all functions of wireless room thermostat available, excluding time program. Symbol ☺ is fix.</li> </ul> </li> </ul> <p><b>Operation</b></p> <ul style="list-style-type: none"> <li>▶ Press sensor button <input type="checkbox"/>. The display shows <b>0</b>.</li> <li>▶ Press sensor button <input type="checkbox"/> or <input type="checkbox"/>, to select option <b>0, 1, 2, 3</b> or <b>4</b>.</li> <li>▶ Select one of the following options: <ul style="list-style-type: none"> <li>– Press sensor button <input type="checkbox"/>, to save the changed settings. The display shows the next parameter <b>P-62</b>.</li> <li>– Press sensor button <input type="checkbox"/>, to interrupt the procedure. The display shows the selected parameter.</li> </ul> </li> </ul>

Parameter	Description
P-62	<p>Configure C/O in-/TB-input.</p> <p>The TB-Inputs detects a voltage between 24 V and 230 V.</p> <ul style="list-style-type: none"> <li>• C/O in-/TB-Input: As soon as a voltage is detected the mode of operation of the wireless connection module is changed to cooling. If this wireless connection module is addressed to other wireless connection modules, then this C/O signal will be sent to the other wireless connection modules within 3 minutes. Please note wiring diagram Fig. 26, page 38. Phase and neutral have to be connected as defined in this diagram. The connection to terminals 01 (L) and 02 (N) may not be interchanged.</li> <li>• TB-Input for temperature monitoring: When the maximum supply water temperature is reached, an external safety limiter will switch off the pump and transfers this signal to the wireless connection module. Due to a primary pump or natural circulation it is possible that water further circulates through the heating loops.</li> </ul> <p><b>ATTENTION</b></p> <p>The TB-Input may not be used as safety temperature limiter.</p> <p><b>NOTE</b></p> <p>A radio channel configured as by-pass will not close when TB-Input is activated.</p> <ul style="list-style-type: none"> <li>• Factory settings: Option "2"</li> <li>• Options           <ul style="list-style-type: none"> <li>– 0: TB-Input is configured as temperature monitor. When the input is activated then the pump will be switched off immediately and all actuators are closed. When activated the red LED lights at the wireless connection module and the warning symbol is shown at the display of the wireless room thermostat.</li> <li>– 1: TB-Input is configured as temperature monitor. When the input is activated then the pump will be <b>not</b> be switched off, but all actuators are closed. When activated the red LED lights at the wireless connection module and the warning symbol is shown at the display of the wireless room thermostat.</li> <li>– 2: The "C/O in"-Input is configured as change-over for heating and cooling and as additional C/O-Input. When this input is activated, then the wireless connection module switches to cooling. The C/O-output is active.</li> </ul> </li> </ul> <p><b>Operation</b></p> <ul style="list-style-type: none"> <li>▶ Press sensor button <input checked="" type="checkbox"/>. The display shows <b>0</b>.</li> <li>▶ Press sensor button <input type="checkbox"/> or <input type="checkbox"/>, to select option <b>0</b>, <b>1</b>, or <b>2</b>.</li> <li>▶ Select one of the following options:           <ul style="list-style-type: none"> <li>– Press sensor button <input checked="" type="checkbox"/>, to save the changed settings. The display shows the next parameter <b>P-63</b>.</li> <li>– Press sensor button <input checked="" type="checkbox"/>, to interrupt the procedure. The display shows the selected parameter.</li> </ul> </li> </ul>

**Parameter descriptions**

Parameter	Description
P-63	<p>Select control of pump "local" or "Master-wireless connection module".</p> <p>This parameter can only be configured when two or more wireless connection modules are combined into a system and communicate with each other via radio frequency or BUS.</p> <ul style="list-style-type: none"> <li>• Factory settings:</li> <li>• Options                             <ul style="list-style-type: none"> <li>– 0: Pump output is configured as local pump. The pump will be switched on only when heating or cooling demand is caused by one of the channels of by the wireless connection module to which the pump is connected. The pump will not be switched on when demand is caused by another wireless connection.</li> <li>– 1: Only the pump output of the Master-wireless connection module is activated. When demand is caused by any channel at any wireless connection module then the pump connected to the Master wireless connection module will be switched on.</li> </ul> </li> </ul> <p><b>Operation</b></p> <ul style="list-style-type: none"> <li>▶ Press sensor button <input checked="" type="checkbox"/>. The display shows <b>0</b>.</li> <li>▶ Press sensor button <input checked="" type="checkbox"/> or <input checked="" type="checkbox"/>, to select option <b>0, 1, or 2</b>.</li> <li>▶ Select one of the following options:                             <ul style="list-style-type: none"> <li>– Press sensor button <input checked="" type="checkbox"/>, to save the changed settings. The display shows the next parameter <b>P-64</b>.</li> <li>– Press sensor button <input checked="" type="checkbox"/>, to interrupt the procedure. The display shows the selected parameter.</li> </ul> </li> </ul>
P-64	<p>Select NC or NO function of thermal actuators.</p> <p>Option "NC" (normally closed) should be selected for thermal actuators that open the valve when the actuator is connected to power. Option "NO" (normally open) should be selected for thermal actuators that close the valve when the actuator is connected to power.</p> <ul style="list-style-type: none"> <li>• Factory settings: Option "0"</li> <li>• Options                             <ul style="list-style-type: none"> <li>– 0: normally closed NC</li> <li>– 1: normally open NO</li> </ul> </li> </ul> <p><b>Operation</b></p> <ul style="list-style-type: none"> <li>▶ Press sensor button <input checked="" type="checkbox"/>. The display shows <b>0</b>.</li> <li>▶ Press sensor button <input checked="" type="checkbox"/> or <input checked="" type="checkbox"/>, to select <b>0 or 1</b></li> <li>▶ Select one of the following options:                             <ul style="list-style-type: none"> <li>– Press sensor button <input checked="" type="checkbox"/>, to save the changed settings. The display shows the next parameter <b>P-65</b>.</li> <li>– Press sensor button <input checked="" type="checkbox"/>, to interrupt the procedure. The display shows the selected parameter.</li> </ul> </li> </ul>

Parameter	Description
P-65	<p>Select control algorithm.</p> <p>For efficient temperature control one can select between three control algorithms and an optimized actuator control. For optimized actuator control see next parameter description P-66.</p> <p>The following control algorithms can be selected: On/Off-control, PWM control for heat pump in combination with surface heating with high inertia (slow systems) and PWM control for surface heating with medium inertia (medium-lag systems) e.g. convection with wall heating. To save energy the pump is released 2 minutes after demand detection.</p> <ul style="list-style-type: none"> <li>• Factory settings: 0</li> <li>• Options:           <ul style="list-style-type: none"> <li>– 0: On/Off-Control The heating will be switched on when the deviation between actual value and setpoint is larger than 0,5 K. The heating will be switched off when the deviation between actual value and setpoint is smaller than 0,5 K. On/Off-control is ideal for floor heating systems with higher supply water temperatures. The after run time of the pump control is 5 minutes.</li> <li>– 1: PWM-control with a period of 20 minutes. This control mode is ideal for floor heating in combination with a heat pump or with low supply water temperature. The after run time of the pump control is 20 minutes.</li> <li>– 2: PWM-control with a period of 12 minutes. This control mode is ideal for wall heating and low supply water temperatures. The after run time of the pump control is 12 minutes.</li> </ul> </li> </ul> <p><b>Operation</b></p> <ul style="list-style-type: none"> <li>▶ Press sensor button <input type="checkbox"/>. The display shows <b>0</b>.</li> <li>▶ Press sensor button <input type="checkbox"/> or <input type="checkbox"/>, to select option <b>0, 1</b> or <b>2</b>.</li> <li>▶ Select one of the following options:           <ul style="list-style-type: none"> <li>– Press sensor button <input type="checkbox"/>, to save the changed settings. The display shows the next parameter <b>P-66</b>.</li> <li>– Press sensor button <input type="checkbox"/>, to interrupt the procedure. The display shows the selected parameter.</li> </ul> </li> </ul>

## Parameter descriptions

Parameter	Description
P-66	<p>Activate or deactivate function "optimized actuator control".</p> <p>The optimized actuator control is a specially developed actuator control that saves energy. This control also replaces a quasi-proportional control.</p> <p>At the start the thermal actuator will receive a 100% signal for a certain period. After this heat up period the actuator receives pulse/pause signal that is depending on the ambient temperature, configured with the options of this P-66. This control yields a significant energy reduction.</p> <div style="border: 1px solid black; padding: 2px; width: fit-content; margin: 10px 0;">NOTE</div> <p>We recommend to deactivate the optimized actuator control at ambient temperatures below 10°C.</p> <ul style="list-style-type: none"> <li>• Factory settings: Option "0"</li> <li>• Options:             <ul style="list-style-type: none"> <li>– 0: deactivated, ambient temperature below 10 °C</li> <li>– 1: activated, ambient temperature between ca. 10 °C and 25°C</li> <li>– 2: activated, ambient temperature between ca. 25°C and 50°C</li> </ul> </li> </ul> <p><b>Operation</b></p> <ul style="list-style-type: none"> <li>▶ Press sensor button <input checked="" type="checkbox"/>. The display shows <b>0</b>.</li> <li>▶ Press sensor button <input type="checkbox"/> or <input type="checkbox"/>, to set option 0, 1 or 2.</li> <li>▶ Select one of the following options:             <ul style="list-style-type: none"> <li>– Press sensor button <input checked="" type="checkbox"/>, to save the changed settings. The display shows the next parameter <b>P-67</b>.</li> <li>– Press sensor button <input checked="" type="checkbox"/>, to interrupt the procedure. The display shows the selected parameter.</li> </ul> </li> </ul>
P-67	<p>Select controlled first start-up of floor heating.</p> <p>It is recommended to heat-up the floor slowly when a new floor heating system is installed.</p> <p>The heating up period takes 36 hours and is divided into three steps:</p> <ul style="list-style-type: none"> <li>• First step of 12 hours with a setpoint of 7 °C</li> <li>• Second step of 12 hours with a setpoint of 12 °C</li> <li>• Third step of 12 hours with a setpoint of 15 °C</li> </ul> <p>When the setpoint of the room temperature is reached, the valves will be closed.</p> <ul style="list-style-type: none"> <li>• Factory settings: Option "0"</li> <li>• Options:             <ul style="list-style-type: none"> <li>– 0: deactivate start-up-mode.</li> <li>– 1: activate start-up-mode.</li> </ul> </li> </ul> <p>When this parameter is selected this start-up-mode can only be deactivated with the wireless room thermostat or by resetting the wireless connection module. When power is interrupted the start-up-mode is stopped and will continue after the power connection has been restored.</p>



Parameter	Description
P-67 (continued)	<p><b>Operation</b></p> <ul style="list-style-type: none"> <li>▶ Press sensor button <input checked="" type="checkbox"/>. The display shows <b>0</b>.</li> <li>▶ Press sensor button <input checked="" type="checkbox"/> or <input type="checkbox"/>, to select option <b>0</b> or <b>1</b>.</li> <li>▶ Select one of the following options:                             <ul style="list-style-type: none"> <li>– Press sensor button <input checked="" type="checkbox"/>, to save the changed settings. The display shows the next parameter <b>P-61</b>.</li> <li>– Press sensor button <input checked="" type="checkbox"/>, to interrupt the procedure. The display shows the selected parameter.</li> </ul> </li> <li>▶ Press sensor button <input checked="" type="checkbox"/>. The display shows <b>P-60</b>.</li> </ul> <p>To stop the start-up-mode during execution or to deactivate before begin:</p> <ul style="list-style-type: none"> <li>▶ Press any button on the wireless room thermostat for 2 seconds.</li> <li>▶ The display changes into operation mode. The setpoint blinks..</li> <li>▶ Press sensor button <input type="checkbox"/>. The display shows the remaining running time of the start-up-mode. Press sensor button <input checked="" type="checkbox"/>, to change to the standard display.</li> <li>▶ Press sensor button <input checked="" type="checkbox"/>, to reduce the remaining running time. The start-up-mode is deactivated at 0 hours.</li> <li>▶ Press sensor button <input checked="" type="checkbox"/>. The display shows <b>no</b>.</li> <li>▶ Press sensor button <input checked="" type="checkbox"/> or <input type="checkbox"/>, to select option <b>no</b> or <b>yes</b>.                             <ul style="list-style-type: none"> <li>– Select option <b>no</b>, to continue the start-up-mode.</li> <li>– Select option <b>yes</b>, to confirm the interruption of the start-up-mode.</li> </ul> </li> <li>▶ Press sensor button <input checked="" type="checkbox"/>. The display shows the standard display.</li> </ul>

Table 19: Service menu – P-60 "Control parameters"

## 9 Cleaning and maintenance

**Cleaning** Clean the wireless room thermostat with a lint-free, dry cloth. Do not use abrasive or caustic cleaning agents.

**Maintenance** The wireless connection module and the wireless room thermostat do not require any maintenance.

## 10 Troubleshooting



The following tables describe possible problems and measures to remedy. Contact your installer for any issues, which can not be resolved with to the following description. See page 2.

### 10.1 Wireless connection module

Problem	Possible cause	Remedy	To be executed by
LED Fuse lights red	Fuse defect	<ul style="list-style-type: none"> <li>• Replace fuse (2 A T). → See page 102, chapter 13.2.2.</li> <li>• Check electrical connections.</li> </ul>	Electrician
LED CH blinks	No radio signal between wireless room thermostat and wireless connection module	<ul style="list-style-type: none"> <li>• Address wireless room thermostat to wireless connection module.</li> </ul>	Professional

Table 20: Troubleshooting wireless connection module

### 10.2 Wireless room thermostat

Problem	Possible cause	Remedy	To be executed by
	Battery almost empty.	Replace batteries.	User
bAtt	Battery critically low. Radio connection between wireless room thermostat and wireless connection module is no longer guaranteed.	Replace batteries immediately. → See also page 27, open wireless room thermostat.	User
 Err1 No radio signal between wireless room thermostat and wireless connection module for more than 30 minutes.	Power failure wireless connection module	Restore power supply. → See also page 92, chapter 10.2.1.	Electrician
	Fuse defect	<ul style="list-style-type: none"> <li>• Replace fuse (2 A T). → See page 104, chapter 13.3.2.</li> <li>• Check electrical connections.</li> </ul>	Electrician









Problem	Possible cause	Remedy	To be executed by
 Err2 No radio signal between wireless room thermostat in sensor mode and wireless connection module for more than 30 minutes.	Power failure wireless connection module	Restore power supply. → See also page 92, chapter 10.2.1.	Electrician
	Fuse defect	<ul style="list-style-type: none"> <li>• Replace fuse (2 A T). → See page 104, chapter 13.3.2.</li> <li>• Check electrical connections.</li> </ul>	Electrician
 Err3 Changed parameters can not be saved	Power failure wireless connection module	Restore power supply.	Electrician
	Fuse defect	<ul style="list-style-type: none"> <li>• Replace fuse (2 A T). → See page 104, chapter 13.3.2.</li> <li>• Check electrical connections.</li> </ul>	Electrician
 Err4 IR-Sensor defect	Battery too weak	Replace batteries	User
	IR-Sensor broken	Replace wireless room thermostat with IR-sensor.	Professional
 	Dew-point exceeded.	Check supply water temperature of cooling unit. If possible increase supply water temperature.	Professional
 Short-time display	Another wireless room thermostat is in the user or service menu.	Set one of the wireless room thermostats into sleeping mode by pressing the sensor button  .	Professional

Table 21: Troubleshooting wireless room thermostat

### 10.2.1 Procedure for ▲ Err1 or ▲ Err2

Once the display shows "▲ Err1" or "▲ Err2", the wireless room thermostat can no longer be assigned to a wireless connection module.

- ▶ Press the sensor buttons  and  of the wireless room thermostat for 10 seconds.
- ▶ After 5 seconds, the display "▲ Err 1" or "▲ Err2" goes out. The display shows the flashing symbols "----" and "Reset".
- ▶ A query appears after 10 seconds. Select the option **yes** to reset the wireless room thermostat to factory settings. Select the options **no** to cancel the process.

We recommend that you perform one of the following steps after resetting the wireless room thermostat to factory settings:

- Delete the associated channel at the wireless connection module.
- Perform a complete reset for the wireless connection module.

### 10.2.2 Procedure when "radio signal lost"

- ▶ Resolve problem according to page 91, Table 21.
- ▶ Execute following steps:
  - Press any sensor button of the wireless room thermostat for 2 seconds. The display changes to operation mode.
  - Wait until all wireless room thermostats have rebuilt the connection with the wireless connection module. This procedure takes at least one hour after power supply has been restored.

### 10.2.3 Replace batteries of wireless room thermostat

NOTE

---





*Use high quality alkaline batteries with a long lifetime in order to enjoy long and problem free operation of the wireless room thermostat.*

---

During battery replacement addressing and parameter settings remain stored. The radio connection and parameter settings are restored within 10 minutes after battery replacement.

- ▶ Open wireless room thermostat. → See also page 27
- ▶ Replace batteries. Dispose batteries environmental friendly!
- ▶ Close wireless room thermostat. → See also page 29, Fig. 13.

## 10.3 FAQs

FAQ	Note
The setpoint temperature cannot be set. The sensor buttons  and  do not react.	Check if the operating mode "Normal operation" has been selected. The setpoint temperature cannot be set in the operating modes "Off (frost protection)" and "Reduced operation". → See page 54, Kapitel 7.4.
The setpoint temperature cannot be set to the desired value.	The setting range is limited. → See page 70, parameter description P-03.
The wireless room thermostat shows only <b>SENS</b> and does not react any longer.	The sensor mode is active. <ul style="list-style-type: none"> <li>Press the wireless room thermostat sensor buttons  and  simultaneously for 10 seconds.</li> </ul>
Time and date is requested for every wireless room thermostat that is addressed.	During addressing of wireless room thermostats to a new connection module the input of time and date is prompted. This input can be skipped, however, with every next wireless room thermostat that is added the time and date prompt will pop-up until time and date are set. → See page 56, chapter 7.5.
Sensor buttons of the wireless room thermostat do not function properly.	Remove and replace the batteries. The wireless room thermostat executes a calibration of the sensor buttons automatically. Do not touch the sensor buttons during calibration. Alternatively, one can wait for 4 minutes until the next regular calibration has been executed. During this 4 minutes period the sensor buttons may not be touched.
Is it possible to show other values at the display than the room temperature?	Time or temperature can be selected. → See parameter description P-01, page 70.
Is it possible to deactivate the display?	Deactivate the display with parameter P-06, option "1". → See parameter description P-06, page 71.
How to correct the addressing of a wireless room thermostat?	It is possible to directly address a wrongly addressed wireless room thermostat to another channel. However, we recommend to delete the first connection before addressing to the new channel. → See page 48, chapter 7.1.5 and page 45, chapter 7.1.1.
How to find out which channels are already assigned to a zone?	Press the button <b>Zone</b> of wireless connection module once, twice, or three times. Each time the LEDs of the channels those are assigned to a zone light. → See page 50, chapter 7.2.
Is information lost during replacement of batteries?	Information is not lost during replacement of the batteries. Date is stored at the wireless connection module.
The pump does not switch off.	<ul style="list-style-type: none"> <li>One or more radio channels are configured as "by-pass".</li> <li>The wireless room thermostat is addressed to another channel.</li> <li>The wireless room thermostat is in emergency mode. No information is sent anymore. Press the relevant channel button on the wireless connection for 10 seconds. The corresponding LED goes off.</li> </ul>
The LED <b>CH</b> is not lit when the target value is set after addressing or commissioning.	<ul style="list-style-type: none"> <li>Check if addressing was performed correctly. → See page 48, chapter 7.1.4.</li> <li>If the LED CH at the wireless connection module flashes, perform addressing again. → See page 44, chapter 7.1.</li> </ul>
The temperature does not increase in heating mode.	<ul style="list-style-type: none"> <li>Check the operating mode. The operating mode "Off (frost protection)" may have been selected.</li> <li>Check the frost protection temperature set. → See page 75, parameter description P-32.</li> </ul>

## Waste disposal

FAQ	Note
The temperature does not drop in cooling mode.	Cooling has been switched off.
The display of the wireless room thermostat shows <b>Err1</b> .	The distance from the wireless connection module is too big. The radio connection has been lost. The display shows <b>Err1</b> until the radio connection is established automatically. This process may take up to 30 minutes.

Table 22: FAQs

## 10.4 Tips and tricks

Application	Description
Wall heating with "by-pass"-function	When using the system for wall heating we recommend not to use the "by-pass-function" of the wireless connection module, but to realize this with special piping and separate valve.
Transfer of C/O-Signal	In case that the C/O signal between wireless connection modules is wired, we advice to connect the C/O output of the master wireless connection module to the C/O-input of the slave wireless connection module. If this C/O-signal is wired parallel with further wireless connection modules, then polarity of the wiring has to be correct.
Floor heating temperature monitoring.	At cooling the min. of the min / max configuration may not be used as dew-point monitor.

Table 23: Tips and tricks

## 11 Waste disposal

**ATTENTION**
**Danger to the environment through improper disposal!**

Improper disposal of the wireless room thermostat, the wireless connection modules or accessories may cause damage to the environment.

- Don't dispose batteries with household waste.
- Don't dispose the wireless connection module and the wireless room thermostat with household waste.
- Dispose the wireless connection modules and wireless room thermostat in accordance with the appropriate country-specific regulations.

## 12 Accessories

### 12.1 Active Antenna

To improve the transmission of a wireless connection module, e.g. when the wireless connection module is installed in a metal cabinet, an active antenna can be installed. → See page 21, Fig. 4.

The active antenna does not require any external power supply. It is provided via the included communication cable from the wireless connection module. A communication cable with a length of five meters and an RJ12 plug on either end is included in the delivery.

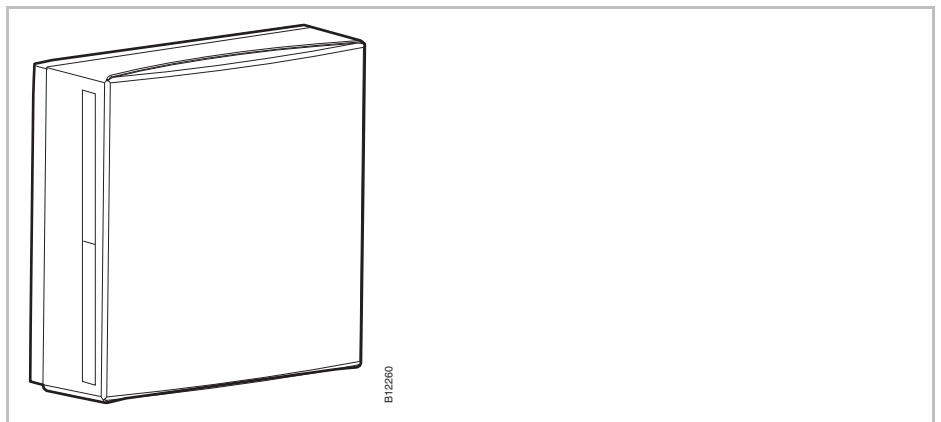

Fig. 39: Active antenna

**NOTE**

*The active antenna does not require any addressing. Once the antenna is connected to the wireless connection module via the mains cable, the internal antenna of the wireless connection module is deactivated and the external active antenna assumes the function.*

## 12.2 Repeater

### Function repeater

If a radio connection between the wireless connection module and room thermostat or between wireless connection modules cannot be achieved, you may use a repeater. This leads to a larger range between the radio devices.

The repeater automatically assigns the required information to the wireless connection module via the radio connection. This requires a 230 V/5 V power supply. A plug-in mains adapter is included in the delivery.

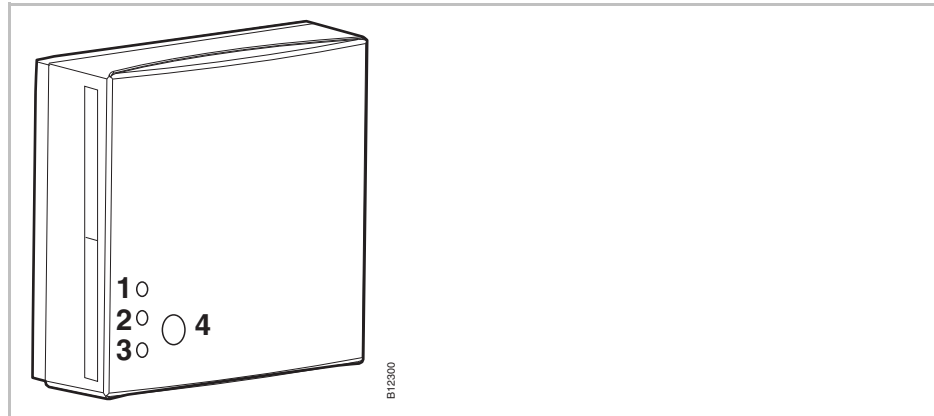

Fig. 40: Repeater

- 1 Red LED: Radio connection with the wireless connection module no longer present
- 2 Yellow LED: Display radio connection
- 3 Green LED: Display power supply
- 4 Push button for addressing

### Radio room operating network and system network

No more than one repeater can be integrated into a radio room operating network or system network (wireless connection module). All room operating devices, room sensors or other accessories can transmit signals to the wireless connection module via the repeater in a radio room operating network. Only the two wireless connection modules "Slave" can transmit signals to the wireless connection module "Master" in a system network.

NOTE

*If the radio connection has been lost, all LEDs at the repeater are lit.*



## 12.2.1 Assign a room thermostat to the repeater

A repeater should be assigned to a room thermostat or several room thermostats.

**NOTE**

*Within a radio room operating network, a repeater has to be assigned to only one room operating device. The other room operating devices are usually recognised automatically.*

*If a room operating device has a radio connection to the wireless connection module via the repeater, the room thermostat always radios via the repeater, even if the room thermostat would reach the wireless connection module without the repeater.*

*Once a repeater is no longer in operation, e.g. from interruption of the power supply, the associated room thermostats automatically try to establish a radio connection to the wireless connection module after 30 minutes. The display shows **Err1**. If the direct radio connection to the wireless connection module can be created, repeater addressing is deleted. If the radio connection is to be via the repeater again, you need to assign the repeater to a room thermostat again. → For the display **Err1**, see page 93, chapter 10.3.*

The room thermostat is already installed at the final site.

The display of the wireless room thermostat shows the symbols "----". Since the distance to the wireless connection module is too far, the room thermostat cannot be assigned to the wireless connection module. The room thermostat is to be assigned to the radio channel CH 1.

- ▶ Press push button **CH 1** on the wireless connection module. The corresponding LED **CH 1** blinks.
- ▶ Remove the covers of the repeater.
- ▶ Place the repeater between the wireless connection module and room thermostat.
- ▶ Plug the USB mains plug into the repeater.
- ▶ Connect mains unit.
- ▶ Press the push button at the repeater for 5 seconds. The green LED at the repeater blinks.
- ▶ Press the sensor buttons  and  of the room thermostat for 5 seconds simultaneously. The green and yellow LEDs at the repeater light up. The LED **CH 1** at the wireless connection module lights up.
- ▶ After 5 seconds, the LED **CH 1** goes out. If there is a need, the LED **CH 1** continues to be lit.

The display of the wireless room thermostat is activated (operation mode). The symbol  is shown and the setpoint is blinking. The setpoint can be changed.

The radio channel CH 1 is assigned a room thermostat. The repeater can be firmly installed.



**NOTE**

*The maximum distance between repeater and wireless connection module is 40 m.*

---

### 12.2.2 Test the repeater's radio connection

Perform the following steps to find out whether the radio connection to the wireless connection module is running via the repeater and whether the wireless connection module and the room thermostat are assigned correctly.

- ▶ The display of the wireless room thermostat shows the symbol . The room thermostat is assigned to a wireless connection module.
- ▶ Press the sensor buttons  and  of the room thermostat for 5 seconds simultaneously. The display of the wireless room thermostat shows "Pair" – "Test" as long as the LED of the wireless connection module is lit. The yellow LED at the repeater goes out and the green LED blinks quickly.
- ▶ On the wireless connection module the LED of the assigned channel is lit. If the wireless room thermostat is assigned to more than one channel then all assigned channel LEDs are lit.
- ▶ The LED goes out or the LEDs go out after 5 seconds

The addressing has been tested.

**NOTE**

*When the green LED at the repeater blinks fast during the test, radio connection from room thermostat to wireless connection module via repeater is established properly.*

*When the green LED at the repeater lights, a direct radio connection between room thermostat to connection module exists. The room thermostat is placed in the wireless connection module's range.*

---

### 12.2.3 Delete the repeater's radio connection

- ▶ Press the push button at the repeater for 10 seconds.
- ▶ After a short time, the yellow LED goes out. The green LED starts to blink. After another 5 seconds, all LEDs will blink.
- ▶ Delete all LEDs at the repeater. The green LED lights up again after a moment.

The addressing is deleted. You may re-address the repeater.

## 12.2.4 Assign the repeater to a wireless connection module

The system comprises a wireless connection module "Master" and two or three wireless connection modules "Slave". Since the distance is too far, the wireless connection modules "Slave" cannot be assigned to the wireless connection module "Master".

- ▶ Press push button **System** of the wireless connection module "Master" until the LED **System** blinks.
- ▶ Remove the covers of the repeater.
- ▶ Place the repeater between the wireless connection module "Master" and the wireless connection modules "Slave". The maximum distance between repeater and wireless connection module is 30 m.
- ▶ Plug the USB mains plug into the repeater.
- ▶ Connect mains unit.
- ▶ Press the push button at the repeater for 5 seconds. The green LED at the repeater blinks.
- ▶ Press push button **System** of the wireless connection module "Slave" until the LED **System** blinks. The green and yellow LEDs on the repeater light up.
- ▶ At successful addressing:
  - the LED **System** of the wireless connection module "Slave" lights up.
  - the LED **System** of the wireless connection module "Master" changes from blinking to off.
  - the LED **System** of the wireless connection module "Master" lights up as soon as the first communication with the wireless connection module "Slave" has been built up.

NOTE

*If the red LED starts to blink during addressing, the wireless connection module does not answer. The distance between repeater and wireless connection module may be too large.*

## 12.2.5 Test addressing of the wireless connection modules "Slave" and "Master"

If the LED **System** is lit on the wireless connection modules "Slave" and "Master" each, the wireless connection module "Slave" is assigned to a wireless connection module "Master". If the LED **System** is not lit, this wireless connection module is too far away from the repeater.

NOTE

*No further tests are required. If required, check the addressing by installing a jumper across terminals 09 and 10 (C/O input) at the wireless connection module "Master". The wireless connection module "Master" will switch to cooling mode and forward the signal to the wireless connection module "Slave". After no more than 3 minutes, the LED "Cool" will light up blue.*

### 12.2.6 Check repeater assignment

Perform the following step to check if a repeater is assigned to a room operating network or a system network.

- ▶ Press the push button at the repeater briefly.
  - If the green LED is lit, the repeater is connected to the room operating network.
  - If the yellow LED is lit, the repeater is connected to the system network.

### 12.2.7 Repeater and radio connection to the wireless connection module

If the red LED is lit on the repeater in addition to the green and the yellow ones, the connection to the wireless connection module has been lost. Check the following items:

- Is the wireless connection module supplied with voltage? The green LED Power must be lit.
- Is the microfuse of the wireless connection module OK? A defective microfuse is displayed by the red LED.
- For system networks: Was a reset performed via the "Master" radio control? The LED "Master" is not lit at a reset.

NOTE
------

---

*A blinking yellow LED at the repeater signals that the radio connection quality is at its threshold. This can be due to the distance between repeater and wireless connection module or due to interferences like metal, etc. We recommend that the repeater be placed closer to the wireless connection module or to remove interferences.*

---

### 12.2.8 Deactivate LEDs at the repeater

If you are bothered by the LEDs being lit, you can switch off the LEDs as follows.

- ▶ Remove the covers of the repeater.
- ▶ There is a push button in the upper area of the PCB. Keep this push button pressed for 5 seconds. The LEDs go out.
- ▶ Install the cover of the repeater.

## 13 Technical data

### 13.1 Radio system

Radio frequency	868 MHz (coded)
Transmission rate	50 kbit/s
Direction	Bidirectional
Reach	<ul style="list-style-type: none"> <li>• 40 m in "normal housings" or detached houses, depending on environment</li> <li>• 200 to 300 m in free field, depending on obstacles, surfaces, local disturbances</li> </ul>
Standards	<ul style="list-style-type: none"> <li>• Radio: EN 300220</li> <li>• RTTE-Immunity: EN 301489-3</li> <li>• RTTE-Radiation: EN 300220-3</li> </ul>
Power reserve internal timer	24 hours after the complete charging time of 6 hours

### 13.2 Wireless connection module

#### 13.2.1 Construction and dimensions

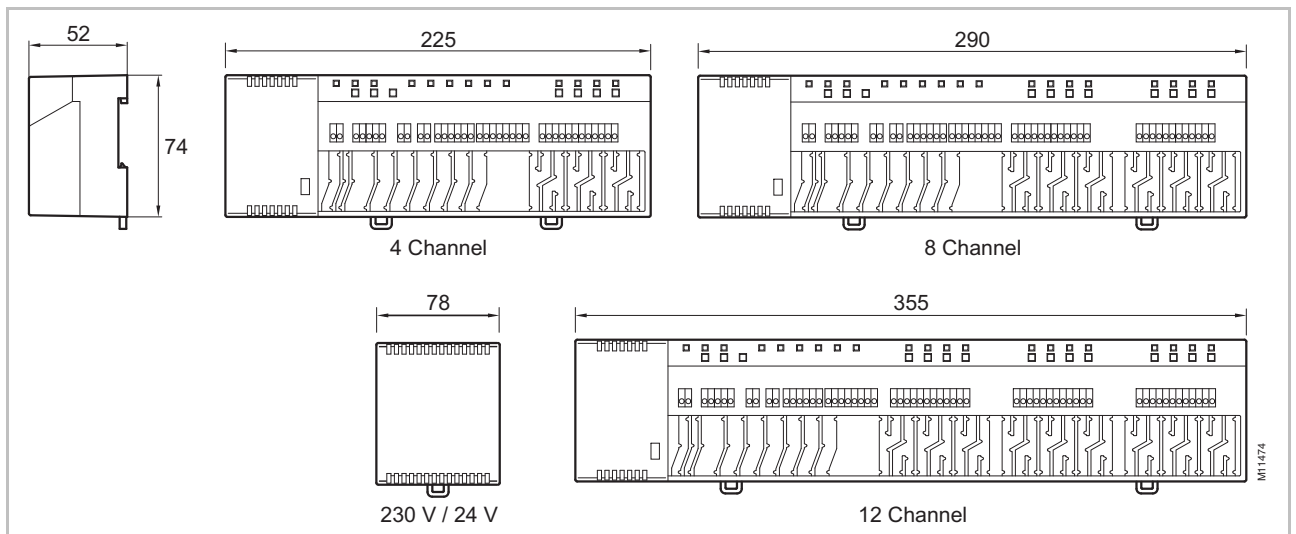

Fig. 41: Dimensions wireless connection module with transformer (all dimensions in mm)

## Technical data

Dimensions(width x height x depth)	<ul style="list-style-type: none"> <li>• 4-channel: 225 mm x 74 mm x 52 mm</li> <li>• 8-channel: 290 mm x 74 mm x 52 mm</li> </ul>
Dimensions connection module without transformer	<ul style="list-style-type: none"> <li>• 12-channel: 355 mm x 74 mm x 52 mm</li> <li>• Transformer: 78 mm x 74 mm x 52 mm</li> </ul>
Weight incl. transformer	<ul style="list-style-type: none"> <li>• 4-channel: 1.3 kg</li> <li>• 8- channel: 1.5 kg</li> <li>• 12- channel: 1.7 kg</li> </ul>
Cable retention	Meander shape
Monitoring	LEDs

### 13.2.2 Electrical connections

Power supply wireless connection module	24 V AC $\pm$ 15% via separate 230 V/24 V 50/60 Hz transformer
Fuse protection	2 A T (Type ELU 179120, manufacturer Siba)
Power source 24 V	External transformer with cable 230 V AC
Power consumption at 24 V, transformer included, without thermal actuators, 4-, 8- or 12-channel version	2.6 W
Power consumption in operation	<ul style="list-style-type: none"> <li>• 4-channel: max. 27 W</li> <li>• 8-channel: max. 40 W</li> <li>• 12-channel: max. 60 W</li> </ul> <p>Power consumption is depending on the number of actuator that is connected.</p>
Max. current at stand-by	200 mA / 250 mA
Max. number of thermal actuators	<ul style="list-style-type: none"> <li>• 4-channel: 6 (2 channels / 2 actuators, 2 channels / 1 actuator)</li> <li>• 8-channel: 12 (4 channels / 2 actuators, 4 channels / 1 actuator)</li> <li>• 12-channel: 18 (6 channels / 2 actuators, 6 channels / 1 actuator)</li> </ul>
Protection class	II (EN60730)

### 13.2.3 Inputs

C/O	Contact recognition, low voltage from wireless connection module
Eco (N/R)	Contact recognition, low voltage from wireless connection module
Dew-point monitoring	Contact recognition, low voltage from wireless connection module
C/O in-/TB-input	General input 24 to 230 V

### 13.2.4 Outputs

Max. number of thermal actuators	<ul style="list-style-type: none"> <li>• 4-channel: 6 (2 channels / 2 actuators, 2 channels / 1 actuator)</li> <li>• 8-channel: 12 (4 channels / 2 actuators, 4 channels / 1 actuator)</li> <li>• 12-channel: 18 (6 channels / 2 actuators, 6 channels / 1 actuator)</li> </ul>
Outputs for thermal actuators	<ul style="list-style-type: none"> <li>• 24 V Triac-outputs</li> <li>• NO (normally open) / NC (normally closed), configurable</li> <li>• PWM- or On/Off-control</li> <li>• Shortcut protected</li> </ul>
Configurable output for C/O or burner start	<ul style="list-style-type: none"> <li>• 230 V / 2.5 A, 1 A inductive</li> <li>• Potential free</li> <li>• Without time delay and after-run time</li> </ul>
Relays for pump output	<ul style="list-style-type: none"> <li>• 230 V / 2.5 A, 1 A inductive</li> <li>• Potential free</li> <li>• 2 min delay (configurable)</li> <li>• 30 s after-run time (configurable)</li> </ul>

### 13.2.5 Performance data

Data transmission	<ul style="list-style-type: none"> <li>• Room control network: max. 10 min</li> <li>• System network: max. 3 min</li> </ul>
Transmission power	< 13 mW

### 13.2.6 Environmental conditions

Ambient temperature	0 to +55 °C
Ambient humidity	5 to 80 % r.F.
Storing and transport temperature	-25 to +60 °C
Degree of protection	IP 20 (EN 60529)

**Technical data**

**13.3 Wireless room thermostat**

**13.3.1 Construction and dimensions**

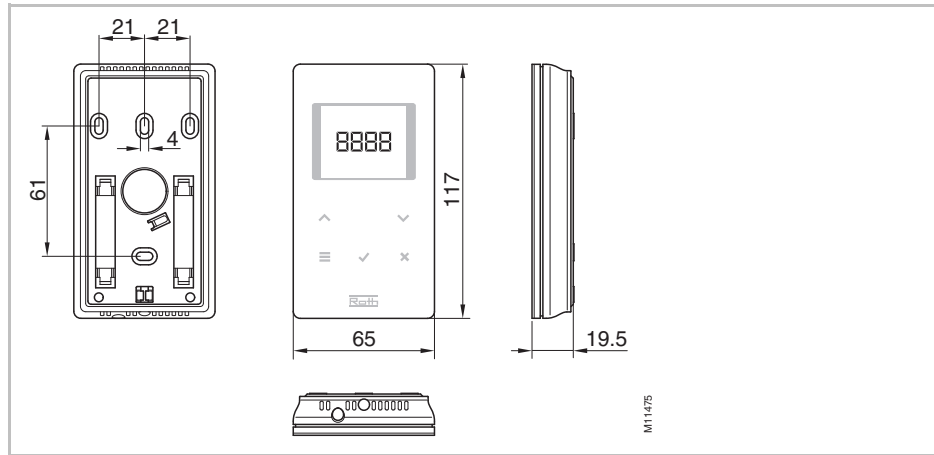

Fig. 42: Dimensions wireless room thermostat (all dimensions in mm)

Dimensions(width x height x depth)	65 x 117 x 19.5 mm
Weight	0.11 kg
Display	<ul style="list-style-type: none"> <li>• TFT LCD, black on grey, 76 Symbols</li> <li>• Dimensions: 32 mm x 38 mm</li> </ul>

**13.3.2 Power supply – Battery**

Battery	2 x 1.5 V AAA
Battery lifetime	> 1.5 years
Fuse protection	2 A T (Type ELU 179120, manufacturer Siba)
Protection class	III (EN 60730)

**13.3.3 Power supply – 230 V AC**

Power supply	230 V AC ± 10 %
Power consumption in operation	1.7 VA
Power consumption Stand-by	0.13 W
Protection class	II (EN 60730)



### 13.3.4 Performance data

Setting range setpoint	+5 to +30 °C
Accuracy (resolution)	±0,1 K/±0,5 K
Cycle time	Ca. 10 min
Dead-time	Ca. 50 s
Transmission interval	<ul style="list-style-type: none"> <li>• 1 ... 10 min</li> <li>• 1 min after change of setpoint or mode of operation</li> <li>• 10 min for transmission of / 2 ... 10 min</li> </ul>
Activation time (wake-up time)	< 2 s
Max. forced refresh time of data wireless connection module	10 s
Sleeping mode	<ul style="list-style-type: none"> <li>• Without operation: after max. 5 s</li> <li>• After programming at user level: 30 s</li> <li>• After programming at service level: 20 min</li> </ul>

### 13.3.5 Environmental conditions

Ambient temperature	0 to +55 °C
Ambient humidity	5 to 80 % r.F.
Storing and transport temperature	-25 to +60 °C
Degree of protection	IP 20 (EN 60529)



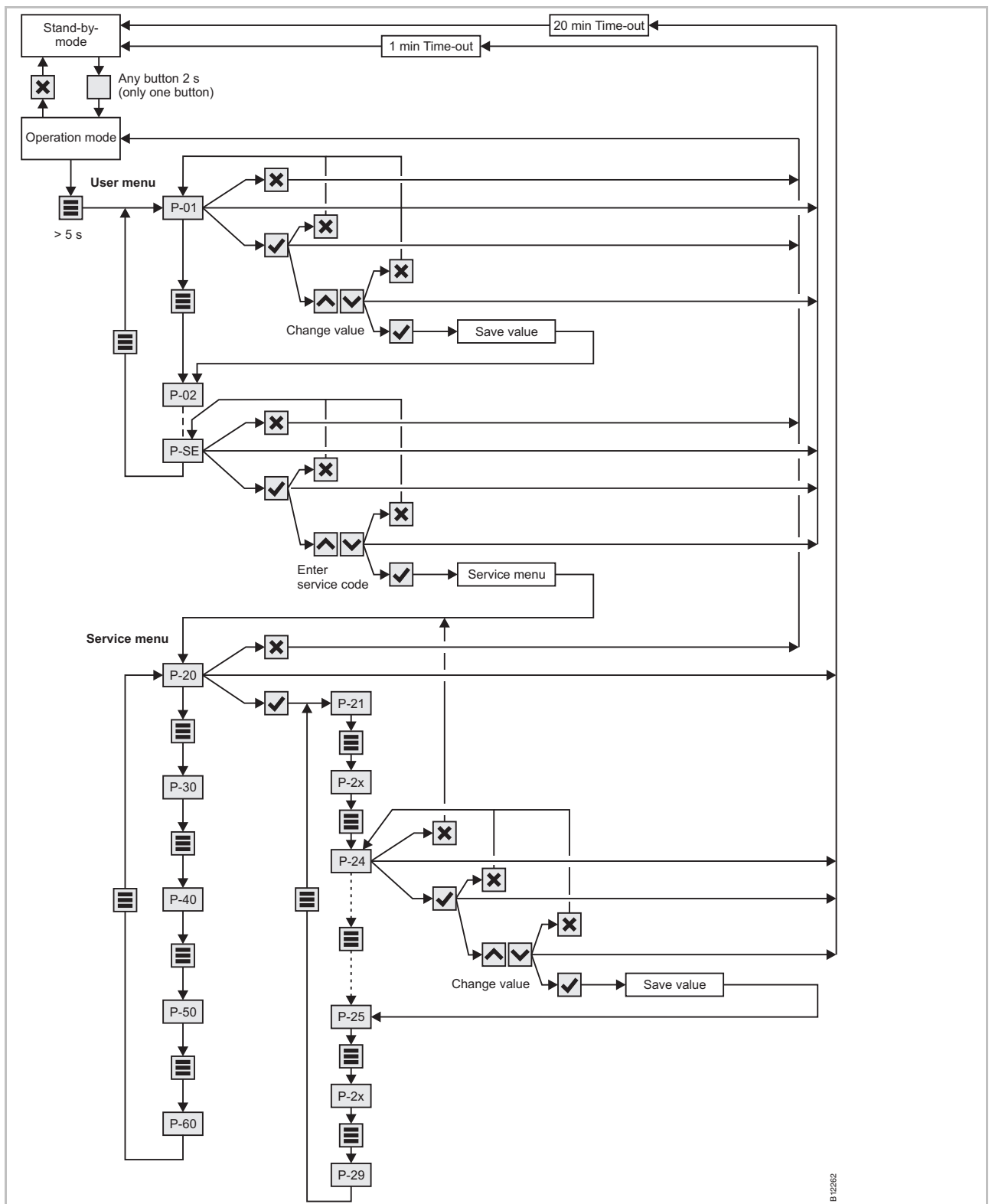

Fig. 44: Menu structure parameter settings for user and service level

# 15 Plant examples and communication

## 15.1 Plant examples with one wireless connection module

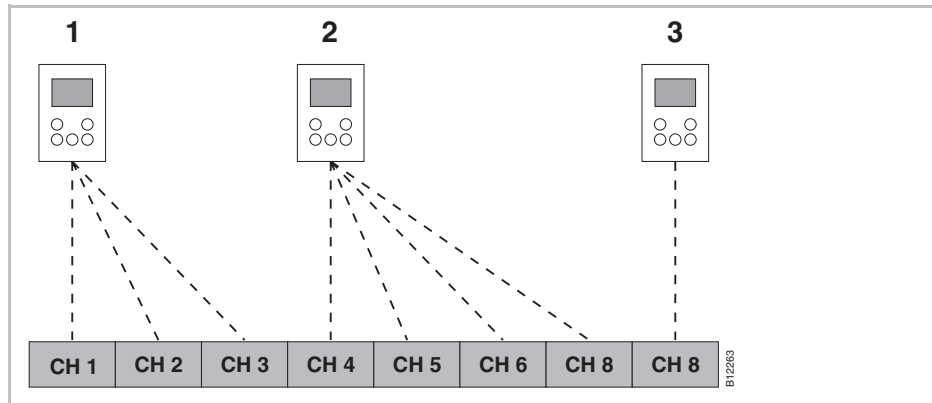

Fig. 45: Radio channel group with equal priority

- 1 Radio channel group 1
- 2 Radio channel group 2
- 3 Single addressing
- CH 1...CH 8: radio-channels

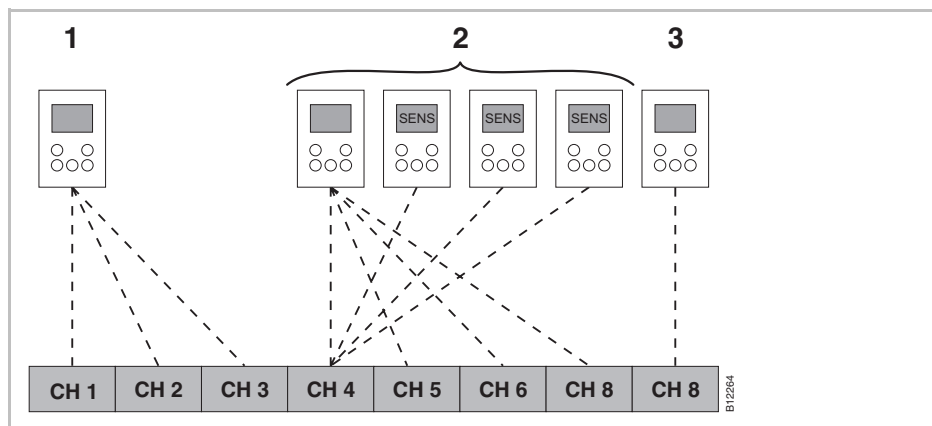

Fig. 46: Radio channel groups with equal priority and average temperature building

- 1 Radio channel group 1
- 2 Radio channel group 2 with average temperature building
- 3 Single addressing
- CH 1...CH 8: radio-channels
- SENS: wireless room thermostat Sensor mode, → see page 46, chapter 46.

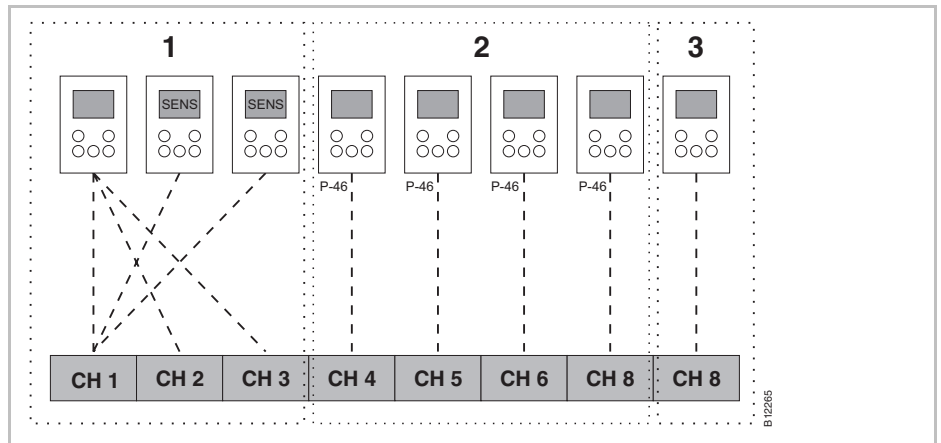

Fig. 47: Radio channel groups with zone building

1 Zone 1 with average temperature building

2 Zone 2 with setpoint sharing

3 Zone 3

CH 1...CH 8: radio-channels

Setpoint sharing → see page 80, parameter P-46.

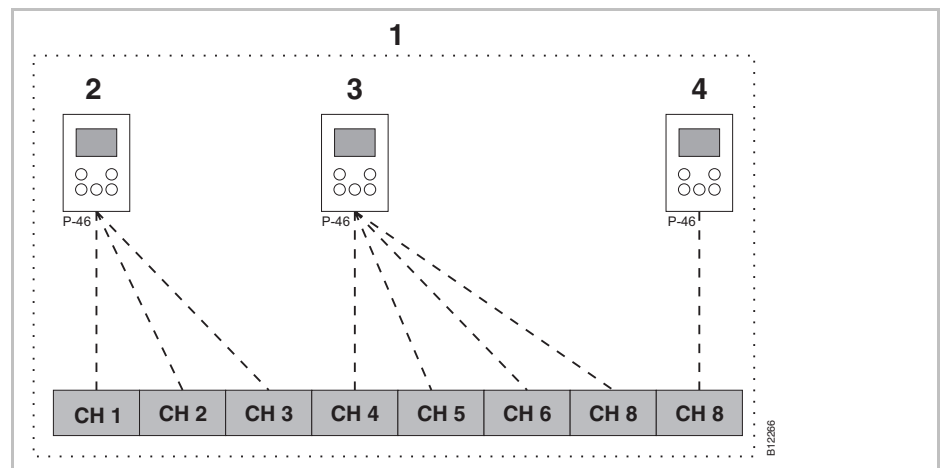

Fig. 48: Setpoint sharing for all wireless room thermostat within one zone

1 Zone 1 with setpoint sharing

2 Radio channel group 1

3 Radio channel group 2

4 Single addressing

CH 1...CH 8: radio-channels

Setpoint sharing, → see page 80, parameter P-46.

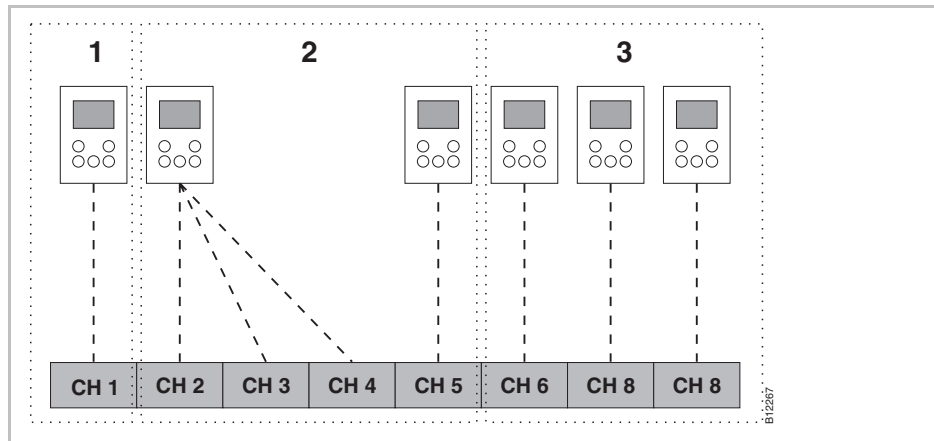

Fig. 49: Wireless room thermostat as "Master" for changing mode of operation – Wireless room thermostat as "Master" with own zone.

- 1 Zone 1 Wireless room thermostat as "Master"
- 2 Zone 2
- 3 Zone 3
- CH 1...CH 8: radio-channels
- Master function → see page 81, parameter P-48.

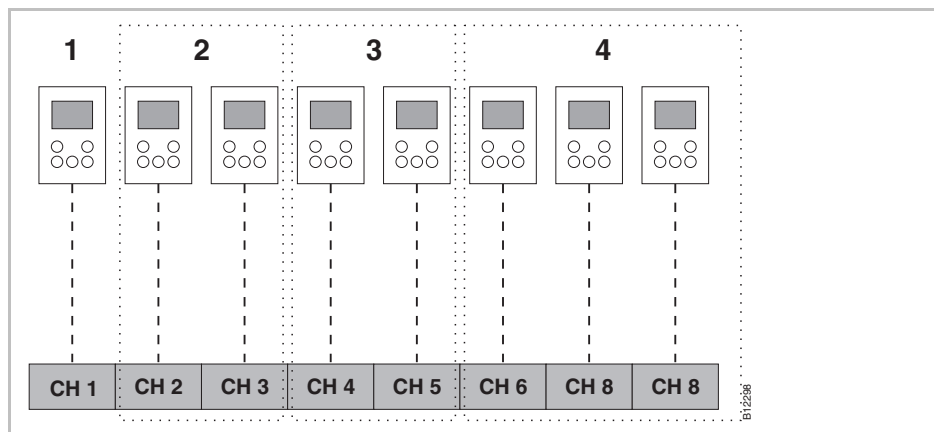

Fig. 50: Wireless room thermostat as "Master" for mode of operation – wireless room thermostat outside the zones

- 1 Wireless room thermostat as "Master", outside the zones
- 2 Zone 1
- 3 Zone 2
- 4 Zone 3
- CH 1...CH 8: radio-channels
- Master function → see page 81, parameter P-48.

## 15.2 Plant examples with up to three wireless connection modules

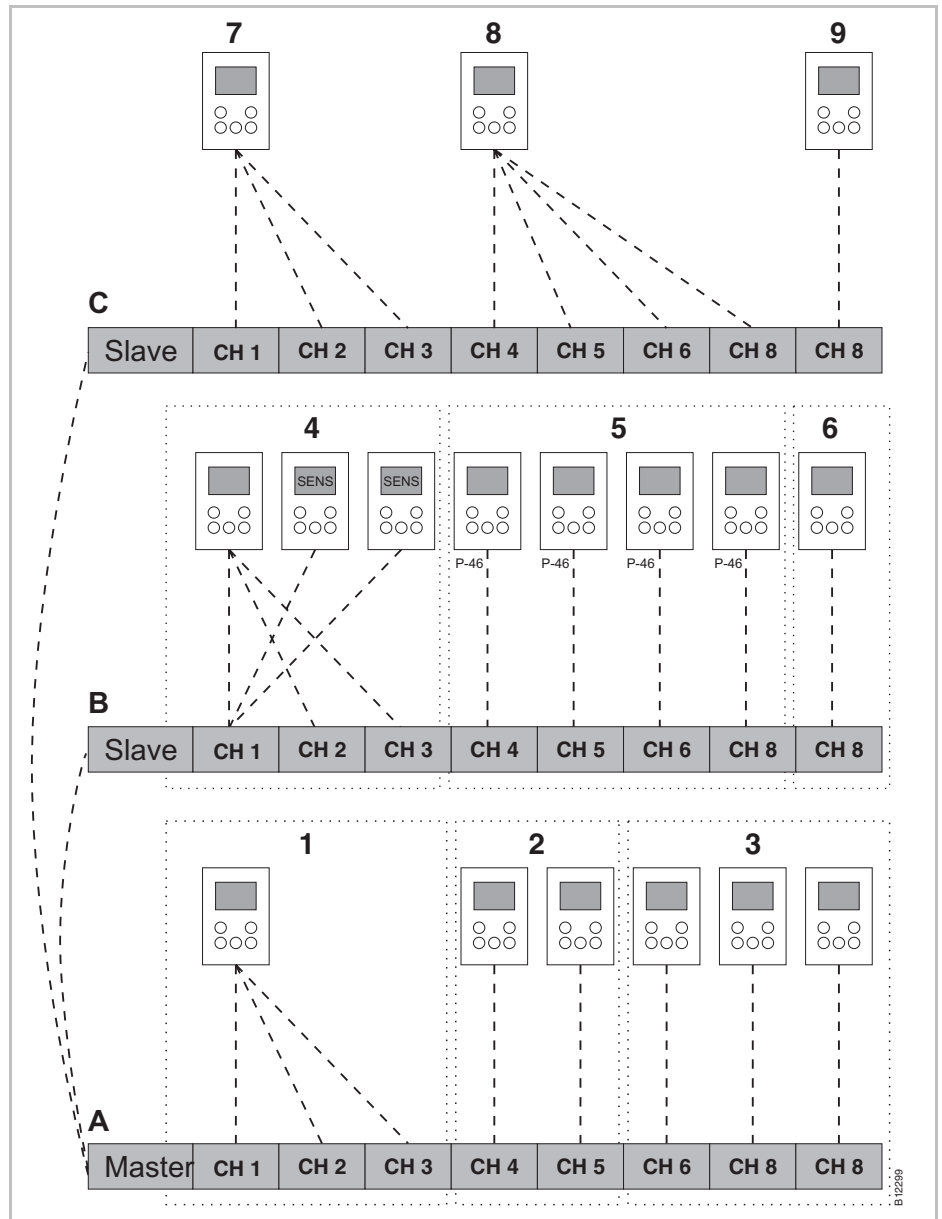

Fig. 51: Example with three wireless connection modules

A Basement

1 Zone 1, basement

2 Zone 2, basement

3 Single addressing

B 1. Floor

4 Zone 1 with average temp. building

5 Zone 2 with setpoint sharing

6 Zone 3

C 2. Floor

7 Radio channel group 1

8 Radio channel group 2

9 Single addressing

CH 1...CH 8: radio-channels

## 16 Reset radio system to factory settings

With the following procedure the wireless room thermostat and the relevant wireless connection module can be reset to factory settings.

- ▶ Reset all wireless room thermostats that are assigned to the wireless connection module with parameter P-24, option "4" to factory settings.  
→ See page 74, parameter description P-24, option "4".
- ▶ Press push buttons **Master** and **System** of the wireless connection module simultaneously for 10 seconds.
- ▶ The LED **Power** of the wireless connection module goes off.
- ▶ The radio system is reset to factory settings as soon as the LED **Power** is off.



## Index

<b>A</b>	
Accessories	
Active antenna.....	95
Repeater.....	96
Type designation.....	16
Active antenna.....	95
Addressing.....	44
Delete.....	48
Delete addressing between wireless connection modules.....	49
Different combinations of addressing.....	44
One thermostat to one channel.....	45
One thermostat to several channels.....	45
Sequence of addressing.....	45
Several thermostats to one channel.....	46
Test.....	48
Test addressing between wireless connection modules.....	49
Tip – more than 20 room devices?.....	44
Wireless connection modules to each other.....	49
Anti-blocking function.....	19
Area of application.....	11
<b>B</b>	
bAtt.....	90
Batteries	
Insertion.....	29
Replace.....	92
Burner start output	
Electrical connections.....	40
Bus communication between connection modules (P-53).....	83
By-pass heat pump (P-45).....	80
<b>C</b>	
C/O-input.....	41
C/O-output	
Electrical connections.....	40
C/O-signal.....	38
Change setpoints.....	53
Changes.....	12
Cleaning.....	89
Code	
Access code public spaces (P-36).....	77
Service menu (P-35).....	77
Commissioning.....	44
Set time and date.....	56
Communication.....	108
Configure C/O in-/TB input.....	85
Connect pump.....	37
Connect transformer.....	36
Connect wires.....	35
Connection	
LAN.....	42
Connection diagram.....	34
Connections	
Central plant devices to master.....	50
Cooling lock (P-45).....	80
Cooling mode.....	19
Copyrights.....	10
Customer service.....	10
<b>D</b>	
Date	
Set time and date.....	56
Dead-zone heating/cooling (P-34).....	76
Delete	
Channel from zone.....	52
Zones.....	52
Design	
Wireless connection module.....	17
Wireless room thermostat.....	18
Dew-point input.....	41
Display	
Wireless room thermostat.....	25
Display elements	
Wireless room thermostat.....	23

## Index

<b>E</b>	
eco-indicator .....	64
eco-indicator	
Energy efficiency .....	64
Eco-input .....	40
Electrical connections .....	32
Burner start output .....	40
C/O-output .....	40
Connect wires .....	35
Heat pump .....	38, 41
Pump .....	37
Thermal actuators .....	37
Transformer .....	36
Wireless room thermosta 230 V version .....	30
Wireless room thermostat 230 V version .....	31
Electricians .....	13
Emergency mode .....	9, 19
Energy efficiency	
eco-indicator .....	64
Measures to increase energy efficiency .....	64
Energy saving mode .....	19
Err1 .....	90, 92
Err2 .....	91, 92
Err3 .....	91
Err4 .....	91
Explanation of symbols .....	8
<b>F</b>	
FAQs .....	93
First start-up of floor heating (P-67) .....	88
Floor temperature control with IR .....	20
Floor temperature correction (P-42) .....	78
Frost protection temperature (P-32) .....	75
Function .....	18
<b>H</b>	
Health hazards .....	13
Heat pump .....	38, 41
Hotel function (P-47) .....	81
<b>I</b>	
Identification .....	15
<b>ID-number</b>	
Wireless connection module (P-09) .....	71
Wireless room thermostat (P-08) .....	71
Improper use .....	12
Increment room temperature setpoint (P-31) .....	75
Indended use .....	12
<b>Installation</b>	
Wireless connection module .....	26
Wireless room thermostat .....	27
Wireless room thermostat 230 V-version .....	30
<b>L</b>	
LAN connection .....	42
LED description .....	22
<b>LEDs</b>	
Wireless connection module .....	21
Limitation of liability .....	9
<b>Lock operation</b>	
Wireless room thermostat .....	64
Lost radio connection .....	48
<b>M</b>	
Maintenance .....	89
Master wireless room thermostat (P-48) .....	81
<b>Material numbers</b>	
Dew-point monitor .....	41
Wireless connection module .....	15
Wireless room thermostat .....	16
Max. floor temperature (P-43) .....	79
Menu structure .....	106
Operation .....	106
Parameter setting user and service level .....	107
<b>Mode of operation</b>	
Select .....	54
Modifications .....	12
<b>Monitoring elements</b>	
Wireless connection module .....	21
<b>N</b>	
<b>N/R input</b>	
Configure (P-61) .....	84
Name plate .....	15
<b>NC actuators</b>	
Select (P-64) .....	86

NO actuators	
Select (P-64).....	86
Notes	
Accredited countries.....	11
Address thermostats before building zones ..	51
Antenna addressing .....	95
Central plant devices connected to master connection module .....	50
Change dead-zone during heating only .....	76
Change heating/cooling with room thermostat .....	55
Deactivate optimized actuator control below 10 °C .....	88
Definition switched-on period and switching point.....	57
Display value setpoint reduced .....	58
Efficient support.....	10
Function test radio connection between connection modules.....	49
How to detect that no zones are built.....	52
Inactive sensor buttons in sensor mode.....	47
Information regarding software updates.....	66
Intellectual property rights .....	10
Limitation 24V output voltage .....	36
Lost radio connection .....	48
Manual override of time programs .....	55
Meaning of OFF during programming time programs.....	58, 62
More than 20 room devices?.....	44
No by-pass for systems with possible high temperatures .....	80
Operating mode Off (frost protection) .....	55
PowerLAN .....	26
Repeater all LEDs .....	96
Repeater green LED .....	98
Repeater maximum distance.....	98
Repeater red LED .....	99
Repeater wireless connection modules Slave and Master .....	99
Repeater, radio connection .....	97
Repeater, test radio connection .....	98
Repeater, yellow LED blinks .....	100
Reset of sensor mode .....	47
	Rules for removing switched-on periodes .....
	63
	Sequence addressing channels .....
	45
	Sequence of switching points .....
	60
	Set master before assigning thermostats.....
	49
	TB input does not protect by-pass channels ..
	85
	Tips – Sensor mode .....
	46
	Use high quality alkaline batteries.....
	92
<b>O</b>	
On/Off control .....	19
Select PWM control (P-65).....	87
Operating elements	
Wireless connection module.....	21
Wireless room thermostat.....	23
Operation .....	44
Modes of operation .....	54
Operation mode wireless room thermostat.....	25
Optimized actuator control.....	20
Optimized actuator control (P-66 ).....	88
Optimized time program (P-52) .....	82
Overview time programs.....	57
<b>P</b>	
Parameter descriptions.....	67
Parameter overview.....	67
Part numbers of product range.....	15
Professionals .....	13
Public spaces (P-47).....	81
Pump connection .....	18
Push buttons description	
Wireless connection module.....	21
PWM control .....	19
Select PWM control (P-65).....	87
<b>R</b>	
Radio communication between connection modules (P-53).....	83
Radio system	
Reset to factory settings .....	112
Reduced mode .....	19
Reduction of room temperature (P-44).....	79
Repeater .....	96

## Index

Reset	
Parameter .....	65
Radio system .....	112
Time program .....	63
Reset to factory settings .....	65
Room temperature control .....	19
<b>S</b>	
Safety .....	12, 13
Electrical connections .....	32
Scope of supply .....	10
SD-card	
Software-Update .....	66
Select	
Mode of operation .....	54
Parameter group .....	72
Sensor button	
Sound on/off (P-07) .....	71
Wireless room thermostat .....	23
Sensor buttons	
Lock operation .....	64
Unlock operation .....	64
Sensor mode .....	46
Condition for reset .....	47
Sequence	
Addressing .....	45
Building zones .....	51
Switching points .....	60
Service code .....	72
Service menu .....	72
Access code public spaces (P-36) .....	77
By-pass heat pump (P-45) .....	80
Configure burner start (P-51) .....	82
Configure C/O in-/TB input (P-61) .....	85
Configure N/R (eco) input (P-61) .....	84
Cooling lock (P-45) .....	80
Dead-zone heating/cooling (P-34) .....	76
Enter service menu .....	72
First start-up of floor heating (P-67) .....	88
Floor temperature correction (P-42) .....	78
Frost protection temperature (P-32) .....	75
Increment room temperature setpoint (P-31) .....	75
Lock for hotel function (P-47) .....	81
Lock for public spaces (P-47) .....	81
Master wireless room thermostat (P-48) .....	81
Max. floor temperature (P-43) .....	79
Optimized actuator control (P-66) .....	88
Optimized time program (P-52) .....	82
Overview .....	67
P-20 – General parameters .....	67, 73
P-30 – For all room thermostats .....	68, 75
P-40 – For individual room thermostats .....	68, 78
P-50 – Plant and topology related .....	68, 82
P-60 – Control parameters .....	69, 84
Reduction of room temperature (P-44) .....	79
Reset to factory settings (P-24) .....	74
Select local or master pump (P-63) .....	86
Select NO/NC actuators (P-64) .....	86
Select On/Off control (P-65) .....	87
Select PWM control (P-65) .....	87
Service code (P-35) .....	77
Set communication between connection modules, radio frequency, Bus or LAN (P-53) .....	83
Set priorities C/O heating/cooling (P-51) .....	82
Setpoint sharing within one zone (P-46) .....	80
Show software version connection module (P-22) .....	73
Show software version thermostat (P-21) .....	73
Show status connection module and I/O box (P-23) .....	73
Summertime/wintertime (P-37) .....	77
Unit for temperature (P-33) .....	76
Wall temperature correction (P-41) .....	78
Set	
Floor temperature setpoint .....	53
Room temperature setpoint .....	53
Time and date at commissioning .....	56
Setpoint	
Normal operation .....	58
Reduced operation .....	58
Set floor temperature setpoint .....	53
Set room temperature setpoint .....	53
Sharing within one zone (P-46) .....	80

Software-Update	
SD-card .....	66
Sound sensor button	
On/off (P-07).....	71
Stand-by mode wireless room thermostat.....	25
Steps during commissioning.....	44
Summertime (P-37) .....	77
Switched-on period (Definition) .....	57
Switching point (Definition).....	57
Symbols	
Wireless room thermostat .....	24
System failure.....	9
<b>T</b>	
TB-input	
C/O-signal.....	38
Temperature monitoring .....	39
Technical data	
Dimensions.....	101
Radio system.....	101
Wireless connection module .....	101
Wireless room thermostat .....	104
Temperature control	
Floor temperature control IR .....	20
Room temperature .....	19
Temperature monitoring .....	39
Test	
Addressing.....	48
Addressing between wireless connection modules .....	49
Thermal actuators	
Electrical connections.....	37
Optimized actuator control .....	20
Time and date	
Adjust time and date.....	56
Set time and date .....	56
Time program .....	19
Change existing program .....	61
Change time program.....	60
Factory settings .....	58
Factory settings time program.....	58
For all weekdays .....	57
For each day of the week .....	57
For working days and weekend.....	57
Overview time programs.....	57
Reset time programs to factory settings.....	63
Rules for removing switched-on periodes .....	63
Select time program .....	59
Switched-on period (Definition) .....	57
Switching point (Definition).....	57
Time out during programming .....	63
Tips and tricks.....	94
Topology .....	108
One wireless connection module .....	108
Up to 3 wireless connection modules.....	111
Troubleshooting .....	90
Lost radio connection .....	90
Radio signal lost .....	92
Wireless connection module.....	90
Wireless room thermostat.....	90
Type designation	
Accessories .....	16
<b>U</b>	
Unit for temperature(P-33).....	76
Unlock operation	
Wireless room thermostat.....	64
User manual .....	7
User menu .....	69
Change time programs (P-04).....	70
Display battery saving mode (P-06) .....	71
Enter user menu .....	69
ID-number connection module (P-09) .....	71
ID-number thermostat (P-08).....	71
Limits room temperature (P-03).....	70
Overview.....	67
Reset time programs (P-05) .....	70
Setpoint floor temperature (P-02).....	70
Shown value in stand-by mode .....	70
Sound sensor buttons (P-07).....	71
<b>W</b>	
Wall temperature correction (P-41) .....	78
Warning symbols .....	8
Waste disposal .....	94

## Index

Wintertime (P-37).....	77	Lock operation .....	64
Wireless connection module		Master function (P-48) .....	81
Addressing to each other.....	49	Material numbers .....	16
Connect power.....	43	Max. floor temperature (P-43).....	79
Design.....	17	Maximum number of room devices.....	44
Dimensions .....	101	Mount 230 V version .....	30
Electrical connections.....	34	Open housing.....	27
Install cover.....	43	Operation elements.....	23
Installation.....	26	Operation mode .....	25
LED description .....	22	Place of installation.....	27
LEDs .....	21	Reduction of room temperature (P-44).....	79
Material numbers .....	15	Sensor button.....	23
Monitoring elements .....	21	Stand-by mode.....	25
Operating elements .....	21	Symbols .....	24
Push buttons description .....	21	Technical data.....	104
Remove cover.....	34	Troubleshooting .....	90
Set master .....	49	Unlock operation.....	64
Technical data .....	101	Wall temperature correction (P-41).....	78
Troubleshooting.....	90	Wiring notes .....	32
Wireless room thermostat		<b>Z</b>	
230 V version.....	30	Zones .....	50
Close housing .....	29	Applications for zoning.....	50
Connect 230 V version .....	31	Building .....	51
Connection 230 V version .....	30	Delete.....	52
Design.....	18	Delete channel from zone .....	52
Display .....	25	Number of zones.....	51
Display elements .....	23	Sequence.....	51
Floor temperature correction (P-42).....	78	Setpoint sharing within one zone (P-46).....	80
Installation.....	27		

## Factory settings parameters

We recommend that you enter your settings in the following tables, e.g. for reset. After a reset of the radio connection module, all settings are reset to factory settings.

### User menu

Parameter	Description	Factory settings	New
P-01	Set display in stand-by-mode: actual value or time.	Room temperature	
P-02	Set setpoint for the minimal floor temperature. (only for versions with integrated IR-sensor)	15 °C	
P-03	Set upper and lower limits for room temperature setpoint.	30 °C / 5 °C	
P-04	Change time programs.	–	
P-05	Reset time programs to factory settings.	–	
P-06	Set display for stand-by-mode. (max. battery saving mode)	On	
P-07	Activate or deactivate sound of sensor button.	On	
P-08	Show ID-number of wireless room thermostat	–	
P-09	Show ID-number of wireless connection module	–	

### Service menu

Parameter	Description	Factory settings	New
P-SE	Access only with service code, factory settings "1234"	–	
P-21	Show software-version of wireless room thermostat	–	
P-22	Show software-version of wireless connection module	–	
P-23	Show actual status of wireless connection module and I/O-Box	–	
P-24	Reset parameter to factory settings.	–	

Parameter	Description	Factory settings	New
P-31	Set increment for room temperature setpoint adjustment.	0: 0.5 K	
P-32	Set temperature for frost protection function.	8.0 °C	
P-33	Set unit for temperature.	0: °C	
P-34	Set dead-zone for change-over between heating and cooling.	0: 2 K	
P-35	Change service code for service menu.	1234	
P-36	Change access code for public spaces.	1234	
P-37	Activate or deactivate "summer-/wintertime".	0: activated	

## Reset radio system to factory settings

Parameter	Description	Factory settings	New
P-41	Set wall temperature correction of wireless room thermostat.	0 K	
P-42	Set floor temperature correction of wireless room thermostat with integrated IR-sensor.	0	
P-43	Set maximum floor temperature of wireless room thermostat with integrated IR-sensor.	35 °C	
P-44	Set reduction of room temperature for "Eco" function.	3 K	
P-45	Activate or deactivate cooling lock and/or bypass, e.g. for a heat pump.	0	
P-46	Activate or deactivate "setpoint sharing within one zone"	0: deactivated	
P-47	Activate or deactivate lock for public spaces or hotels.	0: deactivated	
P-48	Activate or deactivate master function of a wireless room thermostat.	0: deactivated	

Parameter	Description	Factory settings	New
P-51	Set priorities for change-over of heating/cooling and configure output for heating/cooling or burner start.	0	
P-52	Activate or deactivate "optimized time program".	0: deactivated	
P-53	Set communication between wireless connection modules radio frequency, BUS or LAN.	0	

Parameter	Description	Factory settings	New
P-61	Configure ECO or N/R input.	0	
P-62	Configure C/O in-/TB-input.	2	
P-63	Select control of pump "local" or "Master-wireless connection module" (only with activated communication between wireless connection modules).	0	
P-64	Select NC or NO function of thermal actuators.	0: NC	
P-65	Select control algorithm.	0: On/Off	
P-66	Activate or deactivate function "optimized actuator control".	0: deactivated	
P-67	Select controlled first start-up of floor heating.	0: deactivated	



## Factory settings time program

	☾I						☾II						☾III					
	1☾	1☾	2☾	2☾	3☾	3☾	1☾	1☾	2☾	2☾	3☾	3☾	1☾	1☾	2☾	2☾	3☾	3☾
1	Ⓐ 06:00...23:00 OFF -	Ⓐ 06:00...08:30 16:30...23:00 OFF	Ⓐ 06:00...08:30 11:30...13:30 16:30...23:00	Ⓐ 06:00...08:30 11:30...13:30 16:30...23:00	Ⓐ 06:00...08:30 11:30...13:30 16:30...23:00	Ⓐ 06:00...08:30 11:30...13:30 16:30...23:00	Ⓐ 06:00...08:30 11:30...13:30 16:30...23:00	Ⓐ 06:00...08:30 11:30...13:30 16:30...23:00	Ⓐ 06:00...08:30 11:30...13:30 16:30...23:00	Ⓐ 06:00...08:30 11:30...13:30 16:30...23:00	Ⓐ 06:00...08:30 11:30...13:30 16:30...23:00	Ⓐ 06:00...08:30 11:30...13:30 16:30...23:00	Ⓐ 06:00...08:30 11:30...13:30 16:30...23:00	Ⓐ 06:00...08:30 11:30...13:30 16:30...23:00	Ⓐ 06:00...08:30 11:30...13:30 16:30...23:00	Ⓐ 06:00...08:30 11:30...13:30 16:30...23:00	Ⓐ 06:00...08:30 11:30...13:30 16:30...23:00	Ⓐ 06:00...08:30 11:30...13:30 16:30...23:00
2																		
3																		
4																		
5																		
6																		
7																		
1	Ⓐ  e.g. 06:00...14:00 e.g. 17:00...22:00	Ⓐ Ⓑ	Ⓐ Ⓑ	Ⓐ Ⓑ	Ⓐ Ⓑ	Ⓐ Ⓑ	Ⓐ Ⓑ	Ⓐ Ⓑ	Ⓐ Ⓑ	Ⓐ Ⓑ	Ⓐ Ⓑ	Ⓐ Ⓑ	Ⓐ Ⓑ	Ⓐ Ⓑ	Ⓐ Ⓑ	Ⓐ Ⓑ	Ⓐ Ⓑ	Ⓐ Ⓑ
2																		
3																		
4																		
5																		
6																		
7																		

B1257/a

