

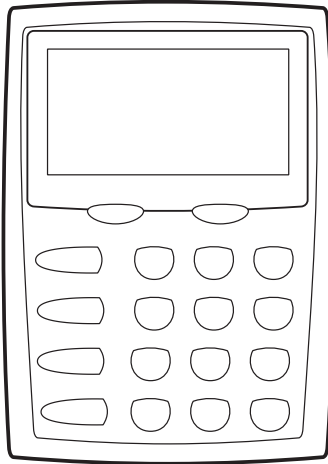

VALET D8 CONTROL PANEL AND DIALLER



VALET

Solutions for Smarter Living

USER'S MANUAL

VALET D8 CONTROL PANEL V4 – USER'S MANUAL, REVISION 2

Versions commencing November 2001



Solutions for Smarter Living

NSW
02 9748 7511

QLD
07 3216 7175

VIC
03 9544 2978

WA
08 9444 9488

VALET D8 V4 USER MANUAL

Revision 2, November 2001

Document Part Number: 890-228REV2

For product:

Valet D8 LED Control Panel (V4)

Valet D8 LCD Control Panel (V4)

© 2001 Valet
Valet D8 V4 user rev2 pmo231101

Specifications may change without notice.

Features	4
Introduction	5
Keypad	6
Keypad Indicators	7
OPERATION by KEYPAD	8
Arming	9
Disarming	10
Resetting Alarms	10
Monitor Mode	11
Panic	12
Duress	12
Fire Alarm	13
Medical Alarm	13
Excluding Zones	14
Alarm Memory	15
OPERATION by RADIO KEY	16
PROGRAMMING	17
Programming Options Table	17
User Code programming	18
Entry/Exit Timer programming	18
Telephone Number programming	19
Monitoring, Central Station	20
Monitoring, Audible	21
Wireless Accessories	20
Remote Operation by Telephone	22
ACCESSORIES	24
Wireless Accessories	25
Troubleshooting	26
Installation Record	27
OPERATION SUMMARY	28

VALET D8 FEATURES

- 8 Fully programmable zones
- Any combination of hardwire or radio zones
- Full radio supervision
- Contact ID Dialler Format
- Ultra-Modern and Impact resistant Housing
- Audible Dialler Format
- "Follow Me" Audible Dialler Option
- Separate 24 Hour Tamper input
- Single or Double Trigger Zones
- Remote LED or LCD Keypads (Max 3)
- Fully programmable via the system Keypad - Eliminates the need for expensive programmers or Proms.
- Inbuilt Vibration Sensor Analyser
- All programming data is permanently stored in a non-volatile EEprom memory
- Windows based Up\Down load Software allows remote programming and event status
- True Dynamic Battery Test every time the Panel is armed / disarmed and every hour
- Area Partitionable (2 Areas). Any Zone can be programmed to any area, as well as common areas
- Comes complete with an AC plug pack and supports a 12V 7Ah battery to maintain systems security under all power supply conditions
- Monitor Mode (Home Mode)
- Outputs are separately fused with Automatic Reset Fuses
- Day Mode and Door Chime feature.
- 30 Event Memory
- Supports 8 Radio Devices (Radio PIRs, Radio Reeds etc)
- Supports 14 Radio Keys
- All inputs and outputs are heavily protected against lightning and high voltage supply transients. An earth terminal is provided for extra protection
- 15 User Codes
- 'Arm only' codes can be programmed
- Programmable Inputs to activate selectable Outputs
- Designed utilising the latest SMD Technology
- Simple to Program and Use.

The Valet D8 micro computer based 8 zone **control panel** is the heart of your security system to which all your detection devices connect.

Each **Zone** of the panel can be connected to one or more detection devices to protect separate rooms of your premises.

Detection devices may be connected to the D8 control system directly by cabling or with optional wireless (Radio) devices.

Detection devices called **Passive Infra-Red Detectors** (or **P.I.R's** for short) can detect the movement of an intruder by sensing their body heat. **P.I.R's** are used to cover various critical areas of your premises where an intruder may enter or trespass. Another detection device used is called a **Reed Switch**. Reed Switches are attached to windows and doors to detect if a window or door has been opened. A Reed Switch consists of a magnet which is normally attached to the moving part of a window or door and the Reed switch which mounts to the door or window frame.

The panel is "**Armed**" when it is set to detect an intruder. At other times it is "**Disarmed**".

Normally a zone is considered **Sealed**. Activation of a detection device will cause the zone to be **Unsealed** and may cause an alarm.

Detectors such as fire detectors and panic buttons must be able to generate an alarm at all times regardless of the panel setting. A zone with this assignment is called a **24 hour zone**.

Some detection devices may be required to generate an alarm or warning only when the panel is Disarmed. A zone with this assignment is called a **Day zone**.

Before leaving the premises you must Arm the panel to enable it to detect intruders and generate an alarm. After arming, the panel will ignore detectors during the **Exit Delay Time** to enable you to depart without triggering an alarm.

Arming the system may be done through the keypad or with the use of optional Radio Keys for Arming by remote control from outside the premises.

When you enter the premises the panel will ignore selected zones for the **Entry Delay Time** and will not alarm unless you don't Disarm the panel during this allowed time.

Disarming the system may be done by keypad or with the use of optional Radio Keys.

Monitor mode allows you to Arm selected zones while others are ignored. Typically, perimeter zones (doors and windows) can be monitored while you are at home.

If you wish to split your alarm system into two areas with access limited to each area by code numbers then **Area operation** is used. Radio Keys can also Arm and Disarm Areas.

The control panel housing and the covers over external sirens are protected by **tamper switches** to detect someone attempting to disable the security system. Activation of these switches will cause an instant tamper alarm.

If a detector becomes faulty, you can **Exclude** the associated zone so that it is totally ignored and cannot generate an alarm. Including the zone will enable it to generate an alarm again.

The control panel is fitted with a **rechargeable stand-by battery** to ensure your security system continues to operate if the mains power is interrupted. This control panel automatically tests the battery every hour and whenever you Arm/Disarm the panel. (**Dynamic Battery test**).

Whenever an alarm occurs, it may be silenced with a **User Code** or by optional Radio Keys, otherwise it will reset at the end of Alarm Reset Time.

All alarms are stored in memory and may be viewed at any time by entering **Memory Mode**.

KEYPAD

The D8 control panel may be supplied with either the LED keypad or the LCD Keypad, depending on the model.

The keypad provides important visual and audible indications and is the main interface for operating and programming the D8 control panel.

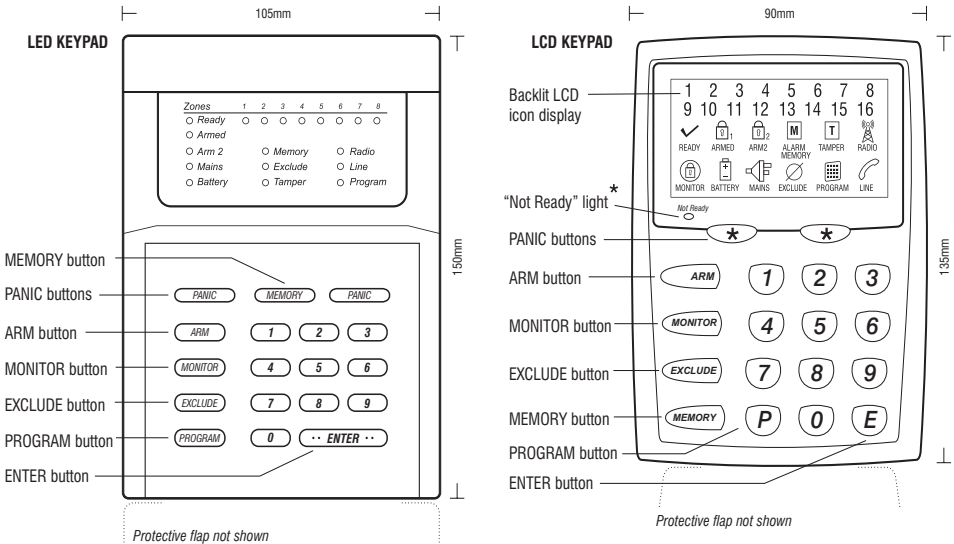

* The "Not Ready" light is on when the panel is not ready to Arm. i.e. a zone is unsealed, there may still be movement in the premises or a door or window left open

DISPLAY TEST (LCD Keypad only)

To display all the keypad icons press and hold the (E) button for at least 2 seconds. All the icons will be on whilst the (E) button is held down.

Display Test can be activated at any time either in operating mode or any program mode.

LED KEYPAD	LCD KEYPAD	STATUS		
		● OFF	○ ON	☀ FLASHING
ZONES 1–8		Zone is sealed	Zone is unsealed	Zone alarm
○ READY	✓ READY	Zone is unsealed, or Power fault or System is Armed, or phone line fault	Ready to Arm	
○ ARMED	🔒 ₁ ARMED	Disarmed	Armed (AREA 1)	Monitor Mode (LED Keypad only)
○ ARM2	🔒 ₂ ARM2	Disarmed	Armed (AREA 2)	
	🔒 MONITOR	Disarmed	Monitor Mode	
○ MAINS	🔊 MAINS	Normal		Mains Power is off
○ BATTERY	🔋 BATTERY	Normal		The panel's backup battery is low
○ MEMORY	M ALARM MEMORY	Normal	Memory Mode selected	New alarms in memory
○ EXCLUDE	⊘ EXCLUDE	Normal		Zones are excluded
○ TAMPER	T TAMPER	Normal		Tamper alarm
○ RADIO	📡 RADIO	Normal	Receiving radio signal (And in Memory Mode indicates a low battery alarm from a radio device)	Indicates that a Radio Key or other radio device has a low battery
○ LINE	📞 LINE	Normal	Dialler is on line	Phone line fault or failure to communicate
○ PROGRAM	📱 PROGRAM	Normal	User Program Mode	Installer Program Mode
	<i>Not Ready</i> ○	Ready to Arm	Not ready to Arm	

KEYPAD BEEPER SOUNDS

Each key press	♪ 1 beep
Valid command	♪♪♪ 3 beeps
Error	♪— 1 long beep
Mains Power is off or Panel Battery is low	♪— ¹⁰ — 10 beeps

OPERATION

This section describes the operation of a typical control panel installation. Keep in mind that your installation may vary depending on the selected options and equipment. The operating instructions which follow will cover the most common options.

Consult your installation company if you require further information.

All control panel operations are controlled by the D8 LED or LCD keypad except if an optional key switch or radio control equipment is installed.

OPERATING RULES

Generally, the panel will be Disarmed. Armed or Monitor modes provide different levels of security for your premises when you are home or away. Three other temporary modes; Program, Memory and Exclude, allow you to perform various operations. The panel will automatically exit from these temporary modes if you do not press any buttons on the keypad in a 4 minute period.

If you make a mistake while entering any codes, press the Enter or E button and start again.

When you are required to enter your access code, you are given five opportunities to enter it correctly. After the fifth invalid attempt the alarm is activated (requiring the correct code to silence the alarm). This prevents anyone trying to guess your code by entering random numbers.

AREA OPERATION

Area Partitioning allows the 8 zones to be split into two partitions; Area1 and Area2.

The panel then effectively operates as two separate systems sharing only the siren outputs and dialler.

USER CODE ASSIGNMENT

A User Code assigned to an Area can Arm and Disarm only that Area. User Codes assigned to both Areas will operate both Areas simultaneously.

COMMON AREA ZONES

Zones assigned to both Areas are Armed only when Area1 and Area2 are both Armed. This allows the Common Area zone/s to be shared by both Areas.

For example, Office A and Office B operate as separate areas but the entrance foyer used by both offices is assigned to both areas meaning it will automatically Arm when both Areas have Armed. The Common Area then automatically disarms when either Area1 or Area2 Disarms.

















OPERATION

Arming and Disarming is carried out as normal from a single keypad or separate keypads installed in both areas or by Radio Key.

Area operation only applies to zones when they are in the Armed state. This means that Day, 24hr and Monitor zones are independent of the area operations.

Note: Area partitioning is in addition to Monitor Mode. Any zone may be allocated to any area.

ARMING

 LED KEYPAD	 LCD KEYPAD
<p>① The <i>Ready</i> light must be on</p> <p>② Press...   </p> <p style="margin-left: 40px;">or...  [User Code]  </p> <p>③ The  Armed light will turn on</p> <ul style="list-style-type: none"> • Leave the premises within the Exit Delay Time • 3 beeps will sound at the end of Exit Delay Time 	<p>① The <i>Not Ready</i> light must be off</p> <p>② Press...   </p> <p style="margin-left: 40px;">or...  [User Code]  </p> <p>③ The  ARMED icon will turn on</p> <ul style="list-style-type: none"> • Leave the premises within the Exit Delay Time • 3 beeps will sound at the end of Exit Delay Time

The control panel must be Armed prior to vacating the premises in order to detect intruders. Ensure that the panel is not in Program, Memory or Exclude modes.

Note: If the panel is already in alarm, you must first silence the alarm before you can Arm.

If something is wrong when Arming the control panel, the normal 3 beeps will be replaced by other warnings.

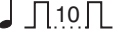
 10 beeps means Mains Power is turned off or the Backup Battery is low.

 One long beep indicates an invalid entry or an alarm is outstanding and needs to be reset by entering your User Code first.

SIREN WARNING:

At the end of the exit time, all zones should be **Sealed**. If any are **Unsealed**, the siren will sound for 2 seconds as a warning to indicate that those zones have been automatically excluded. For maximum security, you should return, Disarm, check the premises and then Arm again. Continual warnings could mean that a detector is faulty and may have to be manually excluded.

If the auto-exclude option is disabled, the siren will sound for the duration of reset time if a zone is Unsealed at the end of exit time.

OPERATION

DISARMING



LED KEYPAD

- 1 Enter the premises through a delay zone
- 2 Press... [User Code] **ENTER**
- 3 The **Armed** light will turn off



LCD KEYPAD

- 1 Enter the premises through a delay zone
- 2 Press... [User Code] **E**
- 3 The **ARMED** icon will turn off

When you enter the protected premises through a delay zone, the keypad responds with regular beeps* as a reminder to Disarm. You then have your programmed entry delay time to Disarm the panel by entering one of your user codes. If the panel is not Disarmed by the end of the entry delay time, an alarm will occur.

By using the optional radio keys you may Disarm your system from within your premises

or from outside your entrance door. There is also the option to 'Chirp' the outside siren three times and to flash the strobe light for two seconds as an indication that you have Disarmed your system.

If you make a mistake in entering your code, then you must press enter and start again. Five incorrect entries will cause an alarm.

* If Entry Beeps are programmed on.

RESETTING ALARMS

Your panel can be reset and the alarm silenced by the same key sequence as Disarming the panel.

If you arrive at your premises and find the strobe light flashing (if installed), reset the panel as above. To check the cause of the alarm, you can view the alarms in memory by entering Memory Mode.

ALARMS, DEFINITION

Alarms may be caused by:

- A zone has been triggered while Armed
- A Tamper has been triggered
- A PANIC button has been triggered

All of these may cause your sirens and strobe to operate. Various visual indications relevant to the alarm will be retained in the memory. If this occurs, Disarming your control panel will reset the alarm. The cause of the alarm can be identified by entering the Alarm Memory Mode as described on page 15.

MONITOR MODE



LED KEYPAD

- 1 Press... **MONITOR** **ENTER**
- or... **MONITOR** [User Code] **ENTER**
- 2 The **Monitor** light will turn on
 - Only the zones which have been programmed by your installer as Monitor zones will be Armed



LCD KEYPAD

- 1 Press... **MONITOR** **E**
- or... **MONITOR** [User Code] **E**
- 2 The **MONITOR** icon will turn on
 - Only the zones which have been programmed by your installer as Monitor zones will be Armed

Monitor mode allows you to Arm selected zones while others are ignored. Typically, perimeter zones (doors and windows) can be monitored while you are at home.

Your installer must program which zones will be active in Monitor mode.

The panel must be fully Disarmed before Arming in Monitor Mode.

If an alarm occurs while in Monitor mode, entering [User Code] **E** will silence the alarm. This will also Disarm the panel, so remember to enter monitor again if needed.

By using the optional Radio Keys you can enter Monitor Mode by pressing the OFF button twice within 4 seconds. (Your installer must enable Radio Key Monitor Arming for this to work).

OPERATION

KEYPAD PANIC



LED KEYPAD

Press... **PANIC** **PANIC** Both keys together

or... **PANIC** [User Code] **.. ENTER ..**

Or... **PANIC** **.. ENTER ..**
(If Keypad Panic Shortcut has been enabled by your installer)



LCD KEYPAD

Press... ***** ***** Both keys together

or... ***** [User Code] **E**

Or... ***** **E**
(If Keypad Panic Shortcut has been enabled by your installer)

The keypad PANIC function may have been programmed to be either **AUDIBLE** - activates siren or buzzers, or **SILENT** - If your system is monitored by a Central Station, sends a PANIC report by dialler. (If PANIC reports have been enabled by your installer).

PANIC cannot be used while the panel is in Program, Memory or Exclude mode.

Note: Your installer may have installed a separate PANIC button. To activate the panic alarm simply press that button.

KEYPAD DURESS ALARM



LED KEYPAD

Press... **9** [User Code] **.. ENTER ..**

Disarms and sends a Duress Alarm report by dialler.

1. If your system is monitored by a central monitoring station
2. If Duress Alarm Report has been enabled by your installer

Duress Alarm can be programmed to sound the RESET output.

1. By default, Duress Alarm does not sound the RESET output

Digits 5, 6 & 8 in front of the user code can also be used trigger the Duress alarm



LCD KEYPAD

Press... **9** [User Code] **E**

Disarms and sends a Duress Alarm report by dialler.

1. If your system is monitored by a central monitoring station
2. If Duress Alarm Report has been enabled by your installer

Duress Alarm can be programmed to sound the RESET output.

1. By default, Duress Alarm does not sound the RESET output

Digits 5, 6 & 8 in front of the user code can also be used trigger the Duress alarm

A DURESS alarm can be triggered to alert the Central Station that you are being forced to Disarm the panel against your will.

To Disarm and send a DURESS alarm, prefix your User Code with one of the digits 5, 6, 8 or 9 when Disarming.

DURESS alarms are only used if your system is monitored by a Central Station.

DURESS IS NORMALLY NOT ENABLED. TO ENABLE THE DURESS FUNCTION, CONSULT YOUR INSTALLER

KEYPAD FIRE ALARM



LED KEYPAD

Press... **3** **.. ENTER ..**

Sounds the siren (Fire Alarm siren sound)
 1. If Keypad Fire Alarm has been enabled by your installer

Sends a Fire Alarm report by dialler.
 1. If your system is monitored by a central monitoring station
 2. If Fire Alarm Report has been enabled by your installer



LCD KEYPAD

Press... **3** **E**

Sounds the siren (Fire Alarm siren sound)
 1. If Keypad Fire Alarm has been enabled by your installer

Sends a Fire Alarm report by dialler.
 1. If your system is monitored by a central monitoring station
 2. If Fire Alarm Report has been enabled by your installer

KEYPAD MEDICAL ALARM



LED KEYPAD

Press... **2** **.. ENTER ..**

Sends a Medical Alarm report by dialler.
 1. If your system is monitored by a central monitoring station
 2. If Medical Alarm Report has been enabled by your installer

Medical Alarm does not sound sirens.



LCD KEYPAD

Press... **2** **E**

Sends a Medical Alarm report by dialler.
 1. If your system is monitored by a central monitoring station
 2. If Medical Alarm Report has been enabled by your installer

Medical Alarm does not sound sirens.

OPERATION

EXCLUDING ZONES



LED KEYPAD

- 1 Press... **EXCLUDE** **ENTER**
- or... **EXCLUDE** [User Code] **ENTER**
- 2 The **EXCLUDE** light will turn on
- 3 Enter the zone number of the zone/s to be Excluded
[Zone No.] **ENTER** [Zone No.] **ENTER**
The zone light of each Excluded zone will turn on
- 4 Press... **ENTER** to exit Exclude mode
- 5 The **EXCLUDE** light will flash continuously



LCD KEYPAD

- 1 Press... **EXCLUDE** **E**
- or... **EXCLUDE** [User Code] **E**
- 2 The **EXCLUDE** icon will turn on
- 3 Enter the zone number of the zone/s to be Excluded
[Zone No.] **E** [Zone No.] **E**
The zone light of each Excluded zone will turn on
- 4 Press... **E** to exit Exclude mode
- 5 The **EXCLUDE** icon will flash continuously

If a detector becomes faulty and cannot be Sealed when arming the panel, then its zone may be Excluded so that it does not generate alarms.

When zones have been Excluded, the EXCLUDE light flashes continuously while the panel is Disarmed and also when Armed.

Zones can only be Excluded when the panel is Disarmed.

Zone Exclude IS **not permanent**. Excluded zones are automatically INCLUDED next time the panel is Disarmed.

Zones can be manually included by the same method as Excluding. Simply use the **[ZONE NUMBER] E** sequence to turn OFF the zone lights to be Included.

NOTES

- **EXCLUDE E** works only when the panel is Disarmed.
- **EXCLUDE [User Code] E** works in any state.
- **EXCLUDE [User Code] E** can only exclude the zones in the Area assigned to that code.

VIEWING EVENT MEMORY

 **LED KEYPAD**

1 Press... **MEMORY** **.. ENTER ..** 

or... **MEMORY** [User Code] **.. ENTER ..** 

2 The **• Memory** light will turn on

3 Press... **MEMORY**
The most recent event will be displayed

Press... **MEMORY**
The next most recent event will be displayed

Press... **MEMORY**
...and so on (up to 30 events)

4 Press... **.. ENTER ..** to exit Memory mode

 **LCD KEYPAD**

1 Press... **MEMORY** **E** 

or... **MEMORY** [User Code] **E** 

2 The **M MEMORY** icon will turn on

3 Press... **MEMORY**
The most recent event will be displayed

Press... **MEMORY**
The next most recent event will be displayed

Press... **MEMORY**
...and so on (up to 30 events)

4 Press... **E** to exit Memory mode

The D8 Control Panel stores a comprehensive Alarm Memory, including Arming, Disarming, Low Battery, Mains Fail and Alarm events.

The memory is constantly upgraded and the last 30 events are always available for viewing.

This Memory display can only be selected while the panel is in the Disarmed state.

TO CLEAR THE MEMORY LIGHT

The MEMORY light flashes continuously when an alarm has occurred as a reminder to view the alarm memory.

The MEMORY light stops flashing after the memory is viewed as shown above.

The MEMORY light is automatically cleared next time the panel is Armed.

MEMORY MODE - EVENTS INDICATED BY KEYPAD LIGHTS:

LIGHT

- Zone lights 1~8
- ARM
(no lights)
- TAMPER
- EXCLUDE
- BATTERY
- MAINS
- RADIO, BATTERY, ZONE
- RADIO, BATTERY, ARM

ALARM EVENT

- Zone alarm
- Panel Armed
- Panel Disarmed
- Tamper alarm (Siren cover, panel etc)
- Panic alarm
- Low Battery
- Mains power failure
- Radio Device battery low
- Radio Key battery low

RADIO KEY OPERATION



VALET RADIO KEY 3 BUTTON

The optional Valet Radio Key allows you to Arm, Disarm and activate PANIC. The Radio Key can also Arm Monitor Mode, (if this has been enabled by your installer).

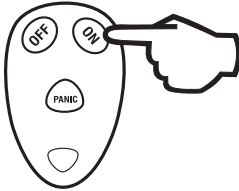

ARMING

Press the ON button.

- The keypad will give 3 beeps.
- The outside siren will give 1 'chirp'. (If enabled by your installer)
- The strobe light will flash briefly

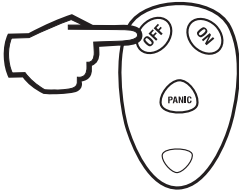

DISARMING

Press the OFF button.

- The keypad will give 3 beeps.
- The outside siren will give 3 'chirps'. (If enabled by your installer).
- The strobe light will flash briefly.

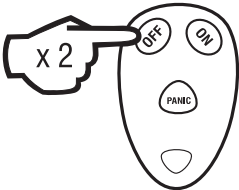

ARMING MONITOR MODE

Press the OFF button twice within 4 seconds.

- The keypad will give 9 beeps.
- The outside siren will NOT 'chirp'.
- The strobe light will flash briefly.

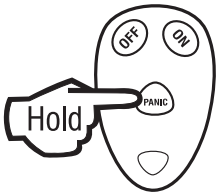

PANIC

Press and hold the PANIC button for at least 4 seconds.

- The siren and strobe will activate, (If enabled by your installer)
- The dialler will report a Panic alarm, (If enabled by your installer and if your system is monitored by a central station).

Press the OFF button to reset a Panic alarm

* The Valet Radio Key is optional and is not supplied with any control panels as standard

* Requires the Valet Radio Interface to be fitted to the control panel.

Various system options, as listed below, can be programmed by the user. These options can only be accessed from Program Mode.

User Codes may need to be re-programmed if a person has forgotten their code, to give a new user access to the system or to give someone temporary access.

User Codes 2-15 can be set as **Arm Only Codes**. These codes can Arm but cannot Disarm the panel. (Useful for assigning to cleaners, tradesmen etc.)

You may need to change the **Entry and Exit timers** if you find the delays are too long or short.

If Audible Monitoring is programmed by your installer, the **'Follow Me' Telephone Number** is the telephone number the dialler will call in the event of an alarm.

If your Valet D8 panel is monitored by a Central Station, the Follow Me number is ignored.

For all other programming changes, talk to your installer.

The panel will automatically exit Program Mode is no buttons are pressed within a 4 minute period.

FACTORY DEFAULT MASTER CODE IS: 123











PROGRAMMING OPTIONS TABLE

OPTION	OPTION No	FACTORY DEFAULT	RANGE	PROGRAMMED
User Code 1 (Master Code)	P11E	123	3 to 6 digits	
User Code 2	P12E		3 to 6 digits	
User Code 3	P13E		3 to 6 digits	
User Code 4	P14E		3 to 6 digits	
User Code 5	P15E		3 to 6 digits	
User Code 6	P16E		3 to 6 digits	
User Code 7	P17E		3 to 6 digits	
User Code 8	P18E		3 to 6 digits	
User Code 9	P19E		3 to 6 digits	
User Code 10	P20E		3 to 6 digits	
User Code 11	P21E		3 to 6 digits	
User Code 12	P22E		3 to 6 digits	
User Code 13	P23E		3 to 6 digits	
User Code 14	P24E		3 to 6 digits	
User Code 15	P25E		3 to 6 digits	
Entry Delay 1	P26E	20 seconds	1 to 99 sec	
Entry Delay 2	P27E	60 seconds	10 to 990 sec	
Exit Delay	P28E	60 seconds	1 to 99 sec	
Follow Me Telephone No.	P00E		Up to 15 digits	

NOTE: The Entry Delay 2 timer programs in 10 second intervals.
Example: if a value of 6 is programmed, the time is 60 seconds.

PROGRAMMING

PROGRAMMING USER CODES

 LED KEYPAD	 LCD KEYPAD
<p>① Press... (PROGRAM) [Master Code] .. ENTER .. </p> <p>Enters Program Mode. The PROGRAM light will be on.</p>	<p>① Press... P [Master Code] E </p> <p>Enters Program Mode. The PROGRAM light will be on.</p>
<p>② Press... (PROGRAM) [Option No.] .. ENTER .. </p> <p>The two digit option number for the code to be programmed. The existing code (if any) will be displayed.</p>	<p>② Press... P [Option No.] E </p> <p>The two digit option number for the code to be programmed. The existing code (if any) will be displayed.</p>
<p>③ Press... [NEW CODE] .. ENTER .. </p> <p>[NEW CODE] .. ENTER .. </p> <p>Enter the new code twice. The new code will be displayed.</p>	<p>③ Press... [NEW CODE] E [NEW CODE] E </p> <p>Enter the new code twice. The new code will be displayed.</p>
<p>④ Press... (PROGRAM) .. ENTER .. </p> <p>To exit Program Mode</p>	<p>④ Press... P E </p> <p>To exit Program Mode</p>











EXAMPLES *The panel must be in Program Mode. (Program light ON)*

To program User Code 1 (The Master Code) to be 1234: **P11E 1234 E 1234 E**

To program User Code 2 as an ARM ONLY code to be 5678: **P12E ARM E 5678 E 5678 E**

When an Arm Only code is displayed, the ARM light or icon is displayed, followed by the digits of the code

PROGRAMMING TIMERS

 LED KEYPAD	 LCD KEYPAD
<p>① Press... (PROGRAM) [Master Code] .. ENTER .. </p> <p>Enters Program Mode. The PROGRAM light will be on.</p>	<p>① Press... P [Master Code] E </p> <p>Enters Program Mode. The PROGRAM light will be on.</p>
<p>② Press... (PROGRAM) [Option No.*] .. ENTER .. </p> <p>The existing time will be displayed.</p>	<p>② Press... P [Option No.*] E </p> <p>The existing time will be displayed.</p>
<p>③ Press... [NEW TIME] .. ENTER .. </p> <p>The new time will be displayed.</p>	<p>③ Press... [NEW TIME] E </p> <p>The new time will be displayed.</p>
<p>④ Press... (PROGRAM) .. ENTER .. </p> <p>To exit Program Mode</p>	<p>④ Press... P E </p> <p>To exit Program Mode</p>

EXAMPLES *The panel must be in Program Mode. (Program light ON)*

To program Entry Delay Time1 to be 15 seconds: **P26E 15 E**

To program Exit Delay Time to be 40 seconds: **P28E 40 E**

PROGRAMMING THE FOLLOW-ME TELEPHONE NUMBER



LED KEYPAD

- 1 Press... **PROGRAM** [Master Code] **.. ENTER ..**

Enters Program Mode. The PROGRAM light will be on.
- 2 Press... **PROGRAM** [Option No.*] **.. ENTER ..**

The existing telephone number (if any) will be displayed.
- 3 Press... [NEW TELEPHONE NUMBER] **.. ENTER ..**

The new telephone number will be displayed.
- 4 Press... **PROGRAM** **.. ENTER ..**

To exit Program Mode



LCD KEYPAD

- 1 Press... **(P)** [Master Code] **(E)**

Enters Program Mode. The PROGRAM light will be on.
- 2 Press... **(P)** [Option No.*] **(E)**

The existing telephone number (if any) will be displayed.
- 3 Press... [NEW TELEPHONE NUMBER] **(E)**

The new telephone number will be displayed.
- 4 Press... **(P)** **(E)**

To exit Program Mode

EXAMPLES *The panel must be in Program Mode. (Program light ON)*

To program the Follow Me Telephone Number to be 9123 1234: **POOE 912341234 E**

To **DELETE** the Follow Me Telephone Number: **POOE MEMORY E**

* For a list of option numbers, see the Programming Options Table on page 17

To enter PROGRAM MODE



PROGRAM [Master Code] **.. ENTER ..**



(P) [Master Code] **(E)**

To exit PROGRAM MODE



PROGRAM **.. ENTER ..**



(P) **(E)**

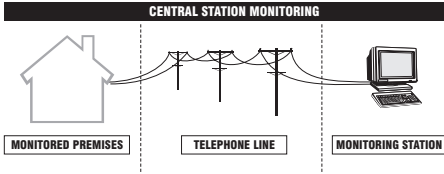

CENTRAL STATION MONITORING

The D8 control panel has an on-board digital dialler which can send detailed alarm messages to a Central Monitoring Station.

The digital messages can include information about the zone or zones which caused the alarm, tamper alarms, low battery or mains failure reports, and it can also (by user number) identify the users who Arm and Disarm the system.

Central Station Monitoring is highly recommended and is the most effective method of monitoring your D8 alarm system. For further information about 24 hour monitoring, contact your installer or Valet.

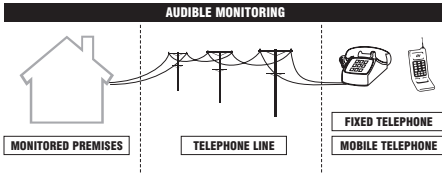

AUDIBLE MONITORING

The D8 can also be programmed to send audible messages to any telephone or mobile phone.

When programmed for audible monitoring, the D8 calls a pre-programmed number (or numbers) and sounds a series of beeps over the phone. These beeps can identify the zone or zones which caused the alarm and well as several other alarm types.

FOLLOW ME TELEPHONE NUMBER

The Follow Me Telephone Number is the telephone number to which the D8 sends alarm reports when Audible Monitoring is enabled.

The Follow Me Telephone Number can be changed by the user in User program Mode.

If the Follow Me Telephone Number is programmed, the Primary and Secondary telephone numbers are ignored, even if programmed. (When Audible Monitoring is enabled).

See page 19 for information on programming the Follow Me Telephone Number.

AUDIBLE MONITORING SEQUENCE

When triggered by an alarm, the D8 will dial the programmed telephone number/s and output the audible message for 45 seconds or until it is acknowledged.

ACKNOWLEDGING THE ALARM

The person receiving the call can then acknowledge the alarm by pressing the **#** key on their telephone. Press the **#** key for at least 2 seconds during pauses in the audible message.

If the alarm is not acknowledged, the keypad's LINE light will flash continuously until the panel is next Armed.

* The Primary and Secondary telephone numbers are normally only used for central station monitoring. These numbers can only be programmed in Installer Program Mode.

** The Follow Me Telephone Number replaces the Primary AND Secondary telephone numbers.

REMOTE OPERATION

OPERATING THE D8 BY TELEPHONE

The D8 will allow a user to call in to the panel, using a standard DTMF telephone, and remotely Arm or Disarm all areas and also turn on or off Aux 1 and Aux 2.

To ensure security of operation a user can only carry out remote operations after entering a valid user code.

WHAT'S NEEDED:

- A telephone with DTMF tones.
- A Valid User code programmed in the D8.
- The D8 to be connected (via Mode 3 socket) to a working telephone line at the installed premises.
- You need to know the telephone number of the line that the D8 is connected to.

SEQUENCE OF OPERATION.

1. Phone the D8 telephone number and listen for the required number of rings (ring ring...ring ring) and then hang up.
2. Wait 10 seconds and then call the number again within 50 seconds.
3. The D8 will answer the second call immediately, sound a beep for 2 seconds then, after a pause, it will sound a lower frequency tone. The D8 is now ready to receive telephone commands.
4. Press the **0** button on the telephone. This tells the D8 that telephone commands will follow. It will respond with either 3 beeps if all OK (One long beep means try again).
5. Now enter a valid User Code (that is normally used for Arming or Disarming the D8) followed by the **#** button.



The D8 will respond with 3 beeps if it recognises the code or 1 long beep to signal the code was invalid and to try again.

6. Enter the required command.
See: Summary Of Telephone Commands.
7. Press ***** **#** to finish. This tells the D8 to hang up. Also, hang up your telephone.

NOTES

- If the D8 does not receive commands for periods longer than 10 seconds it will assume that the call is finished and it will hang up.
- If an alarm occurs which requires the D8 to dial out while attempting remote control, the D8 will treat the alarm as a priority, give a constant tone as a warning and then hang up.
- When all remote control commands are finished press ***** **#** to force the D8 to hang up.

EXAMPLE: ARMING THE D8 BY TELEPHONE

1. Dial the D8 telephone number. Listen for one double ring then hang up.
2. Wait 10 seconds, then dial the D8 telephone number again.
The D8 will answer immediately and gives a 2 second beep followed by low tone.
3. PRESS **0** To prepare the D8 ( 3 beeps)
4. PRESS **[User Code] #** to authorise the next command ( 3 beeps)
5. PRESS **1 #** to Arm the panel ( 3 beeps)
6. PRESS *** #** to finish and hang up

AUDIBLE FEEDBACK

 3 BEEPS:

- The User Code is valid
- Successful Arming or Disarming
- An Auxiliary output has been turned ON.

 1 LONG BEEP:

- D8 is already Armed
- Invalid code. Try again.

 1 SHORT BEEP:

- An Auxiliary output has been turned OFF.

SUMMARY OF TELEPHONE COMMANDS

- 0** Prepare to receive commands
- 1 #** Arm Areas
- 2 #** Disarm Areas
- 3 #** Turn Aux 1 Output ON or OFF
- 4 #** Turn Aux 2 Output ON or OFF
- * #** Finished – hang up

ACCESSORIES

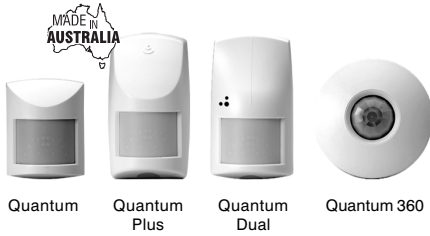

MOTION DETECTORS

The Quantum™ range of high quality and efficient motion detectors - includes passive infra-red detectors, dual technology / microwave and infra-red devices as well as ceiling mounted 360° detectors.

All Quantum™ detectors are designed using the most modern technology and techniques that ensure superior reliability and performance.

Quantum™ - 15m passive infra-red detector with selectable pulse count; suitable for domestic and commercial installations. PetAware model available.

Quantum Plus™ - 15m passive infra-red detector with selectable pulse count, temperature compensation and downward looking 'creep' zones.

Quantum Dual™ - 15m combination microwave and passive infra-red detector. This combination of detection technologies virtually eliminates the possibility of unwanted alarms but faithfully detects humans. PetAware model available.

Quantum 360™ - Ceiling mounted 360° passive infra-red detector with selectable pulse count and sensitivity. Provides 8 metre coverage mounted at standard 2.4 metre ceiling height.



PET AWARE DETECTORS

The Quantum™ Pet Aware PIR and Pet Aware DUAL are able to discriminate between household pets and unwanted human intruders, allowing you to secure your home with your pets indoors.



SIRENS

The range of warning devices includes horn speakers, polytough siren covers, internal 'screamers' and satellite sirens with their own battery backup.



SWITCHES

A variety of switches are available for protecting doors and windows. The line-up includes surface and flush mount reed switches, emergency buttons, roller door reed switches and the unique Nessor™ vibration sensor for highly effective perimeter protection.

RADIO ACCESSORIES

Ask your installer about the range of Valet radio devices for the optional extra convenience of wireless remote control and wireless detection.

Operating your Valet security system can be as convenient as opening your car door. The Valet Radio Key™ provides the benefits of separate ON, OFF and PANIC buttons in a slim, waterproof remote control.



* Valet radio products require the optional Valet Radio Interface to be fitted to the control panel.



VALET RADIO KEYPAD

A unique fully portable radio keypad. The Valet Radio Keypad provides totally wireless Arming/Disarming of the Valet D8 control panel.

Also operates Monitor mode and Panic when used with the Valet D8 panel.

The Valet radio Keypad is suitable for use as a portable keypad or for adding an extra keypad in areas where it is not possible to install wires.



VALET RADIO PIR

Valet Radio PIR (Passive Infrared) motion detector for wireless motion detection.

Can be used in combination with Valet hardwired detectors in areas where it is not possible to install wires. Includes long life

lithium battery.

Also available, the 100-663PET radio Pet Aware model, which detects humans but is immune to household pets.



VALET RADIO KEY PENDANT

Fully waterproof pendant style transmitter can be used as a portable wireless Panic button.

Supplied with a neckchain as well as wristwatch straps. Ideal for use as a medical alarm for the elderly or infirm. (Central Station Monitoring is especially recommended when used for medical alarm purposes). Includes long life lithium battery.



VALET RADIO REED SWITCH

Valet Radio Reed Switch for wireless door and window protection. Includes long life lithium battery.



VALET RADIO KEY 3 BUTTON

Fully waterproof, ultra slim 3 button Radio Key for remote control of the control panel.

With separate buttons for ON (Arm), OFF (Disarm) and PANIC functions. Includes long life lithium battery.

VALET RADIO SMOKE DETECTOR

Radio Smoke Detector using Ionisation smoke detection technology. With on board sounder.

A single battery powers the smoke detector and the transmitter. Includes 9V lithium battery.



TROUBLESHOOTING

SYMPTOM	POSSIBLE CAUSE	REMEDY
Zone light on or long beeps when Arming	One or more Zone Detection Devices (e.g., PIR, Reed Switch) may be Unsealed	Close door or window, find the cause of movement
10 beeps from keypad MAINS light flashing BATTERY light flashing	The mains power may be off, ...or the panel's backup battery may be low, ...or a Radio Device battery may be low.	Make sure the plug pack is plugged in and the power point is turned on. Call your installer.
1 long beep from keypad	Invalid keypad entry	Press E button and try again
2 second siren at the end of Exit Delay time	A zone was Unsealed at the end of Exit Delay time	Disarm the panel and check all zones
Strobe light is flashing	There has been an alarm	Reset the alarm by Disarming the panel and check the Alarm Memory
Siren sounds while the panel is Disarmed	A 24 hour zone has been triggered. E.g, Siren Tamper, Box Tamper, Panic Button.	Reset the alarm by Disarming the panel and call your installer.
EXCLUDE light is flashing	A zone/s has been Excluded	
TAMPER light flashing	The 24 hour Tamper input has triggered	Call your installer
ALARM MEMORY light is flashing	There are alarms in memory	To clear the ALARM MEMORY light, view the Alarm memory otherwise the light will clear next time you Arm the panel.
Cannot enter Program Mode	The panel is Armed. Only the Master Code can enter Program Mode.	Disarm the panel before attempting to enter Program Mode. Try again using the Master Code.

INSTALLATION RECORD



INSTALLATION RECORD

Date purchased: _____	Date installed: _____
Installation Company: _____	
Telephone: _____	

Monitoring Company: _____
Telephone: _____

- P26E ENTRY DELAY TIME 1
- P27E ENTRY DELAY TIME 2
- P28E EXIT DELAY TIME
- P29E SIREN RESET TIME







	Seconds
	Seconds
	Seconds
	Minutes

- ZONE ASSIGNMENT**
- P41E ENTRY DELAY 1
 - P43E ENTRY DELAY 2
 - P42E HANDOVER
 - P40E INSTANT
 - P45E AREA 1
 - P46E AREA 2
 - P51E MONITOR
 - P52E 24 HOUR
 - P54E RESET OUTPUT
 - P55E STROBE OUTPUT
 - P56E SONALERT OUTPUT
 - P57E SIREN OUTPUT
 - P74E Report (dialler)

ZONES	DEVICE TYPE	PIR, Reed switch, etc	DESCRIPTION	Entrance, bedroom1, etc															
1																			
2																			
3																			
4																			
5																			
6																			
7																			
8																			

CODE	OPTION No	CODE HOLDER	AREA 1	AREA 2	RADIO KEY CODE (Y/N)
User Code 1 <small>Master Code</small>	P11E				(Keypad Code only)
User Code 2	P12E				
User Code 3	P13E				
User Code 4	P14E				
User Code 5	P15E				
User Code 6	P16E				
User Code 7	P17E				
User Code 8	P18E				
User Code 9	P19E				
User Code 10	P20E				
User Code 11	P21E				
User Code 12	P22E				
User Code 13	P23E				
User Code 14	P24E				
User Code 15	P25E				

OPERATION SUMMARY

OPERATION	 LED KEYPAD	 LCD KEYPAD	 RADIO KEY
ARM	<p>ARM .. ENTER ..</p> <p>or... ARM [User Code] .. ENTER ..</p>	<p>ARM E</p> <p>or... ARM [User Code] E</p>	
DISARM	<p>[User Code] .. ENTER ..</p>	<p>[User Code] E</p>	
MONITOR MODE	<p>MONITOR .. ENTER ..</p> <p>or... MONITOR [User Code] .. ENTER ..</p>	<p>MONITOR E</p> <p>or... MONITOR [User Code] E</p>	 <p>Press twice within 4 seconds P69E 5E must be ON</p>
PANIC	<p>PANIC PANIC Both keys together</p> <p>or... PANIC [User Code] .. ENTER ..</p> <p>Or... PANIC .. ENTER .. (Keypad Panic Shortcut must be ON, P62E 4E)</p>	<p>* * Both keys together</p> <p>or... * [User Code] E</p> <p>Or... * E (Keypad Panic Shortcut must be ON, P62E 4E)</p>	 <p>Press and hold for 4 seconds (P68E 3E & 4E must be OFF)</p>
KEYPAD DURESS	<p>[x] [User Code] .. ENTER ..</p> <p>To Disarm and report a Duress Alarm, add any of the digits 5, 6, 8 or 9 before the User Code when Disarming</p>	<p>[x] [User Code] E</p>	
EXCLUDING ZONES	<p>EXCLUDE .. ENTER ..</p> <p>or... EXCLUDE [User Code] .. ENTER ..</p> <p>[Zone No.] .. ENTER .. Enter the zone numbers to be Excluded</p> <p>[Zone No.] .. ENTER .. Enter the zone numbers to be Excluded</p> <p>.. ENTER .. To exit Exclude mode</p>	<p>EXCLUDE E</p> <p>or... EXCLUDE [User Code] E</p> <p>[Zone No.] E Enter the zone numbers to be Excluded</p> <p>[Zone No.] E Enter the zone numbers to be Excluded</p> <p>E To exit Exclude mode</p>	
ALARM MEMORY	<p>MEMORY .. ENTER ..</p> <p>or... MEMORY [User Code] .. ENTER ..</p> <p>Press MEMORY repeatedly to display the last 30 events</p> <p>.. ENTER .. To exit Memory mode</p>	<p>MEMORY E</p> <p>or... MEMORY [User Code] E</p> <p>Press MEMORY repeatedly to display the last 30 events</p> <p>E To exit Memory mode</p>	