

Agilent G1701DA MSD ChemStation

**5973 MSD / ChemStation
Quick Reference**



Agilent Technologies

What's New in Revision D.01.00

- A new toolbar has been added to the Top view and an expanded set of toolbars have been added to Data Analysis. Moving the cursor of the mouse over a toolbar will display tool tips (quick descriptions) for each of the buttons.
- The sequence user interface or sample log table has been transformed into a spreadsheet user interface.
- During sequencing the ABORT button in the status panel has been changed to Pause. When this is selected, the sequence will pause immediately. When the sequence is started, it will restart the sequence from where it was paused.
- Long files names are supported. Data file and method paths can be up to 100 characters long. The names of individual data files and methods can be up to 50 characters long.
- User Interfaces for selecting or saving files and directories have been enhanced with browse buttons.
- Support for 5973A and 6890A instruments using GPIB has been restored.
- It is now possible to disable Method Resolution for most changes in the 6890 configuration.
- The Manual Tune and Diagnostics / Vacuum Control views have be merged into a single view, Tune and Vacuum Control.
- A Tune Wizard has been provided to simplify the modification of criteria (tune limits, target ratios) used by the tuning algorithms.
- Loading data files in Data Analysis will now preview the chromatogram.
- The method has been expanded to permit printers other than the default printer to be used for reports generated during Run Method.
- Headers in Data Analysis reports are now configurable for the reports generated by Run Method.
- An improved BOOTP service has replaced the previous BOOTP program. The new BOOTP service will not interfere with shutting down or logging off the computer.
- The SICL drivers have been updated to version L.O2.01 . Version M.01.01 is on the software CD and is for GPIB support.

Online Help

Use the online help to learn about these new features as well as to learn about instrument control, data acquisition, data analysis, methods, sequencing, tuning, and how to use system commands and variables. Troubleshooting the MSD is included to help you diagnose problems.

Using Online Help

To access the online help, select **Help Topics** from the Help menu in any window, or click the **Help** button on any dialog box.

Item	Description
Hide / Show	Lets you turn on or off the display of the list of help topics.
Back	Goes back to the previous help topic.
Print	Lets you print the current book or help topic.
Contents	Displays the list of help topics (shown above).
Index	Lets you use keywords to search the help index for a particular topic.
Search	Lets you type a word or phrase and then displays a list of all the topics in the online help that contain those words.

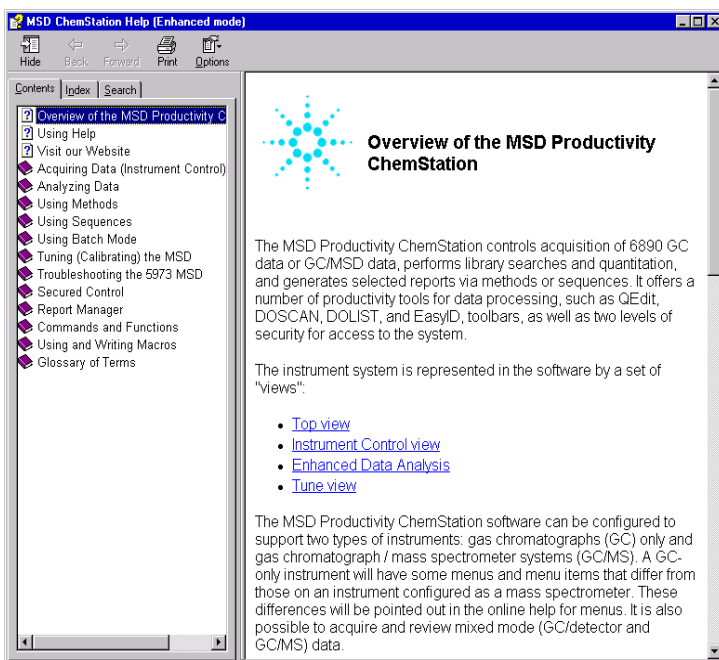

Help Icons



Indicates a book containing more help topics. To open a book, select it then double-click.



Indicates an open book of help topics. To close an open book, select it then double-click.



Indicates a help topic. To jump to a help topic, select it then double-click.

5973 MSD with a 6890 GC

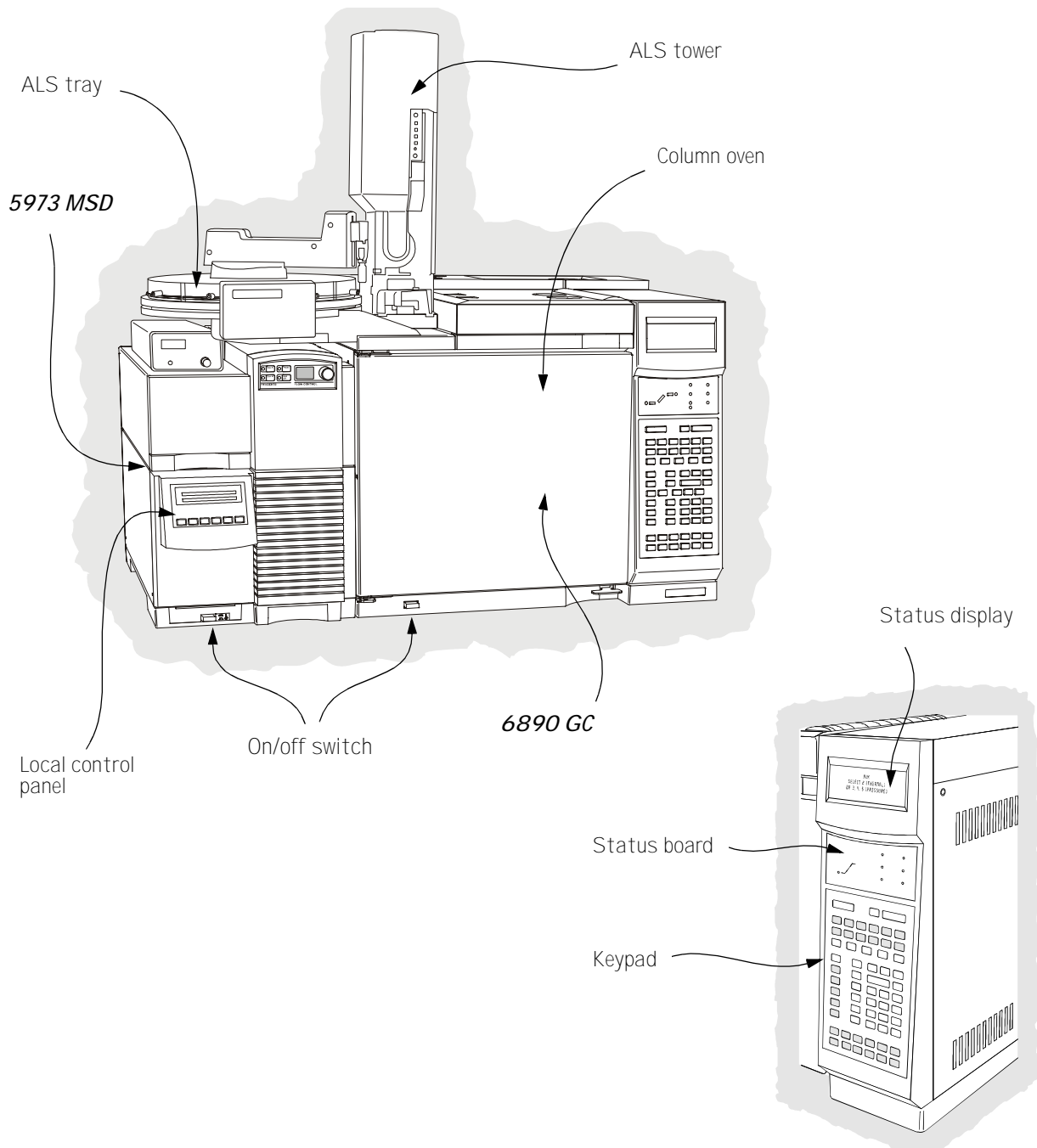

GC Keypad

The MSD ChemStation software provides instrument control for the 6890 GC. This allows you to use the software, instead of the GC keypad, to program the instrument. However, there are times when you may want to use the keypad to quickly perform one of the following tasks.

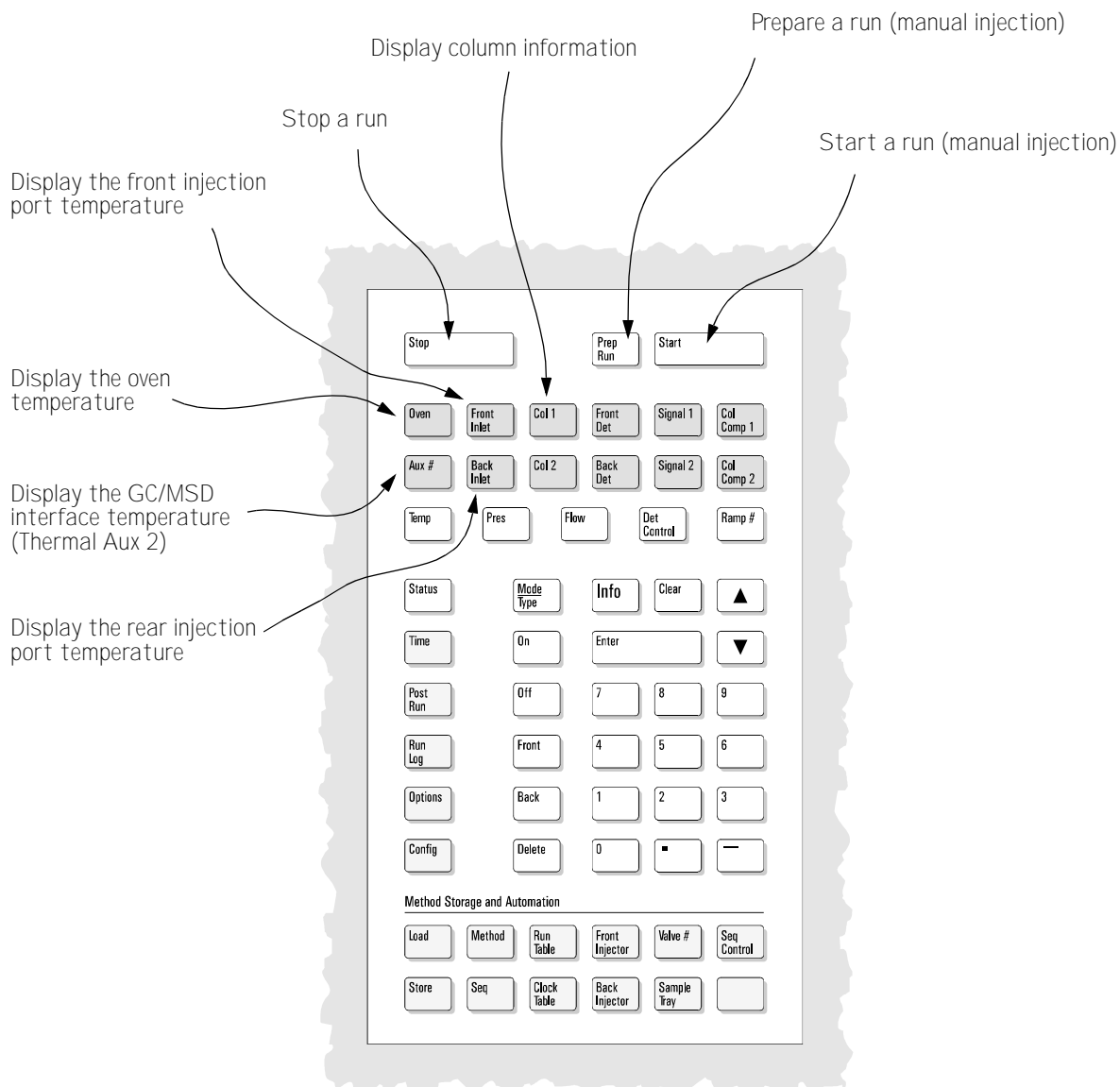

Instrument Control View

The Instrument Control view is displayed when you start up the MSD ChemStation. This is where you set and monitor instrument parameters. If you are in a different view, select **View / Instrument Control** when you are ready to set up the system for data acquisition.

See the online help for more details on the menus, buttons, or windows used in the software.

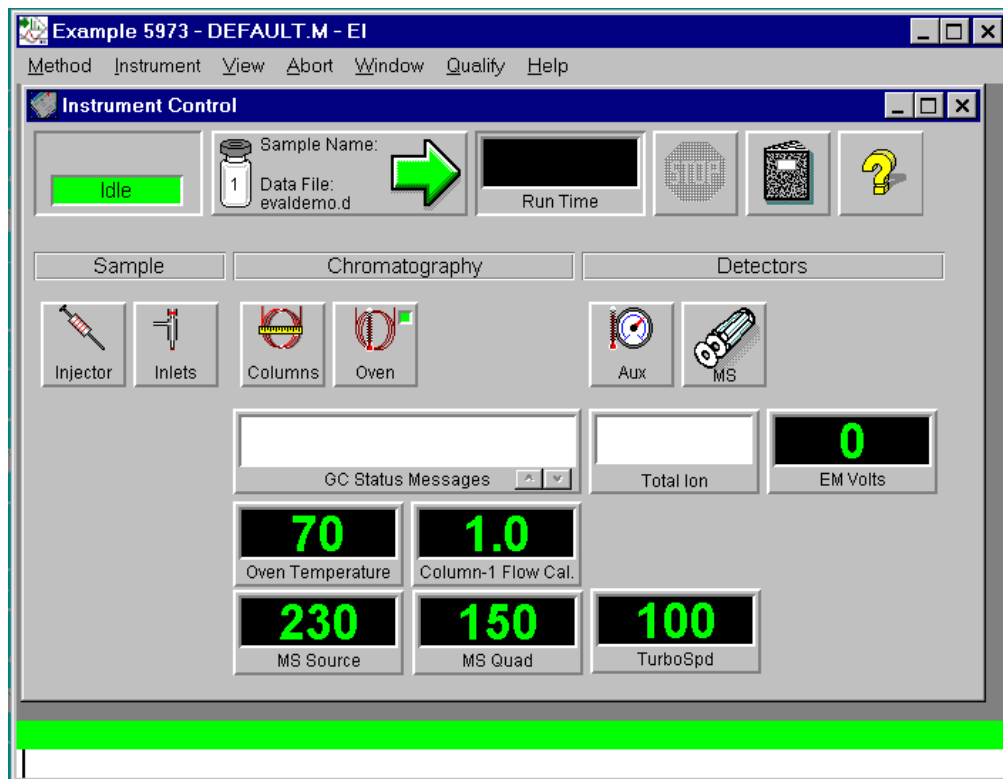

Acquisition Status Lets you tell at a glance the status of the current instrument or run (if any).

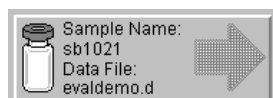

Start Button Lets you start a run. When a run is not in progress, the arrow is green. To start a run, click the green arrow, fill in the Sample Information, and click Start Run. When a run is in progress, the arrow is gray.

This button also shows the current data file name, sample information (if any), and the vial number (1 if no ALS).



Run Time Clock Shows the elapsed time since the beginning of the run if a run is in progress. The scheduled run time is shown below the digital clock. When a run is not in progress, the Run Time clock shows the elapsed time since the last run.



Stop Button Lets you stop the system when it is in Pre-Run, Run, or Post-Run mode. The stop sign is red when a run is in progress and gray when a run is not in progress.



Logbook Button Displays a menu where you can choose to view, open, clear, save, or print a particular logbook.



Help Button Displays a menu where you can select an online help topic for the Instrument Control view. Choose Help Topics to go to the online help for the entire system.



Injector Button Lets you set parameters for the injector when you have configured your system with an ALS.

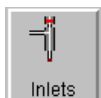

Inlets Button Lets you set parameters for the GC inlet (injection port) that is configured on your system.

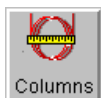

Columns Button Lets you configure columns and set up ramped flow and pressure programs.



Oven Button Displays a menu that lets you edit GC oven parameters or GC monitor parameters. When the GC is ready, the small square in the upper right corner is green. When the GC is not ready, the square is red.

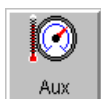

Aux Button Lets you set the temperature of the GC/MSD interface (usually Thermal Aux 2).



MS Button Displays a menu that lets you edit MS acquisition parameters, select another tune file, or edit MS monitors.



Monitor Each monitor displays one instrument parameter. See the online help for a description of the instrument monitors.

Top Menus

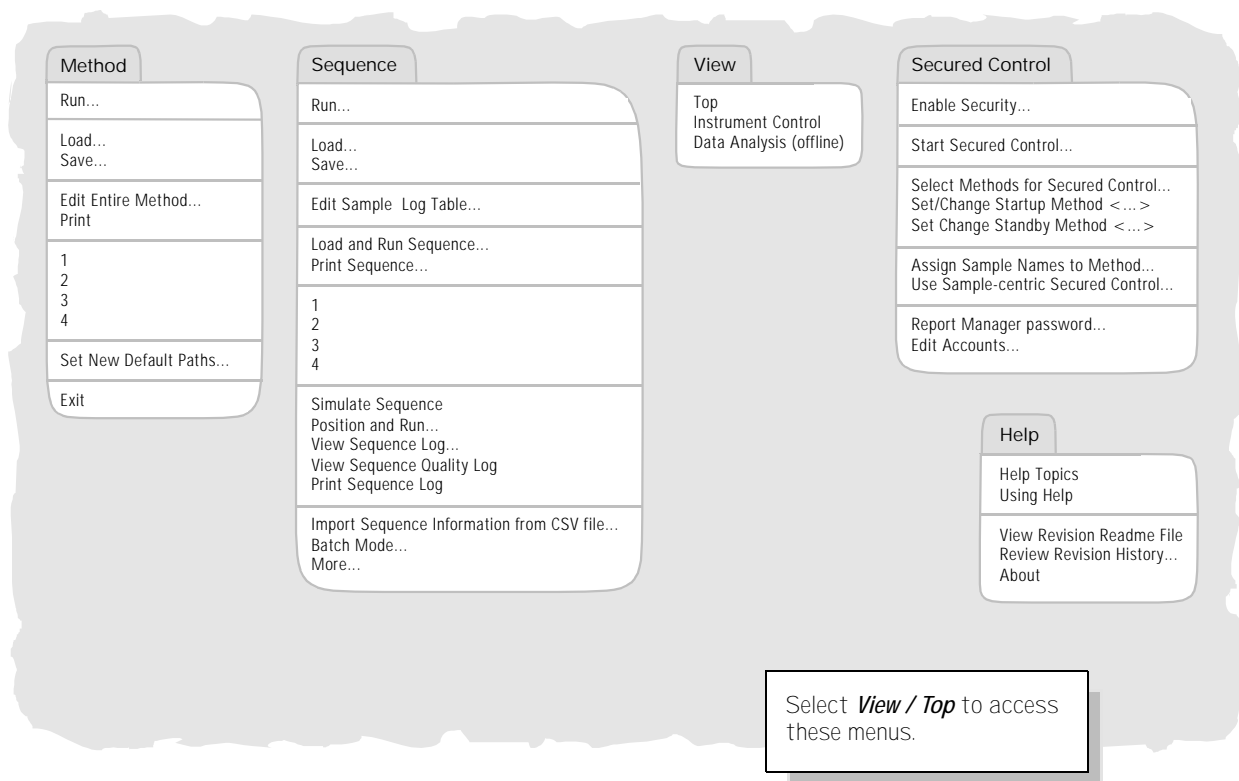

The software menus shown on the following pages are for an MSD ChemStation in Enhanced Mode.

Top Toolbar



Load Sequence

Loads the selected sequence.



Save Sequence

Saves the specified sequence.



Run Sequence

Saves the specified sequence.



Edit Sequence

Lets you set up or modify the sample log table.



Print Sequence

Prints the current sequence.



Simulate Sequence

Simulates the current sequence.



Load Method

Loads the selected method.



Save Method

Saves the specified method.



Run Method

Runs the current method. The Start Run dialog box is displayed.



Edit Method

Lets you modify the method parameters for the current method.



Print Method

Prints the current method.

Instrument Control Menus

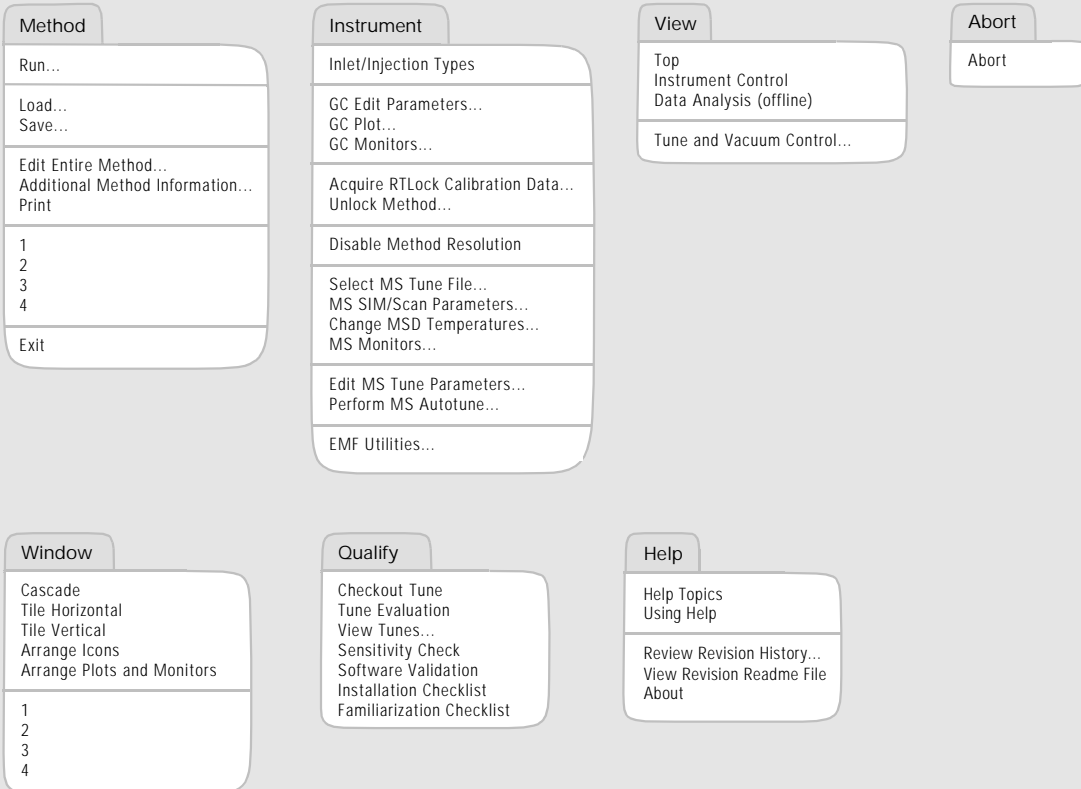

Select **View / Instrument Control** to access these menus.

Tune and Vacuum Control Menus

File

- Reset to Defaults
- Load Tune Values...
- Save Tune Values...

- Trace on
- View Trace...
- Instrument Trace...

- Print
- Printer Orientation...
- Generate Report...

- View Tunes...
- Set View Tunes Report Options...

- Restore Previous Tune(s)...
- Exit

Tune

- Tune MSD
- QuickTune

- Autotune (Atune.U)
- Low Mass Autotune (Lomass.U)

- Standard Spectra Tune (Stune.U)
- DFTPP Tune (DFTPP.U)
- BFB Tune (BFB.U)
- Tune Wizard...

- Air and Water Check
- Tune Evaluation

Vacuum

- Vacuum Status...

- Pump Down...
- Vent...

- Purge Calibrant Valve
- Power-on Temperatures
- Initialize MS Interface

Execute

- MS ON
- MS OFF

- Profile scan
- Repeat profile
- Detailed profile

- Ramp Lenses

- Spectrum scan
- Find mass...

- Determine Mass Axis Correction Factors
- Optimize Quadrupole Frequency

Calibrate

- Mass axis

- Mass #2 widths
- Mass #3 widths
- Peakwidth Linearity

- Adjust Abundances
- Ramp Repeller
- Ramp Ion Focus
- Ramp Entrance Lens
- Ramp Entrance Lens Offset

- Maximize Sensitivity

Parameters

- Manual Tune...

- Edit Tune and Display Parameters...
- Edit MS Temperatures...
- Edit Ramp Parameters...
- Edit Dynamically Ramped Parameters...

Status

- MS Status
- MS I/O Test
- MS Temperature Controller Status

- View Instrument Macro Log...
- View Tune Log...

- Clear Instrument Macro Log...
- Clear Tune Log...

- MS Error Codes...
- Logbook/Sequence Log Error Codes...

View

- Top
- Instrument Control
- Data Analysis (offline)

Abort

- Abort

Help

- Help Topics
- Troubleshooting
- Using Help

- About

Select **View / Tune and Vacuum Control** from Instrument Control to access these menus.

Data Analysis Menus

File

Load Data File...
Next Data File
List Header...
Edit File Info...
Take Snapshot
Subtract Background (BSB)

Select Signals...

Select Printer...
Printer Setup...
Print
Abort

Export Data to CSV File...
Export Data to AIA format...
Import AIA Raw Data Files...

1
2
3

Exit

Method

Run Method...
Run CustomAnalysis

Load Method...
Save Method...

Edit Method...
Edit CustomAnalysis...

Generate AutoSIM Method...

1
2
3

Batch Mode...

Chromatogram

Chromatogram Scaling...
Draw Chromatogram - No Labels
Draw Chromatogram With Labels
Select Chromatogram Labels...

Extract Ion Chromatograms
Display Ion Chromatograms in Merged Format

Select Integrator
MS Signal Integration Parameters...
GC Signal Integration Parameters...
AutoIntegrate
Integrate
Integration Results...
Percent Report

Spectrum

Add
Subtract
Tabulate
Select Library...
Edit Strategy...
Edit Library...

Library Search Report

Change Spectral Display...
Find Mass Spectrum

Calibrate

Set Up Quantitation...
AutoQuant Setup
Edit Compounds...
Update...
List...
Clear...

Quantitate

Calculate
Generate Report

Use Classic Reports
Report Options...

Report Non Target Peaks...
Use Method Aligned GC trace
Trace Mode Quant...

Custom Reports...
Print Report
Update Database

Select Template/Database

Tools

DOLIST...
DOSCAN...
Process Scan List

Export 3-D Data...

Locate A Compound...
Locate All Compounds...

Set Overlay Parameters...
Overlay Chromatograms...

Signal to Noise check...

Change Data State...
Options...
Configure Report Headers...

Generate Screen Results for Current File
Generate Screen Report for Current File
Generate/Print Screen Report for Current File
Generate/Print Screen Report for Multiple Files...
Specify Method Screen Database...
Change Screen Database Parameters...
List Screen Database...
Exclude Zero Qualifiers

Copy Window...
Reset Windows...

View

EasyID
QEdit Quant Result
Edit Non Target Peaks
Parametric Retrieval
Align GC
Review Peak Purity

Results Screener
RTL Lock Setup

Help

Help Topics
Using Help
Review Revision History...
View Revision Readme file
About

Select **View / Data Analysis (offline)** to access these menus.

The View menu in Data Analysis lets you access other Data Analysis modes (shown on the following pages).

EasyID Menus

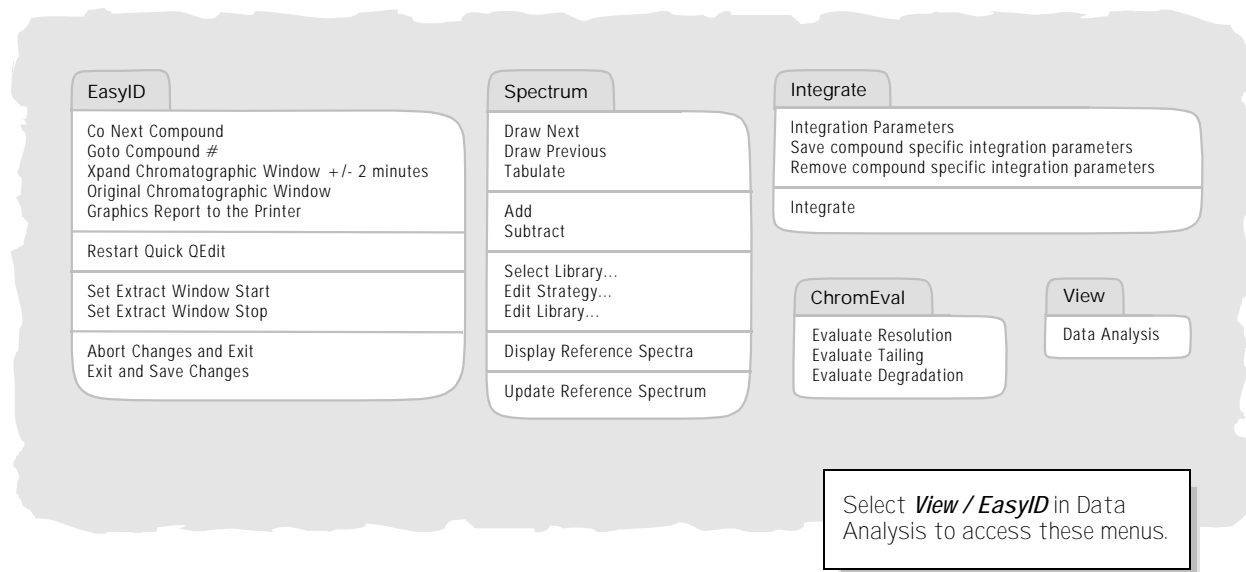

QEdit Menus

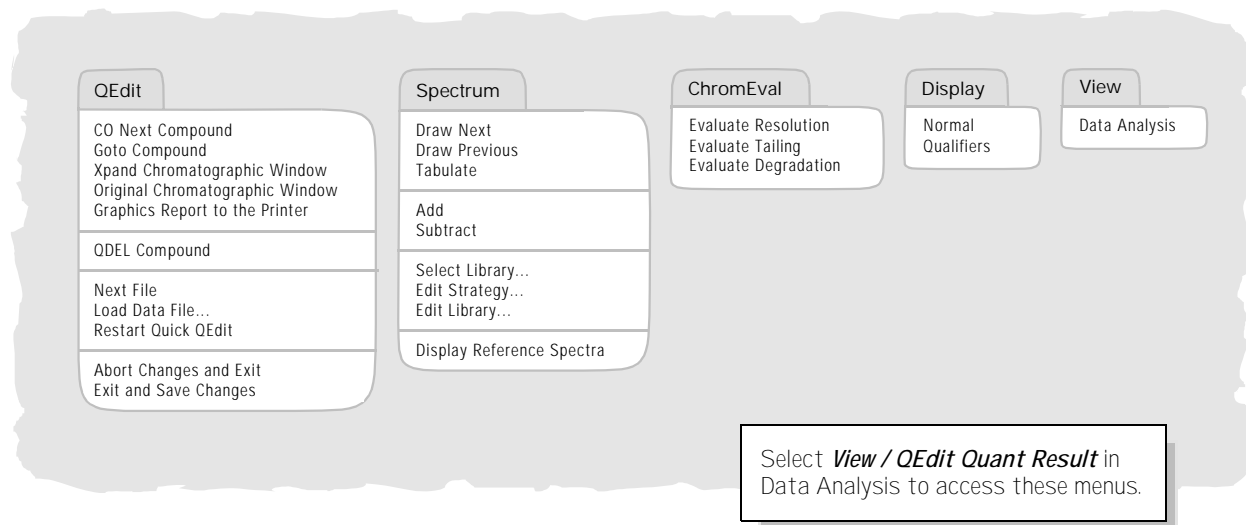

Parametric Retrieval Menus

The diagram illustrates the Parametric Retrieval Menus, organized into eight categories:

- File**
 - Load...
 - List Header
 - Take Snapshot
 - Subtract Background (BSB)
 - Print Current View
 - Save Parameters
 - Abort
 - Exit
- Spectrum**
 - Draw Next
 - Draw Previous
 - Tabulate
 - Add
 - Normalized Subtract
- Library**
 - Select Library...
 - Edit Strategy...
 - Edit Library...
 - Library Search Report...
 - Read JCAMP File...
 - Write JCAMP File...
 - Subset Library...
 - Add Current Entry
- Retrieve**
 - Set Parameters...
 - Select Library...
 - Continue Results
- Structures**
 - Select Structure Database...
 - Set Structure Parameters...
- Options**
 - Select Normalization Ion
 - Extend Database Headers...
 - Command Line
 - Stack
 - Manual Integration
 - Copy Window...
 - Reset Windows
- View**
 - Standard Menu
 - Library Entry Only
 - TIC and Library Entry
 - Unknown and Library Entry
 - Unknown, Library Entry, and Difference
- Help**
 - Help Topics
 - About

Select **View / Parametric Retrieval** in Data Analysis to access these menus.

Align GC Menus

The diagram illustrates the Align GC Menus, organized into two categories:

- Alignment**
 - Show Current Method Alignment Points
 - Perform Alignment
 - Restore Alignment Chromatograms
 - Abort
 - Exit/Save
- View**
 - Data Analysis

Select **View / Align GC** in Data Analysis to access these menus.

Review Peak Purity Menus

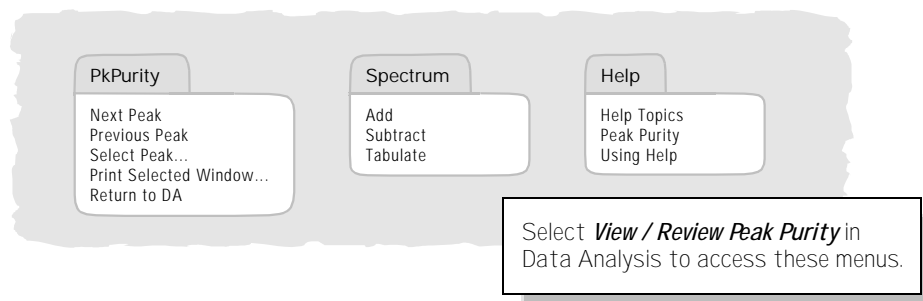

The screenshot shows three menu boxes: PkPurity, Spectrum, and Help. The PkPurity menu includes: Next Peak, Previous Peak, Select Peak..., Print Selected Window..., and Return to DA. The Spectrum menu includes: Add, Subtract, and Tabulate. The Help menu includes: Help Topics, Peak Purity, and Using Help. A callout box at the bottom right states: "Select **View / Review Peak Purity** in Data Analysis to access these menus."

PkPurity

- Next Peak
- Previous Peak
- Select Peak...
- Print Selected Window...
- Return to DA

Spectrum

- Add
- Subtract
- Tabulate

Help

- Help Topics
- Peak Purity
- Using Help

Select **View / Review Peak Purity** in Data Analysis to access these menus.

Quick Screener Menus

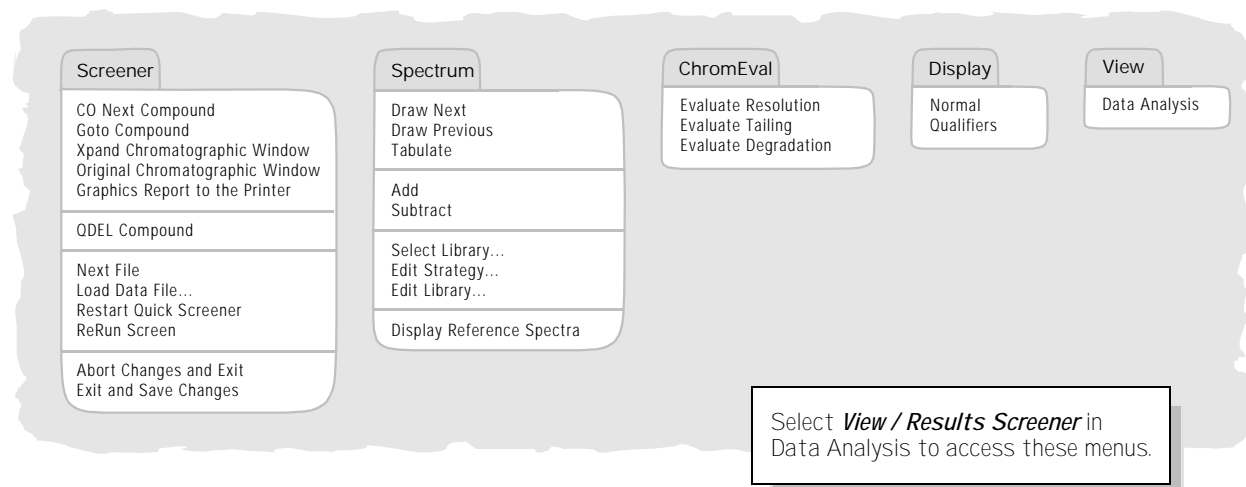

The screenshot shows five menu boxes: Screener, Spectrum, ChromEval, Display, and View. The Screener menu includes: CO Next Compound, Goto Compound, Xpand Chromatographic Window, Original Chromatographic Window, Graphics Report to the Printer, ODEL Compound, Next File, Load Data File..., Restart Quick Screener, ReRun Screen, and Abort Changes and Exit / Exit and Save Changes. The Spectrum menu includes: Draw Next, Draw Previous, Tabulate, Add, Subtract, Select Library..., Edit Strategy..., Edit Library..., and Display Reference Spectra. The ChromEval menu includes: Evaluate Resolution, Evaluate Tailing, and Evaluate Degradation. The Display menu includes: Normal Qualifiers. The View menu includes: Data Analysis. A callout box at the bottom right states: "Select **View / Results Screener** in Data Analysis to access these menus."

Screener

- CO Next Compound
- Goto Compound
- Xpand Chromatographic Window
- Original Chromatographic Window
- Graphics Report to the Printer
- ODEL Compound
- Next File
- Load Data File...
- Restart Quick Screener
- ReRun Screen
- Abort Changes and Exit
- Exit and Save Changes

Spectrum

- Draw Next
- Draw Previous
- Tabulate
- Add
- Subtract
- Select Library...
- Edit Strategy...
- Edit Library...
- Display Reference Spectra

ChromEval

- Evaluate Resolution
- Evaluate Tailing
- Evaluate Degradation

Display

- Normal Qualifiers

View

- Data Analysis

Select **View / Results Screener** in Data Analysis to access these menus.

RTLock Menus

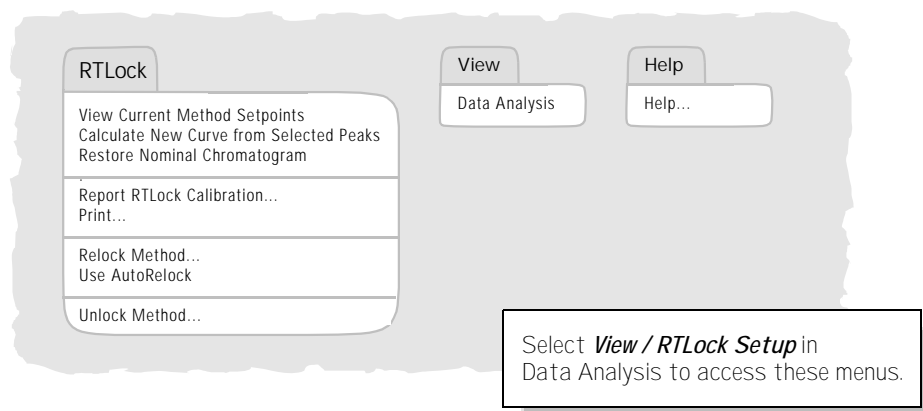

The screenshot shows three menu boxes: RTLock, View, and Help. The RTLock menu includes: View Current Method Setpoints, Calculate New Curve from Selected Peaks, Restore Nominal Chromatogram, Report RTLock Calibration..., Print..., Relock Method..., Use AutoRelock, and Unlock Method.... The View menu includes: Data Analysis. The Help menu includes: Help... A callout box at the bottom right states: "Select **View / RTLock Setup** in Data Analysis to access these menus."

RTLock

- View Current Method Setpoints
- Calculate New Curve from Selected Peaks
- Restore Nominal Chromatogram
- Report RTLock Calibration...
- Print...
- Relock Method...
- Use AutoRelock
- Unlock Method...

View

- Data Analysis

Help

- Help...

Select **View / RTLock Setup** in Data Analysis to access these menus.

Data Analysis Toolbar Buttons



Load Data File Loads the selected data (.D) file and displays the total ion chromatogram (TIC) for that file.



Load Method Loads the selected method (.M) file.



Save Method Saves any changes made to the current method.



Take Snapshot Displays the data that has been acquired up to the time the snapshot is activated. GC/MS data only.



Print Lets you print the selected window, the TIC and spectrum, or the current method.



Copy Window Lets you copy the selected window to the clipboard.



Reset Windows Rearranges the graphics windows to their default positions.



Execute Command Executes the command that is typed into the command line.



Abort Stops a command or macro.



Toggle Command Line Turns the display of the command line on or off.



Edit Colors Lets you adjust the colors of various display items in Data Analysis.



Toggle Graphics Lets you minimize or maximize the displayed graphics.



Close Screen Reports Closes the currently displayed screen reports.



EasyID Lets you update expected retention times and ion ratios for MS data in an existing quantitation database on a compound-by-compound basis.



QEdit Quant Result Lets you review and edit quantitation results once a data file has been quantitated.



Generate Signal-to-Noise Report Lets you perform a signal-to-noise check and then display or print the report.



Review Peak Purity Helps you detect overlapping peaks (multiple-component peaks) in your chromatogram.



Retention Time Locking Accesses the RTLock Setup view which is used for retention time locking tasks.



CUSTOMTOOL1 Lets you run a user-created macro. This macro must first be created and then named CUSTOMTOOL1. See the online help for Using and Writing Macros, and Data Analysis Commands.



CUSTOMTOOL2 Lets you run a user-created macro. This macro must first be created and then named CUSTOMTOOL2. See the online help for Using and Writing Macros, and Data Analysis Commands.



CUSTOMTOOL3 Lets you run a user-created macro. This macro must first be created and then named CUSTOMTOOL3. See the online help for Using and Writing Macros, and Data Analysis Commands.



Draw Chromatogram Redraws the original chromatogram of the current data file without labels or integration marks.



Scale Chromatogram Scales the selected chromatogram by the specified scale factors.



Extract Ion Chromatogram Extracts and displays extracted ion chromatograms (EICs) from the total ion chromatogram (TIC) of the current data file.



Merged Format Causes extracted ion chromatograms to be displayed overlaid on each other.



Overlay Chromatograms Lets you select multiple chromatograms to be displayed superimposed on each other.



AutoIntegrate Tries to find the best integration parameters for the current chromatogram and then integrates the chromatogram.



Integrate Integrates the current chromatogram using parameters set for the current integrator.



Subtract Spectrum Subtracts one spectrum from another and displays the difference.



Select Library Lets you select the libraries that will be used for PBM searches of the currently selected spectrum.



Library Search Report Integrates the current TIC, searches the current library, and generates a report.



Set Up Quantitation Lets you set up a quantitation database by specifying quantitation database globals and entering compounds into the database.



AutoQuant Setup Provides a semi-automated way to create a quantitation database.



Edit Compounds Lets you review and edit information in the quantitation database compound-by-compound.



Update Calibration Lets you add, delete, or update a calibration level in the current quantitation database.



Calculate Quant Report Quantitates the current file and generates a quantitation report.



Generate Quant Report Generates a quantitation report for a file that has already been quantitated.



Print Quant Report Prints the quantitation report.



Custom Reports Starts the Custom Reports software. If the method does not have a quantitation database, or no data file is loaded, you can use default values.



Print Custom Report Prints the custom report template specified by the method using the current data file.



Online Help Displays the MSD ChemStation online help.

To vent (shut down) the MSD

- 1 If your system is equipped with a gauge controller, switch off the triode gauge controller.
- 2 Before venting a CI MSD, press the **Gas Off** button (turns off the reagent gas flow and closes the isolation valve.)

WARNING

On a CI MSD, the Gas Off light must be on when the MSD is venting.

- 3 From the Tune and Vacuum Control view, select **Vent** from the **Vacuum** menu in the software. Follow the instructions presented.
- 4 Set the GC/MSD interface heater and the GC oven temperatures to ambient (25°C).

WARNING

If you are using hydrogen as a carrier gas, the carrier gas flow must be off before turning off the MSD power. If the foreline pump is off, hydrogen will accumulate in the MSD and an explosion may occur. Read the Hydrogen Carrier Gas Safety Guide (5955-5398) before operating the MSD with hydrogen carrier gas.

CAUTION

Be sure the GC oven and GC/MSD interface are cool before turning off carrier gas flow.

- 5 When prompted, turn off the MSD power switch.
- 6 Unplug the MSD power cord.
- 7 Remove the analyzer cover.
- 8 Turn the vent valve knob counterclockwise **only** 3/4 turns or until you hear the hissing sound of air flowing into the analyzer chamber.

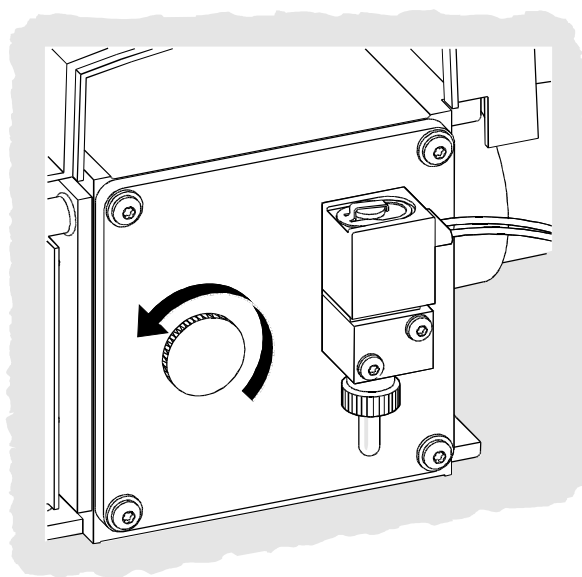

CAUTION

Do not turn the knob too far, or the O-ring may fall out of its groove. Be sure to retighten the knob before pumping down.

WARNING

Allow the analyzer to cool to near room temperature before touching it.

CAUTION

Always wear clean gloves while handling any parts that go inside the analyzer chamber.

WARNING

When the MSD is vented, do not put the ChemStation into the Top view. Doing so will turn on the interface heater.

To pump down (start up) the MSD

- 1 Make sure your system meets all of the following conditions before you pump down:
 - ❑ The vent valve is closed (the knob is turned all the way clockwise.)
 - ❑ All other vacuum seals and fittings are in place and fastened correctly. (The front side plate screw should not be tightened unless hazardous carrier or reagent gases are being used.)
 - ❑ The MSD is connected to a grounded power source.
 - ❑ The GC/MSD interface extends into the GC oven.
 - ❑ A conditioned capillary column is installed in the GC inlet and in the GC/MSD interface.
 - ❑ The GC is on, but the heated zones for the GC/MSD interface, the injection port, and the oven are off.
 - ❑ Carrier gas of at least 99.999% purity is plumbed to the GC with the recommended traps.
 - ❑ If hydrogen is used as carrier gas, carrier gas flow is off and the front sideplate thumbscrew is loosely fastened.
 - ❑ The foreline pump exhaust is properly vented.

WARNING

Make sure your MSD meets ALL the conditions listed above. Failure to do so can result in personal injury.

- 2 Select **Tune and Vacuum Control** from the **View** menu.
- 3 Select **Pump Down** from the **Vacuum** menu.
- 4 When prompted, switch on the MSD.

- 5 Press lightly on the side board to ensure a correct seal.

The rough pump will make a gurgling noise. This noise should stop within a minute. If the noise continues, there is a **large** air leak in your system, probably at the side plate seal, the interface column nut, or the vent valve.

- 6 Once communication with the PC is established, click **OK**. Within 10 to 15 minutes the diffusion pump should be hot, or the turbo pump speed up to 80%. The turbo pump should eventually reach 95%.

CAUTION

If these conditions are not met, the foreline pump will be shut off. You must then power cycle the MSD. If the MSD does not pump down correctly, see the online help for information on troubleshooting air leaks and other vacuum problems.

- 7 When prompted, turn on the GC/MSD interface heater and GC oven. Click **OK** when you have done so. The software will turn on the ion source and mass filter (quad) heaters. The temperature setpoints are stored in the current autotune (*.u) file.

CAUTION

Do not turn on any GC heated zones until carrier gas flow is on. Heating a column with no carrier gas flow will damage the column.

- 8 After the message **Ok to run** appears, wait two hours for the MSD to reach thermal equilibrium.

CAUTION

Data acquired before the MSD has reached thermal equilibrium might not be reproducible.

To tune your MSD

You should tune the MSD periodically to maintain its optimum performance. Tuning is the process of adjusting MSD parameters so the instrument meets certain performance criteria. How often you should tune is determined by the number and type of samples you are running, as well as the overall condition of your system.

Note Always tune the MSD with the same GC oven temperature and column flow, and the same analyzer temperature that will be used for data acquisition.

Keep the Tune reports in a notebook so that successive reports can be easily compared.

To use Autotune

- 1 From the Instrument Control view, select **Perform MS Autotune** from the **Instrument** menu.
- 2 Select one of the following options, depending on the instrument performance required by your application, then click **OK**.
 - Autotune**
Results in maximum sensitivity over the full scan range.
 - Low Mass Autotune**
Tunes for the low-mass range.
 - Standard Spectra Tune**
Results in a standard response over the full scan range. This option may reduce sensitivity.
 - QuickTune**
Adjusts the peak width, mass assignment, and abundance without changing ion ratios.
- 3 Review the Tune report.
- 4 To view the history of tune results, select **View Tunes** from the **Qualify** menu.

To use Manual Tune

Manual tuning lets you interactively set the MSD parameters, such as lens voltages and tuning masses, to values that meet the needs of your particular analysis. You can often obtain greater sensitivity than you can with autotune.

Manual tuning allows you to ramp individual parameters and to specify the range and step size for the ramp. The results of the ramp are displayed visually with the optimum value for the parameter clearly marked on the plot.

You can acquire two types of data in manual tune: profile scans (plots the abundance and peak shape of the tune masses) and spectrum scans (scans plot response across the entire mass range).

See the online help for more details about manual tuning.

To acquire data

To set up the GC for use with the MSD

- 1 Select **Instrument / Inlet/Injection Types**. Select the appropriate injection source and select the **Use MS** checkbox. Click **OK**.
- 2 Click the **Aux** button. Verify that you are using auxiliary channel 2, the heater is on and set to the desired temperature, and that **MSD** is selected as the Type. Click **OK**.
- 3 Click the **Columns** button. Verify that the detector is **MSD** and that **Vacuum** is selected for Outlet psi. Click **OK**.

To inject a sample with the autosampler

- 1 Place the autosampler vial containing the sample into the autosampler tray.
- 2 Select **Run** from the **Method** menu in the Top or Instrument Control view.
- 3 When the Start Run box appears, specify the sample information:
 - Specify a unique data file name for the sample.
 - Enter the position number of the sample vial in the **Vial** field (1 – 100).
 - (optional) Fill in the **Operator Name**, **Sample Name**, and **Misc Info** fields to document the injection.
 - Make sure that the **Data Acquisition** option is selected. Select the Data Analysis option if you want to generate any of the reports specified in the method.
- 4 Click **Run Method** to initiate the run.

CAUTION

Do **not** use the Start button on the GC to start a run when using the autosampler.

To inject a sample manually

- 1 Select **Manual** as the injection source on the Inlet and Injection Parameters box.
- 2 Press the **Prep Run** key on the GC keypad. This cancels the gas saver flow, brings the inlet flow to its setpoint value, and closes the purge valve (for splitless injection only).
- 3 Select **Run** from the **Method** menu from the Top or Instrument Control view.
- 4 When the Start Run box appears, specify the sample information as described below:
 - Specify a unique data file name for the sample.
 - (optional) Fill in the **Operator Name**, **Sample Name**, and **Misc Info** fields to document the injection.
 - Make sure that the **Data Acquisition** option is selected.
 - (optional) Select the **Data Analysis** option if you want to generate any Data Analysis reports specified in the method.
- 5 Click **Run Method** to initiate the run. If the temperatures are stable, the Prepare To Inject box appears. Otherwise, the message **Waiting for GC ready** is displayed.
- 6 When the GC temperatures have stabilized (the **Pre Run** light on the GC is steady), inject the sample and press **Start** on the GC.

CAUTION

Do not inject before the GC is ready. This will cause inconsistent results.

To analyze MS data

To load a data file

- 1 In Data Analysis, select **Load** from the **File** menu.
- 2 Select a data file (double-click on a file name or type a name and click **OK**). The chromatogram for the data file is loaded and displayed in window [2].

A data file must be loaded to perform any of the following tasks.

To integrate a chromatogram

- 1 If the integrator you wish to use is not currently selected, open the **Chromatogram** menu and click **Select Integrator**. Choose an integrator and click **OK**.
- 2 Select **Integrate** from the **Chromatogram** menu.
- 3 (optional) Select **List Results** from the **Chromatogram** menu. A report of tabulated results is displayed on the screen. When you are finished viewing the results, click **Done**.

To select a spectrum

- Double-click the **right** mouse button on the time point of interest in the chromatogram. The spectrum appears in window [1].

To zoom in

- 1 Position the pointer at one corner of the area you wish to expand in a chromatogram or spectrum.
- 2 Press and hold the **left** mouse button while dragging the mouse to select the area you wish to expand.
- 3 Release the mouse button. The selected area expands to fill the existing window.

To zoom out

- 1 Position the pointer anywhere in the zoomed window.
- 2 Double-click the **left** mouse button.

To average spectra

- 1 Position the pointer in the chromatogram at the starting time for the range you want to average.
- 2 Press the **right** mouse button while dragging the mouse to the end of the range you want to average.
- 3 Release the mouse button. The spectra in the selected range are averaged and the averaged spectrum is displayed in window [1].

To add two spectra

- 1 Select a spectrum (double-click the **right** mouse button in the chromatogram).
- 2 Select a second spectrum (double-click the **right** mouse button in the chromatogram).
- 3 Select **Add** from the **Spectrum** menu. The two spectra are added together and the resulting spectrum is displayed in window [1].

To subtract two spectra

- 1 Select a spectrum (double-click the **right** mouse button in the chromatogram).
- 2 Select the spectrum to be subtracted (double-click the **right** mouse button in the chromatogram).
- 3 Select **Subtract** from the **Spectrum** menu. The spectrum selected in Step 2 is subtracted from the spectrum selected in Step 1 and the resulting spectrum is displayed in window [1].

To subtract background spectra

- 1 Select a spectrum or average a range of spectra to subtract from the data file.
- 2 Select **Subtract Background (BSB)** from the **File** menu. The system performs the following tasks:
 - The selected spectrum is subtracted from every scan in the current data file.
 - The subtracted data is stored in a BSB subdirectory in the same directory as the data file.
 - The subtracted data file becomes the current data file and is displayed in window [2].

To use spectral libraries

To integrate and search peaks

Use the following procedure to integrate a total ion chromatogram and automatically generate a library search report for each peak detected.

- 1 In Data Analysis, load a data file. The TIC is displayed.
- 2 Select **Spectrum / Library Search Report**.
- 3 When the Library Search Report Options dialog box appears, select the options you want for the library search report:
 - Select either **Summary** or **Detailed** to determine the report format.
 - Select one or more destinations (**Screen**, **Printer**, and **File**).
 - Select an **Integration Parameter File** (leave the field blank to autointegrate using the ChemStation integrator).
 - Select which spectrum from each peak to use (**Apex**, **Apex - Start of Peak**, **Apex - Background at time**, or **Peak Average**).
- 4 Click **OK** to initiate the search.

The chromatogram is integrated and a spectrum from each peak is searched. The results of the integration appear on the screen. The library search report is sent to the destinations selected in Step 4.
- 5 Select **Chromatogram / Integration Results** to view the tabulated integration results.

To search a single spectrum

- 1 In Data Analysis, load a data file. The TIC is displayed.
- 2 Select a spectrum. The selected spectrum appears in a window below the chromatogram.
- 3 Initiate the library search by double-clicking the right mouse button in the window containing the spectrum.

When the search is complete, the search results appear on the screen. The spectrum for the unknown, the reference spectrum you select from the list of hits, and, if available, the chemical structure of the reference compound is displayed.
- 4 To view other spectral data:
 - Click on another compound in the hit list to display a different reference spectrum.
 - Select the **Difference** checkbox to display the difference between the unknown and the reference spectra.
- 5 To view other information:
 - Click the **Statistics** button to display information about the quality of each hit found in the list.
 - Click the **Text** button to view the header information stored in the library for the current reference spectrum.
- 6 Click the **Print** button to print a copy of the displayed spectra.
- 7 Click the **Done** button to clear the library search results from the screen.

Maintenance Schedule

Maintenance tasks are described in the hardware manuals supplied with your system. How often you need to perform system maintenance may vary for your system. Keep a maintenance record.

Every day

Check, and if necessary, replace the septum.
Check the tightness of the injection port liners.
Check the tightness of the column nuts.

Every week

Check the foreline pump fluid level.
Change the injection port liners and O-rings.

Every month

Clean the split/splitless inlet vent line trap.
Check for leaks (inlet, column connections).

Every three months

Replace gas cylinders (when below 500 psig).

Every six months

Replace the foreline pump fluid.
Check, and if necessary, refill the calibration vial.

Every year

Check, and if necessary, replace the diffusion pump fluid.
Recondition or replace internal and external traps and chemical filters on the GC.

As needed

Tune the MSD.
Clean the ion source.
Replace the carrier gas trap.
Replace worn out parts (filaments, EM, etc.).
Replace the column.
Lubricate seals.

Safety warnings

WARNING

Do not perform maintenance with the MSD on or connected to its power source unless specifically instructed to by documentation supplied with the MSD.

WARNING

The GC/MSD interface can be on and at a dangerously high temperature even though the MSD is off. After it is turned off, the GC/MSD interface cools very slowly. Make sure all parts have cooled before handling them.

WARNING

Be careful when working behind the GC. During cool-down cycles, the GC will emit hot exhaust that could cause burns.

WARNING

The oil trap provided for your foreline pump stops only foreline pump oil. If you are analyzing toxic chemicals or using toxic solvents, remove the oil trap and use a hose to route the foreline pump exhaust out of your laboratory.

WARNING

Use chemical-resistant gloves and safety glasses when replacing pump fluid. Avoid all contact with the fluid.

WARNING

The insulation around the inlets, detectors, valve box, and insulation cups is made of refractory ceramic fibers (RCF). Avoid inhalation of RCF particles. Ventilate your work area, wear long sleeves, gloves, safety glasses, and a disposable respirator. Dispose of insulation in a sealed plastic bag. Wash your hands with mild soap and cold water after handling RCFs.

Operating Tips

- ❑ Back up your data and methods **regularly** to avoid loss of data if the files are accidentally overwritten or deleted, or if a hardware problem develops with your disk drive.
- ❑ Make sure the tune file you are using is appropriate for your samples.
- ❑ Save Tune reports in a notebook for future reference.
- ❑ Perform system maintenance as indicated by the maintenance schedule in the GC and MSD hardware documentation. Keep a record of all maintenance performed.
- ❑ When venting the MSD, take advantage of the cool GC to do maintenance such as replacing inlet liners, septa, etc.
- ❑ After pumpdown, wait **at least 2 hours** for the MSD to reach thermal equilibrium before tuning or acquiring data.
- ❑ Optimum sensitivity generally occurs at column flow rates of 1.2 ml/minute or less.
- ❑ When injecting volumes greater than one microliter, use the pulsed splitless mode and increase the initial oven temperature 10 – 20°C.
- ❑ For splitless injections, pulsed splitless mode gives more quantitative sample transfer onto the column. A pulse pressure of twice the initial inlet pressure is typical.
- ❑ Selecting Constant Flow mode will provide the most efficient separation in most cases. It also results in constant sensitivity throughout the temperature program.
- ❑ For a new column, check that the column nuts are still tight after the first few oven temperature cycles.
- ❑ Use the Config Status keys on the GC keypad to set the 3 display items most important to you (time remaining, oven temp, etc.). These are then always visible regardless of which ChemStation view is on top.
- ❑ Rinse and refill autosampler wash vials. Do not add more solvent to a partially full vial.
- ❑ Use the following table as a guide to using the SIM or Scan acquisition modes.

<i>Task</i>	<i>Mode</i>
Analyze a mixture with unknown components.	Scan
Analyze a mixture with known components in unknown amounts (quantitate).	Scan or SIM
Identify the presence of a few known compounds at low levels within a mixture.	SIM

- ❑ When choosing masses for SIM, use the exact mass printed in the Tabulation report, not the nominal mass annotated on the spectrum display. This provides more accurate data.
- ❑ When doing SIM analysis, use low resolution mode unless you are trying to determine the ratios of masses one amu apart. Low resolution provides maximum sensitivity and repeatability.
- ❑ Choose the narrowest scan range that still produces good library search results. This allows more spectra across the peak and better quantitation.

Troubleshooting Tips

MSD is on, but status flashing "Server not found! Check LAN connection"

This is normal when the MSD is initially turned on. It means the ChemStation has not yet established contact with the MSD. If the flashing continues after the pumpdown is initiated:

- 1 Temporary power failure interrupted communications
- 2 Bad connection between the MSD and the ChemStation and/or the hub

No peaks

- 1 Incorrect sample concentration
- 2 No analytes present
- 3 Syringe missing or not installed correctly (ALS only)
- 4 Empty sample vial
- 5 Injection in split mode instead of splitless mode

Tailing peaks

- 1 Active sites in sample path
- 2 Injection too large
- 3 Injection port too cool
- 4 Column flow too low
- 5 GC/MSD interface or ion source too cool

Peaks with flat tops

- 1 Solvent delay time too short
- 2 Display scale is wrong
- 3 Injection too large
- 4 Electron multiplier voltage too high

Peaks with split tops

- 1 Bad injection technique
- 2 Injection too large

Rising baseline

- 1 Column bleed
- 2 Other contamination

Retention time (RT) drift

- 1 Column has been shortened (shorter RT)
- 2 Old column (shorter RT)
- 3 Active sites in sample path (longer RT)
- 4 Reduced column flow (longer RT)
- 5 Injection port leak (longer RT)
- 6 Initial oven temperature changed (up = shorter RT, down = longer RT)

Poor sensitivity

- 1 Incorrect tuning
- 2 Tune file does not match type of analysis
- 3 Incorrect temperatures
- 4 Incorrect sample concentration
- 5 Leaking injection port
- 6 Incorrect split ratio
- 7 Purge off time in splitless mode too short
- 8 Excessive pressure in the MSD
- 9 Dirty ion source
- 10 Air leak
- 11 Detector is not working correctly
- 12 Poor filament operation
- 13 Incorrect mass filter polarity

Poor repeatability

- 1 Dirty syringe needle
- 2 Leaking injection port
- 3 Mismatched injection port liner and injection size
- 4 Loose column connections
- 5 Variations in pressure, column flow, and temperature
- 6 Dirty ion source
- 7 Loose connections in the analyzer
- 8 Ground loop

Inconsistent peakwidths

- 1 Incorrect tuning
- 2 No PFTBA in calibration vial
- 3 Calibration valve failure
- 4 Dirty ion source
- 5 Worn out electron multiplier
- 6 MSD has not had enough time to reach thermal equilibrium
- 7 Large variations in the temperature of the lab

High background in mass spectra

- 1 Air leak
- 2 Foreline or vacuum manifold pressure too high
- 3 Other contamination

Ions at m/z 18, 28, 32, and 44

- 1 Detector vented recently (residual air and water)
- 2 Air leak

Isotopes missing or isotope ratios incorrect

- 1 Incorrect tuning
- 2 Dirty ion source
- 3 High background
- 4 Electron multiplier voltage too high
- 5 Repeller voltage too high
- 6 High scan speed (Scan mode)
- 7 Low dwell time (SIM mode)
- 8 Peaks too wide or too narrow
- 9 Repeller and ion focus leads have been reversed

Foreline or vacuum manifold pressure too high

- 1 Excessive column flow
- 2 Air leak
- 3 Diffusion pump fluid level too low
- 4 Diffusion pump fluid is contaminated
- 5 Foreline pump oil level too low
- 6 Foreline pump oil is contaminated
- 7 Constricted foreline hose (this would cause the vacuum manifold pressure to be too high but the foreline pressure to be too low)

Refer to the Troubleshooting the MSD section of the online help for more detailed information.



What's in this Book

What's New in Revision D.01.00, 2
Using Online Help, 3
5973 MSD with a 6890 GC, 4
GC Keypad, 5
Instrument Control View, 6
Software Menus (Enhanced Mode), 8
Data Analysis Toolbar Buttons, 16
To vent (shut down) the MSD, 18
To pump down (start up) the MSD, 19
To tune your MSD, 20
To acquire data, 21
To analyze MS data, 22
To use spectral libraries, 23
Maintenance Schedule, 24
Operating Tips, 25
Troubleshooting Tips, 26

Document History

First Edition, 9/03
G1701DA MSD ChemStation
Rev. D.01.00



Printed on recycled paper

G1701-90050
G1701-90050

Manual Part Number
G1701-90050

Copyright © 2003
Agilent Technologies
Printed in U.S.A. 9/03