

OMRON



User's Manual

Cat. No. H085-E1-03

Preface

Thank you for your purchase of your E5EK, intelligent digital controller.

The E5EK allows the user to carry out the following:

- Select from many types of temperature and analog input (multiple input)
- Support position-proportional control (position-proportional type controllers only).
- Select output functions such as control output or alarm (output assignment)
- Use the HBA (heater burnout alarm) function (standard type controllers only).
- Use four setpoints (multi-SP function)
- Use remote SP input.
- Monitor the control loop by LBA (Loop Break Alarm)
- Use the communications function
- Calibrate input or transfer output
- It also features a watertight construction (NEMA4: equivalent to IP66)

This User's Manual describes how to use the E5EK compact, high-function digital controller.

Before using your E5EK, thoroughly read and understand this manual in order to ensure correct use.

About this manual

© OMRON, 1996

- (1) All rights reserved. No part of this publication may be reproduced, stored in a retrieval system, or transmitted, in any form, or by any means, mechanical, electronic, photocopying, recording, or otherwise, without the prior written permission of OMRON.
- (2) No patent liability is assumed with respect to the use of the information contained herein.
- (3) Moreover, because OMRON is constantly striving to improve its high-quality products, the information in this manual is subject to change without notice. Every precaution has been taken in the preparation of this manual. Nevertheless, OMRON assumes no responsibility for errors or omissions. Neither is any liability assumed for damages resulting from the use of the information contained in this publication.

Conventions Used in This Manual

■ Meanings of Abbreviations

Sometimes the following abbreviations are used in parameter names, figures and in text explanations. These abbreviations mean the following.

Abbreviation	Term
PV	Process value
SP	Set point
RSP	Remote set point
LSP	Local set point
LBA	Loop break alarm
HB	Heater burnout
AT	Auto-tuning
ST	Self-tuning

■ How to Read Display Symbols

The following tables show the correspondence between the symbols displayed on the displays and alphabet characters.

A	b	c	d	e	f	G	H	i	J	K	L	M
A	B	C	D	E	F	G	H	I	J	K	L	M

n	o	P	q	r	S	t	U	v	w	x	y	Z
N	O	P	Q	R	S	T	U	V	W	X	Y	Z

■ “Reference” mark

This mark indicates that extra, useful information follows, such as supplementary explanations and how to apply functions.



■ Notice:

OMRON products are manufactured for use according to proper procedures by a qualified operator and only for the purposes described in this manual.

The following conventions are used to indicate and classify precautions in this manual. Always heed the information provided with them. Failure to heed precautions can result in injury to people or damage to the product.

 **DANGER**

Indicates information that, if not heeded, is likely to result in loss of life or serious injury.

 **WARNING**

Indicates information that, if not heeded, could possibly result in loss of life or serious injury.

 **Caution**

Indicates information that, if not heeded, could result in relatively serious or minor injury, damage to the product, or faulty operation.

■ How this Manual is Organized

Purpose	Title	Description
<ul style="list-style-type: none"> ● Learning about the general features of the E5EK 	Chapter 1 Introduction	This chapter describes the features of the E5EK, names of parts, and typical functions.
<ul style="list-style-type: none"> ● Setting up the E5EK 	Chapter 2 Preparations	This chapter describes the operations that you must carry out (e.g. installation, wiring and switch settings) before you can use the E5EK.
<ul style="list-style-type: none"> ● Basic E5EK operations 	Chapter 3 Basic Operation Chapter 5 Parameters	These chapters describe how to use the front panel keys and how to view the display when setting the parameters of the major functions for the E5EK.
<ul style="list-style-type: none"> ● Applied E5EK operations 	Chapter 4 Applied Operation Chapter 5 Parameters	These chapters describe the important functions of the E5EK and how to use the parameters for making full use of the E5EK.
<ul style="list-style-type: none"> ● Using a Position-proportional Type Controller 	Chapter 4 Applied Operation/4.1 Selecting the Control Method	This chapter describes the functions related specifically to position-proportional type controllers.
<ul style="list-style-type: none"> ● Communications with a host computer 	Chapter 6 Using the Communications Function	This chapter mainly describes the communications commands, and gives program examples.
<ul style="list-style-type: none"> ● Calibration 	Chapter 7 Calibration	This chapter describes how the user should calibrate the E5EK.
<ul style="list-style-type: none"> ● Troubleshooting 	Chapter 8 Troubleshooting	This chapter describes what to do if any problems occur.

Pay Attention to the Following when Installing this Controller

- If you remove the controller from its case, never touch nor apply shock to the electronic parts inside.
- Do not cover the area around the E5EK. (Ensure sufficient space around the controller to allow heat radiation.)
- Use a voltage (AC100-240V~ or AC/DC24V≈ at 50 to 60 Hz). At power ON, the prescribed voltage level must be attained within two seconds.
- When wiring input or output lines to your controller, keep the following points in mind to reduce the influence from inductive noise:
 - Allow adequate space between the high voltage/current power lines and the input/output lines.
 - Avoid parallel or common wiring with high voltage sources and power lines carrying large currents.
 - Using separating pipes, duct, and shielded line is also useful in protecting the controller, and its lines from inductive noise.
- Allow as much space as possible between the controller and devices that generate a powerful, high frequency (high-frequency welders, high-frequency sewing machines, and so forth) or surge. These devices may cause malfunctions.
- If there is a large power-generating peripheral device and any of its lines, attach a surge suppressor or noise filter to the device to stop the noise affecting the controller system. In particular, motors, transformers, solenoids and magnetic coils have an inductance component, and therefore can generate very strong noises.
- When mounting a noise filter, be sure to first check the filter's voltage and current capacity, then mount the filter as close as possible to the controller.
- Do not use the controller in places where icing, condensation, dust, corrosive gas (especially sulfurized gas or ammonia gas), shock, vibration, splashing liquid, or oil atmosphere occur. Also, avoid places where the controller can be subjected to intense heat radiation (like from a furnace) or sudden temperature changes.
- Ambient temperature must be kept between -10°C to 55°C. Ambient humidity must be kept between 35%RH to 85%RH (with no icing or condensation). If the controller is installed inside a control board, the ambient temperature must be kept under 55°C, including the temperature around the controller. If the controller is subjected to heat radiation, use a fan to cool the surface of the controller to under 55°C.
- Store the controller at an ambient temperature between -25°C to 65°C. The ambient humidity must be between 35%RH to 85%RH (with no icing or condensation).
- Never place heavy objects on, or apply pressure to the controller that may cause it to deform and deterioration during use or storage.
- Avoid using the controller in places near a radio, television set, or wireless installation. These devices can cause radio disturbances which adversely affect the performance of the controller.

Table of Contents

Preface	I
Conventions Used in This Manual	II
Pay Attention to the Following when Installing this Controller	V
CHAPTER 1 INTRODUCTION	1-1
This chapter introduces the E5EK. First-time users should read this chapter without fail. For details on how to use the controller and parameter settings, see Chapters 2 onwards.	
1.1 Names of parts	1-2
1.2 Input and Output	1-4
1.3 Parameters and Menus	1-7
1.4 About the Communications Function	1-10
1.5 About Calibration	1-11
CHAPTER 2 PREPARATIONS	2-1
This chapter describes the operations you should carry out before turning the E5EK ON.	
2.1 Setting up	2-2
2.2 Installation	2-5
2.3 Wiring Terminals	2-8
CHAPTER 3 BASIC OPERATION	3-1
This chapter describes an actual example for understanding the basic operation of the E5EK.	
3.1 Convention Used in this Chapter	3-2
3.2 Setting Input Specifications	3-4
3.3 Setting Output Specifications	3-6
3.4 Setting Alarm Type	3-9
3.5 Protect Mode	3-12
3.6 Starting and Stopping Operation	3-13
3.7 Adjusting Control Operation	3-14
CHAPTER 4 APPLIED OPERATION	4-1
This chapter describes each of the parameters required for making full use of the features of the E5EK. Read this chapter while referring to the parameter descriptions in chapter 5.	
4.1 Selecting the Control Method	4-2
4.2 Operating Condition Restrictions	4-5
4.3 How to Use Event Input	4-8
4.4 How to Use the Remote SP	4-11
4.5 How to Use the Heater Burnout Alarm	4-13
4.6 LBA	4-15
4.7 How to Use Transfer Output	4-17

CHAPTER 5 PARAMETERS 5-1

This chapter describes the parameters of the E5EK. Use this chapter as a reference guide.

Protect Mode	5-3
Manual Mode	5-5
Level 0 Mode	5-6
Level 1 Mode	5-10
Level 2 Mode	5-18
Setup Mode	5-25
Expansion Mode	5-32
Option Mode	5-37
Calibration Mode	5-46

CHAPTER 6 USING THE COMMUNICATIONS FUNCTION . . 6-1

This chapter mainly describes communications with a host computer and communications commands.

6.1 Outline of the Communications Function	6-2
6.2 Preparing for Communications	6-3
6.3 Command Configuration	6-5
6.4 Commands and Responses	6-6
6.5 How to Read Communications Error Information	6-12
6.6 Program Example	6-14

CHAPTER 7 CALIBRATION 7-1

This chapter describes procedures for each calibration operation. Read this chapter only when the controller must be calibrated.

7.1 Structure of Parameters	7-2
7.2 Calibrating Thermocouple	7-4
7.3 Calibrating Platinum Resistance Thermometer	7-7
7.4 Calibrating Current Input	7-9
7.5 Calibrating Voltage Input	7-10
7.6 Checking Indication Accuracy	7-12

CHAPTER 8 TROUBLESHOOTING 8-1

This chapter describes how to find out and remedy the cause if the E5EK does not function properly.

8.1 Initial Checks	8-2
8.2 How to Use the Error Display	8-3
8.3 How to Use Error Output	8-5
8.4 Checking Operation Restrictions	8-6

APPENDIX

SPECIFICATIONS	A-2
ABOUT CURRENT TRANSFORMER (CT)	A-5
CONTROL BLOCK DIAGRAM	A-6
SETTING LIST	A-8
MODEL LIST	A-11
PARAMETER OPERATIONS LIST	A-12
FUZZY SELF-TUNING	A-14
X FORMAT	A-17
ASCII CODE LIST	A-20

INDEX

REVISION HISTORY

K CHAPTER 1

INTRODUCTION

This chapter introduces the E5EK. First-time users should read this chapter without fail.

For details on how to use the controller and parameter settings, see Chapters 2 onwards.

1.1	Names of parts	1-2
	Main parts	1-2
	Front panel	1-2
	About the displays	1-3
	How to use keys	1-3
1.2	Input and Output	1-4
	Input	1-4
	Output	1-5
1.3	Parameters and Menus	1-7
	Parameter types	1-7
	Selecting modes	1-8
	Selecting parameters	1-9
	Fixing settings	1-9
1.4	About the Communications Function	1-10
1.5	About Calibration	1-11

1.1 Names of parts

■ Main parts

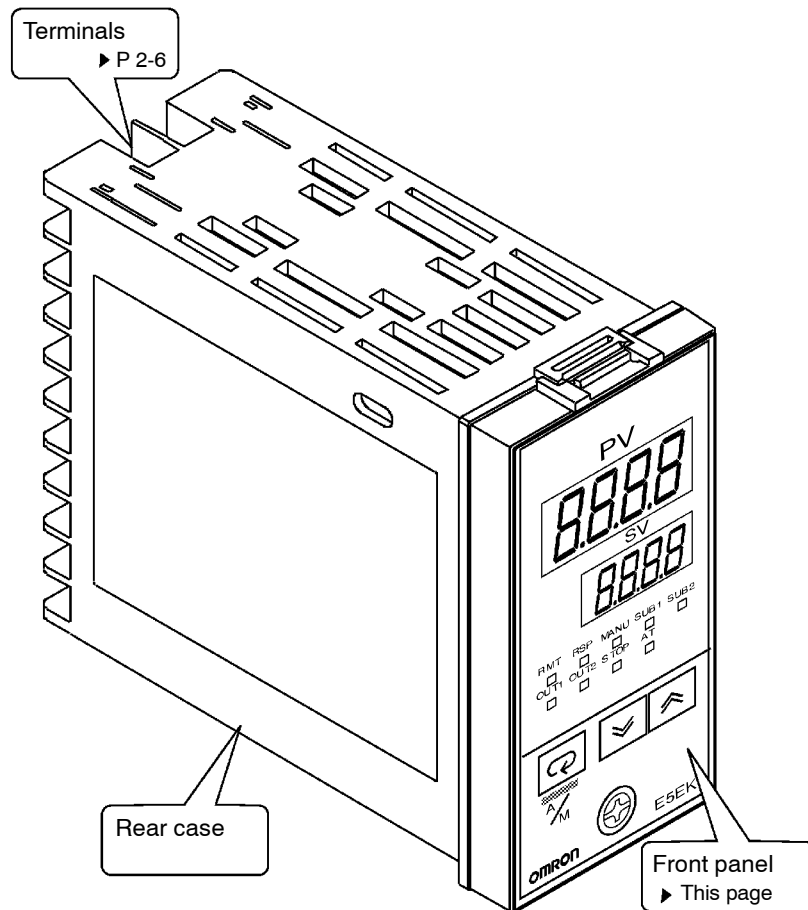

■ Front panel

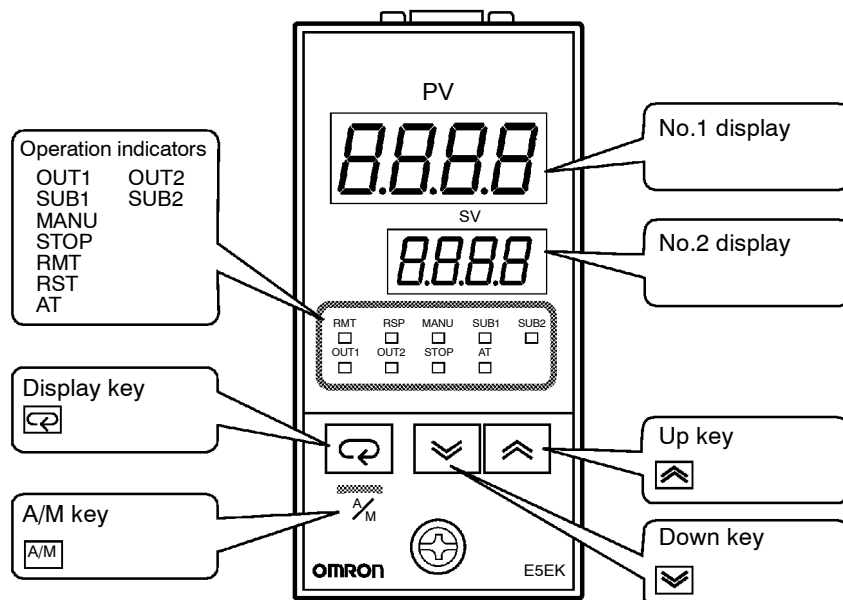







■ About the displays

- **No.1 display** Displays the process value or parameter symbols.
- **No.2 display** Displays the set point, manipulated variable or parameter settings.
- **Operation indicators**
 - OUT1 : Lit when the pulse output function assigned to “control output 1” is ON.
 - OUT2 : Lit when the pulse output function assigned to “control output 2” is ON.
 - SUB1 : Lit when the output function assigned to “auxiliary output 1” is ON.
 - SUB2 : Lit when the output function assigned to “auxiliary output 2” is ON.
 - MANU : Lit in the manual operation mode.
 - STOP : Lit when operation has stopped.
 - RMT : Lit during remote operation.
 - RSP : Lit during remote SP operation.
 - AT : Flashes during auto-tuning.

■ How to use keys

The following describes basic key operations.

-  **key** Each press of this key switches between the auto and manual operations.
-  **key** The functions of this key change according to how long it is pressed. If the key is pressed for less than one second, the parameters are switched. If the key is pressed for one second or more, the menu display appears. In key operations from here on, “press the key” refers to pressing the key for less than one second.
For details on parameter switching and menu display items, see page 1-8.
-   **key** Each press of the  key increments or advances the values or settings on the No.2 display, while each press of the  key decrements or returns the values or settings on the No.2 display.

Functions vary, for example, when the  key is held down simultaneously with the display key, or a key is held down continuously. For details, see page 1-8. Also, chapters 3 and 4 describe examples using various key combinations.

1.2 Input and Output

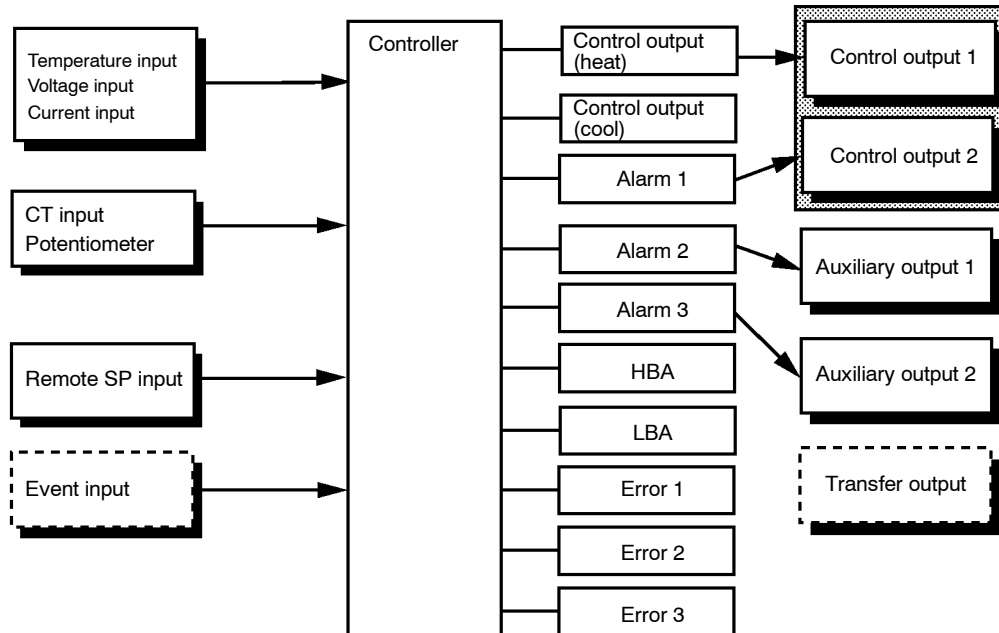

Input

The E5EK supports following inputs: temperature input, current input, voltage input, CT input/Potentiometer, remote SP input and event input.

● Temperature input/Voltage input/Current input

- Only one of temperature input, voltage input and current input can be selected and connected to the controller. The above figure shows temperature input connected to the controller.
- The following input sensors can be connected for temperature input:
Thermocouple: K, J, T, E, L, U, N, R, S, B, W, PLII
Platinum resistance thermometer: JPt100, Pt100
- The following currents can be connected for current input:
4 to 20 mA, 0 to 20 mA
- The following voltages can be connected for voltage input:
1 to 5 VDC, 0 to 5 VDC, 0 to 10 VDC

● CT input/Potentiometer

- Connect CT input when using the HBA (heater burnout alarm) function on a standard type controller (E5EK-AA2).
- Connect the potentiometer when monitoring the valve opening on a position-proportional type controller (E5EK-PRR2). However, note that the potentiometer cannot be used simultaneously with remote SP input.

● Remote SP input

- Remote SP input cannot be used simultaneously with potentiometer.
- When the remote SP function is enabled, inputs within the range 4 to 20 mA are used as the remote SP.

● Event input

When using event input, add on the input unit (E53-CKB).
You can select from the following four event inputs:

- Multi-SP
- Run/Stop
- Auto/Manual
- SP mode

■ Output

The E5EK supports the following five outputs.

- Control output 1
- Control output 2
- Auxiliary output 1
- Auxiliary output 2
- Transfer output

When using control outputs 1 and 2, set the output unit (sold separately). Nine output units are available to suit the output circuit configuration.

When using transfer output, add on the communication unit (E53-AKF).

Note: The output functions of the E5EK do not operate for five seconds after the E5EK is turned ON.

● Output assignments

The E5EK supports the following ten output functions.

- Control output (heat)
- Control output (cool)
- Alarms 1 to 3
- HBA
- LBA
- Error 1 (input error)
- Error 2 (A/D converter error)
- Error 3 (RSP input error)

Assign these output functions to control output 1, control output 2, auxiliary output 1, and auxiliary output 2.

However, note that as control output 1 is used as the open output and control output 2 is used as close output on a position-proportional type controller (E5EK-PRR2), control outputs 1 and 2 cannot be used as assignment destinations. Also, of the output functions, control output (heat), control output (cool), HBA and LBA are disabled.

On a standard type controller, there are restrictions on how assignment destinations (control output 1, control output 2, auxiliary output 1, and auxiliary output 2) can be used. For details, see 3.3 Setting Output Specifications.

In the example on the previous page, “control output (heat)” is assigned to “control output 1”, “alarm 1” is assigned to “control output 2”, and “alarm 2” is assigned to “auxiliary output 1”. Accordingly, the configuration is such that heating control output is connected to control output 1, and alarm output is connected to control output 2 and auxiliary output 1.

Control outputs 1 and 2 are used depending on the differences in control method as follows.

Control Method	Model	Control Output 1/ Control Output 2
Standard control	E5EK-AA2 AC100-240 E5EK-AA2 AC/DC24	Control output (heat) / Alarm, etc.,
Heating and cooling control	E5EK-AA2 AC100-240 E5EK-AA2 AC/DC24	Control output (heat) / Control output (cool)
Position-proportional control	E5EK-PRR2 AC100-240 E5EK-PRR2 AC/DC24	Open/Close

● Transfer output

The E5EK supports the following six transfer outputs.

- Set point
- Set point during SP ramp
- Process value
- Heating side manipulated variable
- Cooling side manipulated variable
- Valve opening

However, note that heating/cooling side manipulated variables can be output only standard type controllers, and valve opening can be output on position-proportional type controllers

These transfer outputs can be output after being scaled. Setting of an upper limit value smaller than the lower limit value is allowed, so reverse scaling can also be carried out.

1.3 Parameters and Menus

■ Parameter types

E5EK parameters are distributed between the following nine modes.

- Protect mode
- Manual mode
- Level 0 mode
- Level 1 mode
- Level 2 mode
- Setup mode
- Expansion mode
- Option mode
- Calibration mode

The settings of parameters in each of seven modes (excluding the protect mode and manual mode) can be checked and modified by selection on the menu display.

● Protect mode

This mode is used to limit use of the menu and $\boxed{A/M}$ keys. The protect function is for preventing unwanted modification of parameters and switching between the auto and manual operation.

● Manual mode

In this mode, the controller can be switched manual operation. The manipulated variable can be manipulated manually only in this mode.

● Level 0 mode

Set the controller to this mode during normal operation. In this mode, you may change the set point during operation, and stop and start operation. You can also monitor (not change) the process value, ramp SP and manipulated variable.

● Level 1 mode

This is the main mode for adjusting control. In this mode, you can execute AT (auto-tuning), and set alarm values, the control period and PID parameters.

● Level 2 mode

This is the auxiliary mode for adjusting control. In this mode, you can set the parameters for limiting the manipulated variable, switch between the remote and local modes, switch between the SP modes, and set the loop break alarm (LBA), alarm hysteresis and the digital filter value of inputs.

● Setup mode

This is the mode for setting the basic specifications. In this mode, you can set parameters that must be checked or set before operation such as the input type, scaling, output assignments and direct/reverse operation.

● Expansion mode

This is the mode for setting expanded functions. In this mode, you can set ST (self-tuning), SP setting limiter, selection of advanced PID or ON/OFF control, specification of the standby sequence resetting method, time for automatic return to the monitoring display.



● Option mode

This is the mode for setting option functions. You can select this mode only when the option unit is set in the controller. In this mode, you can



- Setup mode
- Expansion mode
- Option mode
- Calibration mode

- If you select [S E t] [E ū t] [ō P t] or [C l b] in the menu display, the setup, expansion, option and calibration modes, respectively, are selected.
- When these modes are selected, the control is reset. So, control outputs and auxiliary output are turned OFF. When another mode is selected while in these modes, reset is canceled.



- Protect mode

- To set the controller to the protect mode or to return to the level 0 mode from the protect mode, press the  key and  key for 1 second minimum simultaneously.

- Manual mode





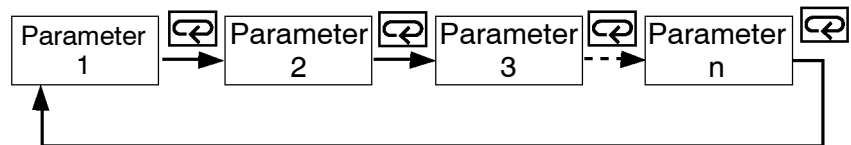

- To set the controller to the manual mode, press the  key for 1 second minimum in the level 0 to 2 mode. To return to the level 0 mode from the manual mode, press the  key for 1 second minimum.

■ Selecting parameters

- When not in the manual mode, each press of the  key switches the parameter.
- If you press the  key when at the final parameter, the display returns to the first parameter.



■ Fixing settings

- When you have changed a parameter setting, specify the parameter using the  or  keys, and either leave the setting for at least two seconds or press the  key. This fixes the setting.
- When another mode is selected, the content of the parameters before the mode was selected is fixed.
- When turning the power OFF, you must first fix the settings and parameter contents (by pressing the  key or selecting another mode). The settings and parameter contents are sometimes not changed by merely pressing the  or  keys.

1.4 About the Communications Function

The E5EK can be provided with a communications function that allows you to check and set controller parameters from a host computer. If the communications function is required, add on the communications unit. For details on the communications function, refer to Chapter 6.

● **RS-232C**

When using the communications function on the RS-232C interface, add on the communications unit (E53-AK01).

● **RS-422**

When using the communications function on the RS-422 interface, add on the communications unit (E53-AK02).

● **RS-485**

When using the communications function on the RS-485 interface, add on the communications unit (E53-AK03).

1.5 About Calibration

The E5EK controller is calibrated before shipment from the factory. So, the user need not calibrate the E5EK controller during regular use.

However, if the E5EK controller must be calibrated by the user, use the parameters provided for user to calibrate temperature input, analog input (voltage, current) and transfer output.

Also, note that calibration data is updated to the latest value each time the E5EK controller is calibrated. Calibration data set before shipment from the factory cannot be returned to after calibration by the user.

● Calibrating inputs

The input type selected in the parameter is the item to be calibrated. The E5EK is provided with the following four calibration parameters.

- Thermocouple
- Platinum resistance thermometer
- Current input
- Voltage input

Two parameters are provided for thermocouple and voltage input.

● Calibrating transfer output

Transfer output can be calibrated when the communications unit (E53-AKF) is added on.

● Registering calibration data

When calibrating each item, the calibration data is temporarily registered. This data can be registered as final calibration data only when all items have been newly calibrated. So, all items must be temporarily registered when calibrating the E5EK controller.

When registering data, information regarding whether or not calibration has been carried out is also registered.

To calibrate these items, the user must prepare separate measuring devices and equipment. For details on handling these measuring devices and equipment, refer to the respective manuals.

For details, see chapter 7 Calibration.

K CHAPTER 2

PREPARATIONS

This chapter describes the operations you should carry out before turning the E5EK ON.

2.1	Setting up	2-2
	Draw-out	2-2
	Setting up the output unit	2-3
	Setting up the option unit	2-4
2.2	Installation	2-5
	Dimensions	2-5
	Panel cutout	2-5
	Mounting	2-6
	Setting up the terminal covers	2-7
2.3	Wiring Terminals	2-8
	Terminal arrangement	2-8
	Precautions when wiring	2-8
	Wiring	2-8

2.1 Setting up

- On a standard type controller, set up the output units for control outputs 1 and 2 before mounting the controller.
- On a position-proportional type controller, the relay output unit is already set. So, this setup operation unnecessary. (Do not replace with other output units.)
- When setting up the output units, draw out the internal mechanism from the housing and insert the output units into the sockets for control outputs 1 and 2.

■ Draw-out

When drawing out the internal mechanism from the housing, prepare a phillips screwdriver matched to the size of the screw on the lower part of the front panel.

- (1) Press down on the hook on the top of the front panel and turn the phillips screwdriver to the left to loosen the screw on the lower part of the front panel.

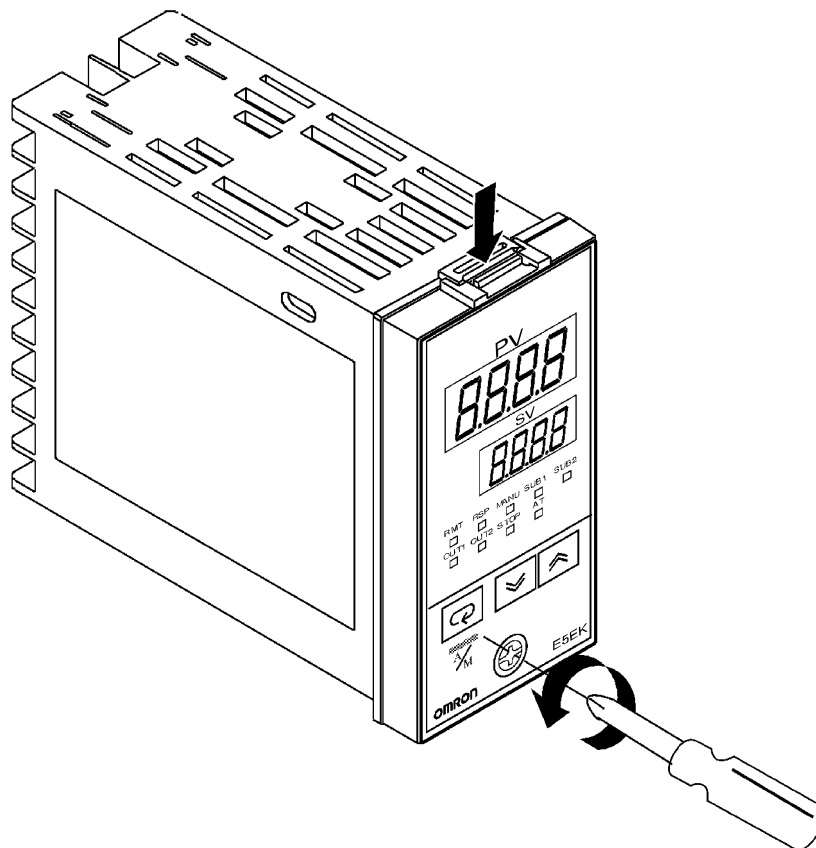

- (2) Draw out the internal mechanism towards you holding both sides of the front panel.



Fixing Screw for Front Panel

Tighten this screw by a torque of 0.3 to 0.5 N·m, or approx. 3 to 5 kgf·cm.

■ Setting up the output unit

● Before setup

- Check the type of the output unit you are about to set up.
- For details on types of output unit and main specifications, see page 2-9.

● Procedure

- (1) Check the positions of the sockets you are about to insert the output units into as shown in the following diagram.

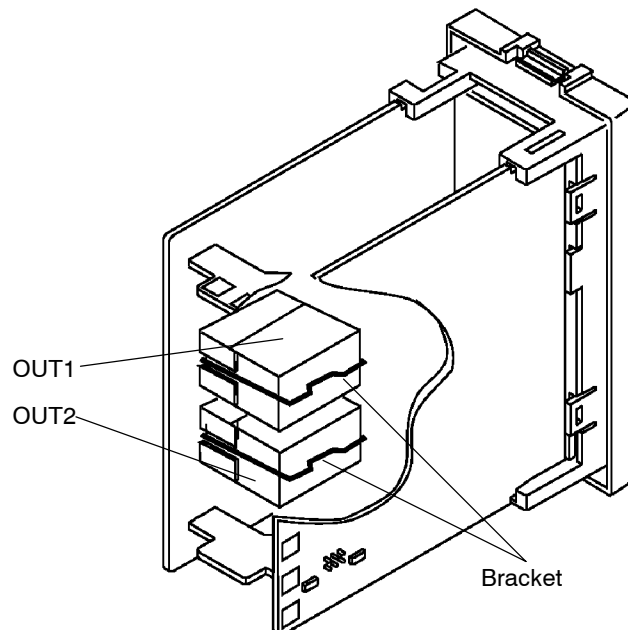

- (2) Remove the power board in the direction of the arrow shown in the figure. The power board is connected to the control board by a center connector. Remove this connector taking care not to bend the connector pins.

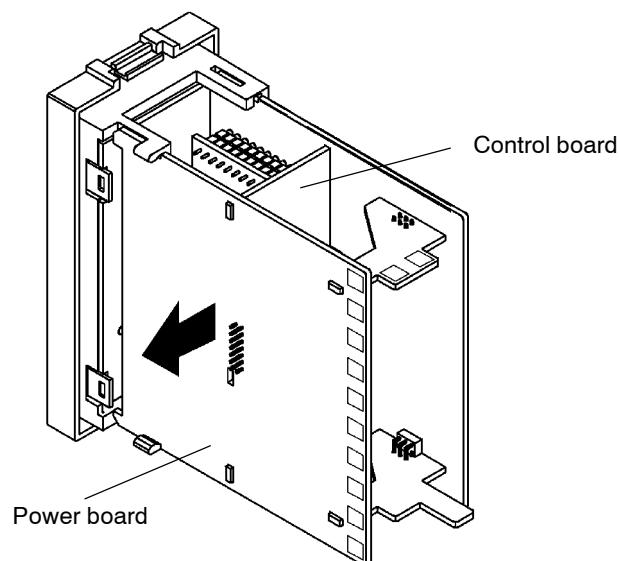

- (3) Insert the output unit for control output 1 into the socket “OUT1” and the output unit for control output 2 into the socket “OUT2”.
- (4) Fasten the output units with the bracket (accessory).
- (5) Return the power board to its original position.

■ Setting up the option unit

● Before setup

- Check the type of the option unit you are about to set up.
- For details on types of option unit and main specifications, see Appendix, Model List (page A-11) and Appendix, Option Unit Ratings and Characteristics (page A-4).
- For details on the relationship between units and terminals, see page 2-8.

● Procedure

- (1) Remove the power board and option boards in the order shown in the following diagram.

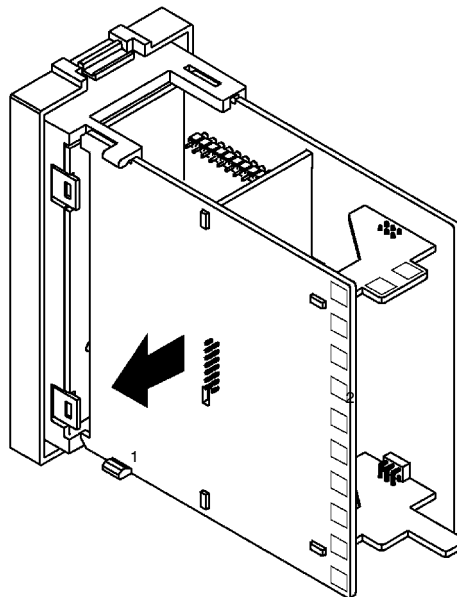

- (2) Insert the option unit into the socket for option 1. The following diagram shows the relationship between option unit and mounting position.

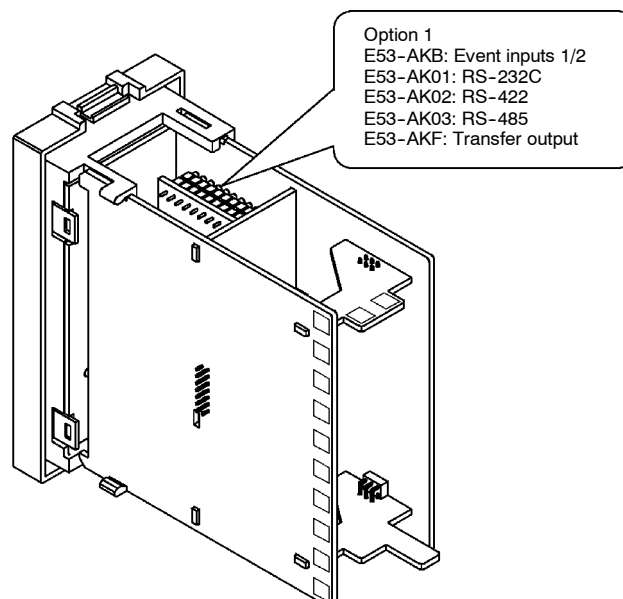

- (3) Mount the option board and the power board in the order shown.

2.2 Installation

■ Dimensions

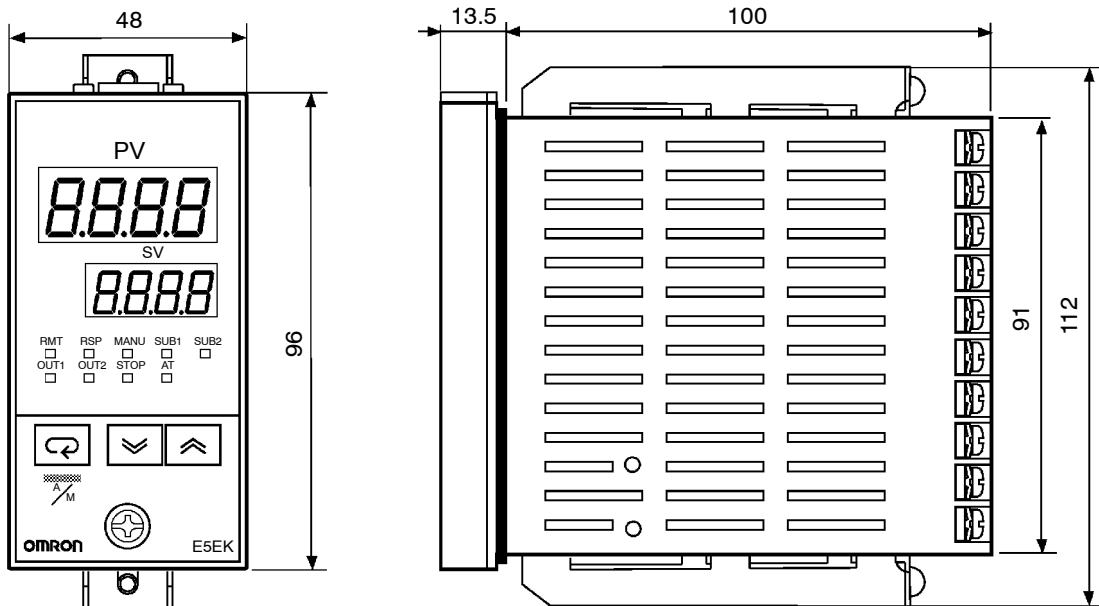

- The width of the rear case is 44 mm.

■ Panel cutout

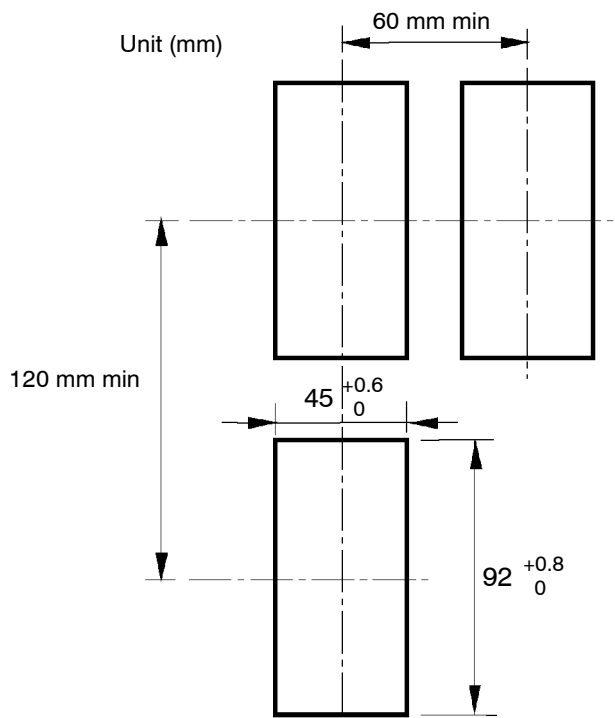

- Recommended panel thickness is 1 to 8 mm.
- Maintain the specified vertical and horizontal mounting space between each controller.
Controllers must not be closely mounted vertically or horizontally.

■ Mounting

- (1) Insert the E5EK controller into the mounting hole in the panel.
- (2) Fit the mounting bracket (accessory) into the fixing slots on the top and bottom of the rear case.

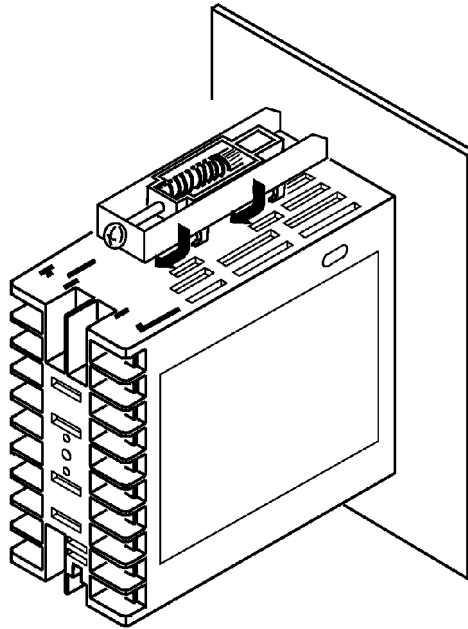

- (3) Tighten the mounting bracket screws alternately a little at a time until the ratchet start to slide.

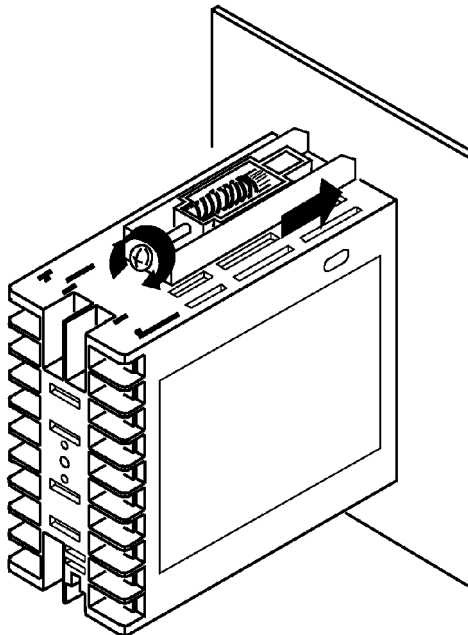

● Setting up the terminal covers

- Fasten the terminal cover (E53-COV08) to protect terminals.
- E5EK-□□2-500 controller is provided with terminal covers.
- Fasten the terminal cover as follows by using the snap pins.

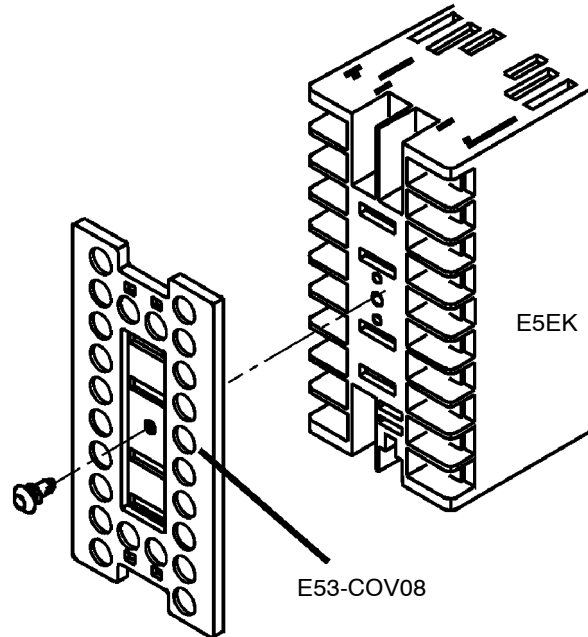

- To remove the terminal cover, pull the edges of the snap pins.

2.3 Wiring Terminals

Terminal arrangement

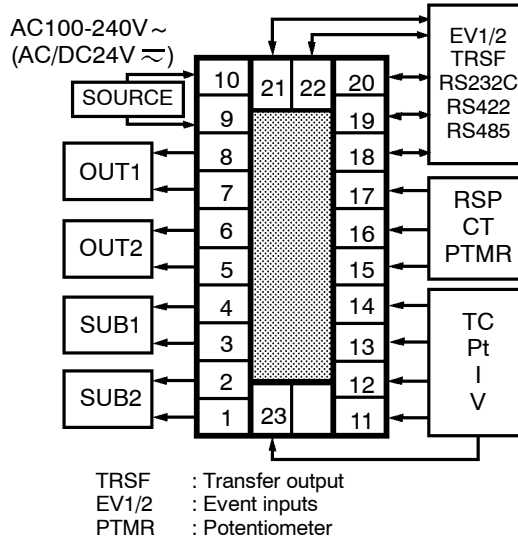

Precautions when wiring

- Use ducts to separate input leads and power lines in order to protect the controller and its lines from external noise.
- We recommend using solderless terminals when wiring the controller.
- Tighten the terminal screws using a torque no greater than 0.78 N·m, or 8 kgf·cm max. Take care not to tighten the terminal screws too tightly.
- Use the following type of solderless terminals for M3.5 screws.

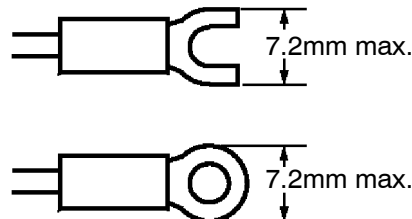

Wiring

Power supply

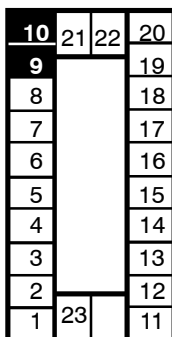

In the following wiring diagrams, the left side of the terminal Nos. indicates the inside of the controller

- Input power to terminal Nos. 9 and 10. Power specifications are as follows:

AC100-240V~, 50/60Hz, 15VA

(AC/DC24V ~, 50/60Hz, 12VA 8W)

● **Sensor input**

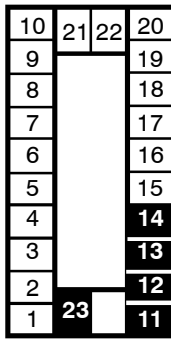

- Connect the sensor input to terminal Nos. 11 to 14 and 33 as follows according to the input type.

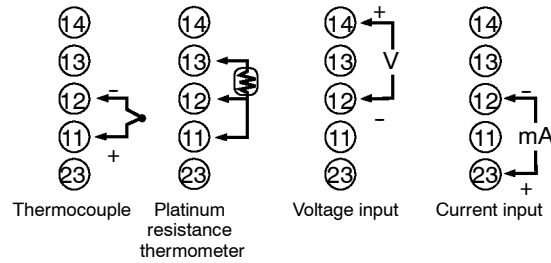

● **Control output**

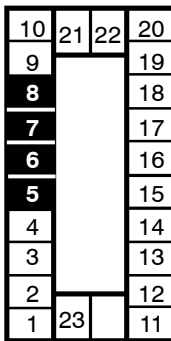

- Terminal Nos. 7 and 8 are for control output 1 (OUT1), and terminal Nos. 5 and 6 are for control output 2 (OUT2). The following diagrams show the available output units and their internal equalizing circuits.

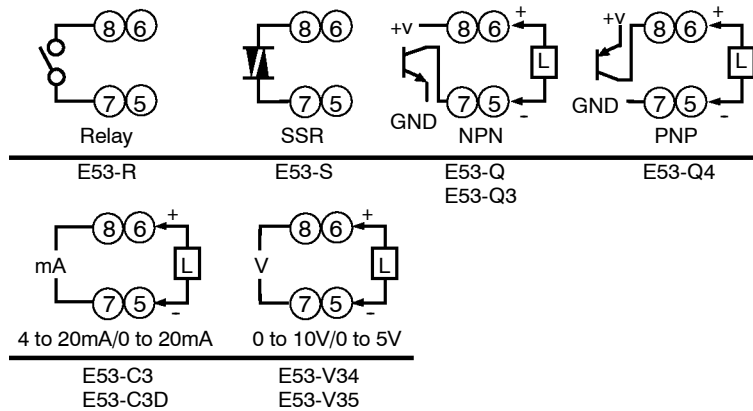

- With E53-V□□ output units, about 2 V is output for one second after the power is interrupted.
- The following table shows the specifications for each output unit.

Model	Output Type	Specifications
E53-R	Relay	250 VAC, 5 A
E53-S	SSR	75 to 250 VAC, 1 A
E53-Q E53-Q3 E53-Q4	Voltage (NPN) Voltage (NPN) Voltage (PNP)	NPN : 12 VDC, 40 mA (with short-circuit protection) NPN : 24 VDC, 20 mA (with short-circuit protection) PNP : 24 VDC, 20 mA (with short-circuit protection)
E53-C3 E53-C3D	4 to 20 mA 0 to 20 mA	4 to 20 mA, Permissible load impedance: 600 Ω max., Resolution: Approx. 2600 0 to 20 mA, Permissible load impedance: 600 Ω max., Resolution: Approx. 2600
E53-V34 E53-V35	0 to 10 V 0 to 5 V	0 to 10 VDC, Permissible load impedance: 1 kΩ min., Resolution: Approx. 2600 0 to 5 VDC, Permissible load impedance: 1 kΩ min., Resolution: Approx. 2600

With E5EK-PRR2 controllers, relay output (250 VAC, 1 A) is fixed.

When replacing the output unit, use the E53-R. The following diagrams show the relationship between terminals and open/close relay settings.

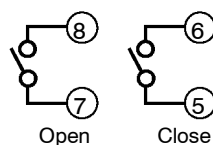

● **Auxiliary output**

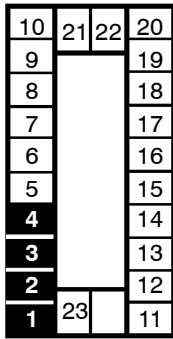

- Terminal Nos.3 and 4 are for auxiliary output 1 (SUB1) and terminal Nos.1 and 2 are for auxiliary output 2 (SUB2).
- The internal equalizing circuits for the auxiliary outputs are as follows:

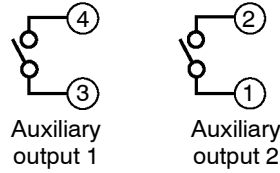

- Output specifications are as follows:
SPST-NO, AC250V, 3A

● **CT input/
Potentiometer**

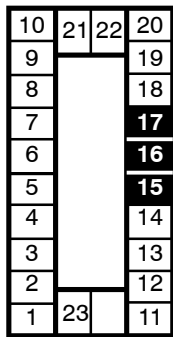

- When using the HBA function on the E5EK-AA2 controller, connect CT input (CT) to terminal Nos.15 to 17. When monitoring the valve opening on the E5EK-PRR2 controller, connect the potentiometer (PTMR) to terminal Nos.15 to 17. Connect each of these inputs as follows:



- For details on CT inputs, see Appendix, About current transformer.
- For details on the potentiometer, see the Instruction Manual for the valve connected to the controller. The variable resistance range is 100 Ω to 2.5 kΩ

● **Remote SP input**

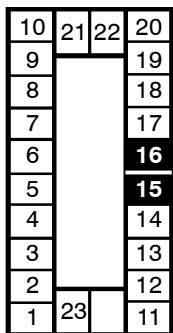

- Connect an input (RSP) to be used as the remote SP to terminal Nos.15 and 16. However, note that the remote SP can not be used on the E5EK-PRR2 controller.
- Only 4 to 20 mA inputs can be connected. Connect the input as follows:

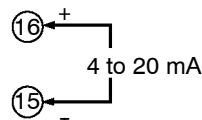

About the power blocks

The E5EK has independent power supplies for each of the terminal blocks shown on the right.

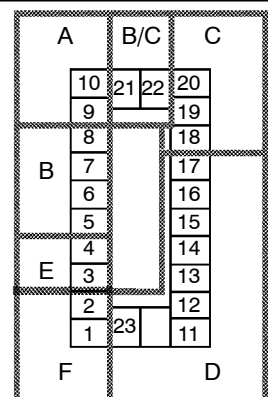

● **Event input**

10	21	22	20
9			19
8			18
7			17
6			16
5			15
4			14
3			13
2			12
1	23		11

- Connect event inputs 1 and 2 (EV1/2) to terminal Nos.18 to 20. However, note that terminal Nos.18 to 20 cannot be used on controllers having a communications function.
- Connect the event inputs as follows:

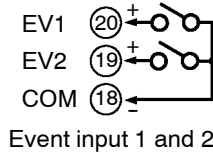

- Use event inputs under the following conditions:

Contact input	ON: 1 kΩ max., OFF: 100 kΩ min.
No-contact input	ON: residual voltage 1.5 V max., OFF: leakage current 0.1 mA max.

- Polarities during no-contact input are as follows:

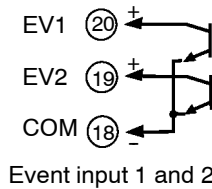

● **Transfer output**

- Connect transfer output (TRSF) to terminal Nos. 21 and 22.
- The internal equalizing circuit for transfer output is as follows:

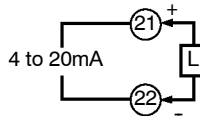

- Transfer output specifications are as follows: 4 to 20 mA,
Permissible load impedance: 600 Ω max.,
Resolution: Approx. 2600

● **Communications**

- Terminal Nos.18 to 22 can be used only on controllers having a communications units (E53-AK01/02/03).
- For details on wiring, see Chapter 6, Using the Communications Function.

K CHAPTER 3

BASIC OPERATION

This chapter describes an actual example for understanding the basic operation of the E5EK.

3.1	Convention Used in this Chapter	3-2
3.2	Setting Input Specifications	3-4
	Input type	3-4
	Scaling	3-4
3.3	Setting Output Specifications	3-6
	Output assignments	3-6
	Direct/reverse operation	3-7
	Control period	3-7
3.4	Setting Alarm Type	3-9
	Alarm type	3-9
	Alarm value	3-9
	Alarm hysteresis	3-10
	Close in alarm/open in alarm	3-10
3.5	Protect Mode	3-12
	Security	3-12
	A/M key protect	3-12
3.6	Starting and Stopping Operation	3-13
3.7	Adjusting Control Operation	3-14
	Changing the set point	3-14
	Manual operation	3-14
	Auto-tuning (A.T.)	3-16

3.1 Convention Used in this Chapter

This chapter describes basic E5EK operations such as how to set up parameters, start and stop operation, and adjusting control operation. For more complex control examples, refer to Chapter 4 Applied Operation and Chapter 5 Parameters.

● Basic Operation Flow

The following diagram shows the basic operation flow.

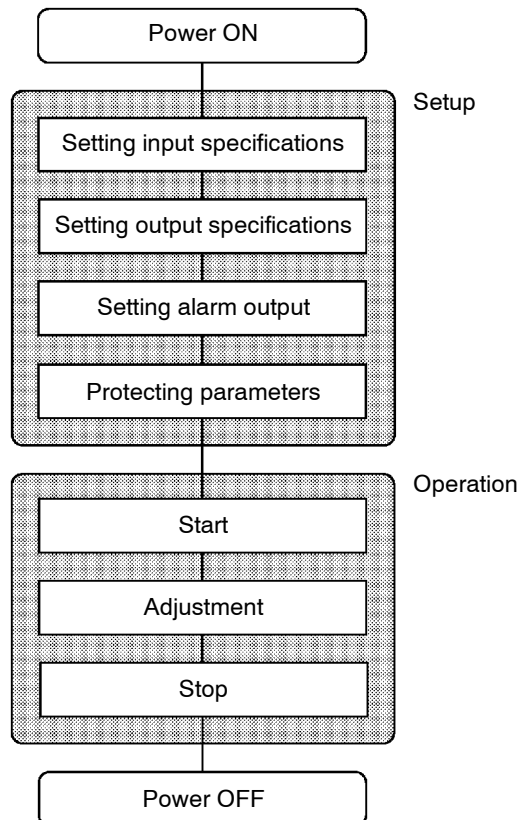

● Setup

This description assumes that the controller is operated under the following conditions.

- A humidity sensor of output 4 to 20 mA is connected to the controller. The measuring range of the humidity sensor is set to 10 to 95%.
- A humidifier is controlled by pulse output to maintain humidity at a constant 60%.
- An alarm is output when the humidity exceeds the upper limit value (70%) or lower limit value (50%).
- Output unit: relay type (E53-R) for OUT1.

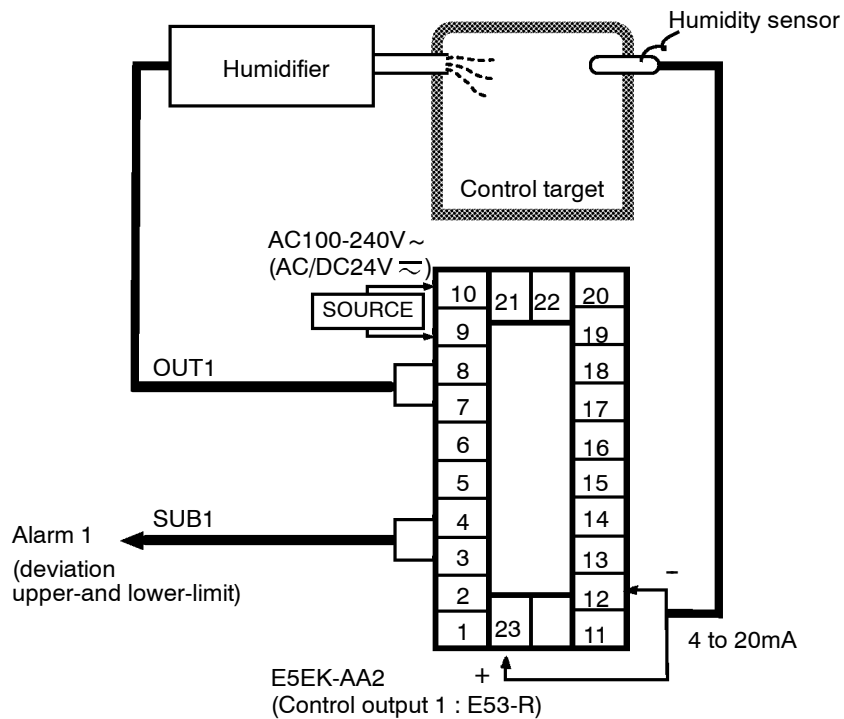

3.2 Setting Input Specifications

Input type



- Set the type No. (0 to 21) in the “input type” parameter. The factory setting is “2: K1 (thermocouple).”
- For details on input types and setting ranges, see page 5-26.

Scaling



- When the voltage input and current input are selected, scaling matched to the control is required.
- The “scaling upper limit”, “scaling lower limit” and “decimal point” parameters (setup mode) are use for scaling.
- The “scaling upper limit” parameter sets the physical quantity to be expressed by the upper limit value of input, and the “scaling lower limit” parameter sets the physical quantity to be expressed by the lower limit value of input. The “decimal point” parameter sets the number of digits past the decimal point.
- The following figure shows scaling example of 4 to 20 mA input. After scaling, the humidity can be directly read. In this case, the “decimal point” parameter is set to “1”.

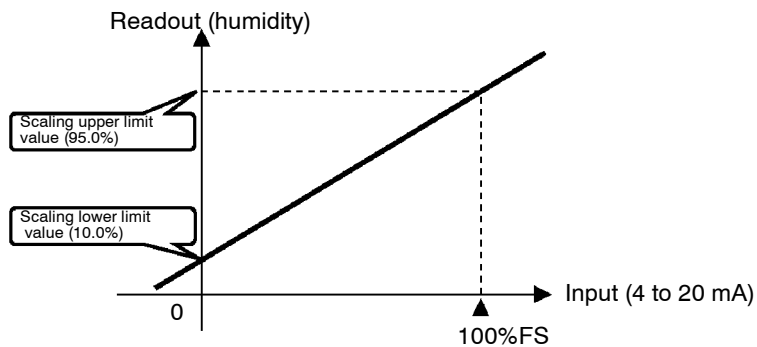

Input shift



- When temperature input is selected, scaling is not required. This is because input is treated as the “temperature” as it is matched to the input type. However, note that the upper and lower limit values of the sensor can be shifted. For example, if both the upper and lower limit values are shifted by 1.2°C, the process value (before shift) is regarded as 201.2°C after shift when input is 200°C before shift.
- To set input shift, set shift values in the “input shift upper limit” and “input shift lower limit” parameters (level 2 mode).

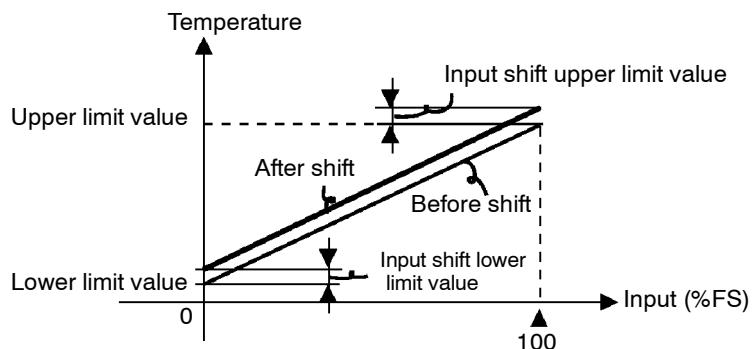

About the temperature unit

To switch the temperature unit from “°C” to “°F” for temperature unit, switch the setting of the “°C/°F selection” parameter to [**C**] from [**F**].

Setting Example

In this example, let's set the parameters as follows:

“input type” = “17 (4 to 20 mA)”
 “scaling upper limit value” = “950”
 “scaling lower limit value” = “100”
 “decimal point” = “1”

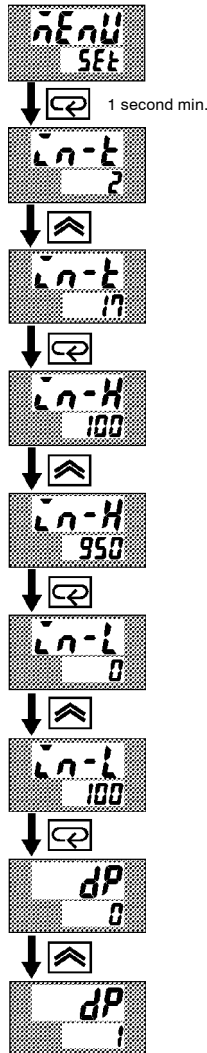

- (1) Select the menu display, and select [`SEt`] (setup mode) using the `▲` or `▼` keys. For details on selecting the menu display, see page 1-8.
- (2) Press the `↻` key to enter the setup mode. The top parameter in the setup mode [`Ln-t`] “input type” is displayed. The parameter default is “2”.
- (3) Press the `▲` key until the display indicates “17”.
- (4) Press the `↻` key to fix the set value. The display changes to [`Ln-H`] (“scaling upper limit value” parameter). The parameter default is “100”.
- (5) Press the `▲` key until the display indicates “950”.
- (6) Press the `↻` key to fix the set value. The display changes to [`Ln-L`] (“scaling lower limit value” parameter). The parameter default is “0”.
- (7) Press the `▲` key until the display indicates “100”.
- (8) Press the `↻` key to fix the set value. The display changes to [`dP`] (“decimal point” parameter). The parameter default is “0”.
- (9) Press the `▲` key until the display indicates “1”.

3.3 Setting Output Specifications

Some output specifications are different according to controller type, standard or position-proportional. The following table summarizes which output-related parameter settings are supported.

Parameter		Standard Type	Position-proportional Type
OUT1	Control output 1 assignment	●	
OUT2	Control output 2 assignment	●	
SUB1	Auxiliary output 1 assignment	●	●
SUB2	Auxiliary output 2 assignment	●	●
REV	Direct/reverse operation	●	●
CP	Control period (heat)	●	
C-CP	Control period (cool)	●	

(● Indicates that an output specification is supported.)

Output assignments

● Standard type

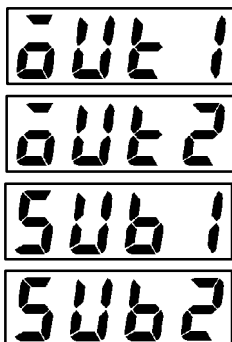

Output assignments are described according to controller type.

- Ten output are supported :
 - control output (heat)
 - control output (cool)
 - alarm outputs 1 to 3
 - HBA
 - LBA, and
 - error 1 (input error)
 - error 2 (A/D converter error)
 - error 3 (RSP input error).

These functions are assigned to control outputs 1 and 2, and auxiliary output 1 and 2.

- Restrictions on assignment destination are placed on some of the outputs. The following table shows where outputs may be assigned to.

Assignment Destination / Output Function	Control Output		Auxiliary Output	
	1	2	1	2
Control output (heat)	●	●		
Control output (cool)	●	●		
Alarm 1	●	●	●	●
Alarm 2	●	●	●	●
Alarm 3	●	●	●	●
HBA	●	●	●	●
LBA	●	●	●	●
Error 1; Input error			●	●
Error 2; A/D converter error			●	●
Error 3; RSP input error			●	●

With control output (cool), the conditions for switching from standard control to heating and cooling control are reached when the output function is assigned at the cooling side during heating and cooling control.

In other words, heating and cooling control is carried out when control output (cool) is assigned, and standard control is carried out when output is not assigned. For details on heating and cooling control, see 4.1 Selecting the Control Method (page 4-2).

- Factory settings are as follows:
 - control output 1 = Control output (heat)
 - control output 2 = Alarm 1
 - auxiliary output 1 = Alarm 2
 - auxiliary output 2 = Alarm 3.
- Output assignments are set in the “control output 1 assignment”, “control output 2 assignment”, “aux output 1 assignment” and “aux output 2 assignment” parameters (setup mode).

● Position-proportional type

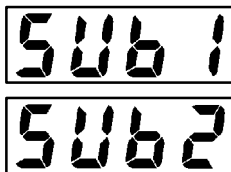

- Position-proportional type controllers support six output functions. These are assigned to auxiliary outputs 1 and 2.
- Restrictions on assignment destinations are placed on some of the outputs. The following table shows where outputs may be assigned to.

Output Function \ Assignment Destination	Control Output		Auxiliary Output	
	1	2	1	2
Alarm 1			●	●
Alarm 2			●	●
Alarm 3			●	●
Error 1 : Input error			●	●
Error 2 : A/D converter error			●	●
Error 3 : RSP input error			●	●

■ Direct/reverse operation

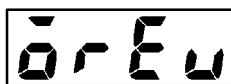

- “Direct operation” (or normal operation) refers to control where the manipulated variable is increased according to the increase in the process value. Alternatively, “reverse operation” refers to control where the manipulated variable is decreased according to the decrease in the process value.
 For example, when the process value (PV), is lower than the set point (SP), in a heating control system, the manipulated variable increases by the difference between the PV and SP values.
 Accordingly, this becomes “reverse operation” in a heating control system. Alternatively, this becomes “direct operation” in a cooling control system.
- Direct/reverse operation is set in the [drEv] “direct/reverse operation” parameter (setup mode).

■ Control period

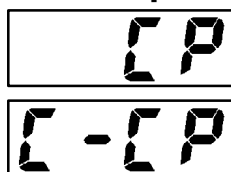

- When the output unit is pulse output such as relay output, set the pulse output cycle (control period). Though a shorter pulse period provides better control performance, the control period should be set taking the life expectancy of the output unit into consideration when the output unit is relay.
- The control period is set in the “control period (heat)” parameter (level 1 mode). Factory setting is “20:20 seconds.”
- The “control period (cool)” output function is not allocated. So, the “control period (cool)” parameter cannot be set.

Setting Example

In this example, let's set the parameters as follows:

- “control output 1 assignment” = “control output (heat)”
- “control output 2 assignment” = “alarm output 1”
- “direct/reverse operation” = “reverse operation”
- “control period” = “20 secs”
- “run/stop” = “run”

All of the above settings in this example are factory settings. So, in this example, we are only going to check the parameter settings.

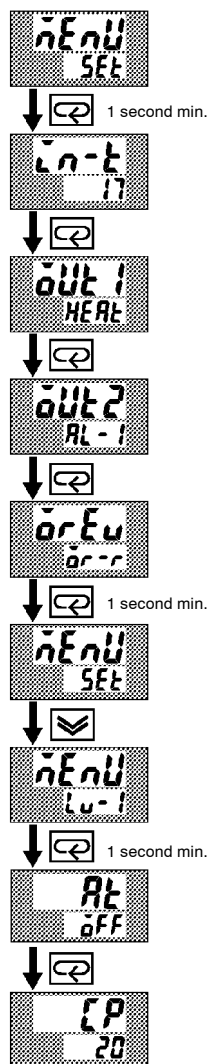

- (1) Select the menu display, and select [SET] (setup mode) using the or keys. For details on selecting the menu display, see page 1-8.
- (2) Press the key to enter the setup mode. The top parameter in the setup mode [IN-T] “input type” is displayed. In this example, the parameter setting is “17: 4 to 20 mA.”
- (3) Press the key until [OUT 1] (“control output 1 assignment” parameter) is displayed. The parameter default is [HEAT].
- (4) As the setting in this example is to be left as it is, press the key. The display changes to [OUT 2] (“control output 2 assignment” parameter). The parameter default is [AL - 1].
- (5) As the setting in this example is to be left as it is, press the key until [OR-EU] (“direct/reverse operation” parameter) is displayed. The parameter default is [OR - r].
- (6) As the setting in this example is to be left as it is, press the or keys to select [L-1] (level 1 mode). For details on selecting the menu display, see page 1-8.
- (7) Press the key to enter the level 1 mode. The top parameter in the level 1 mode [RT] “AT execute/cancel” is displayed.
- (8) Press the key until [CP] (“control period” parameter) is displayed. The parameter default is “20”. As the setting in this example is to be left as it is, quit key operation.

3.4 Setting Alarm Type

- Three alarm outputs are supported: alarms 1 to 3. Of these, only the alarm assigned as the output can be used.
- Alarm output conditions are determined according to the combination of the “alarm type”, “alarm value” and “alarm hysteresis” parameter settings.
- The contact conditions when alarm output is ON can be set to “open” or “closed” in the “close in alarm/open in alarm” parameter.

■ Alarm type

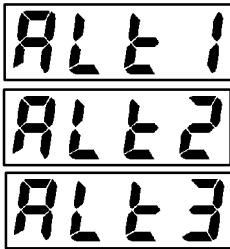

- The following table shows the alarm types supported by the E5EK controller and their respective operations.

Alarm Type		Alarm Output Operation	
		When X is positive	When X is negative
1	Upper-and lower-limit alarm (deviation)	ON OFF	Always ON
2	Upper-limit alarm (deviation)	ON OFF	ON OFF
3	Lower-limit alarm (deviation)	ON OFF	ON OFF
4	Upper-and-lower-limit range alarm (deviation)	ON OFF	Always OFF
5	Upper-and-lower-limit alarm with standby sequence (deviation)	ON OFF	Always OFF
6	Upper-limit alarm with standby sequence (deviation)	ON OFF	ON OFF
7	Lower-limit alarm with standby sequence (deviation)	ON OFF	ON OFF
8	Absolute-value upper-limit alarm	ON OFF	ON OFF
9	Absolute-value lower-limit alarm	ON OFF	ON OFF
10	Absolute-value upper-limit alarm with standby sequence	ON OFF	ON OFF
11	Absolute-value lower-limit alarm with standby sequence	ON OFF	ON OFF

- Alarm types are set independently for each alarm in the “alarm 1 to 3” parameters (setup mode). Factory setting is “2: Upper-limit alarm (deviation)”.

■ Alarm value

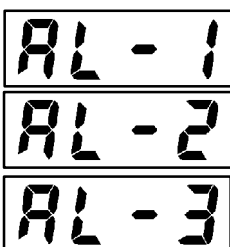

- Alarm values are indicated by “X” in the table above. Alarm output operation differs according to whether the value of the alarm is positive or negative.
- Alarm values are set independently for each alarm in the “alarm value 1 to 3” parameters (level 1 mode). Factory setting is “0”.

■ Alarm hysteresis

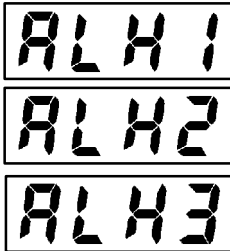

- The hysteresis of alarm outputs when alarms are switched ON/OFF can be set as follows.

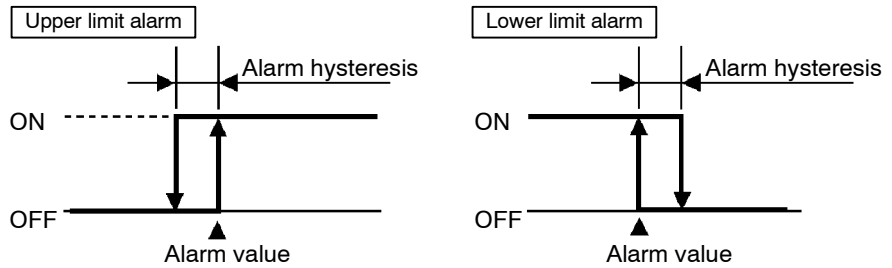

- Alarm hysteresis is set independently for each alarm in the “alarm 1 to 3 hysteresis” parameters (level 2 mode). Factory setting is “0.02: 0.02%FS”.

● Standby sequence

- “Standby sequence” is a function for unconditionally turning alarm output OFF when the process value has left the alarm range once and it next enters the alarm range.
- For example, when the alarm type is set to “deviation lower limit,” generally the process value is within the alarm range, and alarm output become ON as it is as the process value when the power is turned ON is smaller than the set point. However, if the alarm type is set to “deviation lower limit with standby sequence”, alarm output first becomes ON when the process value exceeds the alarm setting value to leave the alarm range and once again falls below the alarm value.

■ Close in alarm/open in alarm

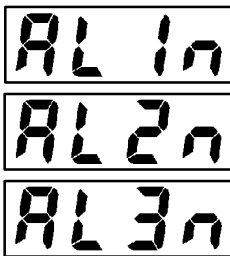

- When the controller is set to “close in alarm,” the status of the alarm output function is output as it is. When set to “open in alarm,” the status of the alarm output function is output inverted.

	Alarm	Output	Output LED
Close in alarm	ON	ON	Lit
	OFF	OFF	Not lit
Open in alarm	ON	OFF	Lit
	OFF	ON	Not lit

- Alarm type and close in alarm (normally open)/open in alarm (normally close) can be set independently for each alarm.
- Close in alarm/open in alarm is set in the “alarm 1 to 3 open in alarm” parameters (setup mode). Factory setting is [a - 0] “close in alarm”.

● Summary of alarm operations

The figure below visually summarizes the above description of alarm operations (when alarm type is set to “lower limit alarm (deviation) with standby sequence”):

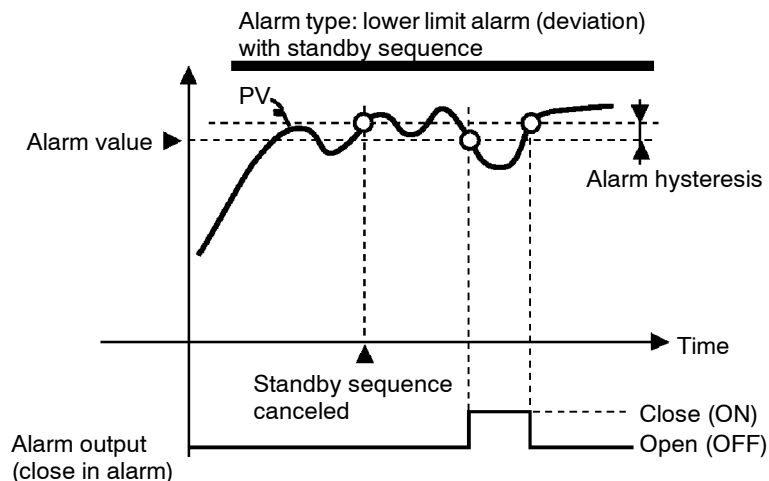

Setting Example

When a set point for a temperature exceeds $\pm 10\%$, alarm1 will be output.

In this example, let's set the parameters as follows:

"alarm type 1"	= "1: (deviation upper-and lower-limit)"
"alarm value 1"	= "10"
"alarm hysteresis"	= "0.20"
"close in alarm/open in alarm"	= "1 - 0: close in alarm"

Meanings of parameters, "alarm hysteresis" and "open in alarm/close in alarm" are the same settings at the shipment, so settings for operations are omitted.

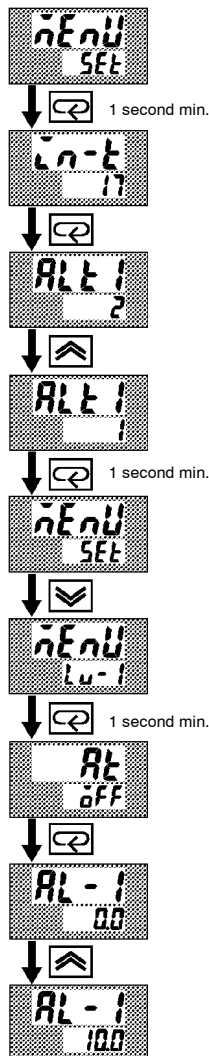

- (1) Select the menu display, and select [**SEt**] (setup mode) using the or keys. For details on selecting the menu display, see page 1-8.
- (2) Press the key to enter the setup mode. The top parameter in the setup mode [**Input - t**] "input type" is displayed. In this example, the parameter setting is "17: 4 to 20 mA".
- (3) Press the key until [**AL t !**] ("alarm type 1" parameter) is displayed. The parameter default is "2: deviation upper limit".
- (4) Press the key to return to "1: deviation upper-and-lower limit".
- (5) Select the menu key, and select [**Lu - !**] (level 1 mode) using the or keys. For details on selecting the menu display, see page 1-8.
- (6) Press the key to enter the level 1 mode. The top parameter in the level 1 mode [**AL**] "AT execute/cancel" is displayed.
- (7) Press the key until [**AL - !**] ("alarm value 1" parameter) is displayed.
- (8) In this example, the parameter setting is "0.0" so press the key until "10.0" is displayed.



About the Decimal Point of the Alarm Value

The decimal point of the alarm value conforms to the setting of the "decimal point" parameter (setup mode). In this example, the "decimal point" parameter is set to "1". (During temperature input, the decimal point of the alarm value conforms to the set sensor.)

3.5 Protect Mode

Security



- This parameter allows you to protect until start of operation parameters that do not change during operation to prevent unwanted modification.
- The set value of the “security” (protect) parameter specifies the range of protected parameters.
- When this parameter is set to “0”, parameters are not protected.
- When this parameter is set to “1” to “3”, the number of modes that can be displayed on the menu display is limited.
When set to “1”, level 0 to 2, setup, expansion and option modes only can be selected. When set to “2”, only level 0 to 2 modes can be selected. When set to “3”, only level 0 and 1 modes can be selected.
- When this parameter is set to “4” to “6”, operations in only the level 0 mode can be selected, and the mode is not displayed on the menu display.
- When this parameter is set to “5”, only the “PV/SP” parameter can be used.
- When this parameter is set to “6”, only the “PV/SP” parameter can be used. (The set point can not change.)
- Default is “1”.

A/M key protect



- This parameter disables use of the key during operation. For example, if you protect use of the key by the “A/M key protect” parameter (protect mode) during auto operation, the controller cannot be set to the manual mode, preventing manual operation of the controller during operation.

Setting Example

- Let's protect the setup, expansion, option and calibration modes. Set the parameters as follows:
“security” = “2: Usable only in level 0 to 2 modes”

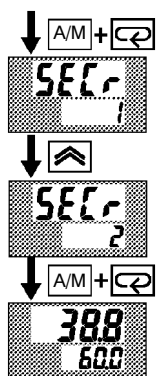

- (1) Press for 1 second minimum the and keys simultaneously, the controller enters the protect mode.
- (2) In the protect mode, the top parameter in the protect mode “security” is displayed. The parameter default is “1”. Press the key to change the parameter setting to “2”.
- (3) Press for 1 second minimum the and keys simultaneously, the display changes to the “PV/SP monitor” parameter (level 0 mode).

3.6 Starting and Stopping Operation



● Manipulated variable at stop

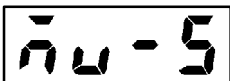

- You can start and stop operation by changing the setting of the “run/stop” parameter (level 0 mode).
- You can switch the RUN/STOP function up to 100,000 times.
- To stop operation, set the “run/stop” parameter to [5tōP] (stop). In a stop state, the “STOP” LED lights.
- Operation cannot be stopped during auto-tuning.
- On a standard type controller, specify the manipulated variable (–5.0 to 105.0%) in the “MV at stop” parameter (level 2 mode) to output the manipulated variable during stop.
Factory-set to “0.0 : 0.0%”
- On a position-proportional type controller, you can select either of the open, close or hold status. In an open status, only control output 1 is ON. In a close status, only control output 2 is ON. In a hold status, both control outputs 1 and 2 are Factory-set to “hold.”

Setting Example

The following example describes the procedure to follow to stop control during operation of the controller.

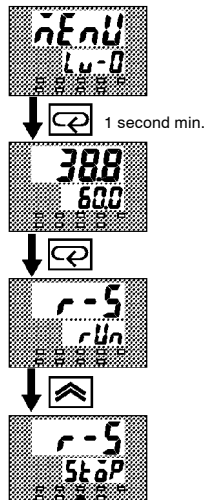

- (1) Select the menu display, and select [Lw-0] (level 0 mode) using the or keys. For details on selecting the menu display, see page 1-8.
- (2) Press the key to enter the level 0 mode. The PV and SP are displayed.
- (3) Press the key until [r-5] (“run/stop” parameter) is displayed.
- (4) Press the key to select [5tōP] (stop). The “STOP” LED lights, and operation stops.

To resume operation, follow the above procedure to select [rUn] (“run”). The “STOP” LED goes out and operation starts.



Using Event Input

Using the E53-AKB, run/stop can be selected by event input. For details on how to use event input, see 4.3 How to Use Event Input, page 4–8.

3.7 Adjusting Control Operation

Changing the set point

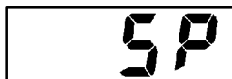

- You can change the set point in the “set point” parameter (level 0 mode).
- However, note that you cannot change the set point when the “security” parameter (protect mode) is set to “6”.
- To change the set point, press the or keys to select the desired value. If you leave the setting for two seconds, the set point is updated to the new setting.

Setting Example

In the following example, let's change the temperature set point from “60°C” to “50°C”.

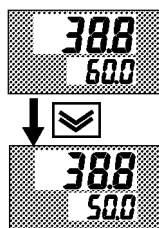

- (1) Select the PV/SP monitor display.
- (2) Press the key to change the setting to “50.0: 50.0°C”.

Manual operation

Standard type

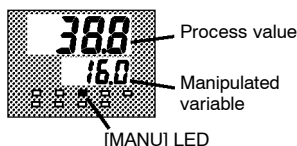

- On standard type controller, the manipulated variable is controlled, and on a position-proportional type controller, the valve opening is controlled.
- To set manual operation and manually set the manipulated variable or the valve opening, press for 1 second minimum the key. The controller enters the manual mode.
- The process value is displayed on the No.1 display, and the manipulated variable is displayed on the No.2 display.
- To change the manipulated variable, press the or keys. After two seconds, the manipulated variable is updated to the new setting.
- Other modes cannot be selected while in the manual mode. To select other modes, press for 1 second minimum the key. The manual mode is quit.
- The automatic return of display function does not work while in the manual mode.
- When switching between manual and auto operation, the manipulated variable is subject to balance-less, bump-less operation.
- If the power is interrupted during manual operation, manual operation is resumed at the manipulated variable at power interruption when the power is reset.
- You can switch the AUTO/MANUAL function up to 100,000 times.



Balance-less,
Bump-less Operation

To prevent sudden changes in the manipulated variable when switching between manual and auto operation, operation is resumed using the value that was active immediately before operation was switched, and the value is brought gradually closer to the value immediately after operation was switched.

The following diagram summarizes manual operation.

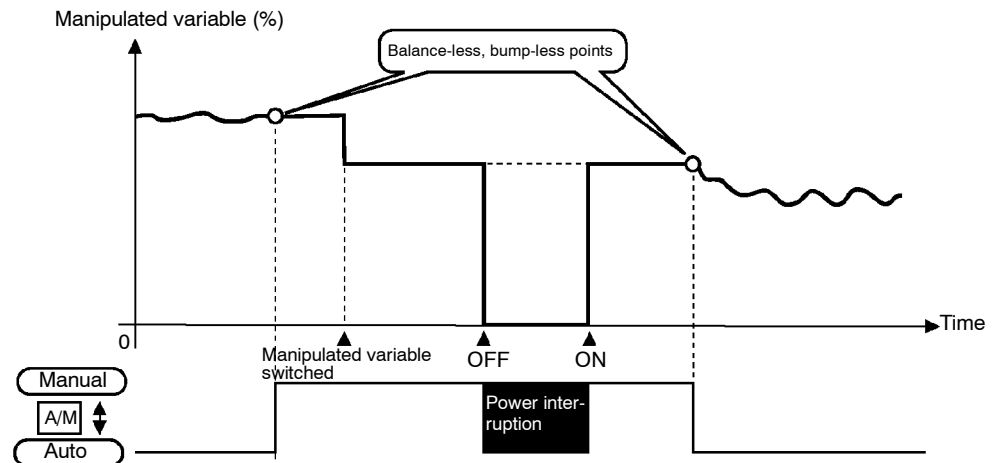



● Position-proportional type

- When a potentiometer is connected to the controller, the process value is displayed on the No.1 display, and the valve opening is displayed on the No.2 display.

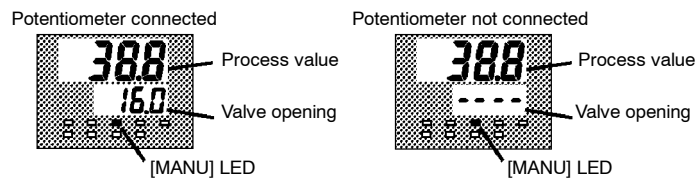
When a potentiometer is not connected to the controller, [----] is displayed on the No.2 display.



- When you press the  key, the open side becomes ON. When you press the  key, the close side becomes ON.
- Other modes cannot be selected while in the manual mode. To select other modes, press for 1 second minimum the  key. The manual mode is quit.
- The automatic return of display function does not work while in the manual mode.
- You can switch the AUTO/MANUAL function up to 100,000 times.

Auto-tuning (A.T.)

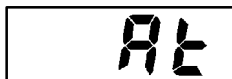

- AT (auto-tuning) cannot be executed while operation is canceled or during ON/OFF control.
- When you execute auto-tuning, the optimum PID parameters are automatically set by forcibly changing the manipulated variable to calculate the characteristics (called the “limit cycle method”) of the control target. During auto-tuning, the AT LED flashes.
- 40%AT or 100%AT can be selected by the limit cycle of MV change width. Specify [At - 1] or [At - 2], respectively, in the “AT execute/cancel” parameter (level 1 mode).
- During heating and cooling control and with position-proportional type, only 100%AT can be executed. (So, [At - 1] (40%AT) will not be displayed.)
- To cancel AT execution, specify [OFF] (“AT cancel”).

40%AT



In order to set the limit cycle of MV change width to 40%, select 40%AT to execute auto-tuning with fluctuations in the process value kept to a minimum. However, note that auto-tuning takes longer to execute compared with 100%AT.

The timing by which limit cycles are generated varies according to whether or not the deviation (DV) at the start of AT execution is 10% full-scale or less.

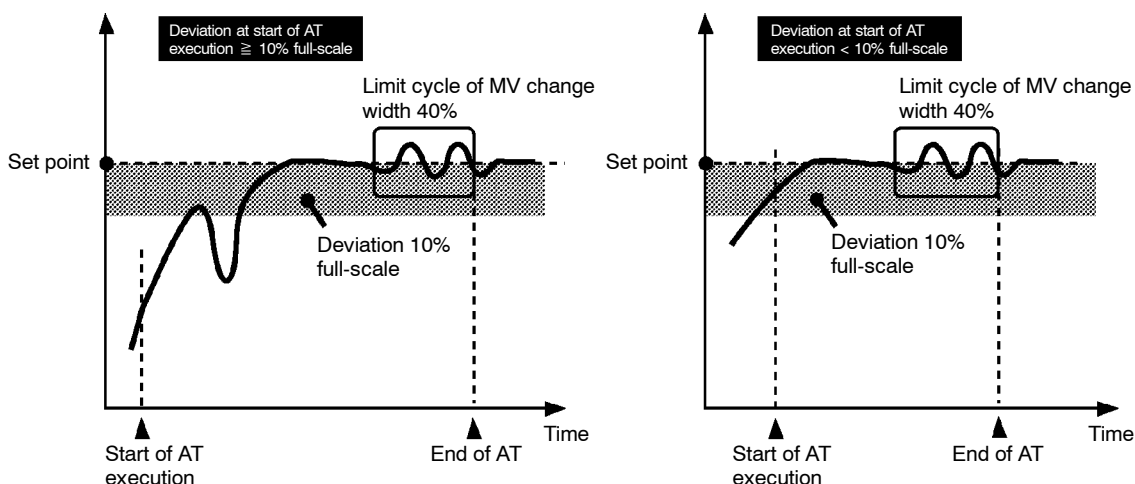

100%AT



In order to set the limit cycle of MV change width to 100%, select 100%AT to shorten the AT execution time without worrying about fluctuations in the process value.

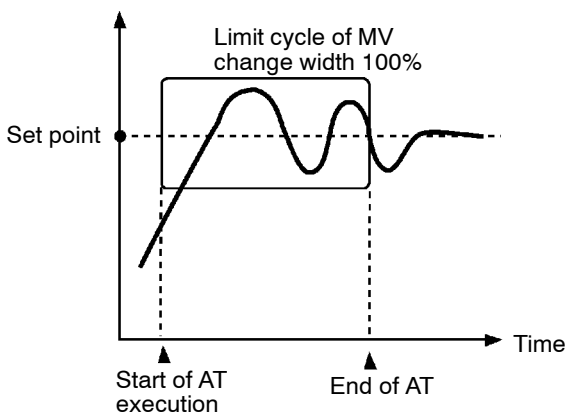

Setting Example

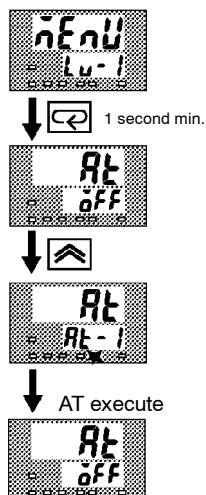

In this example, let's execute 40%AT.

- (1) Select [`LV-1`] (level 1 mode) using the `[Up]` or `[Down]` keys. For details on selecting the menu display, see page 1-8.
- (2) Press the `[Enter]` key to enter the level 1 mode. The top parameter in the setup mode [`AT`] "AT execute/cancel" is displayed. In this example, the parameter setting is [`OFF`] "AT cancel"
- (3) Press the `[Up]` key to specify [`AT-1`].
- (4) The AT LED flashes, and AT execution starts. When the AT LED goes out (end of AT execution), the parameter automatically returns to [`OFF`] ("AT cancel").

In addition to AT, the E5EK is also provided with fuzzy self-tuning (ST) that allows automatic calculation of the PID parameters suited to the control target. However, note that the ST function operates only during standard control by temperature input. For further information regarding the ST, please see page 5-34 and A-14.



About PID Parameters

When control characteristics are already known, the PID parameters can be set directly to adjust control.

PID parameters are set in the "proportional band" (P), "integrated time" (I) and "derivative time" (D) parameters (level 1 mode).

For details on the setting ranges of these parameters, see chapter 5 Level 1 Mode (page 5-13).

K CHAPTER 4

APPLIED OPERATION

This chapter describes each of the parameters required for making full use of the features of the E5EK. Read this chapter while referring to the parameter descriptions in chapter 5.

4.1	Selecting the Control Method	4-2
	Heating and cooling control	4-2
	Position-proportional control	4-3
	ON/OFF control	4-4
4.2	Operating Condition Restrictions	4-5
	Manipulated variable restrictions	4-5
	Set point limiter	4-6
	SP ramp	4-6
4.3	How to Use Event Input	4-8
	Input assignments	4-8
	Multi-SP	4-9
	Other event input functions	4-10
4.4	How to Use the Remote SP	4-11
	Scaling	4-11
	SP mode	4-11
	Remote SP monitor	4-12
	SP tracking	4-12
	Operating conditions	4-12
4.5	How to Use the Heater Burnout Alarm ...	4-13
	Heater burnout detection	4-13
	Operating conditions	4-13
	How to calculate the heater burnout set value	4-14
4.6	LBA	4-15
4.7	How to Use Transfer Output	4-17

4.1 Selecting the Control Method

When selecting the control method, set the parameters according to the following table. (Parameters are factory-set to heating control.)

Control Method \ Parameter	Control output 1 assignment	Control output 2 assignment	Direct/Reverse operations
Heating control (Standard)	Control output (heat)	-	Reverse operation
Cooling control (Standard)	Control output (heat)	-	Direct operation
Heating and cooling control	Control output (heat)	Control output (cool)	Reverse operation

For details on how to assign outputs, see 3.3 Setting Output Specifications (page 3-6).

■ Heating and cooling control

● Dead band

- When heating and cooling control is selected, the “deadband” and “cooling coefficient” parameters can be used.

The dead band is set with the set point as its center. The dead band width is the set value of the “dead band” parameter (level 1 mode). Setting a positive value produces a dead band, while setting a negative value produces an overlap band.

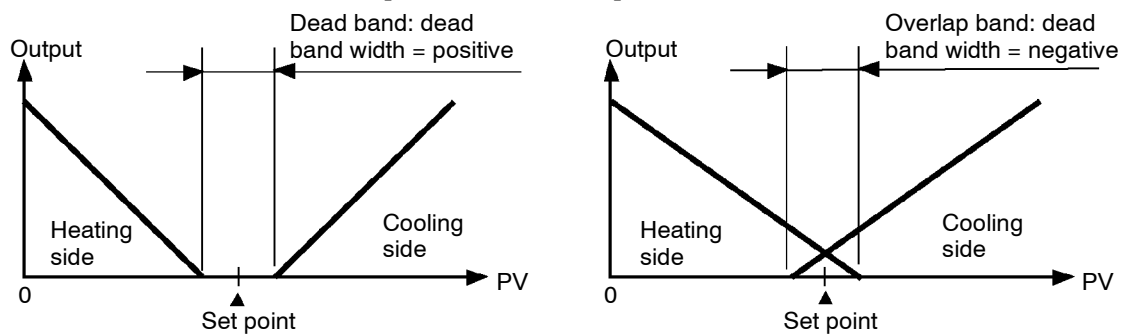

● Cooling coefficient

If the heating and cooling characteristics of the control target greatly differ, preventing satisfactory control characteristics from being obtained by the same PID parameters, adjust the proportional band (P at cooling side) using the cooling coefficient to balance control between the heating and cooling sides. In heating and cooling control, P at the heating or cooling side is calculated by the following formula:

$$\text{Heating side } P = P; \text{ Cooling side } P = \text{cooling coefficient} \times P$$

● Manipulated variable at stop

- In heating and cooling control, the manipulated variable output that is output when controller operation is stopped is dependent on the set value of the “MV at stop” parameter (level 2 mode) in the same way as for standard control.
- However, note that in heating and cooling control, the manipulated variable at the cooling side is treated as a negative value for the sake of convenience. When the manipulated variable at STOP is a negative value, the manipulated variable is output to only the cooling side, and when a positive value, the manipulated variable is output to only the heating side. The factory setting is “0”. If the controller is operated using the factory setting, the manipulated variable is not output to both the heating and cooling sides.



Switching with Manual operation

When the overlap band is set, the bumpless function that operates when switching between manual and automatic operation may not work.

■ Position-proportional control

- Use the position-proportional type controller for position-proportional control.
- On a position-proportional type controller, control output 1 is used for open output, and control output 2 is used for close output. Accordingly, control outputs 1 and 2 cannot be used as output assignments. Special output units are already set on position-proportional type controllers.
- On a position-proportional type controller, the following functions are disabled.

ST
 MV limiter
 P and PD control
 40% AT
 LBA
 HBA
 ON/OFF control

● Travel time

- The travel time is factory-set to “30 seconds.”
- To change the travel time, either set in the “travel time” parameter (option mode), or execute motor calibration in the “motor calibration” parameter (option mode).

● Valve opening monitor

- The valve opening can be monitored when a potentiometer is connected to the controller. However, be sure to execute motor calibration after connecting the potentiometer.

● Manipulated variable at stop/PV error

- Open, close or hold can be selected as output at stop or PV error. Set these outputs in the “manipulated variable at stop” or “manipulated variable at PV error” parameters (level 2 mode).

● Other functions

- Set the dead band in the “position-proportional dead band” parameter (level 1 mode).
- Set the open/close hysteresis in the “open/close hysteresis” parameter (level 1 mode).

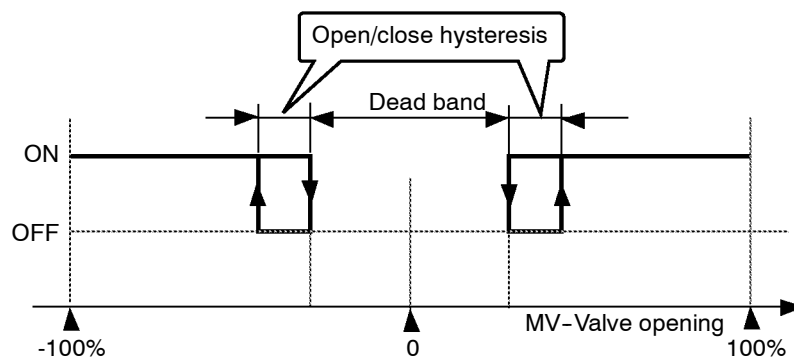

■ ON/OFF control

● Hysteresis

- Switching between advanced PID control and ON/OFF control is carried out by the “PID / ON/OFF” parameter (expansion mode). When this parameter is set to [P L d], advanced PID control is selected, and when set to [a n o f], ON/OFF control is selected. Default is [P L d].
- During position-proportional control, ON/OFF control cannot be selected.
- In ON/OFF control, hysteresis is provided in the program when switching between ON and OFF to stabilize operation. The hysteresis width provided during ON/OFF control is simply referred to as “hysteresis.” Control output (heat) and control output (cool) functions are set in the “hysteresis (heat)” and “hysteresis (cool)” parameters, respectively.
- In standard control (heating or cooling control), hysteresis can be set only for the heating side.

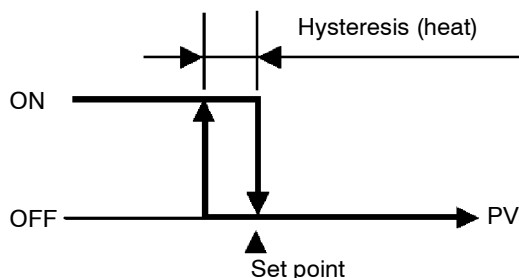

- In heating and cooling control, a dead band can be set. So, 3-position control is made possible.

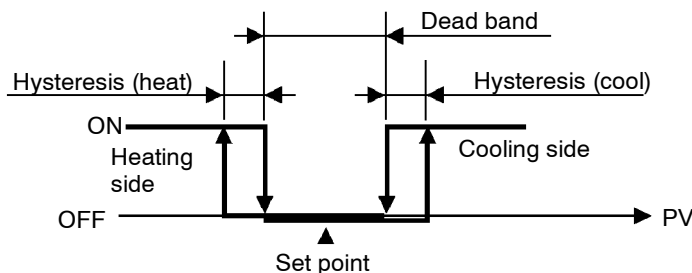

Parameters

Symbol	Parameter Name: Mode	Description
o u t 1	Control output 1 assignment : Setup	For specifying control method
o u t 2	Control output 2 assignment : Setup	For specifying control method
o r e u	Direct/Reverse operation : Setup	For specifying control method
[- d b	Dead band : Level 1	Heating and cooling control
[- S C	Cooling coefficient : Level 1	Heating and cooling control
n u - S	MV at stop : Level 2	Manipulated variable when control operation is stopped
n u - E	MV at PV error : Level 2	Manipulated variable when control operation is PV error
n o t	Travel time : Option	Position-proportional control
[R L b	Motor calibration : Option	Position-proportional control
d b	Positional-proportional dead band : Level 1	Position-proportional control
o c - H	Open/close hysteresis : Level 2	Position-proportional control
H Y S	Hysteresis (heat) : Level 1	ON/OFF control
[H Y S	Hysteresis (cool) : Level 1	ON/OFF control
[o f f	PID / ON/OFF : Expansion	ON/OFF control

4.2 Operating Condition Restrictions

■ Manipulated variable restrictions

The upper-and lower-limit values of the manipulated variable can be restricted by the MV limiter, and the change rate of the manipulated variable can be restricted by the MV change rate limiter.

● MV limiter

The upper-and lower-limit values of the manipulated variable are set in the “MV upper limit” and “MV lower limit” parameters (level 2 mode). When the manipulated variable calculated by the E5EK is outside of the range of the MV limiter, actual outputs are dependent on the set value of these parameters.

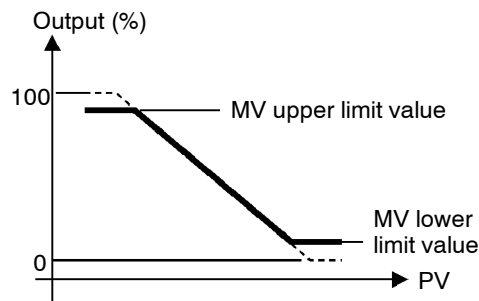

In heating and cooling control, the manipulated variable at the cooling side is treated as a negative value for the sake of convenience. The upper limit is set for the heating side (positive value), and the lower limit is set for the cooling side (negative value) as shown in the following figure.

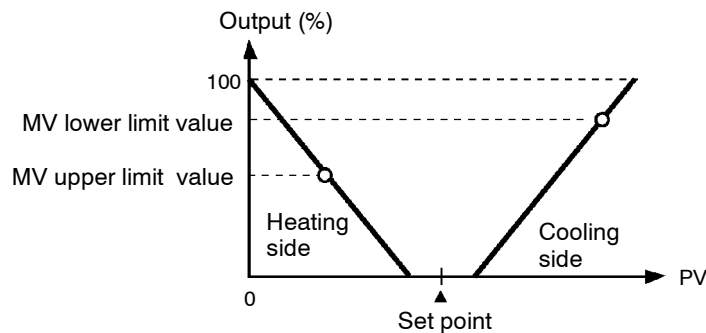

● MV change rate limiter

The “MV change rate limit” parameter (level 2 mode) sets the maximum permissible change width per second of the manipulated variable. If a change in the manipulated variable exceeds this parameter setting, the value calculated by the E5EK is reached while changing the value by the per-second value set in this parameter.

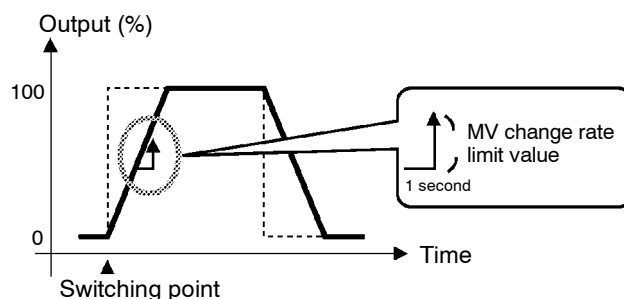

● **Limiter operation conditions**

The limiters are invalid or cannot be set when any of the following conditions occurs:

- During ON/OFF control
- During ST execution
- During AT execution (only by MV change rate limiter)
- During manual operation
- When operation is stopped
- When an error has occurred.
- During position-proportional control (manipulated variable limiter only)

■ **Set point limiter**

The setting range of the set point is limited by the set point limiter. The upper-and lower-limit values of this set point limiter are set in the “Set point upper limit” and “Set point lower limit” parameters (expansion mode), respectively. However, note that when the set point limiter is reset, the set point is forcibly changed to the upper-or lower-limit value of the set point limiter if the set point is out of the limiter range. Also, when the input type, temperature unit and scaling (sensor) range are changed, set point limiter is forcibly reset to the scaling (sensor) range.

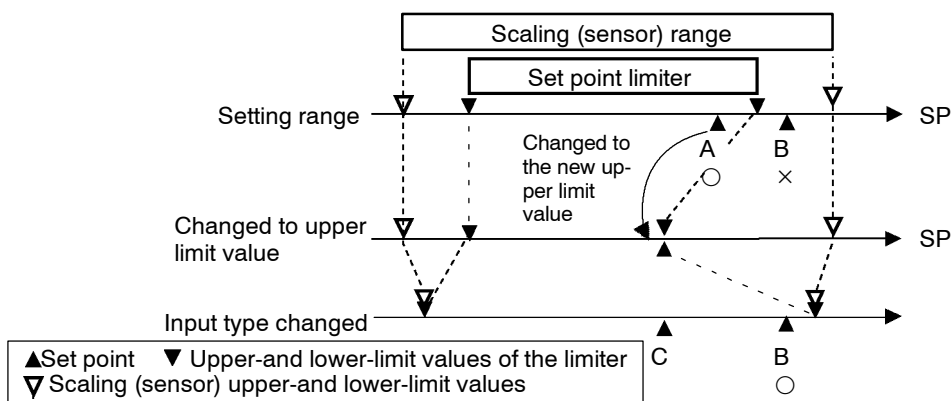

■ **SP ramp**

With the SP ramp function, the controller operates according to the value (set point during SP ramp) limited by a change rate, instead of the changed set point when set point is changed. The interval in which the set point during SP ramp is limited is referred to as the “SP ramp”.

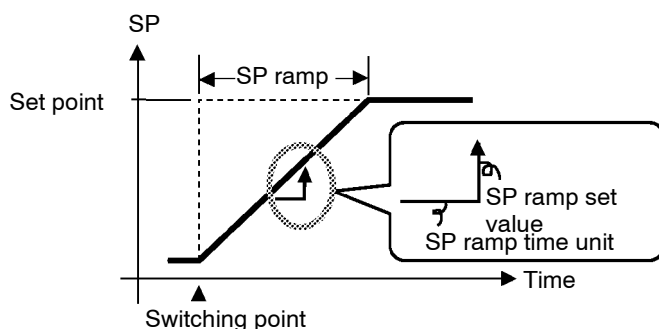

The change rate during the SP ramp is specified by the “SP ramp set value” and “SP ramp time unit” parameters. At the “SP ramp set value” default “0”, the SP ramp function is disabled.

The set point changing in SP ramp can be monitored in the “Set point during SP ramp” parameter (level 0 mode).

● Operation at start

The limiters are invalid or cannot be set when any of the following conditions occurs:

If the SP ramp function is enabled when the power is turned ON, and when “run” is switched to from “stop,” process value may reach the set point after SP ramp in the same way as when the set point is changed. In this case, operation is carried out with the process value regarded as the set point before the change was made.

The direction of the SP ramp changes according to the relationship between the process value and the set point.

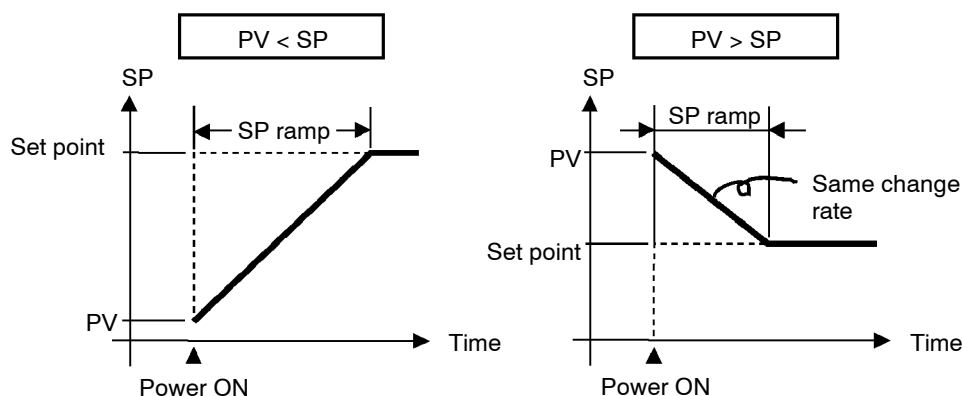

● Restrictions during SP ramp

- Execution of auto-tuning starts after the end of SP ramp.
- When the controller is switched to the manual mode, the set point changes continuously until SP ramp ends.
- When the controller is in the stop state or an error occurs, the SP ramp function becomes invalid.

Parameters

Symbol	Parameter Name: Mode	Description
$\bar{o}L-H$	MV upper limit : Level 2	Manipulated variable restrictions
$\bar{o}L-L$	MV lower limit : Level 2	Manipulated variable restrictions
$\bar{o}rL$	MV change rate limit : Level 2	Manipulated variable restrictions
$\bar{S}L-H$	SP setting upper limit: Expansion	SP setting restrictions
$\bar{S}L-L$	SP setting lower limit : Expansion	SP setting restrictions
$\bar{S}PrL$	SP ramp set value : Level 2	SP changing restrictions
$\bar{S}PrU$	SP ramp time unit : Level 2	SP changing restrictions

4.3 How to Use Event Input

- When using event input, mount the option unit (E53-AKB).
- Event inputs can be switched up to 100,000 times.

Input assignments

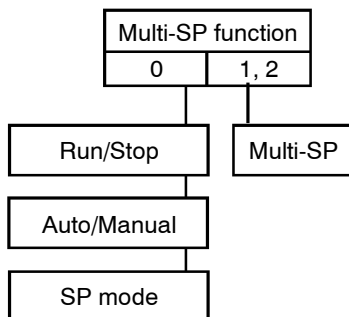

- You can choose from the following four event input functions:
 Multi-SP
 Run/Stop
 Auto/Manual
 SP mode

- In the case of the multi-SP function, the number of event inputs (event input 1 or 2) set in the “multi-SP function” parameter (option mode) are used.
- Other functions are assigned to event inputs 1 and 2 not used for the multi-SP function according to the setting of the “event input assignment 1 and 2” parameters (option mode). However, note that “event input assignment 1/2” parameters cannot be used when only one unit of the E53-AKB is installed.

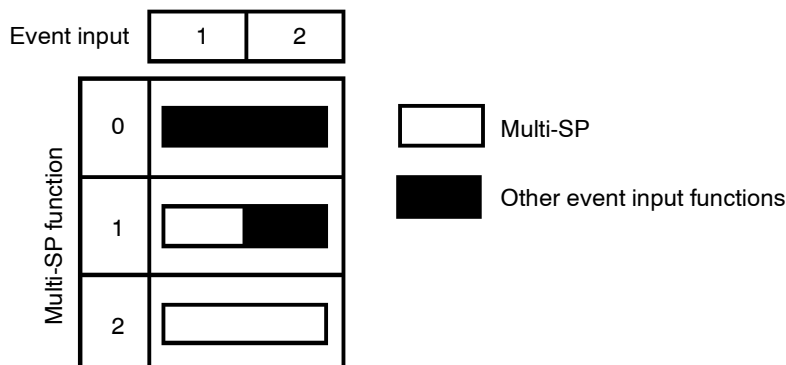

- The following table shows the relationship between the settings and functions of the “event input assignment 1 and 2” parameters.

Setting	Function
OFF	Event input disabled
STOP / OFF	ON : Stop / OFF : Run
MANUAL / OFF	ON : Manual / OFF : Auto
RSP / OFF	ON : RSP / OFF : LSP

● Assignment example

- In this example, set two event inputs are used, the multi-SP function to “1”, and event input 2 to “Run/Stop”. Set as follows:

- Set “multi-SP function” parameter to “1”
- Set “event input assignment 2” parameter to “Set SP”

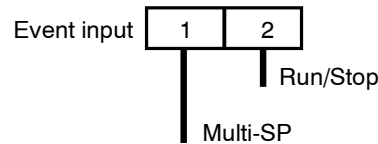

■ Multi-SP

- Set points 0 to 3 are set as the set point according to event input. However, note that these parameters can not be set when the multi-SP function is not selected. The following table shows the relationship between event inputs and set points 0 to 3.

Multi-SP Function	1	2	
Event Input	1	1	2
Set Point 0	OFF	OFF	OFF
Set Point 1	ON	ON	OFF
Set Point 2	-	OFF	ON
Set Point 3	-	ON	ON

- When you have changed the set point in the PV/SP display, the set point of the currently selected is also simultaneously changed.
- When you have switched between set point 0 to 3, the SP ramp function works if the SP ramp function is enabled. The following example shows how the set point changes when you switch from set point 0 to set point 1.

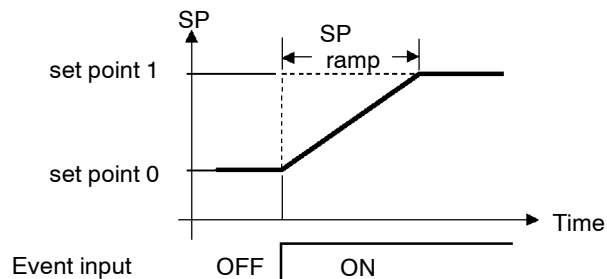

Other event input functions

- Switch the parameter settings for each of the run/stop, remote/local and SP modes.
- The switching operation of auto/manual is the same as that of the A/M key.
- There is no order of priority in event input and key operations. However, run/stop or auto/manual event inputs must be set to either of ON or OFF. So, parameters will always follow event input even if you try to switch settings by key operation.

● Run/Stop

- When event input is set to “ON”, controller operation is stopped and the “STOP” LED lights. The content of event input is reflected in the “run/stop” parameter (level 0 mode).

● Auto/Manual

- When event input is set to “ON”, the controller is switched for manual operation, and the “MANU” LED lights.
- Turn event input ON/OFF while the controller is ON.

● SP mode

- This function is enabled only when the “SP mode enable” parameter (option mode) is set to “ON”.
- When event input is set to “ON”, the remote SP (RSP) is taken as the set point, and the “RSP” LED lights. When event input is set to “OFF”, the local SP (LSP) is taken as the set point. The content of event input is reflected in the “SP mode” parameter (level 2 mode). For details on RSP/LSP, see 4.4 How to Use the Remote SP (page 4-11).

Parameters

Symbol	Parameter Name: Mode	Application
$E_{u-\tilde{n}}$	Multi-SP function : Option	Event input functions
E_{u-*}	Event input assignment 1 and 2 : Option	Event input functions
$SP-^{**}$	Set point 0 to 4 : Level 1	Multi-SP

* : 1 and 2 ** : 0 to 3

4.4 How to Use the Remote SP

- Taking a remote SP input (4 to 20 mA) as the set point is referred to as the “remote SP” function. The remote SP function is enabled only when the “remote SP (RSP) enable” parameter (option mode) is set to “ON”.

Scaling

- Remote SP upper-and lower-limit values can be set by scaling.
- Inputs within the range 4 to 20 mA (-10 to 110%) are allowed as remote SP inputs. Inputs not within this range are regarded as out-of-range input values. In this case, input is clamped at the remote SP lower or upper limit values, and the “RSP” LED blinks.
- If the output function “RSP input error” is assigned for when an out-of-range remote SP is input, the “RSP input error” output is turned ON. Control output also switches to the setting of the “MV at PV error” parameter.
- Set the upper limit value in the “remote SP upper limit” parameter and the lower limit value in the “remote SP lower limit” parameter (option mode).

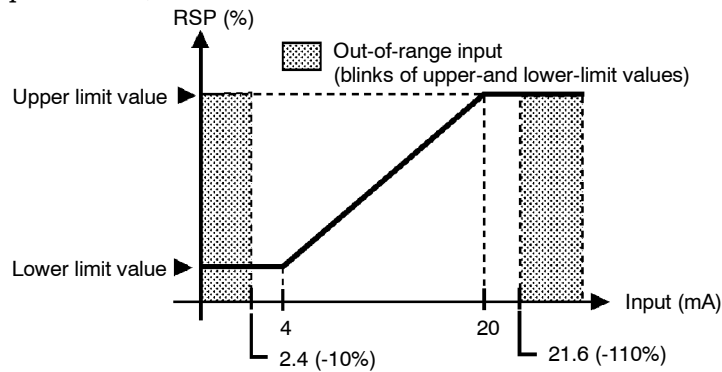

Relationship with set point limiter

- When the “Set point upper limit” or “Set point lower limit” parameters are changed, the remote SP upper-and lower-limit values are forcibly changed to the set point upper-and lower-limit values. The following example shows how the remote SP upper-and lower-limit values are changed when the set point upper limit value is changed from A to B.

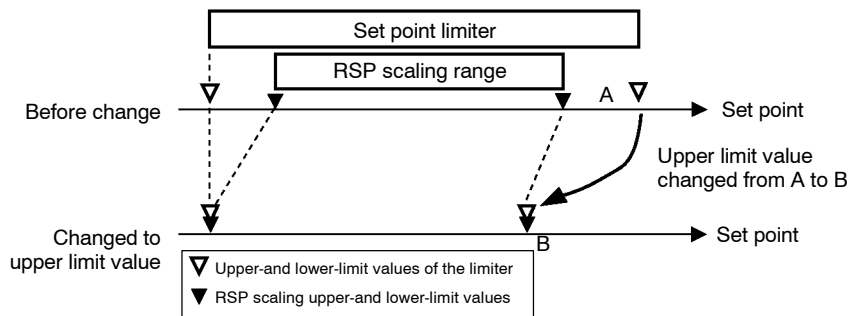

SP mode

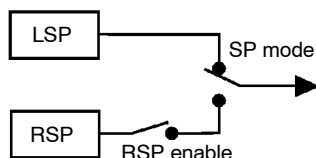

- The set point held internally by the E5EK controller is referred to as the “local SP (LSP).”
- If the multi-SP function is enabled, set points 0 to 3 are enabled for use as the local SP.
- Use the “SP mode” parameter to switch between the remote SP and local SP. When the SP mode parameter is set to “RSP” (remote SP), the “RSP” LED lights. When the SP mode parameter is set to “LSP”, the controller is in the local SP.

Remote SP monitor

- In the remote SP mode, the remote SP can be monitored on the No.2 display for PV/SP. In the local SP mode, the remote SP can be monitored in the “remote SP monitor” parameter.

SP tracking

- When the local SP is switched to from the remote SP when the SP tracking function is enabled, the local SP is changed so that the remote SP value is held at the SP value used immediately before switching.
To use the SP tracking function, set the “SP tracking” parameter to “ON”.
- The following figure shows how SP tracking works when the SP mode is switched.

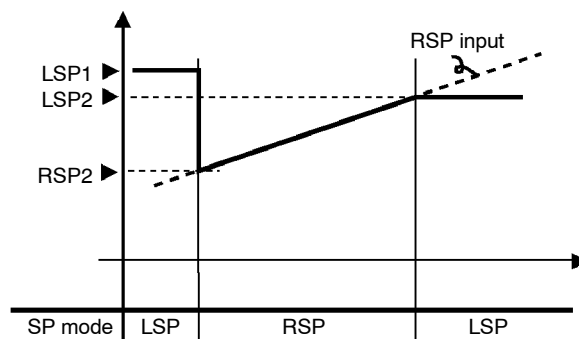

- (1) When the remote SP is switched to when the set point is “LSP1”, the SP is switched to “RSP2”.
 - (2) The SP shifts according to remote SP input.
 - (3) When the local SP is switched to, the set point becomes “LSP2” if the SP tracking function is enabled. If this function is disabled, the SP will be switched to “LSP1”.
- When the local SP is switched to the remote SP, the SP ramp will operate if the SP ramp function is enabled.

Operating conditions

- When the SP function is set to “ON”, the “SP mode” parameter is forcibly changed to [L SP] and the local SP is taken as the set point.
- During auto-tuning, remote SP input is not accepted. Auto-tuning is executed on the set point at the start of auto-tuning.
- Remote SP is not subject to the standby sequence reset conditions.

Parameters

Symbol	Parameter Name: Mode	Application
rSPU	Remote SP enable : Option	Remote SP function
rSPH	Remote SP upper limit : Option	RSP scaling
rSPL	Remote SP lower limit : Option	RSP scaling
rPnd	SP mode : Level 2	LSP/RSP switching
SPtr	SP tracking : Option	LSP/RSP switching

4.5 How to Use the Heater Burnout Alarm

■ Heater burnout detection

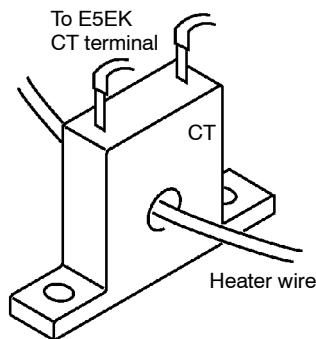

● HBA latch/release

■ Operating conditions

- On a standard type controller, the HBA (heater burnout alarm) function can be used only when the assignment destination of the output function “control output (heat)” is set to pulsed output.
- When using the HBA function, assign output function “heater burnout (HB) alarm” to auxiliary outputs 1 or 2.
- Heater burnout detection works as follows.
 - (1) Connect the current transformer (CT) to terminal Nos.15 and 17, and insert the heater lead through the CT hole.
 - (2) When current flows through this lead, the current transformer generates AC current proportional to the current value. The E5EK measures this AC current to calculate the current flowing to the heater.
 - (3) If heater is burned out, the current measured at the current transformer decreases. This value is compared with the value set as the heater burnout set value and is output as the heater burnout alarm.
- Set the heater burnout set value in the “heater burnout alarm” parameter. To check the current value of the current transformer, use the “heater current monitor” parameter.
- When you are not using the HBA function, set the “heater burnout alarm” parameter to “0.0 (disabled)”.
- When the HBA latch function is set to “ON”, the heater burnout alarm is held until either of the following measures is taken:
 - a Set the heater burnout set value to “0.0”.
 - b Reset the controller.
(Turn the controller’s power OFF then back ON again.)
- To enable the HBA latch function, set the “HBA latch” parameter to “ON”.
- Turn the heater power supply ON at the same time as or before turning the E5EK power supply ON. If the heater power supply is turned ON after turning the E5EK power supply On, the heater burnout alarm is output.
- Control is continued even when the heater burnout alarm is output. (That is, the controller attempts to control the heater as if the heater burnout alarm has not occurred.) So, remedy the condition such as repairs which are caused by the heater burnout alarm.
- The heater burnout alarm is detected only if the control output is continuously ON for 190 ms or more.
- The rated current value may sometimes differ slightly from the actual current value flowing to the heater. Check the current value in an actual operating status in the “heater current monitor” parameter.
- If there is little difference between the current in a normal status and the current in a burnout status, detection may become unstable. On a heater of current 10.0 A or less, maintain a difference of 1.0 A or more. On a heater of current 10.0 A or more, maintain a difference of 2.5 A or more.
- Heater burnout alarm function cannot be used when controlling the heater by a phase control method or by a cycle control method. Also, 3-phase heaters cannot be used.

When detecting heater burnout on a 3-phase heater, use the K2CU-F□□A-□GS (with gate input terminal). (For details, see the respective data sheet.)

How to calculate the heater burn-out set value

- Calculate the set value by the following formula:

$$\text{Set value} = \frac{(\text{current value at normal operation} + \text{current value at burnout})}{2}$$
- Set the current value at burnout when two or more heaters are connected to the CT to the value at the time that the heater having the smallest current value burns out (the value when one of the heaters burns out with all heaters at the same current).
- Make sure that the following condition is satisfied:
 - Heater of current 10.0 A or less
 Current value at normal operation – current value at heater burnout ≥ 1 A
 When resultant current is less than 1 A, detection is unstable.
 - Heater of current 10.0 A or more
 Current value at normal operation – current value at heater burnout ≥ 2.5 A
 When resultant current is less than 2.5 A, detection is unstable.
- The setting range is 0.1 to 49.9 A. Heater burnout is not detected when the setting is “0.0” or “50.0”. When the setting is “0.0”, the heater burnout alarm is set to “OFF”, and when the setting is “50.0”, the heater burnout alarm is set to “ON”.
- Set the total current value at normal heater operation to 50 A or less. When set to 55.0 A or more, [FFF] is displayed in the “heater current monitor” parameter.

Examples of use

Example 1 : when using a 200 VAC, 1 kW heater

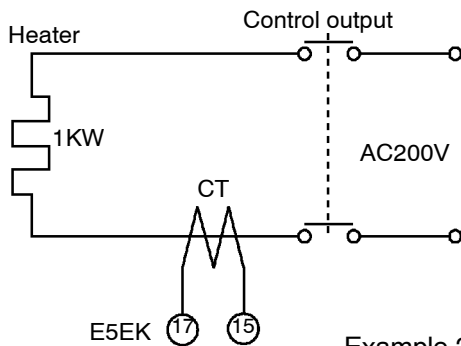

$$\text{Current at normal operation} = \frac{1000}{200} = 5\text{A} (<10\text{A})$$

$$\text{Current at heater burnout} = 0\text{A}$$

$$\text{Set value} = \frac{5+0}{2} = 2.5\text{A}$$

Example 2 : when using three 200 VAC, 1 kW heaters

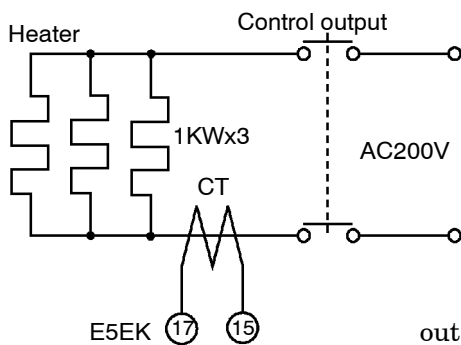

$$\text{Current at normal operation} = \frac{1000}{200} \times 3 = 15\text{A} (\geq 10\text{A})$$

$$\text{Current at burnout of one heater} = \frac{1000}{200} \times 2 = 10\text{A}$$

$$\text{Set value} = \frac{15+10}{2} = 12.5\text{A}$$

$$\begin{aligned} &(\text{current at normal operation} - \text{current at heater burnout}) \\ &= 15 - 10 = 5\text{A} (\geq 2.5\text{A}) \end{aligned}$$

Parameters

Symbol	Parameter Name: Mode	Application
CE	Heater current monitor : Level 1	Heater current value monitor
Hb	Heater burnout : Level 1	Heater burnout detection
HbL	Heater burnout latch : Option	Heater burnout detection alarm latch

4.6 LBA

- The LBA (Loop Break Alarm) function can be used only on standard type controllers.
- The LBA function can be used only when assigned as an output. Also, the LBA function does not work when a memory error or A/D converter error results.
- LBA (Loop Break Alarm) is a function for judging that an error has occurred somewhere on the control loop and outputting an alarm when the process value does not change with the manipulated variable at a maximum or minimum state. Accordingly, the LBA function can be used as a means for detecting a malfunctioning control loop.

● LBA detection time

- Normally, when output is set to maximum or minimum, the process value rises or falls after the dead time has elapsed. LBA is output if the process value does not change in the predicted direction after a fixed amount of time has elapsed. This fixed amount of time is the “LBA detection time.”

● LBA detection width

- LBA operation sometimes becomes unstable when the process value fluctuates considerably due to the control characteristics. The LBA detection width is provided so that changes with respect to output can be correctly detected. Changes smaller than the detection width due to LBA detection timing are not regarded as changes.

● LBA detection example

- The following example describes what happens when a heater burn-out at maximum output.

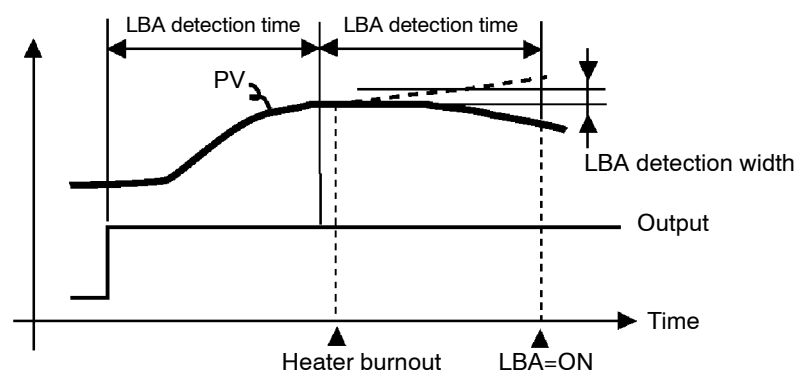

- LBA judgment is carried out at each LBA detection time from the point of maximum output. In above figure, the process value (PV) is changing greatly at the 1st judgment timing, so LBA remains OFF.
- At the 2nd judgment timing, the process value increases as indicated by the broken line of the process value is normal. This means that the change width exceeds the LBA detection width, and LBA output remains OFF.
- If the heater burns out at the point shown in the above figure, the process value “decreases.” Accordingly, it is judged that “the process value is not changing in the increasing direction” at the 2nd judgment timing and the LBA output becomes ON.

● **Setting the LBA detection time**

- The LBA detection time is automatically set by auto-tuning (except in heating and cooling control).
- If the optimum LBA detection time cannot be obtained by auto-tuning, set the time in the “LBA detection time” parameter (level 2 mode).

● **Determining the LBA detection time**

- Calculate the LBA detection time as follows:
 - (1) Set output to maximum.
 - (2) Measure the time it takes for the input change width to reach the LBA detection width (default: 0.2 % full-scale).
 - (3) Take a value twice that of the measurement time as the LBA detection time.

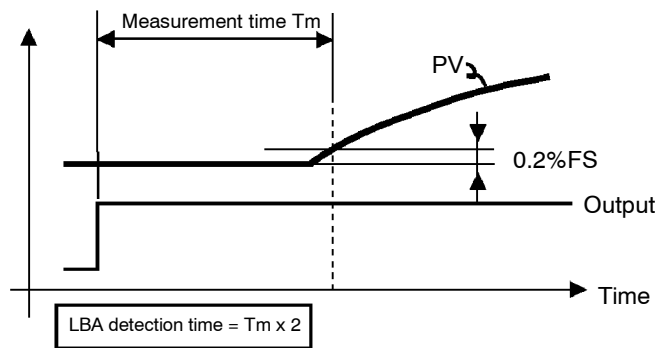

- (4) In the case of ON/OFF operation, set the LBA detection time to a value longer than the control period.

Parameters

Symbol	Parameter Name: Mode	Application
At	AT Execute/Cancel : Level 1	Automatic setting of LBA detection time
LbA	LBA detection time : Level 2	Setting of LBA detection time
LbAb	LBA detection width : Expansion	Changing of LBA detection width

4.7 How to Use Transfer Output

● Transfer output type

- When using transfer output, add on the communications unit (E53-AKF).
- You can select the following data items in the “transfer output type” parameter (option mode) as the transfer outputs:
 - Set point
 - Set point during SP ramp
 - Process value
 - Manipulated variable (heat)
 - Manipulated variable (cool), and
 - Valve opening.

However, note that heating/cooling side manipulated variables can be output only standard type controllers, and valve opening can be output on position-proportional type controllers

● Transfer output scaling

- If the output assignment is changed when either “manipulated variable (heat)” or “manipulated variable (cool)” parameter is selected, the default “set point” is returned to.
- These transfer outputs can be scaled according to the settings of the “transfer output upper limit” and “transfer output lower limit” parameters before output. Setting of an upper limit value smaller than the lower limit value is allowed, so reverse scaling can also be carried out. Also, the scale can be enlarged by the upper-and lower-limit width specified for each data item. The following example shows scaling of the reading side manipulated variable.

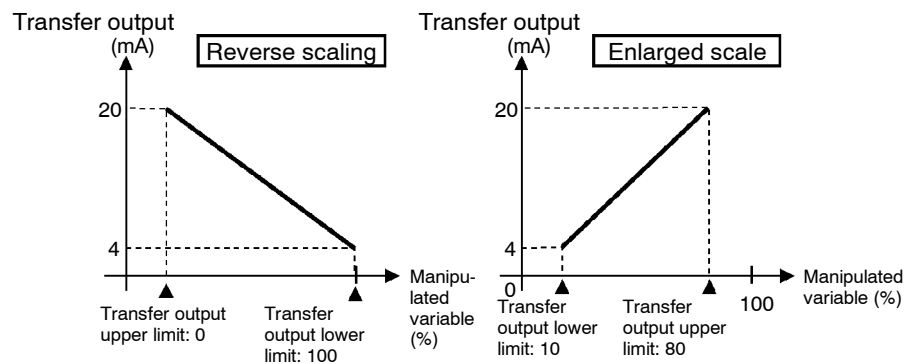

- If “input type”, “scaling upper/lower limit”, “SP limiter upper/lower limit”, or “°C/°F selection” parameters is changed when “set point”, “set point during SP ramp”, or “process value” parameter is selected, each of the “transfer output upper limit” and “transfer output lower limit” parameters are forcibly changed to their respective upper or lower limit values.

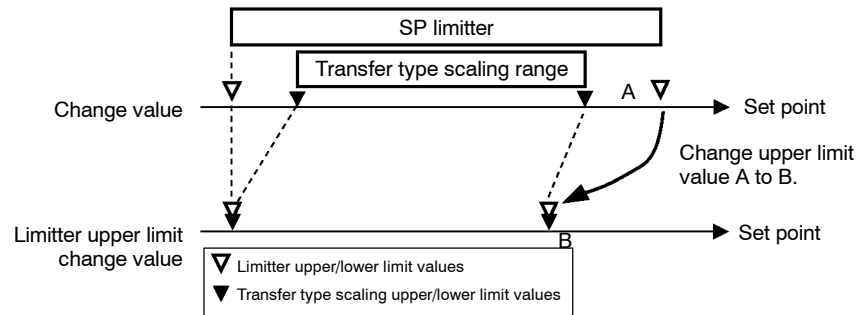

Parameters

Symbol	Parameter Name: Mode	Application
Er-E	Transfer output type : Option	Transfer output designation
Er-H	Transfer output upper limit : Option	Transfer output scaling
Er-L	Transfer output lower limit : Option	Transfer output scaling

K CHAPTER 5

PARAMETERS

This chapter describes the parameters of the E5EK. Use this chapter as a reference guide.

Conventions Used in this Chapter	5-2
Protect Mode	5-3
Manual Mode	5-5
Level 0 Mode	5-6
Level 1 Mode	5-10
Level 2 Mode	5-18
Setup Mode	5-25
Expansion Mode	5-32
Option Mode	5-37
Calibration Mode	5-46

Conventions Used in this Chapter

■ The meaning of icons used in this chapter



Function

Describes the functions of the parameter.



Comment

Describes the range and defaults of the parameter setting.



Monitor

Used for monitor-dedicated parameters.
Describes the range of the monitor values.



Example of use

Describes a procedure using parameters in operating instructions.



See

Describes related parameters and items.



Model





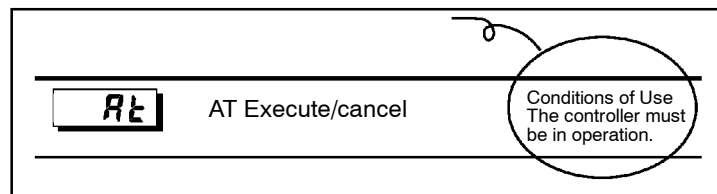

Describes models of the E5EK or option units supporting the parameter being described.

■ About parameter display

On the E5EK controller, only parameters that can be used are displayed. These parameters are displayed only when the “Conditions of Use” on the right of the parameter heading are satisfied. However, note that the settings of protected parameters are still valid, and are not displayed regardless of the conditions of use.



Protect Mode

- The protect mode is for disabling (protecting) the functions of the menu key or  key. Before changing parameters in this mode, first make sure that protecting the menu key or  key will not cause any problems in operation.
- To select this mode, press the  key and  key simultaneously for 1 second minimum. To exit this mode, press the  key and  key down again simultaneously for 1 second minimum.
- The following table shows the parameters supported in this mode and the page where the parameter is described.

Symbol	Parameter Name	Page
SECr	Security	5-3
PEYP	[A/M] key protect	5-4

Security



Function

- This parameter specifies which parameters are protected. However, note that the protect mode and manual mode cannot be protected.



Comment

- When this parameter is set to “0” to “3”, only the modes indicated by the “○” mark in the table below can be selected on the menu display. For example, when this parameter is set to “2”, only level 0 to 2 modes can be selected.

Mode	Set value			
	0	1	2	3
Calibration	○			
Option	○	○		
Expansion	○	○		
Setup	○	○		
Level 2	○	○	○	
Level 1	○	○	○	○
Level 0	○	○	○	○

- When this parameter is set to “4” to “6”, operations in only the level 0 mode can be selected, and the mode is not displayed on the menu display.
- When this parameter is set to “5”, only the “PV/SP” parameter in the level 0 mode can be used.
- When this parameter is set to “6”, only the “PV/SP” parameter in the level 0 mode can be used. (The set point cannot change.)
- Default is “1”. (Only the calibration mode is protected.)



See

- Related article
3.5 Protect Mode (page 3-12)

Protect Mode

PEYP [A/M] key protect







Function

- Invalidate the function of the  key. In other words, you cannot switch between the auto and manual operations by key operation.







Comment

- [] :  key protect ON
- [] :  key protect canceled
- Default = []



See





- Related article
3.5 Protect Mode (page 3-12)

- In this mode, manual operations are possible, and the “MANU” LED lights.
- When this mode is selected, the manipulated variable that was active immediately before the mode was switched to is output. When changing the manipulated variable, change it using the  or  keys.
If this mode is switched to during auto-tuning, auto-tuning is canceled.
- To select this mode when in the level 0 to 2 modes, press the  key for 1 second minimum. To exit this mode, press the  key for 1 second minimum. The mode changes to the level 0 mode.
- “Manual MV” is the only parameter available in this mode.

Manual MV



Function

- Sets the manipulated variable for manual operation or the valve opening. On a standard type controller when you press the  or  keys, the manipulated variable is changed. On a position-proportional type controller when you press the  key, the open side becomes ON, and when you press the  key, the close side becomes ON.
- On a standard type controller, the process value is displayed on the No.1 display and the manipulated variable is displayed on the No.2 display.

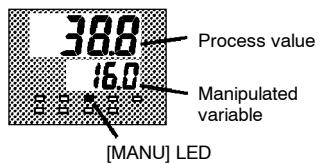

- When a potentiometer is connected on a position-proportional type controller, the process value is displayed on the No.1 display, and the valve opening is displayed on the No.2 display. When a potentiometer is not connected to the controller, [---] is displayed on the No.2 display.

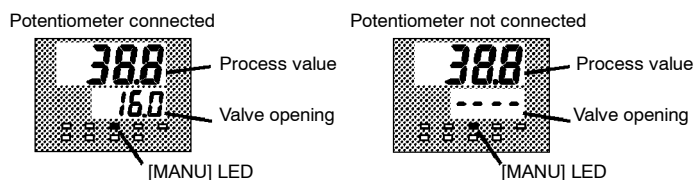

- On standard type controllers, the manual MV is held when the power is interrupted.



Comment

- Standard type

Control Method	Setting Range	Unit	Default
Standard	-5.0 to 105.0	%	0
Heating and cooling	-105.0 to 105.0	%	0

- Position-proportional type





Control Method	Monitor Range	Unit
Position-proportional	-10.0 to 110.0	%



See

- Related article
3.7 Adjusting Control Operation (page 3-14)

Level 0 Mode

- The parameters in this mode can be used only when the “security” parameter (protect mode) is set to “0” to “4”.
- The “PV/SP” parameter can be used when the “security” parameter is set to “5” or “6”. However, note that the SP cannot be changed when it is set to “6”.
- This mode is used for monitoring the process value, set point and manipulated variable during operation, and for checking and setting the SP setting value. It is also used for starting and stopping controller operation.
- To select this mode when in the levels 1 and 2, setup, expansion, option and calibration modes, press the  key for 1 second minimum. The display changes to the menu display. If you select [L - 0] then press  key for 1 second minimum, the controller enters the level 0 mode.
- To select parameters in this mode, press the  key. To change parameter settings, use the  or  keys.
- The following table shows the parameters supported in this mode and the page where the parameter is described.

Symbol	Parameter Name	Page
	PV/SP	5-6
r-SP	Remote SP monitor	5-7
SP-n	Set point during SP ramp	5-8
o	MV monitor (heat)	5-8
[- o	MV monitor (cool)	5-8
u-n	Valve opening monitor	5-9
r-S	Run/Stop	5-9

PV/SP



Function

- The process value is displayed on the No.1 display, and the set point is displayed on the No.2 display. The set point can be set.
- Either of the local SP or remote SP is displayed as the set point depending on the SP mode. In the remote SP mode, the set point is only monitored.

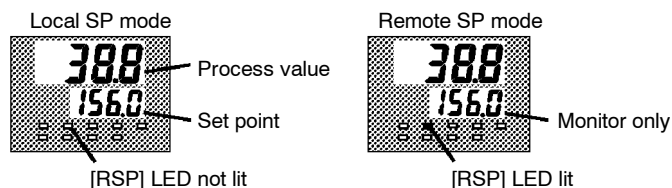

- The selected set point is linked when the multi-SP function is in use in the local SP mode. For example, when set point 1 is selected, set point 1 is displayed on the No.2 display, and the setting of the “set point 1” parameter (level 1 mode) also is changed when the value of set point 1 is changed.
- The decimal point position is dependent on the selected sensor during temperature input and on the results of scaling during analog input.



Comment

- Process value

Monitor Range	Unit
Scaling lower limit -10%FS to scaling upper limit +10%FS	EU

During temperature input, the range of the currently selected sensor is taken as the monitor range.

- Set point

Setting Range/Monitor Range	Unit	Default
Local SP : Local SP lower limit to local SP setting upper limit	EU	0
Remote SP: Remote SP lower limit to remote SP upper limit	EU	-



See

- Related article
3.7 Adjusting Control Operation (page 3-14)
- Related parameters
“Input type” “Scaling upper limit” “Scaling lower limit” “Decimal point” (setup mode)
“SP setting upper limit” “SP setting lower limit” (expansion mode)
“SP mode” (level 2 mode)
“Remote SP enable” “Remote SP upper limit” “Remote SP lower limit” (option mode)

r-SP

Remote SP monitor

Conditions of Use

The controller must be in the local SP mode with the remote SP function enabled.



Function

- Monitors remote SP in the local SP mode.



Monitor

Monitor Range	Unit
Remote SP lower limit to Remote SP upper limit	EU



See

- Related article
4.2 Operating Condition Restrictions/SP ramp (page 4-6)
- Related parameters
“SP mode” (level 2 mode)
“Remote SP enable” “Remote SP lower limit” “Remote SP upper limit” (option mode)

Level 0 Mode

SP - \ddot{a}

Set point during SP ramp

Conditions of Use

The remote SP function must be enabled. When the remote SP function is disabled, this function can be used only when the SP ramp function is enabled.



Function

- Monitors the set point during SP ramp
- Matches the set point of the “PV/SP” parameter when the set point is not during SP ramp.



Monitor

Monitor Range	Unit
Local SP : Local SP setting lower limit to local SP setting upper limit	EU
Remote SP : Remote SP lower limit to remote SP upper limit	EU



See

- Related article
4.2 Operating Condition Restriction/SP ramp (page 4-6)
- Related parameters
“PV/SP” (level 0 mode)
“SP ramp time unit” “SP ramp set value” (level 2 mode)
“Set point upper limit” “Set point lower limit” (expansion mode)
“SP mode” (level 2 mode)
“Remote SP enable” “Remote SP upper limit” “Remote SP lower limit” (option mode)

\ddot{a}

MV monitor (heat)

Conditions of Use

Control must be standard control or heating and cooling control.

$\zeta - \ddot{a}$

MV monitor (cool)



Function

- This parameter cannot be set.
- Monitors the manipulated variable on the heating or cooling side.
- The manipulated variable in a standard control system is checked in the “MV monitor (heat)” parameter.
- The “MV monitor (cool)” parameter can be used only during heating and cooling control.



Monitor

- MV monitor (heat)

Control	Monitor Range	Unit
Standard	-5.0 to 105.0	%
Heating and cooling	0.0 to 105.0	%

- MV monitor (cool)

Control	Monitor Range	Unit
Heating and cooling	0.0 to 105.0	%



Model

E5EK-AA2 AC100-240
E5EK-AA2 AC/DC24



Valve opening monitor

Conditions of Use
Control must be position-proportional control



Function

- Monitors the valve opening during position-proportional control.



Monitor

Monitor Range	Unit
-10 to +110	EU



See

- Related article
4.1 Selecting the Control Method/Position-proportional control (page 4-3)



Model

E5EK-PRR2 AC100-240

E5EK-PRR2 AC/DC24

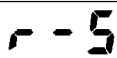

Run/Stop



Function

- This parameter is used for checking the operating status of the controller, and for specifying start and stop of operation.
- When the “run/stop” function is assigned to event input, “stop” is set when event input is ON, and “run” is set when event input is OFF. There is no order of priority in key operations.



Example of use





- To start operation, set this parameter to [5 5] press the or keys. To stop operation, set this parameter to [5 6 P]. When operation is stopped, the “STOP” LED lights.
- Default is [5 5]



See

- Related article
3.6 Starting and Stopping Operation (page 3-13)

Level 1 Mode

- The parameters in this mode can be used only when the “security” parameter (protect mode) is set to “0” to “3”.
- This mode contains the main parameters for adjusting control. These parameters include parameters for executing AT (auto-tuning), setting the alarm values, setting the control period, and setting PID parameters.
- To select this mode when in the levels 0 and 2, setup, expansion, option and calibration modes, press the  key for 1 second minimum. The display changes to the menu display. If you select [L u - !] then press the  key for 1 second minimum, the controller enters the level 1 mode.
- To select parameters in this mode, press the  key. To change parameter settings, use the  or  keys.
- The following table shows the parameters supported in this mode and the page where the parameter is described.

Symbol	Parameter Name	Page
At	AT Execute/Cancel	5-11
SP-0	Set point 0	5-11
SP-1	Set point 1	5-11
SP-2	Set point 2	5-11
SP-3	Set point 3	5-11
AL-1	Alarm value 1	5-12
AL-2	Alarm value 2	5-12
AL-3	Alarm value 3	5-12
P	Proportional band	5-12
I	Integral time	5-12
d	Derivative time	5-12
[- SC	Cooling coefficient	5-13
[- db	Dead band	5-14
db	Position-proportional dead band	5-14
oF - r	Manual reset value	5-15
HYS	Hysteresis (heat)	5-15
[HYS	Hysteresis (cool)	5-15
[P	Control period (heat)	5-16
[- [P	Control period (cool)	5-16
[t	Heater current monitor	5-17
Hb	Heater burnout	5-17

AT

AT Execute/Cancel

Conditions of Use

The controller must be in operation, control must be advanced PID control, and ST must be set to OFF.



Function

- Selects the limit cycle of MV change width (40% or 100%) for execution. After AT execution, the “PID” and the “LBA detection time” (LBA: Loop Break Alarm) parameters are set automatically.
- During heating and cooling control or position-proportional control, only 100%AT can be executed.



Example of use

- When this parameter is selected, the setting becomes [0FF].
- To execute 40%AT, select [AT - 1], and to execute 100%AT, select [AT - 2]. During execution of auto-tuning, the AT LED flashes. However, note that during heating and cooling control or position-proportional control, [AT - 1] is not displayed.
- When AT execution ends, the parameter setting automatically returns to [0FF].



See

- Related article
3.7 Adjusting Control Operation (page 3-16)
- Related parameters
“Run/Stop” (level 0 mode)
“Proportional band” “Integral time” “Derivative time” (level 1 mode)
“LBA detection time” (level 2 mode)

SP-0

Set point 0

SP-2

Set point 2

SP-1

Set point 1

SP-3

Set point 3

Conditions of Use

The controller must be in the local SP mode with the multi-SP function enabled.



Function

- Switches set points 0 to 3 by event input for use as the set point (local SP).
- Of set points 0 to 3, the number of valid set points is designated by the “multi-SP function” parameter.
- The following table shows the relationship between event input and the selected parameter.

Multi-SP Function	1		2	
	1	1	2	
Set Point 0	OFF	OFF	OFF	
Set Point 1	ON	ON	OFF	
Set Point 2	-	OFF	ON	
Set Point 3	-	ON	ON	

- When the set point has been changed, the setting of whichever is selected in event input, “set point 0” to “set point 3”, is linked and changed.
- The decimal point position is dependent on the selected sensor during temperature input and on the results of scaling during analog input.

Level 1 Mode



Comment

Setting Range	Unit	Default
Set point lower limit to Set point upper limit	EU	0



See

- Related article
4.3 How to Use Event Input (page 4-8)
- Related parameters
“Multi-SP function” “Remote SP enable” (option mode)
“Set point” (level 0 mode) “SP mode” (level 2 mode)
“Input type” “Scaling upper limit” “Scaling lower limit” “Decimal point” (setup mode)



Model

- Option unit
E53-AKB

AL - 1

Alarm value 1

AL - 2

Alarm value 2

AL - 3

Alarm value 3

Conditions of Use

Alarms must be assigned as outputs. For example, if alarm outputs 1 and 2 only are assigned as outputs, the “alarm value 3” parameter cannot be used.



Function

- This parameter is used for monitoring or changing the alarm values of alarm outputs 1 to 3.
- During temperature input, the decimal point position is dependent on the currently selected sensor, and during analog input on the results of scaling.



Comment

Setting Range	Unit	Default
-1999 to 9999	EU	0



See

- Related article
3.4 Setting Alarm Type (page 3-9)
- Related parameters
“Input type” “Scaling upper limit” “Scaling lower limit” “Decimal point” “Control output 1 assignment” “Control output 2 assignment” “Auxiliary output 1 assignment” “Auxiliary output 2 assignment” “Alarm 1 type” “Alarm 2 type” “Alarm 3 type” “Alarm 1 open in alarm” “Alarm 2 open in alarm” “Alarm 3 open in alarm” (setup mode)
“Alarm 1 hysteresis” “Alarm 2 hysteresis” “Alarm 3 hysteresis” (level 2 mode)
“Standby sequence reset method” (expansion mode)



Proportional band

Conditions of Use

Control must be advanced PID control, and ST must be set to OFF.



Integral time



Derivative time



Function

- Sets the PID parameters. However, note that the PID parameter settings are changed to optimum values when auto-tuning is executed, and self-tuning is selected.



Comment

Parameter	Setting Range	Unit	Default
Proportional band	0.1 to 999.9	%FS	10.0
Integral time	0 to 3999 (see note1)	Second	233
Derivative time	0 to 3999	Second	40

note 1 : During position-proportional control, the setting range become 1 to 3999s.



See

- Related parameter
“AT Execute/Cancel” (level 1 mode)



Cooling coefficient

Conditions of Use

The control must be either heating and cooling control, or advanced PID control.



Function

- In heating and cooling control, P at the cooling side is calculated by the following formula:

$$\text{Cooling side P} = \text{cooling coefficient} \times P$$



Comment

Setting Range	Unit	Default
0.01 to 99.99	None	1.00



See

- Related article
4.1 Selecting the Control Method (page 4-2)
- Related parameter
“Proportional band” (level 1 mode)



Model

E5EK-AA2 AC100-240

E5EK-AA2 AC/DC24

Level 1 Mode

[-db]

Dead band

Conditions of Use

The control system must be heating and cooling control.



Function

- Sets the output dead band width in a heating and cooling control system. A negative setting sets an overlap band.



Comment

Setting Range	Unit	Default
-19.99 to 99.99	%FS	0.00



See

- Related article
4.1 Selecting the Control Method (page 4-2)



Model

E5EK-AA2 AC100-240
E5EK-AA2 AC/DC24

db

Position-proportional dead band

Conditions of Use

Control must be position-proportional control



Function

- Sets the output hold width during position-proportional control (ON/OFF switching point for open and close output).

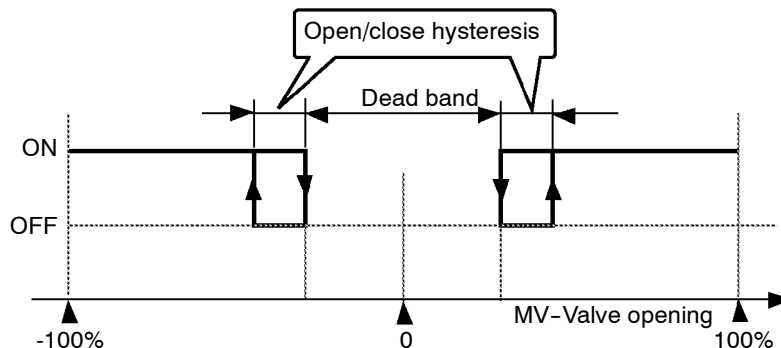

Setting Range	Unit	Default
0.1 to 10.0	%	2.0



Comment

- Related article
4.1 Selecting the Control Method/Position-proportional Control (page 4-3).



See

- Related parameter
“Open/close hysteresis” (level 2 mode)



Model

E5EK-PRR2 AC100-240
E5EK-PRR2 AC/DC24

0F-r

Manual reset value

Conditions of Use

The control must be either standard control or advanced PID control, ST must be set to OFF, and the “integral time” parameter must be set to “0”.



Function

- Sets the required manipulated variable to remove offset during stabilization of P or PD control.



Comment

Setting Range	Unit	Default
0.0 to 100.0	%	50.0



Model

E5EK-AA2 AC100-240
E5EK-AA2 AC/DC24

HYS

Hysteresis (heat)

Conditions of Use

The control system must be ON/OFF control.

CHYS

Hysteresis (cool)



Function

- Sets the hysteresis for ensuring stable operation at ON/OFF switching.
- In standard control, use the “hysteresis (heat)” parameter. The “hysteresis (cool)” parameter cannot be used.
- In heating and cooling control, the hysteresis can be set independently for heating and cooling. Use the “hysteresis (heat)” parameter to set the heating side hysteresis, and use the “hysteresis (cool)” parameter to set the cooling side hysteresis.



Comment

Parameter	Setting Range	Unit	Default
Hysteresis (heat)	0.01 to 99.99	%FS	0.10
Hysteresis (cool)	0.01 to 99.99	%FS	0.10



See

- Related article
4.1 Selecting the Control Method/ON/OFF control (page 4-4)
- Related parameters
“Control output 1 assignment” “Control output 2 assignment” (setup mode)
“PID / ON/OFF” (expansion mode)



Model

E5EK-AA2 AC100-24
E5EK-AA2 AC/DC24

Level 1 Mode

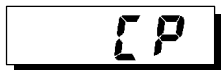

Control period (heat)

Conditions of Use

Relay or voltage output must be set as the outputs, and the control must be set to advanced PID control, standard control or heating and cooling control.

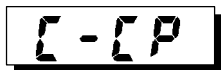

Control period (cool)



Function

- Sets the pulse output period. Set the control period taking the control characteristics and life expectancy of the controller into consideration.
- In standard control, use the “control period (heat)” parameter. The “control period (cool)” parameter cannot be used.
- In heating and cooling control, the control period can be set independently for heating and cooling. Use the “control period (heat)” parameter to set the heating side control period, and use the “control period (cool)” parameter to set the cooling side control period.



Comment

Parameter	Setting Range	Unit	Default
Control period (heat)	1 to 99	Second	20
Control period (cool)	1 to 99	Second	20



See

- Related article
3.3 Setting Output Specifications (page 3-6)
- Related parameters
“Control output 1 assignment” “Control output 2 assignment” (setup mode)



Model

E5EK-AA2 AC100-240
E5EK-AA2 AC/DC24



Heater current monitor

Conditions of Use

The HBA output function must be assigned.



Function

- Measures the current value of the heater from CT input.



Monitor

Monitor Range	Unit
0.0 to 55.0	A

- [FFFF] is displayed when 55.0 A is exceeded.



See

- Related article
4.5 How to Use the Heater Burnout Alarm (page 4-13)
- Related parameters
“Heater burnout” (level 1 mode) “HBA latch” (option mode)



Model

E5EK-AA2 AC100-240
E5EK-AA2 AC/DC24



Heater burnout

Conditions of Use

The HBA output function must be assigned.



Function

- Outputs the heater burnout alarm when the heater current value falls below this parameter setting.
- When the set value is “0.0”, the heater burnout alarm is “OFF”. When the set value is “50.0”, the heater burnout alarm is “ON”.



Comment

Setting Range	Unit	Default
0.0 to 50.0	A	0.0



See







- Related article
4.5 How to Use the Heater Burnout Alarm (page 4-13)
- Related parameters
“Heater current monitor” (level 1 mode) “HBA latch” (option mode)



Model

E5EK-AA2 AC100-240
E5EK-AA2 AC/DC24

Level 2 Mode

- The parameters in this mode can be used only when the “security” parameter (protect mode) is set to “0” to “2”.
- This mode contains the auxiliary parameters for adjusting control. These parameters include parameters for limiting the manipulated variable and set point, parameters for switching between remote and local operation, and parameters for setting the LBA (Loop Break Alarm), alarm hysteresis, and input digital filter values.
- To select this mode when in the levels 0 and 1, setup, expansion, option and calibration modes, press the  key for 1 second minimum. The display changes to the menu display. If you select [L u - ?] using the   key then press the  key for 1 second minimum, the controller enters the level 2 mode.
- To select parameters in this mode, press the  key. To change parameter settings, use the  or  keys.
- The following table shows the parameters supported in this mode and the page where the parameter is described.

Symbol	Parameter Name	Page
r-L	Remote/Local	5-19
SP-ñ	SP mode	5-19
SPrU	SP ramp time unit	5-20
SPrE	SP ramp set value	5-20
LbA	LBA detection time	5-21
ñu-S	MV at stop	5-21
ñu-E	MV at PV error	5-21
õL-H	MV upper limit	5-22
õL-L	MV lower limit	5-22
õrL	MV change rate limit	5-22
LnF	Input digital filter	5-23
õC-H	Open/close hysteresis	5-23
ALH1	Alarm 1 hysteresis	5-24
ALH2	Alarm 2 hysteresis	5-24
ALH3	Alarm 3 hysteresis	5-24
LnSH	Input shift upper limit (temperature)	5-24
LnSL	Input shift lower limit (temperature)	5-24



Remote/Local

Conditions of Use

The communications function must be in use.



Function

- Switches between remote and local operation.
- To change the parameter setting during remote operation, use the communications function. To change the parameter setting during local operation, change the setting on the E5EK controller.

You can check the parameter setting by both communications and on the E5EK controller regardless of whether the controller is switched to remote or local operation.



Comment

Setting Range	Default
[r r̄]: remote / [L L̄]: local	[L L̄]



See

- Related article
Chapter 6 Using the Communications Function
- Related parameters
“Communication stop bit” “Communication data length” “Communication parity” “Communication baud rate” “Communication unit No.” “Event input assignment 1” “Event input assignment 2” (option mode)



Model

- Option units
E53-AK01/02/03



SP mode

Conditions of Use

The remote SP function must be enabled and ST must be set to OFF.



Function

- Switches between remote SP and local SP.
- Switches the SP to the remote SP when an event input to which the “SP mode” has been assigned is ON. Switches the SP to the local SP when an event input to which the “SP mode” has been assigned is OFF.



Comment

Setting Range	Default
[r SP]: Remote SP/[L SP]: Local SP	L SP



See

- Related article
4.4 How to Use the Remote SP (page 4-11)
- Related parameters
“Remote SP enable”
“Event input assignment 1” “Event input assignment 2” “Event input assignment 3” “Event input assignment 4” (option mode)

Level 2 Mode

SP-r-U SP ramp time unit

Conditions of Use
ST must be set to OFF.

SP-r-t SP ramp set value



Function

- Specifies the change rate during SP ramp operation. Set the maximum permissible change width per unit of time (minute or hour) as the “SP ramp set value”. However, note that when set to “0”, the SP ramp function is disabled.
- The time unit and SP ramp set value are independent of each other. For example, when setting “30 per minute”, set the “SP ramp set value” parameter to “30” and the “SP ramp time unit” parameter to [**M**] (“minute”). However, if you change the time unit only to [**H**] (“hour”), the set time becomes “30 per hour.”
- During temperature input, the decimal point position of the SP ramp set value is dependent on the currently selected sensor, and during analog input on the results of scaling.



Comment

Parameter	Setting Range	Unit	Default
SP ramp time unit	[M]: minute/ [H : hour	None	M
SP ramp set value	0 to 9999	EU	0

During temperature input, the range of the currently selected sensor is taken as the setting range for the “SP ramp set value” parameter.



See

- Related article
4.2 Operating Condition Restrictions/SP ramp (page 4-6)
- Related parameters
“Input type” “Scaling upper limit” “Scaling lower limit” “Decimal point” (setup mode)

LbA

LBA detection time

Conditions of Use

The LBA (Loop Break Alarm) function must be assigned as an output.



Function

- This parameter is automatically set by AT execution (excluding AT execution in a ON/OFF control).
- The LBA is output if the change width of the process value falls below 0.2 %full-scale of the time preset to this parameter when the manipulated variable is set in the “MV upper limit” or “MV lower limit” parameters.
- The LBA function is disabled when this parameter is set to “0”.



Comment

Setting Range	Unit	Default
0 to 9999	Second	0



See

- Related article
 - 4.4 LBA (page 4-9)
 - 7.3 How to Use Error Output (page 7-5)
- Related parameters
 - “AT Execute/Cancel” (level 1 mode)
 - “Control output 1 assignment” “Control output 2 assignment” “Auxiliary output 1 assignment” (setup mode)

MV-5

MV at stop

Conditions of Use

Advanced PID control

MV-E

MV at PV error



Function

- The “MV at stop” parameter sets the manipulated variable when operation stops on a standard type controller. On a position-proportional type controller, this parameter sets the action (close/hold/open) when operation stops.
- The “MV at PV error” parameter sets the manipulated variable when an input error occurs. On a position-proportional type controller, this parameter sets the action (close/hold/open) when an input error occurs.



Comment

- Standard type

Control Method	Setting Range	Unit	Default
Standard	-5.0 to 105.0	%	0
Heating and cooling	-105.0 to 105.0	%	0

The manipulated variable at the cooling side during heating and cooling control is expressed as a negative value.

- Position-proportional type

Setting Range	Unit	Default
[Hold]: Hold/[Open]: Open/[Close]: Close	None	Hold



See

- Related articles
 - MV at stop : 3.6 Starting and Stopping Operation (page 3-13)
 - MV at PV error : 8.2 How to Use the Error Display (page 8-3)

Level 2 Mode

OL-H

MV upper limit

OL-L

MV lower limit

OrL

MV change rate limit

Conditions of Use

The control must be advanced PID control, and ST must be set to OFF.



Function

- The “MV upper limit” and “MV lower limit” parameters set the upper and lower limits of the manipulated variable. When the manipulated variable calculated by the E5EK controller is outside of the upper-and lower-limit range, the upper limit or lower limit set to these parameters is output, respectively. However, note that these parameters are disabled during position-proportional control.

- The “MV change rate limit” parameter sets the maximum permissible change width per second of the manipulated variable (On the position-proportional control, valve, opening). If a change in the manipulated variable (On the position-proportional control, valve, opening) causes this parameter setting to be exceeded, the calculated value is reached while changing the value by the per-second value set in this parameter.

This function is disabled when the set value is “0.0”.



Comment

- MV upper limit
The setting ranges during standard control and heating and cooling control are different. Also, the manipulated variable at the cooling side during heating and cooling control is expressed as a negative value.

Control Method	Setting Range	Unit	Default
Standard	MV lower limit +0.1 to 105.0	%	105.0
Heating and cooling	0.0 to 105.0	%	105.0

- MV lower limit
The setting ranges during standard control and heating and cooling control are different. Also, the manipulated variable at the cooling side during heating and cooling control is expressed as a negative value.

Control Method	Setting Range	Unit	Default
Standard	-5.0 to MV upper limit -0.1	%	-5.0
Heating and cooling	-105.0 to 0.0	%	-105.0

- MV change rate limit

Setting Range	Unit	Default
0.0 to 100.0	%	0.0



See

- Related article
4.2 Operating Condition Restrictions/Manipulated variable restrictions (page 4-5)

LnF

Input digital filter



Function

- Sets the time constant of the input digital filter. The following figures shows the effect on data after passing through the digital filter.

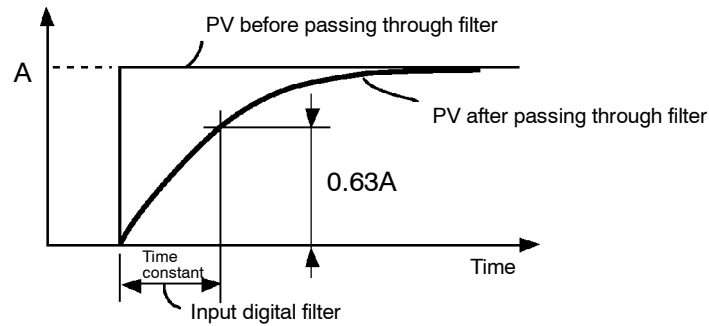

Comment

Setting Range	Unit	Default
0 to 9999	Second	0

oC-H

Open/close hysteresis

Conditions of Use

Control must be position-proportional control.



Function

- Provides hysteresis at ON/OFF switching of open or close output in position-proportional control.



Comment

Setting Range	Unit	Default
0.1 to 20.0	%	0.8



See

- Related article
4.1 Selecting the Control Method/Position-proportional Control (page 4-3)



Model

E5EK-PRR2 AC100-240

E5EK-PRR2 AC/DC24

Level 2 Mode

- ALH1** Alarm 1 hysteresis
- ALH2** Alarm 2 hysteresis
- ALH3** Alarm 3 hysteresis

Conditions of Use

Alarms must be assigned as outputs.
For example, if alarm outputs 1 and 2 only are assigned as outputs, the “alarm 3 hysteresis” parameter cannot be used.



Function

- This parameter is for checking the hysteresis of alarm outputs 1 to 3.



Comment

Setting Range	Unit	Default
0.01 to 99.99	%FS	0.02



See

- Related article
3.4 Setting Alarm Type (page 3-9)
- Related parameters
“Alarm 1 type” “Alarm 2 type” “Alarm 3 type” “Alarm 1 open in alarm” “Alarm 2 open in alarm” “Alarm 3 open in alarm” (setup mode)
“Alarm value 1” “Alarm value 2” “Alarm value 3” (level 1 mode)

- LSH** Input shift upper limit
- LSL** Input shift lower limit

Conditions of Use

The input type must be set to temperature input (thermocouple or platinum resistance thermometer).



Function

- Sets each of the shift amounts for the input shift upper and lower limit values.



Comment







Setting Range	Unit	Default
-199.9 to 999.9	°C or °F	0.0



See

- Related article
3.2 Setting Input Specifications (page 3-4)
- Related parameter
“Input type” (setup mode)

Setup Mode

- The parameters in this mode can be used only when the “security” parameter (protect mode) is set to “0” and “1”.
- This mode contains the parameters for setting the basic specifications of the E5EK controller. These parameters include parameters for specifying the input type, scaling, output assignments, and direct/reverse operation.
- To select this mode when in the levels 0 to 2, expansion, option and calibration modes, press the  key for 1 second minimum. The display changes to the menu display. If you select [5E] using the   key then press the  key for 1 second minimum, the controller enters the setup mode.
- To select parameters in this mode, press the  key. To change parameter settings, use the  or  keys.
- The following table shows the parameters supported in this mode and the page where the parameter is described.

Symbol	Parameter Name	Page
IN-t	Input type	5-26
IN-H	Scaling upper limit	5-27
IN-L	Scaling lower limit	5-27
DP	Decimal point	5-27
d-U	°C/°F selection	5-28
INIt	Parameter initialize	5-27
OUT1	Control output 1 assignment	5-28
OUT2	Control output 2 assignment	5-28
SUB1	Auxiliary output 1 assignment	5-29
SUB2	Auxiliary output 2 assignment	5-29
ALt1	Alarm 1 type	5-30
ALIn	Alarm 1 open in alarm	5-31
ALt2	Alarm 2 type	5-30
AL2n	Alarm 2 open in alarm	5-31
ALt3	Alarm 3 type	5-30
AL3n	Alarm 3 open in alarm	5-31
orEv	Direct/Reverse operation	5-31

Setup Mode

Input type



Function

- Sets the sensor type by the code.



Comment

- Set the code according to the following table. Default is “2: K1 thermocouple”.

Set value	Input Type		
0	JPt	-199.9 to 650.0 (°C) / -199.9 to 999.9 (°F)	Platinum resistance thermometer
1	Pt	-199.9 to 650.0 (°C) / -199.9 to 999.9 (°F)	
2	K1	-200 to 1300 (°C) / -300 to 2300 (°F)	Thermocouple
3	K2	0.0 to 500.0 (°C) / 0.0 to 900.0 (°F)	
4	J1	-100 to 850 (°C) / -100 to 1500 (°F)	
5	J2	0.0 to 400.0 (°C) / 0.0 to 750.0 (°F)	
6	T	-199.9 to 400.0 (°C) / -199.9 to 700.0 (°F)	
7	E	0 to 600 (°C) / 0 to 1100 (°F)	
8	L1	-100 to 850 (°C) / -100 to 1500 (°F)	
9	L2	0.0 to 400.0 (°C) / 0.0 to 750.0 (°F)	
10	U	-199.9 to 400.0 (°C) / -199.9 to 700.0 (°F)	
11	N	-200 to 1300 (°C) / -300 to 2300 (°F)	
12	R	0 to 1700 (°C) / 0 to 3000 (°F)	Current input
13	S	0 to 1700 (°C) / 0 to 3000 (°F)	
14	B	100 to 1800 (°C) / 300 to 3200 (°F)	
15	W	0 to 2300 (°C) / 0 to 4100 (°F)	
16	PLII	0 to 1300 (°C) / 0 to 2300 (°F)	
17	4 to 20mA		Voltage input
18	0 to 20mA		
19	1 to 5V		
20	0 to 5V		Voltage input
21	0 to 10V		



See

- Related article
3.2 Setting Input Specifications (page 3-4)

- Related parameters

When input type is set to temperature input:

“°C/°F selection” (setup mode)

When input type is set to voltage input or current input:

“Scaling upper limit” “Scaling lower limit” “Decimal point” (setup mode)

Ln-H

Scaling upper limit

Conditions of Use

The input type must be set to analog input (voltage or current input).

Ln-L

Scaling lower limit

dp

Decimal point



Function

- This parameter can be used only when voltage input or current input is selected as the input type.
- When voltage input or current input is selected as the input type, scaling is carried out. Set the scaling upper limit in the “scaling upper limit” parameter and the scaling lower limit in the “scaling lower limit” parameter.
- The “decimal point” parameter specifies the decimal point position of parameters (set point, etc.) whose unit is set to EU (Engineering Unit).



Comment

- Scaling upper limit, Scaling lower limit

Parameter	Setting Range	Unit	Default
Scaling upper limit	Scaling lower limit +1 to 9999	EU	100
Scaling lower limit	-1999 to scaling upper limit -1	EU	0

- Decimal point : default : 0

Set Value	Setting	Example
0	0 digits past decimal point	1234
1	1 digit past decimal point	123.4
2	2 digits past decimal point	12.34
3	3 digits past decimal point	1.234



See

- Related article
3.2 Setting Input Specifications (page 3-4)
- Related parameter
“Input type” (setup mode)

Init

Parameter initialize



Function

- Returns parameter settings to their defaults. However, note that the following parameters are not affected by execution of this parameter: “input type”, “scaling upper limit”, “scaling lower limit”, “decimal point” and “°C/°F selection”.



Example of use

- When this parameter is selected, [nō] (“no”) is first displayed. To initialize parameters, press the  key to specify [yēy] (“yes”).

Setup Mode

d-U

°C/°F selection

Conditions of Use

The input type must be set to temperature input (thermocouple or platinum resistance thermometer).



Function

- This parameter can be used when thermocouple or platinum resistance thermometer is selected as the input type.
- Set the temperature input unit to either of “°C” or “°F”.



Comment

Setting Range	Default
[] : °C / [] : °F	[]



See

- Related article
3.2 Setting Input Specifications (page 3-4)
- Related parameter
“Input type” (setup mode)

OUT 1

Control output 1 assignment

Conditions of Use

The control must be standard control or heating and cooling control.

OUT 2

Control output 2 assignment



Function

- Assigns the output functions to either of control output 1 or 2.
- The following seven output functions can be assigned as outputs:
Control output (heat), Control output (cool), Alarms 1 to 3, HBA, and LBA.
- Errors 1, 2 and 3 cannot be assigned as outputs.
- When the output function assigned to control output 1 is ON, the “OUT1” LED lights. However, note that the OUT1 LED does not light when control output (heat) or control output (cool) are assigned to linear outputs such as current and voltage.
- When the output function assigned to control output 2 is ON, the “OUT2” LED lights.



Comment

Symbol	HEAT	COOL	AL - 1	AL - 2	AL - 3	HBA	LBA
Function	Control output (heat)	Control output (cool)	Alarm 1	Alarm 2	Alarm 3	HBA	LBA

Defaults:

“Control output 1” = [HEAT], “Control output 2” = [AL - 1]



See

- Related article
3.3 Setting Output Specifications (page 3-6)
- Related parameters
 - Alarm-related parameters
 - Heating and cooling related parameter
“LBA detection time” (level 2 mode)



Model

E5EK-AA2 AC100-240
E5EK-AA2 AC/DC24

SUB1 Auxiliary output 1 assignment

SUB2 Auxiliary output 2 assignment



Function

- Assigns output functions to either of auxiliary output 1 or 2.
- The following eight output functions can be assigned as outputs:
Alarms 1 to 3, HBA, LBA, Error 1 (input error), Error 2 (A/D converter error), and Error 3 (remote SP input error).
- Control output (heat) and control output (cool) cannot be assigned as outputs.
- Error 3 can be assigned only when the remote SP function is enabled.
- When the output function assigned to auxiliary output 1 or auxiliary output 2 is ON, the “SUB1” or “SUB2” LED lights.



Comment

Symbol	AL-1	AL-2	AL-3	HbA	LbA	S.Err	E333	rSEr
Function	Alarm 1	Alarm 2	Alarm 3	HBA	LBA	Error 1	Error 2	Error 3

Defaults: “Auxiliary output 1” = [AL-2], “Auxiliary output 2” = [AL-3]



See

- Related article
3.3 Setting Output Specifications (page 3-6)
- Related parameter
 - Alarm-related parameter
“LBA detection time” (level 2 mode)

Setup Mode

AL1 Alarm 1 type

AL2 Alarm 2 type

AL3 Alarm 3 type

Conditions of Use

Alarms must be assigned as outputs. For example, if alarm outputs 1 and 2 only are assigned as outputs, the “alarm 3 type” parameter cannot be used.



Function

- “Alarm 1 to 3 type” parameters specify the operation of the alarm by the one of the set values in the following table. For details of operation at an alarm, see page 3-9.



Comment

Set Value	Settings	Set Value	Settings
1	Upper-and lower-limit alarm (deviation)	7	Lower-limit alarm with standby sequence (deviation)
2	Upper-limit alarm (deviation)	8	Absolute-value upper-limit alarm
3	Lower-limit alarm (deviation)	9	Absolute-value lower-limit alarm
4	Upper-and lower-limit range alarm (deviation)	10	Absolute-value upper-limit alarm with standby sequence
5	Upper-and lower-limit alarm with standby sequence (deviation)	11	Absolute-value lower-limit alarm with standby sequence
6	Upper-limit alarm with standby sequence (deviation)		

Defaults: 2 (Deviation upper limit)



See

- Related article
3.4 Setting Alarm Type (page 3-9)
- Related parameters
 “Alarm value 1” “Alarm value 2” “Alarm value 3” (level 1 mode)
 “Alarm 1 hysteresis” “Alarm 2 hysteresis” “Alarm 3 hysteresis” (level 2 mode)
 “Alarm 1 open in alarm” “Alarm 2 open in alarm” “Alarm 3 open in alarm” “Control output 1 assignment” “Control output 2 assignment” “Auxiliary output 1 assignment” “Auxiliary output 2 assignment” (setup mode)

- AL1n** Alarm 1 open in alarm
- AL2n** Alarm 2 open in alarm
- AL3n** Alarm 3 open in alarm

Conditions of Use

Alarms must be assigned as outputs. For example, if alarm outputs 1 and 2 only are assigned as outputs, the “alarm 3 open in alarm” parameter cannot be used.



Function

- Selects the output states of alarms 1 to 3.
- When the controller is set to “close in alarm,” the status of the alarm output function is output as it is. When set to “open in alarm,” the status of the alarm output function is output inverted. The following table shows the relationship between alarm output functions, output and output LEDs.

	Alarm	Output	Output LED
Close in alarm	ON	ON	Lit
	OFF	OFF	Not lit
Open in alarm	ON	OFF	Lit
	OFF	ON	Not lit



Comment

Setting Range	Default
[n - ā] : Close in alarm/ [n - ĩ]:Open in alarm	[n - ā]



See

- Related article
3.4 Setting Alarm Type (page 3-9)
- Related parameters
“Alarm value 1” “Alarm value 2” “Alarm value 3” (level 1 mode)
“Alarm 1 hysteresis” “Alarm 2 hysteresis” “Alarm 3 hysteresis” (level 2 mode)
“Alarm 1 open in alarm” “Alarm 2 open in alarm” “Alarm 3 open in alarm”
“Control output 1 assignment” “Control output 2 assignment” “Auxiliary output 1 assignment” “Auxiliary output 2 assignment”(setup mode)

ōrEu Direct/Reverse operation



Function

- “Direct operation” (or normal operation) refers to control where the manipulated variable is increased according to the increase in the process value. Alternatively, “reverse operation” refers to control where the manipulated variable is increased according to the decrease in the process value.



Comment









Setting Range	Default
[ōr - r] : Reverse operation/ [ōr - d]:Direct operation	[ōr - r]







See

- Related article
3.3 Setting Output Specifications/Direct/reverse operation (page 3-7)

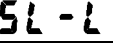
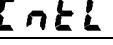
Expansion Mode

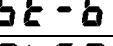
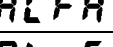
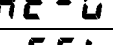
- The parameters in this mode can be used only when the “security” parameter (protect mode) is set to “0” and “1”.
- This mode contains the parameters for setting expanded functions. These parameters include parameters for setting ST (self-tuning), setting the SP setting limiter, selecting advanced PID and ON/OFF control, specifying the standby sequence reset method, and automatic return of display mode.
- To select this mode when in the levels 0 to 2, setup, option and calibration modes, press the  key for 1 second minimum. The display changes to the menu display. If you select [] using the   key then press the  key for 1 second minimum, the controller enters the expansion mode.
- To select parameters in this mode, press the  key. To change parameter settings, use the  or  keys.
- The following table shows the parameters supported in this mode and the page where the parameter is described.

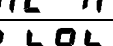
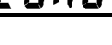
Symbol	Parameter Name	Page
	Set point upper limit	5-33
	Set point lower limit	5-33
	PID / ON/OFF	5-33
	ST	5-34
	ST stable range	5-34
	α	5-34
	AT calculated gain	5-35
	Standby sequence reset method	5-35
	Automatic return of display mode	5-36
	AT hysteresis	5-36
	LBA detection width	5-36

Expansion Mode

SL-H Set point upper limit

SL-L Set point lower limit



Function

- Limits the upper and lower limits of the set point. When the set point exceeds the settings of the “Set point upper limit” and “Set point lower limit” parameters, the E5EK controller regards the settings of the “Set point upper limit” and “Set point lower limit” parameters as the set points.
- When the input type is changed to temperature input, the set point upper and lower limits are changed to the upper and lower limits of the currently selected sensor. And when the input type is changed to analog input, the set point upper and lower limits are changed to the scaling upper and lower limits.
- During temperature input, the decimal point position is dependent on the currently selected sensor, and during analog input on the results of scaling.



Comment

Parameter	Setting Range	Unit	Default
SP setting upper limit	SP setting lower limit +1 to scaling upper limit	EU	1300
SP setting lower limit	Scaling lower limit to SP setting upper limit -1	EU	-200

During temperature input, the range becomes the range of use of the selected sensor instead of the scaling upper and lower limit values.



See

- Related article
4.2 Operating Condition Restrictions (page 4-5)
- Related parameters
“Input type” “Scaling upper limit” “Scaling lower limit” “Decimal point” (setup mode)

EntL PID / ON/OFF

Condition of Use

Control must be standard control or heating and cooling control.



Function

- Selects advanced PID control or ON/OFF control.



Comment

Setting Range	Default
[P L d] : advance PID/ [o n o f] : ON/OFF	[P L d]



See

- Related article
4.1 Selecting the Control Method/ON/OFF control (page 4-4)
- Related parameters
“Hysteresis (heat)” “Hysteresis (cool)” (level 1 mode)



Model

E5EK-AA2 AC100-240
E5EK-AA2 AC/DC24

Expansion Mode

St ST

Conditions of Use

The input type must be set to temperature input, and the control must be standard control and advanced PID control.

St-b ST stable range



Function

- When the “ST” parameter is set to “ON”, the self-tuning (ST) function is active. During operation of the ST function, the power on the load side connected to the control output must be turned ON at the same time or before start of E5EK operation.
- The “ST stable range” parameter sets the stable range width during self-tuning. However, note that this parameter cannot be used when the “ST” parameter is set to “OFF”.



Comment

Parameter	Setting Range	Unit	Default
ST	[0FF]: ST function OFF/[0n]: ST function ON	None	[0FF]
ST stable range	0.1 to 999.9	°C or °F	15.0



See

- Related article
Fuzzy self-tuning (page A-14)
- Related parameters
“Input type” (setup mode)
“PID / ON/OFF” (expansion mode)

ALFA α

Conditions of Use

The control must be advanced PID control, and ST must be set to OFF.



Function

- Usually use the default value.
- Sets advanced PID-control parameter α .



Comment

Setting Range	Unit	Default
0.00 to 1.00	None	0.65



See

- Related parameter
“PID / ON/OFF” (expansion mode)

Expansion Mode

AT-G

AT calculated gain

Conditions of Use

The control must be advanced PID control, and ST must be set to OFF.



Function

- Usually use the default value.
- Sets the gain when adjusting the PID parameters by auto-tuning.
- To give priority to response, decrease the set value of this parameter. To give priority to stability, increase the set value of this parameter.



Comment

Setting Range	Unit	Default
0.1 to 10.0	None	1.0



See

- Related parameters
 - “AT Execute/Cancel” (level 1 mode)
 - “PID / ON/OFF” (expansion mode)

r-EST

Standby sequence reset method



Function

- Selects the conditions for enabling reset after the standby sequence of the alarm has been canceled.
- Condition A:
Control started (including power ON), and, alarm value, input shift value or set point (except for changing SP mode or during Remote SP) changed.
- Condition B:
Power ON



Comment

Setting Range	Default
0: Condition A / 1: Condition B	0



See

- Related parameters
 - “Alarm 1 type” “Alarm 2 type” “Alarm 3 type” (setup mode)

Expansion Mode

rEt

Automatic return of display mode



Function

- If you do not operate any of the controller keys for the time set in this parameter when in levels 0 to 2 modes, the display automatically returns to the PV/SP display.
- When this parameter is set to “0”, this function is disabled.
- This parameter is invalid while the menu is displayed.



Comment

Setting Range	Unit	Default
0 to 99	Second	0

At-H

AT hysteresis

Conditions of Use

The control must be advanced PID control, and ST must be set to OFF.



Function

- Usually Use the default value.
- The levels of limit cycle operations during AT execution are given hysteresis at event ON/OFF switching. This parameter sets this hysteresis width.



Comment

Setting Range	Unit	Default
0.1 to 9.9	%FS	0.2

LbAb

LBA detection width

Conditions of Use

The LBA (Loop Break Alarm) function must be assigned as an output.



Function









- This parameter can be used when LBA is assigned as an output.
- When the change width of the manipulated variable is below the width set in this parameter, the controller regards this as detection of an LBA.









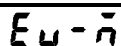
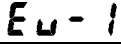
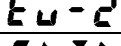
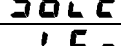
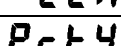
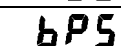

Comment

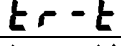
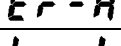
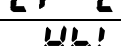
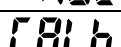
Setting Range	Unit	Default
0.0 to 999.9	%FS	0.2

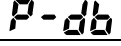
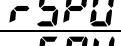
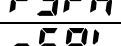
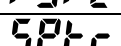
Option Mode

- The parameters in this mode can be used only when the “security” parameter (protect mode) is set to “0” and “1”.
- You can select this mode only when the option unit is set in the controller. In this mode, you can set the communications conditions, transfer output and event input parameters to match the type of option unit set in the controller.
- To select this mode when in the levels 0 to 2, setup, expansion and calibration modes, press the  key for 1 second minimum. The display changes to the menu display. If you select [] using the   key then press the  key for 1 second minimum, the controller enters the option mode.
- To select parameters in this mode, press the  key. To change parameter settings, use the  or  keys.
- The following table shows the parameters supported in this mode and the page where the parameter is described.

Symbol	Parameter Name	Page
	Multi-SP function	5-38
 -1	Event input assignment 1	5-39
 -2	Event input assignment 2	5-39
 St	Communication stop bit	5-40
 LEn	Communication data length	5-40
 Prty	Communication parity	5-40
 bPS	Communication baud rate	5-40
 U-nō	Communication unit No.	5-40
 tr-t	Transfer output type	5-41
 tr-H	Transfer output upper limit	5-41
 tr-L	Transfer output lower limit	5-41
 HbL	HBA latch	5-42
 CALb	Motor calibration	5-42
 nōt	Travel time	5-43
 P-db	PV dead band	5-43
 r-SPU	Remote SP enable	5-44
 r-SPH	Remote SP upper limit	5-44
 r-SPL	Remote SP lower limit	5-44
 SPtr	SP tracking	5-45

Option Mode

E_u- \bar{n}

Multi-SP function

Conditions of Use

The event input function must be in use.



Function

- This parameter specifies the number of event inputs when switching set points (SP) 0 to 3.
- When set to “0”, the set point cannot be switched by event input.
- When this parameter is set to “1”, set points 0 and 1 can be used. When set to “2”, set points 0 to 3 can be used.



Comment

Setting Range	Unit	Default
0 to 2	None	2



See

- Related article
4.3 How to Use Event Input (4-8)
- Related parameter
“Event input assignment 1” (option mode)



Model

- Option unit
E53-AKB

E_u-1 Event input assignment 1

Conditions of Use

Event input other than the multi-SP function must be specified when the event input function is in use.

E_u-2 Event input assignment 2



Function

- When one E53-AKB unit is mounted, only “Event input assignment 3” and “Event input assignment 4” can be used.
- This parameter specifies event input other than the multi-SP function. The following three functions can be specified:
Run/Stop, Auto/Manual, SP mode.
The Remote/Local function can be used on E53-AK01/02/03 option units. The SP mode functions can be used only when the “Remote SP enable” parameter is ON.
- Event input (RUN/STOP, Manual/Auto, and SP mode) is disabled while the menu is displayed.
It is also disabled in set up, expansion, option and calibration modes.



Comment

Symbol	Function	Event Input Operation
None	Not specified	Event input disabled
5tōP	Run/Stop	ON: Stop/OFF: Run
ñPñ	Manual/Auto	ON: Manual/OFF: Auto
rSP	SP mode	ON: Remote SP/OFF: Local SP

- Default : None



See





- Related article
4.3 How to Use Event input (page 4-8)
- Related parameters
“remote SP enable” “multi-SP function” (option mode)



Model

- Option unit
E53-AKB

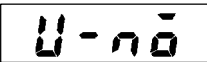
Option Mode

 Communication stop bit	 Communication baud rate
 Communication data length	 Communication unit No.
 Communication parity	Conditions of Use The communications function must be in use.

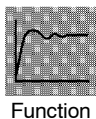

- These parameters set the communications conditions. Make sure that the stop bit, data length, parity and baud rate of the host computer and the E5EK controller are matching. These parameters are valid when the power is turned ON again or when level 0 to 2 modes are switched.
- When connecting two or more E5EK controllers to the host computer, set unit Nos. that will not conflict with the unit Nos. of other controllers.



- “Communication stop bit” parameter

Setting Range	Unit	Default
1, 2	Bits	2

- “Communication data length” parameter

Setting Range	Unit	Default
7, 8	Bits	7

- “Communication parity” parameter

Setting	Default
[nōnE]: None/[EUEr]:Even/[ōdd]:Odd	[EUEr]

- “Communication baud rate” parameter

Setting Range	Unit	Default
1.2, 2.4, 4.8, 9.6, 19.2	kbps	9.6

- “Communication unit No.” parameter

Setting Range	Unit	Default
0 to 99	None	0

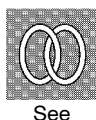

- Related article
Chapter6 USING THE COMMUNICATIONS FUNCTION
- Related parameter
“Remote/Local” (level 2 mode)

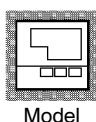

- Option unit
E53-AK01/02/03

Er-t

Transfer output type

Er-H

Transfer output upper limit

Er-L

Transfer output lower limit

Conditions of Use

The transfer output function must be in use.



Function

- These parameters set the transfer output conditions.
- The “transfer output type” parameter selects one of the following as the transfer output type, and assigns this to transfer output:
Set point, Set point during SP ramp, Process value, Manipulated variable (heat) (standard type), Manipulated variable (cool) (This can selected only during heating and cooling control on a standard type controller.), Valve opening (position-proportional control)
- The “transfer output upper limit” and “transfer output lower limit” parameters are used for scaling of transfer output. The setting range varies according to this output data. Also, a lower limit value larger than the upper limit value may be set.
- During temperature input, the decimal point position of the set point, set point during SP ramp or process value is dependent on the currently selected sensor, and during analog input on the results of scaling.



Comment

Transfer Output Type	Transfer Output Lower Limit to Transfer Output Upper Limit
[SP] Set point	Set point lower limit value to Set point upper limit value
[SP-n] Set point during SP ramp	Set point lower limit value to Set point upper limit value
[Pv] Process value	Scaling lower limit to scaling upper limit
[o] Manipulated variable (heat)	-5.0% to 105.0% (Standard control), 0.0 to 105.0% (heating and cooling control)
[[-o] Manipulated variable (cool)	0.0% to 105.0%
[v-n] Valve opening	-10.0 to 110.0%

- Default : [SP]
- The output ranges of the set point, set point during SP ramp or process value when temperature input is selected are the ranges supported by the selected sensor.
- When you have selected the “manipulated variable (heat)” parameter, the transfer output lower limit during heating and cooling control becomes “0.0”.



See

- Related article
4.7 How to Use Transfer Output (page 4-17)



Model

- Option unit
E53-AKF

Option Mode

HbL

HBA latch

Conditions of Use

The HBA output function must be assigned.



Function

- When this parameter is set to ON, the heater burnout alarm is held until either of the following conditions is satisfied:
 - a Set the heater burnout set value to “0.0”.
 - b Reset the controller. (Turn the controller’s power OFF then back ON again.)



Comment

Setting Range	Default
[$\bar{0}n$]: Enabled/[$\bar{0}FF$]: Disabled	[$\bar{0}FF$]



See

- Related article
 - 4.5 How to Use the Heater Burnout Alarm (page 4-13)
- Related parameters
 - “Control output assignment 1” “Control output assignment 2” “Auxiliary output assignments 1” “Auxiliary output assignments 2” (setup mode)



Model

E5EK-AA2 AC100-240
E5EK-AA2 AC/DC24

CALb

Motor Calibration

Conditions of Use

The control must be position-proportion control.



Function

- Executes motor calibration. Be sure to execute this parameter when monitoring the valve opening. (Displays cannot be switched while motor calibration is being executed.)
- The “travel time” parameter is also reset when this parameter is executed.



Example of use

- The default setting is “ $\bar{0}FF$ ”.
- Motor calibration is executed when “ $\bar{0}n$ ” is selected.
- After motor calibration is completed, the setting automatically returns to “ $\bar{0}FF$ ”.



See

- Related article
 - 4.1 Selecting the Control Method/Position-proportional Control (page 4-3)
- Related parameter
 - “Travel time” (option mode)



Model

E5EK-PRR2 AC100-240
E5EK-PRR2 AC/DC24

not

Travel Time

Conditions of Use

The control must be position-proportion control.



Function

- Sets the time from valve fully opened to valve fully closed.
- The travel time is automatically set when the “motor calibration” parameter is executed.



Comment

Setting Range	Unit	Default
1 to 999	Second	30



See

- Related article
4.1 Selecting the Control Method/Position-proportional Control (page 4-3)
- Related parameter
“Motor Calibration” (option mode)



Model

E5EK-PRR2 AC100-240
E5EK-PRR2 AC/DC24

P-db

PV dead band

Conditions of Use

The control must be position-proportion control.



Function

- Sets a band within which valve will not move.

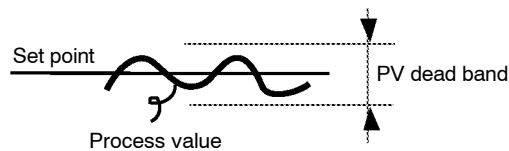

- This function is for use to reduce valve movement, but consequently reduces control performance within the PV deadband.
- The decimal point is dependent on scaling.



Comment

Setting Range	Unit	Default
0 to 9999	EU	0



See

- Related parameters
“Input type” “Scaling upper limit” “Scaling lower limit” “Decimal point” (setup mode)



Model

E5EK-PRR2 AC100-240
E5EK-PRR2 AC/DC24

Option Mode

r-SPU

Remote SP enable

Conditions of Use
ST must be OFF.



Function

- When this parameter is set to “ON”, the remote SP and local SP can be switched for use. (That is, to the SP mode can be specified.). Also, the “set point during SP ramp” parameter is enabled at all times.
- When this parameter is set to “OFF”, only the local SP can be used. The set point during SP ramp is enabled only when the SP ramp function is enabled.



Comment

Setting Range	Default
[00]: Enabled/[0FF]: Disabled	[0FF]



See

- Related article
4.4 How to Use the Remote SP (page 4-11)
- Related parameters
“Set point during SP ramp” (level 0 mode)
“SP mode” (level 2 mode)

r-SPH

Remote SP upper limit

Conditions of Use
The remote SP function must be enabled.

r-SPL

Remote SP lower limit



Function

- Sets the remote SP upper and lower limit values. The upper limit value is the equivalent to 20 mA, and the lower limit value is equivalent to 4 mA. Set the upper limit value in the “remote SP upper limit” parameter and the lower limit value in the “remote SP lower limit” parameter.

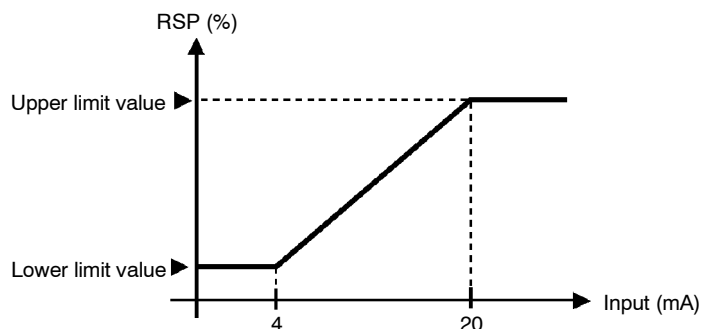

- When the “SP setting upper limit” or “SP setting lower limit” parameters are changed, the remote SP upper and lower limit values are forcibly changed to the SP setting upper and lower limit values.



Comment

Parameter	Setting Range	Unit	Default
Remote SP upper limit	SP setting lower limit to SP setting upper limit	EU	1300
Remote SP lower limit	SP setting lower limit to SP setting upper limit	EU	-200



See

- Related article
 - 4.4 How to Use the Remote SP (page 4-11)
- Related parameters
 - “Decimal point” (setup mode)
 - “SP setting upper limit” “SP setting lower limit” (expansion mode)
 - “Remote SP enable” (option mode)

SPLr

SP tracking enable

Conditions of Use

The remote SP function must be enabled.



Function

- Specifies the operation when the remote SP mode is switched to the local SP mode.
- When this parameter is set to “ON”, the local SP is changed to the remote SP value used immediately before switching.
- When this parameter is set to “OFF”, the local SP is not influenced by the remote SP.



Comment







Setting Range	Default
[00]: Enabled/[0FF]: Disabled	[0FF]



See

- Related article
 - 4.4 How to Use the Remote SP (page 4-11)
- Related parameters
 - “Set point during SP ramp” (level 0 mode)
 - “SP mode” (level 2 mode)

Calibration Mode

- The parameters in this mode can be used only when the “security” parameter (protect mode) is set to “0”. When selecting this mode for the first time after the E5EK has left the factory, return the “security” parameter to “0”.
- This mode contains the parameters for user calibration of inputs and outputs. Only parameters relating to input types specified in the “input type” parameter (setup mode) can be used. Also, related output parameters can be used only when the communications unit (E53-AKF) is added on.
- To select this mode when in the levels 0 to 2, setup, expansion and option modes, press the  key for 1 second minimum. The display changes to the menu display. If you select [ ] using the   key then press the  key for 1 second minimum, the controller enters the calibration mode.
- For details on parameters in the calibration mode, see Chapter 7 Calibration.

K CHAPTER 6

USING THE COMMUNICATIONS FUNCTION

This chapter mainly describes communications with a host computer and communications commands.

6.1	Outline of the Communications Function	6-2
	Outline	6-2
	Transfer procedure	6-2
	Interface	6-2
6.2	Preparing for Communications	6-3
	Cable connections	6-3
	Setting the communications specifications	6-4
6.3	Command Configuration	6-5
6.4	Commands and Responses	6-6
	Reading/writing parameters	6-6
	Issuing special commands	6-10
6.5	How to Read Communications	
	Error Information	6-12
	End code	6-12
	Undefined error	6-13
6.6	Program Example	6-14
	How to use programs	6-14
	Program list (language: IBM PC COMPATIBLE MACHINE)	6-15
	Examples of use	6-16

6.1 Outline of the Communications Function

■ Outline

The communications function allows you to monitor and set E5EK parameters by a program prepared and running on a host computer connected to the E5EK controller. This chapter describes operations as viewed from the host computer.

When using the communications function, the option unit for RS-232C, RS-422 or RS-485 communications must be added on. The E5EK communications function allows you to carry out the following:

- Reading/writing of parameters;
- Operation instructions; and
- Selecting the setting level.

The communications function assumes the following conditions:

- Writing of parameters is possible in during remote operation. Also, parameters cannot be written during execution of auto-tuning;
- Writing parameters are provided with a setting level. Writing conditions are as follows depending on the setting level:

Setting level 1: No restrictions

Setting level 0: Writing of parameters in the setup, expansion and option modes only is prohibited.

- For details on switching between setting levels, see page 6-11.
- The “run/stop”, “remote/local” and “AT execute/cancel” parameters are set aside from other parameters as special commands for instructing operations.

■ Transfer procedure

The host computer sends a “command frame” to the controller, and the controller returns a “response frame” corresponding to the content of the command sent by the host computer. In other words, a response frame is returned for each command frame sent.

The following diagram shows command frame/response frame operations.

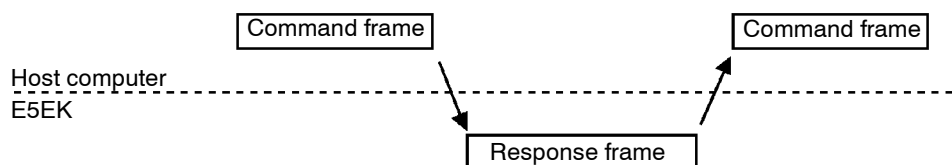

■ Interface

The host computer carries out communications conforming to the RS-232C, RS-422 or RS-485 interface specifications.

Option units supporting the RS-232C, RS-422 and RS-485 specifications are as follows:

- Option units
 - E53-AK01 (RS-232C)
 - E53-AK02 (RS-422)
 - E53-AK03 (RS-485)

● **RS-485**

- Up to 32 controllers including a computer can be connected to the host computer.
- The total cable length should not exceed 500 meters.
- Use shielded twisted-pair cables (AWG28 or more) for the cables.
- Attach terminators to the controllers at both ends of a series of controllers connected in an open configuration. For example, in the following configuration, connect the terminator to the host unit and the unit No.30, and do not connect terminators to unit Nos.0 to 29.
- Use terminators having a resistance of 120Ω (1/2 W). The total resistance of both ends should be at least 54Ω .

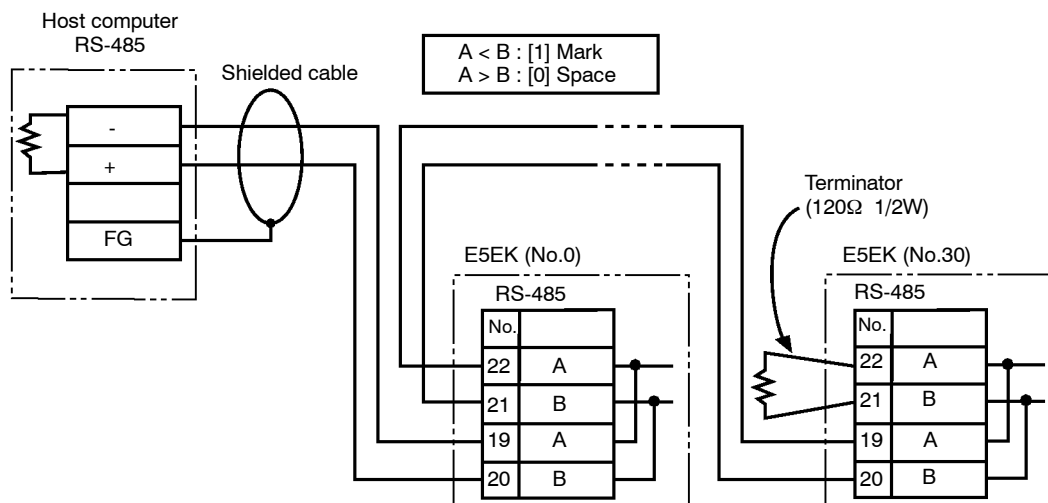

■ **Setting the communications specifications**

Match the communications specifications of the host computer and E5EK controller. When two or more controllers are connected to the host computer, make sure that the communications specifications of all controllers are the same.

This section describes how to set the communications specifications of the E5EK controller. For details on the host computer, see the relevant manual supplied with the host computer.

● **Communications parameters**

Set the communications specifications of the E5EK in the controller’s communications parameters. The communications parameters are set on the front panel of the E5EK controller.

The following table shows the communications parameters (option mode) provided on the E5EK controller and their respective settings.

Parameter/Symbol	Setting	Set Value
Unit No.	<i>U-no</i>	0 to 99
Baud rate	<i>bPS</i>	1.2/2.4/4.8/9.6/19.2 (kbps)
Bit length	<i>LEN</i>	7/8 (bit)
Parity	<i>Prty</i>	None/even/odd
Stop bit	<i>Stbt</i>	1/2

Inverted items are factory-settings.

6.3 Command Configuration

Command configuration is as follows and are paired with a response.

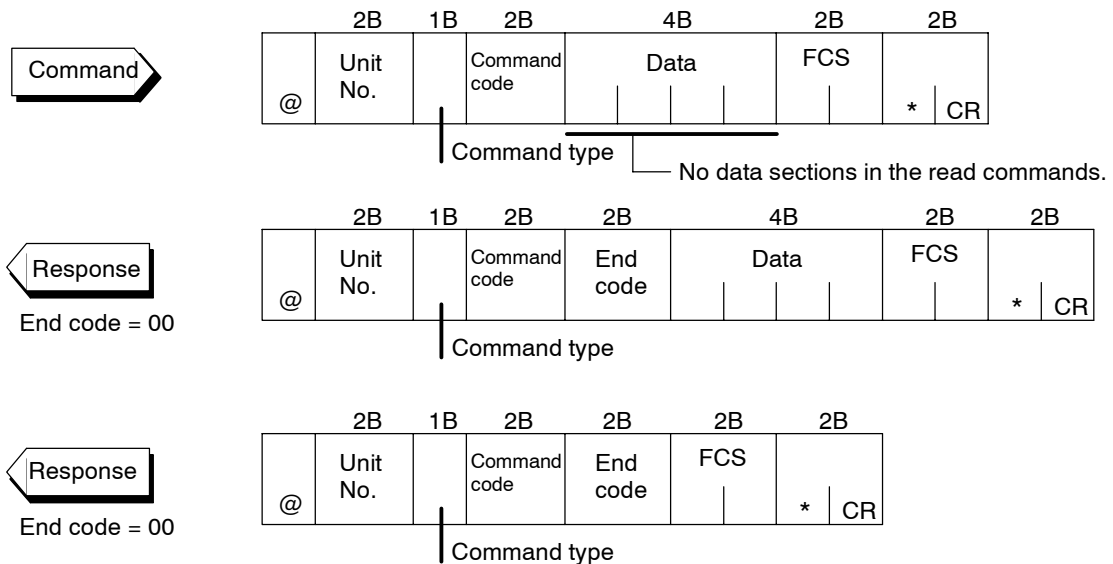

- “@”
The start character. This character must be inserted before the leading byte.
- Unit No.
Specifies the “unit No.” of the E5EK. If there are two or more transmission destinations, specify the desired destination using “unit No.”
- Command type
Specifies the command type by codes “1” to “3”: parameter read, parameter write and special commands.
- Command code
Specifies the command for each command type. With parameter read/write commands, this becomes the parameter No.
- Data
Specifies the set value or setting content. In the parameter read command, set dummy data “0000”. In the response, this is inserted only when the end code is “00”.
- End code
Sets the communication results. For details on the types and meanings of end codes, see 6.5 How to Read Communications Error Information (page 6-12).
- FCS (Frame Check Sequence)
Set the frame check results from the start character to the data section. For details on the frame check, see 6.6 Program Example (page 6-14).
- “*” “CR (Carriage Return) code”
Indicates the end (terminator) of the command or response block.

6.4 Commands and Responses

This section describes commands and response in detail. The conventions used in this section and data restrictions are as follows:

- Data is expressed in 1-byte units and in ASCII code.
- When the read or write data is a numerical value, the data to be set must conform to the following conditions:
 - (1) The decimal point “.” is not indicated in fractions.
 - (2) The leftmost bit of minus numerical data must be expressed as follows:

[example]

10.0=[0100], -150.0=[A500], -15=[F015]

■ Reading/writing parameters

● Reading parameters

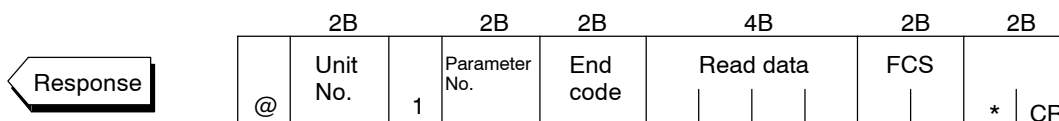
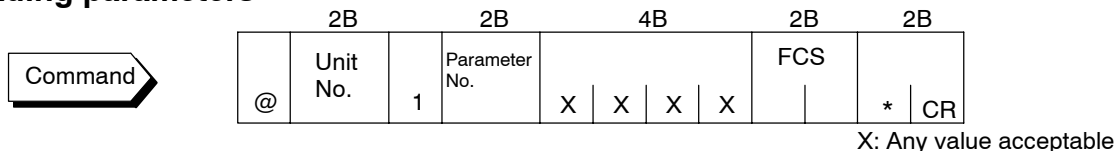

● Writing parameters

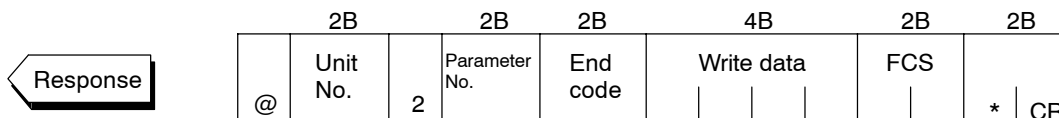
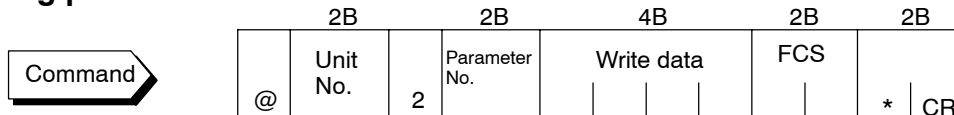

Reading or writing of the parameters of a specified controller is executed.

- Writing is possible only during remote operation.
- Reading is impossible during executing auto-tuning.
- The following are set aside as special commands. For details, see page 6-10.
 - “run/stop”, “remote/local”, “AT execute/cancel”
- For details on parameters in each setting level, see the tables on pages 6-7 and 6-9.

Parameter No.	Parameter	Data Setting and Monitor Range	Mode
00	PV monitor *1	Scaling lower limit -10% to scaling upper limit +10% *2	Level 0
86	SP monitor during SP ramp *1	SP lower limit to SP upper limit	
04	MV monitor (heat) *1	-5.0 to 105.0 *3	
42	MV monitor (cool) *1	0.0 to 105.0	
24	Remote SP monitor *1	Scaling lower limit to scaling upper limit	
14	Valve opening monitor *1	-10.0 to 110.0	
01	Set point	SP lower limit to set point upper limit	Level 1
10	Set point 0	SP lower limit to SP upper limit	
11	Set point 1	SP lower limit to SP upper limit	
12	Set point 2	SP lower limit to SP upper limit	
13	Set point 3	SP lower limit to SP upper limit	
02	Alarm value 1	-1999 to 9999	
03	Alarm value 2	-1999 to 9999	
41	Alarm value 3	-1999 to 9999	
19	Proportional band	0.1 to 999.9	
20	Integral time	0 to 3999 *4	
21	Derivative time	0 to 3999	
22	Cooling coefficient	0.01 to 99.99	
09	Dead band	-19.99 to 99.99	
87	Position-proportional dead band	0.1 to 10.0	
23	Manual reset value	0.0 to 100.0	
06	Hysteresis (heat)	0.01 to 99.99	
43	Hysteresis (cool)	0.01 to 99.99	
07	Control period (heat)	1 to 99	
08	Control period (cool)	1 to 99	
17	Heater current monitor *1	0.0 to 55.0	
18	Heater burnout alarm	0.0 to 50.0	

*1 Possible only during reading

*2 During temperature input, the range becomes the range of use of the selected sensor.

*3 During heating and cooling control, the range becomes 0.0 to 105.0.

*4 During position-proportional control, the range becomes 1 to 3999.



About invalid parameters

Currently, if a command is used for invalid parameters (parameters that do not satisfy the conditions of use in Chapter 5), the “undefined” error (end code: 1C) is output.

Parameter No.	Parameter	Data Setting Range	Mode	
44	SP ramp time unit	0: Minutes, 1: Hours	Level 2	
45	SP ramp set value	0 to 9999		
46	LBA detection time	0 to 9999		
47	MV at stop	-5.0 to 105.0 *1		
48	MV at PV error	-5.0 to 105.0 *1		
50	MV upper limit	MV lower limit +0.1 to 105.0 *2		
49	MV lower limit	-5.0 to MV upper limit -0.1 *3		
51	MV change rate limit	0.0 to 100.0		
56	Input digital filter	0 to 9999		
88	Open/close hysteresis	0.1 to 20.0		
25	Alarm 1 hysteresis	0.01 to 99.99		
26	Alarm 2 hysteresis	0.01 to 99.99		
52	Alarm 3 hysteresis	0.01 to 99.99		
53	Input shift upper limit	-199.9 to 999.9		
54	Input shift lower limit	-199.9 to 999.9		
57	Input type	0 to 21 *4		Setup
59	Scaling upper limit	Scaling lower limit +1 to 9999		
58	Scaling lower limit	-1999 to scaling upper limit -1		
60	Decimal point	0 to 3		
30	°C/°F selection	0 : °C, 1 : °F		
61	Control output 1 assignment	0 to 6 *5		
62	Control output 2 assignment	0 to 6 *5		
63	Auxiliary output 1 assignment	2 to 9 *5		
64	Auxiliary output 2 assignment	2 to 9 *5		
65	Alarm 1 type	1 to 11 *6		
66	Alarm 1 open in alarm	0: closed in alarm, 1: open in alarm		
67	Alarm 2 type	1 to 11 *6		
68	Alarm 2 open in alarm	0: closed in alarm, 1: open in alarm		
69	Alarm 3 type	1 to 11 *6		
70	Alarm 3 open in alarm	0: closed in alarm, 1: open in alarm		
71	Direct/Reverse operation	0: Reverse operation, 1: Direct operation		

*1 During heating and cooling control, the range becomes -105 to 105.0. During position-proportional control, you can select between

0: Hold/1: Open/2: Close. (Default is 0: Hold.)

*2 During heating and cooling control, the range becomes 0.0 to 105.0.

*3 During heating and cooling control, the range becomes -105.0 to 0.0

*4 See page 5-26.

*5 0: Control output (heat), 1: Control output (cool), 2: to 4: Alarms 1 to 3, 5: HBA, 6: LBA, 7 to 9: Errors 1 to 3

*6 See page 5-30.

Parameter No.	Parameter	Data Setting Range	Mode
28	Set point upper limit ^{*1}	Set point lower limit +1 to scaling upper limit	Expansion
27	Set point lower limit ^{*1}	Scaling lower limit to Set point upper limit -1	
72	PID / ON/OFF	0: Advanced PID, 1: ON/OFF	
73	ST	0 : OFF, 1 : ON	
34	ST stable range width	0.1 to 999.9	
35	α	0.00 to 1.00	
85	AT calculated gain	0.1 to 10.0	
37	Standby sequence reset method	0, 1 ^{*2}	
36	Automatic return of display mode	0 to 99	
93	AT hysteresis	0.1 to 9.9	
55	LBA detection width	0.0 to 999.9	
82	HBA latch	0: OFF, 1: ON	
89	Travel time	1 to 999	
38	PV dead band	0 to 9999	
29	Remote SP enable	0: Enabled, 1: Disabled	
91	Remote SP upper limit	SP setting lower limit to SP setting upper limit	
90	Remote SP lower limit	SP setting lower limit to SP setting upper limit	
39	SP tracking	0: OFF, 1: ON	

*1 During temperature input, the range becomes the range of use of the selected sensor instead of the scaling upper/lower limit values

*2 See page 5-35.

■ Issuing special commands

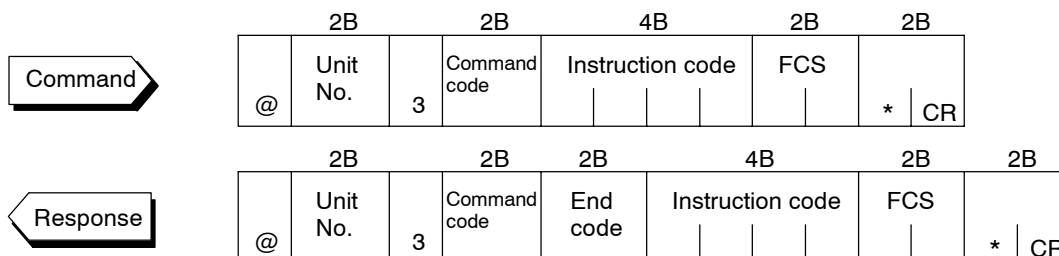

The following functions are issued as special commands.

- **Run/Stop** (number of writings: 100000 operations)
Runs or stops programs. This command cannot be issued in setting level 1.
- **Remote/Local** (number of writings: 100000 operations)
Selects remote operation or local operation.
- **RAM Write mode** (number of writings: 100000 operations)
In the RAM mode, the local SP (set point and set points 0 to 3) are saved to RAM, and in the backup mode, the local SP is saved to EEPROM.
- **RAM data Save**
When this command is issued, set points are saved to EEPROM.
- **AT Execute/Cancel**
Executes or cancels auto-tuning. This command cannot be issued in setting level 1.
- **SP mode** (number of writings: 100000 operations)
Switches between local SP (LSP) and remote SP (RSP). This command cannot be issued in setting level 1.
- **Move to setting level 1**
Issue this command when writing parameters in the setup, expansion and option modes. On the E5EK, the parameter switches to the top parameter “input type” of the setup mode, and control is stopped.
- **Software reset**
Resets E5EK operation by communications. A response is not returned to this command. Also, communications with the E5EK cannot be carried out for five seconds after reset.
- **Status**
Monitors the status of the E5EK. Two command groups are available, A and B, depending on the command code. The response is returned in bit units to the command code (4B) of the response frame. For details on the monitoring details of each group, see page 6–11.

● Command List

Command No.	Command	Command Code
00	Run/Stop	0000: Run, 0001: Stop
02	Remote/Local	0000: Local, 0001: Remote
05	RAM write mode	0000: Backup, 0001: RAM
06	RAM data save	0000:
07	AT Execute/Cancel	0000: Cancel, 0001: 40% AT execution, 0002: 100% AT execution
08	SP mode	0000: LSP, 0001: RSP
09	Move to setting level 1	0000:
11	Software reset	0000:
14	Status	0000: A group, 0001: B group

● A group

Bit	Description	[1]	[0]
0	Heating side output ^{*3}	ON	OFF ^{*1}
1	Cooling side output ^{*4}	ON	OFF ^{*1}
2	Alarm output 1	ON	OFF ^{*2}
3	Alarm output 2	ON	OFF ^{*2}
4	Alarm output 3	ON	OFF ^{*2}
5	LBA output	ON	OFF ^{*2}
6	HBA output	ON	OFF ^{*2}
7	Run/Stop	Stop	Run
8	Auto/Manual	Manual	Auto
9	Remote/Local	Remote	Local
10	SP mode	RSP	LSP
11	Auto-tuning	AT execution	OFF
12			
13			
14			
15			

*1 Always "OFF" at linear output

*2 Always "OFF" when output is not assigned

*3 During position-proportional control, output is Open.

*4 During position-proportional control, output is Close.

● B group

Bit	Description	[1]	[0]
0	Setting level	1	0
1	RAM write mode	RAM	Backup
2	Control output 1 type	Linear	Pulse
3	Control output 2 type	Linear	Pulse
4	EEPROM	RAM ≠ EEPROM	RAM = EEPROM
5	Input error	ON	OFF
6	A/D converter error	ON	OFF
7	CT overflow	ON	OFF
8	CT hold	ON	OFF
9	Potentiometer error	ON	OFF
10	RSP input error	ON	OFF
11			
12			
13			
14			
15			

About Setting Levels

To return to setting level 0 from setting level 1, issue the "software reset" command.

If the parameter write command is issued for the setup and expansion modes in setting level 0, an error occurs, and the end code (0D = Command cannot be executed) is returned.

6.5 How to Read Communications Error Information

The result of communications on the E5EK can be checked by the end code in the response frame. Use this end code to remedy errors that may occur.

■ End code

Communications are normal when the end code in the response is “00”. If the end code is not “00”, this indicates that an error other than an undefined error has occurred. The end code format is as follows and does not contain a data area.

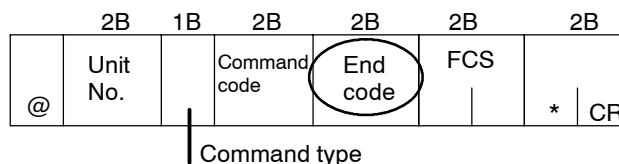

End code	0D	Code name	Command cannot be executed
----------	----	-----------	----------------------------

● Description

- Writing was carried out during local operation.
- Writing was carried out during executing auto-tuning.
- An attempt was made to execute 40%AT during heating and cooling control or position-proportional control.
- An attempt was made to switch run/stop in setting level 1.
- An attempt was made to execute AT in setting level 1.

● Action

- Issue the parameter read or write commands in conditions other than above.

End code	10	Code name	Parity error
----------	----	-----------	--------------

● Description

Parity check error was detected in the received data.

● Action

Check the communications condition. If the communications condition of the host computer and E5EK controller match, then a probable cause is a problem in the communications circuit of one or both of the host computer and E5EK controller.

End code	11	Code name	Framing error
----------	----	-----------	---------------

● Description

Stop bit cannot be detected.

● Action

Check the communications condition. If the communications condition of the host computer and E5EK controller match, then a probable cause is a problem in the communications circuit of one or both of the host computer and E5EK controller.

End code	13	Code name	FCS error
----------	----	-----------	-----------

● Description

The FCS (Frame Check Sequence) do not match.

● Action

Check the FCS program.



About the unit No.

Responses are not returned unless the target unit for communications and the unit No. in the command match.

End code	14	Code name	Format error
----------	----	-----------	--------------

- **Description** The received command length does not match the length defined in the frame format.
- **Action** Check the communications condition. If the communications condition of the host computer and E5EK controller match, then a probable cause is a problem in the communications circuit of one or both of the host computer and E5EK controller.

End code	15	Code name	Setting range error
----------	----	-----------	---------------------

- **Description** Numerical values or code values in the data are not within the setting range.
- **Action** Check the parameter and read or write data of special commands.

■ Undefined error

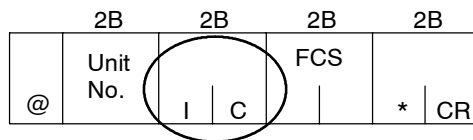

- **Description**
 - An undefined header code has been received.
 - A currently invalid parameter (e.g. the scaling command during temperature input) has been received.
- **Action**
 - Check the parameter No.

6.6 Program Example

■ How to use programs

The program described below is for obtaining corresponding response frame data when some of the command frame data is input.

The input format is as follows. The FCS and terminator are automatically generated, and need not be input.

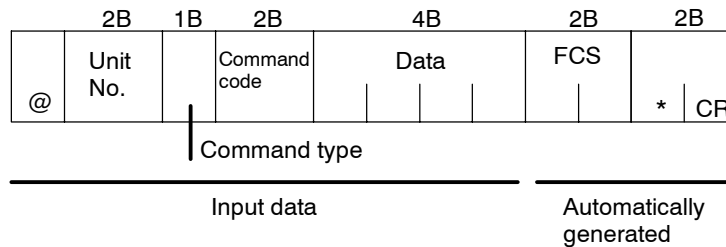

The output format is as follows. The content of the response frame is displayed as it is.

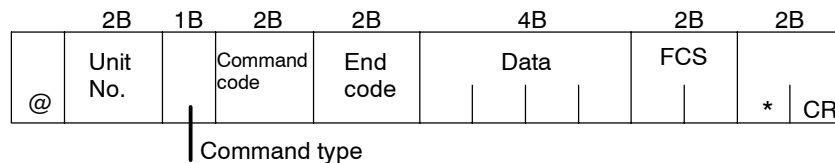

● Procedure

- (1) Read the program.
- (2) Enter "RUN".
- (3) When "send data:" is displayed, enter the command data (from @ to the command string).
- (4) The content of the response frame is displayed following "receive data:".

● Conditions when running a program

- Set the communications condition as follows:
 - Baud rate : 9600 bps
 - Bit length : 7 bits
 - Parity : Even
 - Stop bit : 2
- Make sure that the communications cable is properly connected.

■ Program list (language: IBM PC COMPATIBLE MACHINE)

```

1000 ' -----
1010 ' PROGRAM : E5EK Communication Program
1020 ' ----- For IBM PC COMPATIBLE MACHINE
1050 ' -----
1060 ' ----- RS-232C SPEED: 9600BPS, PARITY: EVEN, DATA: 7, STOP: 2 -----
1070 OPEN "COM: 9600, E, 7, 2, CD0, CS0, DS0, RB256, RS "FOR RANDAM AS #1 LEN=256
1080 REPEAT
1090 ' -----Make Command
1100 PRINT "send data : " ;
1110 INPUT SEND$
1120 ' -----FCS calculation-----
1130 FCS=0
1140 FOR IFCS=1 TO LEN (SEND$)
1150 FCS=FCS XOR ASC (MID$ (SEND$, IFCS, 1))
1160 NEXT
1170 FCS$=RIGHT$ ("0"+HEX$ (FCS), 2)
1180 ' ----- Send data to communication port -----
1190 PRINT #1, SEND$+FCS$+"*"
1200 ' ----- Receive data from communication port -----
1210 RECCNT=0: TMP$=""
1220 DRECLOOP:
1230 IF LOC (1) <> 0 THEN DREC1
1240 RECCNT=RECCNT+1
1250 IF RECCNT=5000 THEN *DRECERR ELSE DRECLOOP
1260 'DREC1
1270 TMP$=TMP$+INPUT$ (LOC (1), #1)
1280 IF RIGHT$ (TMP&, 1)=CHR$ (13) THEN DRECEND
----- ELSE RECCNT=0: GOTO DRECLOOP
1290 DRECERR:
1300 TMP$="No response !!"
1310 DRECEND:
1320 RECV$=TMP$
1330 PRINT "response: "; RECV$
1340 ' ----- Repeat to make Command -----
1350 ' GOTO REPEAT
1360 ' ----- END -----
1370 CLOSE #1
1380 END

```

Examples of use

● Set the unit No. to “00”

- In the following examples, data is shown in individual blocks to make the examples easier to understand. However, when actually creating programs, do not leave spaces between frame items. Also, response are displayed without spaces between frame items.

● Set the set point to “300.0”

- Input data

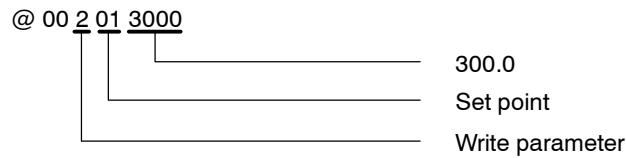

- Response

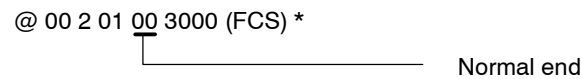

● Start running

- Input data

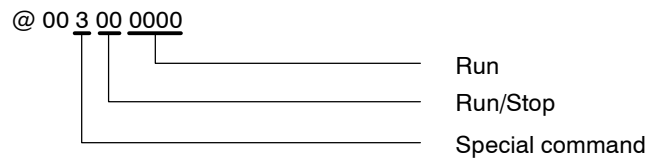

- Response

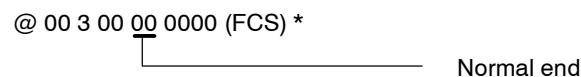

● Monitor process value

- Input data

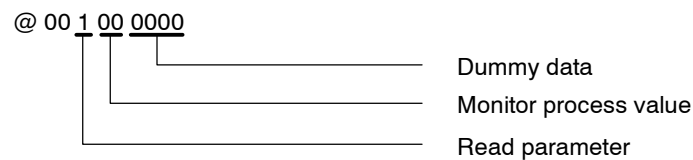

- Response

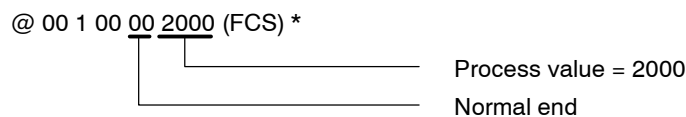

K CHAPTER 7

CALIBRATION

This chapter describes procedures for each calibration operation.
Read this chapter only when the controller must be calibrated.

7.1	Structure of Parameters	7-2
7.2	Calibrating Thermocouple	7-4
7.3	Calibrating Platinum Resistance Thermometer	7-7
7.4	Calibrating Current Input	7-9
7.5	Calibrating Voltage Input	7-10
7.6	Checking Indication Accuracy	7-12

7.1 Structure of Parameters

- To calibrate the E5EK controller, select [**Cal**] in the menu display to select the calibration mode. [**Adj**] is displayed.
- However, note that [**Cal**] may not be displayed on the menu display when, for example, the user is calibrating the E5EK controller for the first time. If this happens, [**Cal**] is displayed by changing the “security” parameter (protect mode) to “0”.
- The parameters in the calibration mode are configured as follows.

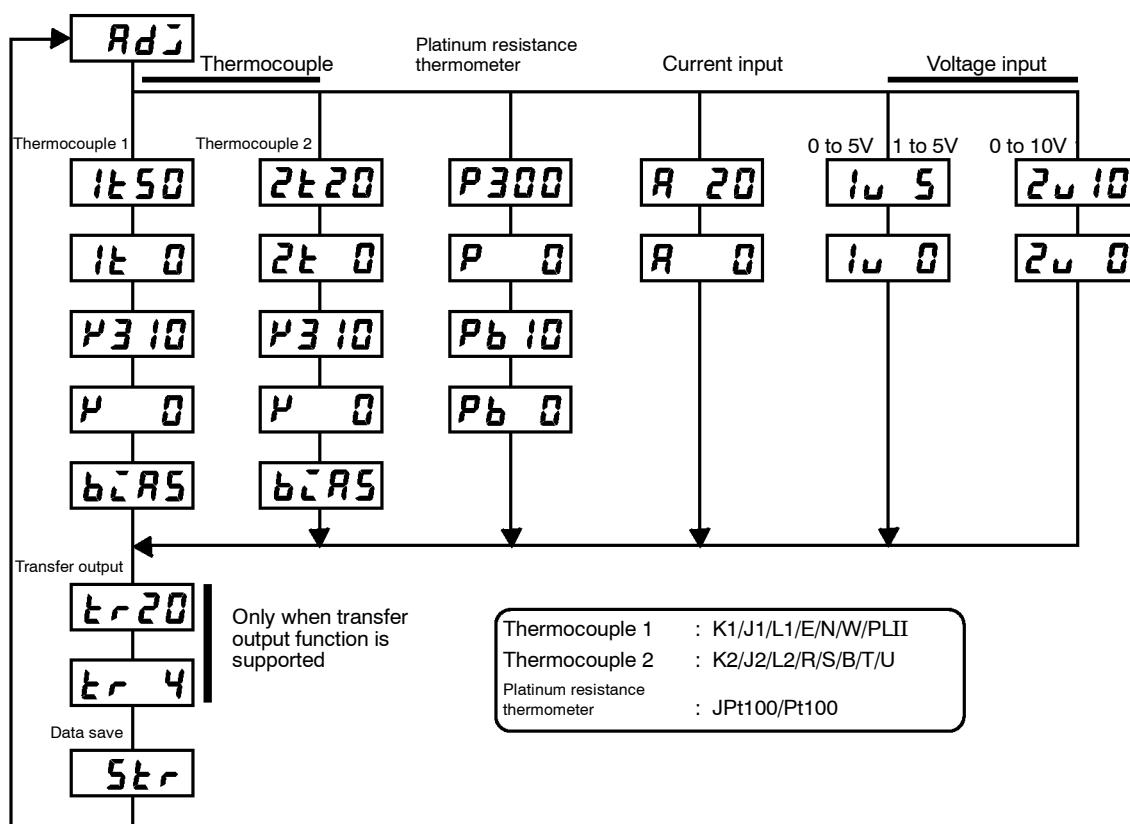

- To select the desired parameter, press the **↩** key. Parameters are displayed in the following order:
 Calibration of inputs → Calibration of transfer output → Saving of calibration data
 If the E5EK controller does not support the transfer output function, calibration of transfer output is automatically deleted from the calibration procedure as follows:
 Calibration of inputs → Saving of calibration data
- Only inputs that have been set in the “input type” parameter (setup mode) can be calibrated. To temporarily save data for each of the calibration parameters, press the **⏏** key for 1 second.
- Transfer output can be calibrated only when the communications unit (E53-AKF) is set in the controller. To adjust data items, press the **⏏** or **⏏** keys.
- The data save menu is displayed only when all calibration items have temporarily been saved.
- After calibrating input, you must always check indication accuracy. For details, see page 7-12.

● Calibration item menu



Calibration item parameter

Process value

- Parameters are displayed on the No.1 display, and the process value is displayed in Hexadecimal on the No.2 display.
- Normally, the process value changes by several digits. The process value flashes, for example, when a sensor error causes the process value to stray from the calibration target range.
- When the process value display is flashing, the process value is not saved as data even if the  key is pressed.

● Calibration save mark



calibration save mark

- Once the E5EK controller has been calibrated by the user, [*Ad*] is preceded by the “.” mark when the calibration mode is selected.

7.2 Calibrating Thermocouple

- Calibrate according to the type of thermocouple, thermocouple 1 group (K1, J1, L1, E, N, W, PLII) and thermocouple 2 group (K2, J2, L2, R, S, B, T, U).
- When calibrating, do not cover the bottom or top of the controller. Also, do not touch the input terminals (Nos. 11 and 12) and compensating conductor on the E5EK controller.

● Preparations

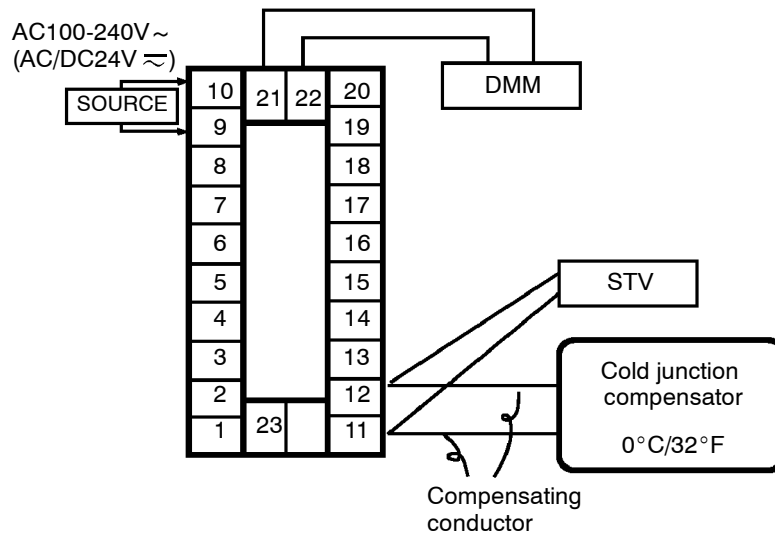

- Set the cold junction compensator to 0°C. However, make sure that internal thermocouples are disabled (tips are open).
- In the above figure, STV refers to a standard DC current/voltage source, and DMM refers to a precision digital multimeter. However, note that DMM is required only when the transfer output function is supported.
- Use the compensating conductor selected thermocouple. However, note that when thermocouple R, S, E, B, W or PLII is used, the cold junction compensator and the compensating conductor can be substituted with the cold junction compensator and the compensating conductor for thermocouple K.



Connecting the Cold Junction Conductor

Correct process values cannot be obtained if you touch the contact ends of the compensating conductor during calibration of a thermocouple. Accordingly, short (enable) or open (disable) the tip of the compensating conductor inside the cold junction compensator as shown in the figure below to create a contact or non-contact state for the cold junction compensator.

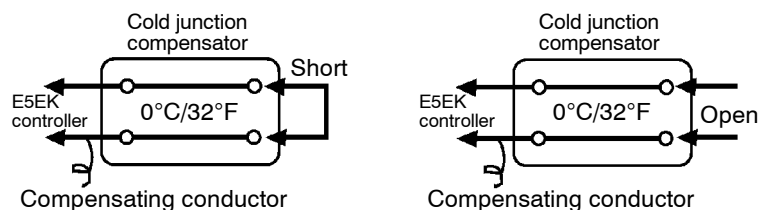

● Calibration: thermocouple 1

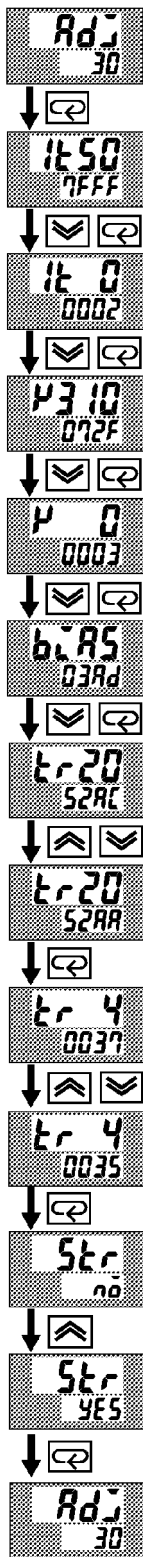

This example describes how to calibrate a thermocouple when the transfer output function is supported. If the transfer output function is not supported, skips steps (7) to (10).

- (1) When [Adj] is displayed, the 30-minute timer is displayed on the No.2 display and counts down. This timer serves as a guide for the aging time when aging is required.
- (2) First, calibrate the main input. Press the key to display [1E 50] (50mV calibration display). Set STV output to 50mV. When the value on the No.2 display has stabilized (changes of several digits max.), press the key to temporarily save the calibration data.
- (3) Press the key to display [1E 0] (0mV calibration display). Set STV output to 0mV. When the value on the No.2 display has stabilized (changes of several digits max.), press the key to temporarily save the calibration data.
- (4) Next, calibrate the cold junction compensator. Press the key to display [P3 10] (310mV calibration display). Set STV output to 310mV. When the value on the No.2 display has stabilized (changes of several digits max.), press the key to temporarily save the calibration data.
- (5) Press the key to display [P 0] (0mV calibration display). Set STV output to 0mV. When the value on the No.2 display has stabilized (changes of several digits max.), press the key to temporarily save the calibration data.
- (6) Finally, calibrate the bias compensation value. Disconnect the STV, and enable the thermocouple of the cold junction compensator. When carrying this out, make sure that the wiring on the STV is disconnected. Make sure that the cold junction compensator is set to 0°C and press the key. The display changes to [b. AS] (calibration display for the bias compensation value). When the value on the No.2 display has stabilized (changes of several digits max.), press the key to temporarily save the calibration data.
- (7) Next, calibrate the transfer output function. If the transfer output function is not supported, skip to step (11). Press the key. The display changes to [Er 20] (20mA calibration display).
- (8) Set the output to 20mA by the or keys while monitoring the voltage on the digital multimeter. In the example on the left, the display indicates that the value two digits smaller than before calibration is “20mA”.
- (9) Press the key. The display changes to [Er 4] (4mA calibration display).
- (10) Set the output to 4mA by the or keys while monitoring the voltage on the digital multimeter. In the example on the left, the display indicates that the value two digits smaller than before calibration is “4mA”.
- (11) Press the key until the display changes to the data save display. Press the key. The No.2 display changes to [YES], and two seconds later the calibration data is saved to internal memory. If you press the key when the No.2 display reads [no], the calibration data is invalidated.
- (12) This completes calibration of the thermocouple 1 group. Press the key to return the display to [Adj].

● Calibration: thermocouple 2



This example describes how to calibrate a thermocouple when the transfer output function is supported. If the transfer output function is not supported, skips steps (7) to (10).

- (1) When [Adj] is displayed, the 30-minute timer is displayed on the No.2 display and counts down. This timer serves as a guide for the aging time when aging is required.
- (2) First, calibrate the main input. Press the key to display [2t 20] (20mV calibration display). Set STV output to 20mV. When the value on the No.2 display has stabilized (changes of several digits max.), press the key to temporarily save the calibration data.
- (3) Press the key to display [2t 0] (0mV calibration display). Set STV output to 0mV. When the value on the No.2 display has stabilized (changes of several digits max.), press the key to temporarily save the calibration data.
- (4) Next, calibrate the cold junction compensator. Press the key to display [μ 310] (310mV calibration display). Set STV output to 310mV. When the value on the No.2 display has stabilized (changes of several digits max.), press the key to temporarily save the calibration data.
- (5) Press the key to display [μ 0] (0mV calibration display). Set STV output to 0mV. When the value on the No.2 display has stabilized (changes of several digits max.), press the key to temporarily save the calibration data.
- (6) Finally, calibrate the bias compensation value. Disconnect the STV, and enable the thermocouple of the cold junction compensator. When carrying this out, make sure that the wiring on the STV is disconnected. Make sure that the cold junction compensator is set to 0°C and press the key. The display changes to [b 20] (calibration display for the bias compensation value). When the value on the No.2 display has stabilized (changes of several digits max.), press the key to temporarily save the calibration data.
- (7) Next, calibrate the transfer output function. If the transfer output function is not supported, skip to step (11). Press the key. The display changes to [t r 20] (20mA calibration display).
- (8) Set the output to 20mA by the or keys while monitoring the voltage on the digital multimeter. In the example on the left, the display indicates that the value two digits smaller than before calibration is “20mA”.
- (9) Press the key. The display changes to [t r 4] (4mA calibration display).
- (10) Set the output to 4mA by the or keys while monitoring the voltage on the digital multimeter. In the example on the left, the display indicates that the value two digits smaller than before calibration is “4mA”.
- (11) Press the key until the display changes to the data save display. Press the key. The No.2 display changes to [YES], and two seconds later the calibration data is saved to internal memory. If you press the key when the No.2 display reads [no], the calibration data is invalidated.
- (12) This completes calibration of the thermocouple 2 group. Press the key to return the display to [Adj].

7.3 Calibrating Platinum Resistance Thermometer

● Preparation

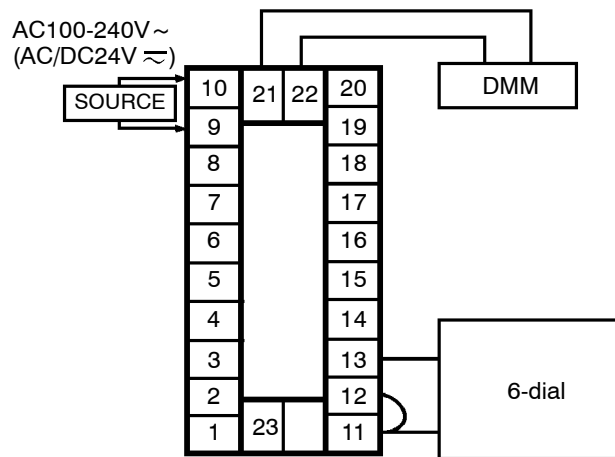

- Use leads of the same thickness when connecting to the platinum resistance thermometer.
- In the above figure, 6-dial refers to a precision resistance box, and DMM stands for a digital multimeter. However, note that the DMM is required only when the transfer output function is supported.
- Connect (short) the leads from terminal Nos. 11 and 12.

● Calibration

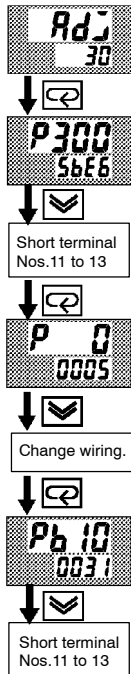

Cont'd on next page

This example describes how to calibrate a platinum resistance thermometer when the transfer output function is supported. If the transfer output function is not supported, skips steps (7) to (10).

- (1) When [Adj] is displayed, the 30-minute timer is displayed on the No.2 display and counts down. This timer serves as a guide for the aging time when aging is required.
- (2) First, calibrate the main input. Press the [P] key to display [P 300] (300Ω calibration display). Set the 6-dial to 300Ω. When the value on the No.2 display has stabilized (changes of several digits max.), press the [✓] key to temporarily store the calibration data.
- (3) Press the [P] key to switch [P 0] (0Ω calibration) display. Short terminal No. 11 to 13. When the value on the No.2 display has stabilized (changes of several digits max.), press the [✓] key to temporarily store the calibration data.
- (4) Next, calibrate the B-B' input. Change the wiring as follows.

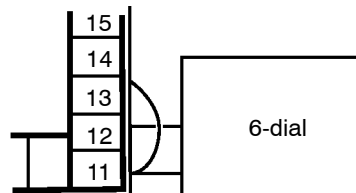

Make the connection across terminals 11 and 12 and the 6-dial as short as possible. Short terminals 11 and 13.

- (5) Press the [P] key to display [P b 10] (10Ω calibration display). Set the 6-dial to 10Ω. When the value on the No.2 display has stabilized (changes of several digits max.), press the [✓] key to temporarily store the calibration data.

From previous page

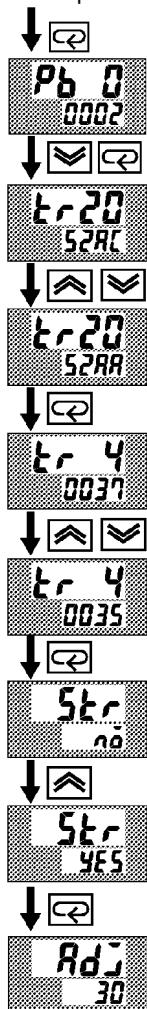

- (6) Press the key to display [Pb 0] (0Ω calibration display, Short terminal Nos. 11 to 13. When the value on the No.2 display has stabilized (changes of several digits max.), press the key to temporarily store the calibration data.
- (7) Next, calibrate the transfer output function. If the transfer output function is not supported, skip to step (11). Press the key. The display changes to [Er 20] (20mA calibration display).
- (8) Set the output to 20mA by the or keys while monitoring the voltage on the digital multimeter. In the example on the left, the display indicates that the value two digits smaller than before calibration is “20mA”.
- (9) Press the key. The display changes to [Er 4] (4mA calibration display).
- (10) Set the output to 4mA by the or keys while monitoring the voltage on the digital multimeter. In the example on the left, the display indicates that the value two digits smaller than before calibration is “4mA”.
- (11) Press the key until the display changes to the data save display. Press the key. The No.2 display changes to [455], and two seconds later the calibration data is saved to internal memory. If you press the key when the No.2 display reads [no], the calibration data is invalidated.
- (12) This completes calibration of the platinum resistance thermometer. Press the key to return the display to [Adj].

7.4 Calibrating Current Input

● Preparation

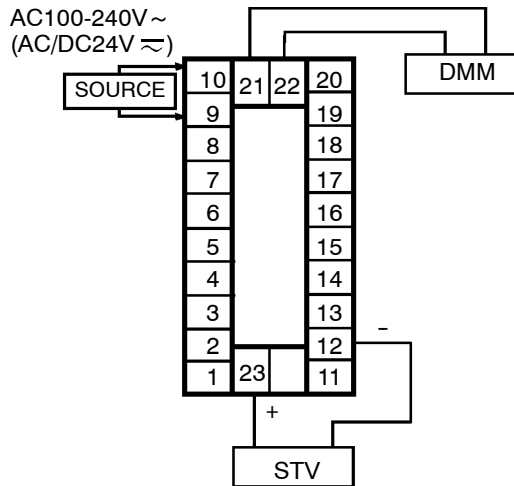

● Calibration

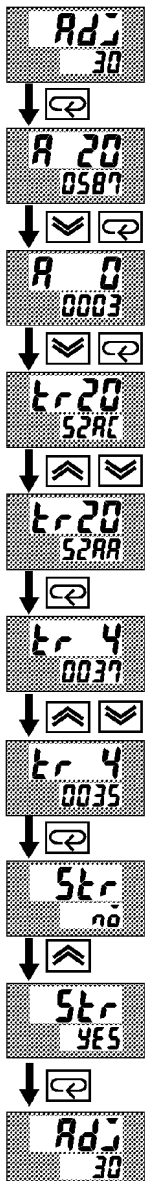

- In the above figure, STV refers to a standard DC current/voltage source, and DMM refers to a precision digital multimeter. However, note that the DMM is required only when the transfer output function is supported.

This example describes how to calibrate a current input when the transfer output function is supported. If the transfer output function is not supported, skips steps (4) to (7).

- (1) When [Adj] is displayed, the 30-minute timer is displayed on the No.2 display and counts down. This timer serves as a guide for the aging time when aging is required.
- (2) Press the [] key. The display changes to [R 20] (20mA calibration display). Set the STV output to 20mA. When the value on the No.2 display has stabilized (changes of several digits max.), press the [] key to temporarily store the calibration data.
- (3) Press the [] key. The display changes to [R 0] (0mA calibration display). Set the STV output to 0 mA. When the value on the No.2 display has stabilized (changes of several digits max.), press the [] key to temporarily store the calibration data.
- (4) Next, calibrate the transfer output function. If the transfer output function is not supported, skip to step (8). Press the [] key. The display changes to [tr 20] (20mA calibration display).
- (5) Set the output to 20mA by the [] or [] keys while monitoring the voltage on the digital multimeter. In the example on the left, the display indicates that the value two digits smaller than before calibration is "20mA".
- (6) Press the [] key. The display changes to [tr 4] (4mA calibration display).
- (7) Set the output to 4mA by the [] or [] keys while monitoring the voltage on the digital multimeter. In the example on the left, the display indicates that the value two digits smaller than before calibration is "4mA".
- (8) Press the [] key until the display changes to the data save display. Press the [] key. The No.2 display changes to [YES], and two seconds later the calibration data is saved to internal memory. If you press the [] key when the No.2 display reads [no], the calibration data is invalidated.
- (9) This completes calibration of current input. Press the [] key to return the display to [Adj].

7.5 Calibrating Voltage Input

● Preparation

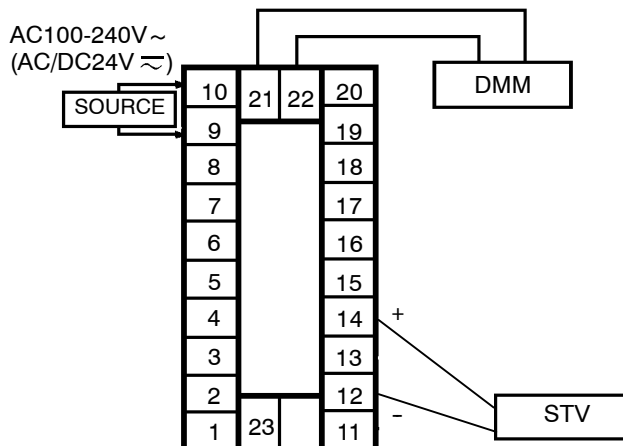

- In the above figure, STV refers to a standard DC current/voltage source, and DMM refers to a precision digital multimeter. However, note that the DMM is required only when the transfer output function is supported.

● Calibration: 0 to 5 V, 1 to 5 V

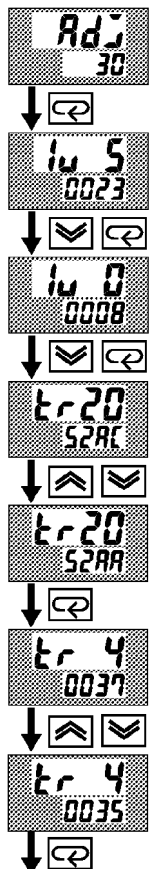

Cont'd on next page

This example describes how to calibrate voltage input when the transfer output function is supported. If the transfer output function is not supported, skips steps (4) to (7).

- (1) When [Adj] is displayed, the 30-minute timer is displayed on the No.2 display and counts down. This timer serves as a guide for the aging time when aging is required.
- (2) Press the key. The display changes to [1u 5] (5 V calibration display). Set the STV output to 5V. When the value on the No.2 display has stabilized (changes of several digits max.), press the key to temporarily store the calibration data.
- (3) Press the key. The display changes to [1u 0] (0V calibration display). Set the STV output to 0V. When the value on the No.2 display has stabilized (changes of several digits max.), press the key to temporarily store the calibration data.
- (4) Next, calibrate the transfer output function. If the transfer output function is not supported, skip to step (8). Press the key. The display changes to [tr 20] (20mA calibration display).
- (5) Set the output to 20mA by the or keys while monitoring the voltage on the digital multimeter. In the example on the left, the display indicates that the value two digits smaller than before calibration is “20mA”.
- (6) Press the key. The display changes to [tr 4] (4mA calibration display).
- (7) Set the output to 4mA by the or keys while monitoring the voltage on the digital multimeter. In the example on the left, the display indicates that the value two digits smaller than before calibration is “4mA”.

From previous page

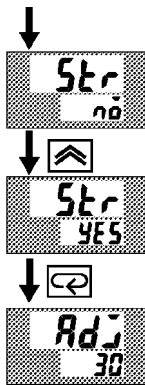

● Calibration : 0 to 10V

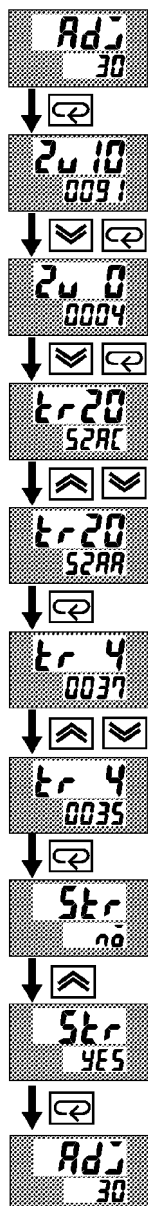

- (8) Press the key until the display changes to the data save display. Press the key. The No.2 display changes to [4E5], and two seconds later the calibration data is saved to internal memory. If you press the key when the No.2 display reads [no], the calibration data is invalidated.
- (9) This completes calibration of voltage input (0 to 5V, 1 to 5V). Press the key to return the display to [Adj].

This example describes how to calibrate voltage input when the transfer output function is supported. If the transfer output function is not supported, skips steps (4) to (7).

- (1) When [Adj] is displayed, the 30-minute timer is displayed on the No.2 display and counts down. This timer serves as a guide for the aging time when aging is required.
- (2) Press the key. The display changes to [2u 10] (10V calibration display). Set the STV output to 10V. When the value on the No.2 display has stabilized (changes of several digits max.), press the key to temporarily store the calibration data.
- (3) Press the key. The display changes to [2u 0] (0V calibration display). Set the STV output to 0V. When the value on the No.2 display has stabilized (changes of several digits max.), press the key to temporarily store the calibration data.
- (4) Next, calibrate the transfer output function. If the transfer output function is not supported, skip to step (8). Press the key. The display changes to [tr 20] (20mA calibration display).
- (5) Set the output to 20mA by the or keys while monitoring the voltage on the digital multimeter. In the example on the left, the display indicates that the value two digits smaller than before calibration is “20mA”.
- (6) Press the key. The display changes to [tr 4] (4mA calibration display).
- (7) Set the output to 4mA by the or keys while monitoring the voltage on the digital multimeter. In the example on the left, the display indicates that the value two digits smaller than before calibration is “4mA”.
- (8) Press the key until the display changes to the data save display. Press the key. The No.2 display changes to [4E5], and two seconds later the calibration data is saved to internal memory. If you press the key when the No.2 display reads [no], the calibration data is invalidated.
- (9) This completes calibration of voltage input (0 to 10V). Press the key to return the display to [Adj].

7.6 Checking Indication Accuracy

- After calibrating input, make sure that you check indication accuracy to make sure that the E5EK controller has been correctly calibrated.
- Operate the E5EK controller in the PV/SP monitor (level 0 mode) mode.
- Check the indication accuracy at the upper and lower limits and mid-point.

● Thermocouple

- Preparation

The following figure shows the required device connection. Make sure that the E5EK controller and cold junction compensator are connected by a compensating conductor for the input type that is to be used during actual operation.

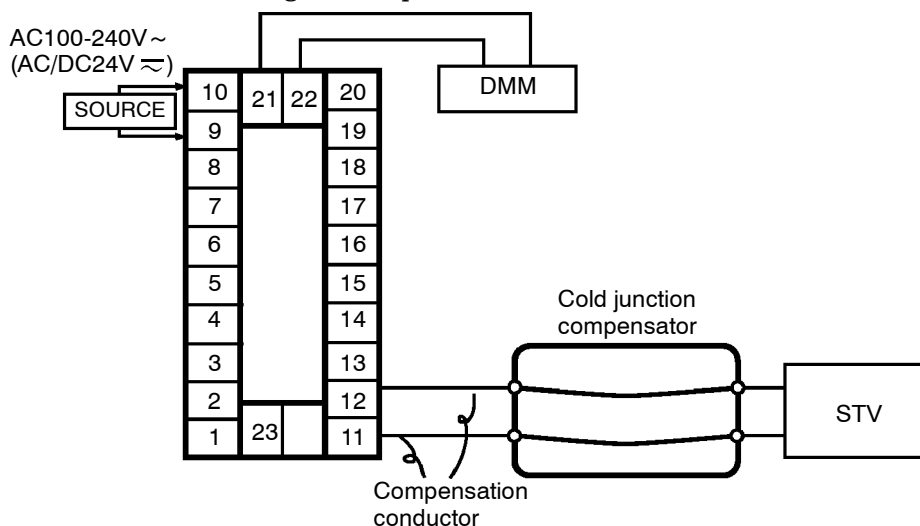

- Operation

Make sure that the cold junction compensator is at 0°C, and set STV output to the voltage equivalent to the starting power of the check value.

● Platinum resistance thermometer

- Preparation

The following figure shows the required device connection.

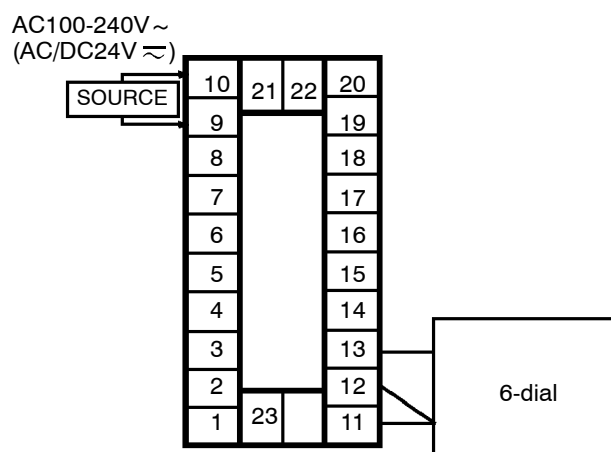

- Operation

Set the 6-dial to the resistance equivalent to the check value.

● Current input

• Preparation

The following figure shows the required device connection.

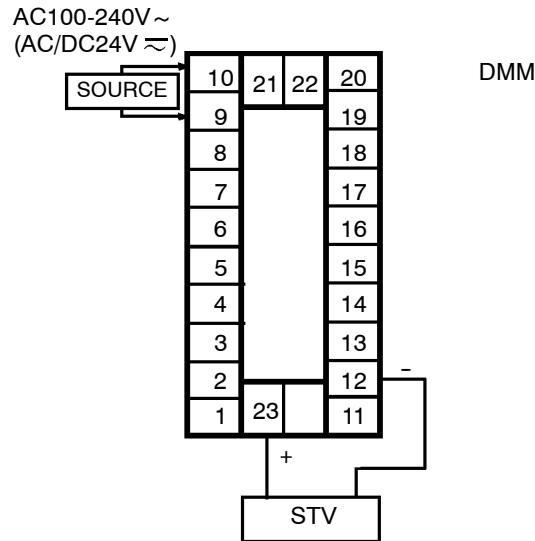

• Operation

Set the STV to the current value equivalent to the check value.

● Voltage input

• Preparation

The following figure shows the required device connection.

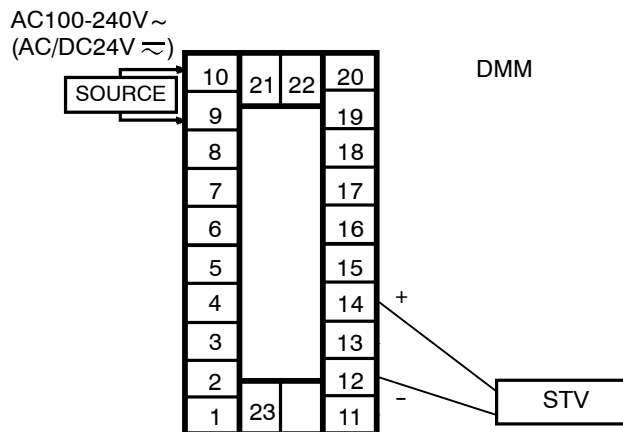

• Operation

Set the STV to the voltage value equivalent to the check value.

K CHAPTER 8

TROUBLESHOOTING

This chapter describes how to find out and remedy the cause if the E5EK does not function properly.

8.1	Initial Checks	8-2
8.2	How to Use the Error Display	8-3
8.3	How to Use Error Output	8-5
8.4	Checking Operation Restrictions	8-6

8.1 Initial Checks

If trouble occurs, first of all check the following.

(1) Power supply

Make sure that the power supply is ON. Also, make sure that the power supply is within the rated voltage range.

(2) Wiring

Make sure that all cables are properly connected.

(3) Communications condition

When communicating using the RS-232C, RS-422 or RS-485 communications interfaces, make sure that the baud rate and other communications condition settings on the host computer and E5EK controller are matching, and are within the permissible ranges.

If there appears to be nothing wrong after checking the E5EK controller, and the same phenomenon continues, check the controller in more detail, for example, on the error display.

8.2 How to Use the Error Display

When an error has occurred, the No.1 display alternately indicates error codes together with the current display item.

This section describes how to check error codes on the display, and the actions you must be taken to remedy the problem.

5Err

Input error

- **Meaning** Input is in error.
- **Action** Check the wiring of inputs, disconnections, and shorts, and check the input type.
- **Operation at error** For control output functions, output the manipulated variable matched to the setting of the “MV at PV error” parameter (level 2 mode). Alarm output functions are activated when the upper limit is exceeded.

E111

Memory error

- **Meaning** Internal memory operation is in error.
- **Action** First, turn the power OFF then back ON again. If the display remains the same, the E5EK controller must be repaired. If the display is restored to normal, then a probable cause can be external noise affecting the control system. Check for external noise.
- **Operation at error** Control output functions turn OFF (2mA max. at 4 to 20mA output, and output equivalent to 0% in case of other outputs). Alarm output functions turn OFF.

E333

A/D converter error

- **Meaning** Internal circuits are in error.
- **Action** First, turn the power OFF then back ON again. If the display remains the same, the E5EK controller must be repaired. If the display is restored to normal, then a probable cause can be external noise affecting the control system. Check for external noise.
- **Operation at error** Control output functions turn OFF (2mA max. at 4 to 20mA output, and output equivalent to 0% in case of other outputs). Alarm output functions turn OFF.

AErr

Calibration data error

This error is output only during temperature input, and is displayed for two seconds when the power is turned ON.

- **Meaning** Calibration data is in error.
- **Action** Must repair.
- **Operation at error** Both control output functions and alarm output functions operate. However, note that readout accuracy is not assured.

CCCC
JJJJ

Display range over

- **Meaning** Though not an error, this is displayed when the process value exceeds the display range when the control range (setting range $\pm 10\%$) is larger than the display range (-1999 to 9999).
 - When less than “-1999” [CCCC]
 - When greater than “9999” [JJJJ]
- **Operation** Control continues, allowing normal operation.

Err

Motor calibration error (Displayed on the No. 2 Display)

- **Meaning** Motor calibration has ended with an error.
- **Action** First, correctly connect the wiring for the potentiometer, open output, and close output. Execute the motor calibration again.

- **Operation procedure**

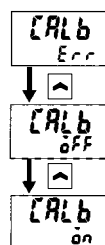

- **Operation at error** When motor calibration is executed, open output will operate and then close output will operate. However, as the value is incorrect, the result turns out to be an error.

8.3 How to Use Error Output

The E5EK controller allows you to assign error output to terminals as outputs.

For details on output assignments, see 3.3 Setting Output Specifications (page 3-6).

- **LBA**
 - LBA (Loop Break Alarm) can be used as a means for detecting loop breaks when the control loop is not functioning normally. For details, see page 4-15.
 - LBA allows you to detect the following errors:
 - (1) Heater burnout
 - (2) Output error (contact weld, damaged transistors, etc.)
 - (3) Sensor error (constant input values, etc.)
 - If you use the LBA function, set the loop break detection time matched to the control characteristics in the “LBA detection time” parameter (level 2 mode).

- **Input errors**
 - If you assign error 1 as the output, an error can be output to auxiliary output 1 or auxiliary output 2 when input is in error. When this error occurs, remedy by following the description for “Input error” (page 8-3).

- **A/D converter error**
 - If you assign error 2 as the output, an error can be output to auxiliary output 1 or auxiliary output 2 when the A/D converter is in error. When this error occurs, remedy by following the description for “A/D converter error” (page 8-3).

- **Remote SP input error**
 - If you assign error 3 as the output, an error can be output to auxiliary output 1 or auxiliary output 2 when the remote SP input error occurs while the remote SP function is enabled. For details on error displays and meanings, see Chapter 4 Applied Operation/4.4 How to Use the Remote SP (page 4-11).
 - When an error occurs, check the state of the remote SP connection. If the lead is broken or disconnected, the remote SP scaling lower limit is displayed blinking on the PV/SP display or remote SP monitor display.

8.4 Checking Operation Restrictions

With the E5EK controller, auto-tuning or self-tuning sometimes do not operate depending on the way functions are combined. The table below summarizes the main operating restrictions.

If the E5EK controller is not operating properly, first check whether operating conditions violate the restrictions in this table.

Restriction	Inoperable or Invalid Functions			
	ST Execution	AT Execution	Limiter Function	Other
At analog input	×			
At heating and cooling control	×	40%AT		
At position-proportional control	×	40% AT	Manipulated variable	ON/OFF control
At ON/OFF control	×	×	Manipulated variable MV change rate	
ST = ON	/	×	Manipulated variable MV change rate	SP ramp function
At AT execution	-	/	MV change rate	Parameter setting
At stop	×	×	Manipulated variable MV change rate	

Items marked by a “x” indicates combinations of conditions not acceptable during ST or AT execution.

Items marked by “-” are impossible combinations.

K APPENDIX

SPECIFICATIONS	A-2
ABOUT CURRENT TRANSFORMER (CT) ...	A-5
CONTROL BLOCK DIAGRAM	A-6
SETTING LIST	A-8
MODEL LIST	A-11
PARAMETER OPERATIONS LIST	A-12
FUZZY SELF-TUNING	A-14
X FORMAT	A-17
ASCII CODE LIST	A-20

SPECIFICATIONS

Ratings

	AC100-240V type	AC/DC24V type
Supply Voltage	AC100-240V ~, 50/60 Hz	AC/DC24V ~, 50/60Hz
Power Consumption	15VA	12VA, 8W
Operating Voltage Range	85% to 110% of rated supply voltage	
Main Input	Thermocouple : K, J, T, E, L, U, N, R, S, B, W, PLII Platinum resistance thermometer : JPt100, Pt100 Voltage input : 4 to 20mA, 0 to 20mA (Input impedance 150Ω) Current input : 1 to 5V, 0 to 5V, 1 to 10V (Input impedance 1MΩ)	
Sub-Input	CT input: E54-CT1, E54-CT3 Potentiometer: 100Ω to 2.5kΩ Remote SP input: 4 to 20 mA (Input impedance 150Ω)	
Control Output	According to output unit (see "Output Unit Ratings and Characteristics")	
Auxiliary Output	SPST-NO, 3A at 250 VAC (resistive load)	
Control Method	Advanced PID or ON/OFF control	
Setting Method	Digital setting using front panel keys	
Indication Method	7-segment digital display, Bar graph and LEDs	
Other Functions	According to option unit (see "Option Unit Ratings and Characteristics")	
Ambient Temperature	Operating : -10°C to 55°C (with no icing)/3-year warranty period: -10°C to 50°C Storage : -25°C to 65°C (with no icing)	
Ambient Humidity	35% to 85%	

*1 Thermocouple W is W/Re5-26.

*2 The following table shows the setting ranges and indication ranges for each of the inputs.

Input	Setting Range	Indication Range
JPt100	-199.9 to 650.0(°C) /-199.9 to 999.9(°F)	-199.9 to 735.0(°C) /-199.9 to 999.9(°F)
Pt100	-199.9 to 650.0(°C) /-199.9 to 999.9(°F)	-199.9 to 735.0(°C) /-199.9 to 999.9(°F)
K1	-200 to 1300(°C) /-300 to 2300(°F)	-350 to 1450(°C) /-560 to 2560(°F)
K2	0.0 to 500.0(°C) /0.0 to 900.0(°F)	-50.0 to 550.0(°C) /-90.0 to 990.0(°F)
J1	-100 to 850(°C) /-100 to 1500(°F)	-195 to 945(°C) /-260 to 1660(°F)
J2	0.0 to 400.0(°C) /0.0 to 750.0(°F)	-40.0 to 440.0(°C) /-75.0 to 825.0(°F)
T	-199.9 to 400.0(°C) /-199.9 to 700.0(°F)	-199.9 to 460.0(°C) /-199.9 to 790.0(°F)
E	0 to 600(°C) /0 to 1100(°F)	-60 to 660(°C) /-110 to 1210(°F)
L1	-100 to 850(°C) /-100 to 1500(°F)	-195 to 945(°C) /-260 to 1660(°F)
L2	0.0 to 400.0(°C) /0.0 to 750.0(°F)	-40.0 to 440.0(°C) /-75.0 to 825.0(°F)
U	-199.9 to 400.0(°C) /-199.9 to 700.0(°F)	-199.9 to 460.0(°C) /-199.9 to 790.0(°F)
N	-200 to 1300(°C) /-300 to 2300(°F)	-350 to 1450(°C) /-560 to 2560(°F)
R	0 to 1700(°C) /0 to 3000(°F)	-170 to 1870(°C) /-300 to 3300(°F)
S	0 to 1700(°C) /0 to 3000(°F)	-170 to 1870(°C) /-300 to 3300(°F)
B	100 to 1800(°C) /300 to 3200(°F)	-70 to 1970(°C) /10 to 3490(°F)
W	0 to 2300(°C) /0 to 4100(°F)	-230 to 2530(°C) /-410 to 4510(°F)
PLII	0 to 1300(°C) /0 to 2300(°F)	-130 to 1430(°C) /-230 to 2530(°F)
4 to 20mA 0 to 20mA 1 to 5V 0 to 5V 0 to 10V	One of following ranges depending on results of scaling -1999 to 9999 -199.9 to 999.9 -19.99 to 99.99 -1.999 to 9.999	-10 to 110% of setting range. Note, however that max. value is -1999 to 9999

Characteristics

Indication Accuracy	Thermocouple: (±0.3% of indication value or ± 1°C, whichever greater) ± 1 digit max. (*1) Platinum resistance thermometer: (±0.2% of indication value or ± 0.8°C whichever greater) ± 1 digit max. Analog input: ±0.2% ± 1 digit max. CT input: ±5%FS ± 1 digit max. Potentiometer: ±5%FS ± 1 digit max. Remote SP: ±0.2%FS ± 1 digit max.	
Temperature variation influence (*2)	Platinum resistance thermometer: (±1% of PV or ± 2°C, whichever greater) ± 1 digit max. Thermocouple (R, S, B, W): (±1% of PV or ± 10°C, whichever greater) ± 1 digit max. Other thermocouples (K1, K2, J1, J2, E, N, T, L1, L2, U, PLII): (±1% of PV or ± 4°C, whichever greater) ± 1 digit max. Analog input (current, voltage, or remote SP input): ±1%FS±1 digit max.	
Voltage variation influence (*2)		
Hysteresis	0.01 to 99.99% FS (in units of 0.01% FS)	
Proportional Band (P)	0.1 to 999.9% FS (in units of 0.1% FS)	
Integral (reset) Time (I)	0 to 3999 s (in units of 1 second) (*3)	
Derivative (rate) Time (D)	0 to 3999 s (in units of 1 second)	
Control Period	1 to 99 s (in units of 1 second)	
Manual Reset Value	0.0 to 100.0% (in units of 0.1%)	
Alarm Setting Range	-1999 to 9999 or -199.9 to 999.9 (decimal point position dependent on input type or result of scaling)	
Sampling Period	Temperature input: 250 ms, Analog input: 100 ms, Sub-input : 1s	
Insulation Resistance	20 MΩ min. (at 500 VDC)	
Dielectric Strength	2000 VAC, 50/60Hz for 1 min (between terminals of different polarities)	
Vibration Resistance	Malfunction	10 to 55 Hz, 10 m/s ² (approx. 1G) for 10 min each in X, Y, and Z directions
	Destruction	10 to 55 Hz, 20 m/s ² (Approx. 2G) for 2hrs each in X, Y, and Z directions
Shock Resistance	Malfunction	200 m/s ² min. (approx. 20G), 3 times each in 6 directions (100 m/s ² (approx. 10G) applied to the relay)
	Destruction	300 m/s ² min. (Approx. 30G), 3 times each in 6 directions
Weight	Approx. 320 g, mounting bracket: approx. 65 g	
Enclosure Ratings	Front panel: NEMA4 for indoor use (equivalent to IP66) Rear case: IEC standard IP20 Terminals: IEC standard IP00	
Memory Protection	Non-volatile memory (number of writings : 100000 operations)	

- *1 The indication accuracy of the K1, T, and N thermocouples at a temperature of -100°C or less is ±2°C ±1 digit maximum. The indication accuracy of the U, L1 and L2 thermocouples at any temperature is ±2°C ±1 digit maximum. The indication accuracy of the B thermocouple at a temperature of 400°C or less is unrestricted. The indication accuracy of the R and S thermocouples at a temperature of 200°C or less is ±3°C ±1 digit maximum. The indication accuracy of the W thermocouple is ±1 digit max. of whichever is the greater of ±0.3% or ±3°C of the indicated value. The indication accuracy of the PLII thermocouple is ±1 digit max. of whichever is the greater of ±0.3% or ±2°C of the indicated value.
- *2 Ambient temperature: -10°C to 23°C to 55°C
Voltage range: -15 to +10% of rated voltage
- *3 On a position-proportional control type, 1 to 3999.

Heater Burnout Alarm

Max. heater current	Single-phase 50 A VAC (see note 1)
Heater current value display accuracy	±5%FS ± 1 digit max.
Heater burnout alarm setting range	0.1 to 49.9 A (in units of 0.1 A) see note 2)
Min. detection ON time	190 ms (see note 3)

- Note:** 1. Use the K2CU-F□□A-□GS (with gate input terminals) for the detection of three-phase heater burnout.
2. The heater burnout alarm is always OFF if the alarm is set to 0.0A and always ON if the alarm is set to 50.0A.
3. No heater burnout detection or heater current value measurement is possible if the control output (heat) is ON for less than 190ms.

■ Output Unit Ratings and Characteristics

Ratings and characteristics conform to the output unit mounted on the controller. For details on the ratings of the output unit, see page 2–9.

The relay output unit is already mounted on the E5EK-PRR2. When replacing the output unit, use the E53-R.

■ Option Unit Ratings and Characteristics

Event inputs	Contact input	ON: 1 k Ω max., OFF: 100 k Ω min.
	No-contact input	ON: residual voltage 1.5 V max., OFF: leakage current 0.1 mA max.
Communications	Interface	:RS-232C, RS-422 or RS-485
	Transmission method	:Half-duplex
	Synchronization method	:Start-stop synchronization (asynchronous method)
	Baud rate	:1.2/2.4/4.8/9.6/19.2 kbps
Transfer output	4 to 20 mA, Permissible load impedance: 600 Ω max. Resolution: Approx. 2600	

ABOUT CURRENT TRANSFORMER (CT)

● Specifications

Item	Specifications	
Type	E54-CT1	E54-CT3
Max. continuous current	50A	120A (*1)
Dielectric Strength	AC 1000V (1min)	
Vibration Resistance	50Hz 98m/s ² [10G]	
Weight	Approx. 11.5g	Approx. 50g
Accessory	-	Armature (2) Plug (2)

*1 The maximum continuous current of the E5AK is 50 A.

● Dimensions

E54-CT1

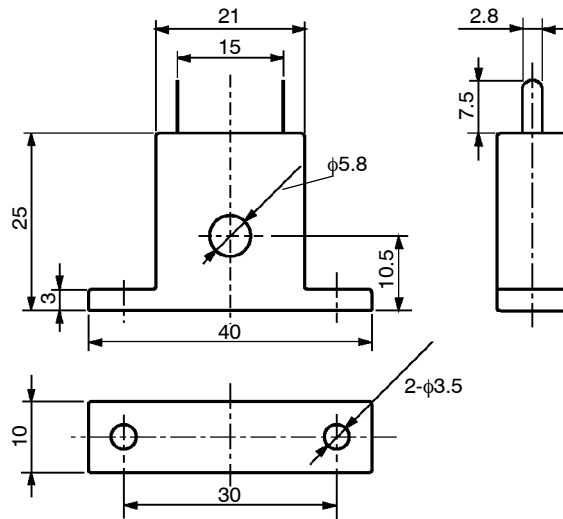

E54-CT3

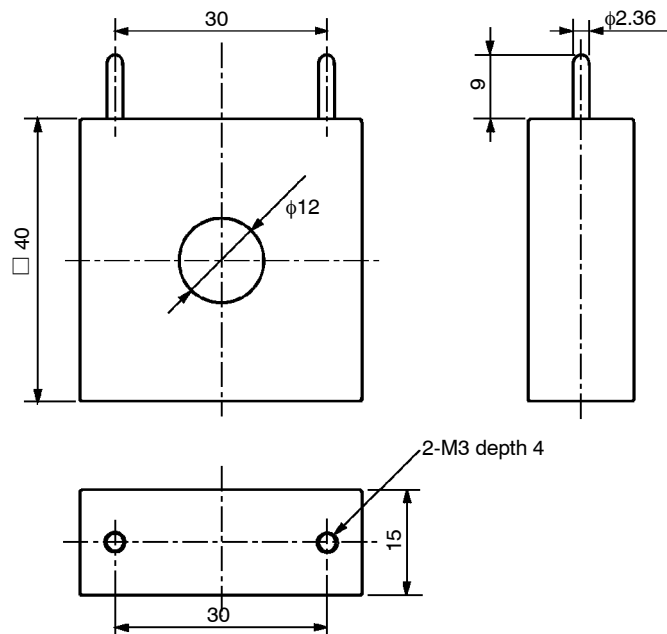

CONTROL BLOCK DIAGRAM

Standard type

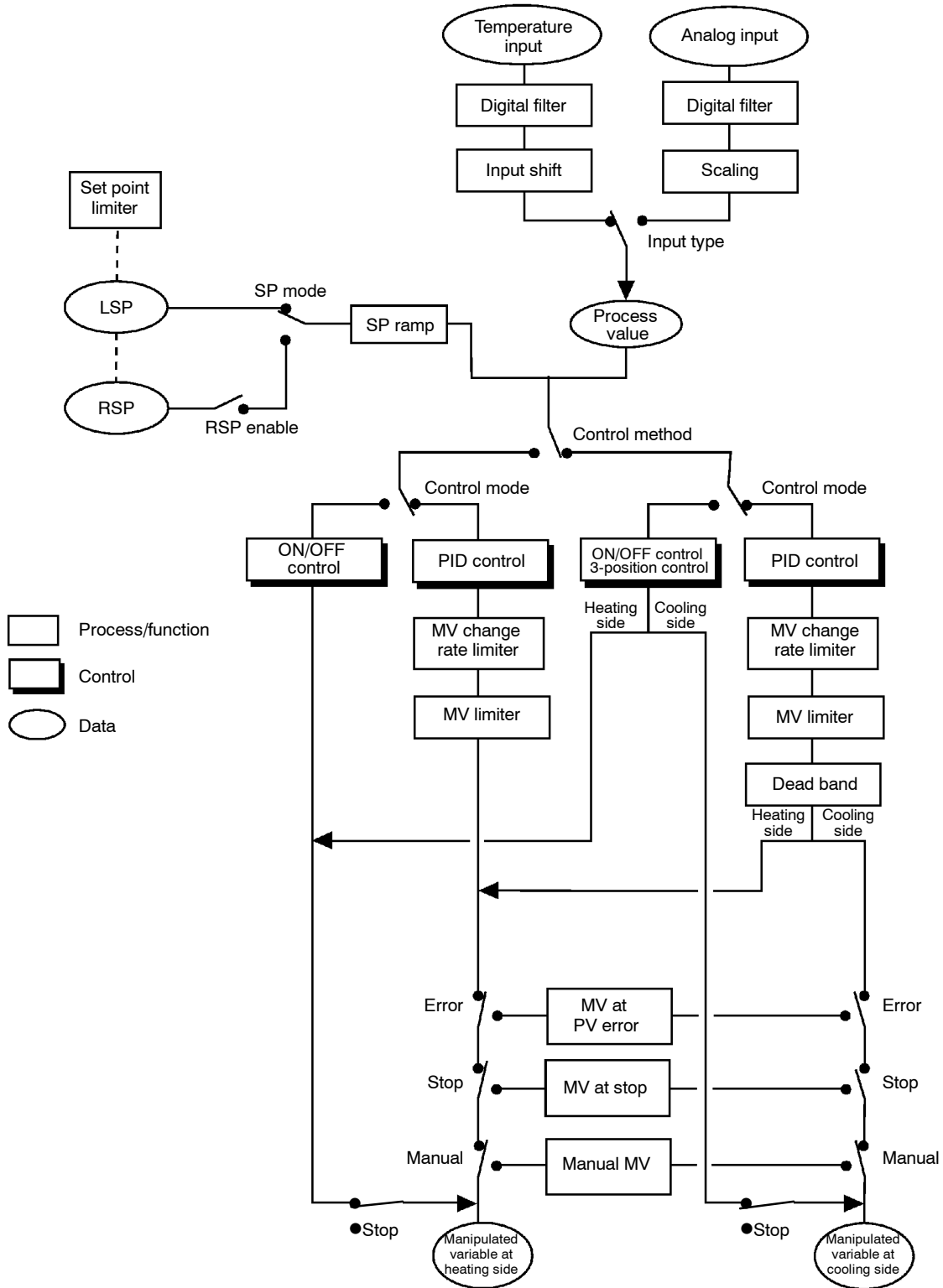

Position-proportional type

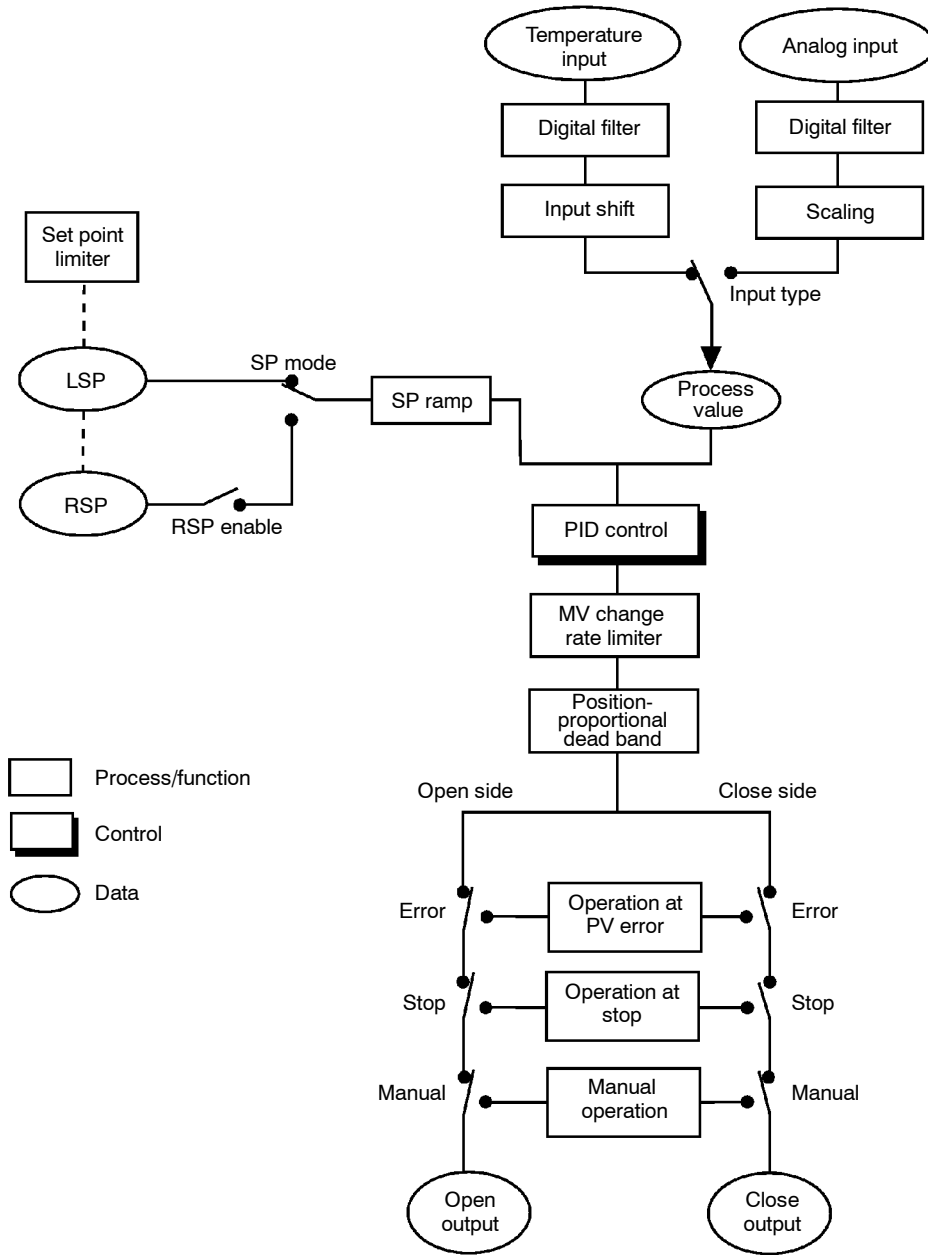

SETTING LIST

Mode	Parameter Name	Setting Range	Unit	Default	Remarks	Setting
Protect	SECr Security	0 to 6	None	1		
	KEYP [A/M] key protect	ON/OFF	None	OFF		
Manual	Manual MV	-5.0 to 105.0 *1	%	0.0		
Level 0	Set point	Set point lower limit to Set point upper limit	EU	0		
	r-s Run/Stop	Run/Stop	None	RUN		
Level 1	At AT Execute/Cancel	OFF/AT-1/AT-2	None	OFF	During running	
	SP-0 Set point 0	Set point lower limit to Set point upper limit	EU	0	Multi-SP	
	SP-1 Set point 1	Set point lower limit to Set point upper limit	EU	0	Multi-SP	
	SP-2 Set point 2	Set point lower limit to Set point upper limit	EU	0	Multi-SP	
	SP-3 Set point 3	Set point lower limit to Set point upper limit	EU	0	Multi-SP	
	AL-1 Alarm value 1	-1999 to 9999	EU	0		
	AL-2 Alarm value 2	-1999 to 9999	EU	0		
	AL-3 Alarm value 3	-1999 to 9999	EU	0		
	P Proportional band	0.1 to 999.9	%FS	10.0		
	I Integral time	0 to 3999	sec	233		
	d Derivative time	0 to 3999	sec	40		
	C-S Cooling coefficient	0.01 to 99.99	None	1.00	At heating and cooling control	
	C-db Dead band	-19.99 to 99.99	%FS	0.00	At heating and cooling control	
	db Position-proportional dead band	0.1 to 10.0	%	2.0	At position-proportional control	
	oF-r Manual reset value	0.0 to 100.0	%	50.0		
	HYS Hysteresis (heat)	0.01 to 99.99	%FS	0.10		
	CHYS Hysteresis (cool)	0.01 to 99.99	%FS	0.10	At heating and cooling control	
	CP Control period (heat)	1 to 99	sec	20		
	C-CP Control period (cool)	1 to 99	sec	20	At heating and cooling control	
	Hb Heater burnout	0.0 to 50.0	A	0.0	Heater burnout detection	
Level 2	r-L Remote/Local	RMT/LCL	None	LCL	Communications unit setting	
	SPnd SP mode	RSP/LSP	None	LSP		
	SPrU SP ramp time unit	M(Minutes) / H(Hours)	None	M		
	SPrE SP ramp set value	0 to 9999	EU	0		
	LbR LBA detection time	0 to 9999 *1	Sec	0		
	nu-S MV at stop	-5.0 to 105.0 *1	%	0.0		
	nu-E MV at PV error	-5.0 to 105.0 *2	%	0.0		
	oL-H MV upper limit	MV lower limit + 0.1 to 105.0 *3	%	105.0		
	oL-L MV lower limit	-5.0 to MV upper limit -0.1	%	-5.0		
	oRL MV change rate limit	0.0 to 100.0	%/sec	0.0		
	INF Input digital filter	0 to 9999	sec	0		
	oC-H Open/close hysteresis	0.1 to 20.0	%	0.8		
	ALH1 Alarm 1 hysteresis	0.01 to 99.99	%FS	0.02		
	ALH2 Alarm 2 hysteresis	0.01 to 99.99	%FS	0.02		
	ALH3 Alarm 3 hysteresis	0.01 to 99.99	%FS	0.02		
	INSH Input shift upper limit	-199.9 to 999.9	°C/°F	0.0	Temperature input	
INSL Input shift lower limit	-199.9 to 999.9	°C/°F	0.0	Temperature input		

*1 During heat and cooling control, the lower limit becomes -105.0%.

During position-proportional control the setting becomes HOLD, OPEN or CLOS.

*2 During heat and cooling control, the setting range becomes 0.0 to 105.0%.

*3 During heat and cooling control, the setting range becomes -105.0 to 0.0%.

Mode	Parameter Name	Setting Range	Unit	Default	Remarks	Setting
Setup	Ln-E	Input type	0 to 21	None	2	
	Ln-H	Scaling upper limit	Scaling lower limit +1 to 9999 *4	EU	-100	Analog input
	Ln-L	Scaling lower limit	-1999 to SP setting upper limit -0.1 *4	EU	0	Analog input
	dP	Decimal point	0 to 3	None	0	Analog input
	d-U	°C/°F selection	°C/°F	None	°C	Temperature input
	LnLE	Parameter initialize	Yes/No	None	NO	
	OUT1	Control output 1 assignment	Heat/Cool/Alarm 1/Alarm 2/Alarm 3 /HBA/LBA	None	HEAT	
	OUT2	Control output 2 assignment	Heat/Cool/Alarm 1/Alarm 2/Alarm 3 /HBA/LBA	None	AL-1	
	SUB1	Auxiliary output 1 assignment	Alarm 1/Alarm 2/Alarm 3/HBA/LBA/ S.ERR/E333/RSER	None	AL-2	
	SUB2	Auxiliary output 2 assignment	Alarm 1/Alarm 2/Alarm 3/HBA/ LBA/S.ERR/E333/RSER	None	AL-3	
	AL1	Alarm 1 type	1 to 11	None	2	Output assignment needed
	AL1n	Alarm 1 open in alarm	N-O/N-C	None	N-O	Output assignment needed
	AL2	Alarm 2 type	1 to 11	None	2	Output assignment needed
	AL2n	Alarm 2 open in alarm	N-O/N-C	None	N-O	Output assignment needed
	AL3	Alarm 3 type	1 to 11	None	2	Output assignment needed
	AL3n	Alarm 3 open in alarm	N-O/N-C	None	N-O	Output assignment needed
OR-EU	Direct/Reverse operation	OR-R/OR-D	None	OR-R		
Expansion	SL-H	Set point upper limit	Set point lower limit +1 to scaling upper limit *2	None	1300 *4	
	SL-L	Set point lower limit	Scaling lower limit to Set point upper limit -1 *2	None	-200 *4	
	LnEL	PID/ON/OFF	PID / ON/OFF	None	PID	
	SE	ST	OFF/ON	None	OFF	
	SE-b	ST stable range	0.1 to 999.9	°C/°F	15.0	ST=ON
	ALFA	α	0.00 to 1.00	None	0.65	
	AT-G	AT calculated gain	0.1 to 10.0	None	1.0	
	RESE	Standby sequence reset setting method	0/1	None	0	
	RET	Automatic return of display mode	0 to 99	Sec	0	
	AT-H	AT hysteresis	0.1 to 9.9	%FS	0.2	
LbAb	LBA detection width	0.0 to 999.9	%FS	0.2		

*4 When temperature input is selected, the sensor range selected in the "input type" parameter (setup mode) corresponds to the scaling upper and lower limit value.

Mode	Parameter Name	Setting Range	Unit	Default	Remarks	Setting
Option	<i>Eu-n</i> Multi-SP function	0 to 2	None	0		
	<i>Eu-1</i> Event input assignment 1	NON/STOP/RMT/MAN/RSP	None	NON		
	<i>Eu-2</i> Event input assignment 2	NON/STOP/RMT/MAN/RSP	None	NON		
	<i>Sbt</i> Communication stop bit	1/2	bits	2		
	<i>Len</i> Communication data length	7/8	bits	7		
	<i>Prty</i> Communication parity	None/Even/Odd	None	EVEN		
	<i>bps</i> Communication baud rate	1.2/2.4/4.8/9.6/19.2	kbps	9.6		
	<i>U-no</i> Communication unit No.	0 to 99	None	0		
	<i>tr-t</i> Transfer output type	SP/SP-M/PV/O/C-O/V-M	None	SP		
	<i>tr-H</i> Transfer output upper limit	*5	*5	*5		
	<i>tr-L</i> Transfer output lower limit	*5	*5	*5		
	<i>Hbl</i> HBA latch	ON/OFF	None	OFF		
	<i>Calb</i> Motor calibration	ON/OFF	None	OFF		
	<i>not</i> Travel time	1 to 999	Sec	1		
	<i>P-db</i> PV dead band	0 to 9999	EU	0		
	<i>rSPU</i> Remote SP enable	ON/OFF	None	OFF		
	<i>rSPH</i> Remote SP upper limit	SP setting lower limit to SP setting upper limit	EU	1300		
	<i>rSPL</i> Remote SP lower limit	SP setting lower limit to SP setting upper limit	EU	-200		
	<i>SPtr</i> SP tracking	ON/OFF	None	OFF		

*5 Set the transfer output type parameter according to the following table.

Transfer Output Type	Transfer Output Lower Limit to Transfer Output Upper Limit
SP :Set point	Set point lower limit to Set point upper limit
SP-M :Set point during SP ramp	Set point lower limit to Set point upper limit
PV :Process value	Scaling lower limit to scaling upper limit
O :Manipulated variable (heat)	-5.0 to 105.0%
C-O :Manipulated variable (cool)	0.0 to 105.0%
V-M :Value opening	-10.0 to 110.0%

- Default : SP
- The output ranges of the SP setting, set point or process value when temperature input is selected are the ranges supported by the selected sensor.
- When the heating side manipulated variable or cooling side manipulated variable is selected, the transfer output lower limit in a heating and cooling control becomes "0.0".

MODEL LIST

Description	Type Name	Specification
Base unit	E5EK-AA2 AC100-240	Standard model
	E5EK-AA2-500 AC100-240	Standard model with terminal cover
	E5EK-AA2 AC/DC24	Standard model
	E5EK-AA2-500 AC/DC24	Standard model with terminal cover
	E5EK-PRR2 AC100-240	Position-proportional model
	E5EK-PRR2-500 AC100-240	Position-proportional model with terminal cover
	E5EK-PRR2 AC/DC24	Position-proportional model
	E5EK-PRR2-500 AC/DC24	Position-proportional model with terminal cover
Option unit	E53-AKB	Event input
	E53-AK01	Communication (RS-232C)
	E53-AK02	Communication (RS-422)
	E53-AK03	Communication (RS-485)
	E53-AKF	Transfer output
Output unit	E53-R	Relay
	E53-S	SSR
	E53-Q	Pulse (NPN) DC12V
	E53-Q3	Pulse (NPN) DC24V
	E53-Q4	Pulse (PNP) DC24V
	E53-C3	Linear (4 to 20mA)
	E53-C3D	Linear (0 to 20mA)
	E53-V34	Linear (0 to 10V)
	E53-V35	Linear (0 to 5V)
Terminal cover	E53-COV08	for E5EK

PARAMETER OPERATIONS LIST

- Switching to modes other than manual or protect mode is carried out by mode selection in the menu display.
- The figure below shows all parameters in the order that they are displayed. Some parameters are not displayed depending on the protect mode setting and conditions of use.

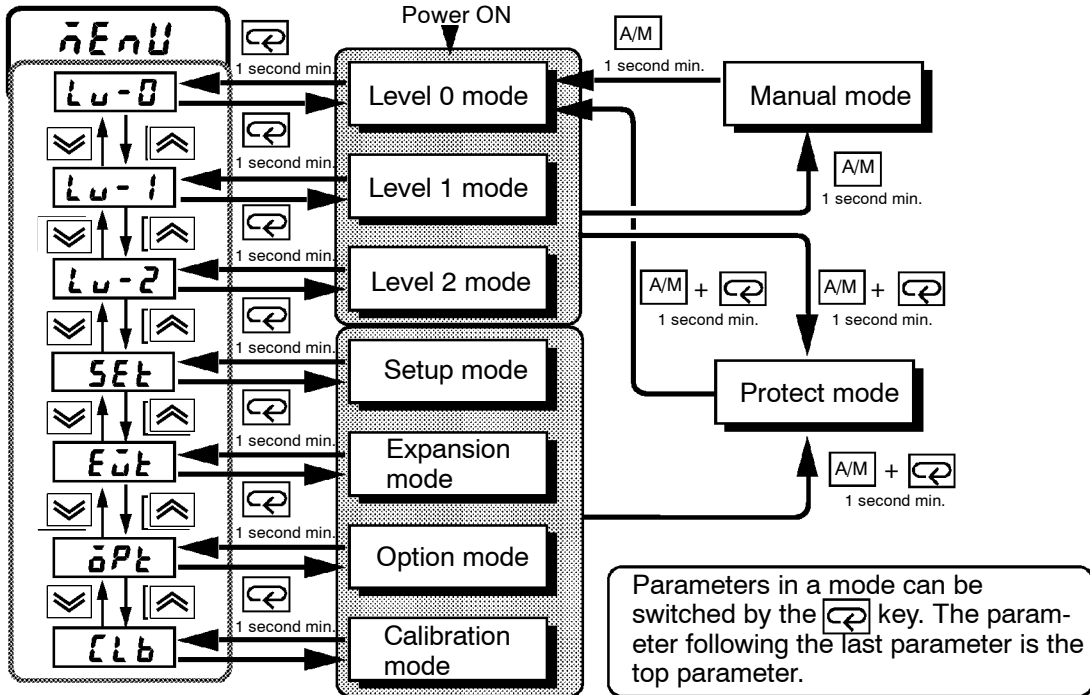

Level 0

- `[]` PV/SP
- `rSP` Remote SP monitor
- `SP-ā` Set point during SP ramp
- `ā` MV monitor (heat)
- `[- ā` MV monitor (cool)
- `u-ā` Valve opening monitor
- `r-S` Run/Stop

Manual mode

- `[]` Manual MV

Protect mode

- `SECr` Security
- `MEYp` [A/M] key protect

Level 1

- `AL` AT Execute/Cancel
- `SP-0` Set point 0
- `SP-1` Set point 1
- `SP-2` Set point 2
- `SP-3` Set point 3
- `AL-1` Alarm value 1
- `AL-2` Alarm value 2
- `AL-3` Alarm value 3
- `P` Proportional band
- `I` Integral time
- `d` Derivative time
- `[- SC` Cooling coefficient
- `[- db` Dead band
- `db` Position-proportional dead band
- `āF-r` Manual reset value
- `HYS` Hysteresis (heat)
- `[HYS` Hysteresis (cool)
- `[P` Control period (heat)
- `[- [P` Control period (cool)
- `[t` Heater current monitor
- `Hb` Heater burnout

Level 2

- `r-L` Remote/Local
- `SP-ā` SP mode
- `SP-rU` SP ramp time unit
- `SP-rt` SP ramp set value
- `LbA` LBA detection time
- `āu-S` MV at stop
- `āu-E` MV at PV error
- `āL-H` MV upper limit
- `āL-L` MV lower limit
- `ārL` MV change rate limit
- `[nF` Input digital filter
- `āC-H` Open/close hysteresis
- `ALH1` Alarm 1 hysteresis
- `ALH2` Alarm 2 hysteresis
- `ALH3` Alarm 3 hysteresis
- `[nSH` Input shift upper limit
- `[nSL` Input shift lower limit

Setup mode

- in-t** Input type
- in-H** Scaling upper limit
- in-L** Scaling lower limit
- db** Decimal point
- d-U** °C/°F selection
- in-it** Parameter initialize
- out-1** Control output 1 assignment
- out-2** Control output 2 assignment
- sub-1** Auxiliary output 1 assignment
- sub-2** Auxiliary output 2 assignment
- ALt-1** Alarm 1 type
- AL in** Alarm 1 open in alarm
- ALt-2** Alarm 2 type
- AL2n** Alarm 2 open in alarm
- ALt-3** Alarm 3 type
- AL3n** Alarm 3 open in alarm
- or-Eu** Direct/Reverse operation

Expansion mode

- SL-H** Set point upper limit
- SL-L** Set point lower limit
- entL** PID / ON/OFF
- St** ST
- St-b** ST stable range
- ALFA** α
- AL-G** AT calculated gain
- r-EST** Standby sequence reset method
- r-ET** Automatic return of display mode
- AL-H** AT hysteresis
- LbAb** LBA detection width

Option mode

- Eu-n** Multi-SP function
- Eu-1** Event input assignment 1
- Eu-2** Event input assignment 2
- Sb-it** Communication stop bit
- LEn** Communication data length
- Prty** Communication parity
- bPS** Communication baud rate
- U-no** Communication unit No.
- tr-t** Transfer output type
- tr-H** Transfer output upper limit
- tr-L** Transfer output lower limit
- HbL** HBA latch
- CALb** Motor calibration
- not** Travel time
- P-db** PV dead band
- r-SPU** Remote SP enable
- r-SPH** Remote SP upper limit
- r-SPL** Remote SP lower limit
- SPtr** SP tracking

Calibration mode

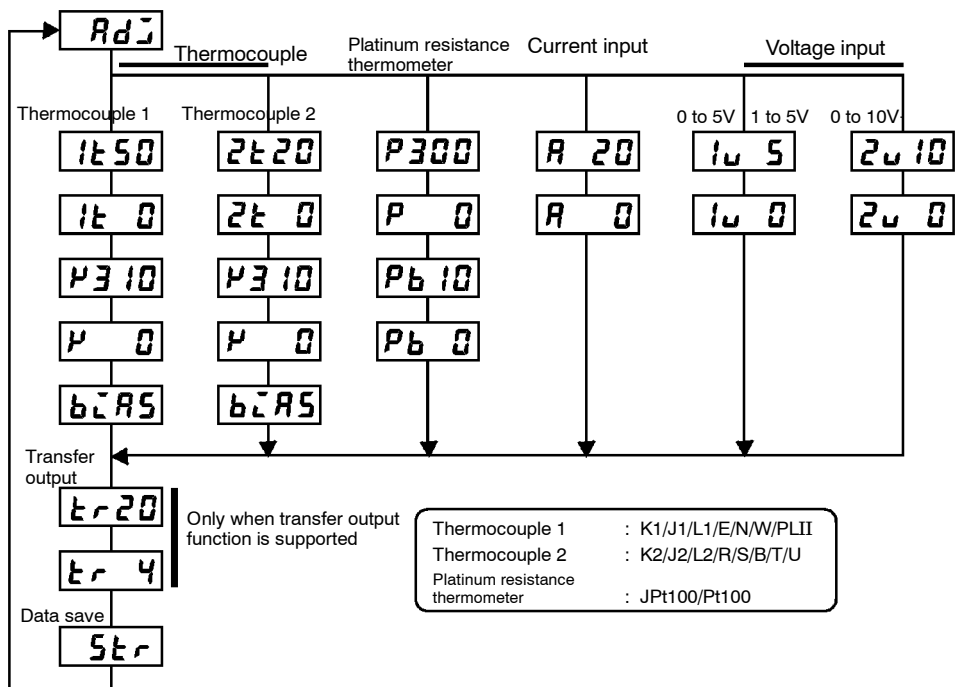

FUZZY SELF-TUNING

Fuzzy self-tuning is a function that enables the E5EK to calculate the most suitable PID constants for the controlled object.

■ Features

- The E5EK determines by itself when to perform fuzzy self-tuning.
- At the time of fuzzy self-tuning, the E5EK does not output any signal that disturbs the temperature or output value.

■ Fuzzy Self-tuning Function

The fuzzy self-tuning function has three modes.

In SRT(step response tuning) mode, the PID constants are tuned using a step response method at the time the set point is changed.

In DT(disturbance tuning) mode, the PID constants are amended so that the controlled temperature will be within the target range set in advance when there is external disturbance.

In HT(hunting tuning) mode, when hunting occurs, the PID constants are amended to suppress the hunting.

Note: Be sure to turn on the power supply to the load either before or simultaneously with the start of Temperature Controller operation. Dead time will be measured from the time the Temperature Controller starts operating. If a load such as a heater is turned on after the Temperature Controller is turned on, dead time longer than the actual value will be measured and inappropriate PID constants will be obtained. If an extremely large amount of dead time is measured, the control amount will be set to 0% for a short period of time before being returned to 100%, and the constants will then be returned. Retuning is performed only for large amounts of dead time, so be sure to follow the precaution given above when starting operation.

● Startup Conditions of SRT

SRT will start if the following conditions are satisfied simultaneously when the E5EK is turned on or the set point is changed.

At the time the E5EK starts operation	At the time set point is changed
1) The set point at the time the E5EK starts operating is different from the set point used at the time SRT was last executed (see note). 2) The process value at the time the E5EK starts operating is smaller than the set point in reverse operation and larger than the set point in normal operation.	1) The new set point is different from the set point used at the time SRT was executed last (see note). 2) The process value is in stable condition before the set point is changed. 3) A larger set point value is set in reverse operation and a smaller set point is set in normal operation.

Note: The last SRT-executed set point is set to 0 before shipping and when changing from advanced PID control to advanced PID control with fuzzy self-tuning.

● PID Constant Refreshing Conditions

If the step control amount is applied before the maximum temperature slope (R) is obtained, SRT will not renew any PID constant. If the proportional band obtained from the R and L values that were measured before the imposition had been completed is larger than the present proportional band, the PID constants will be renewed because the measured value is in the direction towards the suitable proportional band value, and the set point at that time will be the SRT-executed set point.

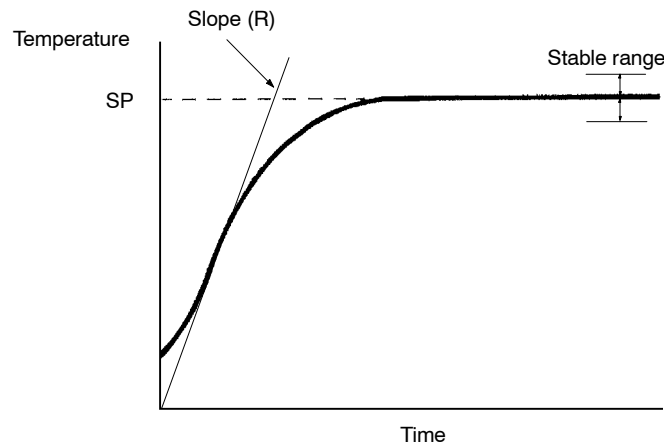

● Stable Temperature Status

If the temperature is within the stable range for a certain time, it is deemed that the temperature is stable. This time is called stability judgement time. Like PID constants, stability judgement time is adjusted with fuzzy self-tuning according to the characteristics of the object to be controlled. Fuzzy self-tuning will not be activated if the temperature is stable because the Temperature Controller deems that temperature control is smooth.

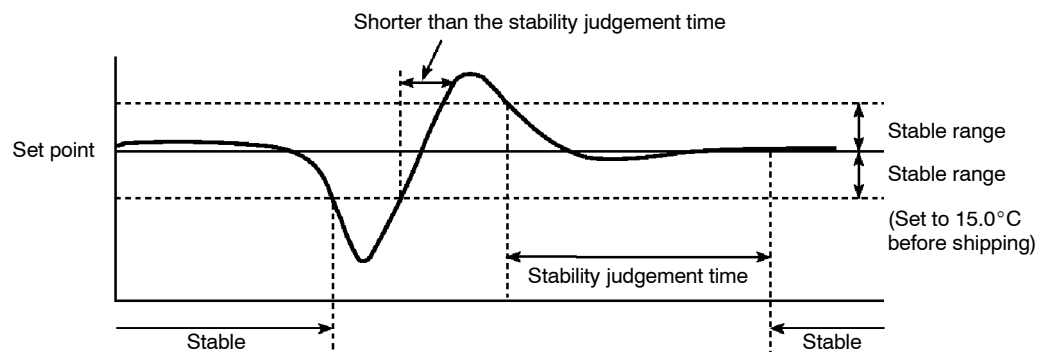

● Balanced Status

If the process value is within the stable range for 60s when there is no output, it is deemed that the temperature is balanced.

● Startup Conditions of DT

- (1) DT will start if the temperature that has been stable varies due to external disturbance and the deflection of the temperature exceeds the stable range, and then the temperature becomes stable, provided that the number of maximum temperature values is less than four.
- (2) DT will start if the set point is changed under the condition that SRT does not start and the temperature becomes stable, provided that the number of maximum temperature values is less than four. If there are four or more maximum temperature values, HT will start.

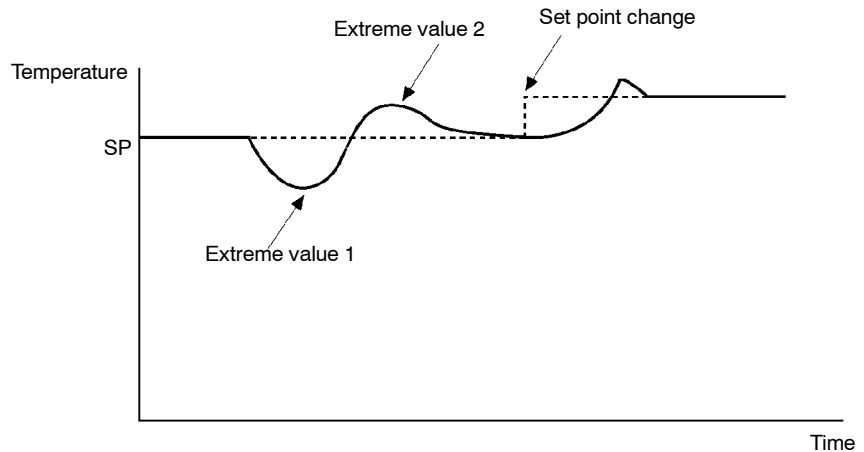

● Startup Conditions of HT

HT will be ON when there is hunting with four or more maximum temperature values (extreme values) while SRT is not being executed.

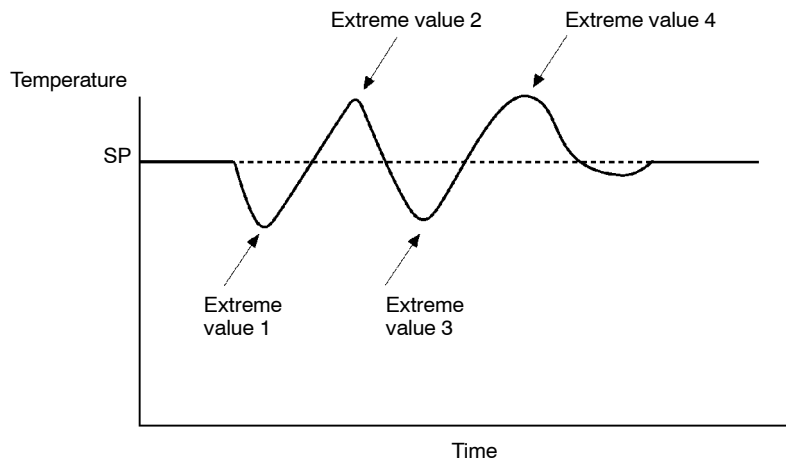

Note: In specific applications where temperature varies periodically due to disturbance, internal parameters need to be adjusted.

X FORMAT

The E5EK controller supports communications in the X format. Some of the data, such as unit, may differ with the E5AX/EX series. For details on commands and setting range, see Chapter 5 Parameters and Chapter 6 Using the Communications Function.

Format

Commands are structured as follows and are paired with a response.

Command

	2B	2B	2B	4 to 8B	2B	2B
@	Unit No.	Header code	Data code	Data	FCS	* CR

Response

	2B	2B	2B	4 to 8B	2B	2B
@	Unit No.	Header code	End code	Data	FCS	* CR

- “@”
The start character. This character must be inserted before the leading byte.
- Unit No.
Specifies the “unit No.” of the E5EK. If there are two or more transmission destinations, specify the desired destination using “unit No.”
- Header code/Data code
Specifies the command type. For details on the command type, see page A-18.
- Data
Specifies the set value or setting content. The data length varies according to the command.
- End code
Sets the communication results. For details on the types and meanings of end codes, see 6.5 How to Read Communications Error Information (page 6-12).
- FCS (Frame Check Sequence)
Set the frame check results from the start character to the data section. For details on the frame check, see 6.6 Program Example (page 6-14).
- “*” “CR (Carriage Return) code”
Indicates the end (terminator) of the command or response block.

■ X FORMAT HEAD LIST

Header Code	Data Code	Command Content	R/W	Data	Remarks
AP	01	AT cancel	Write	None	
AS	01	AT start	Write	None	
IC	-	Undefined error	-	None	Error response
MB	01	Remote/Local	Write	4B	
MA	01	RAM write mode	Write	None	
ME	01	Backup mode			
MW	01	RAM data batch save			
R%	01	Alarm value 1 read	Read	4B	
	02	Alarm value 2 read			
	03	Alarm value 3 read			
RB	01	Proportional band read			
RN	01	Integrated time read			
RV	01	Derivative time read			
RC	01	Cooling coefficient read	Read	4B	During heating and cooling control
RD	01	Dead band read			
RI	01	Input shift upper limit read	Read	4B	
	02	Input shift lower limit read			
RL	01	SP setting limit read	Read	8B	Upper-and lower-limit batch read
RO	01	Manipulated variable read	Read	4B	
RS	01	Set point read			
RX	01	Process value read	Read	8B	with status
RW	01	Heater burnout set value read	Read	4B	
RZ	01	Heater current read	Read	8B	with status
Rb	01	Valve opening read			
W%	01	Alarm value 1 write	Write	4B	
	02	Alarm value 2 write			
	03	Alarm value 3 write			
WB	01	Proportional band write			
WN	01	Integrated time write			
WV	01	Derivative time write			
WC	01	Cooling coefficient write	Write	4B	During heating and cooling control
WD	01	Dead band write			
WI	01	Input shift upper limit write	Write	4B	
	02	Input shift lower limit write			
WS	01	Set point write			
WW	01	Heater burnout set value write			

● RX (process value read) command status

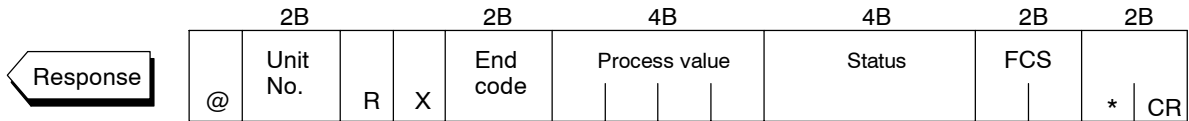
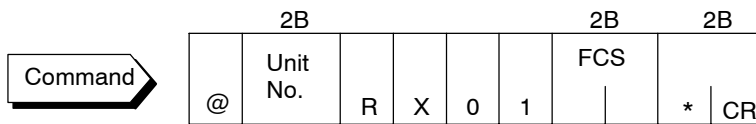

Bit	Content	"1"	"0"
0	Run/Stop	Stop	Run
1	Setting level	1	0
2	Input error	ON	OFF
3	A/D converter error	ON	OFF
4	LBA	ON	OFF
5	HBA	ON	OFF
6			
7	EEPROM	RAM≠EEPROM	RAM=EEPROM
8	Alarm 1	ON	OFF
9	Alarm 2	ON	OFF
10	Alarm 3	ON	OFF
11	AT	AT execution	OFF
12	RAM mode	RAM mode	Backup mode
13	Auto/Manual	Manual	Auto
14	SP mode	Remote SP	Local SP
15	Remote/Local	Remote	Local

ASCII CODE LIST

Hex		0	1	2	3	4	5	6	7	Upper 4 bits
	Bin	0000	0001	0010	0011	0100	0101	0110	0111	
0	0000			SP	0	@	P		p	
1	0001			!	1	A	Q	a	q	
2	0010			"	2	B	R	b	r	
3	0011			#	3	C	S	c	s	
4	0100			\$	4	D	T	d	t	
5	0101			%	5	E	U	e	u	
6	0110			&	6	F	V	f	v	
7	0111			'	7	G	W	g	w	
8	1000			(8	H	X	h	x	
9	1001)	9	I	Y	i	y	
A	1010			*	:	J	Z	j	z	
B	1011			+	;	K	[k	{	
C	1100			,	<	L	¥	l		
D	1101			-	=	M]	m	}	
E	1110			.	>	N	^	n	~	
F	1111			/	?	O	_	o	DEL	

Lower 4 bits

Symbols

- [A/M] key protect 5-4
- °C/°F selection 5-28

Numbers

- 100%AT 3-16
- 40%AT 3-16

A

- A group 6-11
- A/D converter error 3-6, 8-3, 8-5
- A/M key 1-3
- A/M key protect 3-12
- About Calibration 1-11
- ABOUT CURRENT TRANSFORMER (CT) A-5
- About invalid parameters 6-7
- About parameter display 5-2
- About PID Parameters 3-17
- About the Communications
 - Function 1-10
- About the Decimal Point of the Alarm Value 3-11
- About the displays 1-3
- About the power blocks 2-10
- About the temperature unit 3-4
- About the unit No. 6-12
- Adjusting Control Operation 3-14
- Alarm 1 hysteresis 5-24
- Alarm 1 open in alarm 5-31
- Alarm 1 type 5-30
- Alarm 2 hysteresis 5-24
- Alarm 2 open in alarm 5-31
- Alarm 2 type 5-30
- Alarm 3 hysteresis 5-24
- Alarm 3 open in alarm 5-31
- Alarm 3 type 5-30
- Alarm hysteresis 3-10
- Alarm type 3-9
- Alarm value 3-9
- Alarm value 1 5-12
- Alarm value 2 5-12
- Alarm value 3 5-12
- Alfa 5-34
- ASCII CODE LIST A-20
- Assignment example 4-9
- AT calculated gain 5-35
- AT Execute/Cancel 5-11
- AT hysteresis 5-36
- Auto-tuning (A.T.) 3-16
- Auto-tuning key 1-3

- Auto/Manual 4-10
- Automatic return of display mode 5-36
- Auxiliary output 2-10
- Auxiliary output 1 assignment 5-29
- Auxiliary output 2 assignment 5-29

B

- B group 6-11
- Balance-less, Bump-less Operation .. 3-14
- Balanced Status A-15
- Basic Operation Flow 3-2
- Before setup 2-3, 2-4

C

- Cable connections 6-3
- Calibrating Current Input 7-9
- Calibrating inputs 1-11
- Calibrating Platinum Resistance Thermometer 7-7
- Calibrating Thermocouple 7-4
- Calibrating transfer output 1-11
- Calibrating Voltage Input 7-10
- Calibration 7-7, 7-9
- Calibration : 0 to 10V 7-11
- Calibration data error 8-4
- Calibration item menu 7-3
- Calibration Mode 1-8, 1-9, 5-46
- Calibration save mark 7-3
- Calibration: 0 to 5 V, 1 to 5 V 7-10
- Calibration: thermocouple 1 7-5
- Calibration: thermocouple 2 7-6
- Changing the set point 3-14
- Characteristics A-3
- Checking Indication Accuracy 7-12
- Checking Operation Restrictions 8-6
- Close in alarm/open in alarm 3-10
- Command A-17
- Command Configuration 6-5
- Command List 6-10
- Commands and Responses 6-6
- Communication baud rate 5-40
- Communication data length 5-40
- Communication parity 5-40
- Communication stop bit 5-40
- Communication unit No. 5-40
- Communications 2-11
- Communications parameters 6-4
- Conditions when running a program .. 6-14
- Connecting the Cold Junction Conductor 7-4
- CONTROL BLOCK DIAGRAM A-6
- Control output 2-9

- Control output 1 assignment 5-28
 - Control output 2 assignment 5-28
 - Control period 3-7
 - Control period (cool) 5-16
 - Control period (heat) 5-16
 - Convention Used in this Chapter 3-2
 - Conventions Used in this Chapter 5-2
 - Cooling coefficient 4-2, 5-13
 - CT input/Potentiometer 1-4, 2-10
 - Current input 1-4, 7-13
- D**
- Dead band 4-2, 5-14
 - Decimal point 5-27
 - Derivative time 5-13
 - Determining the LBA detection time .. 4-16
 - Dimensions 2-5, A-5
 - Direct/Reverse operation 3-7, 5-31
 - Display range over 8-4
 - Down key 1-3
 - Draw-out 2-2
- E**
- Event input 1-5, 2-11
 - Event input assignment 1 5-39
 - Event input assignment 2 5-39
 - Examples of use 4-14, 6-16
 - Expansion Mode 1-7, 1-9, 5-32
- F**
- Features A-14
 - Fixing Screw for Front Panel 2-2
 - Fixing settings 1-9
 - Format A-17
 - Front panel 1-2
 - FUZZY SELF-TUNING A-14
 - Fuzzy Self-tuning Function A-14
- H**
- HBA latch 5-42
 - HBA latch/release 4-13
 - Heater burnout 5-17
 - Heater burnout detection 4-13
 - Heater current monitor 5-17
 - Heating and cooling control 4-2
 - Heter Burnout Alarm A-3
 - How to calculate the heater burnout
set value 4-14
 - How to Read Communications
Error Information 6-12
 - How to Use Error Output 8-5
 - How to Use Event Input 4-8
 - How to use keys 1-3
 - How to use programs 6-14
 - How to Use the Error Display 8-3
 - How to Use the Heater
Burnout Alarm 4-13
 - How to Use the Remote SP 4-11
 - How to Use Transfer Output 4-17
 - Hysteresis 4-4
 - Hysteresis (cool) 5-15
 - Hysteresis (heat) 5-15
- I**
- Initial Checks 8-2
 - Input and Output 1-4
 - Input assignments 4-8
 - Input digital filter 5-23
 - Input error 3-6, 8-3
 - Input errors 8-5
 - Input shift 3-4
 - Input shift lower limit 5-24
 - Input shift upper limit 5-24
 - Input type 3-4, 5-26
 - Installation 2-5
 - Integral time 5-13
 - Interface 6-2
 - Issuing special commands 6-10
- L**
- LBA 4-15, 8-5
 - LBA detection example 4-15
 - LBA detection time 4-15, 5-21
 - LBA detection width 4-15, 5-36
 - Level 0 Mode 1-7, 1-8, 5-6
 - Level 1 Mode 1-7, 1-8, 5-10
 - Level 2 Mode 1-7, 1-8, 5-18
 - Limiter operation conditions 4-6
- M**
- Main parts 1-2
 - Manipulated variable at stop 3-13, 4-2
 - Manipulated variable at
stop/PV error 4-3
 - Manipulated variable restrictions 4-5
 - Manual Mode 1-7, 1-9, 5-5
 - Manual MV 5-5
 - Manual operation 3-14
 - Manual reset value 5-15
 - Memory error 8-3
 - Menu display 1-8
 - MODEL LIST A-11
 - Monitor process value 6-16

- Motor Calibration 5-42
 - Motor calibration error 8-4
 - Mounting 2-6
 - Multi-SP 4-9
 - Multi-SP function 5-38
 - MV at PV error 5-21
 - MV at stop 5-21
 - MV change rate limit 5-22
 - MV change rate limiter 4-5
 - MV limiter 4-5
 - MV lower limit 5-22
 - MV monitor (cool) 5-8
 - MV monitor (heat) 5-8
 - MV upper limit 5-22
- N**
- Names of parts 1-2
 - No.1 display 1-3
 - No.2 display 1-3
- O**
- ON/OFF control 4-4
 - Open/close hysteresis 5-23
 - Operating Condition Restrictions 4-5
 - Operating conditions 4-12, 4-13
 - Operation at start 4-7
 - Operation indicators 1-3
 - Option Mode 1-7, 1-9, 5-37
 - Option Unit Ratings and Characteristics A-4
 - Other event input functions 4-10
 - Other functions 4-3
 - Outline 6-2
 - Outline of the Communications Function 6-2
 - Output assignments 1-5, 3-6
 - Output Unit Ratings and Characteristics A-4
- P**
- Panel cutout 2-5
 - Parameter initialize 5-27
 - PARAMETER OPERATIONS LIST .. A-12
 - Parameter types 1-7
 - Parameters and Menus 1-7
 - PID / ON/OFF 5-33
 - PID Constant Refreshing Conditions . A-15
 - Platinum resistance thermometer 7-12
 - Position-proportional control 4-3
 - Position-proportional dead band 5-14
 - Position-proportional type 3-7, 3-15, A-7
- Power supply 2-8
 - Precautions when wiring 2-8
 - Preparation 7-7, 7-9, 7-10
 - Preparations 7-4
 - Preparing for Communications 6-3
 - Procedure 2-3, 2-4, 6-14
 - Program Example 6-14
 - Program list 6-15
 - Proportional band 5-13
 - Protect Mode 1-7, 1-9, 3-12, 5-3
 - PV dead band 5-43
 - PV/SP 5-6
- R**
- Ratings A-2
 - Reading parameters 6-6
 - Reading/writing parameters 6-6
 - Registering calibration data 1-11
 - Relationship with set point limiter 4-11
 - Remote SP enable 5-44
 - Remote SP input 1-4, 2-10
 - Remote SP input error 8-5
 - Remote SP lower limit 5-44
 - Remote SP monitor 4-12, 5-7
 - Remote SP upper limit 5-44
 - Remote/Local 5-19
 - Response A-17
 - Restrictions during SP ramp 4-7
 - RS-232C 1-10, 6-3
 - RS-422 1-10, 6-3
 - RS-485 1-10, 6-4
 - RSP input error 3-6
 - Run/Stop 4-10, 5-9
 - RX (process value read) command status A-19
- S**
- Scaling 3-4, 4-11
 - Scaling lower limit 5-27
 - Scaling upper limit 5-27
 - Security 3-12, 5-3
 - Selecting modes 1-8
 - Selecting parameters 1-9
 - Selecting the Control Method 4-2
 - Sensor input 2-9
 - Set point 0 5-11
 - Set point 1 5-11
 - Set point 2 5-11
 - Set point 3 5-11
 - Set point during SP ramp 5-8
 - Set point limiter 4-6
 - Set point lower limit 5-33

- Set point upper limit 5-33
 - Set the set point to "300.0" 6-16
 - Set the unit No. to "00" 6-16
 - Setting Alarm Type 3-9
 - Setting Input Specifications 3-4
 - SETTING LIST A-8
 - Setting Output Specifications 3-6
 - Setting the communications specifications 6-4
 - Setting the LBA detection time 4-16
 - Setting up 2-2
 - Setting up the option unit 2-4
 - Setting up the output unit 2-3
 - Setting up the terminal covers 2-7
 - Setup 3-3
 - Setup Mode 1-7, 1-9, 5-25
 - SP mode 4-10, 4-11, 5-19
 - SP ramp 4-6
 - SP ramp set value 5-20
 - SP ramp time unit 5-20
 - SP tracking 4-12
 - SP tracking enable 5-45
 - SPECIFICATIONS A-2
 - Specifications A-5
 - ST 5-34
 - ST stable range 5-34
 - Stable Temperature Status A-15
 - Standard type 3-6, 3-14, A-6
 - Standby sequence 3-10
 - Standby sequence reset method 5-35
 - Start running 6-16
 - Starting and Stopping Operation 3-13
 - Startup Conditions of DT A-16
 - Startup Conditions of HT A-16
 - Startup Conditions of SRT A-14
 - Structure of Parameters 7-2
 - Summary of alarm operations 3-10
 - Switching with Manual operation 4-2
- T**
- Temperature input 1-4
 - Terminal arrangement 2-8
 - The meaning of icons used in this chapter 5-2
 - Thermocouple 7-12
 - Transfer output 1-6, 2-11
 - Transfer output lower limit 5-41
 - Transfer output scaling 4-17
 - Transfer output type 4-17, 5-41
 - Transfer output upper limit 5-41
 - Transfer procedure 6-2
 - Travel Time 4-3, 5-43
- U**
- Undefined error 6-13
 - Up key 1-3
 - Using Event Input 3-13
- V**
- Valve opening monitor 4-3, 5-9
 - Voltage input 1-4, 7-13
- W**
- Wiring 2-8
 - Wiring Terminals 2-8
 - Writing parameters 6-6
- X**
- X FORMAT A-17
 - X FORMAT HEAD LIST A-18

Revision History

A manual revision code appears as a suffix to the catalog number on the front cover of the manual.

Cat. No. H085-E1-03

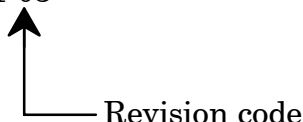

The following table outlines the changes made to the manual during each revision. Page numbers refer to previous version.

Revision code	Date	Revised content
1	July 1996	Original production
2	April 1997	<p>Page V: Changed "100 to 240 VAC" to AC100-240V ~or AC/DC24V ≈</p> <p>Page 1-6: Modified the item of "Model" on the table.</p> <p>Page 2-8: Modified the diagram in "Terminal arrangement".</p> <p>Page 2-10: Changed the power specifications in "Power supply". Deleted some texts in "CT input/Potentionmeter". Changed some texts in "Remote SP input".</p> <p>Page 3-3: Modified the diagram in "Setup".</p> <p>Page 3-8: Added "run/stop" = "run" to Setting Example.</p> <p>Page 5-8: Added "Model" and "Power specifications" to MV monitor.</p> <p>Page 5-9: Added "Model" and "Power specifications" to Valve opening monitor.</p> <p>Page 5-13: Added "Model" and "Power specifications" to Cooling coefficient.</p> <p>Page 5-14: Added "Model" and "Power specifications" to Dead band. Added "Model" and "Power specifications" to Position-proportional dead band.</p> <p>Page 5-15: Added "Model" and "Power specifications" to Manual reset value. Added "Model" and "Power specifications" to Hysteresis.</p> <p>Page 5-16: Added "Model" and "Power specifications" to Control period.</p> <p>Page 5-17: Added "Model" and "Power specifications" to Heater current monitor. Added "Model" and "Power specifications" to Heater burnout.</p> <p>Page 5-23: Added "Model" and "Power specifications" to Open/close hysteresis Model.</p> <p>Page 5-28: Added "Model" and "Power specifications" to Control output assignment.</p> <p>Page 5-33: Added "Model" and "Power specifications" to PID/ON/OFF.</p> <p>Page 5-42: Added "Model" and "Power specifications" to HBA latch. Added "Model" and "Power specifications" to Motor Calibration.</p> <p>Page 5-43: Added "Model" and "Power specifications" to Travel Time. Added "Model" and "Power specifications" to PV dead band.</p> <p>Page 6-3: Modified the diagram in "RS-232C".</p> <p>Page 7-4: Modified the diagram in "Preparations".</p> <p>Page 7-7: Modified the diagram in "Preparation".</p> <p>Page 7-9: Modified the diagram in "Preparation".</p> <p>Page 7-10: Modified the diagram in "Preparation".</p> <p>Page 7-12: Modified the diagram in "Thermocouple". Modified the diagram in "Platinum resistance thermometer".</p> <p>Page 7-13: Modified the diagram in "Current input". Modified the diagram in "Voltage input".</p> <p>Page 8-4: Added "Motor calibration error".</p> <p>Page A-2: Modified "Ratings specifications".</p> <p>Page A-11: Changed "Type Name" and "Specification" in Base unit.</p> <p>Page A-14: Deleted 2) of "At the time the E5EK starts operation" in "Startup Conditions of SRT". Deleted 2) of "At the time set point is changed".</p> <p>Page A-15: Deleted "Imposition Completion Condition of Step Control Amount". Modified the diagram in "PID Constant Refreshing Conditions".</p>
02A	March 2005	Page A-3: Added information to table and accompanying notes.
03	June 2010	Page A-8: Changed "%" or "%FS" for hysteresis parameters at bottom of table.

OMRON Corporation Industrial Automation Company

Tokyo, JAPAN

Contact: www.ia.omron.com

Regional Headquarters

OMRON EUROPE B.V.

Wegalaan 67-69-2132 JD Hoofddorp
The Netherlands

Tel: (31)2356-81-300/Fax: (31)2356-81-388

OMRON ELECTRONICS LLC

One Commerce Drive Schaumburg,
IL 60173-5302 U.S.A.

Tel: (1) 847-843-7900/Fax: (1) 847-843-7787

OMRON ASIA PACIFIC PTE. LTD.

No. 438A Alexandra Road # 05-05/08 (Lobby 2),
Alexandra Technopark,
Singapore 119967

Tel: (65) 6835-3011/Fax: (65) 6835-2711

OMRON (CHINA) CO., LTD.

Room 2211, Bank of China Tower,
200 Yin Cheng Zhong Road,
PuDong New Area, Shanghai, 200120, China

Tel: (86) 21-5037-2222/Fax: (86) 21-5037-2200

Authorized Distributor:

© OMRON Corporation 1996 All Rights Reserved.
In the interest of product improvement,
specifications are subject to change without notice.

Cat. No. H085-E1-03

Printed in Japan

0610