

# ENGLISH

## User manual



Quality HT Products Online at:

[www.GlobalTestSupply.com](http://www.GlobalTestSupply.com)

[sales@GlobalTestSupply.com](mailto:sales@GlobalTestSupply.com)

**Contents:**

1	SAFETY PRECAUTIONS AND PROCEDURES .....	2
1.1	Preliminary .....	2
1.2	Before use .....	3
1.3	After use .....	3
1.4	Measuring (overvoltage) categories definitions .....	3
2	GENERAL DESCRIPTION .....	4
2.1	TRMS and Mean Value measuring instruments .....	4
2.2	True Root Mean Square value and crest factor definitions .....	4
3	PREPARATION FOR USE .....	5
3.1	Initial .....	5
3.2	Power supply .....	5
3.3	Calibration .....	5
3.4	Storage .....	5
4	OPERATING INSTRUCTIONS .....	6
4.1	Instrument description .....	6
4.1.1	Commands description .....	6
4.1.2	Alignment marks .....	6
4.2	Function key description .....	7
4.2.1	HOLD key .....	7
4.2.2	☺ key .....	7
4.2.3	RANGE key .....	7
4.2.4	MAX key .....	7
4.2.5	MODE key .....	7
4.3	Functions of rotary switch description .....	8
4.3.1	DC Voltage measurement .....	8
4.3.2	AC Voltage measurement .....	9
4.3.3	AC Current measurement .....	10
4.3.4	Resistance measurement .....	11
4.3.5	Continuity test and Diode test .....	12
5	MAINTENANCE .....	13
5.1	General informations .....	13
5.2	Battery replacement .....	13
5.3	Cleaning .....	13
5.4	End of life .....	13
6	TECHNICAL SPECIFICATIONS .....	14
6.1	Characteristics .....	14
6.1.1	Safety .....	15
6.1.2	General data .....	15
6.2	Environmental conditions .....	15
6.2.1	Climatic conditions .....	15
6.3	Accessories .....	15
6.3.1	Standard accessories .....	15
7	SERVICE .....	16
7.1	Warranty conditions .....	16
7.2	Service .....	16

## 1 SAFETY PRECAUTIONS AND PROCEDURES

This clamp complies with IEC/EN61010-1. For your own safety and in order to avoid damaging the instrument, you're recommended to keep to the instructions contained in this manual and read carefully all the notes preceded by the symbol .

Take extreme care for the following conditions while measuring:

- Do not measure voltage or current in humid or wet environment
- Do not use the meter in presence of explosive gas (material), combustible gas (material), steam or dust
- Insulate yourself from the object to be tested
- Do not touch exposed metal (conductive) parts such as test lead ends, sockets, fixing objects, circuits, etc
- If you detect anomalies of testing end (metal part) and attachment of the meter such as breakages, deformations, foreign substances, no display, etc., do not take any measurement
- Measuring voltage over 20V as it might cause human body electricity conduction

The followings symbols are used:



Caution: refer to the instruction manual. An incorrect use may damage the tester or its components



High Voltage ranger: electrical shock risk



Double insulated instrument



AC Voltage or Current



DC Voltage



Ground reference

### 1.1 PRELIMINARY

- This apparatus has been designed for use in an environment of pollution degree 2. Indoor use
- It measures **CURRENT** and **VOLTAGE** on CAT IV 600V to ground plants. For overvoltage categories please see § 1.4
- You must comply with the usual safety regulations aimed at protecting you against the dangerous electric current and protecting the instrument against an incorrect operation
- Only the leads supplied with the instrument guarantee compliance with the safety standard. They must be in good conditions and they must be replaced, if necessary, with an identical model
- Do not test or connect to any circuit whose voltage or current exceeds the specified overload protection
- Do not perform any test at environmental conditions exceeding the limits indicated
- Make sure that the battery are installed correctly
- Before connecting the test probes to the installation, check that the function selector is positioned on the required measurement

## 1.2 BEFORE USE

Always keep to the instructions contained in this manual:



### CAUTION

Non compliance with the warnings and/or the instructions may damage the tester and/or its components or injure the operator.

- Before changing the switch's position, take off the clamp jaw from the tested conductor or the electrical circuit in order to avoid any accident
- When the clamp is connected to the circuits to be tested, never touch unused terminals
- When testing resistors, do not add voltage. Although there is a protection circuit, excessive voltage would cause malfunctioning
- Before measuring current, remove the voltage-resistance test leads
- When measuring current, any strong current near or close to the clamp jaw will affect the accuracy
- When measuring current, always put the tested conductor in the middle of the clamp jaw in order to obtain a more accurate reading
- If the reading value or the sign indication remains unchanged during the measurement, check if the HOLD function is active

## 1.3 AFTER USE

- Once the measurements are completed, turn the rotary switch to OFF
- If you expect not to use the clamp for a long time, remove the battery

## 1.4 MEASURING (OVERVOLTAGE) CATEGORIES DEFINITIONS

The norm IEC/EN61010-1: Safety requirements for electrical equipment for measurement, control and laboratory use, Part 1: General requirements, defines what measuring category, usually called overvoltage category, is. On § 6.7.4: Measuring circuits, it says:

(OMISSIS)

circuits are divided into the following measurement categories:

- **Measurement category IV** is for measurements performed at the source of the low-voltage installation  
*Examples are electricity meters and measurements on primary overcurrent protection devices and ripple control units*
- **Measurement category III** is for measurements performed in the building installation  
*Examples are measurements on distribution boards, circuit breakers, wiring, including cables, bus-bars, junction boxes, switches, socket-outlets in the fixed installation, and equipment for industrial use and some other equipment, for example, stationary motors with permanent connection to fixed installation*
- **Measurement category II** is for measurements performed on circuits directly connected to the low voltage installation  
*Examples are measurements on household appliances, portable tools and similar equipment*
- **Measurement category I** is for measurements performed on circuits not directly connected to MAINS  
*Examples are measurements on circuits not derived from MAINS, and specially protected (internal) MAINS-derived circuits. In the latter case, transient stresses are variable; for that reason, the norm requires that the transient withstand capability of the*

## 2 GENERAL DESCRIPTION

HT9012 meter can performs the herewith measurements:

- DC and AC voltage
- Detection of AC voltage without contact
- AC current
- Resistance and test continuity
- Diode test

Each parameter can be selected by rotating the 8-positions switch included OFF position. To abilitate the hold function the **HOLD** key is available. There are also  key to activate/desactivate the display backlight, the **RANGE** key for manual selction of measurement ranges, the **MAX** key for maximum value measurement of some parameters and the **MODE** key for the selection of different features common at the same position of selector rotation. The selected quantity appears on a high-contrast liquid crystal display with indication of measurement units and functions. The instrument disposes of an Auto Power Off function consisting in an automatic switching off 15 minutes after last selector rotation.

### 2.1 TRMS AND MEAN VALUE MEASURING INSTRUMENTS

Safety testers for alternate quantities are divided into two big families:

- MEAN VALUE instruments: instruments which measure only the value of the wave at the fundamental frequency (50 or 60 Hz)
- TRUE ROOT MEAN SQUARE instruments, also defined as TRMS: instruments which measure the true root mean square value of the quantity under test

In presence of a perfectly sinusoidal wave, both families provide identical results. In presence of distorted waves, instead, the readings are different. Mean value instruments provide only the value of the fundamental wave while True RMS instruments provide the value of the entire wave, including harmonics (within the passband of the instrument). Accordingly, if the same quantity is measured with both kinds of instruments, the measured values are identical only if the wave is purely sinusoidal. Should it be distorted, True RMS instruments provide higher values than medium value instruments.

### 2.2 TRUE ROOT MEAN SQUARE VALUE AND CREST FACTOR DEFINITIONS

The current effective value is defined as follows: “In an interval of time equivalent to a period, an alternate current with effective value having an intensity of 1A, by passing on a resistor, disperses the same energy which would be dispersed in the same period of time by a direct current having an intensity of 1A”. From this definition comes the numerical

expression:  $G = \sqrt{\frac{1}{T} \int_{t_0}^{t_0+T} g^2(t) dt}$  The effective value is indicated as RMS (*root mean square*).

The Crest Factor is defined as the ratio between the Peak Value of a signal and its effective value:  $CF (G) = \frac{G_p}{G_{RMS}}$ . This value varies according to the waveform of the signal,

for a purely sinusoidal wave it's worth  $\sqrt{2} = 1.41$ . In presence of distortions the Crest Factor assumes higher values as long as the wave distortion is higher.

### 3 PREPARATION FOR USE

#### 3.1 INITIAL

The tester has been checked from a mechanical and electrical point of view before shipment.

Every care has been taken to make sure that the instrument reaches you in perfect conditions.

However, it's advisable to make a rapid check in order to detect eventual damages which may have occurred in transit. Should this be the case, enter immediately the usual claims with the carrier.

Make sure that all the accessories listed in § 6.3.1 are contained in the package. In case of discrepancies contact the dealer.

In case of returning of the tester please keep to the instructions given in § 7.

#### 3.2 POWER SUPPLY

The instrument is battery supplied. One battery 9V IEC 1604 NEDA 6F22 are included in the package. When battery is low, the symbol “” appears on the display. Replace it immediately, following the instructions given in § 5.2.

The instrument disposes of the Auto Power OFF function (not disable) consisting in an automatic switching off 15 minutes of idleness.

#### 3.3 CALIBRATION

The tester complies with the technical features listed in this manual. Its performances are guaranteed for one year.

#### 3.4 STORAGE

In order to guarantee the accuracy of the measurements, after a period of storage in extreme environmental condition, wait for the necessary time so that the tester returns to normal measuring conditions (see environmental specifications, § 6.2.1).

## 4 OPERATING INSTRUCTIONS

### 4.1 INSTRUMENT DESCRIPTION

#### 4.1.1 Commands description

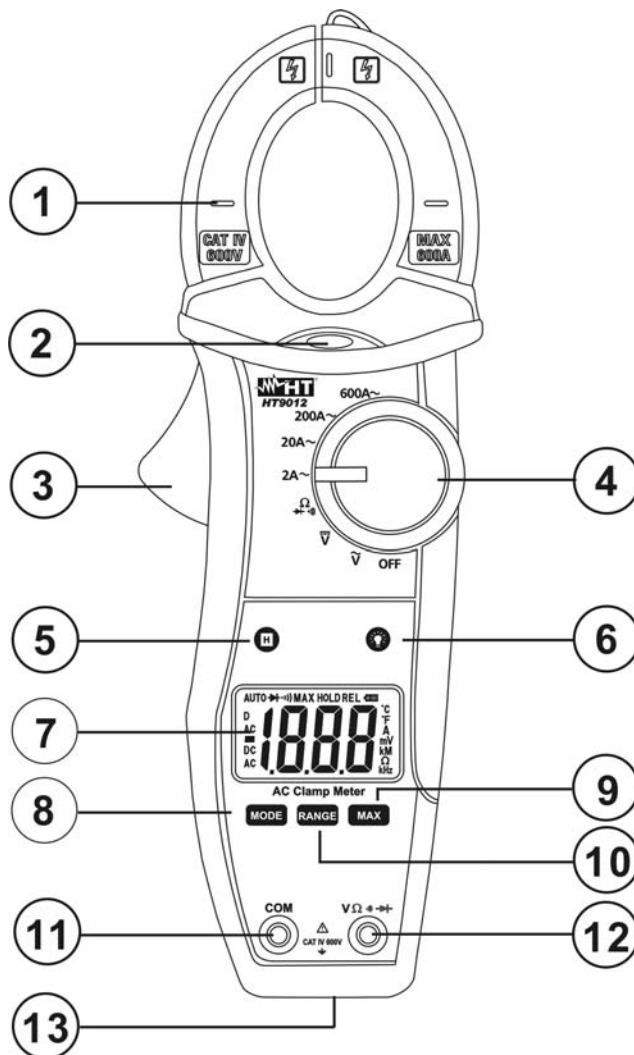

#### LEGEND:

1. Clamp jaw
2. Red LED for AC voltage detection without contact
3. Clamp trigger
4. Rotary function selector
5. **HOLD** key
6. backlight key
7. LCD display
8. **MODE** key
9. **MAX** key
10. **RANGE** key
11. **COM** input jack
12. **VΩ** input jack
13. Battery cover

Fig. 1: Instrument description

#### 4.1.2 Alignment marks

Put the conductor within the jaws on intersection of the indicated marks as much as possible (see Fig. 2) in order to meet the meter accuracy specifications

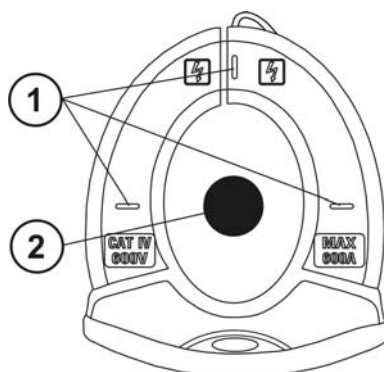

#### LEGEND

1. Alignment marks
2. Conductor



Fig. 2: Alignment marks

## 4.2 FUNCTION KEY DESCRIPTION

### 4.2.1 HOLD key

By pushing **HOLD** key the parameter's measured value is frozen on the display and the symbol "HOLD" appears on it. Pushing **HOLD** key another time deactivates this mode.

### 4.2.2 key

By pushing and hold  key for about 1s it's possible to activate the backlight function on the display. By pressing and hold  key again for about 3s to exit from the function or waiting the automatically disable after about 20 seconds. The function is available on each position of the rotary selector.

### 4.2.3 RANGE key

By pushing **RANGE** key, the manual mode is activated and the "AUTO" symbol disappears from the display. Press **RANGE** cyclically to change the measuring range and fix the decimal point on the display. For reading more than the maximum range the "OL" indication is shown at display. To exit this function keep **RANGE** key pressed for at least 1 second or rotate the selector to another position. This feature is disabled for AC current diode test and continuity test measurements.

### 4.2.4 MAX key

By pushing **MAX** key, maximum value are measured. The symbol corresponding "MAX" is displayed. This value is stored and automatically updated as soon as an higher value is measured by meter. Press **MAX** key again or rotate the selector to another position to exit from this function. This feature is disabled for resistance, diode test and continuity test measurements.

### 4.2.5 MODE key

By pushing **MODE** key the selection of a double measured functions which are present at display is possible. In particular this key is active only in  $\Omega \rightarrow (+/-)$  position to select among resistance test, diode test and continuity test.



## 4.3 FUNCTIONS OF ROTARY SWITCH DESCRIPTION

### 4.3.1 DC Voltage measurement



#### CAUTION

Maximum input for AC Voltage measurements is 1000VDC or 1000VACrms. Do not take any voltage measurement exceeding this limit in order not to risk electrical shock or damaging the meter.

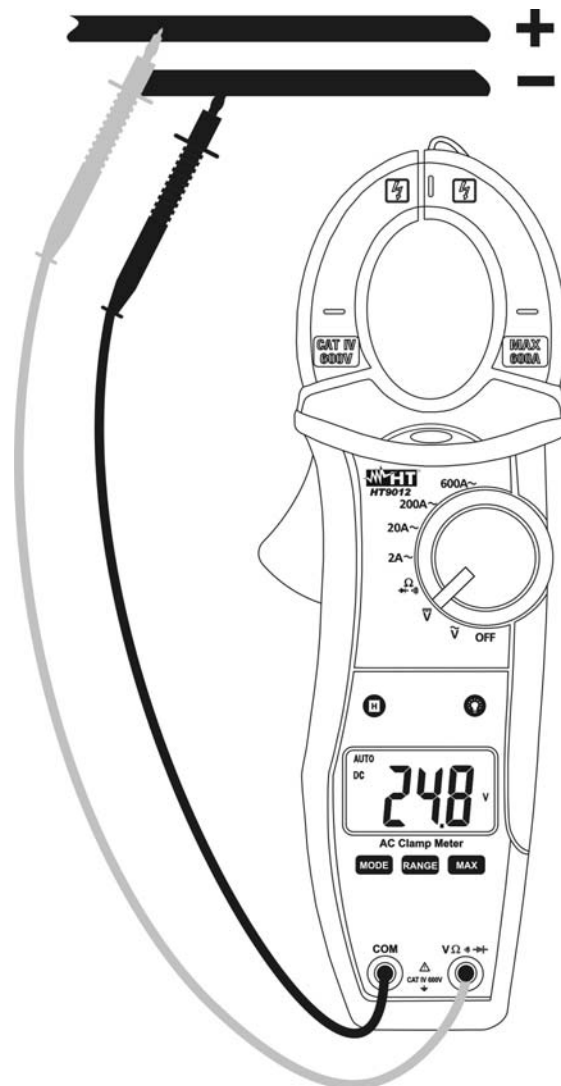

Fig. 3: Taking DC voltage measurement

1. Rotate the switch on **V $\overline{\text{—}}$**  position. The “DC” symbol is shown at display
2. Pressing the **RANGE** key to select the correct range or using the Autorange feature (see § 4.2.3). If the voltage value under test is unknown, select the highest range
3. Insert the red test lead plug into **V $\Omega$**  jack and the black test lead plug into **COM** jack
4. Connect the two long ends of test leads to the desired circuit (see Fig. 3) then reading will be displayed
5. “**OL**” message is shown at display if the DC voltage under test is over the maximum value that the instrument is able to measure
6. The “-” symbol at display means that the voltage have an opposite sign respect the connection of Fig. 3)
7. For HOLD and MAX features please refer to § 4.2

### 4.3.2 AC Voltage measurement



#### CAUTION

Maximum input for AC Voltage measurements is 1000VDC or 1000VACrms. Do not take any voltage measurement exceeding this limit in order not to risk electrical shock or damaging the meter.



Fig. 4: Taking AC voltage measurement

1. Approach the meter closest to AC source and note the turn on of red LED which is placed to the bottom of clamp jaws (see Fig. 1 – part 2) which detect the AC voltage
2. Rotate the switch on  $V \sim$  position. The “AC” symbol is shown at display
3. Pressing the **RANGE** key to select the correct range or using the Autorange feature (see § 4.2.3). If the voltage value under test is unknown, select the highest range
4. Insert the red test lead plug into  $V \Omega \rightarrow \leftarrow$  jack and the black test lead plug into **COM** jack (see Fig. 4)
5. Connect the two long ends of test leads to the desired circuit (see Fig. 4) then reading will be displayed
6. “OL” message is shown at display if the AC voltage under test is over the maximum value that the instrument is able to measure

### 4.3.3 AC Current measurement



#### CAUTION

Make sure that all the test leads are disconnected from the meter terminals for current measurement.

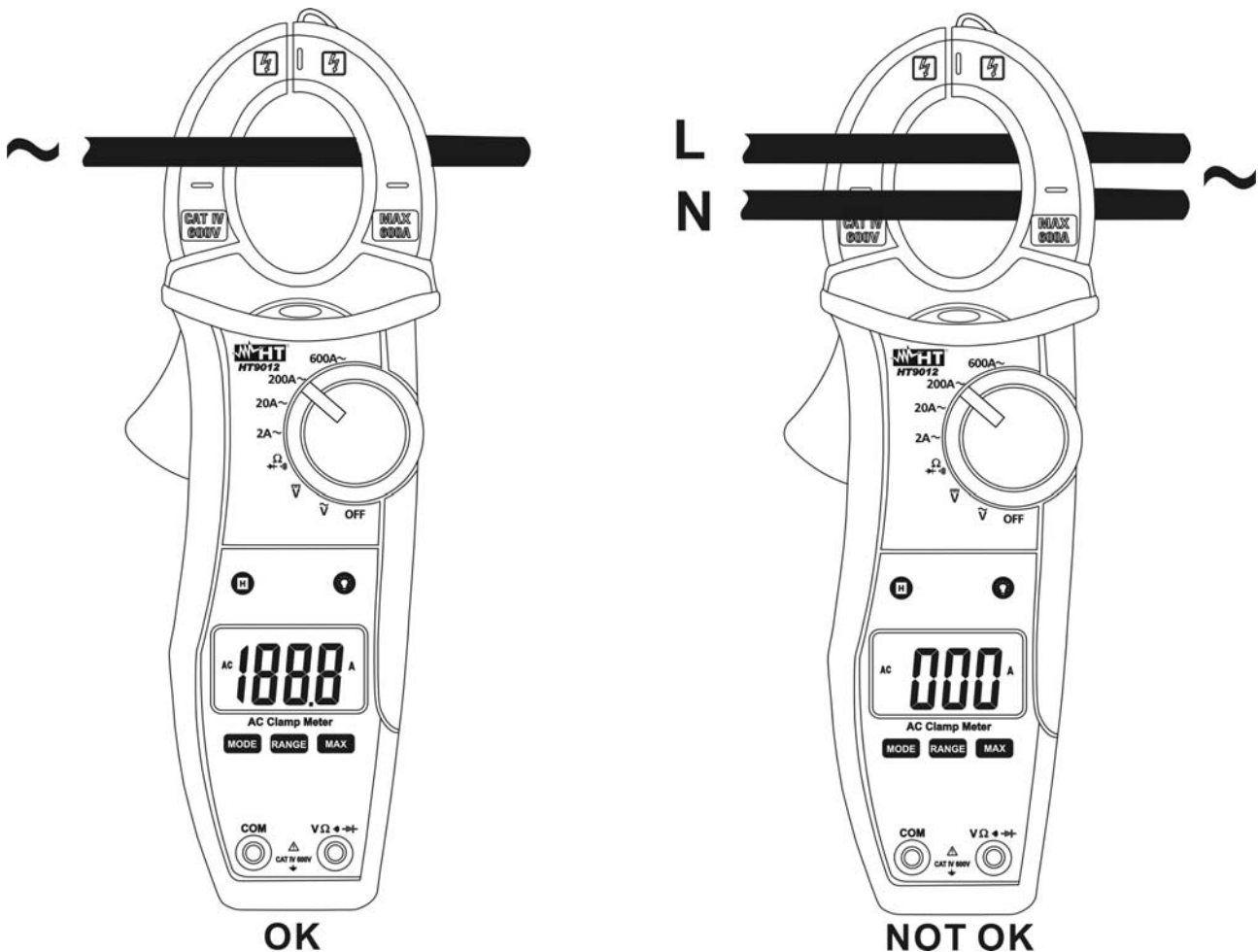

Fig. 5: Taking AC current measurement

1. Approach the meter closest to AC source. The turn on of red LED which is placed to the bottom of clamp jaws (see Fig. 1 – part 2) detect the AC voltage
2. Rotate the switch on position on a measurement range between **2A~** and **600A~**. If the current value under test is unknown, select the highest range
3. Put the conductor to be tested inside to the center of clamp jaw to perform accurated measurements. Consider the notches on jaws as reference (see Fig. 2). The current value is shown at display
4. “**OL**” message is shown at display the current under test is over the maximum value that the instrument is able to measure
5. For HOLD and MAX functions please refer to § 4.2

#### 4.3.4 Resistance measurement



### CAUTION

Before taking any in circuit resistance measurement, remove power from the circuit to be tested and discharge all the capacitors.

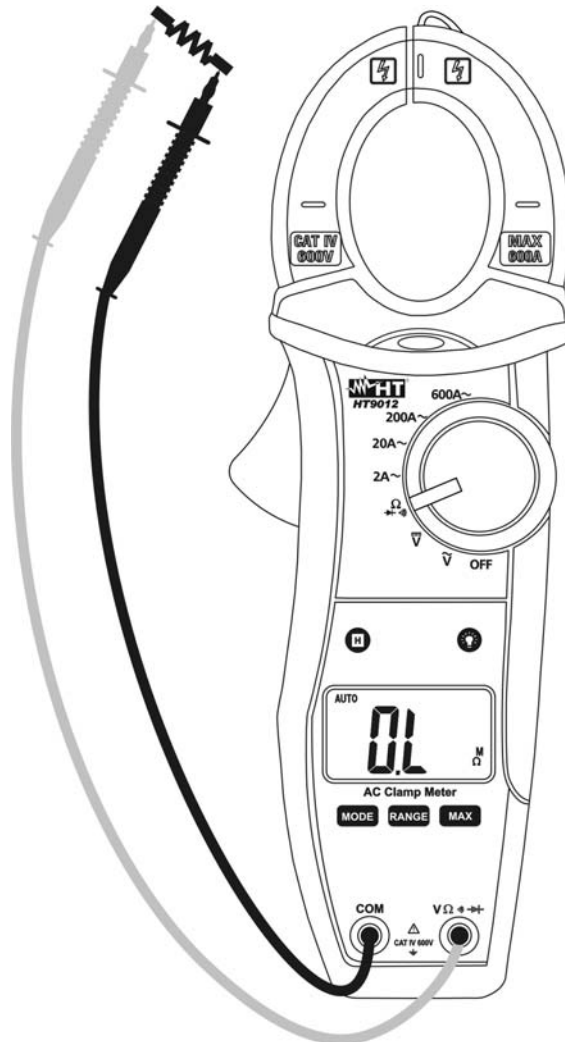

Fig. 6: Taking resistance measurement

1. Rotate the switch on  $\Omega$  position. The “ $\Omega$ ” symbol is shown at display
2. Pressing the **RANGE** key to select the correct range or using the Autorange feature (see § 4.2.3). If the resistance value under test is unknown, select the highest range
3. Insert the red test lead plug into  $V\Omega$  jack and the black test lead plug into **COM** jack
4. Connect the two long ends of test leads to the desired circuit (see Fig. 6) then reading value of resistance will be displayed
5. When “**OL**” symbol is displayed, the resistance under test is over the maximum value that the instrument is able to measure
6. For HOLD function please refer to § 4.2

### 4.3.5 Continuity test and Diode test



#### CAUTION

Before taking any in circuit resistance measurement or diode test, remove power from the circuit to be tested and discharge all the capacitors.

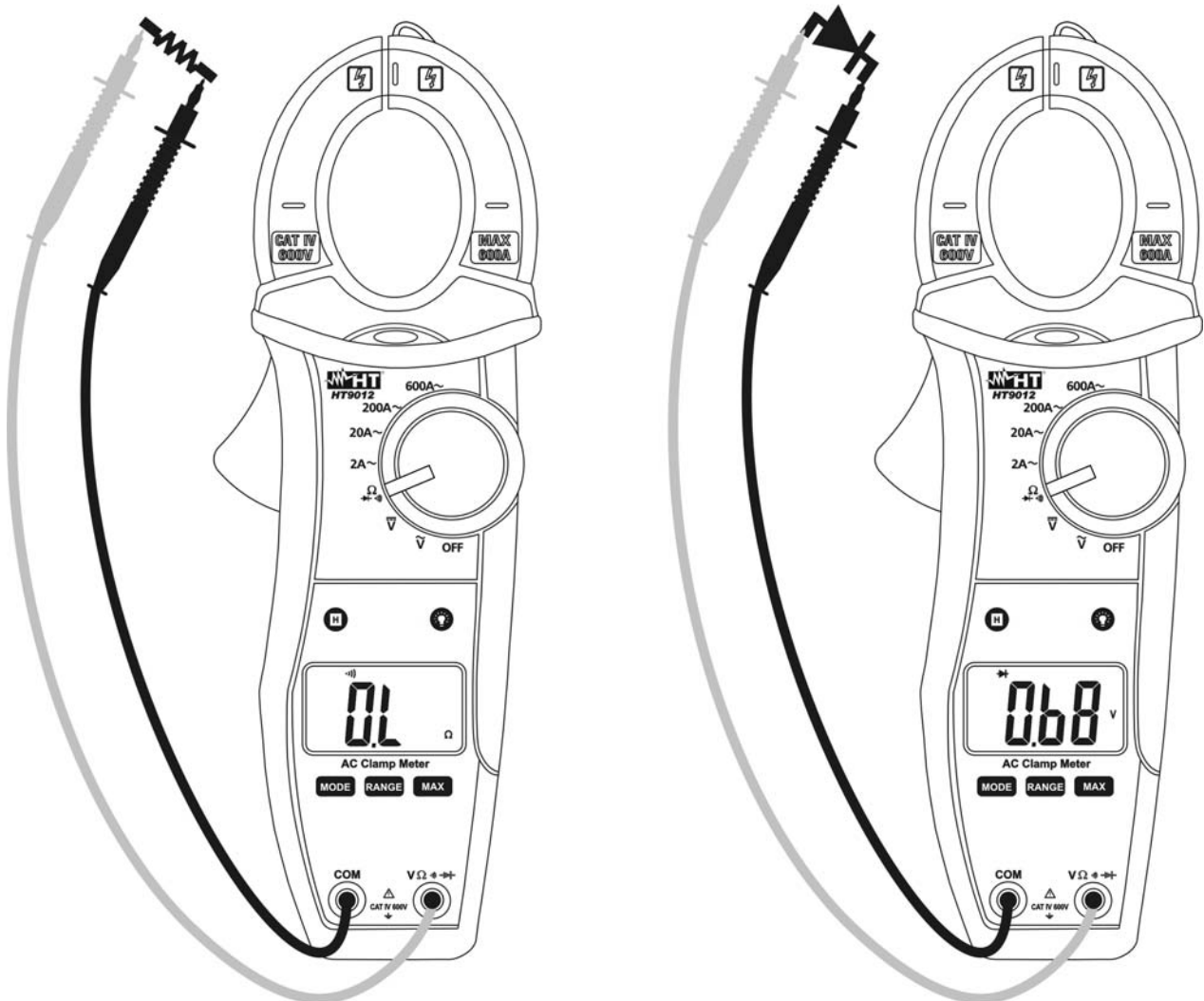

Fig. 7: Taking continuity test and diode test

1. Rotate the switch on  $\Omega \rightarrow \text{diode symbol}$  position
2. Pushing **MODE** key and select continuity test. The  $\text{diode symbol}$  symbol is shown at display
3. Insert the red test lead plug into  $V\Omega \rightarrow \text{diode symbol}$  jack and the black test lead plug into **COM** jack and perform continuity test on the object on test (see Fig. 7 – left side). Buzzer emits sound if the measured resistance value is less about  $100\Omega$
4. Pushing **MODE** key and select diode test. The  $\text{diode symbol}$  symbol is shown at display
5. Connect the red test leads to the anode of diode on test and the black test lead on the cathode ones (see Fig. 7 – right side)
6. Displayed values within 0.4V and 0.7V (direct junction) and “OL” (reverse junction) are correspondent to a correct result. A “0mV” value means a shorted device while a “OL” indication in both side means a broken device

## 5 MAINTENANCE

### 5.1 GENERAL INFORMATIONS

1. This digital clamp meter is a precision instrument. Whether in use or in storage, please do not exceed the specification requirements to avoid possible damages or dangers
2. Do not place this meter at high temperatures or humidity or expose it to direct sunlight
3. Be sure to turn off the meter after use. If you expect not to use the tester for a long time, remove the battery in order to avoid leakages of battery liquid that would damage the internal parts

### 5.2 BATTERY REPLACEMENT

When “” symbol appears on the display, replace the battery



#### CAUTION

Only expert and trained technicians must perform this operation. Remove the test leads or the conductor under test before replacing the battery.

1. Rotate the switch on OFF
2. Remove the test leads or the objects to be tested
3. Remove the screw from the battery cover, and detach the battery cover from the bottom cover
4. Remove the battery
5. Replace the battery with a same type new one
6. Replace the battery cover and screw
7. Use the appropriate battery disposal methods for Yr area

### 5.3 CLEANING

For cleaning the instrument use a soft dry cloth. Never use a wet cloth, solvents or water, etc.

### 5.4 END OF LIFE



**CAUTION:** this symbol indicates that equipment, battery and its accessories shall be subject to a separate collection and correct disposal.



## 6 TECHNICAL SPECIFICATIONS

### 6.1 CHARACTERISTICS

Accuracy is calculated as [% rdg + (n°of dgt) \* resolution] referred to: 23°C ± 5°C <80%RH

#### DC Voltage

Range	Resolution	Accuracy	Input impedance	Overload protection
200.0mV	0.1mV	±(1.0%rdg + 3dgt)	10MΩ	1000VDC/ACrms
2.000V	0.001V			
20.00V	0.01V			
200.0V	0.1V			
1000V	1V			

The meter emits a continuous sound with VDC >1000V

#### AC Voltage

Range	Resolution	Accuracy (50 ÷ 60Hz)	Input impedance	Overload protection
200.0mV	0.1mV	±(1.5%rdg + 15dgt)	10MΩ	1000VDC/ACrms
2.000V	0.001V	±(1.0%rdg + 4dgt)		
20.00V	0.01V			
200.0V	0.1V			
1000V	1V			

Integrated sensor for AC voltage detection: LED turn on for phase-earth voltage > 100V, 50/60Hz

The meter emits a continuous sound on 1000V range for VAC>750V

#### AC Current

Range	Resolution	Accuracy (*)	Frequency range	Overload protection
2.000A	0.001A	±(2.5%rdg + 10dgt)	50÷60Hz	600Arms
20.00A	0.01A	±(2.5%rdg + 4dgt)		
200.0A	0.1A			
600A	1A	±(3.0%rdg + 4dgt)		

(\*) Referred to cable inside to the center of clamp jaws

Position sensitivity: ±2.0%rdg

#### Resistance and Continuity test

Range	Resolution	Accuracy	Buzzer	Overload protection
200.0Ω	0.1Ω	±(1.0%rdg + 5dgt)	≤100Ω	600VDC/ACrms
2.000kΩ	0.001kΩ			
20.00kΩ	0.01kΩ			
200.0kΩ	0.1kΩ			
2.000MΩ	0.001MΩ			
20.00MΩ	0.01MΩ	±(2.0%rdg + 10dgt)		

#### Diode test

Features	Test current	Open voltage
	0.3mA typical	1.5VDC

### 6.1.1 Safety

Comply with:	IEC/EN 61010-1
Insulation:	double insulation
Pollution degree:	2
For inside use, max height:	2000m (6562 ft)
Installation category:	CAT IV 600V, CAT III 1000V to ground

### 6.1.2 General data

#### Mechanical characteristics

Dimensions (L x W x H):	215 x 74 x 43mm ; 8 x 3 x 2 in
Weight (including battery):	285g (10 ounces)
Max conductor size:	30mm (1in)

#### Supply

Battery type:	1x9V alkaline battery NEDA 1604 IEC 6F22
Low battery indication:	“  ” is displayed when the battery level is too low
AutoPowerOFF	after 15min of idleness (not disabled)

#### Display

Characteristics:	3½ LCD (max 2000 points) plus decimal point, unit symbol indication and backlight
Sample rate:	2 times/sec
Conversion mode:	Mean value

## 6.2 ENVIRONMENTAL CONDITIONS

### 6.2.1 Climatic conditions

Reference temperature:	23° ± 5°C (73°F ± 41°F)
Operating temperature:	5 ÷ 40°C (41°F ÷ 104°F)
Operating humidity:	<80%RH
Storage temperature:	-20 ÷ 60 °C (-4°F ÷ 140°F)
Storage humidity:	<80%RH

**This product conforms to the prescriptions of the European directive on low voltage 2006/95/EEC and to EMC directive 2004/108/EEC**

## 6.3 ACCESSORIES

### 6.3.1 Standard accessories

The content of a standard package is the following:

- Instrument HT9012
- Test leads - Cod. 4413-2
- Carrying bag
- Battery
- User manual



## 7 SERVICE

### 7.1 WARRANTY CONDITIONS

This instrument is guaranteed against material or production defects, in accordance with our general sales conditions. During the warranty period the manufacturer reserves the right to decide either to repair or replace the product.

Should you need for any reason to return back the instrument for repair or replacement take prior agreements with the local distributor from whom you bought it. Do not forget to enclose a report describing the reasons for returning (detected fault). Use only original packaging. Any damage occurred in transit due to non original packaging will be charged anyhow to the customer.

The manufacturer will not be responsible for any damage to persons or things.

The warranty doesn't apply to:

- Accessories and batteries (not covered by warranty).
- Repairs made necessary by improper use (including adaptation to particular applications not foreseen in the instructions manual) or improper combination with incompatible accessories or equipment.
- Repairs made necessary by improper shipping material causing damages in transit.
- Repairs made necessary by previous attempts for repair carried out by non skilled or unauthorized personnel.
- Instruments for whatever reason modified by the customer himself without explicit authorization of our Technical Dept.

The contents of this manual cannot be reproduced in any form without our authorization.

**Our products are patented. Our logotypes are registered. We reserve the right to modify characteristics and prices further to technological developments.**

### 7.2 SERVICE

Shouldn't the instrument work properly, before contacting your distributor make sure that battery is correctly installed and working, check the test leads and replace them if necessary. Make sure that your operating procedure corresponds to the one described in this manual.

Should you need for any reason to return back the instrument for repair or replacement take prior agreements with the local distributor from whom you bought it. Do not forget to enclose a report describing the reasons for returning (detected fault). Use only original packaging. Any damage occurred in transit due to non original packaging will be charged anyhow to the customer.

The manufacturer will not be responsible for any damage to persons or things.