

CASIO®

Digital Camera

QV-R200

QV-R70

User's Guide

E

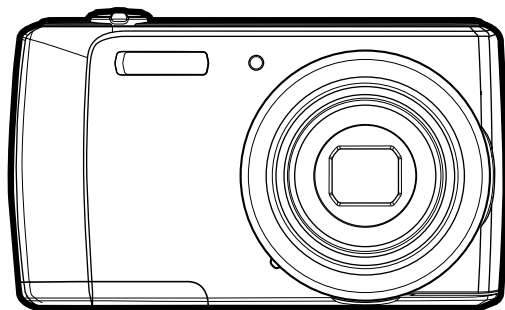

Thank you for purchasing this CASIO product.

- Before using it, be sure to read the precautions contained in this User's Guide.
- Keep the User's Guide in a safe place for future reference.
- For the most up-to-date information about this product, visit the official EXILIM Website at <http://www.exilim.com/>

[Downloaded From ManualsCamera.com](http://www.ManualsCamera.com) Manuals

Accessories

As you unpack your camera, check to make sure that all accessories shown below are included. If anything is missing, contact your original retailer.

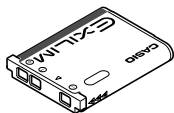

Rechargeable lithium ion
battery (NP-80)

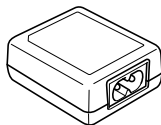

USB-AC adaptor
(AD-C53U)

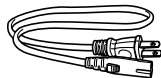

* The shape of the power
cord plug varies
according to country or
geographic area.

Power cord



Strap

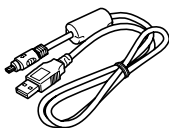

USB cable

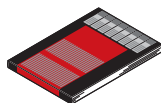

Basic Reference

Read this first!

- The contents of this manual are subject to change without notice.
- The contents of this manual have been checked at each step of the production process. Feel free to contact us if you notice anything that is questionable, erroneous, etc.
- Any copying of the contents of this User's Guide, either in part or its entirety, is forbidden. Except for your own personal use, any other use of the contents of this manual without the permission of CASIO COMPUTER CO., LTD. is forbidden under copyright laws.
- CASIO COMPUTER CO., LTD. shall not be held liable for any damages or lost profits suffered by you or any third party due to the use or malfunction of this product.
- CASIO COMPUTER CO., LTD. shall not be held liable for any damages or lost profits caused by loss of memory contents due to malfunction, repair, or any other reason.
- Note that the example screens and product illustrations shown in this User's Guide may differ somewhat from the screens and configuration of the actual camera.

LCD Panel

The liquid crystal panel of the monitor screen uses high-precision technology that provides a pixel yield of 99.99%. This means that some very small number of pixels may not light or may remain lit at all times. This is due to the characteristics of the liquid crystal panel, and does not indicate malfunction.

Take test shots

Before shooting your final image, shoot a test shot to ensure that the camera is recording correctly.

Contents

Accessories	2
Read this first!	3
Using this Manual	6
System Requirements	6
Camera Views	7
Camera Control	8
Navigation Control	9
Camera Memory	10

■ Getting Started **11**

Attach the Camera Strap	11
First, charge the battery prior to use.	11
Inserting a Memory Card	16
Turning the Power On and Off	17
Initial Settings	17
Modes	18

■ Using the LCD monitor **19**

LCD Monitor Layout	19
Changing the LCD Monitor Display	23

■ Recording Images and Videos **24**

Taking Images	24
Setting the Zoom Dial	24
Using Flash	26
Setting the Focus Mode	27
Using the Function Menu	28
Recording Videos	34
Using the Record Menu	37

■ Playback **46**

Viewing in Single Navigation	46
Viewing Thumbnails	46
Zooming Images	48
Playing Videos	48
Deleting an Image/Video	50
Playback Menu	51

■ ■ Using the Setup Menu 62

Setting Sounds	62
Setting Power Save	63
Setting LCD Save	63
Setting Date & Time	63
Setting Language	63
Setting File Numbering	64
Setting TV Out	64
Setting Memory Kit	64
Reset All	65

■ ■ Making Connections 66

Connecting the Camera to a TV	66
Connecting the Camera to a Computer	67

■ ■ Appendix 70

Precautions during Use	70
About Folder and File Names	79
Troubleshooting	81
Number of Snapshots/Movie Recording Time	83
Specifications	85

Using this Manual

Symbols used in this manual are explained below.

NOTE

- This indicates useful information when using your camera.



IMPORTANT!

- This indicates important message that should be read before using the function.

System Requirements

In order to get the most out of your camera, your computer must meet the following system requirements.

For Windows:

- Windows XP, Windows Vista, Windows 7
- Processor: Pentium II 450MHz or above
- Memory: Minimum 512MB RAM (Over 1GB recommended)
- HDD space: 200MB or above
- 24bit color display monitor
- Microsoft DirectX 9.0c
- USB port

For Macintosh:

- Power Mac G3 or later
- Mac OS 10.3.X (X=0-9) - 10.7.2
- Memory: 512MB or above
- QuickTime player ver. 6.0.3 or above
- USB port

Camera Views

Front View

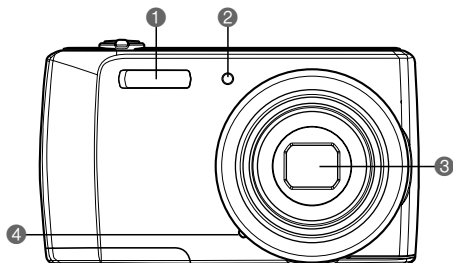

- 1 Flash
- 2 Self-timer LED
- 3 Lens
- 4 Microphone

Back View

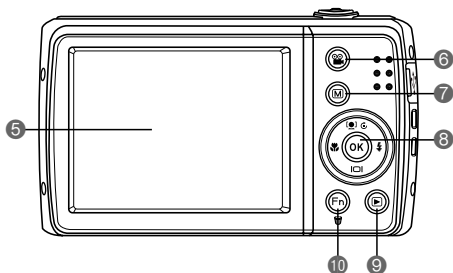

- 5 LCD monitor
- 6 Movie button
- 7 Menu button
- 8 OK button/4-way navigation control (▲, ▼, ◀, ▶)
- 9 Playback button
- 10 FUNC/Delete button

Top View

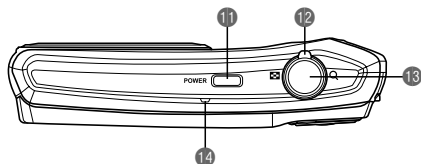

- 11 POWER button
- 12 Zoom dial
- 13 Shutter button
- 14 LED indicator

Bottom View

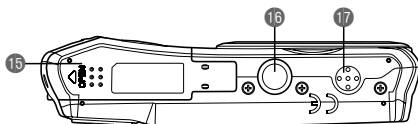

- 15 Battery/Memory card compartment
- 16 Tripod screw hole
- 17 Speaker

Left/Right View

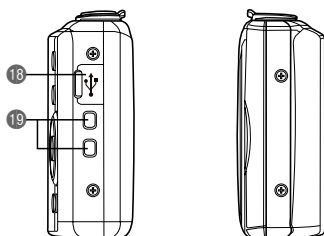

- 18 USB port
- 19 Strap ring

Camera Control

Your camera is equipped with different buttons/dial for ease of use.

Control	Description
POWER button	Press the POWER button to turn the power on/off.
Shutter button	Press to capture an image.
Zoom dial	In Still image record mode, rotate the zoom dial counterclockwise to zoom out, clockwise to zoom in. In Playback mode, rotate to zoom in to magnify image or zoom out enter 9-image/calendar thumbnails.
Menu button	Press to enter or exit menu/submenu.
FUNC/Delete button	In Record mode, press to enter function menu. In Playback mode, press to delete an image or video clip.
Playback button	Press to enable Playback mode or return to Record mode.
Movie button	Press to start/stop recording video.

Navigation Control

The **4-way Navigation Control** and the **OK** button allow you to access the various menus available from the On Screen Display (OSD). You can configure a wide range of settings to ensure maximum results from your images and videos. Further functions of these buttons are as follows.

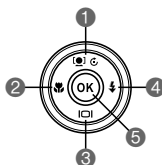

No.	Description
①	Face Tracking/Rotate
②	Macro
③	Display
④	Flash
⑤	OK

Button	Description
OK	<ol style="list-style-type: none"> 1) Confirm a selection when using the OSD menus. 2) In Playback movie mode, press to start video playback.
Flash/Right	<ol style="list-style-type: none"> 1) In Record mode, press to scroll through the Flash mode options (Auto, Red-eye Reduction, Forced On, Slow Sync and Forced Off). 2) In Playback mode, press to view the next image or video clip. 3) In Playback movie mode, press to Forward video playback. 4) In Menu, press to enter the submenu or to navigate through the menu selections.
Macro/Left	<ol style="list-style-type: none"> 1) In Record mode, press to scroll through Macro options (Super Macro, Pan Focus, Infinity and normal). 2) In Playback mode, press to view the previous clip. 3) In Playback movie mode, press to Rewind video playback. 4) In Menu, press to exit a submenu or to navigate through the menu selections.

Button	Description
Up/Face Tracking/ Rotate	1)In Record mode, press to turn the face tracking function on and off. 2)In Playback movie mode, press to pause/start video playback. 3)In Still image playback mode, press to rotate the image to the right 90 degrees with each press. This feature is applicable for still images only. 4)In Menu, press to navigate through the menu and submenu selections.
Display/Down	1)The LCD monitor can be changed into four different types such as Basic, Full, None, and Guideline. 2)In Playback movie mode, press to stop video playback. 3)In Menu, press to navigate through the menu and submenu selections.

Camera Memory

Internal memory

Your camera is equipped with 43.5MB of internal memory. If there is no memory card inserted in the memory card slot, all image and video clips recorded are automatically stored in the internal memory.

External storage

Your camera supports SD cards of up to 4GB in size. It also supports SDHC cards with a maximum capacity of 32GB and SDXC cards with a maximum capacity of 64GB. If there is a storage card inserted in the memory card slot, the camera automatically saves all image and video clips in the external storage card. The icon  indicates the camera is using memory card.



IMPORTANT!

- Not all cards may be compatible with your camera. When purchasing a card, please check the card's specifications and take the camera with you.

Getting Started

Attach the Camera Strap

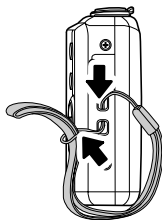

First, charge the battery prior to use.

Note that the battery of a newly purchased camera is not charged. Perform the steps below to load the battery into the camera and charge it.

- Your camera requires a special CASIO rechargeable lithium ion battery (NP-80) for power. Never try to use any other type of battery.

Inserting the Battery

1. Make sure the power is off before inserting the battery.

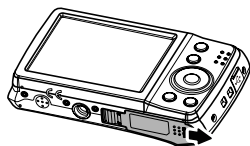

2. Unlock and open the battery/memory card compartment at the bottom of the camera.

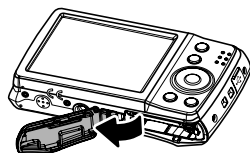

3. Insert the battery into the compartment with the terminal facing inside the camera with correct orientation as shown.

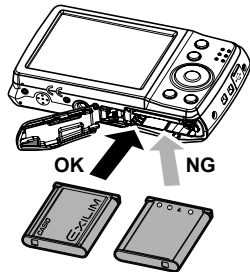

-
4. Close and lock the battery/memory card compartment.

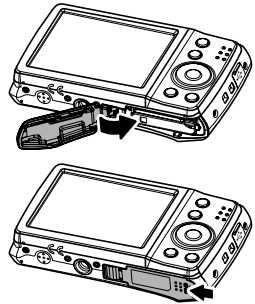

To replace the battery

1. Unlock and open the battery/memory card compartment.
With the LCD monitor side of the camera facing upwards, slide the stopper in the direction indicated by the arrow in the illustration. After the battery pops out, pull it the rest of the way out of the camera.

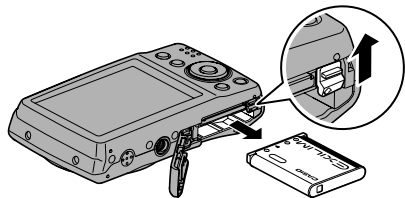

-
2. Insert a new battery.

Charge the Battery

You can use either of the two following methods to charge the camera's battery.

- USB-AC adaptor
- USB connection to a computer

■ To charge with the USB-AC adaptor

1. Turn off the camera.
Check to make sure that the LCD monitor is blank. If it isn't, press the **POWER** button to turn off the camera.

2. After connecting the supplied USB cable to the USB-AC adaptor, plug the power cord into a household power outlet.

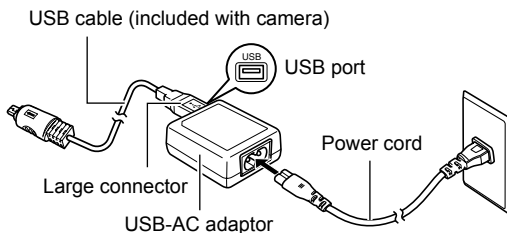

3. Connect the USB cable to the camera. The LED indicator should flash green, indicating that charging has started. The LED indicator will go out when charging is complete. It takes about 150 minutes to achieve a full charge. Charging may take longer depending on charging conditions.

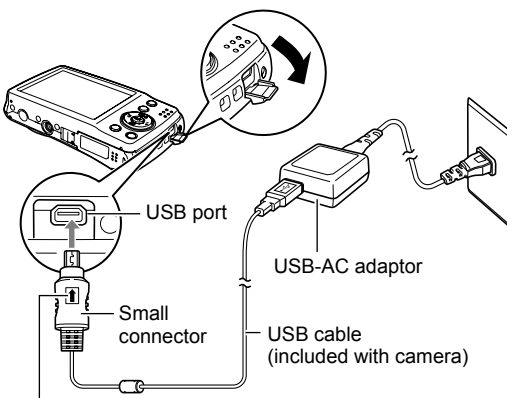

Making sure that the ↑ mark on the USB cable connector is towards the LCD monitor, connect the cable to the camera.

LED indicator Operation

Indicator Status	Description
Flashing green	Charging
Flashing green, fast	Charging problem (page 77)
Off	Charging complete

LED indicator

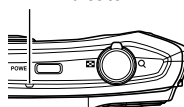

4. After charging is complete, disconnect the USB cable from the camera and then unplug the power cord from the power outlet.

■ To charge using a USB connection to a computer

The battery loaded in the camera is charged whenever the camera is connected directly to a computer with the USB cable.

- Depending on the setup of your computer, you may not be able to charge the camera's battery over a USB connection. If this happens, use of the USB-AC adaptor that comes with the camera is recommended.

1. Turn off the camera.

Check to make sure that the LCD monitor is blank. If it isn't, press the **POWER** button to turn off the camera.

★ **IMPORTANT!**

- If you connect the camera to a computer for the first time after you purchase it while the camera is turned on, the computer will enter a camera recognition operation. If this happens, perform the procedure on page 67. After the computer recognizes the camera, turn off the camera.

2. With your computer turned on, connect the camera to it.

The LED indicator should flash green, indicating that charging has started.

The LED indicator will go out when charging is complete.

It takes about 150 minutes to achieve a full charge. Charging may take longer depending on charging conditions.

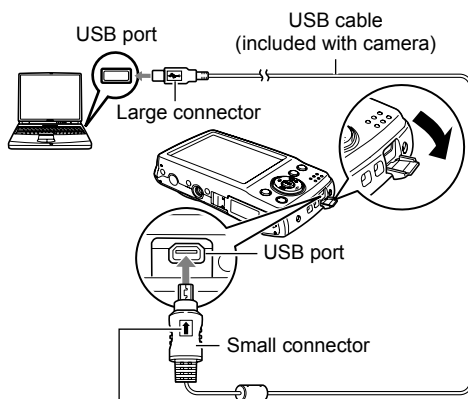

Making sure that the ↑ mark on the USB cable connector is towards the LCD monitor, connect the cable to the camera.

LED indicator Operation

Indicator Status	Description
Flashing green	Charging
Flashing green, fast	Charging problem (page 77)
Off	Charging complete

LED indicator

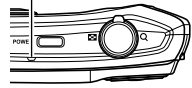

3. After charging is complete, disconnect the USB cable from the camera and then from the computer.



IMPORTANT!

- Charging is not possible if the computer is in a rest or standby state.
- A charging error can occur immediately after charging begins or some time after charging begins. A charging error is indicated by the LED indicator flashing green at high speed.
- Leaving the camera for about 48 hours with no power supplied while the battery is dead will cause its date and time settings to be cleared. A message telling you to configure time and date settings will appear the next time you turn on the camera after restoring power. When this happens, configure date and time settings (page 63).

Other Charging Precautions

- With the two charging methods described above, you can charge the camera's battery (NP-80) without removing it from the camera. Never use any other type of charger device. Attempting to use a different charger can result in unexpected accident.
- USB charging devices and power supply devices are subject to fixed standards. Use of an inferior device or a device that is not up to standard can cause malfunction and/or failure of your camera.
- Operation is not guaranteed in the case of a computer built or modified by you. Even in the case of a commercially available computer, certain USB port specifications may make it impossible to charge via the USB cable.
- A battery that is still warm due to normal use may not charge fully. Give the battery time to cool before charging it.
- A battery discharges slightly even when it is not loaded in the camera. Because of this, it is recommended that you charge the battery immediately before you need to use it.
- Charging the camera's battery may cause interference with TV and radio reception. If this happens, plug the charger into an outlet that is further away from the TV or radio.
- Actual charging time depends on current battery capacity and charging conditions.
- Do not use the USB-AC adaptor with any other device.

Inserting a Memory Card

Expand your camera's storage by using an SD, SDHC or SDXC memory card.

Supported Memory Cards

- SD Memory Card (Up to 4GB)
- SDHC Memory Card (Up to 32GB)
- SDXC Memory Card (Up to 64GB)



Use one of the above types of memory card.

- The above are supported memory card types as of January 2012.
- Noted memory card capacities are standard values.
- Use only SD cards that are compliant with the SD Card Association specification.

To load a memory card

1. Unlock and open the battery/memory card compartment at the bottom of the camera.
2. Insert the memory card into the memory card slot with the metallic part facing the back (LCD monitor) side of the camera.
3. Push the memory card into the memory card slot until it clicks into place.
4. Close and lock the battery/memory card compartment.

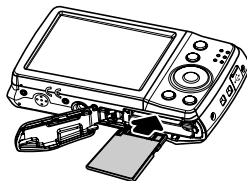
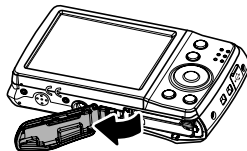

To remove the memory card

1. Unlock and open the battery/memory card compartment.
2. Gently push the card until it pops out.
3. Pull out the card carefully.

NOTE

- Windows XP does not support SDXC cards (exFAT format). However, with Windows XP (Service Pack 2 or 3), you can download an exFAT patch update to enable support for SDXC cards.

Turning the Power On and Off

There are two ways to turn on the camera.

- Press the **POWER** button, then the startup image displays briefly and the startup sound plays if enabled. The zoom lens extends and the camera is turned on in Record mode.
- Hold down the **Playback** button until the LED indicator lights. This turns on the camera in the Playback mode. The zoom lens is not extended.

To turn off the camera, press the **POWER** button.

See “Modes” on page 18 to know more about Record and Playback modes.

Initial Settings

When you turn on your camera for the first time, you will be asked to do the initial settings of your camera. First is the setup of language menu. Specify in which language menus and messages are to be displayed on the LCD monitor.

Setting the Language

1. Press the ▲, ▼, ◀ or ▶ keys to move through the languages.
2. Select a language, and then press the **OK** button to apply.

Setting the Date & Time

1. Press the ◀ or ▶ keys to move through the selection.
2. Press the ▲ or ▼ keys to change the value for the date and time.
3. Press the **OK** button to apply.
4. If necessary, press the **Menu** button to close the menu.

Now, you are ready to start taking images and videos.

NOTE

- Holding down the ▲ or ▼ keys changes the values continuously.
- Removing the battery from the camera too soon after configuring time and date settings for the first time can cause the settings to be reset to their factory defaults. Do not remove the battery for at least 24 hours after configuring settings.

Modes

Your camera has two modes:

Record Mode

- This is the default mode while you turn on the camera every time. You are able to take images and record videos in this mode.

Playback mode

- Press the **Playback** button after the camera is turned on to view and edit captured images or playback videos.

Using the LCD monitor

The LCD monitor shows all important information regarding camera settings as well as the visual image of your image or video. The display on the LCD monitor is called the On Screen Display or OSD.

LCD Monitor Layout

■ Still Image Record Mode Screen Layout

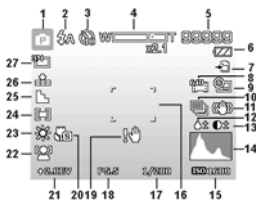

No.	Item	Description
1	Record mode	Indicates the current mode.
2	Flash	Indicates flash settings.
3	Self-timer/Burst	Indicates Drive mode settings.
4	Zoom indicator	Displays zoom.
5	Shots remaining	Indicates the remaining shots available.
6	Battery	Indicates battery level.
7	Storage media	Indicates current storage media in use.
8	Movie size	Indicates video size.
9	Date stamp	Indicates date stamp is enabled.
10	AEB	Indicates AEB function is enabled.
11	Stabilizer	Indicates stabilizer function is enabled.
12	Saturation	Displays saturation settings.
13	Contrast	Displays contrast settings.
14	Histogram	Graphic display of Brightness.
15	ISO	Displays ISO settings.
16	Focus area	Indicates focus area.
17	Shutter speed	Displays shutter speed settings.
18	Aperture value	Displays aperture settings.
19	Shake warning	Indicates that the camera is shaking.
20	Focus	Indicates focus is enabled.

No.	Item	Description
21	Exposure	Displays exposure settings.
22	Face tracking	Indicates face tracking is enabled.
23	White balance	Displays white balance settings.
24	Metering	Displays metering settings.
25	Sharpness	Displays sharpness settings.
26	Quality	Displays quality settings.
27	Photo size	Displays photo size settings.

■ Video Image Record Mode Screen Layout



Recording layout

No.	Item	Description
1	Key indicator	Displays the commands on 4-way navigation control button.
2	Recorded time	Displays recorded time.
3	Recording status	Indicates recording status.

NOTE

- The Pre-Record icon appears on the screen in red color as the same position as zoom indicator.

■ Playback Mode Screen Layout

The Playback mode display varies depending on the type of image being viewed.

Playback mode display of still images:



No.	Item	Description
1	Playback mode	Indicates Playback mode.
2	Protect	Indicates file is protected.
3	File no./Total no.	Indicates the file number over the total number of files in the storage card.
4	Battery	Indicates battery level.
5	Storage media	Indicates used storage memory.
6	Recording information	Displays recording information of the file.
7	DPOF	Indicates the file is marked for printing.
8	Image size	Displays the image size settings.

Playback mode of videos:

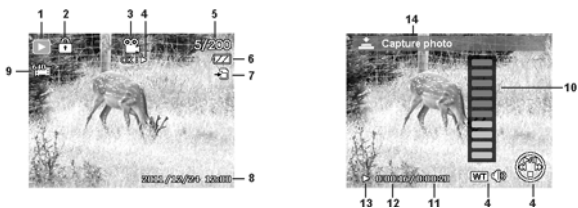

No.	Item	Description
1	Playback mode	Indicates Playback mode.
2	Protect	Indicates file is protected.
3	Video clip	Indicates the file is a video.
4	Button intro	Indicates the button to press on the camera to play a video file.
5	File no./Total no.	Indicates the file number over the total number of files in the storage card.
6	Battery	Indicates battery level.
7	Storage media	Indicates used storage memory.
8	Recording date & time	Displays the date and time of the video clip.
9	Video size	Indicates the size of the video clip.
10	Volume	Indicates the volume while playing.
11	Video length	Display the total length of the video clip.
12	Played time	Indicates the played time of the video.
13	Playing status	Displays playing status.
14	Capture image	Capture the screenshot and save.

Changing the LCD Monitor Display

The type of information displayed on the LCD monitor can be changed using the ▼ key. Press the ▼ key repeatedly to change the LCD display from one type to another. In Record mode, the LCD display can be changed into any of the following.

- Basic
- Full
- None
- Guideline

NOTE

- The OSD information may vary depending on the record mode type.
- The following icons, if enabled, are still displayed on the LCD even when OSD off or Guideline is on: AEB, Face tracking, Drive mode, Stabilizer, and Focus.
- Use the "Guide lines" to properly set image for capture.

In Playback mode, the LCD display can be changed into any of the following.

- Basic
- Full
- None

NOTE

- LCD display cannot be changed in the following situations.
 - Recording video clips
 - Playing video clips
 - Playing slide show

Recording Images and Videos

Taking Images

Now that you are familiar with your camera, you are now ready to take your images. Taking images with your camera is very simple.

1. Turn on the camera by pressing the **POWER** button.

2. Frame the shot using the focus bracket on the LCD monitor. See illustration on the right.

3. Pressing the **Shutter** button down halfway automatically focuses and adjusts the exposure, and pressing the **Shutter** button down fully captures the images.



Focus bracket

If the shake warning icon  appears, hold the camera steadily, with your arms at your side or use a tripod to stabilize the camera to prevent blurred images.

Setting the Zoom Dial

Using a combination of 5 times optical zoom and 5 times digital zoom permits zoom photography at up to 25 times magnification. While the digital zoom can be a useful feature, the more an image is enlarged (zoomed), the more pixelated (grainier) the image will appear. Please refer to “Setting the Digital Zoom” on page 44 on how to setup digital zoom.



To adjust the optical zoom:

1. Rotate the **Zoom** dial to zoom in or zoom out an image.

2. The zoom indicator appears on the LCD monitor.



■ Zoom dial

1. Rotate the dial clockwise  (right) to zoom in.
2. Rotate the dial counterclockwise  (left) to zoom out.

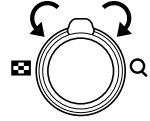

To adjust the digital zoom:

1. Activate digital zoom. See “Setting the Digital Zoom” on page 44.
2. Rotating the **Zoom** dial clockwise/counterclockwise optically zooms in/out to the maximum until it stops.
3. Release the **Zoom** dial.



NOTE

- Zoom operation is not activated in recording videos.

Using Flash

When taking pictures in difficult lighting conditions, use the **Flash/Right** button to get correct exposure. This function cannot be activated in recording videos or continuous shooting.

To activate Flash:

- Press the **Flash/Right** button on your camera repeatedly until your desired Flash mode is displayed on the LCD monitor.

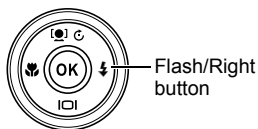

Your camera is equipped with five flash modes.

- ⚡ A** **AUTO.** The flash fires automatically whenever extra lighting is needed.
- ⚡ 👁** **Red-eye reduction.** The flash fires twice to reduce the red-eye effect.
- ⚡** **Forced on.** The flash fires whenever you press the **Shutter** button regardless of lighting conditions.
- ⚡ SL** **Slow sync.** The flash fires with a slow shutter speed.
- ⚡** **Forced off.** The flash is turned off.

Auto flash is enabled.



NOTE

- The flash function is available only when shooting still images. It is not available for the Burst and AEB modes.
- The flash does not charge while the **Zoom** dial is rotated. To enable flash charging, release the **Zoom** dial.

Setting the Focus Mode

This function allows users to define the type focus when recording a still image.

To set the Focus mode:

- Press the **Macro/Left** button repeatedly until the desired Focus mode icon is displayed on the lower left corner of the LCD monitor.

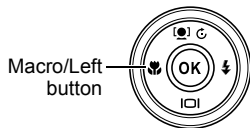

Your camera supports the four focus modes.

Normal. With normal focus, the focus range starts from 15 cm (5.9") (Wide Angle). When the camera is set to Normal mode, there is no icon displayed on the screen.

 **Super Macro.** This mode is designed for close-up photography.

PF **Pan Focus.** The focus of this mode provides maximum Depth of Field (DOF), not designed for close-up photography.

INF **Infinity.** When Infinity is set, the camera focuses on distant objects.



Focus enabled

Using the Function Menu

The **Function Menu** is used to adjust capture settings in Record mode. It contains My Mode, Aspect Ratio, Photo Size, EV Compensation, White Balance, ISO, Metering, Color Mode, Movie Size and Pre-record.



Press the **FUNC/Delete** button of your camera to launch the Function Menu.
Press the **FUNC/Delete** button again to close the menu.

- The Menu bar displays the current status of your camera settings. Only the available functions for the settings are shown as icon on the menu bar.
- The available options for each item on the menu bar are shown in the Menu options.
- Use the ◀ or ▶ keys to move through the menu selections, and then press the **OK** button to save and apply changes.

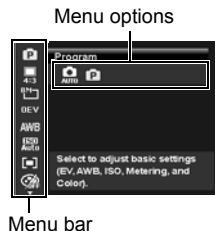

My Mode

My Mode shows the available Scene Modes, with the currently selected Scene Mode highlighted. The icon in the menu bar changes to the icon of the selected Scene Mode.



Aspect Ratio

The Aspect Ratio function is used to set the width to height ratio of an image. Display available remaining shots in help text synchronously while selecting different options.







Photo Size





The Photo size function is used to set the resolution before you capture the image. Changing the Photo Size affects the number of images that can be stored in your memory card. The higher the resolution, the more memory space is required.







The table below shows the Photo Size values for still images when selecting **Aspect ratio 4:3**.

Icon	Pixel Size	Printing Size Suggestion
	4320 × 3240	A2 Size
	3264 × 2448	A3 Size
	2592 × 1944	A4 Size
	2048 × 1536	A5 Size
	640 × 480	E-mail





The table below shows the Photo Size values for still images when selecting **Aspect ratio 3:2**.

Icon	Pixel Size	Printing Size Suggestion
	4320 × 2880	8" × 12"
	3264 × 2176	6" × 9"
	2592 × 1728	5" × 7"
	2048 × 1360	4" × 6"
	640 × 424	E-mail

The table below shows the Photo Size values for still images when selecting **Aspect ratio 16:9**.

Icon	Pixel Size	Printing Size Suggestion
 14M	4320 × 2424	HDTV
 8M	3264 × 1832	HDTV
 5M	2592 × 1456	HDTV
 3M	2048 × 1152	HDTV
 VGA	640 × 360	E-mail

The table below shows the Photo Size values for still images when selecting **Aspect ratio 1:1**.

Icon	Pixel Size	Printing Size Suggestion
 14M	3744 × 3744	square-shaped
 8M	2832 × 2832	square-shaped
 5M	2240 × 2240	square-shaped
 3M	1728 × 1728	square-shaped
 VGA	480 × 480	E-mail

EV Compensation

Images can be captured with the overall scene intentionally made brighter or darker. These settings are used when a suitable brightness (exposure) cannot otherwise be obtained in circumstances where the difference in brightness between the subject and the background (the contrast) is large, or when the subject that you wish to capture is very small within the scene. Available for still images only.



- This function is used only in Program mode (page 38).
- To adjust EV settings, press the ◀ or ▶ keys to increase/decrease the value. As you adjust the settings, the LCD monitor synchronously displays the image applying the EV settings. Press the **OK** button to save and apply changes.

White Balance

This sets the white balance for a variety of lighting conditions and permits images to be captured that approach the conditions that are seen by the human eye.



- This function is used only in Program mode (page 38).
- As you move through the selection, you can see the preview on the LCD monitor synchronously.

Icon	Item	Description
AWB	Auto White Balance	The camera automatically adjusts the white balance.
	Daylight	Ideally used for bright sunny conditions.
	Cloudy	Ideally used for cloudy conditions.
	Tungsten	Ideally used for indoor images with tungsten or halogen lighting without a flash.
	Fluorescent 1	Ideally used for indoor images with bluish fluorescent lighting conditions.
	Fluorescent 2	Ideally used for indoor images with reddish fluorescent lighting conditions.

Icon	Item	Description
	Custom	Used when light source cannot be specified. Press the Shutter button for the camera to automatically adjust the appropriate white balance setting according to the environment.

ISO

This sets the sensitivity for capturing images. When the sensitivity is raised (and the ISO figure is increased), photography will become possible even in dark locations, but the more pixelated (grainier) the image will appear.



- This function is used only in Program mode (page 38).
- Use a higher ISO setting in dim conditions and a lower ISO setting in brighter conditions.



Metering

This sets the metering method for calculating the exposure.









Icon	Item	Description
	Multi	The entire area of the screen is measured, and the exposure is calculated.
	Center	Averages the light metered from the entire frame, but gives greater weight to the subject matter at the center.
	Spot	A very small portion of the center of the screen is measured, and the exposure is calculated.

Color Mode

The Color mode function applies different colors or tones for a more artistic effect on the still images or videos.



- This function is used only in Program mode (page 38).
- As you move through the selection, the preview on the LCD monitor changes synchronously.

Icon	Item	Description
	Off	The camera records normally.
	Vivid	The camera captures the image with more contrast and saturation emphasizing on the bold colors.
	Sepia	Images are captured in sepia tones.
	B&W	Images are captured in black and white.
	Vivid Red	Captured image becomes reddish. Ideally used to record images like flowers and cars to make them more vivid.
	Vivid Green	Captured image becomes greenish. Ideally used to record images like mountains and lawns to make them more vivid.
	Vivid Blue	Captured image becomes bluish. Ideally used to record images like the sky and the ocean to make them look more vivid.

Recording Videos

You can record videos with the camera, the available recording time depends on the capacity of the memory card. Videos can be recorded until the maximum memory capacity has been reached. However, the length of a single video may be limited.



1. Turn on the camera by pressing the **POWER** button.

2. Focus your camera on the subject that you want to take.

3. Press the **Movie** button to start recording.

4. To pause recording, press the **▲** key.

5. To continue recording, press the **▲** key again.

6. To stop recording, press the **Movie** button.

NOTE

- When the camera stop recording due to reaching maximum time (29 minutes) for a single video, simply press the **Movie** button again to continue recording.
- The camera will automatically stop recording when the memory capacity is full.
- Zoom operation is not available while recording a video.
- Power save mode is not available in video recording or pause recording.

Settings of Recording Videos





Press the **FUNC/Delete** button to enable video setting menu before recording a video.

Movie Size

Use this function to adjust the resolution and quality of video clips.



The table below shows the available size and corresponding image quality settings.

Icon	Item	Description
	1280 × 720	HDTV The maximum length of a single video recording is up to 29 minutes. It will automatically stop recording when the recording time is over 29 minutes or the file size is over 4GB.
	640 × 480	High Quality The maximum length of a single video recording is 4GB. It will automatically stop recording when a file size is over 4GB.
	320 × 240	Normal The maximum length of a single video recording is 4GB. It will automatically stop recording when a file size is over 4GB.
	Web	For Internet, see “Internet Mode” on page 36 below.

- Using the camera's built-in memory or certain types of memory cards can slow down processing speed. Whenever possible use an Ultra High-Speed Type memory card. Note, however, that not all operations can be guaranteed even if an Ultra High-Speed Type memory card is used. Certain movie quality settings can result in too much time being required to record data, which can result in breaks in the image and/or audio during playback.

Internet Mode

The Internet mode allows you to record videos with predefined video settings for easy upload to the Internet website.

Therefore when you record using the Internet Mode, the following standards are followed:

- Recorded videos are set to Internet standard resolution of 640×480 .
- Recording automatically stops when the file reaches 1GB.
- Available recording time for Internet Mode is up to 10 minutes.
- Recording a video while  (Web) is selected for the Movie size setting causes a folder named "100UTUBE" to be created for storage of movie files. This helps to simplify uploading to YouTube.

Pre-Record

You can catch the first three seconds of action you would have potentially missed. Once enabled, this function starts recording video automatically before the **Movie** button is pressed. As soon as the **Movie** button is hit, the most recent three seconds of video is added to the beginning of the clip.

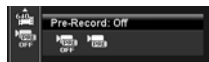

The Pre-Record icon  is displayed in red while Pre-Record is turned on.

NOTE

- Pre-Record will be canceled in the following situation.
 - When you change My Mode to "Program" or switch to Playback mode
 - When you turn off power
 - When you enter USB mode

Using the Record Menu

If you are in Record mode, you can access the Record menu simply by pressing the **Menu** button on your camera.

When the menu is displayed, use the 4-way navigation control and the **OK** button to move through menu selections and apply your desired settings. To close the menu anytime, press the **Menu** button again.

Record Menu

The Record menu allows you to change modes, and setup other capture settings.

To go to Record Menu:

Turn on the camera by pressing **POWER** button.

1. Press the **Menu** button to launch the Record Menu.
2. Use the ▲ or ▼ keys to move through the menu
3. To select an item, press the ► key or **OK** button.
4. Change the submenu settings using the 4-way navigation control.
5. Press the **OK** button to save and apply settings.





Setting the Scene Mode

The following two scene modes can be selected to shoot images.

1. From the Record Menu, press the ► or **OK** button to select **Scene Mode**.
2. Use the navigation control to move through the selection.
3. Press the **OK** button to save and activate the selected Scene mode.

The table below shows the available Scene mode settings.

Icon	Item	Description
	Auto	The simplest way to shoot basic images. Settings are adjusted automatically.
	Program	The camera automatically adjusts suitable shooting settings like shutter speed and aperture values.

The Scene Mode can also be configured using the Function Menu My Mode setting (page 28).





Setting the Drive Mode

Your camera features a Self-timer and Burst which can be set in the Drive mode function in the Record menu. The Self-timer allows you to take images after a pre-defined delay. While burst lets you take consecutive shots. This function is only available in recording still images. The Drive mode setting is automatically set to off when you turn off the camera.

To set the Drive Mode

1. From the Record menu, select **Drive Mode**.
2. Use the ▲ or ▼ keys to go through the selection.
3. Press the **OK** button to save and apply changes.

The table below shows the available Drive mode settings.

Icon	Item	Description
	Off	Captures an image without time delay.
	10 Sec.	Sets a 10-second delay to capture image after pressing the Shutter button.
	2 Sec.	Sets a 2-second delay to capture image after pressing the Shutter button.
	Double	Performs delay and capture twice. <ul style="list-style-type: none">• Performs a 10-second delay, then captures the image.• Performs another 2-second delay, and then captures the image again.
	Burst	Performs continuous shooting when the Shutter button is pressed. Stops shooting when the Shutter button is released.

Setting the AEB

AEB stands for Automatic Exposure Bracketing. It permits 3 consecutive images in the order of standard exposure, under exposure and overexposure compensation.

- AEB function is used only in Program mode (page 38).

To set AEB:

1. From the Record menu, select **AEB**.
2. Use the ▼ or ▲ keys to go through the selection.
3. Press the **OK** button to save and apply changes.



Setting the AF Area

AF stands for Automatic Focus. This feature determines the area on which the camera focuses.

To set AF Area:

1. From the Record menu, select **AF Area**.
2. Use the ▲ or ▼ keys to go through the selection.
3. Press the **OK** button to save and apply changes.

The table below shows the available AF area settings.

Icon	Item	Description
	Wide	The camera automatically selects focus area within the wide frame.
	Center	The focus area is fixed on the center.



Setting Sharpness

This function allows you to enhance or soften finer details of your images.

To set Sharpness:

1. From the Record menu, select **Sharpness**.
2. Use the ▲ or ▼ keys to go through the selection.
3. Press the **OK** button to save and apply changes.

The table below shows the available Sharpness settings.

Icon	Item	Description
	High	Sharpens the image.
	Normal	Normal sharpness.
	Low	Softens the image.



Setting Saturation

The Saturation function lets you adjust the color saturation in your images. Use a higher saturation setting for rich colors and a lower saturation setting for more natural tones.

To set Saturation:

1. From the Record menu, select **Saturation**.
2. Use the ▲ or ▼ keys to go through the selection.
3. Press the **OK** button to save and apply changes.

The table below shows the available Saturation settings.



Icon	Item	Description
	High	Enhance the saturation.
	Normal	Normal saturation.
	Low	Reduce the saturation.

Setting Contrast

This function allows you to adjust the contrast of your images.



To set Contrast:

1. From the Record menu, select **Contrast**.
2. Use the ▲ or ▼ keys to go through the selection.
3. Press the **OK** button to save and apply changes.

Icon	Item	Description
	High	Enhance the contrast.
	Normal	Normal contrast.
	Low	Reduce the contrast.

Setting Quality

The Quality sets the quality (compression) at which the image is captured. The quality determines the amount of compression applied to your images. Fine quality would give you the best images with sharper details and less compression. However, the higher the quality, the more memory space is required in your memory card.

Icon	Item	Description
	Superfine	3x compression rate.
	Fine	7x compression rate.
	Normal	12x compression rate.



Setting the Digital Zoom

This feature controls the Digital zoom mode of your camera. Your camera enlarges an image using the optical zoom first. When the zoom scale exceeds 5x, the camera uses digital zoom.

To set Digital Zoom:

1. From the Record menu, select **Digital Zoom**.
2. Use the ▲ or ▼ keys to go through the selection.
3. Press the **OK** button to save and apply changes.

The table below shows the available Digital Zoom settings.

Icon	Item	Description
	Intelligent Zoom	Enlarges the image digitally with almost no distortion. Intelligent Zoom is not supported when the photo size is 14M.
	Standard Zoom	Enlarges all image sizes up to a maximum of 5x in preview, but the image quality deteriorates.
	Off	Uses the optical zoom only.

NOTE

- Zoom operation is not available in Face Tracking on and video image record modes.
- The maximum Intelligent zoom scale varies depending on the photo size.

Setting the Date Stamp

The date of recording can be printed directly on the still images. This function must be activated before the image is captured. Once date and time are stamped on an image, they can no longer be edited or deleted.

Limitations of Date Stamp functions are as follows.

- Available for still images only.
- May slow down AEB/Burst mode when Date Stamp is enabled in AEB/Burst mode.
- In vertical or rotated images, the date and time on your images still appear horizontally.

To set Date Stamp:

1. From the Record menu, select **Date Stamp**.

2. Use the ▲ or ▼ keys to go through the selection.

3. Press the **OK** button to save and apply changes.

Setting Auto Review

The Auto Review function lets you view the captured image right after shooting it. If Auto Review is On, the camera will display the captured image for **1 second** on the LCD monitor.

To set Auto Review:

1. From the Record menu, select **Auto Review**.

2. Use the ▲ or ▼ keys to go through the selection.

3. Press the **OK** button to save and apply changes.

Setting Stabilizer

This function allows you to prevent blurred images caused by shaking.

1. From the Record menu, select **Stabilizer**.

2. Use the ▲ or ▼ keys to go through the selection.

3. Press the **OK** button to save and apply changes.

Playback

You can playback the still image and video clips on the LCD monitor.

Viewing in Single Navigation

The Single navigation mode displays the images one by one on the LCD monitor. To view image/video clips, follow the steps below.

1. Press the **Playback** button on the camera.
2. The LCD monitor displays an image. To understand the icons and other information on the screen, please see “LCD Monitor Layout” on page 19.



3. Use the ◀ or ▶ keys to view next/previous image/video.
4. To play a video clip, press the **OK** button. See “Playing Videos” on page 48 for more details.

Viewing Thumbnails

This function allows you to view 9-thumbnail images or by calendar mode on the LCD monitor. Searching numerous images is much easier than single view navigation.

To set 9-images mode

1. Press the **Playback** button on the camera.
2. Rotate the **Zoom** dial counterclockwise (left) **once** to enter 9-images mode.
3. Use the navigation control to move through the items.
4. Press the **OK** button to select the image and view it normally.

Scroll bar

If a scroll bar appears, it indicates that the screen can be scrolled.

Scroll bar

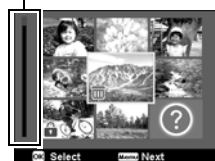

Thumbnail view

To set calendar mode:

1. Press the **Playback** button on the camera.
2. Rotate the **Zoom** dial counterclockwise (left) **twice** to view thumbnails in calendar mode.
3. Use the navigation control to move through the items.
4. Press the **OK** button to select an image and view it normally.



NOTE

- In calendar mode:
 - The first file (including image, video, and error file) recorded on each date appears on the screen.
 - Rotate the **Zoom** dial clockwise (right) would back to 9-images mode.

Thumbnail icon:

When you view the thumbnails, some images may contain icon. The icon indicates the type of file or recording.

Icon	Type	Description
	File Error	Indicates an error file.

Zooming Images

The zoom view function works with still images only.

- In normal view, rotate the **Zoom** dial clockwise (right) repeatedly until the desired zoom view.
- The 4 arrows on the LCD monitor indicate that the image is zoomed in.
- You can zoom to view an image of up to 12x.
- Use the navigation control to view the zoomed image.
- Press the **Menu** button to close zoom view.

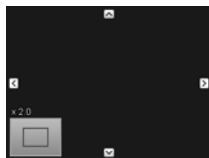

Playing Videos

1. Press the **Playback** button on the camera.

2. Use the navigation control to scroll through the saved images. A video clip has a video icon displayed on screen.

3. Press the **OK** button to play the video.

4. During playback, press and hold the ◀ or ▶ keys to fast forward or rewind the video. The camera supports forward and rewind speed of up to 4x.

5. During playback, use the **Zoom** dial to control volume. Rotate clockwise (right) to increase volume/Rotate counterclockwise (left) to decrease volume.

6. Press the ▲ key to pause playback. Press the ▲ key again to resume. When paused, the play info will remain on screen except **WT** .

7. To forward or rewind the video frame by frame, press the ▲ key to pause playback, then press the ◀ or ▶ keys.

8. Press the ▼ key to stop the playback. The LCD monitor displays the video frame image in Single navigation mode.



NOTE

- The play info, except the icon **WT** , will be displayed when the video is paused, during REW/FF or frame by frame modes.
- Volume cannot be adjusted when paused or during REW/FF modes.

To capture a screenshot image from a video clip

1. During playback of video, press the ▲ key to pause playback on your desired video frame to capture.

2. Press the **Shutter** button to capture a screenshot.

3. The camera stops playback. The LCD monitor displays the captured image in Single navigation mode.

NOTE

- This feature does not function when pressing shutter button and “Memory full” or “Folder cannot be created” message is displayed. The icon  does not appear on the screen either.

Deleting an Image/Video

There are two ways to delete an image/video.

- Using the **FUNC/Delete** button.
- Using Playback menu Delete settings. See “Delete” on page 51.

Using the FUNC/Delete Button



Use the **FUNC/Delete** button on your camera to delete an image/video clip.

1. Press the **Playback** button on the camera.

2. View image/video clips in Single navigation mode.

3. Use the ◀ or ▶ keys to scroll the display.

4. When the desired image/video clip is displayed on the LCD monitor, press the **FUNC/Delete** button.

5. A confirmation selection appears on screen.

6. Select **Delete**.

7. Press the **OK** button to delete.

8. The next image is displayed on the LCD monitor. To delete another file, use the ◀ or ▶ keys to scroll through the image/video clips. Then, repeat steps 6 to 7.

9. To close the Delete function and go back to the Single navigation mode, select **Cancel**.

NOTE

- Locked files cannot be deleted at any time. When you try to delete a locked file, the camera displays “File Locked” message on the LCD monitor.

Playback Menu

The Playback menu allows you to edit images and setup playback settings.

To go to Playback Menu:

1. Press the **Playback** button on the camera.

2. Press the **Menu** button to launch the Playback menu.

3. Use the **▲** or **▼** keys to move through the menu selections.

4. To select a menu, press **▶** or the **OK** button.

5. Change the submenu settings using the 4-way navigation control.

6. Press the **OK** button to save and apply settings.

Delete

The Delete function allows you to remove unwanted files in the internal memory or on the memory card. Protected files cannot be erased, to delete, unprotect the file first. See "Protect" on page 54.

To delete an image/video clip:

1. From the Playback menu, select **Delete**.

2. The Delete submenu is displayed on the LCD monitor. Select an available setting.
 - **Single**: Select one file to delete.
 - **Multi**: Select multiple files to delete at the same time.
 - **All**: Delete all files.

To delete a single file:

1. Select **Single** in the Delete submenu, the images are displayed on the LCD monitor in Single navigation mode.

2. Use the **◀** or **▶** keys to scroll the display.

3. When the desired image/video clip is displayed on the LCD monitor, select **Delete**.

4. Press the **OK** button to delete.

-
5. The next image is displayed on the LCD monitor. To delete another file, use the ◀ or ▶ keys to scroll through the image/video clips. Repeat steps 3 to 4.
-
6. To close the Delete function and go back Playback menu, select **Cancel**.

To delete multiple files:

1. Select **Multi** in the Delete submenu, the images are displayed in thumbnail view on the LCD monitor.
-
2. Use the navigation control to move through the files.



-
3. When the desired image/video clip is highlighted, press the **OK** button to mark image/video clip for deletion.
-
4. Repeat step 3 until all desired images for deletion are marked.
-
5. Press the **Menu** button. A confirmation selection appears.
-
6. Select **Yes** to confirm.
-
7. Press the **OK** button to delete marked files.

To delete all files:

1. Select **All** in the Delete submenu. A confirmation message appears.
-
2. Select **Yes**.
-
3. Press the **OK** button to delete all files.

Slide Show

The slide show function enables you to playback your still images automatically in order one image at a time.

To view slide show:

1. From the Playback menu, select **Slide Show**. The slide show menu appears.

2. Set the slide show settings.

3. Select **Start**, then press the **OK** button to start the slide show.

4. During slideshow, press the **OK** button to pause slide show.

5. Use the **▲** or **▼** keys to move through the options. Select whether to **Continue** or **Exit** the slide show.

6. Press the **OK** button to apply selected option.

To change slide show settings:

1. From the Slide show menu, use the **▲** or **▼** keys to move through the selections.

2. Select Interval setting. Press the **◀** or **▶** keys to adjust. Choose among the available interval settings: 1 sec., 3 sec., 5 sec., and 10 sec.

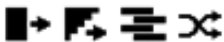
3. Select Transition setting. Press the **◀** or **▶** keys to adjust. Choose among the available transition settings.

4. Select Repeat setting. Press the **◀** or **▶** keys to adjust. Available settings are: Yes, No.

Protect

Set the data to read-only to prevent images from being erased by mistake. A protected file has a lock icon  when viewed on Playback mode.

To protect files:

1. From the Playback menu, select **Protect**.

2. The Protect submenu is displayed on the LCD monitor. Select an available setting.
 - **Single**: Select one file to lock/unlock.
 - **Multi**: Select multiple files from the thumbnail view to lock/unlock.
 - **Lock all**: Lock all files.
 - **Unlock all**: Unlock all files.

To protect/unprotect a single file:

1. Select **Single** in the Protect submenu, the images are displayed on the LCD monitor in Single navigation mode.

2. Use the ◀ or ▶ keys to scroll the display.

3. When the desired file is displayed on the LCD monitor, press the **OK** button to select **Lock/Unlock**.

4. To close the protect/unprotect function and go back Playback menu, select **Exit**.

To protect/unprotect multiple files:

1. Select **Multi** in the Protect submenu, the images are displayed in thumbnail view on the LCD monitor.

2. Use the navigation control to move through the files.

3. When the desired file is highlighted, press the **OK** button to mark/unmark the file clip for protection.

4. Repeat step 3 until all desired files to protect are marked.

5. Press the **Menu** button. A confirmation selection appears.

6. Select **Yes**.

7. Press the **OK** button to lock files and go back to Playback mode.

To protect all files:

1. Select **Lock all** in the Protect submenu. A confirmation message appears.

2. Select **Yes**.

3. Press the **OK** button to lock all files.

To unlock all files:

1. Select **Unlock all** in the Protect submenu. A confirmation message appears.

2. Select **Yes**.

3. Press the **OK** button to unlock all protected files.







Color Mode

The Color mode function lets you edit still images to apply different colors or tones for a more artistic effect. Edited images in this function are saved as a new file.

To activate Color Mode:

1. Press the **Playback** button on the camera.
2. Press the ◀ or ▶ keys to scroll and select an image to edit.
3. Press the **Menu** button to launch the Playback menu.
4. Select **Color Mode**. The Color mode submenu appears.
5. Press the ◀ or ▶ keys to scroll and select an option. As you move through the selection, the preview on the LCD monitor changes synchronously.

The succeeding table shows the available settings.

Icon	Item	Description
	Off	No effect is added to the image.
	Sepia	Image is saved with a sepia tone.
	B&W	Image is saved in black and white.
	Vivid Red	Image is saved with reddish tint.
	Vivid Green	Image is saved with greenish tint.
	Vivid Blue	Image is saved with bluish tint.



Effect

The Effect function is only applicable to still images with different artistic effect. Edited images in this function are saved as a new file.

To activate Effect:

1. Press the **Playback** button on the camera.
2. Press the ◀ or ▶ keys to scroll and select an image to edit.
3. Press the **MENU** button to launch the Playback menu.
4. Select **Effect**. The Effect submenu appears.
5. Press the ◀ or ▶ keys to scroll and select an option. As you move through the selection, the preview on the LCD monitor changes synchronously.

The succeeding table shows the available settings.

Icon	Item	Description
	Off	No effect is added to the image.
	Negative	Image appears to be the opposite of the original image.
	Mosaic	Image is saved with mosaic tiles.

NOTE

- Every time when launching the submenu, the cursor is located on “Off”.

Trim

The Trim function allows you to trim an image to another image size. This function is only available for still images.

To trim an image:

1. Press the **Playback** button on the camera.
2. Use the ◀ or ▶ keys to scroll and select an image to trim.
3. Press the **Menu** button to launch the Playback menu.
4. Select **Trim**. The Trim screen layout is displayed on the LCD monitor.
5. Use the **Zoom** dial to change size as zoom in/out.

No.	Description
1	Enlarged image
2	4-way indicator
3	Trimmed size
4	The approximate location of the trimmed area
5	Image area



6. Use the navigation control to move the image.
7. Press the **OK** button to apply changes. A menu selection appears.
8. Select an available setting.
 - **Overwrite**: Save and replace the old file with the new one.
 - **Save As**: Save the new file as a new one.
 - **Cancel**: Cancel Trim.
9. Press the **OK** button to save/cancel changes.

NOTE

- Trim function is not available for images with image size set to VGA.
- All images will be trimmed in 4:3 ratio regardless of its original image ratio.

Resize

Resizes a previously saved image and only resizing to a smaller size is available.

To resize an image:

1. Press the **Playback** button on the camera.

2. Use the ◀ or ▶ keys to scroll and select an image to resize.

3. Press the **Menu** button to launch the Playback menu.

4. Select **Resize**. The Resize submenu is displayed on the LCD monitor.

5. Select size among: 8M, 5M, 3M, and VGA. Available size settings may vary depending on original image size. Unavailable settings appear as gray icons in Resize submenu.

6. After selecting size, a menu selection appears. Select an available setting.
 - **Overwrite**: Save and replace old file with a new one.
 - **Save As**: Save the new file as a new one.
 - **Cancel**: Cancel resize.

7. Press the **OK** button to save/cancel changes.

NOTE

- Resize function is not available for images with image size set to VGA.

Startup Image

You can specify the startup image from the captured images for camera.

1. Press the **Menu** button to launch the Playback menu.

2. Select **Startup Image**. The menu selection appears.

3. Select an available setting.
 - **System**: Use camera default image.
 - **My Photo**: Use the ◀ or ▶ keys to scroll and select desired image.
 - **Off**: Disable the startup image.

4. Press the **OK** button to apply changes.

NOTE

- The startup image will still be displayed at startup even if the selected image was deleted.

DPOF

DPOF is the abbreviation for Digital Print Order Format, which allows you to embed printing information on your memory card. You can select the images to be printed and how many prints to make with the DPOF menu in the camera and insert the memory card to the card compatible printer. When the printer starts printing, it will read the embedded information on the memory card and print the specified images.

To set DPOF:

1. Press the **Menu** button to launch the Playback menu.

2. Select **DPOF**. The submenu appears. Available settings are as follows.
 - **Single**: Select a single image to mark.
 - **All**: Mark all images in the memory card.
 - **Reset**: Reset all DPOF settings to initial default settings.

To set DPOF on a single image/all images:

1. Select **Single** or **All** on the DPOF submenu.
2. For single image, use the ◀ or ▶ keys to scroll and select an image to mark for printing.
3. Specify the number of copies. Use the ▼ or ▲ keys to increase/decrease number.
4. Press the **FUNC/Delete** button to toggle between turning on/off the date stamp.
5. Press the **OK** button to save DPOF settings.

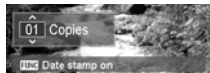

To reset DPOF:

1. Select **Reset** on the DPOF submenu. A confirmation message appears.
2. Select **Yes**.
3. Press the **OK** button to reset DPOF settings.

Radial Blur

Radial Blur blurs the area around a point.

To set Radial blur for an image:

1. Press the **Menu** button to launch the Playback menu.
2. Select **Radial Blur**. The menu selection appears.
3. Use the ▼ or ▲ keys to specify the level of blurs. Changing the level setting causes the radial blur in the image on the LCD monitor to change accordingly.
4. Press the **OK** button to proceed save options.
5. Available settings are as follows.
 - **Overwrite:** Save and replace the old file with a new one.
 - **Save As:** Save the new file as a new one.
 - **Cancel:** Cancel Radial blur.

Using the Setup Menu

You can access the Setup menu whether you are in Record or Playback mode. The Setup menu allows you to configure general camera settings.

To go to Setup menu:

1. Press the **Menu** button to launch the Record/Playback menu.

2. Use the ◀ or ▶ keys to switch the menu tab to Setup menu.

3. Use the ▼ or ▲ keys to move through the menu selections.

4. To select an item, press the **OK** button or ▶ key.

5. Change the submenu settings using the 4-way navigation control.

6. Press the **OK** button to save and apply settings.

Setting Sounds

Use the Sound menu functions to control the sounds produced by the camera.

1. From the Setup menu, select **Sounds**.

2. Adjusts sound settings.

3. Press the **OK** button to apply changes.

Item	Available Settings	Description
Startup	Sound 1, Sound 2, Sound 3, Off	Selects the startup sound when camera is turned on.
Shutter	On, Off	Enables or disables shutter sound when the Shutter button is pressed. Shutter sound is not available when recording videos.
Beep volume	0-4	Adjusts volume.

Setting Power Save

The Power Save function allows you to set an idle time after which the camera automatically sets to sleep mode to save power. After a minute of being in sleep mode, the camera eventually turns off power.

This function is not available in the following instances:

- Recording a video file
- Playing a slide show/video file
- Using the USB connector

Setting LCD Save

Enable the LCD Save function to automatically decrease the LCD brightness to conserve battery power. When the camera is idle for 20 seconds, the LCD darkens. Press any button to resume to normal brightness.

- The camera is idle and enters LCD Save mode when no buttons are pressed. LCD Save, though enabled, does not function during video playback, slide show and video recording.

Setting Date & Time

Use the Date & Time function to set the date and time of your camera. This function is useful in attaching date stamps on captured images. Your camera uses a 24-hour time format.

1. Use the navigation control to adjust date and time value. By holding down the ▼ or ▲ keys, the numeric values changes continuously.
-
2. Press the **OK** button to apply changes.

Setting Language

Specify in which language menus and messages are to be displayed on the LCD monitor.

1. Use the navigation control to scroll through the list and select the desired language.
-
2. Press the **OK** button to confirm and apply settings.

Setting File Numbering

This function allows you to select a method to assign file numbers to images.

Available settings are:

- **Series:** Assigns numbers to files in sequence even if the folder is changed.
- **Reset:** The file numbering will start from 0001 each time a folder is changed or the memory is formatted.

To understand folder and file structure of your camera, see “About Folder and File Names” on page 79.

Setting TV Out

Use the TV Out function to adjust video output signal to accommodate different regional settings. If TV out is not set correctly, the image may not display properly on TV.

Available settings are:

- **NTSC:** Applicable in USA, Canada, and others.
- **PAL:** Applicable in Europe, Asia (excluding Taiwan), Oceania and others.

Setting Memory Kit

This utility formats the internal memory (or memory card) and erases all stored images and data.

Available settings are:

- **Format:** Select to format currently used memory.
- **Copy to Card:** Select to copy all files stored in the internal memory to the memory card.

NOTE

- If images were saved to internal memory before inserting a memory card into the camera, you can use **Copy to Card** function to copy all images from the internal memory to the memory card.
- If a memory card has not been inserted into the camera or the memory card is locked or the internal memory is empty, **Copy to Card** function is not available.

Reset All

Use this function to reset the camera to its factory settings. However, the following settings are exceptions and not affected by Reset.

- Date & Time
- Language
- TV Out
- Custom White Balance data

Making Connections

You can connect your camera to: TV or computer.

Connecting the Camera to a TV

You can play back your images on a TV screen. Before connecting to any video devices, make sure to select NTSC/PAL to match the broadcast standard of the video equipment you are going to connect to the camera.

- As an AV cable, use the separately sold EMC-7A.

To connect your camera to a TV:

1. Turn on the camera.

2. Set the TV out to match the TV's video out format. See "Setting TV Out" on page 64.

3. Connect the AV cable to the USB port on the side of your camera.

4. Connect the other end of the cable to the TV's AV input port.

5. The LCD monitor turns black and all images and video clips are displayed on the TV.

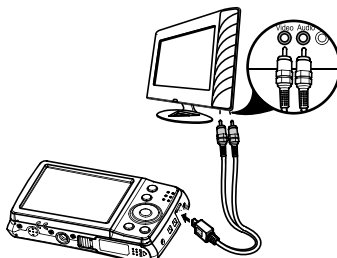

Optional AV cable (EMC-7A)

Connecting the Camera to a Computer

You can transfer images and videos to your computer.

Never use your computer to modify, delete, move, or rename any image files that are in the camera's built-in memory or on its memory card.

Doing so can cause problems with the camera's image management data, which will make it impossible to play back images on the camera and can drastically alter remaining memory capacity. Whenever you want to modify, delete, move, or rename an image, do so only on images that are stored on your computer.

IMPORTANT!

- Never unplug the USB cable, or operate the camera while viewing or storing images. Doing so can cause data to become corrupted.

1. Connect one end of the USB cable to an available USB port on your computer.

2. Connect the other end of the USB cable to the USB port on the side of your camera.

3. Turn on the camera.

4. The computer starts to detect the connection while the LCD monitor appears "Connecting..."

5. Connection established after **PC Mode** appeared on the LCD monitor.

6. Access the files in the camera by your computer.

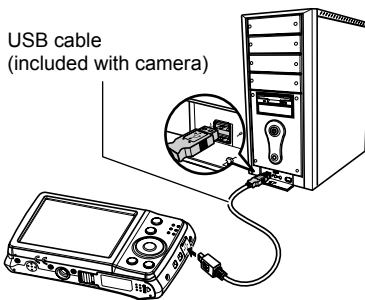

NOTE

- The camera's internal memory and memory card would display as removable drives in computer.
- After the connection, no image is displayed on the LCD monitor.

■ Saving the Files to Your Computer

• Windows

1. Windows 7, Windows Vista users: Click “Start” and then “Computer”.
Windows XP users: Click “Start” and then “My Computer”.

2. Double-click “Removable Disk”.
 - Your computer recognizes the memory card loaded in the camera (or built-in memory if there is no card) as a removable disk.

3. Right-click the “DCIM” folder.

4. On the shortcut menu that appears, click “Copy”.

5. Windows 7, Windows Vista users: Click “Start” and then “Documents”.
Windows XP users: Click “Start” and then “My Documents”.
 - If you already have a “DCIM” folder in “Documents” (Windows 7, Windows Vista) or “My Documents” (Windows XP), the next step will overwrite it. If you want to keep the existing “DCIM” folder, you need to change its name or move it to a different location before performing the next step.

6. Windows 7 users: On the “Documents” “Organize” menu, select “Paste”.
Windows Vista users: On the “Documents” “Edit” menu, select “Paste”.
Windows XP users: On the “My Documents” “Edit” menu, select “Paste”.
This will paste the “DCIM” folder (and all the image files it contains) into your “Documents” (Windows 7, Windows Vista) or “My Documents” (Windows XP) folder. You now have a copy of the files that are in camera memory on your computer.

7. After you finish copying images, disconnect the camera from the computer. On the camera, press the **POWER** button to turn off the camera. Then, disconnect the camera from the computer.

- **Macintosh**

1. Double-click the camera's drive icon.

2. Drag the "DCIM" folder to the folder to which you want to copy it.

3. After the copy operation is complete, drag the drive icon to Trash.

4. On the camera, press the **POWER** button to turn off the camera. Then, disconnect the camera from the computer.

■ **To view images you copied to your computer**

- **Windows**

1. Double-click the copied "DCIM" folder to open it.

2. Double-click the folder that contains the images you want to view.

3. Double-click the image file you want to view.
 - For information about file names, see "Memory Folder Structure" on page 80.
 - An image that was rotated on the camera will be displayed on your computer screen in its original (unrotated) orientation.

- **Macintosh**

1. Double-click the camera's drive icon.

2. Double-click the "DCIM" folder to open it.

3. Double-click the folder that contains the images you want to view.

4. Double-click the image file you want to view.
 - For information about file names, see "Memory Folder Structure" on page 80.
 - An image that was rotated on the camera will be displayed on your Macintosh screen in its original (unrotated) orientation.

Precautions during Use

■ Avoid Use While In Motion

- Never use the camera to record or play back images while operating an automobile or other vehicle, or while walking. Looking at the monitor while in motion creates the risk of serious accident.

■ Flash

- Never use the flash unit in areas where flammable or explosive gas may be present. Such conditions create the risk of fire and explosion.
- Never fire the flash in the direction of a person operating a motor vehicle. Doing so can interfere with the driver's vision and creates the risk of accident.
- Never fire the flash too close to the eyes of the subject. Doing so creates the risk of loss of eyesight.

■ Monitor Screen

- Should the monitor screen ever become cracked, never touch any of the liquid inside the monitor screen. Doing so creates the risk of skin inflammation.
- Should monitor screen liquid ever get into your mouth, immediately rinse your mouth out and contact your physician.
- Should monitor screen liquid ever get into your eyes or onto your skin, immediately rinse with clean water for at least 15 minutes and contact your physician.

■ Connections

- Never plug any devices that are not specified for use with this camera into connectors. Connecting a non-specified device creates the risk of fire and electric shock.

■ Transport

- Never operate the camera inside of an aircraft or anywhere else where operation of such devices is restricted. Improper use creates the risk of serious accident.

■ **Smoke, abnormal odor, overheating, and other abnormalities**

- Continued use of the camera while it is emitting smoke or strange odor, or while it is overheating creates the risk of fire and electric shock. Immediately perform the following steps whenever any of the above symptoms are present.
 1. Turn off the camera.
 2. Remove the battery from the camera, taking care to protect yourself against burn injury.
 3. Contact your dealer or nearest CASIO authorized service center.

■ **Water and Foreign Matter**

- Water, other liquids, or foreign matter (especially metal) getting inside the camera creates the risk of fire and electric shock. Immediately perform the following steps whenever any of the above symptoms are present. Particular care is required when using the camera where it is raining or snowing, near the ocean or other body of water, or in a bathroom.
 1. Turn off the camera.
 2. Remove the battery from the camera.
 3. Contact your dealer or nearest CASIO authorized service center.

■ **Dropping and Rough Treatment**

- Continued use of the camera after it is damaged by dropping or other rough treatment creates the risk of fire and electric shock. Immediately perform the following steps whenever any of the above symptoms are present.
 1. Turn off the camera.
 2. Remove the battery from the camera.
 3. Contact your dealer or nearest CASIO authorized service center.

■ **Keep Away From Fire**

- Never expose the camera to fire, which can cause it to explode and creates the risk of fire and electric shock.

■ **Disassembly and Modification**

- Never try to take the camera apart or modify it in any way. Doing so creates the risk of electric shock, burn injury, and other personal injury. Be sure to leave all internal inspection, maintenance, and repair up to your dealer or nearest CASIO authorized service center.

■ Locations To Be Avoided

- Never leave the camera in any of the following types of locations. Doing so creates the risk of fire and electric shock.
 - Areas subject to large amounts of humidity or dust
 - Food preparation areas or other locations where oil smoke is present
 - Near heaters, on a heated carpet, in areas exposed to direct sunlight, in a closed vehicle parked in the sun, or other areas subject to very high temperatures
- Never place the camera on an unstable surface, on a high shelf, etc. Doing so can cause the camera to fall, creating the risk of personal injury.

■ Backing Up Important Data

- Always keep backup copies of important data in camera memory by transferring it to a computer or other storage device. Note that data can be deleted in the case of camera malfunction, repair, etc.

■ Memory Protection

- Whenever replacing the battery, be sure to follow the correct procedure as described in the documentation that comes with the camera. Incorrectly replacing the battery can result in corruption or loss of data in camera memory.

■ Rechargeable Battery

- Use only the USB-AC adaptor (AD-C53U) or the specified device to charge the battery. Attempting to charge the battery by an unauthorized means creates the risk of battery overheating, fire, and explosion.
- Do not expose or immerse the battery in fresh water or salt water. Doing so can damage the battery, and cause deterioration of its performance and loss of service life.
- The battery is intended for use with a CASIO Digital Camera only. Use with any other device creates the risk of the battery damage, or deterioration of battery performance and service life.
- Failure to observe any of the following precautions creates the risk of battery overheating, fire, and explosion.
 - Never use or leave the battery near open flame.
 - Do not expose the battery to heat or fire.
 - Never carry or store the battery together with items that can conduct electricity (necklaces, pencil lead, etc.).
 - Never disassemble the battery, pierce it with a needle, or expose it to strong impact (hit it with a hammer, step on it, etc.), and never apply solder to it. Never place the battery into a microwave oven, heater, high-pressure generating device, etc.

- Should you ever notice leakage, strange odor, heat generation, discoloration, deformation, or any other abnormal condition while using, charging, or storing a battery, immediately remove it from the camera and keep it away from open flame.
- Do not use or leave the battery under direct sunlight, in an automobile parked in the sun, or in any other area subject to high temperatures. Doing so can damage the battery, and cause deterioration of its performance and loss of service life.
- If battery charging does not end normally within the specified charging time, stop charging anyway and contact your local CASIO authorized service center. Continued charging creates the risk of battery overheating, fire, and explosion.
- Battery fluid can damage your eyes. Should battery fluid get into your eyes accidentally, immediately rinse them with clean tap water and then consult a physician.
- Be sure to read the user documentation that comes with the camera and special USB-AC adaptor before using or charging the battery.
- If a battery is to be used by young children, make sure that a responsible adult makes them aware of the precautions and proper handling instructions, and make sure that they handle the battery correctly.
- Should fluid from a battery accidentally get onto clothing or your skin, immediately rinse it off with clean tap water. Prolonged contact with battery fluid can cause skin irritation.

■ Battery Life

- Battery continuous operation times provided in this manual represent the approximate amount of time before the camera turns off due to low battery power when being powered by the special battery under normal temperature (23°C (73°F)). They do not guarantee that you will be able to achieve the indicated level of operation. Actual battery life is greatly affected by ambient temperature, battery storage conditions, the amount of time spent in storage, etc.
- Leaving the camera on can run down the battery and cause the low battery warning to appear. Turn off the camera whenever you are not using it.
- The low battery warning indicates that the camera is about to turn off due to low battery power. Charge the battery as soon as possible. Leaving a low or dead battery in the camera can lead to battery leakage and data corruption.

■ Data Error Precautions

Your digital camera is manufactured using precision digital components. Any of the following creates the risk of corruption of data in camera memory.

- Removing the battery or memory card while the camera is performing some operation
- Removing the battery or memory card while the LED indicator is lighting green after turning off the camera
- Disconnecting the USB cable while communication is in progress
- Shooting with a battery that quickly goes low right after it is charged
 - * Shooting with a battery that quickly goes low right after it is charged can also cause camera malfunction. Replace the battery with a new one immediately.
- Other abnormal operations

Any of the above conditions can cause an error message to appear on the monitor screen (page 81). Perform the action indicated by the message that appears.

■ Operating Environment

- Operating Temperature Requirements: 0 to 40°C (32 to 104°F)
- Operating Humidity: 10 to 85% (non condensation)
- Do not place the camera in any of the following locations.
 - In an area exposed to direct sunlight, or large amounts of moisture, dust, or sand
 - Near an air conditioner or in other areas subjected to extreme temperature or humidity
 - Inside of a motor vehicle on a hot day, or in an area subjected to strong vibration

■ Condensation

Sudden and extreme temperature changes, such as when the camera is moved from the outdoors on a cold winter day into a warm room, can cause water droplets called “condensation” to form on the interior and the exterior of the camera, which creates the risk of malfunction. To prevent condensation from forming seal the camera in a plastic bag before changing locations. Then leave the bag sealed to allow the air inside to naturally change to the same temperature as the air in the new location. After that, remove the camera from the bag and open the battery cover for a few hours.

■ Lens

- Never apply too much force when cleaning the surface of the lens. Doing so can scratch the lens surface and cause malfunction.
- You may sometimes notice some distortion in certain types of images, such as a slight bend in lines that should be straight. This is due to the characteristics of lenses, and does not indicate malfunction of the camera.

■ Caring for your camera

- Never touch the lens or flash window with your fingers. Finger smudges, dirt, and other foreign matter on the lens or flash window can interfere with proper operation of the camera. Use a blower or other means to keep the lens and flash window free of dirt and dust, and wipe gently with a soft, dry cloth.
- To clean the camera, wipe it with a soft, dry cloth.

■ Old Rechargeable Battery Handling Precautions

- Insulate the positive and negative terminals with tape, etc.
- Do not peel the covering off of the battery.
- Do not try to take the battery apart.

■ USB-AC adaptor Handling Precautions



- Never plug the power cord into an outlet whose voltage rating is different from that marked on the power cord. Doing so creates the risk of fire, malfunction, and electric shock.
 - Take care to protect the power cord against damage and breaking. Never place heavy objects onto the power cord, or expose it to intense heat. Doing so can damage the power cord, creating the risk of fire and electric shock.
 - Never try to modify the power cord, or subject it to severe bending, twisting, or pulling. Doing so creates the risk of fire, malfunction, and electric shock.
 - Never plug in or unplug the power cord while your hands are wet. Doing so creates the risk of electric shock.
 - Do not plug the power cord into an outlet or extension cord that is shared by other devices. Doing so creates the risk of fire, malfunction, and electric shock.
 - Should the power cord ever become damaged (to the point that internal wires are exposed or cut), immediately contact your original retailer or a CASIO authorized service center to request repair. Continued use of a damaged power cord creates the risk of fire, malfunction, and electric shock.
- The USB-AC adaptor becomes slightly warm during charging. This is normal and does not indicate malfunction.
 - Unplug the power cord from the power outlet when you are not using the USB-AC adaptor.
 - Never use detergent to clean the power cord (especially the plug).
 - Never cover the USB-AC adaptor with a blanket, etc. Doing so creates the risk of fire.

■ Other Precautions

The camera becomes slightly warm during use. This is normal and does not indicate malfunction.

■ Copyrights

Except for your own personal enjoyment, unauthorized use of use of snapshots or movies of images whose rights belong to others, without the permission of the right holder, is forbidden by copyright laws. In some cases, shooting of public performances, shows, exhibitions, etc. may be restricted entirely, even if it is for your own personal enjoyment. Regardless of whether such files are purchased by you or obtained for free, posting them on a website, a file sharing site, or any other Internet site, or otherwise distributing them to third parties without the permission of the copyright holder is strictly prohibited by copyright laws and international treaties. For example, uploading or distributing on the Internet images of TV programs, live concerts, music videos, etc. that were photographed or recorded by you may infringe upon the rights of others. Note that CASIO COMPUTER CO., LTD. shall not be held liable for use of this product in any way that infringes on the copyrights of others or that violates copyright laws.

The following terms, which are used in this manual, are registered trademarks or trademarks of their respective owners.

Note that trademark [™] and registered trademark [®] are not use within the text of this manual.

- SDXC Logo is a trademark of SD-3C, LLC.
- Microsoft, Windows, Windows Vista, Windows 7, and DirectX are registered trademarks or trademarks of Microsoft Corporation in the United States and other countries.
- Macintosh, Mac OS, and QuickTime are trademarks of Apple Inc.
- All other company or product names mentioned herein are registered trademarks or trademarks of their respective companies.

Any and all unauthorized copying, distribution, and transfer for commercial purposes of the software provided by CASIO for this product are prohibited.

Charging Precautions

■ If the camera's LED indicator starts flashing green at high speed...

- Ambient temperature or the temperature of the battery may be either too high or too low. Disconnect the USB cable and wait until temperature is within the allowable charging range before trying again.
- Battery contacts may be dirty. Wipe them with a dry cloth.
- Try connecting to a different computer USB port. Depending on the setup of your computer, you may not be able to charge the camera's battery over a USB connection.

If problems continue to occur after you perform the above steps, it could mean that the battery is faulty. Contact your nearest CASIO authorized service center.

Battery Precautions

■ Precautions during Use

- Operation provided by a battery under cold conditions is always less than operation under normal temperatures. This is due to the characteristics of the battery, not the camera.
- Charge the battery in an area where the temperature is within the range of 10°C to 35°C (50°F to 95°F). Outside this temperature range charging can take longer than normal or even fail.
- Do not tear or remove the battery outer label.
- If a battery provides only very limited operation following a full charge, it probably means the battery has reached the end of its service life. Replace the battery with a new one.

■ Storage Precautions

- Storing the battery for a long time while it is charged can cause deterioration of battery characteristics. If you do not plan to use a battery for some time, fully use up its charge before storing it.
- Always remove the battery from the camera when you are not using it. A battery left in the camera can discharge and go dead, which will require some time to charge when you need to use the camera.
- Store batteries in a cool, dry place (20°C (68°F) or lower).
- To prevent over discharging of an unused battery, fully charge it, and then load it in the camera and fully use up the charge about once every six months.

Using the Camera in another Country

■ Precautions during Use

- The bundled USB-AC adaptor is designed for operation with any power supply in the range of 100V to 240V AC, 50/60Hz. Note, however, that the shape of the power cord plug depends on each country or geographic area. Before taking the camera and USB-AC adaptor along on a trip, check with travel agent about the power supply requirements in your destination(s).
- Do not connect the USB-AC adaptor to a power supply through a voltage converter or similar device. Doing so can lead to malfunction.

■ Extra Batteries

- Taking along extra fully charged batteries (NP-80) is recommended while on a trip in order to avoid not being able to shoot images due to the battery going dead.

Memory Card Precautions

■ Using a Memory Card

- SD memory cards, SDHC memory cards, and SDXC memory cards have a write protect switch. Use the switch when you need to guard against accidentally deleting data. Note, however, if you write protect an SD memory card you must then turn write protection off whenever you want to record to it, format it, or delete any of its images.
- If a memory card starts to behave abnormally during image playback, you can restore normal operation by reformatting it (page 64). However, it is recommended that you always take along multiple memory cards whenever using the camera far away from the home or office.
- As you record data to and delete data from a memory card a number of times, it loses its ability to retain data. Because of this, periodic re-formatting of a memory card is recommended.
- Electrostatic charge, electrical noise, and other phenomena can cause data to become corrupted or even lost. Make sure that you always back up important data on other media (CD-R, CD-RW, hard disk, etc.).

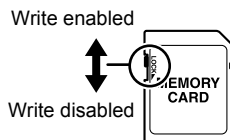

■ Discarding or Transferring Ownership of a Memory Card or the Camera

The format and delete functions of the camera do not actually delete files from the memory card. The original data remains on the card. Note that responsibility for the data on a memory card lies with you. The following procedures are recommended whenever you discard a memory card or the camera, or if you transfer ownership to another party.

- When discarding a memory card, either physically destroy the memory card or use commercially available data delete software to completely delete the data on the memory card.
- When transferring ownership of a memory card to another party, use commercially available data deletion software to completely delete the data on it.
- Use the format function (page 65) to completely delete the data in built-in memory before discarding or transferring ownership of the camera.

About Folder and File Names

Your camera automatically creates specific directory of folders in the internal memory (or memory card) to organize captured images and videos.

File Naming

File names begin with “IMG” and followed by a 4-digit number that increases in sequence. File numbering starts from 0001 when a new folder is created.

If the highest folder number is 999 and the highest file number exceeds 9999, the camera will display the warning message “Folder cannot be created”. When this happens, try one of the following ways:

- Reset the file number. See “Setting File Numbering” on page 64.

■ About DCF

The following operations are supported for DCF-compliant images. Note, however, that CASIO makes no performance guarantees concerning these operations.

- Transferring this camera’s DCF-compliant images to another manufacturer’s camera and view them.
- Printing this camera’s DCF-compliant images on another manufacturer’s printer.
- Transferring another camera’s DCF-compliant images to this camera and view them.

■ Memory Folder Structure

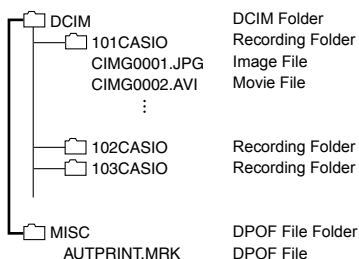

- Recording a video while  (Web) is selected for the Movie size setting causes a folder named “100TUBE” to be created for storage of movie files. This helps to simplify uploading to YouTube.

■ Supported Image Files

- Image files shot with this camera
- DCF-compliant image files

This camera may not be able to display an image, even if it is DCF-compliant. When displaying an image recorded on another camera, it may take a long time for the image to appear on this camera’s monitor screen.

■ Built-in Memory and Memory Card Data Handling Precautions

- Whenever copying memory contents to your computer, you should copy the DCIM folder and all of its contents. A good way to keep track of multiple DCIM copies of the DCIM folders is to change its name to a date or something similar after you copy it to your computer. If you later decided to return the folder to the camera, however, be sure to change its name back to DCIM. The camera is designed to recognize only a root file with the name DCIM. Note the camera also will not be able to recognize the folders inside the DCIM folder unless they have the names they originally had when you copied them from the camera to your computer.
- Folders and files must be stored in accordance with the “Memory Folder Structure” shown on page 80 in order for the camera to be able to recognize them correctly.
- You also can use a computer card adapter or a memory card reader/writer to access camera files directly from the camera’s memory card.

NOTE

- Do not change the folder and file names in the memory card using your computer. It may be unable to playback the data using the camera.

Troubleshooting

Problem	Cause and/or Action
Camera does not turn on.	The battery may be exhausted. Charge or replace the battery.
Camera turns off automatically.	Press the POWER button to turn on the camera.
LCD turns dark.	Press any button except the POWER button to turn on the LCD.
Empty battery icon is displayed on the LCD, then the camera turns off.	Battery is exhausted, please replace or recharge.
LCD monitor displays "No image".	There is no image file in the memory card. Image file format may not be supported.
LCD monitor displays "Not available for this file".	Function is only available for specific file types. File format is not supported.
LCD monitor displays "Memory full".	Memory card is full. Replace the memory card with a new one or delete unnecessary images.
LCD monitor displays "File locked".	This file is locked. Unlock the file. See "Protect" on page 54.
LCD monitor displays "Card locked".	The memory card is protected. Remove the card and slide the write-protect switch to its unlock position.
LCD monitor displays "Format error".	The card may be damaged. You can either change the card or wipe to clean the connected points.
LCD monitor displays "Copy error".	The memory card is protected. Remove the card and slide the write-protect switch to its unlock position. The memory card is full. Replace card or delete unnecessary files.
No image displays on the TV screen.	Incorrect TV-out type was selected. Set the correct TV-out type to match your TV system.

Problem	Cause and/or Action
The lens is stuck.	Do not force the lens to go back. The type of the battery used may be incorrect or the battery power level is too low. Change the battery or charge the battery before using the camera.
LCD monitor Displays “Auto Shutdown”.	The camera’s protection function may have activated because camera temperature is too high. Turn off the camera and wait until it cools down before trying to use it again.

Number of Snapshots/Movie Recording Time

Snapshot (Aspect ratio 4:3)

Image Size (Pixels)	Image Quality	Approximate Image File Size	Built-in Memory* ¹ Recording Capacity	SD Memory Card* ² Recording Capacity
14M (4320×3240)	Superfine	5.19MB	7	2669
	Fine	3.35MB	11	4225
	Normal	2.11MB	17	6310
8M (3264×2448)	Superfine	3.12MB	12	4627
	Fine	1.82MB	20	7252
	Normal	1.26MB	30	10798
5M (2592×1944)	Superfine	2.13MB	20	7252
	Fine	1.2MB	31	11300
	Normal	816KB	46	16755
3M (2048×1536)	Superfine	1.26MB	31	11300
	Fine	762KB	49	17354
	Normal	639KB	60	21126
VGA (640×480)	Superfine	183KB	183	60739
	Fine	147KB	211	69416
	Normal	131KB	249	80986

Movies

Image Quality (pixels)	Maximum File Size	Approximate Data Rate (Frame Rate)	Built-in Memory* ¹ Recording Capacity	SD Memory Card* ² Recording Capacity	File Size of 1-minute Movie
16:9 (1280×720)	Maximum Movie Size: 4 GB (or 29 minutes)	8Mbps (30 Frame)	24 seconds* ³	29 minutes	107MB
640 (640×480)	Maximum Movie Size: 4 GB	8Mbps (30 Frame)	36 seconds	53 minutes 5 seconds	72.5MB
320 (320×240)		4Mbps (30 Frame)	1 minute 9 seconds	1 hour 43 minutes 1 second	37MB
Web (640×480)	Maximum Movie Size: 1 GB (or 10 minutes)	8Mbps (30 Frame)	36 seconds	10 minutes	71.6MB

*1 Built-in memory capacity after formatting (Approx. 43.5MB)

*2 Based on a 16GB SDHC memory card (SanDisk Corporation). The number of images you can save depends on the type of memory card you are using.

*3 The data transfer rate of built-in memory is not sufficient for 16:9 video. Whenever possible use an Ultra High-Speed Type memory card.

- Snapshot and video recording capacity values are approximate and intended for reference only. Actual capacity depends on image contents.
- File size and data rate values are approximate and intended for reference only. Actual values depend on the type of image being shot.
- When using a memory card with a different capacity, calculate the number of images as a percentage of 16GB.

Specifications

File Format	Snapshots: JPEG (Exif Version 2.3); DPOF compliant Movies: Motion JPEG AVI, PCM audio (monaural)
Recording Media	Built-in Memory (Image Storage Area: 43.5MB) SD/SDHC/SDXC * Built-in memory capacity after formatting
Recorded Image Sizes	Snapshot: Aspect ratio 4:3 14M (4320×3240), 8M (3264×2448), 5M (2592×1944), 3M (2048×1536), VGA (640×480) Aspect ratio 3:2 14M (4320×2880), 8M (3264×2176), 5M (2592×1728), 3M (2048×1360), VGA (640×424) Aspect ratio 16:9 14M (4320×2424), 8M (3264×1832), 5M (2592×1456), 3M (2048×1152), VGA (640×360) Aspect ratio 1:1 14M (3744×3744), 8M (2832×2832), 5M (2240×2240), 3M (1728×1728), VGA (480×480) Movie: 16:9 (1280×720), 640 (640×480), 320 (320×240), Web (640×480)
Effective Pixels	14.10 Megapixels
Imaging Element	Size: 1/2.3-inch square pixel CCD Total Pixels: 14.53 Megapixels
Lens/Focal Distance	F2.8 (W) – F6.5 (T) / f= 4.7 to 23.5 mm (equivalent to 26 to 130 mm in 35 mm format)
Zoom	5x optical zoom, 5x digital zoom
Focusing	Contrast Detection Auto Focus • Focus Modes: Normal, Super Macro, Pan Focus, Infinity • AF Area: Wide/Center
Approximate Focus (Snapshot/video) (From Lens Surface)	Normal: 15 cm to ∞ (5.9" to ∞) (Wide Angle) 60 cm to ∞ (23.6" to ∞) (Telephoto) Super Macro: 5 cm to 50 cm (2.0" to 19.9") Infinity: ∞
Metering	Multi-pattern, center weighted, and spot
Exposure Control	Auto, Program AE
Exposure Compensation	-2.0 EV to +2.0 EV (in 1/3EV steps)
Shutter	CCD shutter, mechanical shutter
Shutter Speed	Snapshot (Auto): 1 to 1/2000 second

Aperture Value	F2.8 (W) to F7.9 (W) (When used with ND filter)
White Balance	Auto, Daylight, Cloudy, Tungsten, Fluorescent 1, Fluorescent 2, Custom
Sensitivity (Standard Output Sensitivity)	Snapshots: Auto, ISO 100, ISO 200, ISO 400, ISO 800, ISO 1600 Movies: Auto
Flash Modes	Auto, Red-eye Reduction, Forced On, Slow Sync, Forced Off
Flash Range (ISO Sensitivity: Auto)	Wide Angle: 0.5 m to 1.5 m (1.6' to 4.9') Telephoto: 0.6 m to 1 m (2.0' to 3.3')
Flash Charging Time	Approximately 5 seconds maximum
Monitor Screen	2.7-inch TFT color LCD 230,400 (960×240) dots
External connection terminal	USB port (Hi-Speed USB compatible, USB charging) / AV output terminal (NTSC/PAL)
Microphone	Monaural
Speaker	Monaural
Power Requirements	Rechargeable lithium ion battery (NP-80) ×1

Approximate Battery Life

All of the values provided below represent the approximate amount of time under normal temperature (23°C (73°F)) before the camera turns off. These values are not guaranteed. Low temperatures shorten battery life.

Number of Shots (CIPA) (Operating Time)*¹	190 shots
Continuous Playback (Snapshots)*²	5 hours
Approximate continuous video recording time*³	1 hour 20 minutes

- Battery: NP-80 (Rated Capacity: 700 mAh)
- Recording Medium: 16GB SDHC memory card (SanDisk Corporation)
- Measurement Conditions

*1 Approximate number of shots (CIPA) (Operating Time)

In accordance with CIPA (Camera and Imaging Products Association) standards Normal temperature (23°C (73°F)), monitor on, zoom operation between full wide and full telephoto every 30 seconds, during which two images are shot with flash; power turned off and back on every time 10 images are shot.

*2 Approximate playback time

Standard temperature (23°C (73°F)), one-image scroll approximately every 10 seconds

*3 Approximate time for a repeated cycle of 10 minutes recording followed by deletion of the recorded file.

- The above values are based a new battery, starting from a full charge. Repeated charging shortens battery life.
- Frequency of flash, zoom, and Auto Focus usage, and the time the camera is on greatly affects recording time and number of shots values.

Power Consumption 3.7 V DC, Approximately 2.9 W

Dimensions 99.6 (W) × 57.6 (H) × 23.6 (D) mm
(3.9" (W) × 2.3" (H) × 0.93" (D))

Weight Approximately 130g (4.6 oz)
(including battery and memory card*)
Approximately 113g (4.0 oz) (excluding battery and memory card)
* 16GB SDHC memory card (SanDisk Corporation)

■ Rechargeable lithium ion battery (NP-80)

Rated Voltage	3.7 V
Rated Capacitance	700 mAh
Operating Temperature Requirements	0 to 40°C (32 to 104°F)
Dimensions	31.4 (W) × 39.5 (H) × 5.9 (D) mm (1.24" (W) × 1.56" (H) × 0.23" (D))
Weight	Approximately 15g (0.53 oz)

■ USB-AC adaptor (AD-C53U)

Input Power	100 to 240 V AC, 50/60 Hz, 100 mA
Output Power	5.0 V DC, 650 mA
Operating Temperature Requirements	5 to 35°C (41 to 95°F)
Dimensions	53 (W) × 21 (H) × 45 (D) mm (2.1" (W) × 0.83" (H) × 1.8" (D)) (excluding projections)
Weight	Approximately 37g (1.3 oz)

- Power cord precautions for use in Singapore
The power cord set is not supplied. The power cord used must comply with relevant national and/or international standards.

CASIO®

CASIO COMPUTER CO., LTD.
6-2, Hon-machi 1-chome
Shibuya-ku, Tokyo 151-8543, Japan