



**Jayco**<sup>®</sup> Generations of family fun.

2015 GREYHAWK  
CLASS C MOTORHOMES

0188485.2015



PRINTED ON RECYCLED PAPER



# eCO advantage™

---

**THE JAYCO ECOADVANTAGE IS OUR COMPANY'S COMMITMENT TO PROTECTING THE ENVIRONMENT.** Through Jayco's company-wide sustainability program, we're creating better ways to build better RVs using fewer natural resources. Already, our initiative has created significant impact.

As of December 31, 2013 our company has:

## Recycled



- 6832 tons of wood
- 1138 tons of scrap metal
- 1262 tons of cardboard and paper

## Conserved



- 8,834,000 gallons of fresh water, enough to meet the daily needs of 11,787 Americans.
- 30,200 gallons of gas, enough for Americans to drive more than 845,600 miles.
- Enough electricity to power 2,895 homes for a year.

## Saved



- 56,200 mature trees.
- Enough landfill airspace to meet the annual disposal needs of a community of 39,290 people.

We're proud of our results, and we know those numbers show that a little initiative can go a long way. The Jayco EcoAdvantage is our way of making sure endless generations can enjoy the Great Outdoors..





**WARNING: READ ALL INSTRUCTIONS IN THIS MANUAL AND COMPONENT MANUFACTURER SUPPLIED INFORMATION BEFORE USING YOUR RV.**

This manual has been provided by Jayco, Inc. for the sole purpose of providing instructions concerning the operation and maintenance of this vehicle and its components. Nothing in this manual creates any warranty, either expressed or implied. The only warranty offered by Jayco, Inc. is as set forth in the limited warranty applicable to this vehicle.

The owner's failure to provide required service and/or maintenance could result in the loss of warranty. The owner should review Jayco's limited warranty and the limited warranties that apply to specific components that are offered with this vehicle.

Instructions are included in the manual for operating various components which are optional on some vehicles or may not be available on your particular model. "If so equipped" does not indicate or imply that the component(s) or option(s) were at any time available, or can be retrofitted to your model. In addition, the owner should refer to individual manufacturer's operating instructions contained in the owner's packet.

**Section 1: WARRANTY & SERVICE**

About This Manual ..... 1-1  
 Chassis Guide..... 1-1  
 Customer Relations..... 1-4  
 Customer Responsibility ..... 1-3  
 Dealer Responsibility ..... 1-3  
 Jayco Customer First Emergency Roadside Assistance ..... 1-6  
 JayPlus™ Extended Service Contract ..... 1-5  
 Jayco Travel Club ..... 1-5  
 Manufacturing Process ..... 1-3  
 Motorized Limited Warranty ..... 1-8  
 Motorized Rental Limited Warranty ..... 1-13  
 A Notice To Jayco Dealers..... 1-12  
 Obtaining Emergency Warranty Repair..... 1-6  
 Obtaining Service At Jayco ..... 1-7  
 Obtaining Service For Separately Warranted Items ..... 1-7  
 Replacement Parts..... 1-7  
 Reporting Safety Defects ..... 1-2  
 Safety Alerts..... 1-1  
 Suggestions For Obtaining Service..... 1-4  
 Update Your Contact Information..... 1-5  
 Warranty Packet..... 1-1

**Section 2: OCCUPANT SAFETY**

Combination Carbon Monoxide/Propane Alarm ..... 2-4  
 Cold Weather Usage..... 2-7  
 Condensation ..... 2-8  
 Extended Dry Camping ..... 2-7  
 Fire Extinguisher ..... 2-1  
 Fire Safety..... 2-1  
 Formaldehyde ..... 2-7  
 Other Fire Safety Information..... 2-1  
 Secondary Means Of Escape ..... 2-1  
 Smoke Alarm..... 2-2

**SECTION 3: PRE-TRAVEL INFORMATION**

Exterior Compartments ..... 3-1  
 Loading Your RV..... 3-1  
 Trailer Plug..... 3-4  
 Using The Rear Hitch..... 3-2  
 Vehicle Labels..... 3-1  
 Weighing Your Motor Home ..... 3-4  
 Weight Labels ..... 3-4

**SECTION 4: VEHICLE OPERATION**

Braking & Stopping ..... 4-3  
 Changing A Tire ..... 4-6  
 Child Safety Restraint Systems..... 4-2  
 Driver & Front Passenger Seat ..... 4-2  
 Emergency Stopping..... 4-7  
 Emergency Towing ..... 4-8  
 Entrance Door ..... 4-1

Front Axle Tire Alignment .....	4-4
Instrument Panel.....	4-3
Keys/Locks .....	4-1
Leveling Jacks .....	4-9
Parking Brake .....	4-4
Power Entry Door Step.....	4-1
Rear Vision Camera .....	4-10
Seat Belts .....	4-2
Side View Power Mirrors .....	4-3
Tires.....	4-4
Wheel Lugs/Wheel Liners.....	4-7
Wheel Bearings & Brakes.....	4-7

### **SECTION 5: SLIDEOUT SYSTEMS**

Operating the Slideout.....	5-1
Troubleshooting the Slideout .....	5-2

### **SECTION 6: 30 AMP ELECTRICAL SYSTEM**

120-volt Circuit Breakers .....	6-2
120-volt AC System .....	6-10
12-volt Battery Disconnect.....	6-4
12-volt DC Outlet (If So Equipped) .....	6-8
12-volt DC System.....	6-3
12-volt Fuse Panel.....	6-6
30 amp Power Cord.....	6-10
Approximate Electrical Load Ratings .....	6-9
Auxiliary Start System.....	6-3
Calculating Electrical Load .....	6-11
Chassis Batteries.....	6-5
Command Center .....	6-2
Electrical System Maintenance.....	6-1
Generator .....	6-6
GFCI Receptacle Outlet.....	6-3
House Batteries .....	6-4
In Case Of An Electrical Fire .....	6-1
Inverter (If So Equipped) .....	6-8
Isolator Solenoid.....	6-5
Power Converter.....	6-2
Replacing Light Bulbs .....	6-8

### **SECTION 7: FUEL & PROPANE SYSTEM**

Calculating Propane Usage.....	7-7
Cooking With Propane Gas .....	7-8
Exhaust Gas Fumes .....	7-2
Fuel Economy.....	7-2
Fuel Safety .....	7-1
Propane Gas Container.....	7-5
Propane Gas System.....	7-3
Propane Leak Test .....	7-4
Propane Safety Procedures.....	7-5
Traveling With Propane .....	7-9
Using The Propane System.....	7-7

**SECTION 8: PLUMBING SYSTEM**

12-volt Water Pump & Switch ..... 8-3  
 Bathroom Tub/Shower ..... 8-10  
 Black & Grey Tank Drains ..... 8-17  
 Black Tank Flush (If So Equipped)..... 8-18  
 Black/Grey Water Holding Tanks ..... 8-16  
 Black/Grey Water System ..... 8-16  
 City Water Fill..... 8-13  
 City Water Tank Fill..... 8-13  
 Country Water Fill ..... 8-13  
 Draining the Fresh Water System ..... 8-11  
 Faucets ..... 8-9  
 Fresh Water Holding Tank ..... 8-2  
 Fresh Water System ..... 8-1  
 Hardware & Sink or Shower Fixtures ..... 8-10  
 Monitor Panel..... 8-1  
 Outside Shower..... 8-9  
 Plumbing System Maintenance..... 8-1  
 Sanitization ..... 8-14  
 Toilet ..... 8-18  
 Utility Center ..... 8-12  
 Utility Center Normal Setting..... 8-14  
 Water Heater..... 8-3  
 Water Pressure Regulator (Customer Supplied) ..... 8-2  
 Water Purification System..... 8-11  
 Winterization ..... 8-15

**SECTION 9: HEATING & COOLING**

Air Conditioner ..... 9-1  
 Attic Fan..... 9-1  
 Ducting & Return Air ..... 9-1  
 Furnace..... 9-1  
 Thermostat ..... 9-1

**SECTION 10: APPLIANCES**

BBQ Grill (If So Equipped) ..... 10-3  
 Convection Microwave (If So Equipped) ..... 10-1  
 Cooking With Propane ..... 10-2  
 In Case of Grease Fire..... 10-3  
 Kitchen Range & Oven (If So Equipped)..... 10-2  
 Oven (If So Equipped)..... 10-3  
 Microwave..... 10-1  
 Refrigerator ..... 10-1

**SECTION 11: ELECTRONICS**

Exterior Television (If So Equipped)..... 11-2  
 Television Power Supply..... 11-1  
 Television Roof Antenna ..... 11-1

**SECTION 12: INTERIOR**

ABS Plastics ..... 12-4  
 Bed Storage ..... 12-2  
 Booth Dinette (If So Equipped) ..... 12-1



Cabinetry & Tables .....	12-3
Cleaning The Interior .....	12-1
Countertops .....	12-4
Décor Items .....	12-3
Flooring.....	12-4
Free Standing Table & Chairs (If So Equipped).....	12-2
Furniture Upholstery .....	12-2
Hide-A-Bed (If So Equipped) .....	12-1
Interior Wall Panel .....	12-4
J-Steel Sofa (If So Equipped) .....	12-1
Pantry (If So Equipped) .....	12-3
Privacy Drape Installation .....	12-3

### **SECTION 13: EXTERIOR**

Chassis Maintenance .....	13-4
Cleaning The Exterior .....	13-1
Exterior Roof & Sidewall Vents.....	13-4
Frame .....	13-4
Patio Awning.....	13-1
Roof Ladder (If So Equipped) .....	13-1
Sealants.....	13-4
Windows .....	13-4

### **SECTION 14: TRAVEL/CAMPING/STORAGE CHECKLISTS**

Maintenance Checklist.....	14-4
Motor Home Storage .....	14-2
Ready to Leave Checklist .....	14-1
RV Start-Up .....	14-1

### **SECTION 15: ADDITIONAL INFORMATION**

Featured Components Quick Reference Chart.....	15-1
Change of Address/Ownership Form.....	15-2

**THIS PAGE IS INTENTIONALLY BLANK**

---

***Congratulations!*** Thank you for selecting a Jayco RV. We are excited to welcome you to our growing RV family. Jayco is the largest privately held manufacturer of recreation vehicles in the world. We are committed to being the most respected name in RVs. We invite you to drop by our Visitors Center located in Middlebury, Indiana. To book a group tour or check our scheduled factory tour times (free admission, closed holidays) please call 1-800-RV-JAYCO.

## **ABOUT THIS MANUAL**

---

This manual is a guide to the operation and maintenance of your RV. Jayco RVs are available in several sizes and models, so accessories and components may differ. Some equipment described in this manual may not apply to your RV. If you find the components vary significantly from what is described, contact your dealer to ensure you have the correct information. Nothing in this manual creates any warranty, either expressed or implied, nor does it cover every possible detail of equipment, standard or option, installed on or in your RV.

*Information, illustrations and specifications in this manual reflect the most current available at the time of publication approval, are subject to change and not intended to indicate actual size.*

## **WARRANTY PACKET**

---

The Warranty Packet contains original equipment manufacturer (OEM) operator manuals, warranty cards and/or registrations. It is important you complete and mail the warranty cards and registrations within the prescribed time limits to avoid loss of warranty coverage. This manual and the Warranty Packet should be considered a permanent part of the RV. If the RV is sold, they should remain with the RV for the next owner.

## **CHASSIS GUIDE**

---

Throughout this manual, frequent reference is made to the vehicle's Chassis Guide.

The Chassis guide refers to the chassis manufacturer's owner manual, warranty cards and/or registrations. The chassis guide has pertinent information regarding the transmission, tires, etc. consult the Chassis Guide for operating safety, maintenance, servicing instructions and warranty coverage.

## **SAFETY ALERTS**

---

Your safety, and the safety of others, is very important. To help you make informed decisions, we have provided operating procedures and other information on safety labels affixed to your RV and in this manual.

Please call your dealer or Jayco Customer Service if you are unsure how to proceed. Always use the appropriate safety gear when servicing or maintaining your RV.



This is the safety alert symbol. It is used to alert you to potential personal injury hazards. Obey all safety messages that follow this symbol to avoid possible injury or death.

**DANGER**

This indicates an imminently hazardous situation which, if not avoided, will result in death or serious injury.

**WARNING**

This indicates a potentially hazardous situation which, if not avoided, will result in death or serious injury.

**CAUTION**

This indicates a potentially hazardous situation which, if not avoided, will result in minor or moderate injury.

**CAUTION**

This indicates a potentially hazardous situation which, if not avoided, may result in property damage

**REPORTING SAFETY DEFECTS****In the United States**

If you believe that your RV has an alleged defect that could cause a crash or cause injury or death, you should immediately inform the National Highway Traffic Safety Administration (NHTSA) and Jayco.

If NHTSA receives similar complaints, it may open an investigation, and if it finds that a safety defect exists in a group of vehicles it may order a recall and remedy campaign. However, NHTSA cannot become involved in individual problems between you, your dealer or Jayco. For additional information, please refer to the NHTSA website at [www.safercar.gov](http://www.safercar.gov).

*To contact NHTSA by phone:*

Call the Department of Transportation (DOT) Vehicle Safety Hotline at 1-888- 327-4236 and a NHTSA representative will record your complaint information (TTY: 1-800-424-9153 or 1-202-484-5238).

*To contact NHTSA by mail:*

Office of Defects Investigations/CRD  
NVS-216

1200 New Jersey Ave SE  
Washington, DC 20590

**In Canada**

If you believe your RV has an alleged safety defect, you should contact Transport Canada and Jayco. Transport Canada prefers to be called instead of posted mail or email as it enables their investigators to confirm that your information is correct, and to answer your questions accurately. For additional information, please refer to the Transport Canada website at [www.tc.gc.ca](http://www.tc.gc.ca).

*To contact Transport Canada by phone:*

Call 1-800-333-0510 (or 1-613-993-9851 if you are calling from the Ottawa region) and ask to speak to a defect investigator.

To contact Transport Canada by mail:

Road Safety and Motor Vehicle  
Regulation Directorate  
Transport Canada  
Tower C, Place de Ville  
330 Sparks Street  
Ottawa, Ontario K1A 0N5

## MANUFACTURING PROCESS



Jayco recreation vehicles are manufactured for use as temporary living quarters for recreation, camping and travel uses, all as defined by the bylaws of the Recreation Vehicle Industry Association (RVIA).

This recreation vehicle is not intended for use as a full-time residence or for commercial use. Commercial use means using the RV as a business asset such as a mobile office or using the RV for lease or rental purposes.

Jayco reserves the right to discontinue or change specifications or design at any time without notice and without incurring any obligation whatsoever. RV's built for sale in Canada may differ to conform to Canadian Codes.

## CUSTOMER RESPONSIBILITY

It is important you read and understand the information in this manual and your Warranty Packet using your RV.

Familiarize yourself with the applicable warranties. You are responsible for ensuring the procedures for obtaining warranty repair are followed properly. It is your responsibility and obligation to return your RV to your dealer for warranty service repair.

As the owner of the RV, you are responsible for regular and proper maintenance performed in accordance with this manual and the OEM manuals. Regular and proper maintenance will help prevent conditions arising from neglect that are not covered by warranty.

As with your other personal belongings, it is important to protect yourself and others with insurance coverage. Your insurance agent can assist you in obtaining the appropriate insurance coverage for personal liability, theft, collision, property damage, etc.

## DEALER RESPONSIBILITY

At the time of sale of the new RV, your dealer is expected to:

- Deliver your RV in the best condition possible. Your RV must pass the dealer's pre-delivery inspection (PDI), including all systems tests.
- Provide orientation of the RV, its systems, components and operation.
- Request that you read all warranty information and explain any provision not clearly understood.
- Ensure you receive the Warranty Packet. Your dealer can assist you in completing the OEM warranty cards or registrations, and locate any required component model or serial numbers.
- Complete and return the "Warranty Registration and Customer Delivery Form" to Jayco within 10 days of delivery to activate the applicable warranty coverage.

The **Motorized Limited Warranty** is activated only after Jayco receives a signed and dated “Warranty Registration and Customer Delivery Form” from your dealer.

## **SUGGESTIONS FOR OBTAINING SERVICE**

---

The independent dealers authorized to sell Jayco RVs are also there to provide service after the sale. We work closely with them in an effort to keep you satisfied. To help ensure your dealer provides the level of service you expect, here are some suggestions we would like to make:

**Contact your dealer at once...** Do not wait until you are ready to use your RV. Your dealer may not be able to service it immediately and/or the repair may require parts be ordered. The dealer's service department is busiest on Mondays, Fridays and before the holidays.

**Prepare for the appointment...** If you are having warranty work performed, be sure to have the right papers with you.

Take your warranty folder and have your vehicle information available. Not all the work to be performed may be covered by the warranty; discuss additional charges with the dealer's service management.

**Prepare a list...** Provide your dealer with a written list of specific repairs needed. It is important that you provide any vehicle repair history to the dealer's service manager. Keep a maintenance log of your RV service history. This can often provide a clue to the current issue.

**Be reasonable with your requests...** If you leave a list with several items and you need your RV returned back by a specific time, discuss the situation with the dealer's service management and list your items in order of priority. This may include making a second appointment for work not completed or parts that the dealer may need to order.

**Don't expect to look over the technician's shoulder...** Please do not be offended if you are told you cannot watch the work being done. Some insurance requirements forbid admission of customers to the service area.

**Inspect the work performed...** Finally, check out the service or repair job when you pick up your RV. Notify the dealer's service management immediately of any dissatisfaction. If you cannot return your RV immediately for repair, make an appointment as soon as possible.

Please be aware that all repair businesses require notification of any issues with their repairs within a specified time limit. Make sure you are familiar with your dealer or RV repair center's repair policies.

## **CUSTOMER RELATIONS**

---

Jayco has empowered its dealers to make warranty and repair decisions. If a special circumstance occurs that requires information from Jayco, we have asked your dealer's service management to make the contact on your behalf. **This is why you should always talk to your dealer's service management first.**

When making contact with your dealer, please provide the following information:

- Your name, location and phone number.
- Your RV 17-digit vehicle identification number (VIN).
- Your date of purchase.
- The name of your selling dealer.
  - If different from above, the contact information for the RV repair facility you are contacting Jayco to discuss.

- A detailed description of the concern.
- If applicable, the component description, serial number and model number.

**Mailing address**

Jayco, Inc.  
Customer Service  
P.O. Box 460  
903 S. Main Street  
Middlebury IN 46540

Phone (toll-free)

Phone (local)

Fax (toll-free)

Brochure request    info@Jayco.com

Parts email

Service email

Website

**Shipping address**

Jayco, Inc.  
Customer Service  
100 Bontrager Drive  
Bldg 42 Door 4220  
Middlebury IN 46540

(800) 283-8267

(574) 825-0608

(866) 709-9139

parts@Jayco.com

service@Jayco.com

www.Jayco.com

**An important note about alterations and warranties**

Installations or alterations to the original equipment vehicle as distributed by Jayco are not covered by the Motorized Limited Warranty. The special body company, assembler, equipment installer or upfitter is solely responsible for warranties on the body or equipment and any alterations (or any effect of the alterations) to any of the parts, components, systems or assemblies installed by Jayco. Jayco is not responsible for the safety or quality of design features, materials or workmanship of any alterations by such suppliers.

**UPDATE YOUR CONTACT INFORMATION**

Help keep your contact information current so that, in the event of a recall or customer notification letter, you are notified. Please copy and mail your completed "Change of Address or Ownership, Stolen, Totaled or Destroyed" form to Jayco.

If you purchased your RV as "used," include proof of ownership (i.e., a copy of your bill of sale, insurance policy, etc.).

**JAYCO TRAVEL CLUB**

All owners of Jayco RVs are eligible for membership in the Jayco Travel Club. The club promotes family camping and the active use of your RV with others who have similar interests in the RV lifestyle.



One "International Rally" is held each year in various locations around the United States and Canada. In addition, the club offers a variety of local and regional activities throughout the year.

By belonging to the Jayco Travel Club, you will find new ways to enjoy your RV and make friends all across the country. For more information, please visit [www.Jaycorvclub.com](http://www.Jaycorvclub.com) or call 1-800-262-5178.

**JAYPLUS™ EXTENDED SERVICE CONTRACT**

Don't let unexpected repair costs keep you from traveling toward your dreams. Protect yourself with a JayPlus™ Extended Service Agreement. For more information, contact your dealer or call 1-800-527-3426.



Your dealer can help you obtain a JayPlus™ insurance quote from GMAC Insurance or call 1-877-484-2261 (Savings Code: GL 2A).

### JAYCO CUSTOMER FIRST EMERGENCY ROADSIDE ASSISTANCE

---

Jayco has teamed up with Coach-Net to offer 24/7 motorist assistance. We are offering this free of charge for the first year of ownership (certain restrictions apply\*). You may continue your emergency roadside assistance benefits in the following years by contacting Coach-Net to discuss terms and rates for this independently continued coverage.

For details on accessing your emergency roadside assistance benefits, please refer to your Member Benefit Guide that is sent out 6-8 weeks after your completed "Warranty Registration and Customer Delivery Form" is received by Jayco, or contact Coach-Net ([www.coach-net.com](http://www.coach-net.com)) at 1-877-801-0333.

*\*To qualify for coverage, your RV must be eligible as set forth under the terms of the **Motorized Limited Warranty**.*

### OBTAINING EMERGENCY WARRANTY REPAIR

---

A roadside emergency can happen at any time, whether your RV is new or old. If you are traveling, using the following guidelines can help get you back on the road faster.

1. Call 1-800-RV-JAYCO or use our website dealer locator to find an authorized Jayco dealer in your area. Contact them for an appointment; they will handle all warranty repair billing and returned parts for you.
2. If you cannot locate an authorized Jayco dealer near you, ask the campground staff for referrals or check the local telephone yellow pages. Or contact Jayco Customer Service or your selling dealer for assistance in locating a repair facility.
  - a. Contact the RV repair facility to discuss your situation and make an appointment. Ask how their billing will be handled. They may choose to bill Jayco directly; otherwise, you are expected to pay them.
  - b. Have the RV repair facility inspect your RV. Either they or you must call Jayco Customer Service to discuss applicable warranty coverage prior to any repair work being performed.
  - c. Jayco Customer Service will issue an authorization number upon warranty repair approval and advise if any original parts need to be returned.
  - d. Once Jayco Customer Service has issued an authorization number, the RV repair facility may begin actual repair to your RV.
  - e. Inspect the completed repair work thoroughly. If you are not satisfied, communicate that immediately to the RV repair facility management. Make sure you are satisfied with the repair before you pay or leave the premises.
  - f. For reimbursement, either you or the RV repair facility must send a copy of your itemized repair bill and all requested return parts by UPS (regular ground, freight pre-paid) within 60 days of the completed repair date.

To expedite processing your warranty claim, include your name, address, phone number, RV 17-digit VIN and authorization number. If returning parts, include a copy of your return freight bill.



**Obtaining weekend or after business hours repair assistance**

If an authorized Jayco dealer is not located nearby, contact your selling dealer for assistance. If your dealer is closed, check with the campground staff or telephone yellow pages for an RV repair facility.

Have the item repaired and contact Jayco Customer Service immediately the following business day.

Failure to contact Jayco Customer Service, unauthorized or improper warranty repairs, or failure to return requested original parts may result in loss of reimbursements and/or loss of warranty.

**OBTAINING SERVICE FOR SEPARATELY WARRANTED ITEMS**

Your selling dealer is responsible for servicing your RV before delivery, and has an interest in your continued satisfaction. We recommend your dealer perform all inspection, warranty and maintenance services. Some dealers may be authorized service centers for those OEMs whose products are warranted separately and excluded from the **Motorized Limited Warranty**.

**OBTAINING SERVICE AT JAYCO**

Should your RV be in need of service, and your dealer recommend that the repairs be made at the Jayco Factory Service Center, your RV may be returned to us with the following guidelines\*:

- You or your dealer must make a confirmed appointment a minimum of 60 days prior to dropping off your RV at the Jayco Factory Service Center.
- The holding tanks must be emptied and rinsed. We have a dumping station available for customer use.
- The propane system and all electrical systems must be shut down and turned off. We are not responsible for discharged batteries or propane tanks.
- During the appropriate season, please ensure your RV is winterized.
- Unless prior approval has been obtained from the Jayco Factory Service Center, all personal items must be removed from the area where you are requesting service repair and the refrigerator emptied. We are not responsible for loss of food items.
- You are responsible for all transportation costs. You may need to arrange for alternative accommodations for some types of repairs. Please be prepared accordingly.

\*Jayco Customer Service occasionally utilizes local independent repair facilities. Your RV may be referred to or repaired by one of these local repair facilities.

**REPLACEMENT PARTS**

Parts for Jayco RVs are distributed exclusively by authorized Jayco dealers. Jayco does not sell parts retail direct or to non-authorized dealers. If an original part is no longer available, Jayco will try to provide an appropriate substitute.

**MOTORIZED LIMITED WARRANTY****WHAT AND WHO IS COVERED**

The Jayco warranty covers the “house portion” of this recreational vehicle (“RV”), when used only for its intended purpose of recreational travel and camping, for two (2) years, or the first twenty-four thousand (24,000) miles of use, whichever occurs first. It covers RV’s that are sold in, and remain in, the United States, U.S. Territories and Canada, only. The house portion means the living area of the RV assembled by Jayco. The warranty period begins on the date that the RV is delivered to the first retail purchaser by an independent, authorized dealer of Jayco, or, if the dealer places the vehicle in service prior to retail sale, on the date the RV is first placed in such service. In the event that a substantial defect in material or workmanship, attributable to Jayco, is found to exist during the warranty period, it will be repaired or replaced, at Jayco’s option, without charge to the RV owner, in accordance with the terms, conditions and limitations of this limited warranty.

This limited warranty applies to the first consumer purchaser only. All rights and limitations within this warranty are applicable to the original owner of the RV only. Jayco’s limited warranty only covers substantial defects in materials, components, or parts of the RV attributable to Jayco. It does not replace, modify, or apply to the warranties provided by the manufacturers that supply the products used by Jayco to assemble the RV, like the chassis. You may contact an independent, authorized dealer for details.

Jayco’s obligation to repair or replace defective materials or workmanship is the sole obligation of Jayco under this limited warranty. Jayco reserves the right to use new or remanufactured parts of similar quality to complete any work, and to make parts and design changes from time to time without notice to anyone. Jayco reserves the right to make changes in the design or material of its products without incurring any obligation to incorporate such changes in any product previously manufactured. Jayco makes no warranty as to the future performance of this RV, and this limited warranty is not intended to extend to the future performance of this RV, or any of its materials, components or parts. In addition, the RV owner’s obligation to notify Jayco, or one of its independent, authorized dealers, of a claimed defect does not modify any obligation placed on the RV owner to contact Jayco directly when attempting to pursue remedies under state or federal law.

**LIMITATIONS, EXCLUSIONS AND DISCLAIMER OF IMPLIED WARRANTIES**

**ANY IMPLIED WARRANTY THAT IS FOUND TO ARISE BY WAY OF STATE OR FEDERAL LAW, INCLUDING ANY IMPLIED WARRANTY OF MERCHANTABILITY OR ANY IMPLIED WARRANTY OF FITNESS, IS LIMITED IN DURATION TO THE DURATION SET FORTH IN THIS LIMITED WARRANTY AND IS LIMITED IN SCOPE OF COVERAGE TO THE SCOPE OF COVERAGE OF THIS LIMITED WARRANTY.**

Jayco makes no warranty of any nature beyond that contained in this limited warranty. Jayco does not authorize any person to create any other obligation or liability for it regarding this RV, and Jayco is not responsible for any representation, promise or warranty made by any dealer or other person beyond what is expressly stated in this limited warranty, and no one has the authority to enlarge, amend or modify this limited warranty. Any selling or servicing dealer is not Jayco’s agent, but an independent entity.

**JAYCO SHALL NOT BE LIABLE FOR ANY INCIDENTAL OR CONSEQUENTIAL DAMAGES THAT MAY RESULT FROM BREACH OF THIS LIMITED WARRANTY OR ANY IMPLIED WARRANTY. THIS EXCLUSION OF CONSEQUENTIAL AND INCIDENTAL DAMAGES SHALL BE INDEPENDENT OF ANY FAILURE OF THE ESSENTIAL PURPOSE OF ANY WARRANTY, AND THIS EXCLUSION SHALL SURVIVE ANY DETERMINATION THAT THIS LIMITED WARRANTY OR ANY IMPLIED WARRANTY HAS FAILED OF ITS ESSENTIAL PURPOSE.**

Some states do not allow limitations on how long an implied warranty lasts, or the exclusion or limitation of incidental or consequential damages, so the above limitations or exclusions may not apply to you.

## **HOW TO GET SERVICE**

To obtain warranty service the owner must do all of the following:

1. Notify an independent, authorized dealer of Jayco, or Jayco, of the substantial defect in material or workmanship attributable to Jayco, within the warranty coverage period designated above;
2. Provide the notification mentioned in (1), above, within ten (10) days of when the owner discovered, or should have discovered, the substantial defect in material or workmanship attributable to Jayco;
3. Promptly schedule an appointment with and take the RV to an independent, authorized dealer of Jayco, or Jayco, for repairs; and
4. Pay any freight or transportation costs, import duties, fees and all incidental expenses associated with obtaining warranty service.

For warranty service simply contact one of Jayco's independent, authorized service centers for an appointment and then deliver your RV to the service center on the specified appointment date. If you need assistance you may contact Jayco, at 903 S. Main Street, P.O. Box 460, Middlebury, Indiana 46540, Attn: Customer Service, (574) 825-5861, (800) 283-8267 or [www.jayco.com](http://www.jayco.com).

NOTE: Jayco does not control the scheduling of service work at the independent, authorized dealerships. You may encounter some delay in scheduling or completion of work. Also, you must notify the selling dealer at time of delivery to have work performed on any defect that occurred at the factory during manufacture at no cost to you as provided by this limited warranty. (See below under WHAT IS NOT COVERED).

If two (2) or more service attempts have been made to correct any covered defect that you believe impairs the value, use or safety of the RV, or if it has taken longer than thirty (30) days for those types of repairs to be completed, you must, to the extent permitted by law, notify Jayco directly, in writing, at the above address, of the unsuccessful repair(s) of the alleged defect(s) so that Jayco can become directly involved in making sure that you are provided service pursuant to the terms of this limited warranty.

## **WHAT IS NOT COVERED**

By way of example only, this limited warranty does not cover any of the following: defects in materials, components or parts of the RV not attributable to Jayco; items that are added or changed after the RV leaves the possession of Jayco; additional equipment or accessories installed at any dealership, or other place of business, or by any other party, other than Jayco; any RV used for rental or other commercial purposes (Note: It shall be concluded that the RV has been used for commercial and/or business purposes if the RV owner or user files a tax form claiming any business or commercial tax benefit related to the RV, or if the

RV is purchased, registered or titled in a business name); any RV sold or used outside the United States, U.S. Territories or Canada; any RV not used solely for recreational travel and camping; any RV purchased through auction or wholesale; any RV purchased from a dealer that is not an authorized dealer of Jayco; normal wear, tear or usage, such as tears, punctures, soiling, mildew, fading, or discoloration of exterior plastic or fiberglass, or soft goods, such as upholstery, drapes, carpet, vinyl, screens, cushions, mattresses and fabrics; the effects of condensation or moisture from condensation inside the RV or failure to provide adequate ventilation; mold or any damage caused by mold to the inside or outside of the RV; imperfections that do not affect the suitability of the RV for its intended purpose of recreational use or items that are working as designed but that you are unhappy with; problems, including water leaks, related to misuse, mishandling, neglect or abuse, including failure to maintain the RV in accordance with the owner's manual, or other routine maintenance such as inspections, lubricating, adjustments, tightening of screws and fittings, tightening of lug nuts, sealing, rotating tires; damage due to accident, whether or not foreseeable, including any acts of weather or damage or corrosion due to the environment, theft, vandalism, fire, or other intervening acts not attributable to Jayco; service items such as windshield wiper blades, lubricants, fluids, filters, etc.; damage resulting from tire wear or tire failure; defacing, scratches, dents, chips on any surface or fabric of the RV; damage caused by off road use, overloading the RV or alteration of the RV, or any of its components or parts; wheel alignment or adjustments to axles when caused by improper maintenance, loading or damage from road hazards, including off road travel, wheel damage or balancing or damage from tire failures. Also, any costs associated with obtaining service, including by way of example, travel costs, are specifically excluded from the coverage of this warranty.

In addition, this limited warranty does not cover any material, component or part of the RV that is warranted by another entity, including, by way of example, the automotive chassis and power train, steering, handling, braking, wheel balance, muffler, tires, tubes, batteries, gauges, generator, hydraulic jacks, inverter, converter, microwave, television, DVD/CD player, radio, speakers, television, refrigerator, range, hot water heater, water pump, stove, carbon monoxide detector, smoke detector, propane detector, furnace or any air conditioner. (Note: The written warranty provided by the manufacturer of the component part is the direct responsibility of that manufacturer).

Defects and/or damage to interior and exterior surfaces, trim, upholstery and other appearance items may occur at the factory. These items are usually detected and corrected at the factory or by the selling dealer prior to delivery to the retail customer. You must inspect your RV for this type of damage when you take delivery. If you find any such defect or damage you must notify the selling dealer at time of delivery to have these items covered by this limited warranty and to have work performed on the items at no cost to you as provided by this limited warranty.

### **EVENTS DISCHARGING JAYCO FROM OBLIGATION UNDER WARRANTY**

Certain things completely discharge Jayco from any obligation under this warranty and void it. By way of example, the following shall discharge Jayco from any express or implied warranty obligation to repair or replace any defect that results from: any rental or other commercial use or purchase of the RV (as defined in this warranty), any RV sold outside of, or used outside of, the United States, U.S. Territories or Canada, through an auction or wholesale or by a non-authorized dealer, any defect in a separately manufactured component part,

owner neglect or failure to provide routine maintenance (See Owner's Manual), unauthorized alteration, off road use, collision or accident, whether or not foreseeable, including any acts of weather or damage or corrosion due to the environment, theft, vandalism, fire, explosions, overloading in excess of weight ratings, and tampering with any portion of the RV, or any use of the RV as a semi-permanent or permanent home.

### **LEGAL REMEDIES**

Any action to enforce any portion of this limited warranty, or any implied warranty, shall be commenced within six (6) months after expiration of the warranty coverage period designated above. Any performance of repairs shall not suspend this limitation period from expiring. Any performance of repairs after the warranty coverage period has expired, or performance of repairs regarding anything excluded from coverage under this limited warranty shall be considered "good will" repairs, and they will not alter the express terms of this limited warranty, or extend the warranty coverage period or this limitation period. In addition, this warranty is not intended to extend to future performance, and nothing in this warranty, or any action of Jayco, or any agent of Jayco, shall be interpreted as an extension of the warranty period or this limitation period. Some states do not allow a reduction in the statute of limitations, so this reduction may not apply to you.

### **WARRANTY REGISTRATIONS**

Your warranty registration records should be completed and delivered to the manufacturers of component parts. The selling dealership will assist you in completing and submitting a delayed warranty start form for your chassis, which is included in your chassis paperwork, and in filling out the Jayco product warranty registration form. That form must be returned to Jayco within ten (10) days of your taking delivery of the RV. Your Jayco warranty will not be registered unless this warranty registration is completed and received by Jayco. Failure to file this warranty registration with Jayco will not affect your rights under this limited warranty as long as you can present proof of purchase, but it can cause delays in obtaining the benefits of this limited warranty, and it may inhibit any servicing facility's ability to provide proper repairs and/or part replacement.

### **CARE AND MAINTENANCE**

It is the owner's responsibility to perform proper care and maintenance of the RV, and to assure correct load distribution. For details regarding this, please see your Jayco owner's manual and the owner's manuals of the chassis manufacturer and other component part manufacturers. These outline various care and maintenance that is required to maintain your RV. Please review all manuals supplied with your RV, and contact your selling dealership or supplier of the component part if you have questions. Note: Failure to maintain the RV as noted in those manuals voids this limited warranty, and any damage to the RV as a result of your failure to perform such care, is not covered by this limited warranty.

**THIS WARRANTY GIVES YOU SPECIFIC LEGAL RIGHTS, AND YOU MAY ALSO HAVE OTHER RIGHTS THAT VARY FROM STATE TO STATE.**

### **JAYCO, INC.**

903 S. Main Street \* P.O. Box 460 \* Middlebury, IN 46540

Telephone: 574-825-5861 or 800-283-8267

---

**NOTICE TO JAYCO DEALERS**

---

Pages 8-11 of this Owner's Manual contains the warranty that applies to this RV.

However, if the Jayco dealer decides to use this RV for rental purposes, then the warranty contained in pages 8-10 will not apply to this RV. The rental warranty, located on pages 12-14, applies in that situation.

If, on the other hand, the Jayco dealer sells this RV to a retail customer then the rental warranty would not be applicable. **The rental warranty does not apply to retail consumers.**

Jayco's rental program is applicable to the following product lines:

- Redhawk
- Greyhawk
- Melbourne
- Seneca

If you have any questions regarding this, please contact Jayco Customer Service at (800) 283-8267 or (574) 825-0608.

**JAYCO MOTORIZED RENTAL LIMITED WARRANTY****WHAT AND WHO IS COVERED**

The Jayco warranty covers this recreational vehicle (“RV”), when used only for recreational travel and camping, including recreational travel and camping by renters of the Dealer, for one (1) year, or the first twelve thousand (12,000) miles of use. This limited warranty applies to the original Dealer only, and it is not transferable. The warranty period begins on the date that Dealer first places the RV in rental service. In the event that a substantial defect in material or workmanship, attributable to Jayco, is found to exist during the warranty period, Jayco will reimburse the Dealer either the reasonable costs of repair or the reasonable costs of replacement of the defect, (Jayco’s option), in accordance with the terms, conditions and limitations of this limited warranty.

Jayco’s obligation to reimburse Dealer for the reasonable costs of repair or replacement of defective materials or workmanship is the sole obligation of Jayco under this limited warranty. Jayco reserves the right to use new or remanufactured parts of similar quality to complete any work, and to make parts and design changes from time to time without notice to anyone. Jayco reserves the right to make changes in the design or material or its products without incurring any obligation to incorporate such changes in any product previously manufactured. Jayco makes no warranty as to the future performance of this RV, and this limited warranty is not intended to extend to the future performance of this RV, or any of its materials, components or parts. In addition, the Dealer’s obligation to notify Jayco, of a claimed defect does not modify any obligation placed on the Dealer to contact Jayco directly when attempting to pursue remedies under state or federal law.

**LIMITATIONS, EXCLUSIONS AND DISCLAIMER OF IMPLIED WARRANTIES**

**ANY IMPLIED WARRANTY THAT IS FOUND TO ARISE BY WAY OF STATE OR FEDERAL LAW, INCLUDING ANY IMPLIED WARRANTY OF MERCHANTABILITY OR ANY IMPLIED WARRANTY OF FITNESS, IS LIMITED IN DURATION TO THE DURATION OF THIS LIMITED WARRANTY AND IS LIMITED IN SCOPE OF COVERAGE TO THE SCOPE OF COVERAGE OF THIS LIMITED WARRANTY.** Jayco makes no warranty of any nature beyond that contained in this limited warranty. Jayco does not authorize any person to create any other obligation or liability for it regarding this RV, and Jayco is not responsible for representation, promise or warranty made by any dealer or other person beyond what is expressly stated in this limited warranty, and no one has the authority to enlarge, amend or modify this limited warranty. Any selling or servicing dealer is not Jayco’s agent, but an independent entity.

**JAYCO SHALL NOT BE LIABLE FOR ANY INCIDENTAL OR CONSEQUENTIAL DAMAGES THAT MAY RESULT FROM BREACH OF THIS LIMITED WARRANTY OR ANY IMPLIED WARRANTY. THIS EXCLUSION OF CONSEQUENTIAL AND INCIDENTAL DAMAGES SHALL BE INDEPENDENT OF ANY FAILURE OF THE ESSENTIAL PURPOSE OF ANY WARRANTY, AND THIS EXCLUSION SHALL SURVIVE ANY DETERMINATION THAT THIS LIMITED WARRANTY OR ANY IMPLIED WARRANTY HAS FAILED OF ITS ESSENTIAL PURPOSE.**

Some states do not allow limitations on how long an implied warranty lasts, or the exclusion or limitation of incidental or consequential damages, so the above limitations or exclusions may not apply to you.

## HOW TO GET SERVICE

To obtain reimbursement of warranty service the owner must do all of the following:

1. Notify Jayco of the substantial defect in material or workmanship attributable to Jayco, within the warranty coverage period;
2. Provide the notification mentioned in (1), above, within ten (10) days of when the owner discovered, or should have discovered, the substantial defect in material or workmanship attributable to Jayco;
3. Promptly and appropriately make the necessary repairs; and
4. Pay any freight or transportation costs, import duties, fees and all incidental expenses associated with obtaining warranty service.

If you need assistance you may contact Jayco, at P. O. Box 460, Middlebury, Indiana, 46540, Attn: Customer Service (574) 825-5861, (800) 283-8267 or [www.jayco.com](http://www.jayco.com). Also, you must notify Jayco within three (3) days of delivery to you to have work performed on any defect or damage to appearance items that occurred at the factory during manufacturer or during delivery at no cost to you as provided by this limited warranty. (See below under WHAT IS NOT COVERED).

If two (2) or more service attempts have been made to correct any covered defect that you believe impairs the value, use or safety of the RV, or if it has taken longer than thirty (30) days for those types of repairs to be completed, you must, to the extent permitted by law, notify Jayco directly, in writing, at the above address, of the unsuccessful repair(s) of the alleged defect(s) so that Jayco can become directly involved in making sure that you are provided service pursuant to the terms of this limited warranty.

## WHAT IS NOT COVERED

By way of example, only, this Limited Warranty does not cover any of the following: defects in materials, components or parts of the RV not attributable to Jayco; items that are added or changed after the RV leaves the possession of Jayco; additional equipment or accessories installed at any dealership, or other place of business, or by any other party, other than Jayco; any RV not used solely for recreational travel and camping; all soft goods, normal wear, tear or usage, such as tears, punctures, soiling, mildew, fading, or discoloration of exterior plastic, fiberglass, upholstery, drapes, carpet, vinyl, screens, cushions, mattresses and fabrics; the effects of condensation or moisture from condensation inside the RV and failure to provide adequate ventilation; mold or any damage caused by mold to the inside or outside of the RV; imperfections that do not affect the suitability of the RV for its intended purpose of recreational use or items that are working as designed but that you are unhappy with; problems related to misuse, mishandling, neglect or abuse, including failure to maintain the RV in accordance with the owner's manual, or other routine maintenance such as inspections, lubricating, adjustments, tightening of screws, tightening of lug nuts, sealing, rotating tires; damage due to accident, whether or not foreseeable, including any acts of weather or damage or corrosion due to the environment, theft, vandalism, fire, or other intervening acts not attributable to Jayco; service items such as windshield wiper blades, lubricants, fluids, filters, etc.; damage resulting from tire wear or tire failure; defacing, scratches, dents, chips on any surface or fabric of the RV; damage caused by off road use, overloading the RV or alteration of the RV, or any of its components or parts.



In addition, this limited warranty does not cover any material, component or part of the RV that is warranted by another entity, including, by way of example, the automotive chassis and power train, steering, handling, braking, wheel balance, muffler, tires, tubes, batteries, gauges, generator, hydraulic jacks, inverter, converter, microwave, television, DVD/CD player, radio, speakers, television, refrigerator, range, hot water heater, water pump, stove, carbon monoxide detector, smoke detector, propane detector, furnace or any air conditioner. (Note: the written warranty provided by the manufacturer of the component part is the direct responsibility of that manufacturer).

Defects and/or damage to interior and exterior surfaces, trim, upholstery and other appearance items may occur at the factory or during delivery of the RV to you. These items are usually detected and corrected at the factory. You must inspect the RV for this type of damage when you take delivery from Jayco. If you find any such defect or damage you must notify Jayco within three (3) days of delivery of the RV to you to have these items covered by this limited warranty and to have work performed on the items covered by this limited warranty.

### **EVENTS DISCHARGING JAYCO FROM OBLIGATION UNDER WARRANTY**

Certain things completely discharge Jayco from any obligation under this warranty and void it. By way of example, the following shall discharge Jayco from any express or implied warranty obligation to repair or replace any defect that results from: any defect in a separately manufactured component part, any neglect or failure to provide routine maintenance by you or anyone you rent the RV to (See Owner's Manual), unauthorized alteration, off road use, collision or accident, whether or not foreseeable, including any acts of weather or damage or corrosion due to the environment, theft, vandalism, fire, explosions, overloading in excess of weight ratings, and tampering with any portion of the RV.

### **LEGAL REMEDIES**

Any action to enforce any portion of this limited warranty, or any implied warranty, shall be commenced within six (6) months after expiration of the warranty coverage period designated above. Any performance of repairs shall not suspend this limitation period from expiring. Any performance of repairs after the warranty coverage period has expired, or performance of repairs regarding any thing excluded from coverage under this limited warranty shall be considered "good will" repairs, and they will not alter the express terms of this limited warranty, or extend the warranty coverage period or this limitation period. In addition, this warranty is not intended to extend to future performance, and nothing in this warranty, or any action of Jayco, or any agent of Jayco, shall be interpreted as an extension of the warranty or this limitation period. Some states do not allow a reduction in the statute of limitations, so this reduction may not apply to you.

### **WARRANTY REGISTRATIONS**

Your warranty registration records should be completed and delivered to the manufacturers of component parts, including the delayed warranty start form for the chassis, which is included in the chassis paperwork. The Jayco product warranty registration form must be returned to Jayco within ten (10) days of your taking delivery of the RV. Your Jayco warranty will not be registered unless this warranty registration is completed and received by Jayco. Failure to file this warranty registration with Jayco will not affect your rights under this limited warranty as long as you can present proof of purchase, but it can cause delays in obtaining the benefits of this limited warranty, and it may inhibit any servicing facilities' ability to provide proper repairs and/or part replacement.

**CARE AND MAINTENANCE**

It is your responsibility to perform proper care and maintenance of the RV, and to assure correct load distribution. For details regarding this, please see your Jayco owner's manual and the owner's manuals of the chassis manufacturer and other component part manufacturers. These outline various care and maintenance that is required to maintain your RV. Please review all manuals supplied with the RV, and contact Jayco or the supplier of the component part if you have questions. Note: failure to maintain the RV as noted in those manuals voids this limited warranty, and any damage to the RV as a result of your failure to perform such care, is not covered by this limited warranty.

THIS WARRANTY GIVES YOU SPECIFIC LEGAL RIGHTS, AND YOU MAY ALSO HAVE OTHER RIGHTS THAT VARY FROM STATE TO STATE.

**JAYCO, INC.**

903 S. Main Street \* P.O. Box 460 \* Middlebury, IN 46540  
Telephone: 574-825-5861 or 800-28

## SECONDARY MEANS OF ESCAPE (EXIT WINDOW)

---

The emergency egress window is designed to allow quick exit from the RV during an emergency if access to the main entrance door is not available.

- Make sure all occupants know how to open and operate the egress window before an emergency occurs.
- When pulling into your campsite, make sure the egress is not blocked by trees or other obstacles. Make sure the ground below the window is solid and can be used as an escape path.
- The Egress window must be locked during transit.

Do not remove the following label from your RV:



**Fig. 2.1 Emergency egress window label**

## FIRE SAFETY

---

If a fire does start, follow these basic safety rules:

1. Have everyone evacuate the motor home immediately.
2. After everyone is clear and accounted for, check the fire to see if you can attempt to put it out.
3. If it is large, or the fire is fuel-fed, get clear of the motor home and have the Fire Department handle the emergency.
4. Do not attempt to use water to put out the fire. Water can spread some types of fire, and electrocution is possible with an electrical fire.

## OTHER FIRE SAFETY INFORMATION

---

Refer to the following sections for additional fire safety information.

- See the Electrical Systems Section**, in case of an electrical fire.
- See the Appliance Section**, in case of a grease fire.

## FIRE EXTINGUISHER

---

Fire extinguishers are classified and rated by fire types, A, B, and C. These classifications identify the kinds of fires or burning materials they are designed to fight.

**Class A** – Solid materials such as wood, paper, cloth, rubber and some plastics.

**Class B** – Liquids such as grease, cooking oils, gasoline, kerosene or other flammable liquids.

**Class C** – Electrical such as electrical wires or other live electrical equipment.

A dry chemical fire extinguisher has been installed in your RV. It is suitable for extinguishing small fires of the Class B or C type only. We suggest you become thoroughly familiar with the operating instructions displayed on the side of the fire extinguisher.

**NOTE:** For information on how to use your fire extinguisher, refer to the fire extinguisher user's manual provided in your Warranty Packet.

### Inspection and Maintenance

Read and follow all instructions on the label and owner's manual provided by the fire extinguisher manufacturer.



#### WARNING

Do not check the pressure, test or practice using the fire extinguisher by squeezing the trigger, even briefly. The fire extinguisher is not rechargeable or refillable. Once used, it will gradually lose pressure and will not be fully charged for use in an emergency.



#### DANGER

Do not turn the electrical power back on or plug in any appliances after the use of a fire extinguisher. Please refer to the fire extinguisher's user manual for further instructions on maintenance and clean up.

### SMOKE ALARM

Some of the most common fire safety issues are burning candles, smoking in bed, leaving children unattended and cleaning with flammable fluids. The smoke detector is intended to help reduce those risks.

Your motor home is equipped with a smoke alarm that is listed for use in a recreation vehicle. They are not fool proof. Smoke alarms only work if they are operational and maintained.

Be sure to read, understand and follow the owner's information from the manufacturer of the smoke alarm included in your Warranty Packet, including information regarding the limited life of smoke alarms.

Please be aware the smoke alarm cannot detect fires if the smoke does not reach it. Anything preventing smoke from reaching the alarm may delay or prevent an alarm (i.e., a closed door may prevent smoke from reaching an alarm on the other side of the door, etc.).

There are instances when the smoke detector alarm may not be heard.

Although the detector alarm horn meets or exceeds current UL standards, it may not be heard for many reasons.

These include (but not limited to): a closed or partially closed door, the alarm may be drowned out by other noise like the TV, stereo, traffic, weather, air conditioner or other appliances.



#### WARNING

This smoke alarm will not alert hearing impaired residents. Special alarms with flashing strobe lights are recommended for the hearing impaired.

### Operation

The smoke alarm is operational once the battery is correctly installed. The LED light will indicate the battery is functioning properly. When the production of combustion is sensed, the smoke detector sounds a loud alarm that continues until the air is cleared. The LED light will also give a visual indication of a sounding alarm.

**How to test**

Stand at arm's length from the smoke alarm when testing as the alarm horn may be harmful to your hearing. The alarm horn is loud to alert you to an emergency. The test button will accurately test all functions. Never use an open flame from a match or lighter to test this smoke alarm.



A warning label is located near the smoke alarm (Fig. 2.2). Please do not remove the following label from your motor home.

**Fig. 2.2 Test smoke alarm**

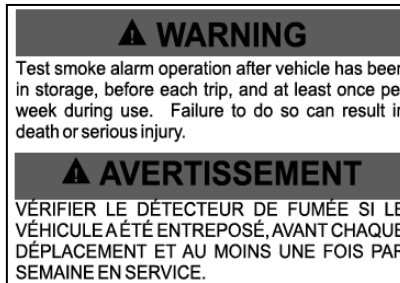
**Maintenance**

Gently vacuum off any dust on the cover of the smoke alarm with your vacuum's soft brush attachment. Test the smoke alarm once you have vacuumed. Never use water, cleaners or solvents to clean the smoke alarm as they may damage the smoke alarm. Do not paint the smoke detector. For information on how to maintain your smoke detector, refer to the smoke detector user's manual provided in the Warranty Packet.

**Battery**

The smoke alarm will not function if the battery is missing, disconnected, dead, the wrong type of battery is used or the battery is not installed correctly. The smoke detector requires one standard 9V battery.

When the battery becomes weak, the smoke alarm will "beep" about once a minute (the low battery warning). This low battery warning should last for 30 days, but you should replace the battery immediately to continue your protection.

When the battery is removed from the alarm, the battery flag in the compartment will pop up; therefore, the alarm cannot be installed to the mounting bracket without a battery.



Regardless of the manufacturer's suggested battery life, you **MUST** replace the battery once the smoke alarm starts "beeping" (the low battery warning).

For information on the correct battery and battery installation for your smoke detector, refer to the smoke detector user's manual provided in the Warranty Packet

### Replacement

Smoke alarms have a limited life and are not foolproof. Smoke alarms will wear out over time like any appliance. Always replace the detector immediately if it is not working properly, it displays any type of problem, or within five years of use. Refer to the smoke detector manufacturer's information in your Warranty Packet for additional information.

## COMBINATION CARBON MONOXIDE/ PROPANE ALARM

Your motor home is equipped with a combination carbon monoxide (CO)/propane alarm that is listed for use in recreation vehicles. The combination carbon monoxide/ propane alarm will only work if it is operational and maintained.

Be sure to read, understand and follow the owner's information from the manufacturer of the combination CO/propane alarm that has been supplied in your Warranty Packet. This includes information regarding the limited life of the alarm.

Carbon monoxide (CO) is an insidious poison. It is a colorless, odorless and tasteless gas. Many cases of reported carbon monoxide poisoning indicate while victims are aware they are not feeling well, they become so disoriented they are unable to save themselves by either exiting the vehicle or calling for assistance. Young children and household pets may be the first affected.



### WARNING

The following symptoms are related to carbon monoxide poisoning and should be discussed with all members of the household:

**Mild exposure:** Slight headache, nausea, vomiting, fatigue (often described as "flu-like" symptoms).

**Medium exposure:** Severe throbbing headaches, drowsiness, confusion, fast heart rate.

**Extreme exposure:** Unconsciousness, convulsions, cardio-respiratory failure, death.

Your combination carbon monoxide/propane alarm is designed to detect the toxic carbon monoxide fumes that result from incomplete combustion, such as those emitted from appliances, furnaces, fireplaces and auto exhaust. A carbon monoxide/propane alarm is **NOT A SUBSTITUTE** for other combustible gas, fire or smoke alarms.

This carbon monoxide alarm is designed to detect carbon monoxide gas from ANY source of combustion. It is not designed to detect smoke, fire or any other gas. Please note that there are hazards against which carbon monoxide detection may not be effective, such as natural gas leaks or explosions.

This alarm is designed to sense the presence of carbon monoxide/propane gas, however there are other combustible fumes or vapors that may be detected by the sensor including (but not limited to ): acetone, alcohol, butane and gasoline.

These chemicals can be found in commonly used items such as deodorants, colognes, perfumes, adhesives, lacquer, kerosene, glues, wine, liquor, most cleaning agents and the propellants of aerosol cans.

High temperatures can activate glue and adhesive vapors. If you close up a recreation vehicle on a hot day, the chemicals used in its construction may be detected for months after the vehicle was constructed (for more information, refer to Section 2, Formaldehyde).

**WARNING**

The carbon monoxide detector installed is intended for use in ordinary indoor locations of recreation vehicles. It is not designed to comply with Occupational Safety and Health Administration (OSHA) commercial or industrial standards.

Do not disconnect the battery or the alarm.

Individuals with medical problems may consider using warning devices that provide audible and visual signals for carbon monoxide concentrations under 30 PPM.

This alarm will only indicate the presence of carbon monoxide gas at the sensor. Carbon monoxide gas may be present in other areas.

The ultimate responsibility for protection against toxic carbon monoxide fumes rests solely on you. Installing a carbon monoxide/propane alarm is just the first step in protecting your family from toxic carbon monoxide poisoning

**⊗ NOTE:** The alarm is wired directly to the motor home 12-volt electrical system, with continual power being supplied by the motor home battery. There is no 9-volt battery power supply in the carbon monoxide/propane alarm. If the battery cable is disconnected at the battery terminals, the alarm will not work.

**What you should do if the alarm sounds****WARNING**

Actuation of this detector indicates the presence of carbon monoxide which can kill you.

1. Operate the RESET/SILENCE button.
2. Call your emergency services (fire department or 911).
3. Immediately move to fresh air (outdoors or by an open door or window).
4. Do not re-enter the premises or move away from the open door or window until the emergency service responders have arrived, the premises have been aired out, and your alarm remains in its normal condition.

If your alarm reactivates within a 24-hour period, repeat steps 1-4 and call a qualified appliance technician to investigate for sources of carbon monoxide from fuel burning equipment and appliances, and inspect for proper operation of this equipment. Make sure that motor vehicle(s) are not, and have not been, operating in an attached garage or adjacent to the motor home.

If problems are identified during this inspection, have the alarm serviced immediately. Note any combustion equipment not inspected by the technician and consult the manufacturer's instructions or contact the manufacturer directly for more information about carbon monoxide safety and this alarm.

### Alarm Signals

- ❑ **Normal Operation:** The LED will maintain a steady green light, indicating that the alarm is powered.
- ❑ **CO alarm condition:** The red LED light will remain steady and the alarm will sound 4 “BEEPS” then silent for 5 seconds. These signals indicate immediate action is required.
- ❑ **Propane gas alarm:** The red LED light will flash and the alarm will sound a steady tone. These signals indicate immediate action is required.
- ❑ **Alarm malfunction/low battery:** The gas LED will remain off and the Operational/CO LED will alternate re/green and the alarm will sound once every 15 seconds.
- ❑ **End of life alarm:** The LED will flash red/red, green/green and the alarm will “BEEP every 25-30 seconds. The alarm should be replaced immediately.



### WARNING

Never turn the 12-volt battery disconnect control to the off position and disconnect the battery cable to silence the alarm.



### WARNING

The alarm will automatically sense when the level of carbon monoxide in the air reaches below dangerous levels. You should stay outside the vehicle in fresh air until the alarm is silenced. When the alarm sounds, do not stand too close to the alarm. The sound produced by the alarm is loud because it is designed to wake a person in an emergency. Prolonged exposure to the alarm at a close distance may be harmful to your hearing.

### Maintenance

Vacuum the alarm cover at least once a year. Clean the cover by hand using a cloth dampened in clean water. Dry with a soft cloth. Do not spray the front panel of the alarm with cleaning agents or waxes. This action may damage the sensor causing an alarm or cause the alarm to malfunction. Do not paint the face of the alarm.

### Testing the combination carbon monoxide/ propane alarm



### WARNING

Test the alarm operation after the motor home has been in storage, before each trip and at least once per week during use.

The TEST/RESET button tests all ELECTRICAL functions of the alarm. The TEST/Mute switch is located on the front of the alarm. Press and hold the test button for 1 second. The alarm is working properly if the GREEN indicator light changes color to RED and the horn beeps 4 times. The Gas LED should also blink red.

⊗ **NOTE:** Pressing the test button does not check the sensor operation. Refer to the carbon monoxide/propane alarm manufacturers user’s manual provided in the Warranty Packet for additional information on testing the sensors.



Repair or replace the combination carbon monoxide/propane alarm when the alarm no longer functions. As with any electronic product, it has a limited life. Alarms that do not work cannot protect you.

⊗ **NOTE:** The carbon monoxide/propane alarm manufacturer strongly recommends replacement of the detector five years after the date of purchase.

### Further Information

Refer to the Warranty Packet for more information from the carbon monoxide/propane alarm manufacturer.

## FORMALDEHYDE

Some components in the motor home contain formaldehyde-based adhesives that may release formaldehyde fumes into the air for an unknown period of time. Individuals who are allergic to formaldehyde gas fumes may experience irritation to eyes, ears, nose and throat.

Indoor air quality may also be affected by leaving your motor home closed for a period of time.

To aide in dissipation, ventilate the motor home by opening all windows and circulate the air with a fan. The following label is located inside the motor home near the entry door. This label should be left permanently affixed to the motor home.

**Fig. 2.3 Formaldehyde warning label**



## EXTENDED DRY CAMPING

Your motor home has been built for enjoyment in a recreational manner. It is not intended to be used as full-time living quarters.

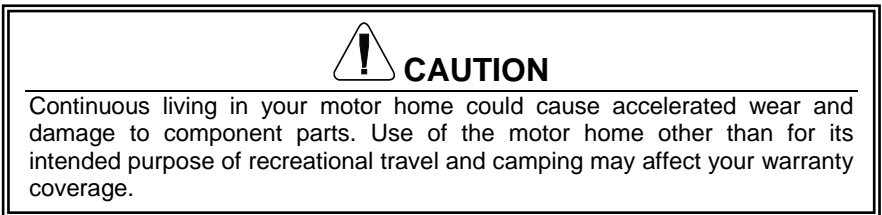

## COLD WEATHER USAGE

Proper care should be taken when planning to use your motor home in cold weather. Please keep in mind that your motor home was not designed for use during sub-freezing weather. When used in freezing or below freezing temperatures, the following precautions need to be taken:

- More protection will be needed to protect the fresh water and drainage systems to avoid freezing problems (see **Winterizing the Plumbing System**).
- Propane and sufficient power is needed for protection from possible freeze-ups on the propane regulator. Keep in mind that more frequent furnace operation will substantially increase battery draw and propane use.
- During cool weather usage, ventilation or the addition of a dehumidifier may be required to reduce condensation (see **Condensation**).

Check outside extrusions on compartment doors, locks, slide outs, windows, vents, etc., for frozen moisture before operating to avoid damage to parts.

## CONDENSATION



### WARNING

Condensation should be taken seriously. Ignoring it can damage the motor home (damage caused by condensation is not warrantable), and more importantly could lead to mold or mildew issues which could be a health hazard.

Condensation is a natural phenomenon. The amount of condensation will vary with climate conditions, particularly the relative humidity.

#### To reduce condensation

Proper ventilation and, if needed, the use of a dehumidifier (customer supplied) will assist in controlling condensation. Many RV and marine dealers carry small dehumidifiers sized for RV use. Other suggestions are:

- Crack open windows and roof vents to allow warm moist air to escape.
- When taking a shower open the bath roof vent (if so equipped) approximately ½" allowing the moisture to escape.
- Use the range hood fan (if so equipped) when cooking or washing dishes.
- Avoid hanging wet towels (or clothes) inside the motor home to dry.
- If condensation is found in cabinets or closets, open those doors slightly to equalize the temperature and provide ventilation.
- Uncontrolled condensation can cause dampness, mildew, etc., inside your RV. Be sure to make strong effort to control condensation. Repairs due to condensation are not covered under the terms of the **Motorized Limited Warranty** or the **Extended Limited Warranty**.

## VEHICLE LABELS

---

Decals and data plates used throughout the RV aid in its safe and efficient operation, or provide service instructions. Read all decals, data and instruction plates before operating your RV. If any decal, data or instruction plate is painted over, damaged or removed, it should be replaced.

## LOADING YOUR RV

---



### WARNING

Never load the RV in excess of the GAWR for either axle. **Overloading your RV may result in adverse handling characteristics and damage to the chassis.**

When loading heavy objects keep them as low as possible, preferably on the floor. Distribute cargo side-to-side so the weight on each tire does not exceed one-half of the GAWR for either axle. Store and secure all loose items inside the motor home before traveling.

Overlooked items such as canned goods, small appliances on the countertop, cooking pans on the range or free-standing furniture items can become dangerous projectiles during a sudden stop.



### WARNING

For traveling safety, it is important to make sure the tie down straps are secured on all appliances such as the toaster, coffee maker, etc. Vibration during travel will move the appliances, creating the potential for them to fall out of their cabinets possibly causing injury.

## EXTERIOR COMPARTMENTS

---



### WARNING

Your recreation vehicle's load capacity is designated by weight, not by volume, so you cannot necessarily use all available space when loading the vehicle. Do not exceed your GVWR and ensure you are loading the vehicle as evenly as you can for the best possible handling. Ensure heavy items are secured so they do not shift during travel.



### WARNING

Store items in areas designated for storage. Do not store anything in the areas reserved for the converter, electrical panels or the furnace or water heater, etc.

**WARNING**

The actual weight of the vehicle, passengers, all options, liquids, the hitch weight of your towed vehicle and your personal cargo is important for you to know so you do not exceed the Gross Vehicle Weight Rating (GVWR) of the motor home. The volume of space available for storage may exceed the amount of available cargo capacity. Large storage compartments have been designed to accommodate normal camping items, which are bulky, but not necessarily heavy.

**WARNING**

**DO NOT EXCEED YOUR GVWR!** This means you should weigh your RV as loaded for your normal travel to determine the actual weight.

**WARNING**

If you exceed the GVWR, you **MUST** remove items from the RV, or drain liquids, then re-weigh the vehicle to ensure you have achieved a safe weight. Weight labels are posted inside your motor home so you can make a decision before you buy about how much cargo capacity is important for you personally.

**USING THE REAR HITCH**

The motor home is designed primarily as a recreation vehicle. Any towing will affect vehicle handling, durability and fuel economy. Exceeding any of the listed weight ratings will result in unacceptable overall vehicle performance. Your safety and satisfaction require proper use of correct equipment.

The factory installed towing hitch on this vehicle is capable of pulling 5,000 lbs. of load (maximum), however the vertical (tongue) weight will vary according to the towed vehicle. A hitch bar of appropriate strength and steel should be selected to match the towing receptor.

Always use safety chains between the motor home and the towed trailer or vehicle. Cross the chains under the tongue and allow for slack when turning corners. Connect the safety chains to the vehicle frame or hook retainers. Never attach the safety chains to the bumper.

Before descending a steep or long grade when towing a trailer or vehicle, reduce speed and shift the motor home into a lower gear to control vehicle speed. Avoid frequent or prolonged brake application, which can cause overheating or brake failure.

By definition the GCWR is "the maximum total weight rating allowed for a vehicle and any attachment, such as a trailer or towed vehicle. To determine the total allowable weight for a towed item, subtract the GVWR from the GCWR.

Do not remove the following label:

**▲WARNING:**

YOUR MOTORHOME CHASSIS BRAKING SYSTEM IS RATED FOR OPERATION AT GVWR, NOT GCWR. CONSULT YOUR OWNER'S MANUAL(S) FOR SPECIFIC WEIGHING INSTRUCTIONS AND TOWING GUIDELINES. THE BRAKING CAPACITY OF YOUR MOTORHOME IS NOT NECESSARILY AS GREAT AS THE TOWING CAPACITY. SEPARATE BRAKING SYSTEMS MAY BE NECESSARY FOR CONTROL OF A TOWED VEHICLE. (AUTO, TRAILER, BOAT, ETC.) BEHIND THE MOTORHOME. IF THE TOWED VEHICLE MEETS OR EXCEEDS THE MINIMUM WEIGHT AS DETERMINED BY THE CHASSIS MANUFACTURER (THIS MINIMUM WEIGHT RATING WILL VARY BY CHASSIS AND CHASSIS MANUFACTURER), CONTACT YOUR CHASSIS DEALER OR MANUFACTURER FOR ASSISTANCE IN DETERMINING WHETHER A SEPARATE BRAKING SYSTEM IS RECOMMENDED AND WHAT LIMITS THERE ARE FOR YOUR TOWING COMBINATION AND TRAVELING SAFETY.

**Fig. 3.1 Towing and braking label**

**WARNING**

**Total weight of your motor home and any trailer or vehicle towed by it must not exceed the GCWR.** Do not assume that you can tow a RV that happens to be within the capacity of the tow vehicle hitch. By doing so, you may exceed the total GCWR of the motor home.

**WARNING**

**The total weight of your motor home (including cargo, passengers, fluids, etc.) in addition to the vertical (tongue) weight must not exceed the GVWR and/or any GAWR.** Once again, do not assume that you can tow a trailer or vehicle that happens to be within the vertical (tongue) weight capacity of the hitch. By doing so, you may exceed the GVWR and/or GAWR of the motor home

In addition, a separate supplemental braking system must be installed if the towed trailer or vehicle meets or exceeds the minimum weight determined by the chassis manufacturer (this minimum weight rating will vary by chassis and chassis manufacturer).

Contact your dealer for assistance in determining whether a separate braking system is recommended for your towing and traveling safety. Failure to follow these instructions will create a safety hazard and may result in an accident.

**WARNING**

**Your motor home chassis braking system is rated for operation at GVWR, NOT GCWR.** Any trailer or vehicle being towed by your motor home must have adequate brakes as required by all state (or province) and local regulations for towing with your motor home, including areas you may be traveling through.

**Maintenance**

Keep the hitch clean along with your general frame maintenance.

- ❑ At the beginning of the season, and monthly or thereafter, clean the inside of the receiver tube with a wire brush and spray with a silicone spray.
- ❑ Always remove the utility mount from the receiver when it is not in use. This will help prevent the utility mount from rusting to the tube.
- ❑ Periodically check the bolts for tightness. They need to be torqued to the proper setting (refer to your Chassis Guide).

**TRAILER PLUG**

If you choose to tow behind your RV, a chassis manufacturer supplied 7-way trailer plug (located at the hitch) is pre-wired into your motor home. Wiring to operate your towed vehicle brakes must be the same size in both the towed vehicle and the motor home.

White	1	Ground
Blue	2	Brakes
Green	3	Running lights
Black	4	House batteries charge line
Red	5	Stop & left turn
Brown	6	Stop & right turn
Yellow	7	Back up

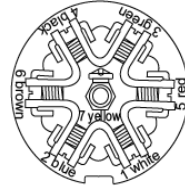

**Fig. 3.2**  
7-way trailer plug  
Car end, rear view

**Maintenance**

The connector plug may build up corrosion with extended use and should be cleaned periodically to insure good electrical contact. Make sure the connector plug is kept clean and protected from road elements as you travel.

**WEIGHT LABELS**

**WARNING**

The factory-installed weight labels are specific to the recreation vehicle for which they are supplied and are not interchangeable.

Vehicle weight labels are posted on Jayco manufactured RVs so you can make an informed decision before your purchase. Do not remove these labels from your RV. If the labels are missing, contact your dealer or Jayco Customer Service for replacements

MOTOR HOME OCCUPANT AND CARGO CARRYING CAPACITY

VIN: \_\_\_\_\_

THE COMBINED WEIGHT OF OCCUPANTS AND CARGO SHOULD NEVER EXCEED:  
XXXX kg. OR (XXXX Lbs)  
SAFETY BELT EQUIPPED SEATING CAPACITY: X

CAUTION:  
A FULL LOAD OF WATER EQUALS XXXX kg. OR (XXXX Lbs.) OF CARGO @ 1 kg/L (8.3 Lb/gal)  
AND THE TONGUE WEIGHT OF A TOWED TRAILER COUNTS AS CARGO

THE WEIGHT OF THIS RECREATION VEHICLE MOTOR HOME AS COMPLETED AT THE FACTORY WITH  
FULL PROPANE TANK AND FULL ENGINE FUELS IS:  
XXXXX kg. OR (XXXXX Lbs.)

THE GCWR OF THIS RECREATION VEHICLE MOTOR HOME IS: XXXXX kg. OR (XXXXX Lbs)

CONSULT YOUR DEALER AND SEE OWNER'S MANUAL FOR DEFINITIONS, ADDITIONAL WEIGHT  
LOADING, WEIGHING INFORMATION AND TOWING GUIDELINES INCLUDING AUXILIARY BRAKE  
REQUIREMENTS FOR ANY TOWED TRAILER OR VEHICLE.

**Fig. 3.3** Federal Certification label

<b>MANUFACTURED BY: JAYCO, INC.</b>		<b>DATE:</b> _____
FABRIQUE PAR:		
INC. VEHICULE FABRIQUE PAR:	VIRGINIA	PAYS D'ORIGINE:
OEM REFERENCE:	SÉRIE CHASSIS:	PAYS DE DESTINATION:
GROSS POND:	FRONT END WT:	PES. PO. AV.
_____ KG	_____ INT. CENTRAL:	PES. PO. AR.
_____ KG	_____ SEC. MARCHES:	PES. PO. AR.
TYPE DE VEHICULE: (S) CAMIONNETTE (M) CAMIONNETTE (T) CAMIONNETTE (L) CAMIONNETTE (R) CAMIONNETTE (S) CAMIONNETTE (M) CAMIONNETTE (T) CAMIONNETTE (L) CAMIONNETTE (R)		
LE VEHICULE CONFORME A TOUTES LES EXIGENCES DES REGLEMENTS EN VIGUEUR AU CANADA ET AUX ETATS UNIS AU 15 JANVIER 2000.		
THIS VEHICLE CONFORMS TO ALL APPLICABLE U.S. FEDERAL MOTOR VEHICLE SAFETY STANDARDS AND STANDARD REGULATIONS UNDER THE CANADIAN MOTOR VEHICLE SAFETY REGULATIONS EFFECT ON THE DATE OF MANUFACTURE HEREIN.		
LE VEHICULE CONFORME A TOUTES LES NORMES QUE LES SONT APPLICABLES EN VERTU DU REGLEMENT SUR LA SECURITE DES VEHICULES AUTOMOBILES DU CANADA EN VIGUEUR A LA DATE SA FABRICATION CI-DESSUS.		

**Fig 3.4** Motor home Weight Information label

**WEIGHING YOUR MOTOR HOME**

Now that your RV is loaded you should have it weighed. The actual weight of the RV, passengers, all options, liquids, the hitch weight of your towed vehicle and your personal cargo is important for you to know so you do not exceed the GVWR. There are two important factors when loading your RV: total weight and balance.

It is imperative that you verify compliance within all applicable weight ratings. Overloading your RV will void the **Motorized Limited Warranty** and the warranties of many component part manufacturers.

**Have your RV weighed periodically at a public scale to determine the proper load distribution.** Keep in mind that individual scales will operate differently. The surroundings of the scale need to be adequate to accommodate weighing each side of your RV.

There are three basic types of public scales. Each type of scale involves a different procedure in weighing the motor home. Your motor home must remain as level as possible on the scale (even if the axle is not physically on the scale). To obtain the side-to-side weights, make sure there is enough space on either side of the scale to accommodate the motor home being partially off the scale.

If a boat, trailer or other vehicle is being towed, it should be weighed separately. This weight should be combined with the motor home's Gross Vehicle Weight (GVW) to ensure the total combined weight does not exceed the GCWR.

Once actual weights are obtained, it is now possible to compare them to the **Weight Information Label** weight ratings to ensure you are below the posted minimum ratings.

If there is a difference in the weights on one side of the vehicle as compared to weights on the other side, components (tires, wheels, brakes, springs, etc.) on the heavier side may be overloaded although the total axle load is within the GAWR.



### CAUTION

It is important to redistribute the load to avoid component failure as well as to improve the handling characteristics of the vehicle.



### WARNING

Dump the gray and black water holding tanks before traveling to avoid carrying unnecessary weight. Traveling with the tanks full can affect your fuel consumption, and depending on the location of the tanks, can affect your vehicle handling characteristics. If you are dry camping and cannot immediately empty your holding tanks, reduce your vehicle speed until you reach a dumping station.

The motor home towing and braking label is located both at the exterior, on or near the hitch receiver bar, and in the interior, adjacent to or immediately below the RVIA weight information label on the back of an interior cabinet door (typically in the kitchen area).

Both labels should be kept permanently affixed to the motor home.

**⚠WARNING:**

YOUR MOTORHOME CHASSIS BRAKING SYSTEM IS RATED FOR OPERATION AT GVWR, NOT GCWR. CONSULT YOUR OWNER'S MANUAL(S) FOR SPECIFIC WEIGHING INSTRUCTIONS AND TOWING GUIDELINES. THE BRAKING CAPACITY OF YOUR MOTORHOME IS NOT NECESSARILY AS GREAT AS THE TOWING CAPACITY.

SEPARATE BRAKING SYSTEMS MAY BE NECESSARY FOR CONTROL OF A TOWED VEHICLE, (AUTO, TRAILER, BOAT, ETC.) BEHIND THE MOTORHOME. IF THE TOWED VEHICLE MEETS OR EXCEEDS THE MINIMUM WEIGHT AS DETERMINED BY THE CHASSIS MANUFACTURER (THIS MINIMUM WEIGHT RATING WILL VARY BY CHASSIS AND CHASSIS MANUFACTURER), CONTACT YOUR CHASSIS DEALER OR MANUFACTURER FOR ASSISTANCE IN DETERMINING WHETHER A SEPARATE BRAKING SYSTEM IS RECOMMENDED AND WHAT LIMITS THERE ARE FOR YOUR TOWING COMBINATION AND TRAVELING SAFETY.

**Fig. 3.5 Towing and  
braking label**



**Driving** safety and protection against injury cannot be fully ensured. However, we recommend you pay special attention to the following:

- ❑ The use of daytime running lights can increase other motorists' awareness of the motor home to all traffic.
- ❑ Keep the tires inflated to the specified levels. Replace the tires before they are excessively worn.
- ❑ Driving with the propane system on can add to the danger if you are involved in an accident or have a fire. Most refrigerators will keep food cold or frozen for eight hours without running while you travel. Shut the propane system off at the propane cylinder.
- ❑ Adverse weather conditions and extremes in terrain may affect the performance and handling of your vehicle. Do not operate the vehicle cruise control on icy or extremely wet roads, winding roads, in heavy traffic or in any other traffic situation where a constant speed cannot be maintained.

### KEYS/LOCKS

Several keys are provided when you purchase your motor home. Most keys have an individual key number stamped on the plate. Record these key numbers and keep the information in safe place. To have duplicate keys made, or replace lost keys, order a key blank from your dealer.

**⊗ NOTE:** Locks on entrance and baggage doors need biannual lubrication using a light coat of silicone spray. Conditions such as rain, salt, dust and pollution may increase the maintenance needs.

### ENTRANCE DOOR

We have included an assist grab handle at the motor home entrance door. The interior portion of the entrance screen door is equipped with a plastic slide panel that allows access to the entrance door handle and locks. The entrance door has both a regular door lock and a dead bolt lock.

Always hold onto the entry door when opening or closing it. Damage caused by the entry door catch and holder because you failed to do so is not covered by the **Motorized Limited Warranty**.

### POWER ENTRY DOOR STEP

The electric door step opens automatically when the screen door is opened. Constant 12-volt power to the electric step is supplied through a circuit breaker (generally located inside the battery box near the auxiliary start solenoid.)



### WARNING

When opening the door from the outside, make sure you are not obstructing the path of the entrance step. Step deployment takes approximately two seconds. Keep hands and fingers clear while extending or retracting the entry door step.

**LOOK BEFORE ENTERING OR EXITING YOUR MOTOR HOME!**

**DRIVER & FRONT PASSENGER SEAT****WARNING**

Do not adjust the seat while driving. After adjusting the seat, make sure that it is locked in position. To ensure that the seat is locked securely, try to move the seat forward or backward without using the adjusting lever or button.

Do not put packages, pets or other objects between the driver's and front passenger co-captain's seat.

**SEAT BELTS****WARNING**

Legislation in some states may require you to use seat belts, but even if it is not required, a seat belt should always be worn by anyone who drives or rides in this vehicle.

- Never use one seat belt for more than one occupant. Never carry more people in the motor home than there are seat belts.
- Only seats equipped with seat belts are to be occupied while the vehicle is in motion. While traveling, do not occupy beds or any seats that do not have seat belts.
- Be sure to lock all doors before driving. Locking the doors and using the provided seat belts will minimize the risk of injury or ejection in an accident.
- If you are pregnant, consult your health care professional for advice on seat belt use.

Seat belts are installed to protect the driver and passengers. Always use seat belts. In an accident, injury to the driver and passengers may be reduced if seat belts are properly used.

The booth dinette, sofa and chair(s) have two-point lap-seat belts installed. These seat belts should be used in all seating positions.

**Maintenance and inspection of seat belts**

The webbing used in seat belts may be cleaned with a mild soap or detergent solution.

Allow the belts to dry in the shade and do not allow them to retract until fully dry. Do not try to bleach or re-dye the belts. The resulting color may rub off and the webbing strength could be affected.

Regularly check the seat belt buckles and release mechanisms for positive action and check automatic locking retractors for positive engagement. If the seat belt webbing shows obvious cuts, protruding broken fibers or severe fading which indicates weakening by exposure to sunlight, the entire seat belt assembly should be replaced.

**CHILD SAFETY RESTRAINT SYSTEMS**

When transporting infants or small children, an appropriate child safety restraint system should always be used. Follow the manufacturer's instructions for the correct installation and use of these systems.

**⊗ NOTE:** All child safety restraint systems should always face the front or rear of the motor home. They should never be installed so the occupant is facing the side of the motor home.

**INSTRUMENT PANEL****WARNING**

Do not set anything on or attach anything to the instrument panel or dash. Do not attach anything to the steering wheel cover such as trim material, badges, etc. Failure to follow these warnings may restrict the driver's visibility or cause an object to strike and injure an occupant in the case of a collision or sudden stop.

**For more information** refer to your Chassis Guide.

**SIDE VIEW POWER MIRRORS (IF SO EQUIPPED)**

After adjusting the front driver's seat, adjust the exterior side view power mirrors to your driving preference.

**Power remote mirrors**

You can adjust the power remote mirrors when the ignition key is in the ON or ACC position.

1. Move the control knob to the side you want to adjust.
2. Press the control arrows in the direction you want the mirror to move.
3. Return the control knob to the center to lock the mirror(s) into place.

The power remote mirrors also contain heating elements to defog or de-ice the mirrored glass if needed. To activate this feature, use the "Mirror Heat" control located on the driver's side console next to the mirror control.

**⊗ NOTE:** To prevent the batteries from running down, operate the power remote mirrors when the chassis engine is running.

**BRAKING & STOPPING****WARNING**

**Your motor home braking system is rated for operation at GVWR not GCWR.**

**WARNING**

Whenever possible, do not travel with waste in the holding tanks. Liquid or debris in the holding tank(s) may affect the towing characteristics and may result in property damage or personal injury.

When descending a long hill, drop down into a lower gear (or lower range if you have automatic transmission). Avoid conditions that require excessive and prolonged use of your brakes. Apply and release brakes at short intervals to give them a chance to cool.

The vehicle transmission and engine will help in controlling downhill speed and can lengthen brake life. The distance required to stop the motor home is greater than an automobile's. Use care when accelerating or decelerating on a slippery surface. Abrupt speed changes can cause skidding and loss of control.

Driving through water deep enough to wet the brakes may affect stopping distance or cause the vehicle to pull to one side.

Check the motor homes brake operation in a safe area to be sure they have not been affected. **Never operate any vehicle if a difference in braking efficiency is noticeable.**

---

## PARKING BRAKE

---

The parking brake should be engaged when the motor home is parked. Never drive your motor home with the parking brake set as this will reduce the parking brake effectiveness and cause excessive wear. For more information refer to your Chassis Guide.

---

## FRONT AXLE TIRE ALIGNMENT

---

The term alignment refers to both the adjustment angles on the steering axle and suspension and tracking of the rear axle. Many factors are considered when establishing proper alignment. Steering components, suspension, wheel bearings and even proper loading will affect the alignment.

We recommend you have the front suspension and steering alignment checked and adjusted after you have fully loaded the vehicle according to your needs as part of the vehicle maintenance. Thereafter, it is your responsibility to have the alignment inspected periodically to maintain vehicle steering performance and prevent uneven tire wear as part of your normal maintenance.

☒ **NOTE:** Always have the alignment checked and adjusted by a qualified shop with the proper equipment to handle heavy vehicles.

☒ **NOTE:** A road test by the dealer should be included as part of the pre-delivery inspection. The dealer can check for and correct any steering problems before you take delivery.

After this road test has been completed, front-end alignment and/or vibrations will not be covered as part of the new vehicle limited warranty.

---

## TIRES

---

**Read and understand the following before taking your first trip in your RV!**

**Proper care and maintenance of your tires is essential to ensure your safety, as well as the safety of others, as you travel.** Routine maintenance on your motor home is important, but it cannot be overstated just how critical proper tire maintenance is to the safety, operation and durability of your new motor home. You must follow the manufacturer's inflation guidelines for maximum load capacity; under-inflation is just as dangerous as over-inflation. To insure your tires are operating safely, regular inspection of your tires and checking tire pressures is absolutely mandatory.

When you are using your motor home, check inflation pressure weekly to insure maximum tire life and travel wear. Pressure should be checked when the tires are cold. During travel, tires heat up and pressure increases. **Do not bleed air from hot tires or your tires may then be under-inflated.**

☒ **NOTE:** Cold tire inflation pressure is defined as a tire that has not been used for three or more hours, or has been driven less than one mile. Tire inflation pressure of a hot tire may show an increase of as much as 6 psi over a cold tire.



**WARNING**

Tire pressure should be checked at the beginning of each trip to obtain the maximum life of the tire. Follow the instructions listed on the Federal Certification label to determine the correct tire pressure. Under-inflation may cause tire failures and swaying, this may result in loss of control, injury, death or property damage.









**DANGER**

Failure to follow proper inflation guidelines may result in tire failure, which under certain circumstances can cause loss of vehicle control or accidents that may result in property damage, bodily injury and/or death.

Tire pressure is the most important factor in the life and performance of your tires. Proper inflation should be monitored closely. Failure to do so could result in the overheating of a tire, which could result in a blowout. Inflation pressure should be as recommended by the tire manufacturer or as the federal label for the motor home indicates.

Examine your tires frequently for unusual wear. Alignment, balance and bearing wear will affect tire wear. Make sure to look for cracking, bulging, uneven tread wear, etc.

**Tire Wear Diagnostic Chart**

Wear Pattern	Cause	Action	
	<b>Center Wear</b>	Over Inflation	Adjust pressure to particular load per tire catalog.
	<b>Edge Wear</b>	Under Inflation	Adjust pressure to particular load per tire catalog.
	<b>Side Wear</b>	Loss of camber or overloading	Make sure load doesn't exceed axle rating. Align at alignment shop.
	<b>Toe Wear</b>	Incorrect toe-in	Align at alignment shop.
	<b>Cupping</b>	Out-of balance	Check bearing adjustment and balance tires.
	<b>Flat Spots</b>	Wheel lockup & tire skidding	Avoid sudden stops when possible and adjust brakes.

**CAUTION**

Tire wear should be checked frequently. Once a wear pattern becomes firmly established in a tire it is difficult to stop, even if the underlying cause is corrected.

**CHANGING A TIRE****WARNING**

The motor home is very heavy. Raising the motor home to replace the spare tire should only be done with extreme caution by a qualified technician. The vehicle could slip, causing personal injury or death. **DO NOT ATTEMPT TO DO THIS YOURSELF**

If you experience a flat tire on your motor home while driving, gradually decrease your vehicle speed (if possible). Hold the steering wheel firmly and move the motor home to a safe place on the side of the road. Please contact your road service provider (if applicable) or a qualified service facility for assistance. It is not recommended you attempt to change the tire or jack the motor home yourself; this is why a jack and spare tire have not been included with the motor home.

Make sure the road service technician reads and is familiar with the Chassis Guide information regarding changing the tires. Make sure the wheel lug nuts have been tightened to the proper torque as outlined in your Chassis Guide.

**Replacement****WARNING**

Do not use the leveling jack system to support the motor home while under the vehicle or changing tires. The leveling system is designed as a leveling system only. Do not use the leveling jack system as a jack or in conjunction with a jack. It is highly recommended that, should a tire change be required, it be performed by a knowledgeable, trained professional. Attempts to change tires while supporting the motor home with the leveling jack system could result in damage to the motor home and risk causing serious injury or death.

**WARNING**

When replacing a tire, make sure to replace it with a tire of the same size and specifications (refer to your Chassis Guide and/or the Federal certification label for assistance.) Be sure to use only tires that are rated for RV use. The use of passenger tires should be avoided; they do not have the same load capability as tires that are specifically identified for RV use.

**WHEEL LUGS/WHEEL LINERS****WARNING**

Failure to maintain proper torque of the wheel lug nuts could lead to separation of the tire and wheel while driving, possibly resulting in property damage or personal injury.

**WARNING**

Check and tighten the wheel lug nuts regularly to make sure they did not loosen during travel. Refer to your Chassis Guide for Torque recommendations. Failure to tighten and maintain wheel lug nuts to the proper torque specification, could allow the wheels to come off while the motor home is in motion, and could result in serious injury in the event of a collision or loss of vehicle control.

Torque is the amount of rotating force applied to a fastener, such as a lug nut. Proper torque of lug nuts can only be achieved by using a properly calibrated torque wrench and socket. Do not use a 4-way socket or any other type of wrench that does not measure the actual pressure applied to the lug nut.

**⊗ NOTE:** The proper method of tightening wheel lug nuts is with a torque wrench, not with an impact wrench or by hand. Because of the importance of having proper torque on the wheel lug nuts, you should always have the wheels mounted and properly torqued by a qualified technician using the proper tools.

After your first trip, check the wheel lug torque periodically for safety according to your Chassis Guide. If you suspect the wheel lug nuts have loosened at any time, have them checked and torqued to the proper limits immediately.

**Check and re-torque after the first 10, 25 and 50 miles (16, 40 and 80 kilometers). Thereafter, check and maintain the torque according to the listed torque values.**

**Wheel lugs**

If you suspect or notice the wheel stud bolts are cracked or broken, they must be replaced, along with adjacent bolts that have probably also been weakened due to the additional stress placed on them.

**WHEEL BEARINGS & BRAKES**

Follow the Chassis Guide maintenance instructions for the front and rear axle for wheel and suspension maintenance, including the brakes and wheel bearings. Contact your Chassis manufacturer for assistance.

**EMERGENCY STOPPING**

Always carry road flares or reflective warning signs to display if necessary. Pull off the roadway as far as possible for emergency stopping. Turn ON your motor home hazard warning flashers. If traveling at night, use three red warning indicators such as flares, reflectors or lanterns, as follows:

1. Place the first warning indicator on the traffic side of the motor home, directed at the nearest approaching traffic.
2. Place the second warning indicator 100 feet behind the motor home in the center of the lane and toward approaching traffic.
3. Place the third warning indicator 100 feet in front of the motor home in the center of the lane and away from the traffic approaching from behind.

The hazard-warning flasher provides additional safety if the motor home is stopped on the side of the roadway and presents a possible hazard to other motorists. When the flasher is on, it serves as a warning to others to approach and overtake your vehicle with caution.

### Curves and/or hills may affect the safe placement of warning indicators



#### **WARNING**

For personal safety, always stand off the road and out of the way of traffic.

### EMERGENCY TOWING

If your motor home ever needs to be towed, refer to the instructions in your Chassis Guide. Please contact your road service provider (if applicable) or a qualified service facility for assistance. Make sure the road service technician reads and is familiar with the information contained in your Chassis Guide regarding emergency towing.



#### **WARNING**

When the unit is being towed, be aware of the strap locations. Misplaced straps could result in damage to the exterior of you unit. Damage resulting from misplaced straps is the responsibility of the towing company, and is not covered by the unit warranty.



#### **WARNING**

**Never allow anyone to go under the RV while it is being lifted and/or being towed.**



**LEVELING JACKS (If So Equipped)**

Once you have parked your motor home (and blocked the wheels if needed), you need to ensure it is level. Leveling is very important.

- ❑ The water drainage systems are designed with proper slope and must be level for proper operation.
- ❑ The appliances perform best when level.

**Before operating the system****CAUTION**

Before operating the hydraulic leveling system:

- Check that potential jack contact locations are clear of obstructions or depressions.
- Keep people clear of the motor home prior to turning the leveling system ON and while the leveling system is in operation.

The hydraulic leveling jack system should only be operated under the following conditions:

1. Park the motor home on reasonably solid surface or jacks may sink into the ground. On extremely soft surfaces use load distribution pads under each leveling jack.
2. Check that potential jack contact locations are clear of obstructions or depressions.
3. Keep people clear of the motor home prior to turning the leveling system ON and while the leveling system is in operation.
4. Engage the parking brake.
5. Make sure the transmission gear selector is engaged in NEUTRAL or PARK.

⊗ **NOTE:** The leveling jack system will not operate if the ignition key is at the “on” position.

The following label should be kept permanently affixed by the leveling jack control panel located in the command center:



Fig. 4.1 Leveling jack label

**CAUTION**

Never expose hands or other parts of the body near hydraulic leaks. High-pressure oil leaks may cut and penetrate the skin causing serious injury.

**CAUTION**

**Never lift the wheels off the ground when leveling the motor home.**

**WARNING**

- ❑ After starting the leveling cycle it is very important you or other occupants do not move around in the motor home until the vehicle is level. Failure to remain still during the leveling cycle can affect the leveling jack system sensors.
- ❑ Do not move the motor home while the jacks are still in contact with the ground or extended. Damage to the vehicle could occur.
- ❑ Do not rely solely upon warning lights to determine the position of the leveling jacks. It is the operator's responsibility to check that all the leveling jacks are fully raised in the travel mode before moving the motor home.

**To manually override****WARNING**

**Use extreme caution when overriding the hydraulic leveling jack pump. Ensure that no one becomes trapped under the motor home or by the entrance steps (if extended). It is highly recommended you have someone assist you.**

Before attempting to override the semi-automatic hydraulic leveling system ensure the area around the motor home is clear of others, including children and pets. In the event the hydraulic leveling jack control panel will not retract the jacks, the jacks can be retracted using the auxiliary valves at the hydraulic pump connection. Refer to the manufacturers user guide for detailed operating and safety information.

**Storage**

When storing the motor home, it is recommended the jacks be stored in the retracted position (the manufacturer requires the jacks be cycled periodically). If the jacks must be stored in the extended position, it is recommended the system be fully retracted once per month.

**REAR VISION CAMERA**

Your motor home is equipped with a rear vision monitor that gives a limited televised view of what is behind your motor home. The rear vision camera will aid you in backing up the motor home, and can be used for a greater field of vision when driving in heavy traffic.

Check the outside rear view mirrors when driving and backing up the motor home for a more complete field of vision.

Objects in the camera/monitor view can be closer than they appear. To become accustomed to using the rear view camera monitor, practice backing up in a safe place. If in doubt, ask another person outside the vehicle to assist.

The monitor is operational whenever the engine is running. To use the monitor, flip the switch from standby to ON (the monitor will also work when with the motor home is in “reverse” and the monitor in standby). **Make sure you turn the monitor to standby while driving to avoid being distracted.**

Never operate the rear vision monitor in the ON position for extended periods of time as this may result in an “image burn” on the monitor.

**WARNING**

The rear vision camera aids in the use of, but does not replace vehicle side/rear-view mirrors.

**WARNING**

Objects in the camera view are closer than they appear. When backing up, proceed cautiously and be prepared to stop.

**THIS PAGE IS INTENTIONALLY BLANK**

---

**WARNING**

Ensure that the motorhome is level before operating the slideout room. Water leaks and other problems could result if the slideout is operated without leveling the motorhome.

Ensure there are no people or obstructions blocking the path of the room when it is moving. Keep away from the slide rails when the room is in motion. The gear assembly may pinch or catch on loose clothing causing personal injury.

**FAILURE TO FOLLOW THESE INSTRUCTIONS COULD RESULT IN SERIOUS INJURY OR DEATH.**

**CAUTION**

Do not place excessive weight in the slideout room. It can cause the slideout room to malfunction and cause damage to the slideout.

The slideout room system is designed for additional floor space and comfort. The mechanical components are gear driven. Electric powered slideout room systems have a manual override to allow you to extend or retract the slideout room(s) in case of a power loss. Make sure you have sufficient power available before operating your slideout system.

**OPERATING THE SLIDEOUT****CAUTION**

Additional support jacks are not needed under the slideout. Damage can occur to your slideout room from improper use of aftermarket support jacks.

1. The auxiliary battery (customer supplied) must be fully charged and connected. If possible, the RV should be hooked up to 120-volt AC power so the converter operates.
2. The RV must be level and the stabilizer jacks in the extended position.
3. Locate the slideout room control switch. The main slideout switch is located in the command center. The bedroom slideout switch may be located in the command center or on a bedroom interior wall depending on the model.



**Fig. 5.3 Bedroom slideout control switch**

4. To move the room out, press the OUT section of the switch and hold it until the motor stops (travel time is approx. 25 seconds). Operating the switch after the room is fully extended will damage the switch and motor.



**Fig. 5.4 Exterior  
slideout room corner**

After the slideout is extended, verify that the corners of the black rubber seal are set up correctly. The corners of this seal are cut at a 45° angle. The top of the seal must overlap the side of the seal to avoid the possibility of water penetration.

### Retracting slideout room

Press the IN section of the slideout control switch and hold it until the motor stops. Operating the switch after the room is fully retracted will damage the switch and motor.

### Maintenance



### WARNING

Do not work on your system unless the 12-volt DC (auxiliary battery, customer supplied) and 120-volt AC electrical systems (shore line power cord) have been disconnected.

Your slideout system has been designed to require very little maintenance. To ensure a long life of your slideout system, read, understand and follow these simple instructions. This system contains a pre-lubed bearing that is lubricated when the room is moved in and out. Do not spray oil or grease on the rails while the room is extended.

### TROUBLESHOOTING THE SLIDEOUT

If the slideout does not move when the slideout switch is depressed, follow these steps.

- Check the auxiliary battery (customer supplied) for a full charge and good wire connections.
- Check the 12-volt fuse or circuit breaker.
- Check for loose connections at the slideout motor.

If the slideout still will not operate, follow these steps.

- If the slideout is extended, refer to the following section on overriding the specific slideout system installed on your RV.
- If the slideout is retracted, leave it in that position.
- Contact your dealer or Jayco Customer Service for repair assistance.

If the slideout extends crooked or only one side moves, follow these steps.

- Follow steps on overriding the specific slideout system installed on your RV.
- You may need to push the side that is not sliding to get it to retract all the way.
- Contact your dealer or Jayco Customer Service for repair assistance.

**Slideout override****WARNING**

Do not work on your system unless the battery is disconnected. Failure to comply could result in death or serious injury.

Locate and remove the access panel for the slideout motor.

**MAIN ROOM MOTOR**

Fig. 5.5 Main room slideout motor

**ROTATE TO  
RELEASE BRAKE**

1. From the rear of the motor, rotate the brake release lever counter-clockwise 1/8 turn. This will release the brake that locks the slideout in place.
2. Disconnect one slideout motor wire near the motor.
3. The slideout is now free to move. Locate the access panel either at the front or rear of the slideout rail. Remove the access panel for the manual slideout shaft.
4. Use a 3/4 socket and ratchet on the hex head located on either end of the drive shaft and turn the shaft until the slideout is in the position you desire. When the slideout is fully extended (or retracted), put pressure on the wrench to ensure a tight seal, then return the brake release lever to its normal downward position. This will ensure that the slideout is locked into a sealed position.

**CAUTION**

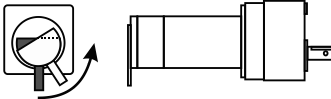
When the slideout motor brake is released, the slideout will not lock into place, and therefore it will not be sealed from the outdoors! When the slideout has been retracted, return the brake release lever to its downward position in order to seal and lock the slideout.

**THIS PAGE IS INTENTIONALLY BLANK**

---



**The** RV electrical system is comprised of two independent electrical systems. One operates off of 12-volt DC power and the other off of 120-volt 60hz AC power. All installations have been made in compliance with industry standards applicable on the date of manufacture. Because the electrical equipment and associated circuitry are engineered into a dedicated system specific to your motor home, we recommend you do not make unauthorized changes or add fixed appliances to it. **Changes or additions made after delivery may result in a hazardous condition.**

Service and/or modification of the electrical system should only be performed by qualified electrical technicians using approved materials, components, and methods meeting current safety and code requirements. Please consult your dealer's service department for assistance.

To read more about the various components incorporated into the motor home electrical system, please refer to the information contained in your Warranty Packet. Consult the Chassis Guide for information pertaining to the chassis drivetrain electrical system.

### ELECTRICAL SYSTEM MAINTENANCE

Always disconnect the shore power cord, turn "off" the inverter, and the generator, disable automatic generator start functionality, and disconnect the negative 12-volt DC battery terminal before working on the electrical system. Always make sure the battery disconnect solenoid, power converter, and inverter (if so equipped) are turned "off" before disconnecting the house batteries.



#### WARNING

Use caution when using metal tools. If a tool contacts a battery terminal or metal connected to it, a short circuit could occur which could cause personal injury, explosion or fire

### IN CASE OF AN ELECTRICAL FIRE



#### WARNING

Do not attempt to use water to put out an electrical fire. Water can spread some types of fire, and electrocution is possible with an electrical fire.

1. Have everyone evacuate the motor home immediately.
2. Switch the 120-volt main circuit breaker in the motor home to the "off" position.
3. Disconnect the negative battery cable(s) at the battery.
4. Disconnect the power cord from the shore power receptacle.
5. Turn "off" the generator.
6. Always have faulty or damaged wiring and electrical components repaired immediately.

**⊗ NOTE:** It is important that everyone knows where to find the 120-volt main circuit breaker and how it operates.

## COMMAND CENTER

Your motor home is equipped with a Command Center that allows you to monitor several systems from one location. For your convenience, the Command Center is located near the kitchen area. More information on the controls located in the Command Center will be discussed throughout this manual.

## 120-VOLT CIRCUIT BREAKERS

The 120-volt AC circuit breakers located inside the main load center and inverter sub-panel protect all 120-volt wiring and components in the motor home from circuit overloads and short circuits. Should a circuit overload or short circuit occur the circuit breaker protecting the affected circuit will “trip” preventing the flow of electricity through that circuit. If a circuit breaker trips, shut “off” the appliance on that circuit (i.e., central air conditioner, etc.) and allow the circuit breaker to cool down for a brief period of time.

After the cooling down period, reset the circuit breaker by moving its lever “off” and then back to the “on” position. If the circuit breaker re-trips or frequently trips, contact your dealer to have the electrical problem diagnosed and repaired.

A circuit breaker identification label is permanently attached to the inside surface of the 120-volt load center.



### CAUTION

Circuit breakers and fuses will not offer complete protection of the electrical system in the event of power surge or voltage spike.

## Maintenance and Replacement

At the beginning of camping season, inspect the circuit breakers and replace as needed. Test by turning each circuit breaker “off” and back “on”. Circuit breakers are wearable parts and must be replaced as needed, as part of your motor home maintenance. If you have any questions, consult your dealer.



### WARNING

Replacement circuit breakers must be of the same voltage, amperage rating and type. Never use a higher rated replacement circuit breaker; doing so may cause a fire by overheating the RV wiring.

Please contact your dealer for repair assistance when replacing circuit breakers.

## POWER CONVERTER

The power converter converts 120-volt AC power to useable 12-volt DC power when the shore power cord is connected to an external power source. The converter has a built-in protective thermal breaker that will shut it down should overheating occur. Overheating can be caused by operating the converter above its maximum power output for an extended period of time, or by an obstruction to its ventilation air flow. To reduce converter heat build keep unnecessary 12-volt lights and motors turned “off”. Keep the converter cooling fins and fan clear of obstructions.

### Inspection and maintenance

If the 12-volt power converter is not working (auxiliary battery not being charged) check the reverse polarity fuse(s) located on the end of the converter. **There are no customer serviceable parts inside the converter case and the manufacturer's warranty will be void if the case has been removed.** If you have further concerns contact your dealer.

### GFCI RECEPTACLE OUTLET

---

Grounding is your personal protection from electrical shock. Each motor home has a ground fault current interrupter (GFCI) engineered into the electrical system. This device has been designed to reduce the possible injury caused by electric shock. The GFCI will not protect against short circuits or circuit overloads.

Test all GFCI receptacles monthly

- ❑ Push in the GFCI "TEST" button. The GFCI "RESET" button should pop out indicating the GFCI receptacle has been "tripped" and interrupted 120-volt power.
- ❑ Push in the GFCI "RESET" button to restore 120-volt power. Contact your independent Jayco dealer for assistance if the GFCI "RESET" button does not restore 120-volt power and pops back out.

A "tripped" GFCI receptacle indicates that abnormally high 120-volt current flow (a ground fault) was detected through the electrical system grounding circuit. A fault condition can be caused by faulty wire insulation, wet wiring inside an appliance, or faulty electrical equipment connected to the circuit, etc. All ground faults must be repaired before use of the motor home

### 12-VOLT DC SYSTEM

---

The majority of your motor home lighting is powered by 12-volt electricity. The 12-volt DC system is composed of components that will operate when the following conditions are met:

- ❑ Power is supplied by the chassis alternator when the chassis engine is running.
- ❑ The power converter will supply interior 12-volt DC power when the shore power cord is plugged into a 120-volt external power source. The converter will also charge the house batteries in most situations.
- ❑ The house batteries power many interior 12-volt components including the lighting fixtures, water pump, 12-volt motors, 12-volt appliances, etc, when the motorhome is not connected to a 120 volt power source.

### AUXILIARY START SYSTEM

---

Your motor home is equipped with an auxiliary start switch which can momentarily connect both the house and chassis batteries should the chassis battery become discharged. To operate, depress the "Aux. Start" switch (located on the front driver's dash) and hold it down. While the "Aux. Start" switch is depressed use the ignition key to start the chassis engine. Release the "Aux. Start" switch after the engine has started.

## 12-VOLT BATTERY DISCONNECT

The 12-volt battery disconnect switch is located near the entrance door. This momentary switch controls a latching type solenoid (located near the house batteries), which connects or disconnects the house batteries dependent upon the number of times it is pushed.

When engaged the battery disconnect solenoid supplies battery power to all accessories connected to the house 12-volt fuse panel.

The battery disconnect feature should be used to disconnect the motor home from house battery power during periods of storage or during maintenance. The solenoid must be engaged for the 12-volt house electrical system to operate.

Never depress the momentary battery disconnect switch for longer than 1 second. Depressing and holding the switch down will disable the battery disconnect solenoid. Should this occur the main ground cable for the house batteries must be removed for 1 minute to re-enable the solenoid operation.



### WARNING

**Always wear eye protection when working with batteries.** Keep sparks, cigarettes and flames away from the battery as the battery may explode. Do not use a booster battery or any other power source that has an output that exceeds 12-volt. Use adequate ventilation when charging or using the battery in an enclosed space.

## HOUSE BATTERIES

Your motor home has many 12-volt DC loads. When combined, their total load requires more power than the converter can produce. High demands for 12-volt power can be met by the house batteries for a limited period of time. The 12-volt DC electrical system is designed for usage with Group 27 deep cycle batteries. The batteries for the house section of the motorhome are usually referred to as house (or coach) batteries.

The house batteries are factory-installed to provide temporary 12-volt power when 120-volt power is not available to operate the power converter. When drawing energy from the batteries, remember that there is a limited amount of power available before the batteries need to be recharged.

### To recharge the house batteries

When the engine is running, the alternator will automatically charge the house batteries through the auxiliary start solenoid. When parked at a campsite and plugged into shore power the power converter will automatically charge the batteries. Complete charging may take several hours and depends upon battery condition and the amount of power consumed by the 12-volt devices operated during the charging period.

### Dry camping

Consider the charge condition of the house batteries when dry camping. When the house batteries are not being recharged and power is being drawn from them, they will eventually discharge. A battery will discharge faster as its voltage gets lower. Plan your 12-volt electrical use accordingly.

A fully charged 12-volt battery will read 12.7 volts DC and have a specific gravity of 1.265 at 80°F (32°C). The house batteries are considered discharged at 11.8 volts and "dead" at 11.65 volts.

When battery voltage drops below these lower thresholds permanent battery damage may occur.

Typically, a deep cycle battery has an amp-hour rating of 75-100 amps. If you run the furnace and refrigerator simultaneously, you will be using approximately (12.0 + 3.0) 15.0 amps per hour.

This does not include any 12-volt lights, water pump or any other 12-volt component.

If the furnace and refrigerator in the above example operated constantly, a 75 amp-hour battery would become fully discharged in 5 hours (75ah / 15a = 5h).

### **Battery storage instructions**

Some equipment in your motor home will draw small amounts of electrical current even when turned "off". To prevent house battery discharge when the motor home is not connected to power through the shore power cord, it is recommended you shut "off" the 12-volt battery disconnect solenoid and disconnect the battery negative cable at the house batteries.

During storage, it is important to check battery voltage at least every two weeks and to recharge them as needed. If you remove the batteries from your motor home protect them from accidental shorting and keep them in a cool, dry, well ventilated area.

### **Replacement and maintenance**

For accuracy, test battery voltage using a volt-ohm meter (customer supplied). When it is time to replace the house batteries, replace with Group 27 deep cycle batteries only. Contact the battery manufacturer for further information. Do not reverse the positive and negative battery cables. Doing so will blow the reverse polarity fuses that protect the power converter.

## **CHASSIS BATTERIES**

---

Each chassis is built with batteries to provide energy to start the engine and operate devices supplied with the chassis. The chassis battery is furnished and warranted by the chassis manufacturer (as applicable).

## **ISOLATOR SOLENOID**

---

When house batteries are installed in parallel circuitry with the chassis battery, the charge level in both connected batteries will naturally equalize. An isolator solenoid is incorporated to break the connection between the house batteries and the chassis battery when the ignition key is in the "off" position.

Breaking this connection prevents discharge of the chassis battery (used to start the engine) when using 12-volt devices in the house section of your motor home. When the engine is running the isolator solenoid engages allowing the house batteries to be charged by the vehicle alternator.



### **CAUTION**

Always leave the ignition key in the "off" position unless the engine is running.

## 12-VOLT FUSE PANEL

The 12-volt fuse panel is labeled to indicate fuse sizes, positions and the components powered. At the beginning of camping season, inspect all the 12-volt fuses and replace as needed.

### Replacing a fuse

Before replacing a fuse, always turn off the electrical components protected by it.

1. Disconnect the shore power cord.
2. Turn "off" the inverter (if so equipped).
3. Disconnect the house batteries main negative battery cable.
4. Remove the fuse panel cover to check fuses.
5. Pull the fuse straight out of the fuse block. If the fuse is not blown, something else must be causing the problem. Please contact your dealer for further assistance.
6. Insert a new fuse of the same specified voltage, amperage rating and type in the original location. **Never use a higher rated replacement fuse.**



### WARNING

Replacement fuses must be of the same voltage, amperage rating and type. Never use a higher rated replacement fuse; doing so may cause a fire by overheating the RV wiring.

The fuse panel label should be kept permanently affixed to your motor home. The fuses will not offer complete protection of the motor home electrical system in the event of a power surge or spike.

Replacement fuses must be of the same voltage, amperage rating and type. Never use a higher rated replacement fuse; doing so may cause a fire by overheating the RV wiring.

## GENERATOR

The factory-installed generator will produce 120-volt AC power for use when camping in areas where shore power is unavailable. 120-volt power from the generator is output to the AC distribution center by way of a factory-installed automatic transfer switch. In the default mode, the automatic transfer switch connects the generator to the AC distribution center when the generator is operating and shore power is disconnected.

When the generator is operating it will power the converter, which in turn will charge the house and chassis batteries. The generator requires 12-volt power from the house batteries to start and draws fuel from the chassis fuel tank. If the fuel tank drops to or below 1/4 full, the generator will automatically shut off to keep the motor home from being stranded. Be aware the generator, when operating, gives off carbon monoxide.

### Before starting the generator

1. Make sure the carbon monoxide detector is working.
2. Turn "off" air conditioners and all other appliances.
3. Check for fuel, exhaust and coolant leaks.

**STOP the generator immediately if there is a fuel, exhaust or coolant leak and have it repaired!**

**WARNING**

**CARBON MONOXIDE IS DEADLY!** Do not run the generator when your motor home is indoors or in a confined space. Asphyxiation or carbon monoxide poisoning hazards exist whenever generator exhaust gasses can accumulate.

**WARNING**

**CARBON MONOXIDE IS DEADLY! MOVING PARTS AND ELECTRICITY** can cause severe personal injury or death. To reduce exposure to these hazards, **always disable AGS before:**

- Sleeping in vehicle, unless vehicle has a working CARBON MONOXIDE detector.
- Parking vehicle in garage or confined space.
- Parking vehicle for storage.
- Servicing vehicle for storage.
- Servicing generator.
- Servicing batteries.
- Servicing appliances or electrical systems.
- Fueling the vehicle.

**DO NOT run the generator or use the AGS AUTO ON or QUIET ON modes when your RV is indoors or in a confined space.** Asphyxiation or carbon monoxide poisoning hazards exist whenever generator exhaust gasses can accumulate.

**CAUTION**

Excessive cranking can overheat and damage the generator starter motor. Do not crank for more than 20 seconds at a time. Wait at least two minutes before trying again. If the generator does not start after the third try, refer to the generator manufacturer's user manual for more information.

**To start the generator manually**

1. A remote start/stop switch is located inside the motor home. A second start/stop switch is located on the generator.
  2. Press the operation control switch to start the generator. (Depending on how cold it is, preheat can take up to 15 seconds).
  3. The hour meter will monitor minutes of usage when the generator is running.
- For top performance and engine life, especially in colder weather, let the genset engine warm up for two minutes before connecting (turning "on") appliances.

**Automatic Generator Start (AGS) system (if so equipped)**

When enabled, the AGS system will automatically start and stop the generator according to operator or factory selected parameters. It can also be used as a manual generator start/stop switch.

1. The AGS system has been set up and tested using default values for the factory-installed generator. Consult the manufacturer's manual for operator programming information.
2. The AGS system is enabled by pressing the SUTO GEN key followed by pressing the ENTER key on the face of the Energy Command control panel.
3. The AGS system will not operate unless the battery disconnect switch is "on".
4. The factory-installed AGS system will not start the generator when shore power is connected to the motor home. If shore power is connected to the motor home when the AGS has started the generator, the generator will stop.
5. The AGS system as installed will be disabled anytime the chassis ignition key is cycled to either the "on" or "off" position. The AGS may be manually re-enabled after an ignition key cycle.
6. The AGS system, when enabled, and with the above conditions met, can start and stop the generator according to:
  - front air conditioner call to run
  - rear air conditioner call to run
  - coach battery low charge level
  - coach battery charge level prior to
  - camp ground quiet time (when AGS is set to quiet time "on" mode).

### **Maintenance**

With the exception of simple items such as normal maintenance (i.e., oil changes, etc.), all service work should be done by a repair facility authorized by the generator OEM. Improper adjustments can damage the generator and electrical appliances, and can result in a safety hazard. If any discrepancy or problem is noted, contact your dealer for assistance.

### **INVERTER (IF SO EQUIPPED)**

---

Your motor home may be equipped with a factory-installed inverter that converts 12-volt DC current to 120-volt AC current. It is important that you familiarize yourself with the inverter function and operation. The inverter should be "off" when not in use.

**The factory-installed inverter is not intended for use with medical device(s).**

### **12-VOLT DC OUTLET (IF SO EQUIPPED)**

---

There may be a 12-volt DC outlet (not applicable on all models) in your motor home. When the 12-volt DC outlet is used as a power source for an electric appliance, make sure that the appliance operates on 12-volt DC power and that it consumes less than 60 watts (5 amps) of 12-volt power. To prevent short circuits do not allow metallic foreign matter to get into the 12-volt DC outlet.

### **REPLACING LIGHT BULBS**

---

Before replacing a bulb, be sure the light is off. Do not touch the glass part of the new bulb with your bare fingers. The skin oil left on the glass will evaporate when the bulb gets hot, the vapor will condense on the reflector and it will dim the surface. Replace a bulb only with a new bulb of the same rating and type.



**APPROXIMATE ELECTRICAL LOAD RATINGS**

<b>120 Volt System</b>	
Air Conditioner	18 AMPS
Coffee Maker	6-12 AMPS
Converter (each)	8 AMPS
Curling Iron or Hair Dryer	10-14 AMPS
DVD System	3 AMPS
Microwave	12 AMPS
Refrigerator	6 AMPS
Satellite Receiver	2 AMPS
TV	2-4 AMPS
Vacuum Cleaner	8 AMPS
Washer/Dryer	12 AMPS
Water Heater	12 AMPS

120 Volts: Labeled watts divided by 120 = Power consumed in AMPS

<b>12 Volt System</b>	
Aisle Lights	1.0 AMP
Baggage Compartment Lights	1.4 AMPS
Decorative Wall Lights	1.5 AMPS
Dinette Light	4.5 AMPS
Exterior Entertainment Center	5-7 AMPS
Fantastic Fan	1.5 AMPS
Fluorescent Double Lights -12"	2.0 AMPS
Fluorescent Double Lights -18"	2.5 AMPS
Furnace	12.0 AMPS
Generator Start	95.0 AMPS*
Halogen Light	1.7 AMPS
Illuminated Switch	.125 AMP
Inverter	variable
Leveling System	95.0 AMPS*
LP Detector	.125 AMP
Map Light	1.5 AMPS
Porch Light	1.5 AMPS
Power Awning	10.0 AMPS
Power Vent	5.0 AMPS
Refrigerator	3.0 AMPS
Shower Light	1.4 AMPS
Step Cover	10.0 AMPS
TV Plate/Antenna Booster	1.0 AMP
Vanity Light	4.2 AMPS
Water Heater	6.0 AMPS
Water Pump	7.0 AMPS

\*Momentary Load

12 Volts: Labeled watts divided by 12 = Power consumed in AMPS

**120-VOLT AC SYSTEM****WARNING**

Make certain the external power source you connect the power cord to is a properly wired **30 amp NEMA TT-30** RV receptacle and not 240 volt AC.

Your motor home is equipped with a 30 amp 120-volt 60hz AC electrical system. The entire system is designed to operate on 1 leg of 120-volt power at a maximum current flow of 30 amperes. Exposure to voltages higher or lower than a nominal 120-volts will damage or shorten the service life of the electrical system and appliances. The 30 amp 120-volt 60hz AC electrical system can be powered by the 120-volt 60hz utilities found in RV campgrounds or by 120-volt 60hz generator power.

The following electrical components will only operate when your motorhome is connected to shore or generator power: 120 to 12-volt power converter, air conditioner, refrigerator, microwave oven, television(s), home theater system(s), electric water heater, washer, dryer, fireplace, and appliances plugged into convenience receptacles.

**30 AMP POWER CORD**

The 30 amp power cord is also commonly referred to as the “shore power cord.” This power cord is designed to ground the motor home electrical system through the external power source receptacle. It is also designed to carry the voltage and current output from 30 amp campground power receptacles.

**WARNING****PLUG INTO 30-AMP SERVICE ONLY.**

- Do not hook up the 30-amp power cord to any receptacle until you have verified proper polarity and grounding. Polarity indicators can be purchased in most electrical and hardware stores.
- Do not use any cheater plug, adapter or extension cord to reconfigure incoming AC power or break the continuity of the circuit connected to the grounding pin.
- Do not connect the power cord into an outlet that is not grounded, or adapt the 30 amp power cord plug to connect it to a receptacle for which it is not designed.
- Do not remove the grounding pin to connect to a non-grounded receptacle. Removal of the ground pin disables an important safety feature designed to prevent shock and electrocution hazards.
- Do not connect the power cord to an extension cord. Use of an improper extension cord will cause overheating of the cord as well as potentially causing premature failure of the AC equipment.

It is the responsibility of the owner of the electrical receptacle to ensure that the receptacle is properly wired and grounded. Reverse polarity and/or improper grounding of your RV can cause personal injury or death.

**WARNING**

Plugging the shoreline power cord into an incorrectly wired power source could damage the motor home electrical system and result in severe or fatal injury.

Occasionally the electrical service provided by a campground may experience low or high voltage (i.e., surges or spikes). Any prolonged exposure will shorten the life of the electrical system and appliances. Consult your dealer for recommendations on power surge protection.

**Connecting the power cord****WARNING**

The power cord must be fully extended when in use and not left coiled in the electrical compartment or on the ground. If the power cord is left coiled, it may potentially create enough heat to melt its protective casing.

Always test the 30 amp external power source (i.e., the campsite power receptacle or electrical box) with a ground monitor before connecting your power cord to it. If the ground monitor indicates 'reverse polarity' or an 'open ground' **DO NOT** connect the power cord.

1. Turn "off" the load center main 30 amp 120-volt circuit breaker.
2. Carefully extend the entire length of the power cord (approximately 25'-35') from the electric cable hatch to the external power source.
3. Plug the power cord into the receptacle. Be sure all the power cord prongs are properly plugged into the receptacle.
4. Return to your motor home and turn "on" the load center main circuit breaker.
5. To help prevent power surges from damaging the connected loads, please follow these instructions when hooking up to the external power source:

**The shore line power cord should be unplugged when the motor home is left unattended. If something would happen to the electrical system, this may help limit potential damage.**

When you are ready to leave, reverse the power cord connection process. Use care to prevent damaging the power cord electrical connection pins when connecting or disconnecting the shore line power cord. Grasp the plug to remove the power cord from the outlet; do not unplug it by pulling on the cord.

**Maintenance**

Inspect the power cord for cuts, cracks and worn insulation. Have the power cord replaced immediately if these symptoms are noticed.

**CALCULATING ELECTRICAL LOAD**

When connecting appliances to the electrical system, remember that 120-volt power usage is limited to a total of 30 amps. Be mindful of the fact that each operating appliance collectively places an added load on your 120-volt electrical system.

An unintentional “trip” of a circuit breaker may occur if you overload the motor home and/or campground electrical system. The amperage rating of individual appliances can be calculated by dividing appliance wattage consumed (normally listed on the appliance) by nominal design voltage (120 for a 120-volt appliance).

For example: 1200 watts divided by 120-volts equals 10 amps.

**WARNING**

To help prevent power surges from damaging the electrical system and its connected devices, please follow the instructions listing below when connecting to shore power.

- ❑ Only connect the shore power cord to properly wired 30 amp NEMA TT30 120 volt power receptacles.
- ❑ Do not connect the shore power cord to any power receptacle until you have contacted the campground owner and/or premise attendant to verify proper shore receptacle polarity and grounding. Polarity indicators can be purchased in most electrical and hardware stores.
- ❑ Do not use a cheater plug, adapter or extension cord to reconfigure incoming AC power or to break the continuity of the power cord grounding circuit.
- ❑ Do not connect the power cord to an extension cord. Use of an extension cord can cause overheating of the extension cord and can create a low voltage condition. Premature failure of connected 120-volt AC powered equipment may result.
- ❑ Do not connect the power cord to an outlet that is not grounded or adapt the 30 amp power cord plug to connect to a receptacle for which it is not designed.
- ❑ Do not remove the power cord grounding terminal to allow connection with a non-grounded receptacle. Disabling the grounding circuit of the shore power cord may create a shock or electrocution hazard.

It is the responsibility of the owner to ensure that the electrical receptacle being used is properly wired and grounded.

Reverse polarity and/or improper grounding of the motor home can cause property damage, personal injury or death. Failures due to improperly wired and grounded electric receptacles are not covered by the limited warranty.

## FUEL SAFETY

For your protection and others, it is critical to understand the danger associated with fuel. Take time to become educated about the property of fuel and use it safely.



### DANGER

Automotive fuels can cause serious injury or death if misused or mishandled. If you have further questions, consult your dealer or Jayco Customer Service for assistance.

- ❑ Always shut OFF the vehicle engine while refueling.
- ❑ Do not bring or store fuel or other flammable liquids inside the motor home because a fire or explosion may result.
- ❑ Before refueling, extinguish all smoking materials and any open flames.
- ❑ Before refueling, always turn OFF all spark producing appliances (i.e., water heaters, furnaces, etc.).
- ❑ Do not overfill the fuel tank(s). The pressure in an overfilled fuel tank may cause leakage and lead to fuel spray and/or fire.
- ❑ Fuel spills represent a serious fire hazard, and should be cleaned up immediately.
- ❑ Never restart an engine or re-light any pilot lights while raw fuel is present.

**FAILURE TO COMPLY COULD RESULT IN FIRE, DEATH OR SERIOUS INJURY.**

### Fuel selection

Remember the generator is also fueled by the same system used to fuel the chassis engine. Check the generator manufacturer and the chassis manufacturer information to help determine the type of fuel best suited for this dual application.

### Fuel filler cap



### WARNING

Do not replace the fuel fill cap with one of a different type. Only use a cap specified for your motor home. Use of a substitute cap may create excessive fuel system pressure, resulting in fuel station damage and improper operation in a collision.

Remove the fuel filler cap by slowly turning it counterclockwise and waiting for any "hiss" noise to stop. Then unscrew the cap all the way. To close the fuel filler cap, securely turn the cap clockwise until you hear clicking sounds.

### Filling the fuel tank

If you spill fuel on the motor home, clean it up immediately. Fuel can dull or soften paint and damage other surfaces. Use care when fueling your motor home. The following labels (if so equipped) should be kept permanently affixed to your motor home:

Fig. 7.1 Flammable liquid

**⚠ DANGER**

Vehicle and equipment powered by internal combustion engines and placed in recreational vehicles can cause carbon monoxide poisoning or asphyxiation, which could result in death or serious injury. The flammable liquids used to power these items can cause a fire or explosion, which can result in death or serious injury.

To reduce risk:

1. Do not ride in the vehicle storage area while vehicles are present.
2. Do not sleep in the vehicle storage area while vehicles are present.
3. Close doors and windows in walls of separation (if installed) while any vehicle is present.
4. Run fuel out of engines of stored vehicles after shutting off fuel at the tank.
5. Do not store, transport, or dispense fuel inside this vehicle.
6. Open the windows, openings, or air ventilation systems provided for venting the transportation area when vehicles are present.
7. Do not operate propane appliances, pilot lights, or electrical equipment when vehicles are present.

## FUEL ECONOMY

Fuel economy depends on many factors. Your driving habits can significantly affect your fuel economy. Some recommendations for achieving maximum fuel economy are shown:

- Keep your tires inflated to the recommended pressures.
- Keep your motor home "tuned-up." An out-of-tune engine wastes fuel and costs you money.
- Keep your air cleaner clean and your motor home lubricated according to the recommendations in this manual and the Chassis Guide.
- Do not overload your motor home or tow heavy loads.

## EXHAUST GAS FUMES



### WARNING

Avoid inhaling exhaust gases as they contain carbon monoxide, which is a potentially toxic gas that is colorless and odorless. Refer to **Sec. 2 Safety Precautions**, Carbon monoxide alarm.

To avoid breathing exhaust gases, follow these precautions:

- Do not run the engine in confined areas, such as a closed garage, any longer than needed to move your motor home in or out of the area.
- Windows should be closed while driving or running the generator (if so equipped) to avoid drawing dangerous exhaust gases into the motor home.
- If you suspect that exhaust fumes are entering the passenger compartment, have the cause determined and corrected as soon as possible.

If you must drive under these circumstances, close all the windows, and adjust the heating or cooling system to force outside air into the motor home (set the blower on high speed).

**WARNING**

If you are in a parked motor home with either the engine running or the generator running there is a potential for exhaust fumes to filter back into the motor home.

The best protection against carbon monoxide entry into the motor home is a properly maintained ventilation system and an active carbon monoxide detector. To allow for proper operation of the motor home ventilation system, keep the ventilation inlet grill(s) clear of snow, leaves or other obstructions at all times.

**Maintenance**

It is recommended that the exhaust system and vehicle body be inspected by a qualified motor home service center.

- Each time the engine is ready for an oil change.
- Whenever a change in the sound of the exhaust is noticed.
- Whenever the exhaust system, underbody or rear of the vehicle is damaged.

**For more information**

Refer to your Chassis Guide.

**PROPANE GAS SYSTEM**

Propane or LP (liquefied petroleum) gas is a clean and efficient form of energy when proper handling and safety precautions are observed. The propane system in your motor home furnishes the fuel for cooking, heating, hot water and propane generator (if so equipped). Propane can also be used as an alternative energy source for refrigeration.

The propane fuel system is comprised of numerous components such as the propane container, hoses, the propane gas regulator, piping and copper tubing lines to each appliance.

Propane is heavier than air; the gas tends to flow to lower areas and will sometimes pocket in these low areas, such as the floor.

Your motor home is equipped with a propane alarm (refer to **Sec. 2 Safety Precautions**, Combination Carbon Monoxide (CO)/Propane Alarm.)

**WARNING**

Propane cylinders should not be placed or stored inside the vehicle. LP-gas cylinders are equipped with safety devices that relieve pressure by discharging gas into the atmosphere

**Maintenance**

Although both Jayco and your selling dealer carefully test for leakage, travel vibrations can loosen fittings. Have the vehicle propane system checked at all connections soon after the purchase of your vehicle, and after the initial filling of the propane tanks.

**NOTE:** All propane lines have been checked with air pressure at the time of manufacture. Dealers are required to recheck and adjust pressure before retail delivery.

Continued periodic checks of the propane system at 5,000 miles of travel (or at least once a year), by a qualified propane service representative as part of your normal maintenance is recommended. Hand tighten the LP gas system valves only, do not use a wrench or pliers as over tightening may damage the valve seals and cause them to leak.

The following labels should be kept permanently affixed to the motor home.

 **DANGER**

**ALL PILOT LIGHTS, APPLIANCES, AND THEIR IGNITORS (SEE OPERATING INSTRUCTIONS) SHALL BE TURNED OFF BEFORE REFUELING OF MOTOR FUEL TANKS AND/ OR PROPANE CONTAINERS.**  
**FAILURE TO COMPLY COULD RESULT IN DEATH OR SERIOUS INJURY.**

 **WARNING**

DO NOT FILL PROPANE CONTAINER(S)  
 TO MORE THAN 80 PERCENT OF  
 CAPACITY.  
**FAILURE TO COMPLY COULD RESULT IN DEATH OR SERIOUS INJURY.**

 **CAUTION**

THIS PIPING SYSTEM IS DESIGNED FOR USE WITH PROPANE ONLY. DO NOT CONNECT NATURAL GAS TO THIS SYSTEM.

Securely cap this inlet when not connected for use. After turning on propane, except after normal cylinder replacement, test propane piping and connection to appliances for leakage with soapy water or bubble solution. Do not use products that contain ammonia or chlorine.

DD-37

Fig. 7.2 Propane label

## PROPANE LEAK TEST

Leaks may be found easily with a soapy water solution. Do not use a solution containing ammonia or chlorine when locating leaks. These products are corrosive to copper gas lines and brass fittings, which could result in deterioration of the copper and brass components.

Apply the soapy solution to the outside of the gas piping fittings. If a leak is present, the soapy solution will "bubble" at the leak point. **If a leak is indicated, shut off the propane system valve(s) and contact an independent Jayco dealer or qualified propane service representative immediately.**

 **WARNING**

**Never use an open flame to test for a propane leak.** Do not check for leaks using products that contain ammonia or chlorine; these products can cause cracks to form on the metal tubing and brass fittings



## PROPANE SAFETY PROCEDURE

Propane is a colorless and odorless gas that, in the liquefied state, resembles water. An odorant (usually a sulfur compound) is added as a warning agent. If you smell propane within the vehicle, quickly and carefully perform the procedure listed on the label below.

When propane container is low, occasionally there may be a concentration of an onion or garlic-like odor, which can be mistaken for a propane gas leak.

After the propane container has been refueled, the odor will usually disappear. If not, turn off the valve(s) and have the propane system inspected by an independent Jayco dealer or qualified propane service representative.

This label has been placed in the vehicle near the range, for models equipped with a propane system.

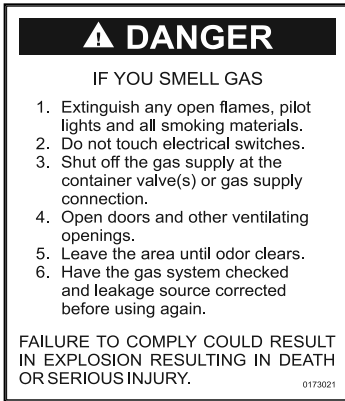

**Fig. 7.3 propane system label**

## PROPANE GAS CONTAINER



Propane is a true gas compressed into a liquid form. As the fuel is released from the container, it changes to vapor which is then used for the operation of the appliances. Propane will not run through the appliances in the liquid state. A permanently mounted A.S.M.E. approved propane container is located under the floor of the motor home.

**⊗ NOTE: Tanks are to be installed, fueled and maintained in accordance to State and Local codes, rules, regulations or laws.**

Propane expands 1½ percent for every ten degrees of increase in temperature. It is imperative to leave sufficient space inside the container to allow for natural expansion of gas during warmer weather.

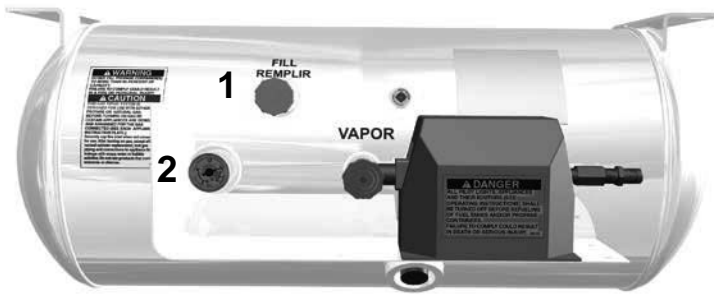

1: Propane fill valve; 2: Propane gauge  
Fig. 7.4 ASME tank

### Servicing or filling

Because the container is not removable, the motor home will need to be driven to a qualified propane facility for servicing or filling. Only the authorized gas service technician(s) should be near the motor home while the propane tank is being filled. The new propane container must be carefully purged for proper appliance performance and operation. The propane tank must **NEVER BE OVERFILLED**.



### WARNING

Always shut OFF the engine while refueling. Do not smoke and do not operate other ignition sources while refueling.



### WARNING

When the propane container is disconnected from the main supply hose and the P.O.L. connection, install the P.O.L. plastic cap that is attached to the container

Replace all protective covers and caps on the propane system and/or container after filling. Make sure the valve is closed and the compartment door is securely latched.

### LP gas container overfill

Never allow your propane tank to be filled above the maximum safe level as indicated by the fixed liquid level gauge.

Do not allow the visible gauge to be used for filling. Overfilling the propane container above the liquid capacity indicated on the container, could allow liquid propane to enter the system that is designed for vapor only creating a hazardous condition.

The following warning label has been placed by the propane container.

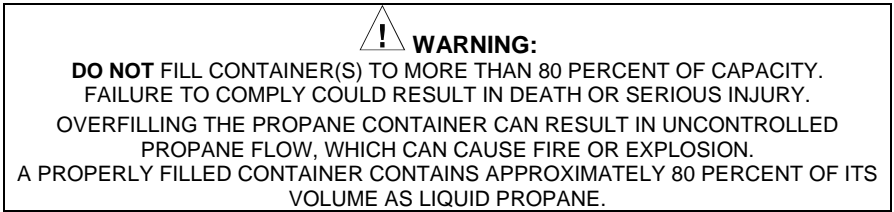

**Fig. 7.5 “Do not fill to more than 80%” label**



Refer to your Warranty Packet for more information on the LP gas system components.

### **USING THE PROPANE SYSTEM**

After your motor home is completely set up and you are prepared for camping enjoyment, use the following steps for propane operation:

1. Close ALL burner valves, controls and pilot light valves.
2. Open the main valve in the propane tank slowly to avoid a fast rush of propane vapor through the excess flow valve causing propane “freeze-up.” Should you experience propane “freeze-up,” close the main valve and wait 15 minutes before trying again.
3. Listen carefully as propane begins to flow. If a hissing noise is heard for more than one or two seconds, close the main valve and contact your RV dealer to have the propane system tested.
4. Light the appliances as needed and directed in the appropriate appliance manufacturer’s owner manual located in the Warranty Packet.

Keep the propane container valves closed at all times unless you are using the propane gas system or are having the propane container filled.

**Make sure that you read and fully understand ALL safety requirements for handling and operation of the propane system.**

The Warranty Packet contains manufacturer’s user guides for the various appliances hooked to your propane system.

The propane system provides added benefits to your camping enjoyment; however, it must be handled with care. If you have any questions or concerns, consult with your dealer and/or the specific manufacturer.

If you have double cylinders on your motor home, use only one at a time. Otherwise, the propane supply will be drawn equally from both cylinders until the supply has been totally exhausted. Using one cylinder until it is empty, then using the second cylinder will allow you to fill the empty cylinder at your convenience without running totally out of propane.

## CALCULATING PROPANE USAGE

It is important to remember that your furnace, refrigerator, water heater and range all may use propane to operate. Each has a different BTU rating, and you will need to consider them to determine how long your propane supply will last. Most RV gas appliances are operated intermittently. Propane consumption depends on individual use of appliances and the length of time operated. Unless there is heavy use of hot water, the water heater consumption of propane is minimal. During cool temperature or high wind conditions, furnace consumption can be extremely high.

To calculate your propane supply, take the BTU ratings for your propane appliances and divide that into the BTU availability. Each gallon of propane (3.86 liters) produces about 91,500 BTU's (46,514 kilojoules) of heat energy.

### Propane consumption chart

The following chart provides average propane consumption information.

Appliance	Average BTU Consumption per Hour	Kilojoules/Hour
Water Heater	8,800	9,280
Refrigerator	1,200 – 1,500	1,270 – 1,580
Furnace	35,000 – 40,000	36,930 – 42,200
Range/oven	7,100	7,490
Range, rear burner	6,500	6,860
Range, front burner	9,000	9,490
Outside Grill	10,000	10,550

## COOKING WITH PROPANE GAS

Unlike homes, the amount of oxygen supply is limited due to the size of the recreation vehicle. Proper ventilation when using the cooking appliance(s) will help you avoid the danger of asphyxiation. **It is especially important that cooking appliances not be used for comfort heating, as the danger of asphyxiation is greater when the appliance is used for long periods of time. FAILURE TO COMPLY MAY RESULT IN DEATH OR SERIOUS INJURY.**

The following warning labels are located in the cooking area to remind the user to provide an adequate supply of fresh air for combustion.

 **WARNING:**

**IT IS NOT SAFE TO USE COOKING APPLIANCES FOR COMFORT HEATING.**

Cooking appliances need fresh air for safe operation

Before operation:

1. Open overhead vent or turn on exhaust fan.
2. Open Window

**FAILURE TO COMPLY COULD RESULT IN DEATH OR SERIOUS INJURY**

**Fig 7.6**  
**Cooking / comfort**  
**heating label**

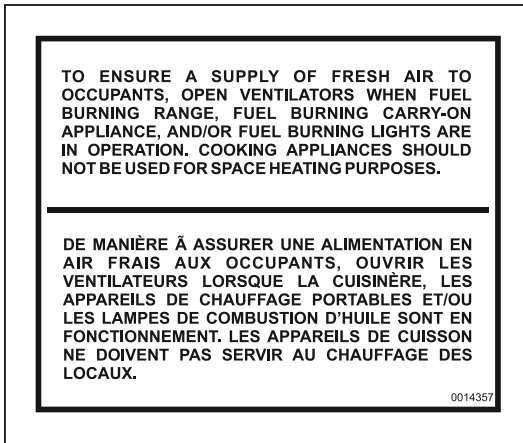

**Fig. 7.7 Ensure a supply of fresh air** (Canada units only)



**Fig. 7.8 Cooking / comfort heating label**



### TRAVELING WITH PROPANE

**⊗ NOTE:** Some states prohibit propane appliances to be operated during travel, especially in underground tunnels. Make sure you know the laws for the areas where you travel.

Use care when fueling your motor home. Make certain your propane tank is properly fastened in place. The label listed below should be kept permanently affixed to your RV:

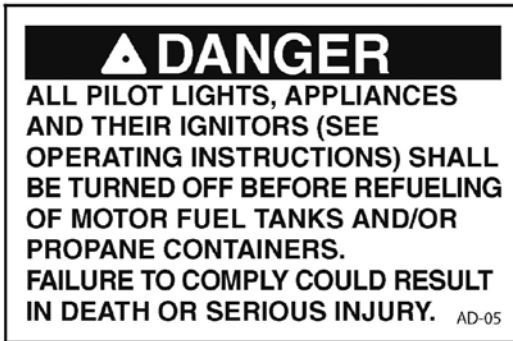

Fig. 7.9 Refueling warning label

**There** are two different water systems in your motor home: the fresh water system and the waste water system. The fresh water system consists of the fresh water holding tank, fresh water connections, water pump, outside shower assembly (if so equipped), water heater, faucets, tub/shower, and water purification system (if so equipped). The waste water system consists of the waste water holding tank, sewage holding tank, drains and toilet.

### PLUMBING SYSTEM MAINTENANCE

- Check all fittings, pressure and waste, for leaks before each trip or before vehicle storage as part of your normal maintenance:
- Inspect all faucets, the water purification system (optional) and sink connections (including drain baskets or filters).
- Inspect connections at the water pump and water heater.
- At the end of every trip, you should drain any unused water from the fresh water system.
- The fresh water (or potable water) system needs periodic sanitization and winterization to take care of all the components within the plumbing system and help discourage the growth of bacteria and other organisms that can contaminate the water supply.

There are labels affixed to the exterior of the motor home sidewall that indicate the locations of the water system drains and fills. Be aware some drain valves may be located inside the motor home (once the exterior label is found, go inside to find the drain corresponding location).

### FRESH WATER SYSTEM



#### WARNING

DO NOT drink water deemed microbiologically unsafe or of unknown quality.

All water contains contaminant and mineral particles that can cause fresh water system odors. Untreated well water is a major source of water system odors. The fresh water (or potable water) system needs periodic sanitization and winterization to take care of all the components within the plumbing system and help discourage the growth of bacteria and other organisms that can contaminate the water supply.



#### WARNING

Never travel with full fresh, black or grey water holding tanks.

### MONITOR PANEL

The monitor panel located in the Command Center allows you to monitor the fresh water, grey water, black water and house batteries levels. These functions are controlled using the “tact” switches located on the Command Center faceplate. The monitor panel operates on 12-volt DC power supplied by either the converter or house batteries.

Sensors installed in the holding tanks connect to a resistor assembly (relaying an electronic message to the display board). No power is drawn from the house batteries unless a switch is pushed or turned ON. Fuses for the monitor panel are located in the fuse panel.

### Operation

Press only one “tact” switch at a time. As you push either the “FRESH”, “BLACK”, “GREY1” or “GREY2 (optional)” switch, one or more LED lights will illuminate indicating that holding tank content level. When pushing the “BATT” switch, the highest LED light illuminated indicates the estimated house batteries condition.

C	=	charge at 12.7 volts or above
G	=	good at 12.1 volts or above
F	=	fair at 11.6 volts or above
L	=	low at 6.0 volts or above

### FRESH WATER HOLDING TANK

The fresh water tank can be gravity filled or pressure filled using the fresh water inlet (called city water). Plastic overflow tubes are plumbed into the fresh water holding tank to allow water to flow out of the water tank. Occasionally, you may see water coming from the overflow tubes (located underneath the motor home) when the fresh water holding tank is filled. This is normal, and is caused by external circumstances, including the motor home being parked on an incline, or the motion caused by starting or stopping the motor home during travel.



### CAUTION

Be careful not to overfill the fresh water holding tank. It can pressurize the tank, causing leakage and water damage and void the warranty. DO NOT leave the tank unattended while filling.

**Do not cap, block or modify the fresh water tank overflow tubes in any way. Enough water pressure can build up during the filling process to damage the plumbing system if the overflow tubes are obstructed.**

### WATER PRESSURE REGULATOR (CUSTOMER SUPPLIED)

Excessive pressure from water supply systems may be encountered in some parks, especially in mountain regions. Water pressure regulators are available to protect the water system against such high pressure. Water pressure regulators (customer supplied) are available from your RV dealer to protect the plumbing system against such high pressure.



### CAUTION

Not using a water pressure regulator when using city water may cause the o-rings to fail. To prevent damage to the plumbing system or components when using the city water connection, a 45 lb. (315 KPa) rated water pressure regulator is recommended.



## 12-VOLT WATER PUMP & SWITCH

When you want to use water in your motor home and it is not hooked up to city water, you will need sufficient 12-volt DC power to run the water pump.

Once activated, the water pump (also known as the demand pump) will self-prime, and provide water. The water pump continues to run until approximately 45 lbs. of pressure is achieved then shut off. The water pump will automatically re-start when pressure drops. Some cycling may occur, depending on the volume of water being released. The water pump has a built-in check valve to prevent water from back flowing.

All water pump switches illuminate when the water pump is activated. Please be aware the water pump must be shut OFF at the same switch used to turn it ON.

The water pump switch should be in the OFF position when the motor home is unattended for any amount of time. If something would happen to the water system, this may help limit water damage to a smaller area.

Periodically check the in-line water pump strainer for accumulated debris. To clean, shut off the water pump, unscrew the clear cap, remove the re-useable metal strainer and clear any debris, then reinstall.

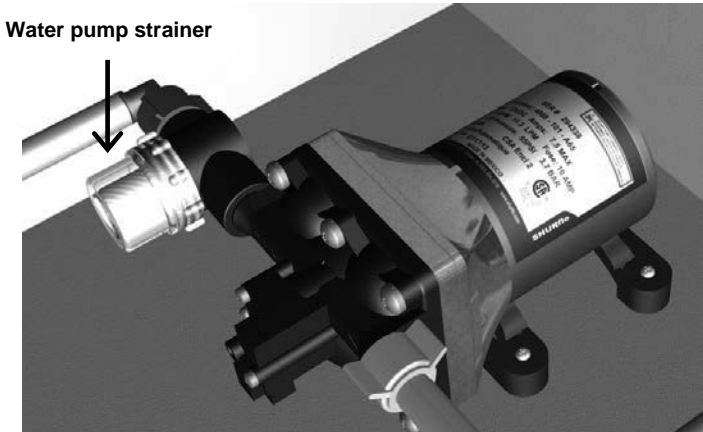

Fig. 8.1 Water pump

## WATER HEATER



### WARNING

Do not alter the operation or change the design/construction of your water heater. For your safety, only factory authorized parts should be used on your water heater. Accessories marketed for recreation vehicles, such as an “add-on” electric heating elements, are not recommended by the manufacturer. Such items are not approved to be installed and could create an unsafe condition and will void all warranties

**WARNING**

If you smell propane gas then **STOP!** and follow the procedures listed in the **Propane System Section** before attempting to operate the water heater.

Your motor home is equipped with either a tank or tankless water heater. The following is an overview of both systems. For detailed operating instructions, refer to the manufacturer's owner's manual supplied in your Warranty packet.

**Tank Water Heater System (If so equipped)****Odor from the hot water system**

Many water supplies contain sufficient amounts of sulfur to produce an odor, often called "sulfur water." Sulfur water can be caused by a chemical action or by bacteria. Generally, sulfur water is not harmful, only unpleasant to smell. Refer to the water heater manufacturer's owner's manual for details on eliminating the odor from sulfur water. Odor from sulfur water is not a service problem.

**Water heater bypass (If So Equipped)**

Your motor home may be equipped with a water heater bypass. This three-valve system is located at either the water heater, or on the system panel depending on your model. The water heater bypass valves must be in the NORMAL position (open the hot and cold valves, close the mixer – or middle – valve) to use the water heater (and when sanitizing). If winterizing the motor home plumbing system, position the three valves to the BYPASS position (close the hot and cold valves, open the mixer - or middle - valve).

**GAS/ELECTRIC DSI (TANK) WATER HEATER (If So Equipped)**

Your motor home may be equipped with a gas/electric DSI (direct spark ignite) water heater. The following is an overview of the water heater operation. For detailed operating and safety information, refer to the manufacturer's user's guide included in the Owner's Warranty packet.

**WARNING**

Hydrogen gas may result if you have not used the water heater for two weeks or more. **HYDROGEN GAS IS EXTREMELY FLAMMABLE.** To reduce the risk of injury under these conditions, open the hot water faucet for several minutes at the kitchen sink before you use any electrical appliance connected to the hot water system. If hydrogen is present, you may hear what sounds like air escaping through the pipe as the water begins to flow. Hydrogen gas may be present even after water has been drained from the water heater tank. Open the faucet at the sink and allow the system to vent for five to ten minutes. Do not smoke or have any open flame near the open faucet while venting. On DSI water heater models, make sure the switch is OFF.

Read the safety and operating information provided in the manufacturer's user guide before attempting to activate the water heater. Make sure the water heater is filled with water before use; even momentary operation of the water heater without water in it may result in damage to the tank and/or controls. Always open both the hot and cold water faucets when filling the fresh water tank to allow air pockets to be forced out of the water heater.

The DSI water heater is designed to heat water quickly and efficiently. The water heater manufacturer has preset the sensing limit to maintain the water temperature when the water heater is activated.

The thermostat on your water heater is not adjustable. It is a temperature sensing limit designed to maintain a water temperature of 130°F (54°C).

The water heater does not have a pilot. It is equipped with an ignition device which automatically lights the burner. Do not try to light the burner by hand.

### Operating instructions

1. Turn OFF all electric power to the water heater.
2. Turn OFF the propane supply.
3. Wait five minutes for the propane to clear the area. **If you smell propane STOP!** Follow the safety instructions listed in the manufacturer's owner's manual. If you do not smell propane, go to the next step.
4. Turn ON the propane supply.
5. Turn ON electrical power to the water heater.
6. Turn the switch to the "ON" position. If the burner does not light, the system will automatically attempt two more tries for ignition before lock-out occurs. *NOTE: Each ignition cycle will have a 15 second purge before spark cycle if system is a three try system.*
7. If lock-out occurs before the main burner lights, turn the water heater control switch to OFF, wait five seconds and turn the switch to the ON position. This will restart the ignition cycle.
8. The first start-up of the heater may require several ignition cycles before all the air is purged from the propane lines.

If the burner will not come on, the following items should be checked before calling a service person:

1. See if the switch is turned OFF.
2. Check to make sure the propane supply to the water heater is not empty or turned OFF.
3. Check to see if the reset button on the water heater ECO is tripped.

### High altitude deration

Operation of the water heater at high altitudes may require derating. If the water heater is not properly derated, lack of sufficient oxygen for combustion may produce improper burner operation. Pilot outage caused by burner lift-off or sooting from a yellow burner may occur, indicating the possibility of carbon monoxide. You may also notice a lack of efficiency in heating the water because of incomplete combustion of the burner at these higher altitudes. Consult with the local propane company, your dealer or the water heater manufacturer for proper derating of the water heater. Change out of the orifice (derating) should be done by the dealer or a qualified service agency.

**⊗ NOTE:** It is important that once the motor home has returned to lower elevation (below 4500 feet) any high altitude deration or other adjustments be reversed for proper operation of the water heater.

### Anode rod protection

The tank in the water heater is protected by a magnesium or aluminum anode to prolong the life of the tank by absorbing the corrosive action of hot water. Under normal use, the anode rod will deteriorate and because of this, the water heater OEM recommends the anode rod be replaced yearly. Water with high levels of iron and/or sulfate will increase the rate of deterioration; therefore, more frequent replacements may be required.

If an anode rod is mostly eaten away, replace it with a new one. The water heater manufacturer recommends replacement of the anode rod when consumption or weight loss is greater than 75 percent.

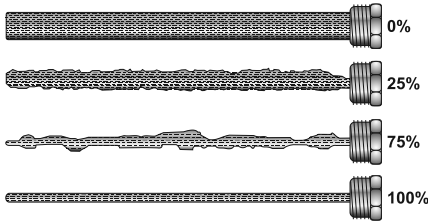

**Fig. 8.2 Anode rod replacement chart**



### WARNING

Do not replace anode rod or any other component with an accessory part that is not authorized by the water heater manufacturer, such as an "add-on electric heating element. Such items are not approved to be installed and could create an unsafe condition and will void all warranties

Operating the water heater without the proper anode rod protection will decrease tank life and will void the tank manufacturer's warranty on the tank. To extend the anode life, drain the water from the water heater tank whenever the motor home is not being used. Avoid any extended time of non-use with water in the tank.

To prevent a water leak when replacing the anode rod, a pipe thread sealant approved for potable water (such as Teflon Tape) must be applied to the threads of the anode rod. Proper application of a thread sealant will not interfere with the anode's function.

#### Pressure & temperature relief valve

The temperature and pressure relief valve is designed to open if the temperature of the water within the heater reaches 120° F, or if the water pressure in the heater reaches 150 pounds. When this pressure is reached, the pressure relief valve will open and water will drip from the valve.

This "weeping" or dripping will continue until the pressure is reduced to below 150 pounds, and the valve closes. This condition is normal and does not indicate a defective relief valve.



### WARNING

Do not place a valve between the pressure and temperature (P&T) valve and the tank. Do not remove or plug the relief valve under any circumstances.

One way to reduce the frequency of this occurrence is to maintain an air pocket at the top of the water heater tank. This air pocket will form in the tank by design; however, it will be reduced over time by the everyday use of your water heater. To replenish this air pocket:

1. Turn off the water heater.
2. Turn off the cold water supply line.
3. Open a faucet in the motor home.

4. Pull out the handle of the pressure relief (P&T) valve and allow water to flow from the valve until it stops.
5. Release the handle on the P&T valve - it should snap closed.

Close the faucet and turn on the cold water supply. As the tank fills, the air pocket will develop. Repeat this procedure as often as needed to reduce the frequency of the weeping P&T valve.

### **Maintenance**

Do not allow the burner to burn with a yellow flame, or continue to operate the water heater with an improper burner flame.

Periodically, inspect the water heater vent for soot. Soot is a sign of incomplete combustion and must be corrected before operating the water heater. This is your visual warning that the water heater is operating in an unsafe manner. If soot is present, immediately shut the unit down and contact your dealer or a qualified service agency.

Periodically inspect the vent for obstructions. Do not terminate the vent on your water heater inside of add-on rooms, screen porches or patios. Doing so will result in products of combustion being vented into the rooms or occupied areas.

### **Draining the water heater**

The water heater should be drained if your motor home is going to be stored for an extended period of time. See Water heater bypass on page 8-4 of this section.

If the motor home is to be stored over the winter months, the water heater must be drained to prevent potential damage from freezing. Damage to the water heater caused by freezing is not warrantable. Refer to the water heater manufacturer's owner's manual for details on winterizing your water heater.

1. Turn off electrical power to the water heater either at the switch from the electrical element of at the breaker.
2. Shut off the propane supply to the water heater.
3. Turn off the pressure pump on the water system.
4. Open both hot and cold water faucets.
5. Remove the anode rod from the tank.

### **For more information**

Read the manufacturer's owner's manual. If you have further questions contact your RV dealer, the manufacturer, or Jayco Customer Service.

### **TANKLESS WATER HEATER (If So Equipped)**

Your motor home may be equipped with a tankless water heater. The tankless water heater uses up less LP Gas than storage tank model water heaters since it only uses energy when hot water is demanded. There is no pilot light to burn when no hot water is needed. The tankless water heater supplies an unlimited supply of hot water on demand (once lines are purged of standing water). As hot water is demanded, the cold water enters the heater. A water flow sensor detects the flowing water and automatically ignites the burner. Water circulates through the heat exchanger and is heated to the set temperature. When the tap is closed, the unit shuts down.

The tankless water heater does not require an anode rod to prevent corrosion, or a by-pass valve for winterizing. It is not affected by high altitudes.

The output temperature of the water depends on the temperature of the inlet water AND the amount of hot water that is drawn. If the inlet water temperature is over 65°F the tankless water heater will generate water in the range of 105°F to 120°F (on Low flame) depending on the water flow selected by the user.

### Operating Tips

- Purge air out of ALL hot and cold water lines.
- Open the water heater door and turn the power switch “ON”.
- Set GMC dial to appropriate setting.
- Open hot water faucet to a medium water flow.
- To reduce temperature:
  - Turn GMC dial “counter-clockwise”.
  - Increase hot water flow.
  - Gradually add cold water.
- To increase temperature:
  - Turn GMC dial “clockwise”.
  - Reduce hot water flow.

### For Additional Information

For detailed operating information refer to the manufacturer’s owner’s manual included in the Warranty Packet.

### Winterization

Freezing of the water heater and its plumbing components will result in severe damage not covered by warranty. For this reason it is advisable to follow the recommendation(s) below if the unit is to be stored in a freezing environment or for long periods of time. At the start of the winter season or before traveling to a location where freezing conditions are likely, the unit must be winterized.

The very small amount of water present in the heat exchanger **DOES NOT** require the installation of a bypass kit. Winterization can be accomplished using one of the two common methods of winterization used for RV water systems, The compressed air method or the anti-freeze method. Refer to “Winterization” in this section for details.

### Winter Use Device (WUD)

If you wish to operate the water heater in potentially freezing conditions the model GSWH-1M has a built in thermostat that will start the burner whenever the temperature of the Heat Exchanger falls below 38°F and will automatically shut off when it senses a temperature in excess of 58 °F.

**IMPORTANT:** To allow the WUD device to operate you must have sufficient LP Gas in the tank and you must leave the unit powered with the ON / OFF switch in the ON position at all times that freezing may occur. It will not protect the entire RV’s plumbing system. The RV must be designed for winter use/freezing conditions.

### Pressure - Temperature Relief Valve

This water heater is equipped with a temperature and pressure relief valve that complies with the standard for Relief Valves and Automatic Gas Shutoff Devices for Hot Water Systems, ANSI Z21.22.



## WARNING

### SCALDING INJURY-EXPLOSION

- Valve is not serviceable; if defective it must be replaced.
- Tampering with valve will result in scalding injury. Do not place a plug or reducing coupling on outlet part of valve. If you use a discharge line allow complete drainage for both valve and line.
- Tampering with valve will void the warranty.

**THIS VALVE IS A SAFETY COMPONENT AND MUST NOT BE REMOVED FOR ANY REASON OTHER THAN REPLACEMENT.**

**WHEN REPLACING THE PRESSURE–TEMPERATURE RELIEF VALVE**

- ❑ **DO NOT** install anything less than a combination pressure–temperature relief valve certified by a recognized testing laboratory that conducts periodic inspections of such products and certifies them as meeting the requirements for Relief Valves and Automatic Gas Shutoff Devices for Hot Water Supply Systems, ANSI Z21.22. Valve must have a maximum set pressure not to exceed 150 psi.
- ❑ Install valve into opening provided and marked for this purpose on water heater.
- ❑ Installation must conform with local codes or in the absence of local codes, American National Standard for Recreational Vehicles, ANSI A119.2/NFPA 501C.

**For more information**

Refer to the manufacturer’s user guide included in your Warranty Packet.

**Maintenance**

Inspect your water heater monthly and have it serviced at least once a year by the manufacturer’s recommended service technician. Refer to the manufacturer’s owner’s manual for detailed inspection and maintenance information. If you have further questions contact your RV dealer, the manufacturer, or Jayco Customer Service.

**OUTSIDE SHOWER**

A handheld shower assembly with both hot and cold water is available for washing or rinsing with the outside shower.

1. Be sure the water heater is ON and had sufficient time to heat the water.
2. Open the outside shower compartment door.
3. If dry camping, be sure the 12-volt water pump is ON.
4. Remove the handheld shower from its holder.
5. Turn ON the hot and cold faucet knobs, and adjust the water temperature as desired.
6. To activate the handheld shower turn ON the sprayer head attachment (some models).

To cease operation, close the faucet knobs. After the water has been allowed to drain from the shower head, replace it in the outside shower compartment. Any remaining water in the shower hose will drip or run out; this is not a leak but performs as intended.

**FAUCETS**



**WARNING**

Water temperatures over 125°F (49°C) can cause severe burns instantly or death from scalds; therefore, be careful when using hot water. Always test the water temperature before showering or washing.

The faucets operate much the same way as the faucets in your home. Make sure there is sufficient water available and, if dry camping, the 12-volt water pump is turned ON before operating.

To open the faucets, turn the hot and cold knobs ON and adjust the temperature to your comfort level. Close the faucets when a sufficient amount of water is released.

The tub/shower faucet requires a vacuum breaker when the shower hose and head are used. There are two purposes for this breaker:

- To prevent siphoning water through the hose from another fixture.
- To prevent water from being contained in the hose.

The showerhead DOES NOT have a complete shut-off valve (the complete shut-off is at the faucet). The showerhead may drip slightly in the OFF position after use; this is normal and does not indicate a leak or defect. There may be air in the plumbing lines that will need to be bled out before a steady stream of water comes from the faucet.

### **For more information**

Refer to the manufacturer's owners manual.

## **BATHROOM TUB / SHOWER**

---

The bathing facilities in your motor home function similar to those in your home. Keep the water heater and holding tank capacities in mind when using the fresh water system. Long showers are not suggested due to the limited amount of water available. The used water will drain through the plumbing pipes into the grey water holding tank.

1. Be sure the water heater is ON and had sufficient time to heat the water.
2. If dry camping, be sure your 12-volt water pump is ON.
3. Adjust the hot and cold faucets to the desired temperature before bathing.
4. To conserve water while showering, wet down and turn the water OFF while you use soap, then rinse.
5. When you are finished, shut the water faucets OFF.

Unlike your home, the motor home does not contain a water pressure balance valve. If someone is using the shower, it is recommended that the fresh water system NOT BE USED until they are finished.

### **Maintenance**

Read the manufacturer's operator manual or label instructions. The tub/shower walls (if applicable) in your motor home are made of ABS plastic material. Use a mild detergent soap and warm water to clean. Contact your RV dealer for repair or replacement.

Do not use gritty or abrasive particle soaps or scouring compound to clean ABS plastic. Avoid using "Citrus" or biodegradable cleaners which contain "D-Limonene." They will damage plastic materials.

## **HARDWARE & SINK OR SHOWER FIXTURES**

---

Use mild dish soap and water to clean these fixtures. Do not use harsh chemicals or sprays. A mild solution of vinegar and water works well to remove hard water spots and stains from the sink or shower fixtures.



## WATER PURIFICATION SYSTEM

The water purification system is located in the utility compartment in most models. Other locations may include the kitchen, bath or hutch cabinet. If the water supply has not been used for some time, allow the water to flow for several minutes to flush the system. When not in use, the water filter cartridge should be stored out of freezing temperatures. RV antifreeze will damage the water filter cartridge.

The water purification system manufacturer has supplied a plastic bypass hose with fittings on either end that is designed to replace the water filter cartridge when the motor home is being winterized. This plastic bypass hose is re-usable, store it when it is not in use.

**Each new RV is winterized with RV antifreeze before it leaves Jayco, Inc. To use the water purification system the clear plastic bypass hose must be removed and the water filter cartridge installed.**

### Replacing the water filter cartridge

Replace the water filter cartridge at least once a year.

1. Drain the fresh water system.
2. Place a container beneath the water cartridge filter to catch any spillage.
3. Unscrew the fittings at the top and bottom of the water filter cartridge. Pull the water filter cartridge down and out of the fittings.
4. Insert the new water filter cartridge and tighten the fittings securely by hand. Dispose of the used water cartridge filter.

### For more information

Refer to the manufacturer's owners manual and the label on the water filter cartridge.

## DRAINING THE FRESH WATER SYSTEM

To drain the fresh water holding tank and supply lines:

1. Open all faucets, including the outside shower faucet.
2. Open the "fresh tank drain" valve.  
All permanent fresh water tanks can be drained by one of two types of drain valves. A white plastic drain is attached to the exterior wall (open valve to drain) or a valve located inside the motor home adjacent to the water tank (this knob turns 45° to open or close).
3. Open the "low point drains" by turning, then pulling the handles up.

As their name indicates, they will be at the lowest point of water lines. A label is placed on the outside of the RV to indicate where the drains are located. The drains will typically need to be opened from inside the motor home. Once the label is found on the exterior sidewall, go inside the motor home to find the corresponding location of the drains.

4. Turn ON the water pump and allow it to run as needed.
5. Operate the toilet flush lever until water stops flowing.
6. Relieve the water pressure using the P&T valve BEFORE removing the water heater drain plug.
7. Otherwise, if there is any water pressure present the water will spray out of the opening when the drain plug is removed.



**Fig. 8.3**  
Exterior  
fresh water

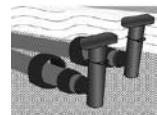

**Fig. 8.4** Low  
point drains

When you are finished draining the fresh water system, reverse these steps and dump the grey and black water holding tanks at an appropriate facility or according to local public codes.

## UTILITY CENTER

The following information defines the function of the utility center settings indicated on the utility center label:

**City Fixtures** - This setting allows you to access water at all faucets using city water.

**City Tank Fill** - This setting allows you to fill your fresh water tank using city water.

**Country Fill** - This setting allows you to fill your fresh water tank (using the 12-volt water pump) when you do not have access to city water.

**Normal** - If the RV is not connected to city water, this setting allows you to pump water from the fresh water tank to all faucets using the 12-volt water pump.

**Sanitize/Winterize Lines** – This setting allows you to sanitize or winterize your fresh water system.

**Sanitize Tank** – This setting allows you to sanitize the fresh water tank.

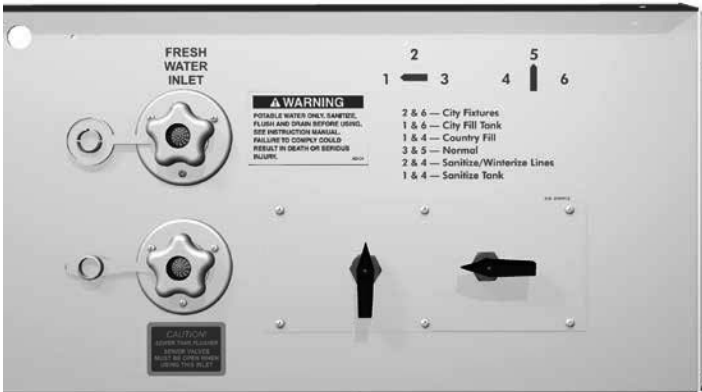

The city water connection inlet is located in the utility compartment. We recommend that you use a non-toxic drinking water hose dedicated only to supplying the motor home with fresh water (to reduce the chance of contamination, prevent the non-toxic drinking water hose from coming into contact with the ground). Install the city water connection inlet cap when the fresh water connection is not being used. Do not remove the following label from your motor home:



Fig. 8.5 Potable water only label

**The fresh water connection should be unplugged (i.e., the non-toxic drinking water hose disconnected) when the motor home is unattended for any amount of time. If something would happen to the water system, this may help limit water damage to a smaller area.**

### **City Water Fill**

Use this setting if you are at a campground or other facility where the motor home can be hooked up to an external water source.

1. If needed, sanitize the water system prior to travel.
2. Move the “water heater bypass valve” to the NORMAL position.
3. Remove the city water connection inlet cap and attach a non-toxic drinking water hose to the city water connection inlet.
4. Place the utility center valves in the “City Fixtures” position.
5. Turn ON the water at the external water source.
6. Enter the motor home and open the cold water supply faucets to bleed air from the water lines. When the water lines are nearly full, you may experience some “air pockets.” Allow them to escape before closing the cold water supply faucets.
7. The water heater will fill first, followed by the supply lines and faucets.
8. Turn the appropriate (12-volt or 120-volt) water heater control switch ON.

### **To disconnect**

9. Shut OFF the water at the external water source.
10. Disconnect the non-toxic drinking water hose and reinstall the city water connection inlet cap.

### **City Water Tank Fill**

Use this setting to fill the water tank using the city water tank fill.

1. If needed, sanitize the water system prior to travel.
2. Move the “water heater bypass valve” to the NORMAL position.
3. Remove the city water connection inlet cap and attach a non-toxic drinking water hose to the inlet.
4. Place the utility center valves in the “City Tank Fill” position.
5. Turn ON the water at the external water source.
6. Water will flow into the fresh water tank.

### **To disconnect**

During the filling process, periodically check the fresh water tank level using the monitor panel located in the Command Center. When the fresh water tank is full, it is normal to see water running from the fresh water overflow tubes onto the ground.

7. Shut OFF the water at the external water source.
8. Disconnect the non-toxic drinking water hose and reinstall the city water connection inlet cap.

### **Country Water Fill**

Generally speaking, this setting is used to fill the water tank when dry camping.

1. If needed, sanitize the water system prior to travel.
2. Move the “water heater bypass valve” to the NORMAL position.
3. Remove the city water connection inlet cap and attach a short non-toxic drinking water hose running from your container of potable water to the city water connection inlet.
4. Place the utility center valves in the “Country Fill” position.
5. Turn ON the water pump.

6. Enter the motor home and open the cold water supply faucets to bleed air from the water lines. When the water lines are nearly full, you may experience some "air pockets." Allow them to escape before closing the cold water supply faucets.
7. The water heater will fill first, followed by the supply lines and faucets.
8. When at your campsite, turn the appropriate (12-volt or 120-volt) water heater control switch ON.

### **To disconnect**

During the filling process, periodically check the fresh water tank level using the monitor panel located in the Command Center. When the fresh water tank is full, it is normal to see water running from the fresh water overflow tubes onto the ground.

9. Shut OFF the water pump.
10. Disconnect the non-toxic drinking water hose and reinstall the city water connection inlet cap.

### **Utility Center Normal Setting**

Generally speaking, this setting allows you to use the water system when dry camping.

1. If needed, sanitize the water system prior to travel.
2. Turn the appropriate (12-volt or 120-volt) water heater control switch ON.
3. Move the "water heater bypass valve" to the NORMAL position.
4. Place the utility center valves in the "Normal" position.
5. Turn on the water pump (make sure you have sufficient 12-volt power).
6. Water will be pumped from the fresh water tank to all faucets.

### **Sanitization**

#### **When to sanitize**

- When your motor home is new.
- At the beginning and end of each season.
- When the water system becomes contaminated or every three months of use.

#### **How to sanitize**

1. Level the motor home and drain the fresh water system (see **Draining the fresh water system**).
2. Prepare a chlorine solution using 1/4 cup of household bleach (sodium hypochlorite solution) to one gallon (3.785 liters) of water in a container. Prepare one gallon of solution for every 15 gallons of tank capacity. This will result in a residual chlorine concentration of 50 ppm in the water system. If a 100 ppm concentration is required as discussed in step 13, use 1/2 cup of household bleach with one gallon of water to prepare the chlorine solution. One gallon of the solution should be used for each 15 gallons of tank capacity.
3. At the exterior utility center, place the clear hose into the container with the chlorine solution.
4. Turn the "city water / fresh tank fill valve" to the FILL TANK position.
5. Turn the "sanitize / winterize intake valve" to the SANI/WINT position.
6. Turn the water pump ON.
7. After the recommended amount of solution is in the tank, turn the "sanitize/winterize intake valve" back to the NORMAL position.
8. Turn the "city water / fresh tank fill valve" to the NORMAL position.
9. Open the hot water line on all the faucets (kitchen, lavatory, shower and outside shower) until water begins to flow continuously and a chlorine smell is noticeable.

10. Close the hot water lines and repeat with the cold water lines on the faucets.
11. Let the solution remain in the system for at least four hours when disinfecting with 50 PPM residual chlorine. If a shorter time period is desired, then a 100 PPM chlorine concentration should be permitted to sit in the system for at least one hour.
12. After the required period, drain the chlorine solution from the fresh water system (see **Draining the fresh water system**). Some solution may remain in the water heater and will be flushed in the following steps:
13. Fill the fresh water system using clean (potable) water (see **Fresh water connections**) completely full.
14. Then, drain the fresh water system (see **Draining the fresh water system**).

**⊗ NOTE: If a chlorine taste lingers in the water, flush the water system with a solution consisting of one-quart vinegar to five gallons of clean water. Re-flush as necessary.**

### **Winterization**



### **WARNING**

Automotive antifreeze (ethylene glycol) and windshield washer antifreeze (methanol) are poisonous. Never use these products in your fresh water system. These products are harmful and may be fatal if swallowed

Preparing your motor home for colder weather or storage is very important for most states and Canada. Failure to prepare your motor home may cause water supply lines and the water heater to freeze.

No commodity or product should be added to the fresh water system to ensure freeze protection other than RV antifreeze.

The motor home should be winterized at the end of the camping season or when the motor home will be exposed to temperatures that will fall at or below 32°F (0°C). Repairs due to freezing are not covered by warranty.

There are two methods of winterizing your motor home based upon your model. Please read, understand and follow all instructions before beginning.

### **Air pressure**

This method will utilize an air hose to blow excess water from the water lines.

1. Make sure all holding tanks are empty and drain valves OPEN.
2. Run the water pump until it is dry, this will take approximately 15-20 seconds.
3. OPEN all faucets and drains, and the toilet.
4. Using an air hose and adapter (customer supplied), blow air through the city water connection. Any remaining water will blow out in five to ten minutes.

Pour one cup of non-toxic RV antifreeze into all drain P-traps.



### **WARNING**

Never apply air pressure to the water system with any of the valves in the closed position. Air pressure applied to a closed valve, faucet or low point drain could potentially damage the seals and cause water leaks. If you have questions, consult with your RV dealer.

### **Antifreeze method**

It may be easier to winterize the motor home with another person to assist you.

1. Level the motor home and drain the fresh water plumbing system.
2. Replace the water filter cartridge with the clear plastic bypass hose. Make sure the water heater 12-volt and 120-volt interior control switches are OFF.
3. Turn the water heater bypass valve to the BYPASS position. (if so equipped).
4. Move the valves to the “Sanitize/Winterize Lines” position. The low point drains must be closed for the antifreeze to siphon through the lines.
5. Insert the garden hose into a container of motor home antifreeze solution (this quantity should be enough to winterize the motor home); attach the other end to the city water connection. *To assist the siphoning process, put the container on a surface approximately two feet above ground level.*
6. Turn the water pump ON. *If the water pump fails to self-prime, temporarily open the low point drains (close the low point drains as soon as the water pump primes [RV antifreeze will begin draining out] and before continuing to the next step).*
7. Open the hot water line on all the faucets (kitchen, lavatory, shower and outside shower) until RV antifreeze begins to flow continuously.
8. Close the faucet hot water lines and repeat with the cold water lines on all the faucets. Do not forget to run RV antifreeze through the toilet.

**When you are done adding RV antifreeze**

9. Remove the garden hose from the container of RV antifreeze.
10. To prevent staining, wipe the RV antifreeze out of the sinks, shower (or tub) and toilet using a soft, dry cloth.

To reduce the chance of contamination, prevent the garden hose from coming into contact with the ground. If needed, contact your RV dealer for assistance.

**BLACK/GREY WATER SYSTEM**

---

Water from the sinks and shower (or tub) flow into the gray water (or waste water) holding tank. Water from the toilet will flow into the sewage (or black water) holding tank. Certain floor plans may also have the lavatory draining into the waste (black) tank.

**Drain pipes**

The drain pipes have a “P-trap” installed to help prevent odors from escaping into the motor home. During travel, water from the P-traps may spill and permit odors into the motor home. These odors come from food particles decomposing in the tank.

By adding water and using a RV approved deodorizing agent you will dissolve the contents faster and will keep the drain lines and tanks clean and free flowing. These chemicals are available at an RV supply store or your Jayco independent dealer.

**Vents**

Another important part of this system is the vent pipes and vents that release air from the grey and black water holding tanks. The exterior vent cap is attached to the roof and must be kept clear of obstructions to perform as intended.

On some models, the vent pipe may be part of the drainage system referred to as a “wet vent” (water flows downward as air flows upward in the same pipe).

**BLACK/GREY WATER HOLDING TANKS**

---

The weight of the holding tank contents is not calculated into the motor home cargo carrying capacity (this extra weight would reduce your available cargo capacity).

Traveling with full holding tank(s) could possibly cause you to exceed the individual tire ratings and/or the motor home GAWR or GVWR.

Potential damage to suspension components, such as springs, tires and axles, could result. If your motor home holding tank(s) are located behind the axles, the weight of the full tank(s) will reduce the hitch weight. Motor home sway and other handling difficulties can be the result of the hitch weight being too light.

**WARNING**

Never travel with full black or grey water holding tanks. This not only wastes your fuel but depending on the location of the tank(s), it can affect your vehicle handling characteristics.

Dump the gray and black water holding tanks before traveling to avoid carrying unnecessary weight. If you are dry camping and cannot immediately empty your holding tanks, reduce your vehicle speed until you reach a dumping station. When connected to the sewer drain line at a campground, keep the “black tank drain” valve closed until the holding tank is at least  $\frac{3}{4}$  full. This should provide sufficient water to assist in complete draining of the black water holding tank. Repeat as needed.

Before using the motor home or after dumping the grey and black water holding tanks, always add the proper amount of deodorant to the black water tank to prevent malodors and help break down holding tank contents (unless winterizing). Follow the deodorant bottle or package instructions. Driving to a disposal site will normally loosen any accumulated waste debris or solids from the sides of the holding tanks.

Never leave the black tank drain in the open position continuously when connected to the campground sewer system.

**WARNING**

Do not add automotive antifreeze or caustic chemicals such as laundry detergents into the holding tanks. Although these products may have a deodorizing effect, they may damage the plastic and rubber parts of the plumbing system or the components.

**BLACK & GREY TANK DRAINS**

The grey tank drain and black tank drain are also referred to as dump valves. Always drain the black water holding tank first so the following grey tank waste water can help rinse any solids or debris from the dump outlet and sewer hose.

1. To make drainage easier, level the motor home.
2. Remove the sewer hose housing dust cap, and attach the sewer hose.
3. Place the end of the sewer hose into the approved dump station.
4. Open the black tank dump valve (close it when the black water holding tank is emptied).
5. Open the grey tank dump valve (close it when the grey holding tank is emptied).
6. Remove, clean and store the sewer hose.
7. Close the sewer hose housing dust cap.

You can locate many dump stations throughout the United States and Canada in Woodall's, Rand McNally Camp Guide, Good Sam Camp Guide, KOA Campgrounds Camp Guide and various other publications. Some fuel stations also have dump stations.

Please contact your RV dealer for assistance in the purchase and installation of a sewer hose and/or sewer hose extension (if needed).

### BLACK TANK FLUSH (IF SO EQUIPPED)



#### WARNING

Do not use the same hose to fill your fresh (potable) water tank that is used for the black tank flush.

The black tank flush is also called a “no fuss flush.” The fresh water from the non-toxic drinking water hose goes directly into the black water holding tank where there is a “sprayer” connection located.

This allows you to clean the black water holding tank by removing debris and preventing accumulation.

There is a check valve incorporated in the plumbing lines to prevent back flow. Flush the black water tank each time the grey and black water holding tanks are dumped or as needed:

1. Dump the black water tank and leave the black tank drain valve open.
2. Connect a garden hose from the water supply source to the “black tank flush.”
3. With the water source turned ON, flush the black water holding tank until the water running out of the black tank drain valve is clear (not discolored or cloudy).
4. Disconnect the garden hose and close the “black tank drain” valve. Fasten the sewer hose housing dust cap back on the “black tank flush.”



#### CAUTION

The black tank drain valve must be OPEN any time there is a hose (water supply) connected to the black tank flush



#### CAUTION

Do not leave any hose (water supply) connected to the black tank flush when it is not in use.

### TOILET

The toilet is efficient and easy to operate. Generally, more water is required only when flushing solids.

Prior to using the sanitation system, it is strongly recommended to flush the toilet several times to release sufficient water into the holding tank. If there is not a sufficient amount of water used during flushing, the waste materials may not evacuate properly from the drain line to the tank. Clogged tanks and pipes could eventually occur.



The toilet system will perform better when water is run for ten to fifteen seconds after flushing to ensure that the waste will proceed to the bottom of the tank.

Unlike a toilet in a home, which may use up to seven gallons of water per flush, the average recreation vehicle system uses one to three quarts (1 - 3 liters).

For added convenience and better sanitation system performance, it is advisable to always have four to six inches (10 - 15 cm) of water in the toilet.



### WARNING

It is important to prevent solid waste buildup. Follow the toilet manufacturer's recommended instructions each time after emptying the black water holding tank.

To prevent help toilet blockage, always use RV grade single-ply toilet paper. Do not flush paper towels, diapers, sanitary napkins or other foreign objects down the RV toilet.



### CAUTION

It is important to add enough water to prevent solid waste buildup. Follow the directions listed below and in the manufacturer's operator manual.

#### **Sewage (black) tank preparation**

1. Release one to two quarts (1 or 2 liters) of water into the toilet bowl.
2. Follow the directions on your toilet chemical bottle (customer supplied), by placing the recommended quantity of holding tank chemical into the toilet bowl.
3. Flush the toilet and allow at least two gallons (8 liters) of water to flow into the holding tank.

#### **Waste (grey) holding tank preparation**

No special preparation is required; however, placing a small quantity of chemicals into this tank (such as baking soda or an approved RV chemical) will reduce odors from food particles in the system.

#### **Cleaning & Maintenance**

The toilet should be cleaned regularly for maximum sanitation and operational efficiency.

Do not use chlorine (undiluted) or caustic chemicals, such as laundry bleach or drain opening types, in the toilet system. These products damage the seals in toilets and dump valves.

#### **For more information**

Refer to the manufacturer's operator manual. If you have further questions consult your RV dealer, the manufacturer or Jayco Customer Service.

**THIS PAGE IS INTENTIONALLY BLANK**

---

---

**DUCTING & RETURN AIR**

---

All heat discharges, registers and return air grills must be free and clear of obstructions. This includes all closeable registers that are intended to reduce airflow, do not shut it off completely.

---

**ATTIC FAN (IF SO EQUIPPED)**

---

The 12-volt DC attic fan (or powered roof vent) allows fresh air to circulate through the motor home. Do not leave the attic fan open when the motor home is stored or unattended for long periods. High winds, other unusual conditions or obstructions may prevent the dome from closing; the resulting leakage could cause non-warrantable damage.

---

**THERMOSTAT**

---

There may be up to two 12-volt DC thermostats in your motor home. Use the controls to set the temperature to your comfort setting.

---

**AIR CONDITIONER**

---

Your motor home has a roof mounted air conditioning system that is controlled by a thermostat. Cooled air enters the motor home through the adjustable “chill grill.” Make sure you have sufficient power available before operating the air conditioner. Do not operate the air conditioner without the return air filter.

Operating the system without the filter allows the lint and dirt that is normally stopped by the filter to accumulate on the cooling coil of the air conditioner. This also will lead to a loss of air volume, possible equipment damage and an expensive cleaning process.

A special foam gasket is placed between the roof material and the subframe of the air conditioner to guard against water leakage. The air conditioner is subjected to wind pressures along with motor vibration during normal operation. Inspect the mounting bolts for tightness to ensure there is no leakage or looseness at least annually. Re-tighten bolts when they are loose. DO NOT over tighten these bolts as it may damage this gasket. The air conditioner gasket is a wearable part that eventually will need to be replaced. To gain access to the bolts, remove the filtered panel cover on central air systems or the entire air box on non-central air conditioners.

**Heat pump operation**

Set the thermostat for either electric or gas heat. On the electric setting, the heat pump will become the primary heat source as long as the interior temperature of the RV has not dropped 5° below the thermostat set point. If this occurs, the thermostat will automatically activate your gas furnace.

The furnace will continue as the heat source until the thermostat set point has been satisfied. At that point, the heat pump will again become the primary heat source.

---

**FURNACE**

---

The furnace installed in your motor home is controlled by a thermostat. The furnace requires both 12-volt power and propane gas for full operation. Make sure you have sufficient power available before operating your furnace

If you have any questions contact your dealer or Jayco Customer Service.

A qualified RV technician should perform all furnace maintenance at least once a year (more often depending on furnace usage). Never attempt to repair the furnace yourself.

**WARNING**

The furnace should be inspected periodically (monthly during the heating season) for presence of soot on the vent. Soot is formed whenever combustion is incomplete. This is a visual warning that the furnace is operating in an unsafe manner. If soot is observed on the vent, immediately shut the furnace OFF and contact a qualified service agency. Operating the furnace under this condition could lead to serious property damage, personal injury or loss of life.

**WARNING**

To ensure your personal safety, do not obstruct or alter the furnace in any manner. Do not install screens over the vent for any reason. Screens will become restricted and cause unsafe furnace operation. For your safety, only the manufacturer's factory authorized parts should be used on your furnace.

**REFRIGERATOR****WARNING**

If you smell propane gas **STOP!** Follow the directions located in your manufacturer's owner's manual and in this manual.

The refrigerator is not intended for quick freezing or cooling. We recommend stocking it with pre-frozen or pre-cooled food when possible. The shelves should not be covered with paper or plastic and the food items should be arranged so air can circulate freely. Keep the area at the back of the refrigerator clean and free of debris. Check for obstructions in the exterior refrigerator vent area (i.e., spider webs, bird nests, etc). Use a soft cloth to dust off the debris.

For optimum efficiency and performance, it is recommended the refrigerator be checked at least twice a year as part of the routine maintenance.

**MICROWAVE (IF SO EQUIPPED)**

For details on operation, cleaning and safety information, refer to the manufacturer owner's manual.

**⊗NOTE:** To prevent damage, remove the turntable from the microwave when traveling.

**⊗NOTE:** Make sure you are connected to a 120-volt power source

**CONVECTION MICROWAVE (IF SO EQUIPPED)**

For details on operation, cleaning and safety information, refer to the manufacturer owner's manual.

The convection microwave bridges the gap between microwaving your food and conventional cooking. Make sure there is sufficient 120-volt power available before operating the convection microwave (refer to **Sec. 6 Electrical Systems**, calculating electrical load).

**⊗NOTE:** To prevent damage, remove the turntable from the microwave when traveling.

**⊗NOTE:** Make sure you are connected to a 120-volt power source

**Microwave Oven Use**

For list of preset programs, see the Quick Reference Guide provided with your model.

**General Cleaning**

**IMPORTANT:** Before cleaning, make sure all controls are off and the microwave oven is cool. Always follow label instructions on cleaning products.

To avoid damage to the microwave oven caused by arcing due to soil buildup keep cavity, microwave inlet cover, cooking rack supports, and area where the door touches the frame clean.

Clean with mild soap, water and a soft cloth or sponge, or as indicated below.

- Grease filters: mild soap and water or dishwasher.
- Door and exterior: mild soap and water, or glass cleaner applied to paper towel.
- Control panel: sponge or soft cloth and water.

- ❑ Stainless steel (on some models): mild soap and water, then rinse with clean water and dry with soft cloth, or use stainless steel cleaner.
- ❑ Turntable: mild soap and water or dishwasher.
- ❑ Rack(s): mild soap, water and washcloth. Dishwasher cleaning is not recommended.

### **COOKING WITH PROPANE**

See Propane System Section for important safety instructions. Refer to the manufacturer's owners manual for detailed operating and safety instructions for all propane appliances.

### **KITCHEN RANGE & OVEN (IF SO EQUIPPED)**



#### **WARNING**

During and after use, do not touch or let clothing or other flammable material come in contact with the top burners (or heating elements), burner grates or other areas near the top burners or oven until they have had sufficient time to cool. These areas can get hot enough to cause burns.



#### **WARNING**

If using glass, glass/ceramic, ceramic, earthenware or other glazed utensils (or cookware) verify it is safe for use on the top burners. Only certain types of utensils (or cookware) are suitable for surface or top burner use.



#### **WARNING**

Never leave cooking food unattended. Turn the pan handles inward but not over the tops of the other range burners. Ensure that pans used are large enough to contain the food and avoid boil-overs. Heavy splattering or spills left on the cook top can ignite and cause burns.

To prevent damage, always use the manufacturer's recommended size flat bottom pan(s). Generally, the pan should be large enough to cover the burner, but not be more than one inch larger than the burner grate. Do not use a broiler pan, griddle or any other large utensil that covers more than one burner at a time.

This will create excessive heat that may cause melting, sooting or discoloration.

In addition, the use of undersized pans could expose a portion of the heating element to direct contact and may result in ignition of clothing. Proper relationship of pans to burner will improve efficiency.

Refer to the manufacturer owner's manual for detailed operating and safety instructions.

**OVEN (IF SO EQUIPPED)****WARNING**

Do not cover the oven vent openings while the oven is in operation. Restricting the flow of combustion air will create an asphyxiation hazard.

The propane gas oven must have 12-volt power to operate. If you have any questions contact your dealer or Jayco Customer Service. Do not use the oven as a storage area.

Refer to the manufacturer owner's manual for detailed operating and safety instructions.

**IN CASE OF A GREASE FIRE****WARNING**

Do not attempt to use water to put out the fire. Water can spread some types of fire, and electrocution is possible with an electrical fire.

Grease is flammable. Never allow grease to collect around top burners or on the cook top surface. Wipe up spills immediately. Refer to Section 2 – Safety Precautions, for fire safety and fire extinguisher information.

**BBQ GRILL (IF SO EQUIPPED)****WARNING**

Make sure that you read, understand and follow all information supplied with your RV about propane before operating the BBQ grill. The propane hose must be correctly connected before lighting the grill. Failure to follow instructions supplied by the grill manufacturer with your RV or to use any other components than those originally supplied with the grill could lead to death or serious injury from fire or explosion.

**WARNING**

The maximum weight limit for the bracket on the side of your motor home is 50 lbs. This limit includes the weight placed on the BBQ grill. Exceeding this weight limit could cause damage to the unit and possibly cause personal injury from hot equipment.

The BBQ grill is for use outside of the motor home. **Never use this grill inside a compartment or the motor home.** Before operating the BBQ grill, make sure that it is securely placed on the support bracket. The BBQ grill must be COMPLETELY cooled before storing to avoid damaging the carrying case (if so equipped) and causing injury from handling the grill when it is hot. Wait until the grill is completely cooled, then store it.

**Attaching the “quick coupler” connection**

The “quick coupler” is directly connected to the RV propane system. The “quick-coupler” connection has a positive shut-off valve as required by code and standards.

1. Place the “quick coupler handle in the OFF position and push back the sleeve. The valve handle must be OFF to make the connection.
2. Insert the plug and release the sleeve.
3. Push the plug until the sleeve snaps forward, locking the plug into the socket.
4. Turn the handle ON to allow propane to flow to the drop in stove.

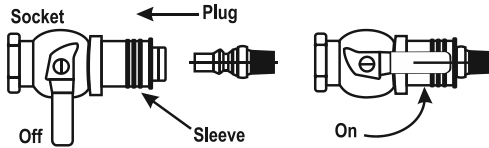

**Fig. 10.1 Quick connect coupler**

**BBQ Grill Prep (if so equipped)**

Your RV is equipped with a propane “quick-coupler” connection and support bracket for easy installation of the BBQ grill.

**WATER HEATER – SEE PLUMBING SECTION**



## TELEVISION POWER SUPPLY

For good station reception, the TV power supply must be turned ON to view local television stations. Turning the TV power supply ON sends 12-volt DC through the cable to the TV roof antenna. The voltage energizes the transistors in the antenna head amplifier. The TV signal then comes down the cable to the outlets.

Turn the TV power supply OFF to view cable television or to use a VCR or DVD.



**Fig. 11.1 TV Power Supply**

## TELEVISION ROOF ANTENNA

To view local stations at either (or both) the front or bedroom television sets using the television antenna, make sure the TV power supply is ON and the TV roof antenna is raised to the operating position.

The following is an overview of the antenna operation. Refer to the manufacturer's user guide included in your Warranty Packet for detailed operating instructions, or visit the manufacturer's website.

### Raising the antenna

To raise the TV antenna to the operating position turn the antenna elevating crank clockwise in the UP direction (approximately 13 turns) until some resistance to turning is noted (Fig. 9.2).

On amplified models, 12-volt DC power is required. Turn power supply ON to use either front or rear TV outlet. Neither outlet will work unless power supply switch is ON. **DO NOT** connect high current devices such as hair dryers to this receptacle. Maximum current rating of this receptacle is 8 amps at +12 VDC.

After the antenna is in the full UP position, pull down on the round knob with both hands until it disengages from the ceiling plate. Rotate the knob for best picture (Fig. 9.3).

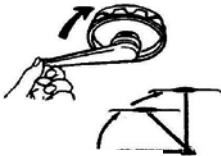

**Fig. 11.2**



**Fig. 11.3**

### To Test

1. Make sure the television set is working properly.
2. Switch the power supply ON and OFF to see if there is a difference in the picture quality while watching TV. If there is no difference, refer to manufacturer's manual for further testing procedures.



### CAUTION

The TV power supply should be turned OFF when connecting/disconnecting the cables to the power supply and antenna, but should be turned ON when testing for voltage.

Rotate the antenna until the pointer on the directional handle aligns with the pointer on the ceiling plate. Turn the elevating crank counterclockwise in the DOWN direction (approximately 13 turns) until resistance is noted. The antenna is now locked in the travel position.

**CAUTION**

Make sure the television antenna is in the travel position (cranked down) before moving the motor home. Failure to lower the antenna into the travel position before traveling may damage the antenna.

**DO'S**

1. Check parking location for obstructions before raising antenna.
2. Carefully raise, lower and rotate. If this is difficult, check for cause.
3. Rotate slowly when selecting station and check fine tuning on TV set to make sure it is properly adjusted.
4. Lower antenna before moving vehicle.

**DONT'S**

1. Don't force elevating crank up or down.
2. Don't rotate directional handle hard against stops.
3. Don't travel with lift in up position.
4. Don't leave lift part way up or down.
5. Don't apply sealing compound or paint over top of base plate or anywhere on lift.

**Lubricating the antenna**

The elevating gear should be lubricated 3-4 times a year with silicone spray.

Two times yearly or in the event rotating the antenna becomes difficult, normal operation can be restored by lubricating the bearing surface between the rotating gear housing and the base plate. Any **silicone lubricant spray** may be used.

Lubricate rubber quad ring on elevating shaft which is below worm gear with silicone spray lubricant at least twice yearly. This will keep quad ring from becoming brittle which could result in leaks down elevating shaft.

Refer to the manufacturer's user guide for detailed information on lubricating the antenna.

**EXTERIOR TELEVISION (IF SO EQUIPPED)**

The exterior television is located on the curbside of the unit. You can access the television by opening the exterior cargo door to the stationary open position.

Refer to the individual component manufacturer's information (located in the Warranty Packet) for detailed operating instructions.

## CLEANING THE INTERIOR

To keep the value of your motor home, perform regular maintenance using the proper materials and procedures. Using the wrong cleaner may result in damage to the surfaces in your motor home. Check with the manufacturer's information for the recommended cleaning agent. If in doubt, check to see if the cleaner will cause damage by testing a small area out of sight or contact your independent Jayco dealer for assistance. Do not use flammable liquids or sprays to clean the motor home.

## HIDE-A-BED (IF SO EQUIPPED)

The hide-a-bed sofa functions much the same as a regular residential hide-a-bed sofa. To make the hide-a-bed sofa into a bed, remove the seat cushions and pull the strap located at the front of the sofa seat bottom out towards you firmly and gently.

To convert the hide-a-bed back into the upright sofa position, reverse the process (make sure to pull the seat belts out into their usable positions). Be sure to hold the sofa strap firmly to ensure the hide-a-bed sofa does not suddenly drop shut. Refer to the furniture manufacturer's care instructions for this product.



### WARNING

Always use seatbelts if sitting in the hide-a-bed while the motor home is in transit

## J-STEEL SOFA (IF SO EQUIPPED)

The J-steel sofa functions much the same as a residential futon. To make the J-steel sofa in to a bed, lift up on the bottom seat cushion and pull it towards you.

The sofa back will drop down to provide a sleeping surface. For additional comfort and to reduce fabric damage, you may want to place a cover or air mattress (customer supplied) over the J-steel sofa when it is in the sleeping position.



### WARNING

Always use seatbelts if sitting in the sofa while the motorhome is in transit.

## BOOTH DINETTE (IF SO EQUIPPED)

The dinette is designed to seat up to four adults. You can access the dinette bench storage by removing all the cushions and lifting the bottom seat supports. If the dinette bottom seat support is screwed shut, it is to protect factory-installed equipment (do not use that area for storage). To convert back to a booth dinette, reverse the process.

The booth dinette can be converted into a bed. To convert, remove all the cushions from the booth dinette. Lift the tabletop, remove the detachable table legs and place the tabletop on the ledges provided between the booth dinette benches.

Lay the seat back cushions against the back of the booth dinette bench. Lay the dinette seat bottom cushions in between the seat back cushions. The area where the cushions meet should be slightly raised.

Push the raised cushion ends down gently. The cushions are designed to fit snugly. Reverse this process when converting back to the booth dinette.

### **FREE STANDING TABLE AND CHAIRS (IF SO EQUIPPED)**

Two free standing chairs and two folding chairs are included in the Free Standing Table/Chair Package (if so equipped). When traveling in the motor home, it is recommended the free standing dinette chairs be fastened securely at the dinette table, and the folding chairs be secured.

### **FURNITURE UPHOLSTERY**

To retain the value of your motor home, maintain the furniture upholstery carefully and keep the interior clean. Vacuum the furniture regularly using a soft brush attachment to remove any loose dirt or debris.

#### **Fabric (if so equipped)**

It is recommended the fabric be professionally cleaned if it becomes stained or soiled. The professional cleaner should be made aware the fabrics have been treated to be fire resistant. For more information, refer to the specific furniture manufacturer's care instructions.

#### **Ultraleather™ (if so equipped)**

It is recommended the Ultraleather™ be professionally cleaned if it becomes stained or soiled. For more information, refer to the specific furniture manufacturer's care instructions.

#### **Leather (if so equipped)**

Periodic vacuuming, using a dry cloth to wipe up spills immediately, and using a damp cloth on problem areas, will help to keep your leather furniture in good condition. Leather surfaces can vary as do the cleaning methods. Refer to the furniture manufacturer's recommendation, or consult a cleaning professional.

It is recommended you do not use any cleaners containing oils, waxes or silicones. Cleaners containing silicone can eventually destroy the finish on the leather. Cleaners containing oils or waxes leave residues on the surface of the leather which can attract more dirt which can eventually lead to cracking.

### **BED STORAGE**

Additional storage has been provided under the bed. It is equipped with gas struts to assist with easy access. To access the storage area, grasp the end ledge at the foot of the bed and lift carefully. To close, carefully push down on the bed slowly easing it to the closed position.



#### **CAUTION**

Before lifting, be sure there is nothing on the bed that will restrict its movement or add extra weight. Use caution when opening or closing the bed to keep hands and fingers at the end ledge provided (not on the side or further back than necessary) to avoid pinch points.

The bedroom electric slide room system may be located under the bed. If so, it can be accessed by removing the screws holding the wooden paneling in place. Use care not to obstruct the slide room system when using the under bed storage area.

---

## PRIVACY DRAPE INSTALLATION

---

Remove the privacy drape from the storage bag, which you should find in the storage area under the mattress platform in the bedroom.

Starting at the driver's side of the cab, attach the black plastic hook to the loop attached to the wall behind the driver's seat. Make sure that the side of the drape with Velcro® is facing the motorhome windshield.

1. Pull the drape toward the front of the motor home and behind the driver's side sun visor. Open the sun visor against the windshield to hold the drape in place.
2. Proceed across the windshield to the passenger side, again placing the drape behind the sun visor and opening the sun visor to hold the drape in place.
3. Attach the black plastic hook at the passenger's side of the cab to the loop attached to the wall behind the passenger's seat.
4. Attach the Velcro® at the top edge of the drape above the driver's and passenger's doors to the corresponding Velcro on the roof of the motorhome cab.
5. The Velcro® at the bottom corners of the privacy drape under the black plastic hooks should also be attached to the Velcro on the walls of the motorhome in the corresponding locations.

---

## DÉCOR ITEMS

---

Décor items such as window treatments, day/night pleated shades, mini blinds and décor glass should be cared for as follows:

### **Window treatments and curtains**

Dust occasionally with a vacuum and soft brush attachment. Due to fire retardant chemicals, they should be professionally cleaned only.

### **Décor Glass (if so equipped)**

Use a glass cleaner to remove smudges, smears and spots. If there is any decorative etching on the décor glass, use care when cleaning around that area.

---

## PANTRY (IF SO EQUIPPED)

---

Depending on the kitchen layout of your RV, you may have a pantry that you can use to store items you wish to take with you as you travel and camp. Ensure items stored in the pantry are secured so they do not shift during travel.

The cabinetry has been designed to accommodate the normal camping items (i.e., paper plates, flatware, cookware, etc.) which are bulky but not necessarily heavy.

**Remember your RV's load capacity is designed by weight, not volume, so you cannot necessarily use all available space.**

---

## CABINETRY & TABLES

---

To keep hardwood doors, cabinet fronts and hardwood tables looking like new regularly dust with a soft cloth dampened with a cleaning polish or mild detergent solution. Avoid using ammonia based products or silicone oils as they may cause damage if used over a long period of time.

The finish is durable and resistant to most household spills. However, spills should be wiped up promptly to avoid potential problems. Excessive prolonged exposure to direct sunlight, high temperatures and high humidity can cause damage to both the finish and the wood itself. These should be avoided.

---

**COUNTERTOPS**

---

Glass rings, food spills, water spots and smudges usually wipe off with a damp sponge. Stubborn stains can be removed with a general-purpose spray cleaner. Some stains can be removed by squeezing fresh lemon juice over the stain and allowing the juice to soak for approximately forty-five minutes. After 45 minutes, sprinkle baking soda over the lemon juice and rub with a soft cloth.

**To prevent permanent damage**

- Always use hot pads or trivets under hot pans, dishes, or heat producing appliances such as frying pans.
- Always use a cutting board; never use a knife on the countertop.
- Avoid harsh chemicals such as drain cleaners, oven cleaners, etc.
- Do not let cleaners with bleach set on the top. Wipe them off promptly.

---

**INTERIOR WALL PANEL**

---

Please contact your dealership service department for assistance in repairing décor paneling. If deep scratches occur on the wall panel, putty sticks can be used to cover scratches on wood surfaces. These can be obtained from local hardwood stores and lumberyards.

---

**FLOORING**

---

Always test a cleaning agent in an inconspicuous area for colorfastness.

**Carpet**

Vacuum your carpet regularly. It is important to remove loose soil and debris while it is on the surface.

Heavily traveled areas (i.e., walkways, areas in front of the furniture) may be protected with small throw rugs to prolong the life of the carpet.

Prompt attention to spots and spills is essential. Remove as much of the spill as possible. Absorb wet spills as quickly as possible by blotting repeatedly with white paper or cloth towels.

Refer to the manufacturer's guide included in your Warranty Packet for detailed cleaning information, or contact a cleaning professional.

**Vinyl flooring**

Periodically vacuum or sweep to remove dirt and gritty particles. Although most common spills will not permanently stain the vinyl floors, they are usually easier to remove if wiped up before they set. Simply blot with a paper towel and wipe clean with a damp cloth. Do not use dish detergents or vinegar and water because they will dull your floor.

To care for the vinyl floor covering, use a damp mop with water and a mild cleaner on the entire floor. **DO NOT SOAK THE FLOORING.** Use care to avoid wetting the carpet edges. To avoid problems of "yellowing" linoleum, the flooring manufacturer recommends avoiding cleaners that contain oil based solvents (i.e. cleaners containing lemon oil, Murphy's Oil Soap, etc.).

---

**ABS PLASTICS**

---

Dust and wipe clean with soft, damp cloth or chamois, wiping gently. Do not use gritty or abrasive particle soaps or scouring compound to clean ABS plastic. Avoid using "Citrus" or biodegradable cleaners which contain "D-Limonene" as they may damage plastic materials.

## PATIO AWNING



### WARNING

Awnings must be closed (and locked if applicable) while the RV is in transit.



### WARNING

If weather conditions are windy or stormy, close the awning(s) into the travel mode position.

Refer to the manufacturer's user guide included in your Warranty Packet for operating and safety information.

### Awning care

It is a good idea to keep the awnings in the closed position if you will be away from the motor home for an extended period of time. Keep your awnings clean and in good condition to prevent costly repairs.

- Periodically check that the fasteners are tight. Tighten if necessary.
- Keep the awning fabric clean. For detailed cleaning information, refer to the manufacturer's owner information included in the Owner's Portfolio.

## ROOF LADDER (IF SO EQUIPPED)

Your motor home is equipped with a rear ladder, to allow access to the roof.



### WARNING

The ladder weight capacity should not be exceeded (see ladder capacity label). There should never be more than one person on the ladder at the same time.

## CLEANING THE EXTERIOR

To protect your motor home's exterior finish, wash it often and thoroughly.

Your RV is exposed to many environmental conditions that have an adverse affect on the paint finish:

- Road Salt and Sodium Chloride
- Road Tar / Bugs
- Bird Droppings / Tree Sap
- Industrial Fallout / Acid Rain /Pollution
- UV Exposure and Moisture

The most common problems resulting from these conditions are corrosion, staining, and chemical spotting. Generally, the longer the foreign material remains in contact with the exterior finish, the more extensive the damage. These problems can be minimized by regularly scheduled washing and polishing. Wash your motor home as soon as possible if it becomes contaminated with foreign material.

Avoid parking under trees or near ocean sea salt. Ice or snow should not be scraped from the painted surface: Brush off! Bugs and bird droppings should be rinsed off daily.

Gravel roads should be avoided. Anti-freeze, gasoline or washer solvents if spilled on the painted surface should be rinsed off with water immediately.

### Washing

Commercial washing should be avoided. Wash with cold water using a mild liquid soap. Dry wiping with a dry cloth is not recommended.

Make sure the RV's surface temperature is cool, under 90 F, and out of direct sunlight. A shaded area is ideal for washing your vehicle as direct sunlight causes water spotting. Use a mild soap or detergent. Most auto care stores will carry a car wash shampoo.

Try to avoid combination wash-n-wax products as these waxes can cause build up and are designed for smaller surfaces. Have two dedicated sponges or wash mitts: one for the exterior walls and one for the wheels and under- carriage.

Brushes or wash mitts that are made of plastic bristles are acceptable for use on tires and wheel wells, but are not intended for use on the exterior walls. Avoid using such items on painted surfaces as they will damage the finish. Wash the wheels and wheel wells first as this removes heavy dirt and debris and prevents it from splattering on panels. Wet the entire area down to remove loose dirt and grime, then hand wash one area at a time using your dedicated paint finish sponge or wash mitt. Wash from the top and work your way down, rinsing frequently to minimize grit abrasion. Follow with a final rinse of water. This process will remove most contamination from the motor home's surface. For stubborn stains such as road tar or bug stains, use an ammonia based glass cleaner or a small amount of rubbing alcohol on a damp cloth followed immediately by warm soapy water, and rinsing with clean water. This may not dissolve the road tar, but it will loosen tar and bug stains and remove them from the surface. Do not use solvent based cleaners on bird droppings or tree sap as these are water based stains. They can be dissolved using ammonia based glass cleaner, warm soapy water and a little "elbow grease". Once again, after removing stubborn stains immediately rinse with clean water. Drying the motor home is just as important as washing your vehicle. Tap and well water contain many chemicals that could water stain your RV's finish.

We suggest using a damp natural or synthetic chamois. There are other drying products such as lint-free micro-fiber towels that work just as well.

### During cold weather

Salt and other chemicals that are spread on winter roads in some geographical areas can have a detrimental effect on the motor home's underbody. **If your motor home is exposed to these conditions, spray the underbody with a high-pressure hose every time you wash the exterior of your motor home.**

Take special care to remove mud or other debris that could trap and hold salt or moisture. After washing your motor home, wipe off all water drops from the rubber parts around the slideout and doors.

⊠ **NOTE:** When the slideout or door is frozen, opening it by force may tear off or crack the rubber gasket that is installed around the slideout or door. Therefore, pour warm water on the gasket to melt the ice (wipe off the water thoroughly after opening the slideout or door). To prevent the weather stripping from freezing, treat it with a silicone spray.

### Waxing

Wax your motor home once or twice a year, or when painted surfaces do not shed water well. Use a soft cloth to apply a small amount of wax to the painted surfaces.



After the wax has dried, polish the motor home with a dry, soft cloth. Do not wax your motor home in direct sunlight. Wax it after the surfaces have cooled. Do not apply wax to any area having a flat black finish as it can cause discoloration. If the finish has been stained with wax, wipe off the area with a soft cloth and warm water. When waxing the area around the various openings, do not apply any wax on the weatherstrip. If it is stained with wax, the weatherstrip cannot maintain a weatherproof seal around the opening.

**CAUTION**

Do not use waxes containing high-abrasive compounds. Such waxes remove rust and stains effectively from the paint work, but they are also harmful to the luster of the painted surface since they scrape off the coating. Further, they are detrimental to glossy surfaces, such as the grille, garnish, moldings, etc. do not use gasoline or paint thinners to remove road tar or other contamination to the painted surface.

**Polishing your motor home****CAUTION**

Do not use a buffer and a buffing compound as it may damage the exterior surface. Please contact a professional paint body shop for assistance.

If painted surfaces have been severely damaged and have lost their original luster and color tone, polish the surface lightly with a fine polishing compound. Avoid limiting your polishing to the damaged surface only; polish a somewhat wider area, moving the polishing cloth in one direction. After polishing, flush the compound from the surface and apply a coat of wax to regain a beautiful luster.

**Damaged paint**

To prevent corrosion, touch up small cracks and scratches in the paint coat as soon as possible with touch-up film or paint. Carefully check the body areas facing the road and the tires for damage to the paint coat caused by flying stones, etc. To purchase touch-up paint, use the closest automotive paint (available locally) match possible.

**Cleaning plastic parts**

Use a sponge or chamois to clean plastic parts. Use warm water and a soft cloth or chamois to remove any white residue from dark colored plastic surfaces. Do not use a scrubbing brush, other hard tools, or wax containing abrasives as they may damage the plastic surface.

**CAUTION**

Do not allow plastic to come into contact with brake fluid, engine oil, grease, paint thinner, or battery acid. These will damage plastic. Use a soft cloth and a mild detergent solution to wipe away any such contact.

**Chrome parts**

To prevent chrome parts from spotting or corroding, wash with water, dry thoroughly, and apply a non-abrasive automotive wax.

If the chrome is severely damaged or pitted, use a commercially available chrome polish product.

---

**WINDOWS**

---

Any ventilating window may permit water inside, especially during heavy rainstorms. Condensation will also cause water to accumulate on windows and in the tracks. The window “glass” can normally be cleaned with a sponge and water. Use glass cleaner to remove wax, oil, grease, dead insects, etc. After washing the glass, wipe it dry with a clean, soft cloth.

---

**CHASSIS MAINTENANCE**

---

Refer to your Chassis Guide for detailed safety and maintenance instructions.

---

**FRAME**

---

Sand, pebbles, objects on the highway, climate (salt air exposure) or ice inhibiting chemicals used during the winter months will damage the paint, inviting rust and other deterioration. Periodically inspect the exterior exposed areas, clean and repaint the frame members occasionally and whenever you notice rust or paint chipped away, to insure protection.

---

**EXTERIOR ROOF & SIDEWALL VENTS**

---

While you are cleaning the exterior roof, also inspect the roof vents (including sealants) for cracks and keep them clean. Inspect the refrigerator and holding tank vents for blockages from bird nests, spider webs, leaves, etc.

Water heater, furnace and refrigerator exterior doors need to be kept clean and free of obstructions (i.e., insect nests, mud daubers, etc.) while the appliances (if so equipped) are in use.

---

**SEALANTS**

---

Sealants perform a very important function and should be inspected closely and regularly maintained. We incorporate many different types of sealants, including butyl/putty, black butyl-encapsulated foam, silicone (clear and colored), roof sealant and foam. In general, sealants do not have “set” lifetimes. Varying environmental factors affect the pliability and adhesiveness of sealants. You or your dealer must:

- Inspect all sealants, a minimum of every six months. A quick walk around the motor home before leaving may help prevent potential problems during trips and vacations.
- Have the sealant replaced if you notice any cracks, voids, gaps, breaks, looseness or any sign of physical deterioration.
- Always use the same type of sealant that was removed. Your dealer service or parts manager can help you obtain the correct sealant(s).

The sealants may become damaged due to ultraviolet exposure, air pollution, freezing temperatures and exposure to other elements. If deteriorated, repair immediately to prevent damage.

Cap seal all trim and openings at least once after the first year and thereafter as cracks, peeling, lifting and shrinkage occur. Conditions such as rain, salt, dust and pollution may increase your vehicle maintenance needs.

**RV START-UP**

---

The following checklist will help ensure a trouble-free camping season:

- Inspect and work all interior and exterior latches and locks (lube if necessary).
- Make sure the batteries are fully charged and installed correctly.
- Turn ON the motorhome 12-volt battery disconnect switch.
- Inspect the power cord and carefully clean the contacts if necessary. Plug in the power cord to an appropriate power source.
- Turn on the interior lights and check outlets for polarity. If needed, replace any blown fuses. Check the circuit breakers and test the GFCI.
- Inspect and test all safety detectors. If needed, replace any drained or discharged batteries. If you have a defective or damaged safety detector, replace it immediately.
- Inspect and turn on the propane system. If you have any questions, contact your dealer or a qualified propane service representative for assistance.
- If the propane system is functioning properly, test the pilot lights on range, refrigerator, furnace and water heater (if so equipped).
- Inspect the leveling jacks (if so equipped) for operation. If needed, perform maintenance as specified by the leveling jack manufacturer.
- Test all exterior and interior lights. Replace any bulbs if they are burnt out.
- Prepare the chassis portion of the motorhome for the camping season in accordance with the Chassis Guide.
- Inspect the tires for wear, cracks and inflation pressure.
- Wash the exterior of the motorhome. Do a sealant inspection and repair as necessary.
- De-winterize and sanitize the fresh water system.
- Connect a towed vehicle to motorhome (if applicable) and test all connections and lights.

**READY TO LEAVE CHECKLIST**

---

Before leaving or returning home, it is critical that you complete the necessary procedures to ensure a safe trip. As you develop a routine, it is possible that a checklist will be helpful. This is a general list, which you may want to customize as you determine your own needs.

- Make sure you follow all safety precautions noted in this owner's manual and in any manufacturer's operators manual when preparing to travel.
- Check the area under the RV after overnight parking and look for water or other fluid leaks. If leaks are detected, find the cause and correct it immediately.
- Make sure all fluids are at proper levels. Check the engine oil, transmission fluid, engine coolant, power steering fluid and wind shield washer fluid.
- Check the fuel gauge and lights on the motor home. Have someone observe the operation of all exterior lights while you activate the controls. Check the turn signal and high beam indicators on the instrument panel.
- Examine the tires for excessive tread wear or uneven wear patterns. Check for stones, nails, glass or other objects lodged in the tread. Inspect for tread cuts or sidewall cracks.
- Check wheel lug nuts for tightness and tires for proper air inflation pressure.

## **SECTION 14 – TRAVEL/CAMPING/STORAGE CHECKLISTS CLASS C MOTORHOME**

- Check the propane cylinder gauge to make sure there is propane available.
- Make sure the propane cylinder is in place and secure for transport.

### **Interior**

- Close roof vents
- Close windows & latch blinds
- Counter items put away or tied down
- Furnace turned off
- Latch drawers, cabinets & doors
- Turn off the interior lights and appliances.
- Disconnect any cable TV or phone hookups and lower the TV antenna (if so equipped).
- Move slideout in and lock it in place (if so equipped)
- Fasten and secure the furniture for travel (if so equipped)
- Refrigerator door locked
- Set refrigerator to 12-volt (if so equipped)
- Water heater turned off (if so equipped)
- Water pump turned off

### **Exterior**

- Empty black holding tank, rinse as needed
- Empty gray holding tank
- Pack equipment into compartments and secure it
- Lock all exterior compartments
- Propane turned off
- Retract awning and secure them for transport.
- Retract step
- Retract leveling jacks to the travel position (if so equipped)
- Water hose & electric cord unhooked and stored
- Check tire pressure (include inner wheel and spare, if applicable)
- Check wheel lugs
- Test brakes for proper operation
- Secure any loose, heavy or sharp objects in the RV or exterior compartments.
- Disconnect the shore line power cord and ensure it is stored correctly.
- Fasten all interior and exterior doors securely. Lock them (if applicable).
- Walk around your RV one last time to make sure everything is stored away and the baggage compartments are closed and locked.
- Secure and lock the entrance door

## **MOTOR HOME STORAGE**

Properly preparing your motor home for storage during periods of non-usage will prevent problems from arising. It will also make it easier to get started again for the following camping trip or season.

To prevent costly freeze-ups, winterize the plumbing system when it will not be in use for an extended period of time, especially if it is stored in colder climates.

Periodically inspect your motor home during storage, and seal off any area that can offer an entry point for rodents, birds or insects. Also inspect the motor home for any damage.

**Damage from birds, rodents, insects, etc., is not covered under the “Motorized Transferable Limited Warranty” applicable to your motor home.**

- Disconnect the batteries to prevent battery discharge.
- Turn OFF the motor home 12-volt battery disconnect switch
- Turn OFF the inverter mode at remote
- Check your roof and other surfaces to ensure there is no damage and potential leakage that might otherwise go unnoticed until it is too late.
- Close all windows and roof vents.
- Cover all external outlets, such as furnace, exhaust, etc. to prevent mice or other rodents from entering.
- Drain all water lines.
- Cover all external outlets, such as furnace, exhaust, etc. to prevent mice or other rodents from entering.
- Cover the roof air conditioner.
- Do not use the stabilizing jacks during storage (if so equipped).
- Drain all water lines.
- Drain and flush all holding tanks (fresh water, gray water, black water and/or hot water tanks).
- Prepare the chassis for storage in accordance to the Chassis Guide. Remember to use fuel additives and supplements if so recommended.
- Wash and wax the exterior of the vehicle. Do a sealant inspection and repair as necessary.
- Adding fuel stabilizer to the generator will aid in preventing condensation and fuel varnishing.
- Inspect and clean tires. Check for wear, cracks and inflation pressure.
- To prevent weather checking and other UV damage, cover tires that are exposed to sunlight.
- Turn all cushions on edge to prevent the moisture/mildew buildup during storage.
- Close the propane cylinder valve(s).
- Inspect under the motor home for any openings into the floor where animals or insects may enter and seal if necessary.
- Turn the furnace thermostat(s) to the OFF position.
- If your motor home is equipped with a gas/electric DSI range, light a range gas burner to consume any gas remaining in the lines. Once the flame extinguishes itself, turn the burner valve OFF.
- You may want to place rodent control products in the vehicle during storage. Rodents can do damage to the interior components, particularly during the winter months.
- Remove all perishables from the refrigerator/freezer. Defrost, wash and dry the interior of the refrigerator/freezer and prop (or block) the doors open so air can circulate and prevent mildew or use crumpled newspaper or open boxes of baking soda in the refrigerator to eliminate odors during storage
- Remove all perishables from the cabinets. Leave the cabinets and doors ajar to allow air circulation and prevent mildew and musty odors.
- Lubricate locks and hinges on exterior doors.

**While the motor home is being stored**

If the vehicle is stored outside in areas of heavy snow, you should periodically brush the snow off to prevent excessive accumulation and prevent possible roof damage.



**CAUTION**

Excessive snow, 8" or more, or ice, 2" or more, places excessive weight on the RV roof. Remove excessive snow or ice as needed. Care **MUST** be exercised to not damage the roof material when removing snow & ice. Excessive weight can damage the roof, seals, etc. Water leaks and poor fit or operation are the results of this damage.

**MAINTENANCE CHECKLIST**

This list is a quick reference sheet for suggested areas of regular maintenance. Review all manufacturer's operators manuals supplied with your RV to perform these listed maintenance items.

**Prior to First Trip**

- Inspect and reseal as needed.
- Have the propane system checked for leaks by your dealer.
- Check wheel lug nuts at specified intervals to listed torque specifications, re-torque as needed.
- Sanitize the fresh water system.
- Test the safety alarms.

**First Two-Hundred Miles**

- Check wheel nuts at specified intervals to listed torque values. Re-torque as needed.
- Have brakes adjusted by a qualified service technician.

**Each Trip**

- Inspect and reseal as needed.
- Check the auxiliary battery (If so equipped).
- Have the propane system checked for leaks by your dealer.
- Check running lights.
- Check tire pressure and wear, including spare (if so equipped). Make sure the tires are cold when checking the tire pressure.
- Flush out water heater tank.
- Inspect safety chains for signs of wear (if so equipped).
- Test brakes.
- Test safety alarms.

### FEATURED COMPONENTS QUICK REFERENCE CHART

Your motor home may be equipped with some of the items listed below. This is a partial listing and it is not intended to cover all components in your motor home. All information is the latest available at the time of publication. Entegra Coach reserves the right to change any of the following information without notice.

COMPONENT	MANUFACTURER	WEBSITE	PHONE NO.
AIR CONDITIONER	RV PRODUCTS	www.rvcomfort.com	(316) 832-4357
AWNING	CAREFREE OF COLORADO	www.carefreeofcolorado.com	(800) 622-3230
BACKUP CAMERA AND MONITOR	ASA AUDIOVOX	www.asaelectronics.com	(877) 845-8750
CONVERTER	PROGRESSIVE DYNAMICS	www.progressivedyn.com	(269) 781-4241
ENTRY STEP	POWER GEAR	info@powergearus.com	(574) 256-6743
FAN,CEILING 12V	FAN-TASTIC VENT	www.fantasticvent.com	(800) 521-0298
FAN, EXHAUST 12V	VENTLINE	www.ventline.com	(574) 848-4491
FIRE EXTINGUISHER	CONTACT YOUR DEALER		
FURNACE	ATWOOD/ HYDROFLAME	www.atwoodmobile.com	(800) 546-8759
HITCH	CEQUENT TOWING	www.cequentgroup.com	
INVERTER	XANTREX TECHNOLOGY INC	www.xantrex.com	(800) 670-0707
LADDER,ROOF	CHRISTIANSON IND,		(269) 663-8502
LOAD CENTER	PROGRESSIVE DYNAMICS	www.progressivedyn.com	(269) 781-4241
MONITOR PANEL	KIB ENTERPRISES	www.kibenterprises.com	(800) 250-7051
OUTSIDE SHOWER	B & B MOLDERS	www.bandbmolders.com	(574) 259-7838
PROPANE TANK	MANCHESTER TANK	www.mantank.com	(800) 877-8265
PROPANE/CARBON MONOXIDE ALARM	CONTACT YOUR DEALER		
RADIO	CONTACT YOUR DEALER		
RANGEHOOD	VENTLINE INC.	www.ventline.co,	(574) 848-4491
REFRIGERATOR,	NORCOLD	www.norcold.com	(800) 543-1219
SATELLITE DISH	WINEGARD	www.winegard.com	(800) 788-4417
SLIDEOUT SYSTEM	POWER GEAR	www.powergearus.com	(800) 334-4712
SMOKE ALARM	CONTACT YOUR DEALER		
SOLENOID, AUX. START (CHASSIS)	CONTACT YOUR DEALER		
SOLENOID, BATTERY DISCONNECT	KIB ENTERPRISES	www.kibenterprises.com	(800) 250-7051
TANK SPRAYER/BLK	B & B MOLDERS	www.bandbmolders.com	(574) 259-7838
THERMOSTAT	RV PRODUCTS	www.rvcomfort.com/rvp	(316) 832-4357
TOILET	THETFORD CORP	www.thetford.com	(800) 521-3032
TV	CONTACT YOUR DEALER		
TV ANTENNA	WINEGARD	www.winegard.com	(800) 788-4417
WATER HEATER, TANK DSI	ATWOOD	www.atwoodmobile.com	(800) 546-8759
WATER HEATER, TANKLESS	GIRARD SYSTEMS	www.girardsystems.com	(800) 382-8442
WATER PUMP, 12V	SHURFLO EAST	www.shurflo.com	(800) 854-3218

**THIS PAGE IS INTENTIONALLY BLANK**

---



**Jayco  
Ownership Notification**

**Fax Form To: (800) 825-7876**

**ATTENTION!**  
Federal record keeping laws require that we maintain a file of owners of our product. Your cooperation in filling out this form will be appreciated.

Change of Owner

Transfer of Limited Warranty  
(see limited warranty for details)

**Model Information:**

Serial#: \_\_\_\_\_

Chassis #: \_\_\_\_\_ Odometer Reading \_\_\_\_\_  
(Motorized only)

**New Owner Information:**

Purchased Date: \_\_\_\_\_

Name: \_\_\_\_\_

Address: \_\_\_\_\_

City: \_\_\_\_\_ State/Province: \_\_\_\_\_ Zip Code \_\_\_\_\_

Phone # \_\_\_\_\_ E-Mail Address \_\_\_\_\_

**Previous Owner Information:**

Purchased Date: \_\_\_\_\_

Name: \_\_\_\_\_

Address: \_\_\_\_\_

City: \_\_\_\_\_ State/Province: \_\_\_\_\_ Zip Code \_\_\_\_\_

Phone # \_\_\_\_\_ E-Mail Address \_\_\_\_\_