

Installation Manual

Enphase Engage Cable and Accessories



Contact Information

Enphase Energy Inc.
201 1st Street
Petaluma, CA 94952
Phone: 707-763-4784 Toll Free: 877-797-4743
Fax: 707-763-0784

<http://www.enphase.com>

info@enphaseenergy.com

Other Information

Product information is subject to change without notice. All trademarks are recognized as the property of their respective owners.

Copyright © 2011 Enphase Energy. All rights reserved.



Table of Contents





Important Safety Information	5
Read this First	5
Safety Instructions	5
For Your Safety	5
Electrical Installation	5
The Enphase Engage Cable and Accessories	7
Compatibility	7
Parts and Tools Required.....	7
Lightning Surge Protection	7
Selecting Cable Type	8
Connector Spacing Options.....	8
Voltage Types and Conductor Count	9
Racking Compatibility	9
Cabling Length Options	9
Planning for Cable Lengths and Type	10
Enphase Engage Cable and Accessories Installation	11
Installation Procedure	12
Step 1 – Measure AC at Service Entrance Conductors	12
Step 2 – Install the AC Branch Circuit Junction Box	13
Step 3 – Position the Enphase Engage Cable.....	14
Step 4 – Attach the Microinverters to the Racking	14
Step 5 – Dress the Engage Cable	15
Step 6 – Terminate the Unused End of the Engage Cable	17
Attaching the Terminator	17
Replacing or Removing the Terminator	19
Step 7 – Connect the Engage Cable to Junction Box(es).....	19
Step 8 – Verification and Commissioning.....	21
Disconnecting a Microinverter from the Engage Cable	22
Technical Data.....	23
Appendix – Sample Wiring Diagrams	25
Sample Wiring Diagram – 240 Vac	25
Sample Wiring Diagram – 208 Vac	26



Important Safety Information

Read this First

To reduce the risk of electrical shock, and to ensure the safe installation and operation of the Enphase System, the following safety indications appear throughout this document.





-  **DANGER** Indicates a hazardous situation, which if not avoided, **will** result in death or serious injury.
-  **WARNING** Indicates a hazardous situation, which if not avoided, **could** result in death or serious injury.
-  **CAUTION** Indicates a hazardous situation which, if not avoided, **could** result in minor or moderate injury.
-  **NOTICE** Follow instructions closely to avoid damage or malfunction to the device and/or damage to surrounding property.

Safety Instructions

For Your Safety

-  **DANGER** **Risk of Electrical Shock.** Do NOT connect or disconnect the photovoltaic module from the Enphase Microinverter without first removing AC power from the photovoltaic system.

Electrical Installation

-  **WARNING** Be aware that only trained solar professionals should install and/or replace the Enphase Cabling System or connect the Enphase Microinverter to the electrical utility grid.
-  **WARNING** Perform all electrical installations in accordance with all local electrical codes and the National Electrical Code (NEC), ANSI/NFPA 70.
-  **WARNING** The AC connectors on the cabling are rated as a disconnect only when used with an Enphase Microinverter.
-  **WARNING** Connect the Enphase Microinverter to the electrical utility grid only after receiving prior approval from the utility company and any applicable AHJ (authority having jurisdiction).
-  **NOTICE** Before installing the cabling, read all instructions and cautionary markings in the user manual, on the Enphase equipment, and on the all other photovoltaic equipment.



The Enphase Engage Cable and Accessories

The Engage Cable is a continuous length of 2.5 mm² (12 AWG), outdoor rated cable with integrated connectors for microinverters. These connectors are preinstalled along the Engage Cable at intervals to accommodate PV module widths. The microinverters plug directly into the cable connectors.

Compatibility

The cabling is compatible with a variety of PV racking systems. For a list of approved PV racking systems, refer to the PV Racking Compatibility document on the Enphase website (<http://www.enphase.com/support/downloads>).

Parts and Tools Required

In addition to the Enphase microinverters, PV modules, PV racking, and associated hardware, you will need the following items.

Enphase equipment:

- Enphase Engage Cable. See Selecting Cable Type on page 8 for options.
- Watertight sealing caps, as needed (for any unused drops on the cable)
- Terminators, as needed (for AC branch circuit cable ends)
- Cable clips
- Enphase disconnect tool (number 2 Phillips screwdriver can be substituted)

Other items:

- Outdoor-rated, weather-proof AC junction box(es)
- Grounding conductor
- Torque wrench, sockets, wrenches for mounting hardware
- Adjustable wrench or open ended wrench (for terminators)

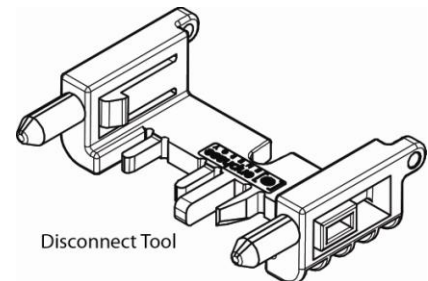

Lightning Surge Protection

Lightning protection and resulting voltage surge are protected in accordance with EN 62305-1. It is assumed that the PV modules are installed in accordance with related standards and that the microinverter is a part of a broader lightning mitigation system in accordance with EN 62305-1, -3.

In some areas, the statistical frequency of lightning strikes near a PV installation is high enough that lightning protection must be installed as part of an Enphase system. In some areas, a surge protection device might be mandatory following a risk analysis, according to NFC 15-100 (art. 443) & NFC 15-443L.

Selecting Cable Type

Enphase Engage Cable is available in two different voltage types and two connector spacing options. Depending upon installer needs, the cable is also available in different lengths.

The cable is installed by simply rolling out the desired length of cable and cutting it to size. One end is wired directly into the junction box at the head of the branch circuit, eliminating the need for a separate AC interconnect cable. The other end is sealed from the environment using an Enphase Branch Terminator. The microinverter AC cable connectors are then plugged into the regularly-spaced connectors as shown.

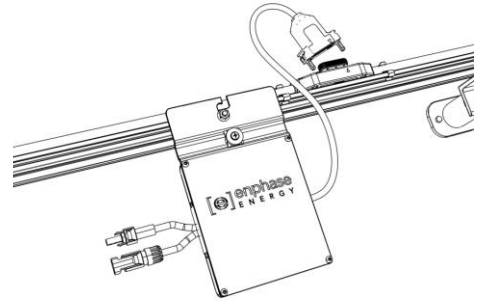

Connector Spacing Options

The gap between connectors on the cable can be either 1.025 meters (40") or 1.7 meters (67"). The 1.025 meter spacing is best suited for connecting PV modules installed in portrait orientation, while the 1.7 meter gap is best suited to PV modules installed in landscape orientation.

Cabling with connectors spaced at 1.025 meter (40") for PV modules in portrait orientation

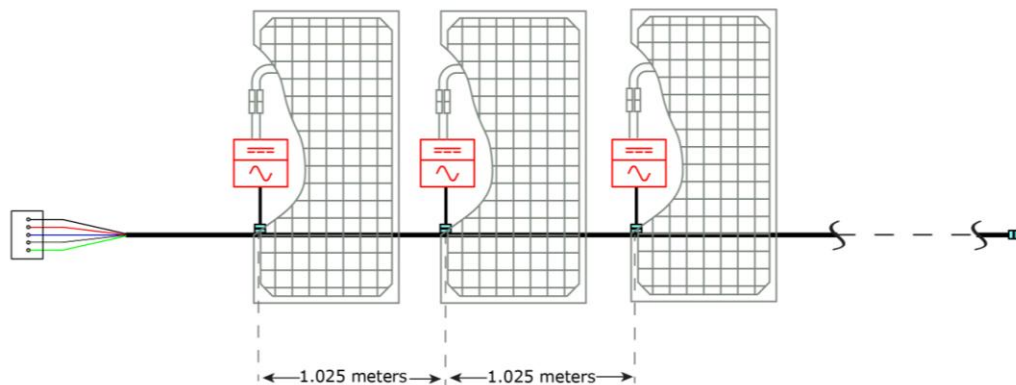

Cabling with connectors spaced at 1.7 meters (67") for PV modules in landscape orientation

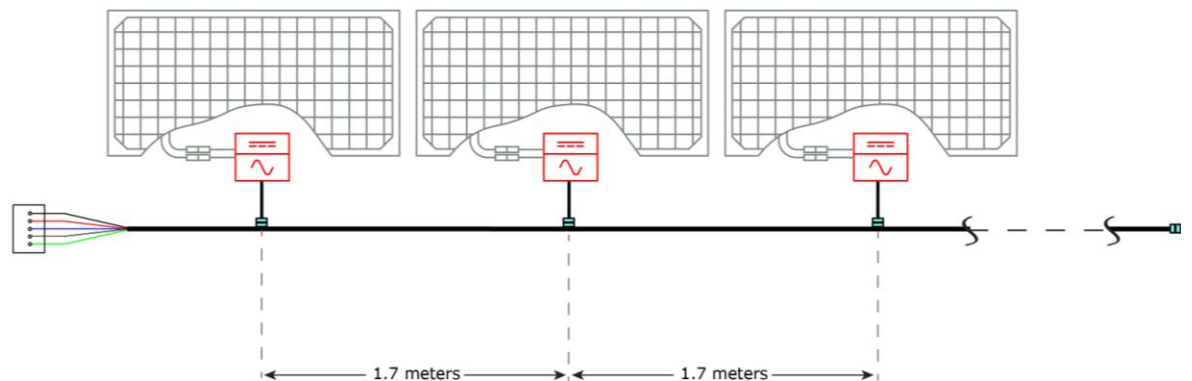

Voltage Types and Conductor Count

The voltage types are either 240VAC split phase or 208VAC three phase. **All cable connectors bear labels indicating their cable voltage designation.** Typically used for residential applications, 240VAC includes four conductors. This cabling should also be used for split phase 208VAC applications. Three-phase 208VAC cabling includes five conductors, and is used for most commercial installations. Because Enphase microinverters output onto two phases, three phase cabling balances the phases by rotating conductor use from one microinverter to the next as shown in the following diagram. In the diagram, the three phases are labeled 1, 2, and 3.

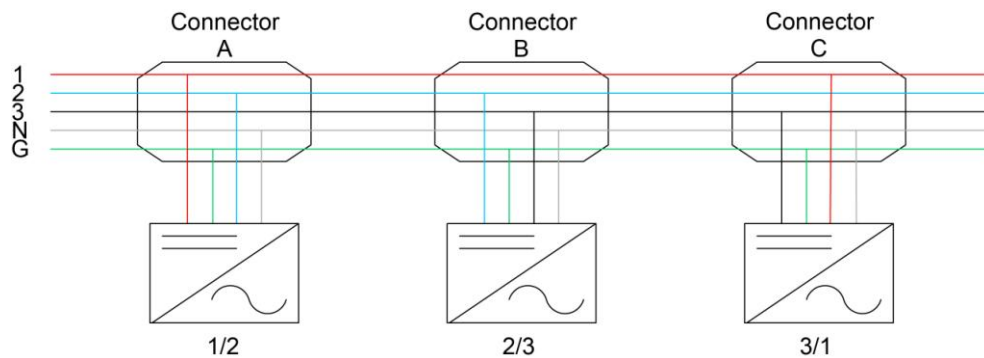

Racking Compatibility

Engage Cabling is compatible with a variety of racking systems. For a list of approved PV module racking types, refer to the Racking Compatibility document at (<http://www.enphase.com/support/downloads>).

Cabling Length Options

Engage Cabling is available in shorter lengths with 30-40 connectors, depending upon voltage type. Longer lengths can be ordered and cut to suit per order. Ordering options include:

Model Number	Voltage type/ conductor #	Connector count	Connector spacing	PV module orientation	Approx. weight
ET10-240-40	240VAC, 4 conductor	40	1.025 m (40")	Portrait	18.1 kg (40 lbs)
ET17-240-40	240VAC, 4 conductor	40	1.7 m (67")	Landscape	20.4 kg (45 lbs)
ET10-208-30	208VAC, 5 conductor	30	1.025 m (40")	Portrait	13.6 kg (30 lbs)
ET17-208-30	208VAC, 5 conductor	30	1.7 m (67")	Landscape	15.9 kg (35 lbs)
ET10-240-BULK	240VAC, 4 conductor	240	1.025 m (40")	Portrait	over 90 kg (200 lbs)
ET17-240-BULK	240VAC, 4 conductor	240	1.7 m (67")	Landscape	over 90 kg (200 lbs)
ET10-208-BULK	208VAC, 5 conductor	240	1.025 m (40")	Portrait	over 90 kg (200 lbs)
ET17-208-BULK	208VAC, 5 conductor	240	1.7 m (67")	Landscape	over 90 kg (200 lbs)

Planning for Cable Lengths and Type

The Cabling System is flexible enough to adapt to almost any solar design. To determine the length and cable type that you need, take into account the following considerations:

- **The number of Enphase Microinverters to be installed on the AC branch circuit.** Be certain to allocate the correct number of connectors, including extra connectors for gaps and turns.
- **Additional length required to reach from the AC branch circuit junction box to the first microinverter.** If greater than half a connector interval is needed, it may be necessary to allow for one (or more) unused connectors in order to span this distance. Unused connectors must be covered with Enphase watertight sealing caps.
- **Additional length required to reach from one row of PV modules to the next.** If the PV modules are laid out in multiple rows, the distance from one row to the next often requires additional cabling length.
- **Bend radius.** When planning cabling turns or loops, you must account for a minimum bend radius of 6.7 cm (2.625”).
- **Multiple sub-arrays.** Often, the AC branch circuit may be composed of several smaller sub-arrays across more than one roof plane. In this case, the cable is cut to service each smaller array, and the sub-arrays are connected together using appropriately rated lengths of conduit. The transition from cable to conduit is accomplished using an outdoor rated AC junction box, as required by the NEC and local code. Unused connectors must be covered with Enphase watertight sealing caps.
- **Mixture of PV modules in both portrait and landscape orientation.** When PV modules are installed in mixed orientation (both portrait and landscape orientation), there are three choices for cabling:
 1. Cabling with 1.025 meter spacing between connectors results in cleanest install for the PV modules in portrait orientation. For PV modules placed in landscape orientation, plan for an unused connector between each PV module to accommodate the required additional distance. Unused connectors must be covered with Enphase watertight sealing caps.
 2. Cabling with 1.7 meter spacing between connectors results in cleanest install for PV modules in landscape orientation, but requires that any additional cable length between PV modules in portrait orientation be coiled and dressed so that cabling does not contact the roof. Again, unused connectors must be covered with Enphase watertight sealing caps.
 3. Another solution when PV modules are installed in mixed orientation is to transition between 1.025 and 1.7 meter spacing cable options using an outdoor rated junction box. This junction box can be installed to the PV racking.

Enphase Engage Cable and Accessories Installation

Follow the instructions in this section to install the Engage Cable.

For information on microinverter installation, refer to the *M215 Installation and Operation Manual* at <http://www.enphase.com/support/downloads>.

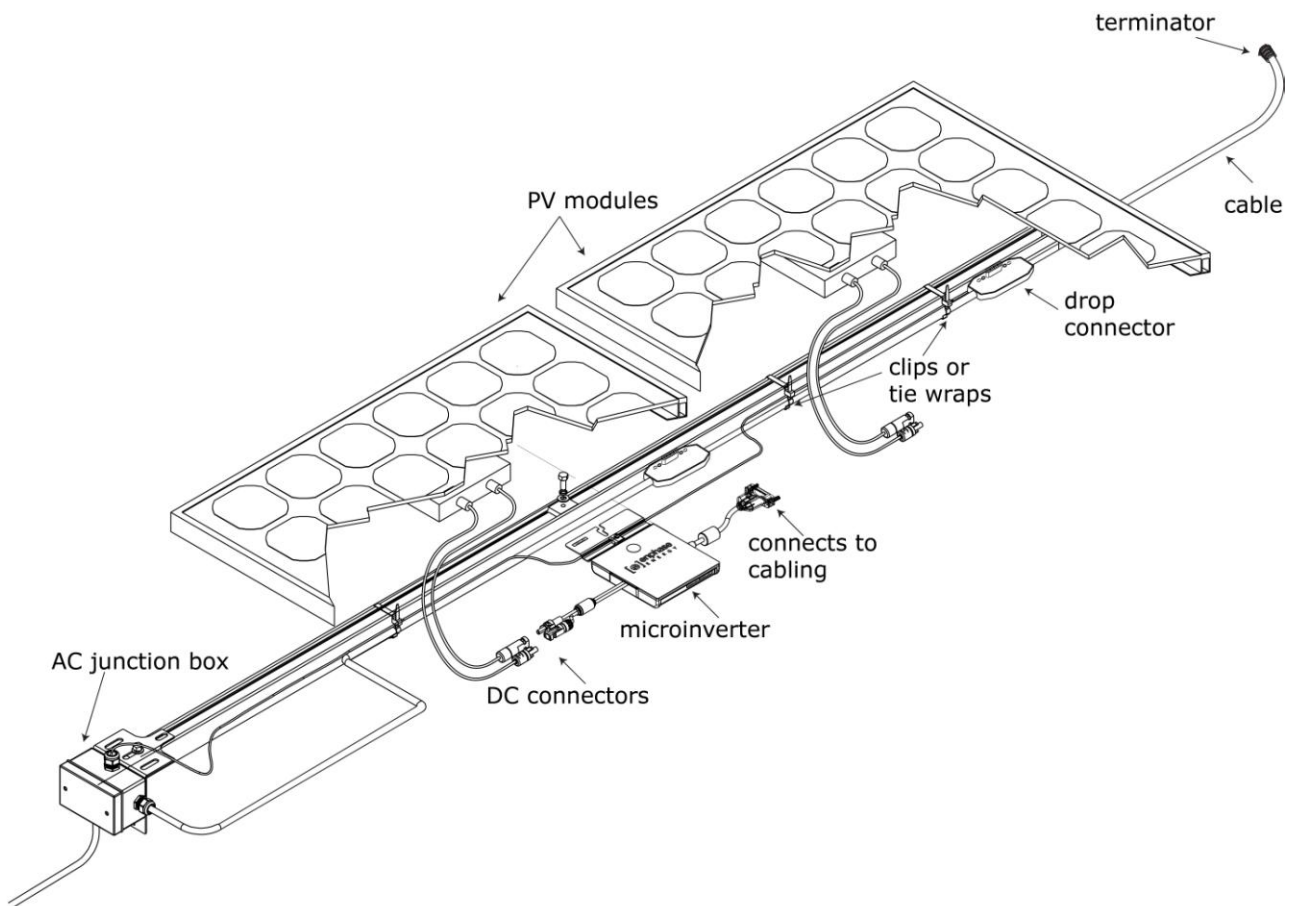

Installation Procedure

Installing the Engage Cable and Accessories involves several key steps:

1. Measure AC at Service Entrance Conductors
2. Install the AC Branch Circuit Junction Box
3. Position the Engage Cable
4. Attach the Microinverters to the Racking
5. Dress the Engage Cable
6. Terminate the Unused End of the Engage Cable
7. Connect the Engage Cable to Junction Box(es)
8. Verification and Commissioning



Risk of Electrical Shock. Due to presence of exposed conductors, DO NOT connect the Enphase Microinverters to the utility grid or energize the AC circuit(s) until you have completed all of the installation procedures as described in the following sections.

Step 1 – Measure AC at Service Entrance Conductors

Measure AC line voltage at the service entrance conductors. Acceptable ranges are shown in the following table.

240 Volt AC Split Phase		208 Volt AC 3 Phase	
L1 to L2	211 to 264 Vac	L1 to L2 to L3	183 to 229 Vac
L1, L2 to neutral	106 to 132 Vac	L1, L2, L3 to neutral	106 to 132 Vac

NOTICE

Be sure the Engage Cable you are using matches the service at the site. Use 208Vac cabling at sites with three-phase 208Vac service, or use 240Vac cabling at sites with 240Vac service. Check the labeling on the cable drop connectors to verify the cable type.

Step 2 – Install the AC Branch Circuit Junction Box

⚠ DANGER

Risk of Electrical Shock. Be aware that installation of this equipment includes risk of electric shock. Do not install the junction box without first removing AC power from the Enphase System.

NOTICE

Use electrical system components approved for wet locations only.

NOTICE

When stripping off the cable sheath, make sure that the conductors are not damaged.

NOTICE

Do not weigh down the cabling system.

NOTICE

Loose cables might become a tripping hazard. Attach the power cables correctly.

NOTICE

Do NOT exceed the maximum number of microinverters in an AC branch circuit as listed on page 7 of this manual, and protect each microinverter AC branch circuit with a 20 A maximum breaker.

- a. Size the AC wire gauge to account for voltage drop. Select the correct wire size based on the distance from the beginning of the microinverter branch circuit to the breaker in the load center.

All components of system wiring must be considered, including internal voltage drop within the length of Engage Cable. Typically, three wire sections and several wire terminations must be quantified. There is also some resistance associated with each OCPD (OverCurrent Protective Device), typically a circuit breaker. As all of these resistances are in series, they add together. Since the same current is flowing through each resistance, the total voltage drop is total current times the total resistance. For a split-phase system, the total resistance is equal to two times the one-way resistance. For a three-phase system, each of the three line currents and resistances must be calculated.

NOTICE

NEC guidelines for voltage drop on feeder and branch circuit conductors will not be sufficient for microinverter branch circuits that contain the maximum allowable microinverters. This is due to high inherent voltage rise on the branch circuit.

For more information, refer to the *Voltage Drop Calculations* Application Note at <http://www.enphase.com/support/downloads>.

- b. Install an outdoor rated, weather-proof junction box at a suitable location on the PV racking system (typically at the end of a row of modules).
- c. Provide an AC connection from the junction box back to the utility interconnection, using equipment and practice as required by the NEC and local jurisdictions.

Step 3 – Position the Enphase Engage Cable

NOTICE

Many modules have a central stiffening brace. In these cases, do **not** position the connector and microinverter at the exact center of the PV module, but position the cable so that connectors do not conflict with the braces.

- a. Lay the cabling along the route it will travel, positioning the connectors so that they align with the PV modules.
- b. Module widths vary by manufacturer. On the Engage Cable, connectors are spaced at intervals to allow for the widest PV modules compatible with Enphase Microinverters. If narrower modules are used, it may be necessary to account for excess cable by adding a loop of cable at suitable intervals.

Step 4 – Attach the Microinverters to the Racking

- a. **Mount the microinverters according to the microinverter manual.** Ensure both that the microinverter does not interfere with the PV module frames or stiffening brace, and that the drop cable from the microinverter can easily reach the connector on the cable.

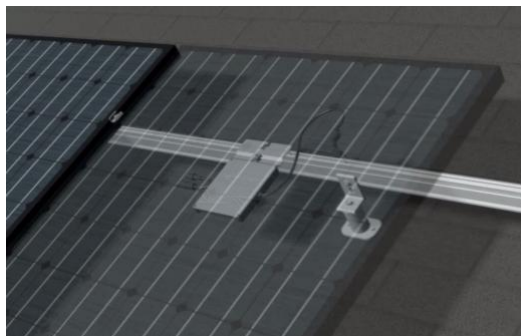

- b. Ground the microinverters using either a continuous, unbroken grounding conductor or approved grounding washers. Follow the methods described in the *M215 Installation and Operation Manual* at <http://www.enphase.com/support/downloads>.

Step 5 – Dress the Engage Cable

NOTICE

Adhere to the following requirements:

- Do not expose the connection to directed, pressurized liquid (water jets, etc.).
- Do not expose the connection to continuous immersion.
- Do not expose the AC connector to continuous tension (e.g., tension due to pulling or bending the cable near the connection)
- Use only the connectors and cables provided.
- Do not allow contamination or debris in the connectors.
- Use the cable and connectors only when all parts are present and intact.
- Fit the connection using only the prescribed tools.
- There are two release holes in the cable connector. These holes are used to disconnect the connector. **Keep these release holes clear and accessible.**



- a. Attach the Engage Cable to the rack using the included clips, or you may use tie wraps. The cable clips are designed so that the drop cable from the microinverter can also be dressed into the clip underneath the cable.
- b. Dress any excess cabling in loops so that cabling does not contact the roof.



⚠ WARNING

Tripping Hazard. Do **not** leave the cabling to rest on the roof. Loose cables might become a tripping hazard. Attach the power cables correctly.

- c. Place tie wraps or clips on either side of the drop connector. Use one or two additional clips, tie wraps, or other support scheme to secure the cable between connectors.
- d. Remove the temporary shipping cap from the Engage Cable.



Step 5 – Dress the Engage Cable (continued)

- e. Connect the microinverter and listen for two clicks as the two prongs engage. Ensure that **both** latching mechanisms have engaged.

NOTICE

The connector has not been designed for repeated linking and unlinking.



- f. Repeat steps **a** through **e** for all microinverters in the branch.

- g. Cover any unused connector with a watertight sealing cap. Listen for two clicks as the connectors engage. Ensure that **both** latching mechanisms have engaged.

NOTICE

Make sure watertight sealing caps are installed on **all** unused AC connectors. Unused AC connectors are live when the system is energized by the utility.



NOTICE

Do not use the shipping cap to cover unused connectors. The shipping cap does not provide an adequate environmental seal. Enphase watertight sealing caps (included in the Installation Kit) are required for protection against moisture ingress.

NOTICE

Enphase watertight sealing caps are IP67 rated. Within the term "IP67", "IP" indicates an Ingress Protection (IP) rating against dust and liquids. This specific rating of IP67 indicates that this connector protects against all dust particles and immersion in liquid.

NOTICE

If you need to remove a watertight sealing cap, you must use the Enphase disconnect tool or a #2 Phillips screwdriver.

Step 6 – Terminate the Unused End of the Engage Cable

Attaching the Terminator

NOTICE

The terminator is intended for one-time use only. If you open the terminator following installation, the latching mechanism is destroyed and the terminator cap cannot be used again. If the latching mechanism is defective, the terminator must not be used. The latching mechanism must not be circumvented or manipulated.

NOTICE

Adhere to the following requirements:

- Use of the terminator assembly is the only method allowed to seal the conductor end of the trunk.
- Do not expose the terminator cap to directed, pressurized liquid (water jets, etc.).
- Do not expose the terminator cap to continuous immersion.
- Do not expose the terminator cap to continuous tension (e.g., tension due to pulling or bending the cable near the terminator cap)
- Do not install or use in potentially explosive environments.
- Do not allow the terminator to come into contact with open flame.
- Use the terminator cap assembly only when all parts are present and intact.
- Fit the terminator cap using only the prescribed tools.

To attach the terminator:

- Check the terminator cap assembly for completeness. It is made up of the individual parts shown.

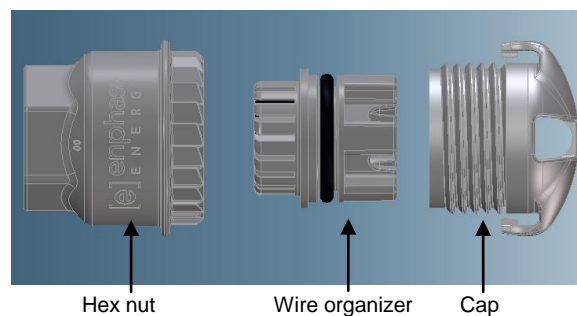

- To guarantee the safety of the wire organizer and to ensure that it remains sealed, please make sure that all parts are present and that all seals are seated correctly in the wire organizer.

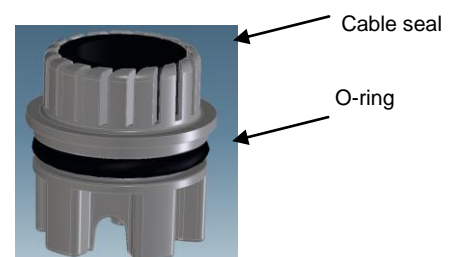

The wire organizer must be complete, as shown.

⚠ DANGER

Risk of Electrical Shock. The terminator cap must not be installed while power is connected.

- c. Strip at least 60 mm (2.5 inches) of the shielding from the conductors.

NOTICE

If the exposed wires are damaged, system function can no longer be guaranteed.

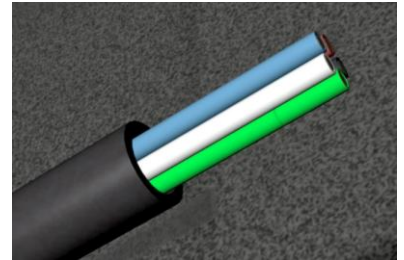

- d. Slide the hex nut onto the cable.
- e. Insert the cable all the way into the wire organizer (up to the stop).
- f. Bend the individual wires into the slots (spaces) on the wire organizer.
- g. Using a diagonal cutter, trim wires to the correct length so that they fit cleanly into the slots (spaces) in the wire organizer.

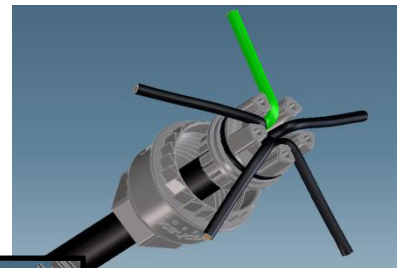

- h. Press the cap onto the wire organizer, bending the wires into the slots of the wire organizer.

If the wires resist being pressed into the cap, you may need to trim the wires a little further using a diagonal cutter.

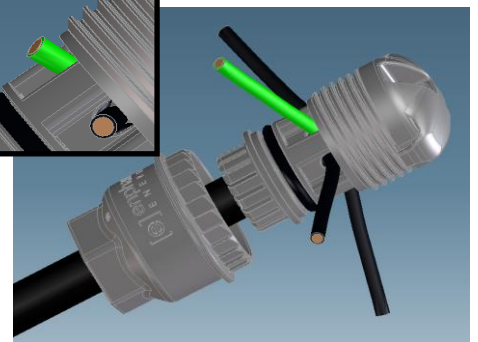
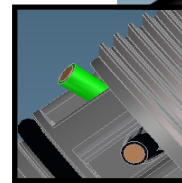

- i. Screw the hex nut onto the cap.

NOTICE

Never unscrew the hex nut as this can twist and damage the cable.

- j. Insert a #2 Philips screwdriver into the slot on the cap to hold it in place. (Alternatively you can hold the cap firmly in place using the Enphase hand tool).
- k. Use a 24mm (7/8 inch) wrench and tighten the nut until the latching mechanism has been screwed all the way to the base.



- l. Use a tie wrap or cable clip to attach the cable to the racking, so that the cable and terminator do not touch the roof.

Replacing or Removing the Terminator

If the terminator must be replaced or removed, observe the following.

⚠ DANGER

Risk of Electrical Shock. Never open, remove or replace the terminator while it is connected to the power supply.

NOTICE

Damage to the latching mechanism **cannot** be seen with the naked eye. Label the opened terminator and dispose of it immediately to ensure that it cannot be reused accidentally.

NOTICE

The terminator is intended for **one-time use only**. If you open the terminator again following the installation, this will destroy the latching mechanism, meaning that the unit then **cannot** be used again.

- a. Remove the terminator by cutting it off using a diagonal cutter set flush against the end of the cable.
- b. Replace the terminator as described in the previous steps, beginning on page 17.

Step 7 – Connect the Engage Cable to Junction Box(es)

NOTICE

Perform the following steps in accordance with NEC regulations.

- a. Connect Engage Cable into the AC branch circuit junction box using an appropriate gland or strain relief fitting. The cable requires a strain relief connector with an opening of 1.3 cm (0.5 inches) in diameter.
- b. Connect the Engage Cable into additional junction boxes as needed to transition to conduit between smaller sub-arrays. Remember to adhere to branch limits for the microinverters being used.



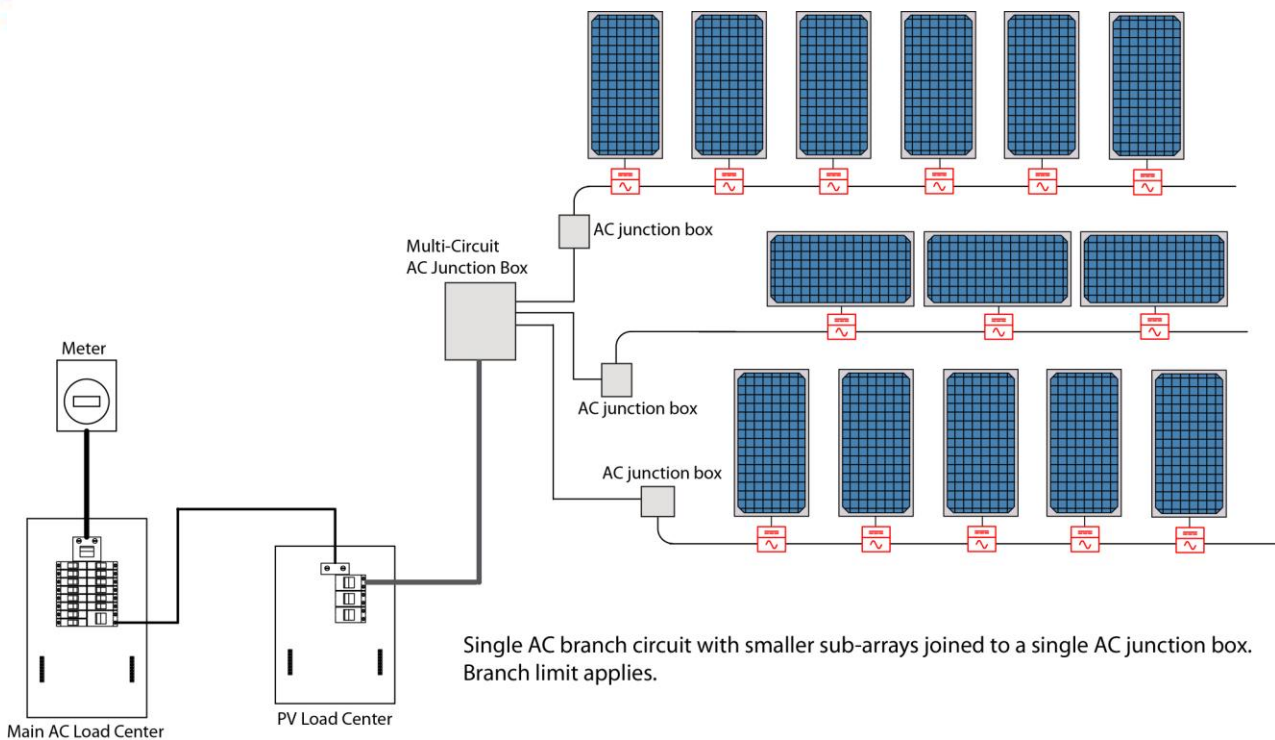

Refer to the wiring diagrams located in the Appendix of this manual for more information.

NOTICE The Engage Cable uses a different wiring scheme than used with other Enphase Microinverters. Be aware of the difference in wire color code.

The 12 AWG conductors are identified as follows: L1 is sheathed in Black, L2 is sheathed in red, L3 is sheathed in blue (208 Vac only), Neutral is sheathed in white, and Ground is sheathed in green. The grounding wire is used to ground the microinverters. A WEEB or continuous ground is required in addition to this green grounding wire.

Balanced 208 VAC is accomplished by alternating phases between microinverters.

240 Volt AC Split Phase Wiring	208 Volt AC Three-Phase Wiring
Black – L1 Red – L2 White – Neutral Green - Ground	Black – L1 Red – L2 Blue – L3 White – Neutral Green - Ground

The green wire acts as equipment ground. A continuous GEC for system ground is also required as described in the next step.

Step 8 – Verification and Commissioning

NOTICE

Prior to final connection to the utility grid, ensure that all AC and DC wiring is correct.

- a. Ensure that none of the AC and DC wires are pinched or damaged.
- b. Ensure that all junction boxes are properly closed.
- c. Ensure that all unused connectors are capped.
- d. Ensure that all connectors are properly seated.
- e. Install the microinverters and commission the system as instructed by the Enphase Microinverter installation and operation manual.

Disconnecting a Microinverter from the Engage Cable

To ensure the microinverter is not disconnected from the PV modules under load, adhere to the following disconnection steps in the order shown:

1. Disconnect the microinverter AC connector from the Engage Cable.
2. Cover the module with an opaque cover.
3. Using a DC current probe, verify there is no current flowing in the DC wires between the PV module and the microinverter.

NOTICE

Care should be taken when measuring DC currents due to the fact that most clamp-on meters must be zeroed first and tend to drift with time.

4. Disconnect the PV module DC wire connectors from the microinverter.
5. Remove the microinverter from the PV array racking.
6. The microinverter connectors are tool-removable only. The installation kit includes a disconnect tool with two prongs. To disconnect a microinverter from the cabling system, insert these two prongs into the two holes in the cable connector. Squeeze the sides of the disconnect tool to engage with the connector. Rock the connector back and forth while pulling gently to disengage.
7. If the disconnect tool is not available, a #2 Phillips screwdriver can be used in its place. Insert the screwdriver into one hole, rock that side of the drop connector out, then insert the screwdriver into the other hole and pull the connector out entirely.

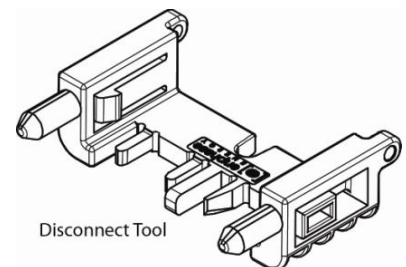

⚠ DANGER

Risk of Electrical Shock. Do not leave the drop connector uncovered for an extended period. If you do not plan to replace the microinverter immediately, you must cover any unused connector with a watertight sealing cap. Listen for two clicks as the connectors engage.

Technical Data

Specification	Value
System temperature range (ambient)	-40C to +65C (-40F to 149F)
Cable temperature rating	90C Dry / 90C Wet
Cable insulator rating	THWN-2
Environmental protection rating	IEC 60529 IP67
UV exposure rating	UL 746 C, F1
Conductor gauge	12AWG
Maximum current carrying capacity of the Engage Cable	20 amperes
Maximum current carrying capacity of the drop cable (on the microinverter)	4 amperes
Cable bundle diameter	1.3 cm (0.525")
Drop connector dimensions	11.8 cm x 6.0 cm x 3.2 cm (4.64" x 2.36" x 1.25")
Terminator cap dimensions	3.6 cm diameter x 5.1 cm tall (1.4" x 2")
Cable weights [about 1lb (0.5 kg) per drop]:	
30-drop cable	30 lbs/14 kg (approximate)
40-drop cable	40 lbs/18 kg (approximate)
240-drop cable	240 lbs/110 kg (approximate)





Appendix – Sample Wiring Diagrams

Sample Wiring Diagram – 240 Vac

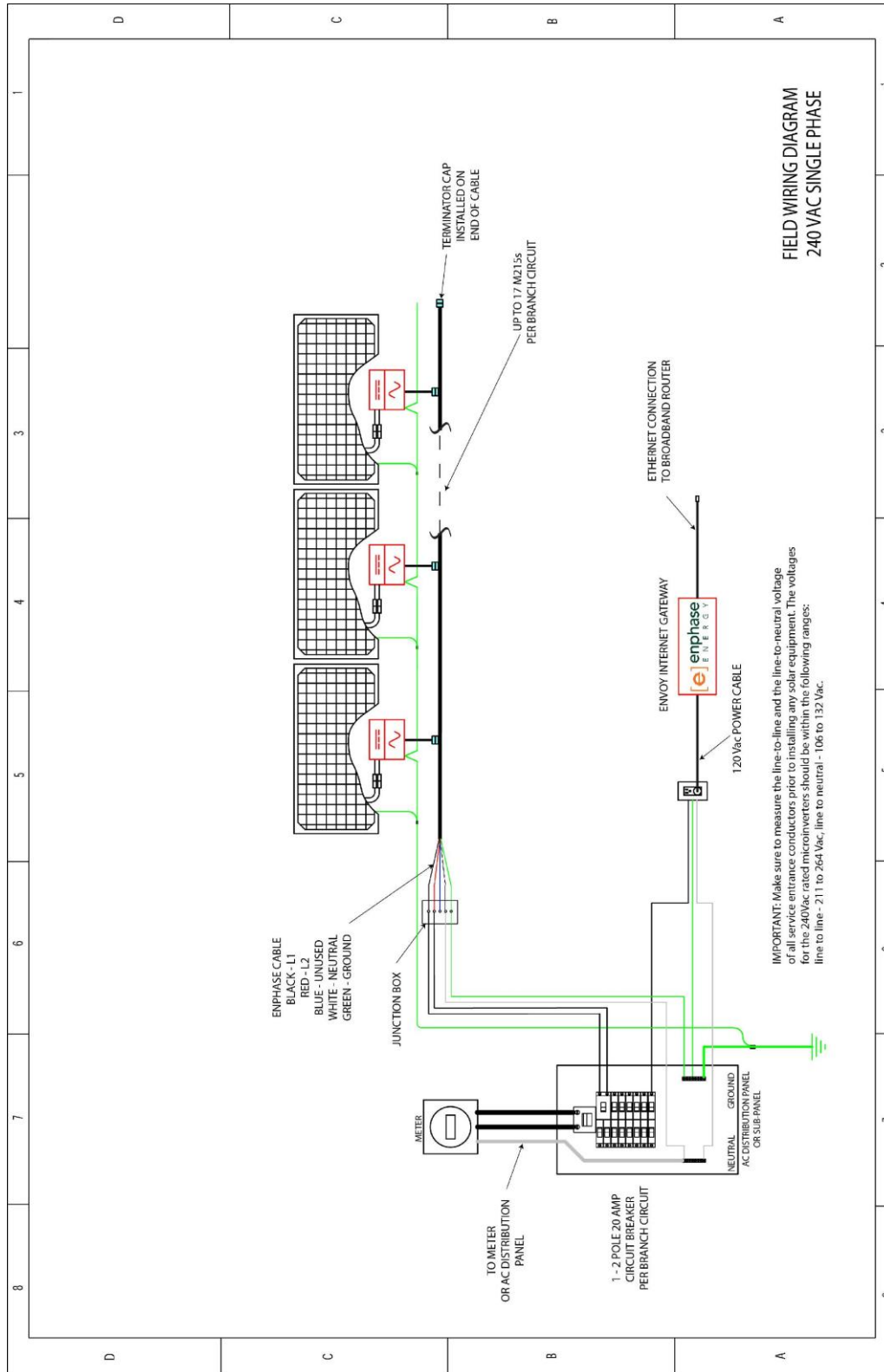

Sample Wiring Diagram – 208 Vac

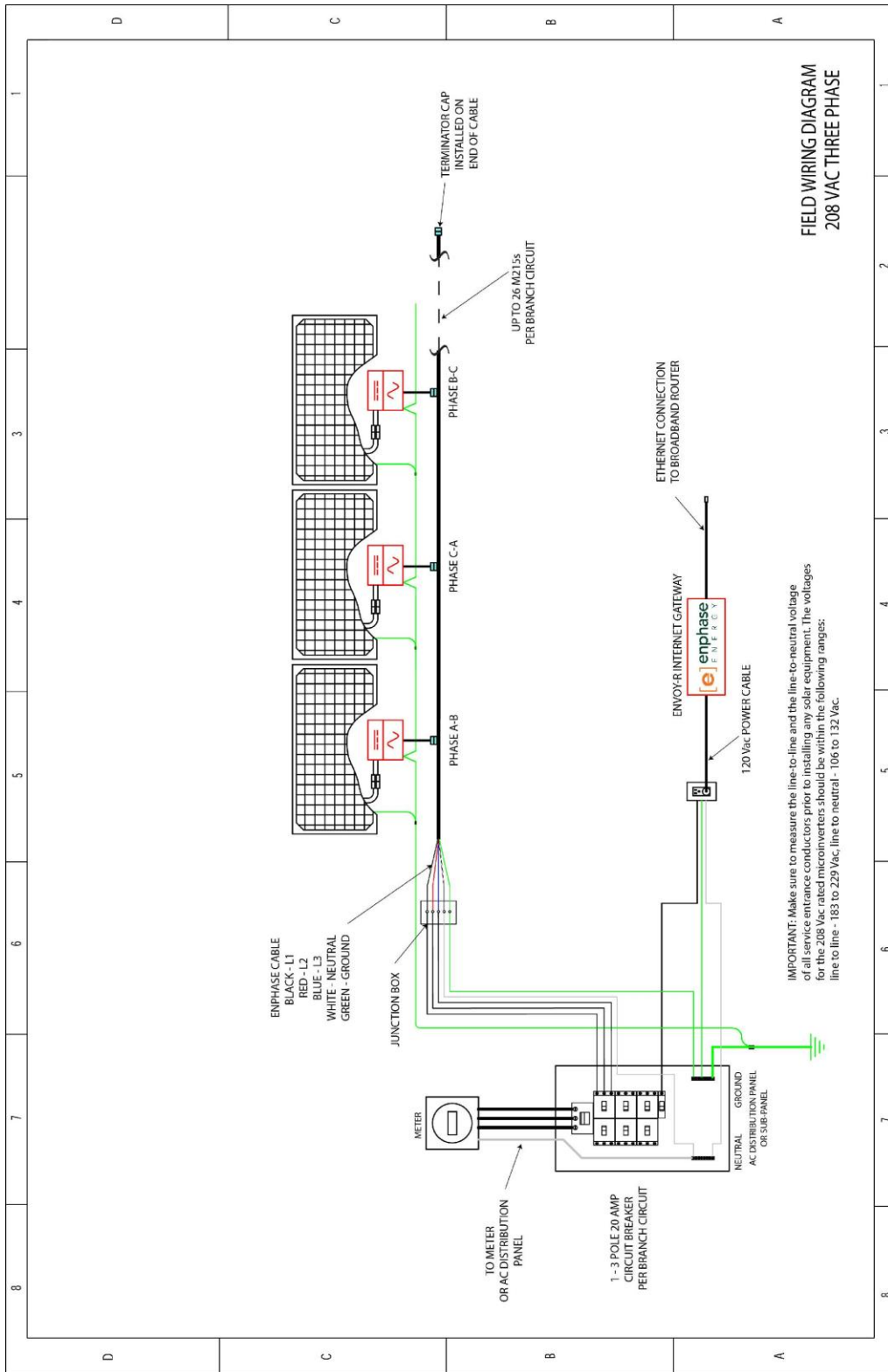





Enphase Energy Inc.
201 1st Street
Petaluma, CA 94952
Phone: 707-763-4784
TOLL FREE: 877-797-4743
Fax: 707-763-0784
www.enphase.com
info@enphaseenergy.com