

WEATHER STATION

MODEL: BHB613

USER'S MANUAL

INTRODUCTION

Thank you for purchasing the Oregon Scientific weather station. This weather station has been designed specifically with performance and ease of use in mind. As with all Oregon Scientific products, this barometer is made to the highest quality standards using precision electronic components and should give you many years of trouble free use. Please note that the accuracy of the weather forecasting is about 70 ~ 75 percent.

FEATURES & KEY CONFIGURATION

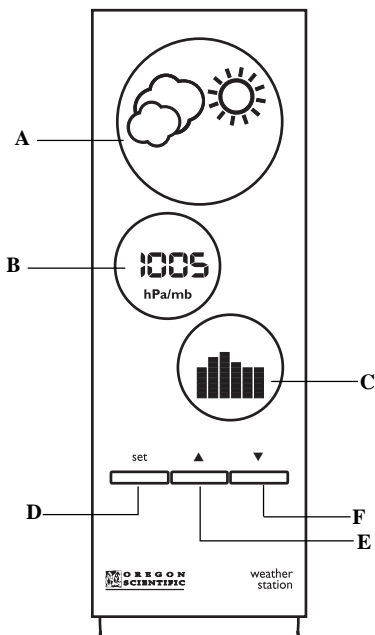

A. WEATHER FORECAST WINDOW

Weather forecast indication shows sunny, slightly cloudy, cloudy and rainy.

B. PRESSURE READING WINDOW

Displays the current pressure reading.

C. PRESSURE TREND CHART WINDOW

D. [SET] button

To set the altitude

E. [UP] button

Increases the value of setting by 10

F. [DOWN] button

Decreases the value of setting by 10

G. [RESET] BUTTON

Returns all settings to default value and erases all memories.

H. [hPa/mb-inHg] Slide switch

Selects between hPa/mb or inHg display unit.

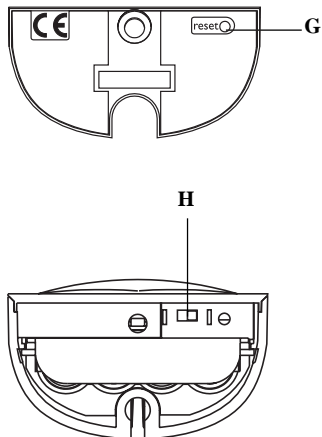

BATTERY INSTALLATION

The unit uses four UM-4 "AAA" size batteries. If the "  " indicator appears, removes the exhausted batteries and follow these steps to replace the batteries:

1. Unscrew the battery door at the bottom of the unit.
2. Remove the battery cover and insert the batteries as indicated by the polarity symbols (+ and -) marked inside the battery compartment.
3. Replace the battery door and fasten the screw.

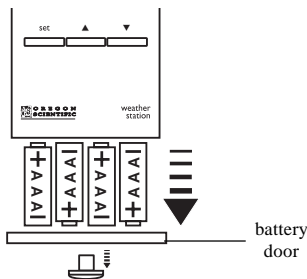





Note: After replacing the batteries, the whole display will be turned on for about 3 seconds and then show the following:

- a. Weather forecast shows slightly cloudy (a sun with the cloud indicator)
- b. Pressure trend shows steady.
- c. Barometric pressure shows the current reading.

The unit takes about 24 hours to store the barometric pressure date. Until that time has elapsed, the pressure trend and weather forecast symbols may not reflect actual weather forecast for your area.

HOW TO READ THE ILLUSTRATED WEATHER FORECAST SYMBOLS

Your weather station detects barometric pressure changes and the LCD displays the illustrated weather symbols which indicating the weather forecast for 12 or 24 hours ahead, for an area with a radius of about 18-30 miles.

Indicator displays on the unit				
Forecas	Sunny	Slightly Cloudy	Cloudy	Rainy

Important:

1. The accuracy of weather forecasting when using pressure trend alone is about 70 to 75 percent and, therefore, we cannot be held responsible for any inconveniences caused by an inaccurate weather forecast.

2. The weather forecasts symbols reflect forecast 12-24 hours in the future and not the current situation..
3. A ' Sunny ' forecast reflects fine clear weather.

HOW TO READ THE PRESSURE TREND CHART

Stored memory of the barometric pressure changes are displayed on the chart, in 5 steps indicating the pressure 1,3,6,12 and 24 hours ago. This chart is plotted by comparing the past barometric pressure to the present pressure.

This gives you the pressure trend over the last 24 hours. The weather will be getting better (worse) if this chart shows the bar marks moving up (down) towards the present time.

Important:

It is only possible to measure the barometric pressure trend properly if your barometer remains at the same altitude.

When moving around at different altitude within a short time period, the air pressure changes. The barometric pressure reading is precise only if the barometer has remained at a constant altitude for 24 hours.

However, please note again the accuracy of a weather forecast based on the barometric pressure reading. It is considered to be about 70-75%.

HOW TO SET THE ALTITUDE

1. Press and hold the [SET] button for 2 seconds to set the altitude. The 'ALT' indicator will turn on with the altitude setting flashing (display in meter). The accuracy of a general pressure-based weather forecast is about 70% to 75%.

Increase/decrease the altitude in steps of 10 meter by pressing [▲] or [▼] button.

2. Press the [SET] button again to set the altitude. At this time the previous pressure display will reappear. If the altitude has been changed, the ' ALT ' indicator flashing (about 15 minutes) until a new sampling takes place and the pressure reading is then compensated with the new altitude.
3. Press the [SET] button 6 times to confirm the setting you just entered or wait for one minute for automatic exit.

Note: For monitoring the local barometric pressure reading, the user needs to select the 0 meter (preset value) for the altitude setting.

For monitoring the Sea Level barometric pressure reading at certain altitude, the user needs to select the local altitude (-100 to 2500 meters i.e. -328 to 8223 feet) for the altitude setting. The BHB-613 requires entry of elevation in meters not feet. Therefore, to convert feet to meters, multiply feet by 0.3048.

To determine your location elevation, please either contact your local library, TV/ radio weather forecaster, or via Intenet at www.worldatlas.com/aatals/infopage/elevation.htm.

HOW TO SELECT THE BAR OR LINE CHART FOR THE PRESSURE TREND

- To get the line chart display, press the **[RESET]** button at the bottom of the unit while pressing and holding the **[SET]** key in the bar chart display.
- To get the bar chart display, press the **[RESET]** button once.

Note: Either action will reset the unit and the previous readings/setting will be lost.

HOW TO SELECT THE PRESSURE UNITS OF MEASURE

The switch in the battery compartment of the weather station selects between hPa/mb and inHg. To select hPa/mb, set the switch to hPa/mb. To select inHg, set the switch to inHg.

LOW BATTERY SIGNAL INDICATION



If the voltage of the batteries becomes low, the "  " indicator will be displayed. Replace the batteries when the "  " indicator is displayed.

TABLE STANDING OR WALL MOUNTING

Table Standing :

Your unit comes with stand connector for connecting it to the other modular units.

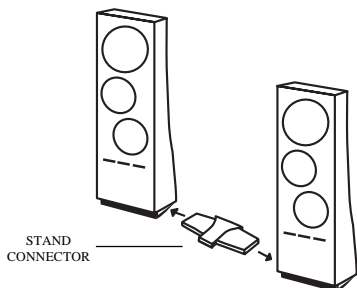

Wall-Mounting:

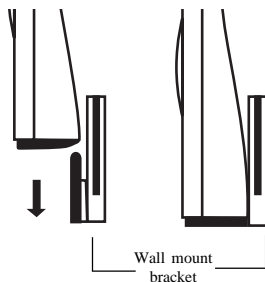

Connector:

Use wall-mount connector to align with other wall-mount bracket if necessary.

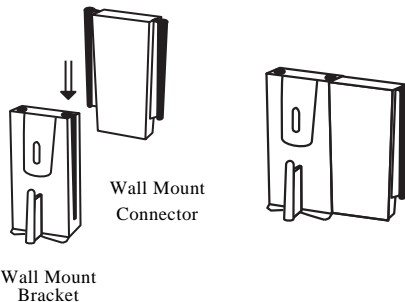

Un-install the brackets:

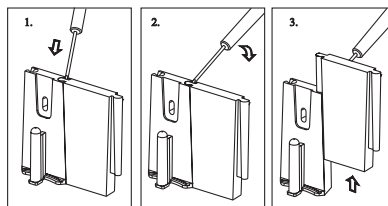

MAINTENANCE

When handled properly, this unit is engineered to give you years of satisfactory service. Here are a few product care instructions:

1. Do not immerse the unit in water. If the unit comes in contact with water, dry it immediately with a soft lint-free cloth.
2. Do not clean the unit with abrasive or corrosive materials. Abrasive cleaning agents may scratch the plastic parts and corrode the electronic circuit.
3. Do not subject the unit to excessive: force, shock, dust, temperature, or humidity. Such treatment may result in malfunction, a shorter electronic life span, damaged batteries, or distorted parts.
4. Do not tamper with the unit's internal components. Doing so will terminate the unit's warranty and may cause damage. The unit contains no user-serviceable parts.
5. Only use new batteries as specified in this instruction manual. Do not mix new and old batteries as the old batteries may leak.
6. Read this instruction manual thoroughly before operating the unit.

SPECIFICATION

Pressure measuring range	:	794 to 1050 hPa/mb (24.45 to 31.00 inHg)
Altitude compensation for barometric pressure reading	:	-100 to 2500 meters (-328 to 8223 feet)
Pressure display resolution	:	1 hPa/mb (0.03inHg)
Pressure sampling cycle	:	15 minutes
Power source	:	Four pcs. UM-4 or “AAA” size batteries
Battery life	:	9 month
Dimension	:	6.64" x 2.32" x 1.28" (H xWxD)
Weight	:	4.80 ounces (without battery)

CAUTION

- The content of this manual is subject to change without further notice.
- Due to printing limitation, the displays shown in this manual may differ from the actual display.
- The contents of this manual may not be reproduced without the permission of the manufacturer.

CUSTOMER ASSISTANCE

Should you require assistance regarding this product and its operation, please contact our customer care department at 800-853-8883 or via email at helpme@oscientific.com.

WARRANTY

This product is warranted to be free of manufacturing defects for a period of 1 year from date of retail purchase. Defective product should be directed to the place of retail purchase for exchange. Should this not be possible, contact our customer care department for assistance and a return material authorization. No returns may be made without a return authorization. Please retain your retail receipt as you may be asked to provide a copy of it for proff of date purchased.

This warranty does not cover product subjected to abuse, misuse, accidental damage or tampering.