

Register your product and get support at

www.philips.com/welcome

AD620



User manual

PHILIPS

Contents

1	Important	3
<hr/>		
2	Your Docking Speaker	3
	Introduction	3
	What's in the box	3
	Overview of the main unit	4
<hr/>		
3	Get started	5
	Connect power	5
<hr/>		
4	Play	5
	Play from iPod/iPhone	5
	Play from Bluetooth device	6
	Play from an external audio device	7
	Adjust volume	7
<hr/>		
5	Product information	7
	Specifications	7
<hr/>		
6	Troubleshooting	8
	About Bluetooth device	8
<hr/>		
7	Notice	9
	Disposal of your old product	9

1 Important

- Read these instructions.
- Heed all warnings.
- Follow all instructions.
- Do not use this apparatus near water.
- Do not block any ventilation openings. Install in accordance with the manufacturer's instructions.
- Do not install near any heat sources such as radiators, heat registers, stoves, or other apparatus (including amplifiers) that produce heat.
- Protect the power cord from being walked on or pinched, particularly at plugs, convenience receptacles, and the point where they exit from the apparatus.
- Only use attachments/accessories specified by the manufacturer.
- Unplug this apparatus during lightning storms or when unused for long periods of time.
- Refer all servicing to qualified service personnel. Servicing is required when the apparatus has been damaged in any way, such as power-supply cord or plug is damaged, liquid has been spilled or objects have fallen into the apparatus, the apparatus has been exposed to rain or moisture, does not operate normally, or has been dropped.
- Apparatus shall not be exposed to dripping or splashing.
- Do not place any sources of danger on the apparatus (e.g. liquid filled objects, lighted candles).
- Where the plug of the Direct Plug-in Adapter is used as the disconnect device, the disconnect device shall remain readily operable.



Warning

- Never remove the casing of this apparatus.
- Never place this apparatus on other electrical equipment.
- Ensure that you always have easy access to the power cord, plug or adaptor to disconnect the apparatus from the power.

2 Your Docking Speaker

Congratulations on your purchase, and welcome to Philips! To fully benefit from the support that Philips offers, register your product at www.philips.com/welcome.

If you contact Philips, you will be asked for the model and serial number of this apparatus. The model number and serial number are on the bottom of the apparatus. Write the numbers here:

Model No. _____

Serial No. _____

Introduction

With this docking speaker, you can enjoy audio from the iPod/iPhone, Bluetooth devices, and other external audio devices.

What's in the box

Check and identify the contents of your package:

- Main unit
- AC power adaptor
- Quick start guide

Overview of the main unit

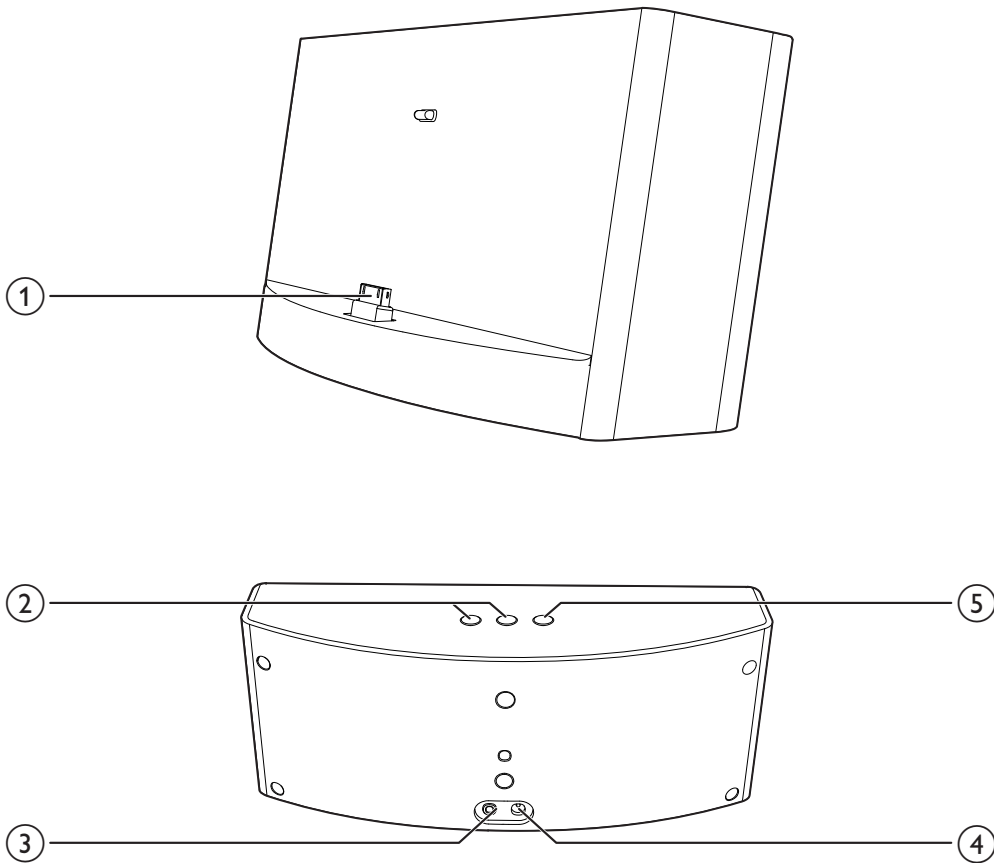

- ① **Dock for the iPod/iPhone**
- ② **VOL +/-**
 - Adjust volume.
- ③ **MP3 LINK**
 - Connect an external audio device.
- ④ **DC IN**
 - Connect power.
- ⑤ *****
 - Enable or disable Bluetooth function.

3 Get started

Always follow the instructions in this chapter in sequence.

Connect power



Caution

- Risk of product damage! Make sure that the power supply voltage matches the voltage printed on the bottom of the unit.
- Risk of electric shock! When you unplug the AC adaptor, always pull the plug from the socket. Never pull the cord.



Note

- The type plate is located at the back of the docking speaker.

Connect the power adaptor to:

- the **DC IN** socket at the back of the docking speaker.
- the wall outlet.

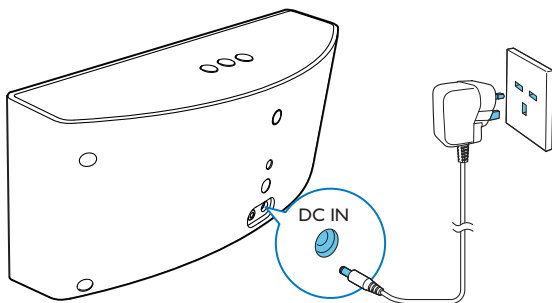

4 Play

Play from iPod/iPhone

You can enjoy audio from your iPod/iPhone through this docking speaker.

Compatible iPod/iPhone

The docking speaker supports the following iPod and iPhone models:

Made for:

- iPod touch (1st, 2nd, 3rd, and 4th generation)
- iPod classic
- iPod nano (1st, 2nd, 3rd, 4th, 5th, and 6th generation)
- iPhone 4S
- iPhone 4
- iPhone 3GS
- iPhone 3G
- iPhone

Listen to the iPod/iPhone

- 1 Place an iPod/iPhone in the dock.
- 2 Play audio from the iPod/iPhone.

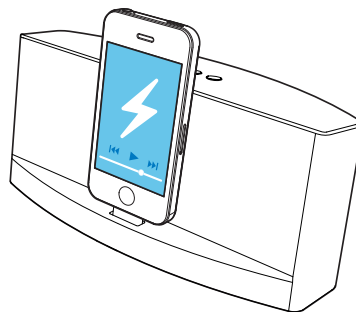

To remove the iPod/iPhone:

Pull the iPod/iPhone out of the dock.

Charge the iPod/iPhone

When the docking speaker is connected to power, the docked iPod/iPhone begins to charge automatically.

Play from Bluetooth device

Pair with Bluetooth devices

Note

- Before you connect a Bluetooth device to this docking speaker, familiarize yourself with the Bluetooth capabilities of the device.
- The effective operation range between the docking system and the paired device is approximately 10 meters (30 feet).
- Keep this docking speaker away from other electronic devices that may cause interference.

- 1 Press  to select Bluetooth source.
↳ The Bluetooth button blinks.
- 2 Turn on Bluetooth function on your device.
 - Different devices may have different way to activate Bluetooth.

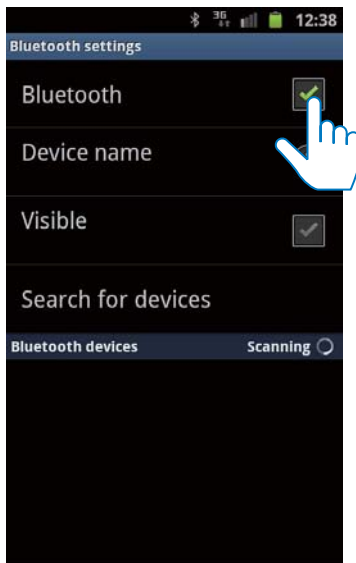

- 3 Scan Bluetooth devices that can pair with your device.
- 4 When “PHILIPS AD620” is displayed on your device, select it to start connection.
 - ↳ Double beep tone confirmation is heard and the Bluetooth button stops blinking if connection is successful.
 - ↳ A different Bluetooth icon is displayed on your device.

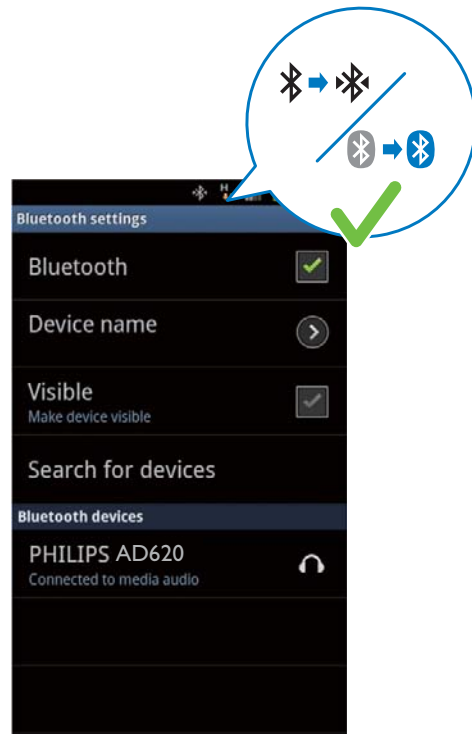

- 5 Play music in your device.
 - ↳ Music comes through the docking speaker.

Tip

- If your Bluetooth device has been paired with AD620 before, you just need to find out “PHILIPS AD620” on your Bluetooth menu, then confirm the connection.

To disconnect Bluetooth:

- Press  on the docking speaker again; or
- Deactivate Bluetooth function on your device or move it beyond the communication range.

Play from an external audio device

With this docking speaker, you can also enjoy audio from an external device such as an MP3 player.

- 1 If no iPod/iPhone is docked, connect an MP3 link cable (not supplied) to:
 - the **MP3-LINK** socket at the back of the docking speaker.
 - the headphone socket on an external device.

↳ The docking speaker switches to MP3 link mode automatically.
- 2 Play music on the device (see the device's user manual).

Adjust volume

During play, press **VOL +/-** to adjust volume.

5 Product information



Note

- Product information is subject to change without prior notice.

Specifications

Amplifier

Total Output Power	10 W per channel x 2
Signal to Noise Ratio	> 62 dBA
MP3 Link	650 mV RMS

Bluetooth

Standard	Bluetooth Standard Version 2.1+EDR
Output power	0 dBm (Class 2)
Frequency band	2.402~2.480 GHzISM Band
Range	10 m (free space)

General information

AC Power	Model: AS190-100-A1180 (Philips); Input: 100-240V ~, 50/60Hz, 0.7A; Output: 10V \equiv 1.8 A
Operation Power Consumption	15 W
Standby Power Consumption	<0.5 W
Max. load for iPod/iPhone	5V \equiv 1 A
Dimensions - Main Unit (W x H x D)	275 x 117 x 121 mm
Weight - Main Unit - With Packing	1.2 kg 1.7 kg

6 Troubleshooting



Warning

- Never remove the casing of this apparatus.

To keep the warranty valid, never try to repair the system yourself.

If you encounter problems when using this apparatus, check the following points before requesting service. If the problem remains unsolved, go to the Philips web site (www.philips.com/support). When you contact Philips, ensure that the apparatus is nearby and the model number and serial number are available.

No power

- Ensure that the AC power adaptor of the unit is connected properly.
- Ensure that there is power at the AC outlet.

No sound

- Adjust the volume.

No response from the unit

- Disconnect and reconnect the AC power adaptor; then turn on the unit again.

About Bluetooth device

Music playback is unavailable on the system even after successful Bluetooth connection.

- The device cannot be used with the system to play music.

The audio quality is poor after connection with a Bluetooth-enabled device.

- The Bluetooth reception is poor. Move the device closer to the system or remove any obstacle between the device and the system.

Cannot connect with the system.

- The device does not support the profiles required for the system.
- The Bluetooth function of the device is not enabled. Refer to the user manual of the device for how to enable the function.
- The system is not in the pairing mode.
- The system is already connected with another Bluetooth-enabled device. Disconnect that device or all other connected devices and then try again.

The paired device connects and disconnects constantly.

- The Bluetooth reception is poor. Move the device closer to the system or remove any obstacle between the device and the system.
- For some devices, the Bluetooth connection may be deactivated automatically as a power-saving feature. This does not indicate any malfunction of the system.

7 Notice

Any changes or modifications made to this device that are not expressly approved by Philips Consumer Lifestyle may void the user's authority to operate the equipment.



"Made for iPod" and "Made for iPhone" mean that an electronic accessory has been designed to connect specifically to iPod or iPhone respectively, and has been certified by the developer to meet Apple performance standards. Apple is not responsible for the operation of this device or its compliance with safety and regulatory standards. Please note that the use of this accessory with iPod or iPhone may affect wireless performance. iPod and iPhone are trademarks of Apple Inc., registered in the U.S. and other countries.

CE 2150

This product complies with the radio interference requirements of the European Community.

Disposal of your old product

Your product is designed and manufactured with high quality materials and components, which can be recycled and reused.

Never dispose of your product with other household waste. Please inform yourself about the local rules on the separate collection of electrical and electronic products and batteries. The correct disposal of these products helps prevent potentially negative consequences on the environment and human health.

Please visit www.recycle.philips.com for additional information on a recycling center in your area.

Environmental information

All unnecessary packaging has been omitted. We have tried to make the packaging easy to separate into three materials: cardboard (box), polystyrene foam (buffer) and polyethylene (bags, protective foam sheet.)

Your system consists of materials which can be recycled and reused if disassembled by a specialized company. Please observe the local regulations regarding the disposal of packaging materials, exhausted batteries and old equipment.

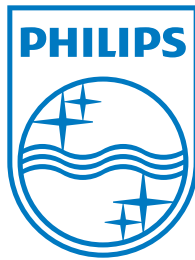

Specifications are subject to change without notice
© 2012 Koninklijke Philips Electronics N.V.
All rights reserved.

AD620_05_UM_EN_V1.0

