

# SEARS

## Electric Water Heater Owners Manual

MODEL NOS.

- ✓ 153.310360 30 Gal.
- ✓ 153.320360 40 Gal.
- ✓ 153.310460 52 Gal.
- ✓ 153.320530 HT\* 52 Gal.
- ✓ 153.320560 66 Gal.
- ✓ 153.310560 82 Gal.
- ✓ 153.320630 HT\* 82 Gal.
- ✓ 153.320830 HT\* 82 Gal.
- ✓ 153.320860 82 Gal.



GAMA certification applies to all residential electric water heaters with capacities of 20 to 120 Gallons. Input rating of 12 Kw or less at a voltage no greater than 250 V.

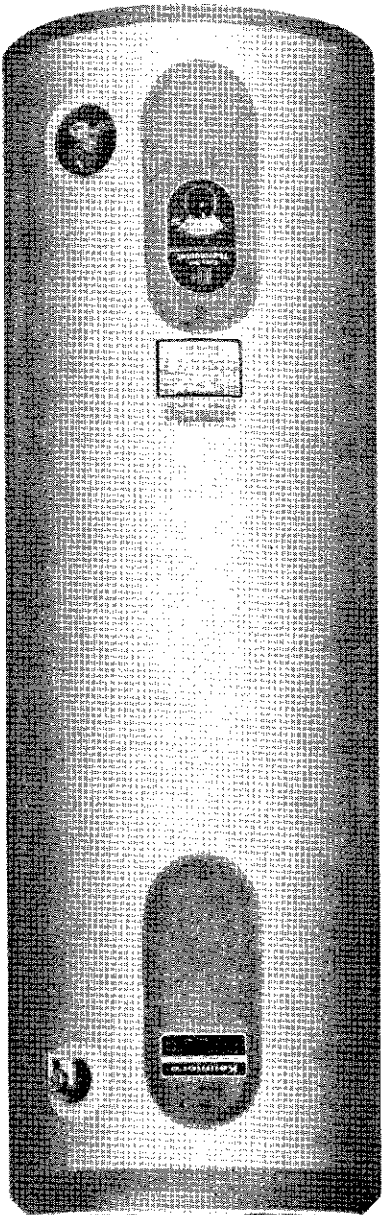

- Installation • Operation • Repair Parts

### WARNING

READ THE GENERAL SAFETY SECTION BEGINNING ON INSIDE COVER AND THEN THIS ENTIRE MANUAL BEFORE INSTALLING OR OPERATING THIS WATER HEATER.

Save this Manual for Future Reference.

# KENMORE POWER MISER™ 10+

## WARNING

Improper installation, adjustment, alteration, service or maintenance can cause DEATH, SERIOUS BODILY INJURY OR PROPERTY DAMAGE. Refer to this manual for assistance or consult the local Sears Service Center for further information.

## WARNING

At the time of manufacture this water heater was provided with a combination temperature-pressure relief valve certified by a nationally recognized testing laboratory that maintains periodic inspection of production of listed equipment or materials, as meeting the requirements for Relief Valves and Automatic Gas Shutoff Devices for Hot Water Supply Systems, and the latest edition of ANSI Z21.22 and the code requirements of ASME. If replaced, the valve must meet the requirements of local codes, but not less than a combination temperature and pressure relief valve certified as meeting the requirements for Relief Valves and Automatic Gas Shutoff Devices for Hot Water Supply Systems, ANSI Z21.22 and ASME, may require a valve model different from the one furnished with the water heater.

Compliance with such local requirements must be satisfied by the installer or end user of the water heater with a locally prescribed temperature-pressure relief valve installed in the designated opening in the water heater in place of the factory furnished valve.

For safe operation of the water heater, the relief valve must not be removed from its designated opening or plugged. The temperature-pressure relief valve must be installed directly into the fitting of the water heater designated for the relief valve. Position the valve downward and provide tubing so that any discharge will exit only within 6 inches above, or at any distance below the structural floor. Be certain that no contact is made with any electrical part. The discharge opening must not be blocked or reduced in size under any circumstances. Excessive length, over 15 feet, or use of more than two elbows can cause restriction and reduce the discharge capacity of the valve.

No valve or other obstruction is to be placed between the relief valve and the tank. Do not connect tubing directly to discharge drain unless a 6" air gap is provided. To prevent bodily injury, hazard to life, or property damage, the relief valve must be allowed to discharge water in quantities should circumstances demand. If the discharge pipe is not connected to a drain or other suitable means, the water flow may cause property damage.

## The Discharge Pipe:

- Must not be smaller in size than the outlet pipe size of the valve, or have any reducing couplings or other restrictions.
- Must not be plugged or blocked.
- Must be of material listed for hot water distribution.
- Must be installed so as to allow complete drainage of both the temperature-pressure relief valve, and the discharge pipe.
- Must terminate at an adequate drain.
- Must not have any valve between the relief valve and tank.

## WARNING

**HAZARD OF ELECTRICAL SHOCK!** Before removing any access panels or servicing the water heater, make sure the electrical supply to the water heater is turned "OFF". Failure to do this could result in DEATH, SERIOUS BODILY INJURY, OR PROPERTY DAMAGE.

## WARNING

**HOTTER WATER CAN SCALD:** Water heaters are intended to produce hot water. Water heated to a temperature which will satisfy clothes washing, dish washing, and other sanitizing needs can scald and permanently injure you upon contact. Some people are more likely to be permanently injured by hot water than others. These include the elderly, children, the infirm, or physically/mentally handicapped. If anyone using hot water in your home fits into one of these groups or if there is a local code or state law requiring a certain temperature water at the hot water tap, then you must take special precautions. In addition to using the lowest possible temperature setting that satisfies your hot water needs, some type of tempering device, such as a mixing valve, should be used at the hot water taps used by these people or at the water heater. Mixing valves are available at plumbing supply or hardware stores. Follow manufacturers instructions for installation of the valves. Before changing the factory setting of the thermostat, read the "Temperature Regulation" section in this manual.

## WARNING

**WATER HEATERS EQUIPPED FOR ONE VOLTAGE ONLY:** This water heater is equipped for one type voltage only. Check the rating plate near the bottom access panel for the correct voltage. DO NOT use this water heater with any voltage other than the one shown on the model rating plate. Failure to use the correct voltage can cause problems which can result in DEATH, SERIOUS BODILY INJURY, OR PROPERTY DAMAGE. If you have any questions or doubts consult your electric company.

## WARNING

**INSULATING JACKETS:** When installing an external water heater insulation jacket on an electric water heater:  
a. DO NOT cover the temperature-pressure relief valve.  
b. DO NOT put insulation over the access covers or any access areas.  
c. DO NOT cover or remove operating instructions, and safety related warning labels and materials affixed to the water heater.

## WARNING

Do not use this appliance if any part of it has been under water. An electrical short or malfunction could occur. The water heater should be replaced.

## CAUTION

**WATER HEATERS EVENTUALLY LEAK:** Installation of the water heater must be accomplished in such a manner that if the tank or any connections should leak, the flow of water will not cause damage to the structure. When such locations cannot be avoided, a suitable drain pan should be installed under the water heater. Drain pans are available at your local Sears Store. Such a drain pan must be piped to an adequate drain. Under no circumstances is the manufacturer or Sears to be held liable for any water damage in connection with this water heater.

# Table of Contents

2	General Safety
3	Table of Contents
4	Introduction
4	Specifications
4	Preparing for the New Installation
5	Materials Needed
5	Basic Tools
6	Removing the Old Water Heater
7	Locating the New Water Heater
7	Facts to Consider About the Location
7	Facts to Consider About the Convertible Lower Element
8-15	Installing the New Water Heater
8	Water Piping
9	Temperature-Pressure Relief Valve
10	Filling the Water Heater
10-12	Converting the Lower Element
13	Wiring Diagrams
14	Wiring
15	Installation Checklist
15, 16	Temperature Regulation
16	Thermostats
16	Temperature Settings
16	Thermostat Adjustment
17, 18	For Your Information
17	Start Up Conditions
17	Thermal Expansion
17	Strange Sounds
17, 18	Operational Conditions
17	Rumbling Noise
17	High Temperature Shut Off System
17	Not Enough or No Hot Water
18	Water Is Too Hot
18	Indicator Light
19-22	Periodic Maintenance
19	Temperature-Pressure Relief Valve Operation
19	Draining
20-22	Element Cleaning/Replacement
22	Drain Valve Washer Replacement
22	Service
23	Leakage Checkpoints
24-27	Repair Parts
28	Warranty
28	About Your Warranty
28	Sears Installation Policy
28	Sears Installation Warranty

# Introduction

**Thank You** for purchasing a Sears water heater. Properly installed and maintained, it should give you years of trouble free service. If you should decide that you want the new water heater professionally installed by Sears contact the local Sears Service Center or any Sears store. They will arrange for prompt, quality installation by Sears authorized contractors.

**Abbreviations Found In This Instruction Manual**  
 U.L.-Underwriters Laboratories, 333 Pfingsten Rd., Northbrook, IL 60062  
 National Electrical Code-This publication is available from your local government or public library or electric company or by writing to U.L. above.  
 A.N.S.I.-American National Standards Institute

# Specifications

MODEL NUMBER	TANK CAPACITY IN GALLONS	DIMENSIONS IN INCHES		RECOVERY RATE GAL. PER HOUR @90°F. RISE	ELEMENT WATTAGE AT 240 VOLTS		MINIMUM WIRE SIZE* (GAUGE)	MAXIMUM FUSE OR CIRCUIT BREAKER SIZE (AMPS)
		DIAMETER	HEIGHT		UPPER	LOWER		
153.310360	30	19	45%	17.3	3800	3800	12	20
153.320360	30	19	59%	25.0	3800	5500	10	30
153.310460	40	19	59%	17.3	3800	3800	12	20
153.320460	40	19	59%	25.0	3800	5500	10	30
153.320530 HT	52	21	59%	17.3	3800	3800	12	20
153.310560	52	21	59%	17.3	3800	3800	12	20
153.320560	52	21	59%	25.0	3800	5500	10	30
153.320630 HT	66	23	60%	17.3	3800	3800	12	20
153.320630 HT	66	23	60%	25.0	3800	5500	10	30
153.320830 HT	82	25	61%	17.3	3800	3800	12	20
153.320830 HT	82	25	61%	25.0	3800	5500	10	30
153.310860	82	25	60%	17.3	3800	3800	12	20
153.320860	82	25	60%	25.0	3800	5500	10	30

\*Wiring size based on standard 60°C. copper wire. If distance from fuse box to water heater is more than 90 feet, refer to your local electrical code.

# Preparing for the New Installation

1. Read the "General Safety" section, page 2 of this manual first and then the entire manual carefully. If you don't follow the safety rules, the water heater will not operate properly. It could cause DEATH, SERIOUS BODILY INJURY AND/OR PROPERTY DAMAGE. This manual contains instructions for the installation, operation, and maintenance of this electric water heater. It also contains warnings throughout the manual that you must read and be aware of. All warnings and all instructions are essential to the proper operation of the water heater and your safety. Since we cannot put everything on the first few pages, READ THIS ENTIRE MANUAL BEFORE ATTEMPTING TO INSTALL OR OPERATE THE WATER HEATER.
2. The installation must conform with the instructions in this manual; electric company rules; and Local Codes, or in the absence of Local Codes, with the latest edition of the National Electrical Code. This publication is available from your local government or public library or electric company or by writing Underwriters
3. If after reading this manual you have any questions or do not understand any portion of the instructions, call Sears Service Center.
4. Carefully plan the place where you are going to put the water heater. Correct electrical wiring and connections are very important in preventing death from possible electrical shock and fires. Examine the location to ensure the water heater complies with the "Locating the New Water Heater" section.
5. For California installation this water heater must be braced, anchored, or strapped to avoid falling or moving during an earthquake. See instructions for correct installation procedures. Instructions may be obtained from your local dealer, wholesaler, public utilities or California Office of the State Architect, 400 P Street, Sacramento, CA 95814

# Materials and Basic Tools Needed

## Materials Needed

To simplify the installation Sears has available the installation parts shown below. You may or may not need all of these materials, depending on your type of installation.

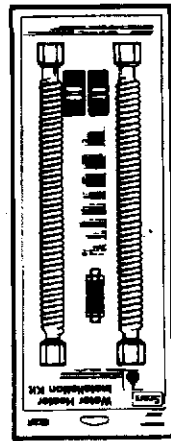

WATER HEATER INSTALLATION KIT WITH FLEXIBLE CONNECTORS FOR 3/4" GALVANIZED OR 1/2" PLUMBING



COMPRESSION COUPLINGS FOR CONNECTING TO COPPER PLUMBING WITHOUT SWEAT SOLDERING

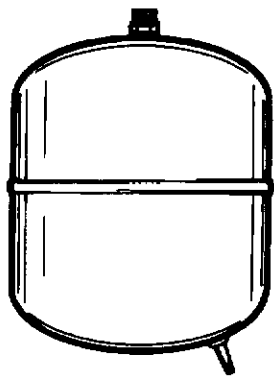

EXPANSION TANKS FOR THERMAL EXPANSION AND 5 GALLON CAPACITY THROUGH LOCAL SEARS SERVICE CENTERS

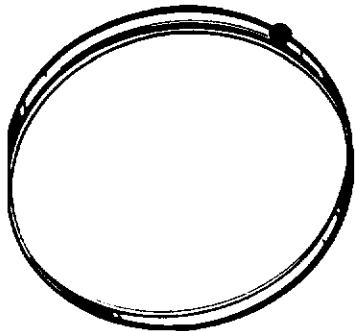

28" DIAMETER DRAIN PAN FOR WATER HEATERS 26" IN DIAMETER AND UNDER

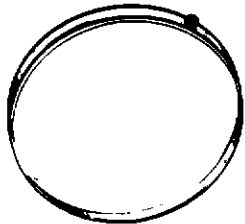

20" DIAMETER DRAIN PAN FOR WATER HEATERS 18" IN DIAMETER AND UNDER

## Basic Tools

You may or not need all of these tools, depending on your type of installation. These tools can be purchased at your local Sears store.

- Pipe Wrench (2)
- Screwdriver
- 6 Foot Tape or Folding Rule
- Garden Hose
- Drill
- Pipe Dope or Teflon Tape

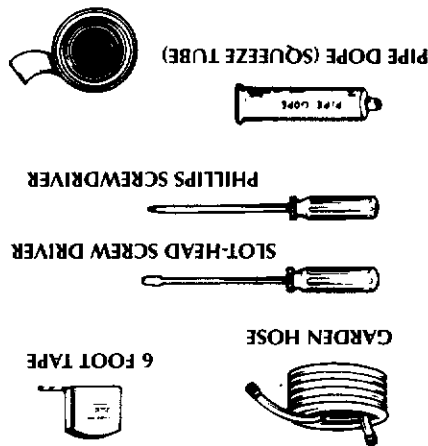

ROLL OF TEFLON TAPE (Use only on water connections)

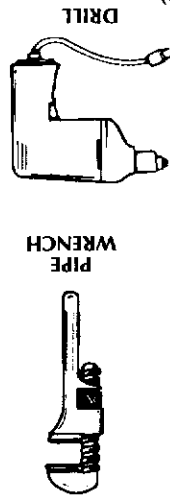

DRILL

PIPE WRENCH

## ADDITIONAL TOOLS NEEDED WHEN SWEAT SOLDERING

- Tubing Cutters or Hacksaw
- Propane Torch
- Soft Solder
- Solder Flux
- Emery Cloth
- Wire Brushes

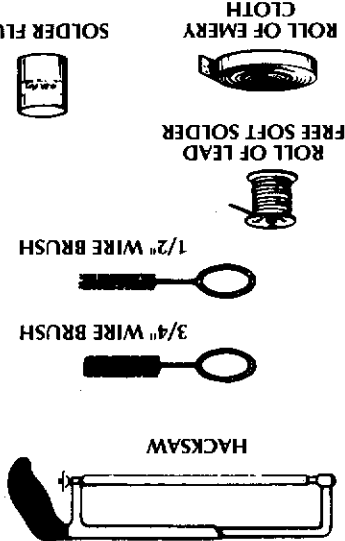

HACKSAW

3/4" WIRE BRUSH

1/2" WIRE BRUSH

ROLL OF LEAD

FREE SOFT SOLDER

ROLL OF EMERY CLOTH

SOLDER FLUX

TUBING CUTTER

PROPANE TORCH



# Removing the Old Water Heater

Mineral buildup or sediment may have accumulated in the old water heater. This causes the water heater to be much heavier than normal and this residue, if spilled out, could cause staining.

**CAUTION**

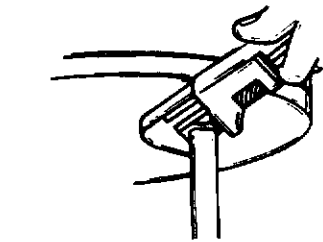

a. If you have copper piping to the water heater, the two copper water pipes can be cut with a hacksaw approximately four inches away from where they connect to the water heater. This will avoid cutting off the pipes too short. Additional cuts can be made later if necessary. Disconnect the temperature-pressure relief valve drain line. When the water heater is drained, disconnect the hose from the drain valve. Close the drain valve. The water heater is now completely disconnected and ready to be removed.

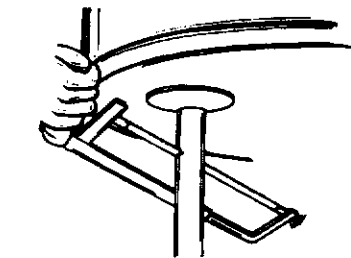

b. If you have galvanized pipe to the water heater, loosen the two galvanized pipes with a pipe wrench at the union in each line. Also disconnect the piping remaining to the water heater. These pieces should be saved since they may be needed when reconnecting the new water heater. Disconnect the temperature-pressure relief valve drain line. When the water heater is drained, disconnect the hose from the drain valve. Close the drain valve. The water heater is now completely disconnected and ready to be removed.

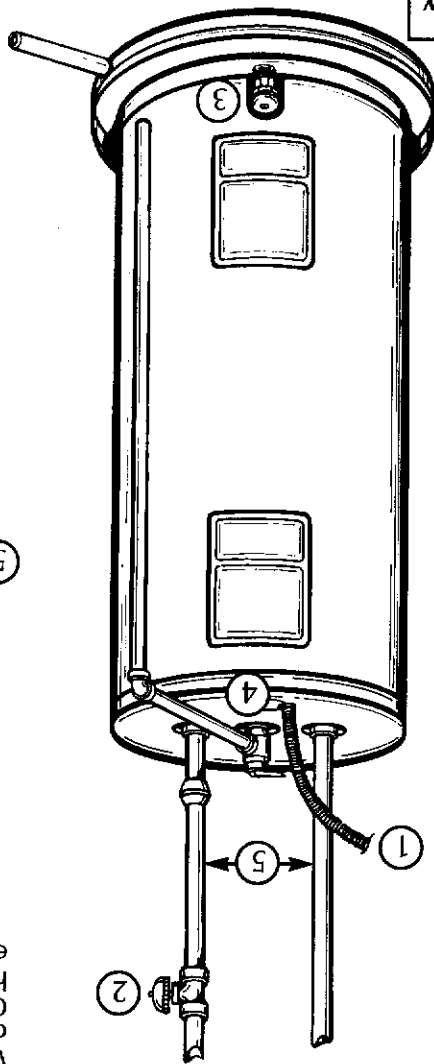

1 Turn "OFF" electrical supply to the water heater.

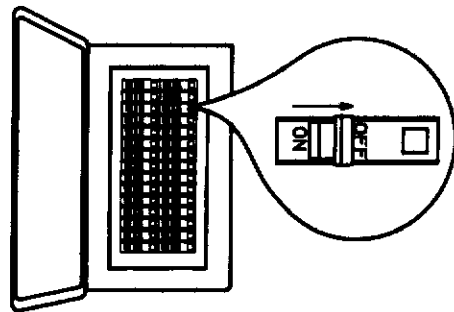

2 Turn "OFF" the water supply to the water heater at the water shutoff valve or water meter.

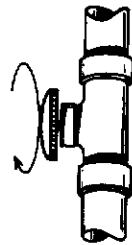

3 Attach a hose to the water heater drain valve and put the other end in a floor drain or outdoors. Open the water heater drain valve. Open a nearby hot water faucet which will relieve pressure in the water heater and speed draining.

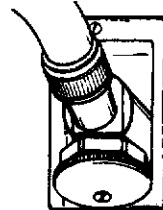

**WARNING**  
The water passing out of the drain valve may be extremely hot. To avoid being scalded, make sure all connections are tight and that the water flow is directed away from any person.

4 Check again to make sure the electrical supply is turned "OFF" to the water heater. Then disconnect the electrical supply connection from the water heater junction box.

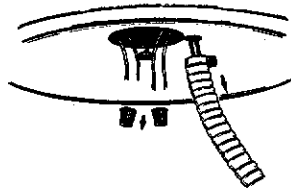

# Locating the New Water Heater

## Facts to Consider About the Location

You should carefully choose an indoor location for the new water heater, because the placement is a very important consideration for the safety of the occupants in the building and for the most economical use of the appliance. This water heater is not intended for outdoor installation.

Whether replacing an old water heater or putting the water heater in a new location, the following critical points must be observed.

1. The location selected should be indoors as close to and as centralized with the water piping system as possible. This water heater, as well as all water heaters, will eventually leak. Do not install without adequate drainage provisions where water flow will cause damage.

### CAUTION

**WATER HEATERS EVENTUALLY LEAK:** Installation of the water heater must be accomplished in such a manner that if the tank or any connections should leak, the flow of water will not cause damage to the structure. When such locations cannot be avoided, a suitable drain pan should be installed under the water heater. Drain pans are available at your local Sears Store. Such a drain pan must be piped to an adequate drain. Under no circumstances is the manufacturer or Sears to be held liable for any water damage in connection with this water heater.

### CAUTION

**INSTALLATION IN RESIDENTIAL GARAGES:** The water heater must be located and/or protected so it is not subject to physical damage by a moving vehicle.

2. The location selection must provide adequate clearance for servicing and proper operation of the water heater.

## Facts to Consider About The Convertible Lower Element

The **Upper Element** (if a double element model), is a conventional 3800 watt element which only operates at its rated wattage on 240 volts. (See rating plate on water heater).

The **Lower Element** of the water heater can be converted from operation at 3800 watts to 5500 watts on a 240 volt system.

Read and follow water heater warnings and instructions after reading these instructions in this manual, if you do not understand any portion, call Sears Service Center.

### WARNING

Before making the conversion to 5500 watts, check the (1) power supply...must be 240 volts, (2) wiring...10 gauge AWG @ type TW, 60c or equivalent, and (3) Circuit breakers or fusing...capable of 30 amp loading. Also, the installation must conform with this manual, local codes and electric utility rules. Failure to comply can result in DEATH, SERIOUS BODILY INJURY OR PROPERTY DAMAGE.

ELECTRIC WATER HEATER				ELECTRIC WATER HEATER			
ECO INSTALLED				ELECTRIC WATER HEATER			
MAY BE DAMAGED BY WATER AL				ELECTRIC WATER HEATER			
RE-CONVERSION				ELECTRIC WATER HEATER			
SERIAL NO. MODEL NUMBER				ELECTRIC WATER HEATER			
CAPACITY				ELECTRIC WATER HEATER			
U.S. GAL.				ELECTRIC WATER HEATER			
FACTORY EQUIPPED WITH				ELECTRIC WATER HEATER			
UPPER ELEMENT LOWER ELEMENT				ELECTRIC WATER HEATER			
MAXIMUM VOLTAGE				ELECTRIC WATER HEATER			
CHECK (✓) HERE				ELECTRIC WATER HEATER			
FACTORY EQUIPPED AS F.S.L.				ELECTRIC WATER HEATER			
150				ELECTRIC WATER HEATER			
AC ONLY INSTALLED AS				ELECTRIC WATER HEATER			
CHECK (✓) HERE				ELECTRIC WATER HEATER			
MAXIMUM WATTAGE				ELECTRIC WATER HEATER			
UPPER ELEMENT LOWER ELEMENT				ELECTRIC WATER HEATER			
WATTS WATTS				ELECTRIC WATER HEATER			
OPTIONAL WATTAGE				ELECTRIC WATER HEATER			
UPPER ELEMENT LOWER ELEMENT				ELECTRIC WATER HEATER			
MAXIMUM WATTAGE				ELECTRIC WATER HEATER			
CHECK (✓) HERE				ELECTRIC WATER HEATER			
IF CONVERTED				ELECTRIC WATER HEATER			
SEE INSTRUCTION				ELECTRIC WATER HEATER			
WARNING				ELECTRIC WATER HEATER			

**NOTE:** Whether or not the element conversion is made the model rating plate must be marked. Using a hard point ink pen, check the appropriate block within the model rating plate, which is located adjacent to the lower access panel.

# Installing the New Water Heater

## Water Piping

### WARNING

**HOTTER WATER CAN SCALD:** Water heaters are intended to produce hot water. Water heated to a temperature which will satisfy clothes washing, dish washing, and other sanitizing needs can scald and permanently injure you upon contact. Some people are more likely to be permanently injured by hot water than others. These include the elderly, children, the infirm, or physically/mentally handicapped. If anyone using hot water in your home fits into one of these groups or if there is a local code or state law requiring a certain temperature water at the hot water tap, then you must take special precautions. In addition to using the lowest possible temperature setting that satisfies your hot water needs, some type of tempering device, such as a mixing valve, should be used at the hot water taps used by these people or at the water heater. Mixing valves are available at plumbing supply or hardware stores. Follow manufacturers instructions for installation of the valves. Before changing the factory setting on the thermostat, read the "Temperature Regulation" section in this manual.

The illustration shows the attachment of the water piping to the water heater. The water heater is equipped with 1/2 inch water connections.

If a water heater is installed in a closed water supply system, such as one having a back-flow preventer, check valve, water meter with a check valve, etc., in the cold water supply, means shall be provided to control thermal expansion. Contact the local utility or local Sears Service Center on how to control this situation.

**NOTE:** If using copper tubing, solder tubing to an adapter before attaching the adaptor to the cold water line directly to the cold water inlet. It will harm the dip tube and damage the tank.

1. Look at the top cover of the water heater. The hot water outlet is marked hot. Put two or three turns of teflon tape around the threaded end of the threaded-to-sweat coupling and around both ends of the 1/2" threaded heat trap nipple. Using flexible connectors, connect the hot water pipe to the hot water outlet of the water heater. The illustration shows the proper installation of two heat traps for all Residential Electric models. This gives you the greatest amount of energy savings by keeping the heat within the tank during stand-by periods.

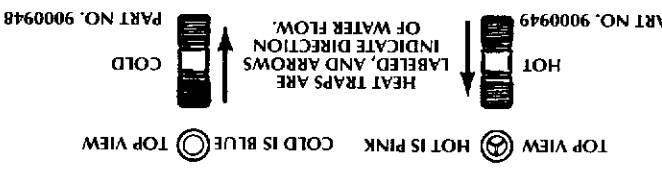

**NOTE:** Do not apply heat to the heat traps while making sweat connections to the water heater. Sweat tubing to pipe joint compound on the threads of the fittings that is resistant to the action of liquefied petroleum (L.P.) gases. Do not remove end inserts.

2. Look at the top cover of the water heater. The cold water inlet is marked cold. Put two or three turns of teflon tape around the threaded end of the threaded-to-sweat coupling and around both ends of the 1/2" threaded heat trap nipple. Using flexible connectors, connect the cold water pipe to the cold water inlet of the water heater.

**NOTE:** Your water heater is insulated to minimize heat loss from the tank. Further reduction in heat loss can be accomplished by insulating the hot water lines from the water heater.

### INSTALLATION COMPLETED USING SEARS INSTALLATION KIT.

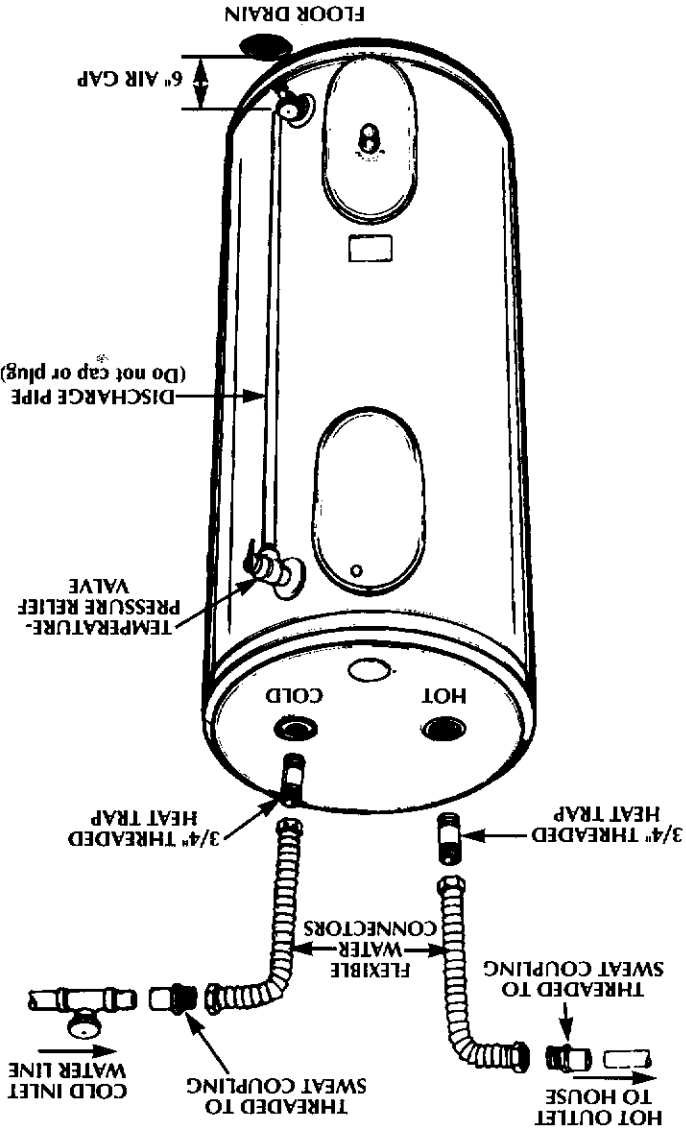



# Installing the New Water Heater (cont'd)

## Temperature-Pressure Relief Valve

### WARNING

At the time of manufacture this water heater was provided with a combination temperature-pressure relief valve certified by a nationally recognized testing laboratory that maintains periodic inspection of production of listed equipment or materials, as meeting the requirements for Relief Valves and Automatic Gas Shutoff Devices for Hot Water Supply Systems, and the latest edition of ANSI Z21.22 and the code requirements of ASME. If replaced, the valve must meet the requirements of local codes, but not less than a combination temperature and pressure relief valve certified as meeting the requirements for Relief Valves and Automatic Gas Shutoff Devices for Hot Water Supply Systems, ANSI Z21.22 by a nationally recognized testing laboratory that maintains periodic inspection of production of listed equipment or materials. The valve must be marked with a maximum set pressure not to exceed the marked hydrostatic working pressure of the water heater (150 lbs./sq. in.) and a discharge capacity not less than the water heater input rate as shown on the model rating plate. (Electric heaters - watts divided by 1000 x 3415 equal BTU/hr. rate.)

Your local jurisdictional authority, while mandating the use of a temperature-pressure relief valve complying with ANSI Z21.22 and ASME, may require a valve model different from the one furnished with the water heater.

Compliance with such local requirements must be satisfied by the installer or end user of the water heater with a locally prescribed temperature-pressure relief valve installed in the designated opening in the water heater in place of the factory furnished valve.

For safe operation of the water heater, the relief valve must not be removed from its designated opening or plugged. The temperature-pressure relief valve must be installed directly into the fitting of the water heater and provide tubing so that any discharge will exit only within 6 inches above, or at any distance below the structural floor. Be certain that no contact is made with any live electrical part. The discharge opening must not be blocked or reduced in size under any circumstances. Excessive length, over 15 feet, or use of more than two elbows can cause restriction and reduce the discharge capacity of the valve.

No valve or other obstruction is to be placed between the relief valve and the tank. Do not connect tubing directly to the discharge drain unless a 6" air gap is provided. To prevent bodily injury, hazard to life, or property damage, the relief valve must be allowed to discharge water in quantities should circumstances demand. If the discharge pipe is not connected to a drain or other suitable means, the water flow may cause property damage.

The Discharge Pipe:  
 —Must not be smaller in size than the outlet pipe size of the valve, or have any reducing couplings or other restriction.  
 —Must be of material listed for hot water distribution.  
 —Must be installed so as to allow complete drainage of both the temperature-pressure relief valve, and the discharge pipe.  
 —Must terminate at an adequate drain.  
 —Must not have any valve between the relief valve and tank.

The temperature-pressure relief valve must be manually operated at least once a year. Caution should be taken to ensure that (1) no one is in front of or around the outlet of the temperature-pressure relief valve discharge line, and (2) the water manually discharged will not cause any bodily injury or property damage because the water may be extremely hot.

If after manually operating the valve, it fails to completely rest and continues to release water, immediately, close the cold water inlet to the water heater, follow the draining instructions, and replace the temperature-pressure relief valve with a new one.

### WARNING

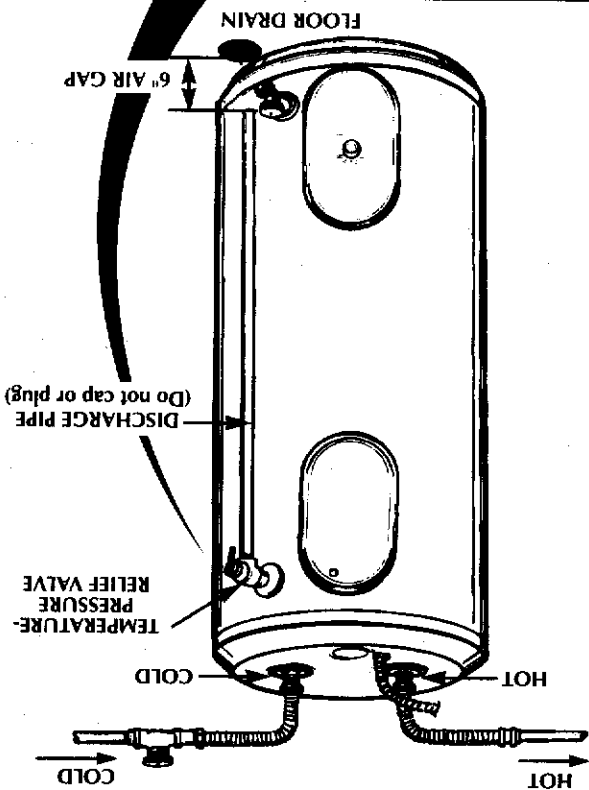

### WARNING "RELIEF VALVE OPENING"

This water heater is provided with a combination Temperature-Pressure Relief Valve listed as complying with the standard for Relief Valves and Automatic Gas Shutoff Devices for Hot Water Supply Systems, ANSI Z21.22 and the code requirements of ASME.

Your local jurisdictional authority, while mandating the use of a Temperature-Pressure Relief Valve complying with ANSI Z21.22 and ASME, may require a valve model different from the one furnished with the water heater. Compliance with such local requirements must be satisfied by the installer or end user of the water heater with a locally prescribed Temperature-Pressure Relief Valve installed in the designated opening in the water heater.

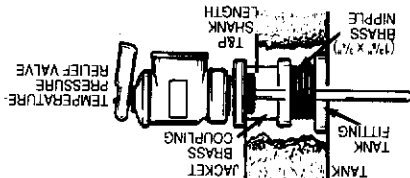

- If a short shank (less than 2" temperature-pressure relief valve is to be installed (as shown), a nipple and coupling must be used.
- If a long shank (2" or longer) is to be installed, do not use the nipple and coupling.

Install Temperature-Pressure protective equipment required by local codes, but not less than a combination Temperature-Pressure Relief Valve certified as meeting the requirements for Relief Valves and Automatic Gas Shutoff Devices for Hot Water Supply Systems, ANSI Z21.22 by a nationally recognized testing laboratory that maintains periodic inspection of production of listed equipment or materials. The valve must be oriented, provided with tubing, or otherwise installed so that discharge can exit only within 6 inches above, or at any distance below the structural floor, and cannot contact any live electrical part.

For safe operation of the water heater, the Relief Valve must not be removed or plugged. See manual heading - "Temperature-Pressure Relief Valve" for installation and maintenance of Relief Valve, discharge pipe and other safety precautions.

# Installing the New Water Heater (cont'd)

## Filling the Water Heater

1. Close the water heater drain valve by turning the handle to the right (clockwise). The drain valve is on the lower front of the water heater.
  2. Open the cold water supply valve to the water heater.
  - NOTE: The cold water supply valve must be left open when the heater is in use.
  3. To insure complete filling of the tank, allow air to exit by opening the nearest hot water faucet. Allow water to run until a constant flow is obtained. This will let air out of the water heater and the piping.
- Never use this water heater unless it is completely full of water. To prevent damage to the tank and heating element, the tank must be filled with water. Water must flow from the hot water faucet before turning "ON" power.

## Converting the Lower Element

These instructions only cover the conversion of the convertible element, read this entire manual before attempting to install or operate the water heater. The water heater is set to operate at 3800 watts. The lower element can be converted to operate at 5500 watts. Refer to the "Facts to Consider About the Convertible Lower Element" section.

The Upper Element, (if a double element model) is a conventional 3800 watt element which only operates at its rated wattage on 240 volts. (See rating plate on water heater).

The Lower Element of the water heater can be converted from operation at 3800 watts to 5500 watts on a 240 volt system.

If after reading these instructions and this manual, if you do not understand any portion, call Sears Service Center.

### WARNING

Before making the conversion to 5500 watts, check the (1) power supply...must be 240 volts, (2) wiring...10 gauge AWC @ type T.W. 60c or equivalent, and (3) Circuit breakers or fusing...capable of 30 amp loading. Also, the installation must conform with this Manual, local codes and electric utility rules. Failure to comply can result in DEATH, SERIOUS BODILY INJURY OR PROPERTY DAMAGE.

NOTE: Whether or not the element conversion is made the model rating plate, which is located adjacent to the lower access panel.

Necessary element conversion parts are located in a small bag contained within the large plastic manual envelope attached to the side of the water heater.

### CONVERSION PARTS

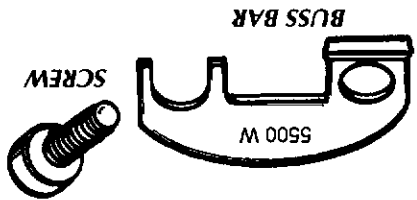

1. Before beginning the conversion turn "OFF" electric power supply to the water heater.

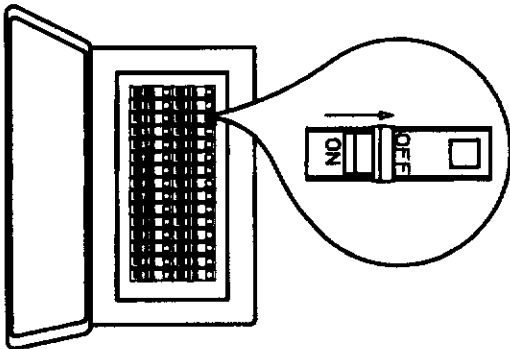

### WARNING

HAZARD OF ELECTRICAL SHOCK! Before removing any access panels or servicing the water heater, make sure the electrical supply to the water heater is turned "OFF". Failure to do this could result in DEATH, SERIOUS BODILY INJURY, OR PROPERTY DAMAGE.

# Installing the New Water Heater (cont'd)

2. The convertible element is located behind the lower access panel of the water heater. Remove the two screws securing the access panel, and remove panel.

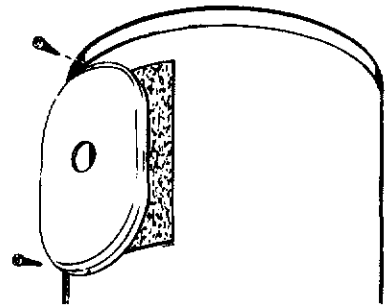

3. Remove the adjustment dial from the thermostat by gently pulling it directly away from the thermostat.

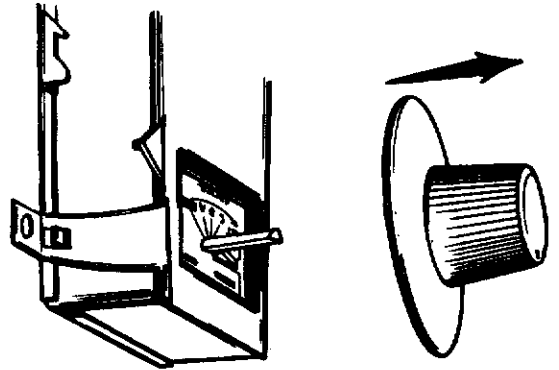

4. Open the flap of insulation to expose the opening.

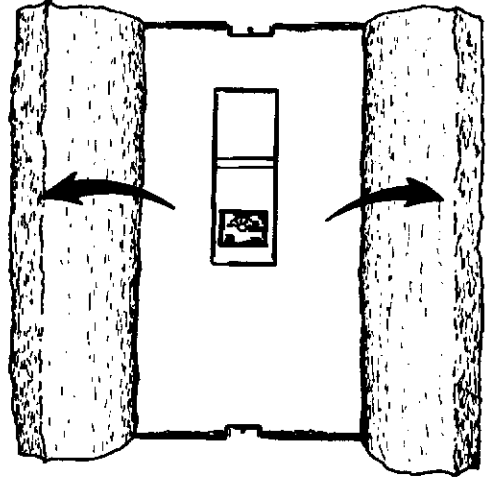

5. The plastic terminal cover is clipped into the thermostat and held by a tab on the right side of the thermostat. Bend the plastic terminal cover away from the thermostat, being careful not to pull the thermostat from its bracket nor bend the thermostat bracket, remove the terminal cover.

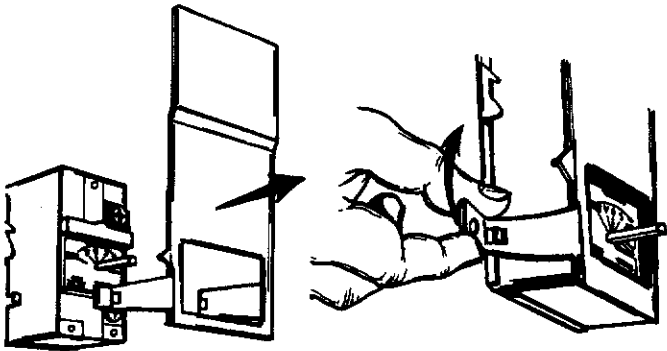

6. Remove the screws from terminal 2 of the element, and move the looped end of the wire aside.

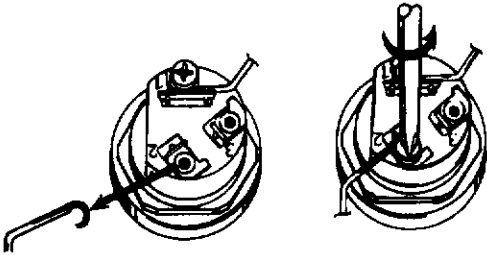

7. The buss bar is labeled 5500 W. Place the buss bar over terminals 2 and 3 with the 5500 W visible. Install the extra screw provided into terminal 3.

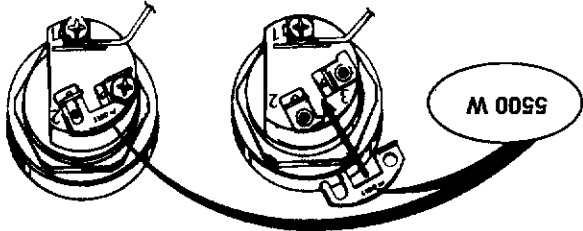

8. The wire removed from terminal 2 has a looped end. It must remain looped and now be placed (as shown) on top of the buss bar, over the opening of terminal 2, and secured using the remaining screw.

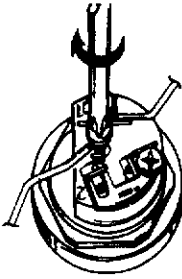

# Installing the New Water Heater (cont'd)

## Converting the Lower Element (cont'd)

9. Tighten terminals 2 and 3 to ensure proper electrical connection.

**WARNING**  
Failure to tighten terminal screws can cause a fire which can result in DEATH, SERIOUS BODILY INJURY, OR PROPERTY DAMAGE.

10. Replace terminal cover on the thermostat, making sure the notch is in place over the tab.

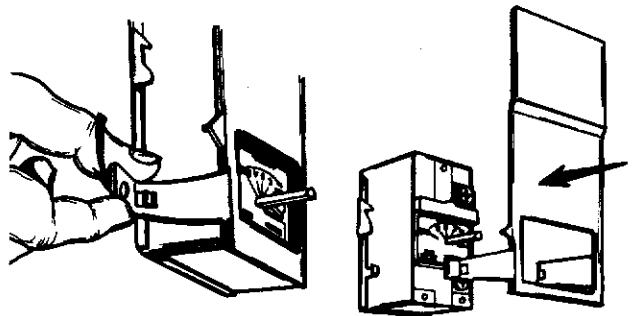

**WARNING**  
Make sure the thermostat is flush against the tank, the terminal cover is in place, and the insulation is replaced. Failure to do so can result in DEATH, SERIOUS BODILY INJURY, OR PROPERTY DAMAGE.

11. Fold the insulation back in place so that it completely covers the thermostat and element.

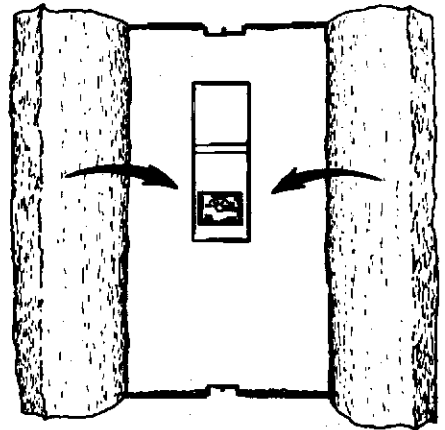

12

12. The adjustment dial has a "D" shaped opening that matches a "D" shaped shaft on the thermostat. Align the opening in the dial to the shaft and gently push the dial onto the shaft.

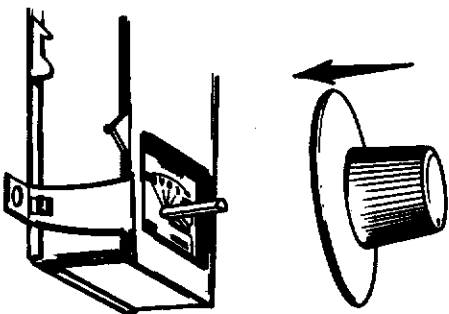

13. Replace the access panel.

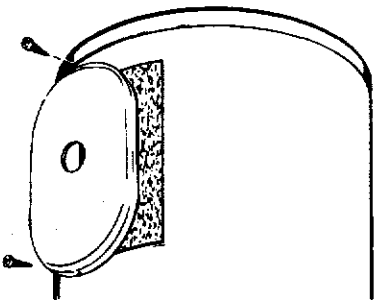

14. Complete wiring to the water heater, or if completed, turn "ON" electric power to the water heater after filling the tank with water.

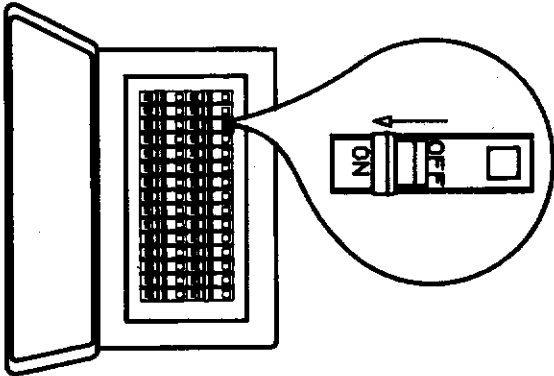

### CAUTION

Never use this water heater unless it is completely full of water. To prevent damage to the tank and heating element, the tank must be filled with water. Water must flow from the hot water faucet before turning "ON" power.

# Installing the New Water Heater (cont'd)

## Wiring Diagrams

STANDARD WIRING FOR  
2 WIRE LEAD WATER HEATERS  
NON-SIMULTANEOUS OPERATION  
240 VOLT DOUBLE ELEMENT

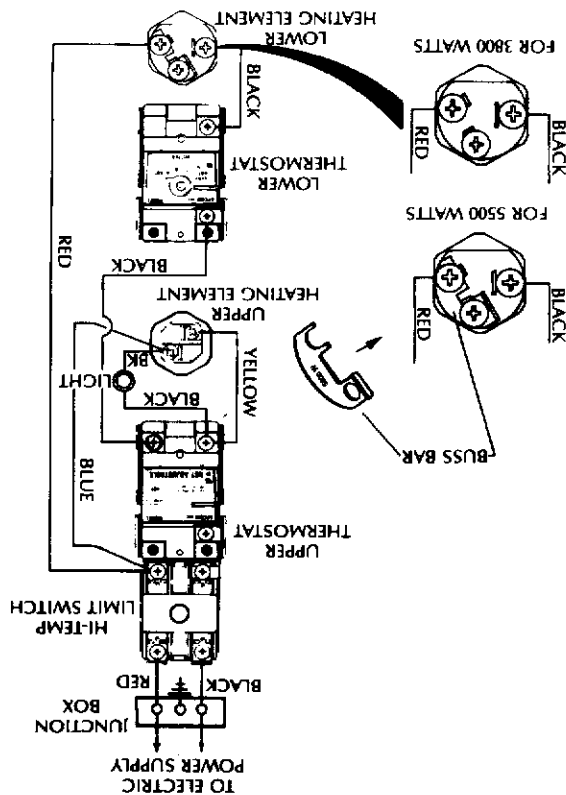

WIRING FOR 3 WIRE LEAD WATER HEATERS  
NON-SIMULTANEOUS OPERATION  
240 VOLT DOUBLE ELEMENT

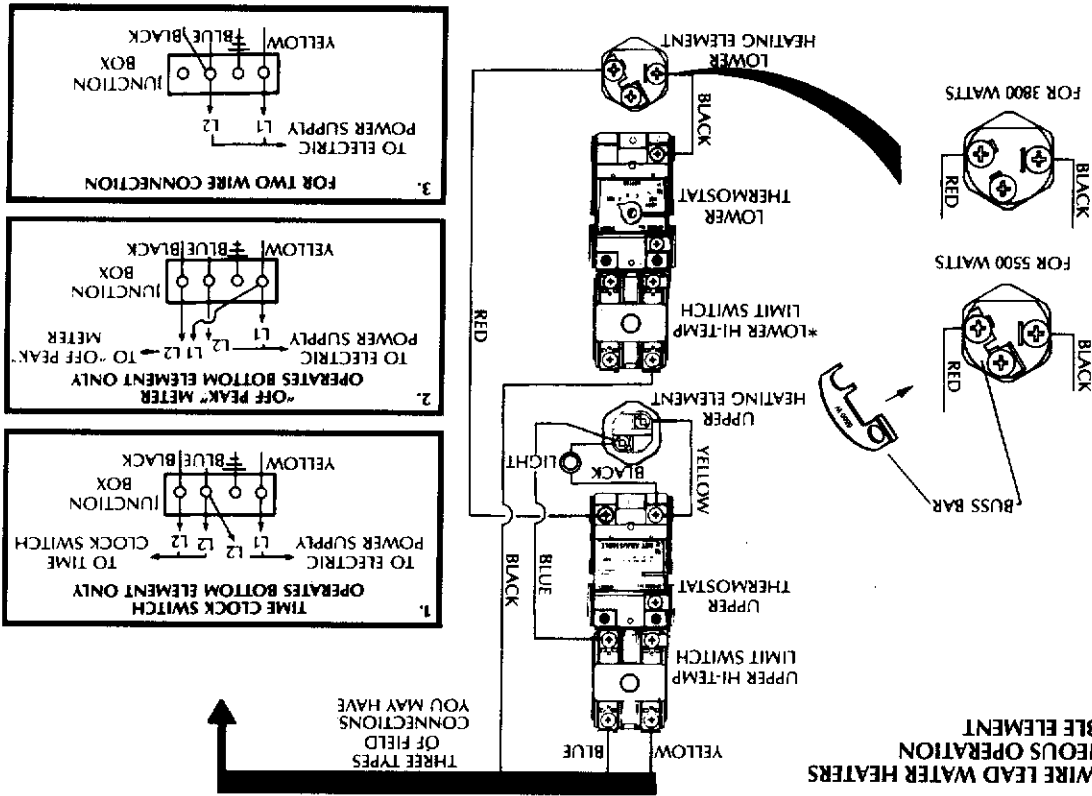

\*Note: Some Lower Hi-Temp Limit Switches may have 4 terminals. Use only the 2 terminals on left.

# Installing the New Water Heater (cont'd)

## Wiring

### CAUTION

Never use this water heater unless it is completely full of water. To prevent damage to the tank and heating elements, the tank must be filled with water. Water must flow from the hot water faucet before turning on power.

You must provide all wiring of the proper size outside of the water heater. You must obey local codes and electric company requirements when you install this wiring.

If you are not familiar with electric codes and practices, or if you have any doubt, even the slightest doubt, in your ability to connect the wiring to this water heater, obtain the service of a competent electrician. Contact your Sears salesperson to arrange for a professional electrician.

### WARNING

**WATER HEATERS EQUIPPED FOR ONE VOLTAGE ONLY:** This water heater is equipped for one type voltage panel for the correct voltage. **DO NOT** use this water heater with any voltage other than the one shown on the model rating plate. Failure to use the correct voltage can cause problems which can result in **DEATH, SERIOUS BODILY INJURY, OR PROPERTY DAMAGE.** If you have any questions or doubts consult your electric company.

If wiring from your fuse box or circuit breaker box was aluminum for your old water heater, replace it with copper wire. If you wish to reuse the existing aluminum wire, have the connection at the water heater made by a competent electrician. Contact your Sears salesperson to arrange for a professional electrician.

### CAUTION

1. Provide a way to easily shut off the electric power when working on the water heater. This could be with a circuit breaker or fuse block in the entrance box or a separate disconnect switch.

2. Install and connect a circuit directly from the main fuse or circuit breaker box. This circuit must be the right size and have its own fuse or circuit breaker. Refer to the chart in the "Specifications" section for the correct size wire and fuse or circuit breaker.

3. If metal conduit is used for the grounding conductor:
  - A. The grounding electrode conductor shall be of copper, aluminum, or copperclad aluminum. The material shall be of one continuous length without a splice or joint.
  - B. Rigid metal conduit, intermediate metal conduit, or electrical metallic tubing may be used for the grounding means if conduit or tubing is terminated in fittings approved for grounding.
  - C. Flexible metal conduit or flexible metallic tubing shall be permitted for grounding if all the following conditions are met:
    1. The length in any ground return path does not exceed 6 feet.
    2. The circuit conductors contained therein are protected by overcurrent devices rated at 20 amperes or less.
    3. The conduit or tubing is terminated in fittings approved for grounding.
- For complete grounding details and all allowable exceptions, refer to the latest edition of the National Electrical Code.
4. A standard 1/2" conduit opening has been made in the water heater junction box for the conduit connection.
5. Use wire nuts and connect the power supply wiring to the wires inside the water heater's junction box.
6. The water heater must be electrically "grounded" by the installer. A green ground screw has been provided on the water heater's junction box. Connect ground wire to this location.
7. Replace the wiring junction cover using the screw provided.

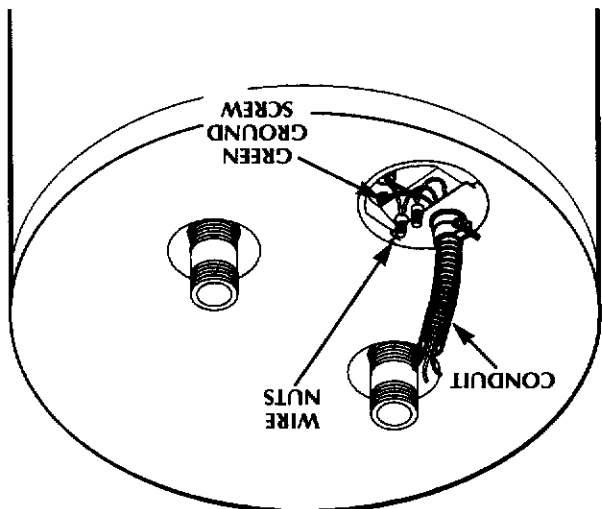

# Installing the New Water Heater (cont'd)

## Installation Checklist

1. Whether or not the element conversion is made, the model rating plate must be marked. Using a hard point ink pen, check the appropriate block within the model rating plate, which is located adjacent to the lower access panel.
2. Is the fuse or circuit breaker size correct as shown in the chart in the "Specifications" section?
3. Are the wires from the circuit breaker or fuse service to the water heater's junction box on the correct wire size (gauge) as shown in the chart in the "Specifications" section?
4. Is the new temperature-pressure relief valve properly installed, and piped to an adequate drain? See "Temperature-Pressure Relief Valve" section.
5. Is the water heater completely filled with water? See "Filling the Water Heater" instructions in the "Installing the New Water Heater" section.
6. Will a water leak damage anything? See "Locating the New Water Heater" section.
7. Are the cold and hot water lines connected to the water heater correctly? See "Water Piping" instructions in the "Installing the New Water Heater" section.
8. Is there adequate clearance for maintenance around the water heater?
9. Do you need to call your electric company to check your wiring?

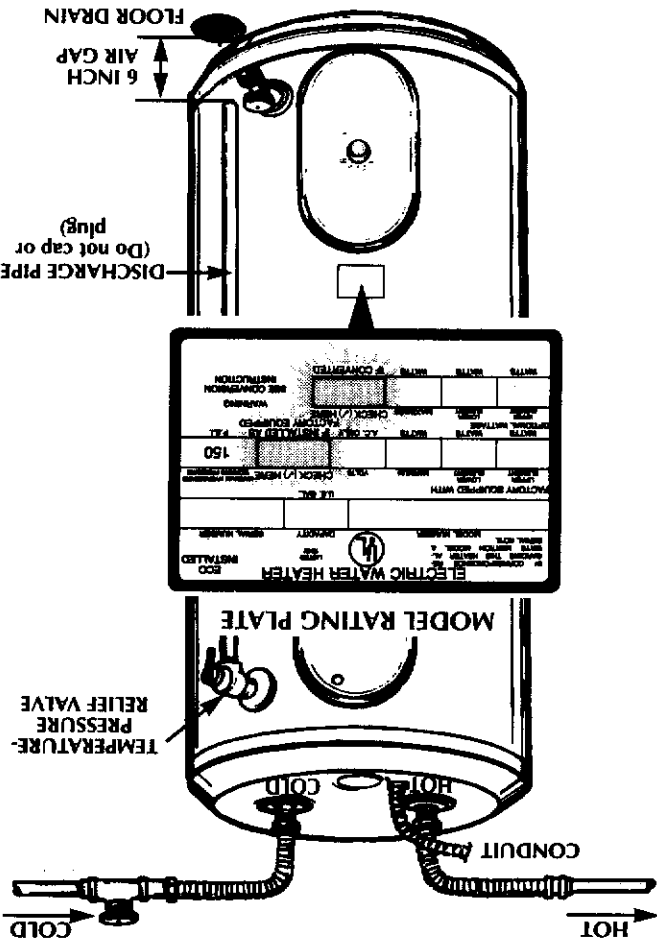

# Temperature Regulation

**WARNING** HOTTER WATER CAN SCALD: Water heaters are intended to produce hot water. Water heated to a temperature which will satisfy clothes washing, dish washing, and other sanitizing needs can scald and permanently injure you upon contact. Some people are more likely to be permanently injured by hot water than others. These include the elderly, children, the infirm, or physically/mentally handicapped. If anyone using hot water in your home fits into one of these groups or if there is a local code or state law requiring a certain temperature water at the hot water tap, then you must take special precautions. In addition to using the lowest possible temperature setting that satisfies your hot water needs, some type of tempering device, such as a mixing valve, should be used at the hot water taps used by these people or at the water heater. Mixing valves are available at plumbing supply or hardware stores. Follow manufacturers instructions for installation of the valves. Before changing the factory setting on the thermostat, read the "Temperature Regulation" section in this manual.

**WARNING** Never allow small children to use a hot water tap, or to draw their own bath water. Never leave a child or handicapped person unattended in a bathtub or shower.

# Temperature Regulation (cont'd)

## Thermostats

The thermostat(s) of this water heater have been factory set at their lowest position which approximates 120°F (Hot) to reduce the risk of scald injury.

The upper thermostat is not adjustable. Its temperature setting is fixed to approximate 120°F (Hot).

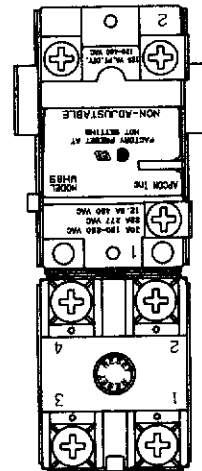

UPPER THERMOSTAT NOT ADJUSTABLE  
BEHIND UPPER ACCESS PANEL

The lower thermostat is factory set at its lowest position which approximates 120°F (Hot) and is adjustable if a different water temperature is desired. Read all warnings in this manual and on the water heater before proceeding.

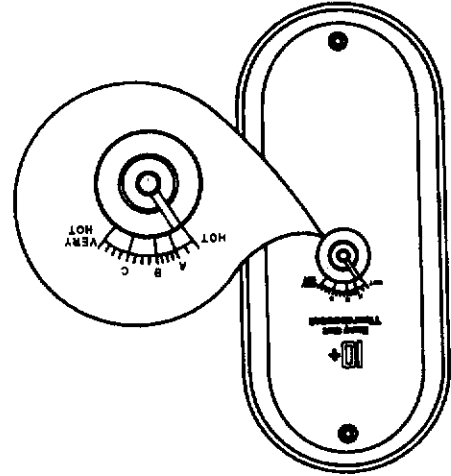

LOWER THERMOSTAT ADJUSTABLE  
THROUGH LOWER ACCESS PANEL

## Temperature Settings

**HOT**—Is a thermostat setting of approximately 120°F, which will supply hot water at the most economical temperatures.

**A**—Is a thermostat setting of approximately 130°F.

**B**—Is a thermostat setting of approximately 140°F. This is the lowest setting for supply of hot water to dishwashers.

**C**—Is a thermostat setting of approximately 150°F.

**VERY HOT**—Is a thermostat setting of approximately 160°F. It is recommended that the dial be set lower whenever possible.

**NOTE:** Residential electric water heaters will not supply sanitizing hot water for dishwashers.

## Thermostat Adjustment

The upper and lower thermostats have been factory set at hot (approximately 120°F) to reduce the risk of scald injury.

The upper thermostat is not adjustable. The lower thermostat is adjustable if a different water temperature is desired. Read all warnings in the "Temperature-Regulation" section before proceeding.

The adjustment dial can be turned clockwise (↻) to increase the temperature setting or counter clockwise (↺) to decrease the temperature setting.



**Start Up Conditions**

**THERMAL EXPANSION**

Water supply systems may, because of high line pressure, frequent cut-offs, the effects of water hammer and others, have installed devices such as pressure reducing valves, check valves, back flow preventers, etc...to control these types of problems. When these devices are not equipped with an internal by-pass, and no other measures are taken, the device cause the water system to be closed. As water is heated, it expands (thermal expansion) and closed systems do not allow for the expansion of heated water.

The water within the water heater tank expands as it is heated and increases the pressure of the water system. If the relieving point of the water heater's temperature-pressure relief valve is reached, the valve will relieve the excess pressure. The temperature-pressure relief valve is not intended for the constant relief of thermal expansion. This is an unacceptable condition and must be corrected.

It is recommended that any devices installed which could create a closed system, have a by-pass and/or the system have an expansion tank to relieve the pressure built by thermal expansion in the water system. Expansion tanks are available for ordering through the Sears Service Center. Contact the local water supplier and/or Sears Service Center for assistance in controlling these situations.

**STRANGE SOUNDS**

Possible noises due to expansion and contraction of some metal parts during periods of heat-up and cool-down do not represent harmful or dangerous conditions.

**Operational Conditions**

**RUMBLING NOISE**

In some water areas, scale or mineral deposits will build up on your heating elements. This buildup will cause a rumbling noise. Follow "Element Cleaning/Replacement" instructions to clean and replace the elements.

**HIGH TEMPERATURE SHUT OFF SYSTEM**

The water heater has a high limit shut off system with a reset button located in the upper thermostat. Follow the resetting instructions which refer to the high limit behind the upper access panel.

**NOTE:** If your water heater is connected to an "OFF PEAK" clock, and uses the "3 wire lead" wiring diagram in the "Wiring Diagram" section, then the water heater will have a hi-limit on both the upper and lower thermostats. Follow the instructions to reset the hi-limit behind the upper and lower access panels.

1. Before beginning, turn "OFF" electrical power supply to the water heater.

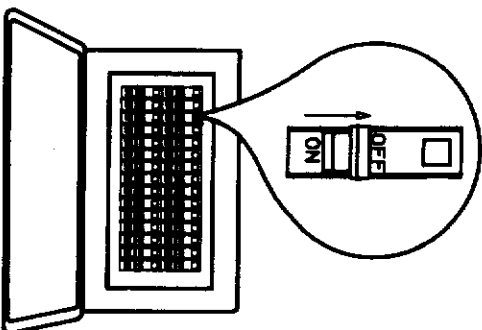

**WARNING**  
**HAZARD OF ELECTRICAL SHOCK! Before removing any access panels or servicing the water heater, make sure the electrical supply to the water heater is turned "OFF". Failure to do this could result in DEATH, SERIOUS BODILY INJURY, OR PROPERTY DAMAGE.**

2. Remove the two screws securing the access panel and remove panel.
3. Open the flap of insulation to expose the opening.
4. Reset the high limit by pushing in the red button marked "RESET".

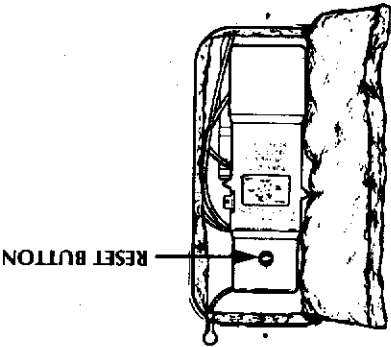

5. Fold the insulation back in place so that it completely covers the thermostat and element.
6. Replace the access panel.
7. Turn "ON" electric power to the water heater.

**CAUTION**

If the high limit must be reset again, call Sears Service Department to find out why the high limit turned "OFF" the electric power.

## INDICATOR LIGHT

The indicator light on the front upper panel tells you when the top element is on. At this time you may not have enough hot water for a bath or shower. The light will go off when the water in the upper 1/4 of the tank is heated.

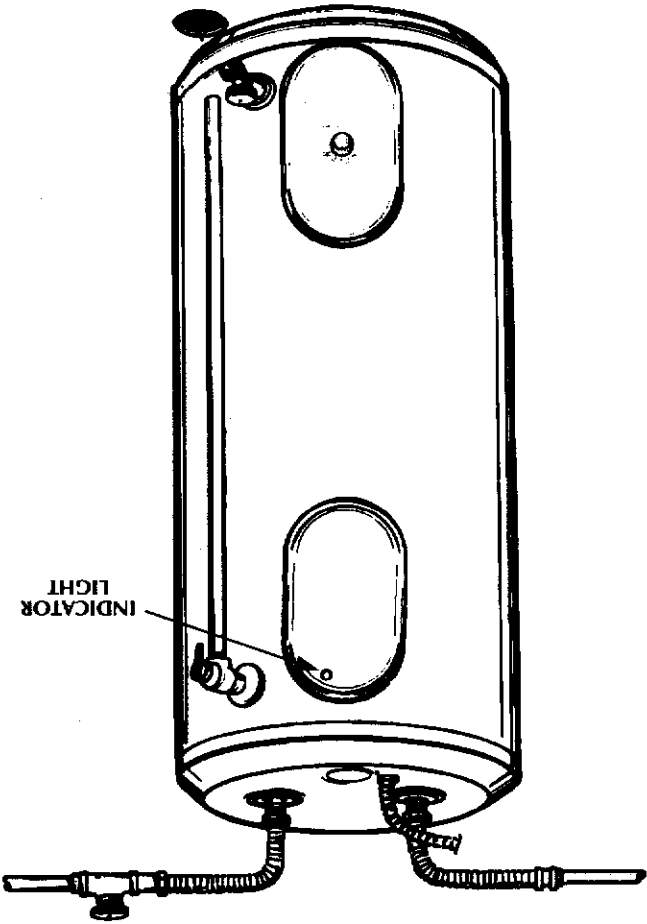

## NOT ENOUGH OR NO HOT WATER

1. In a new installation, the water heater may not be properly connected. Make sure the cold water supply valve is open. Review and check piping installation. Make sure that the cold water line is connected to the cold water inlet to the water heater and the hot water line to the hot water outlet on the water heater.
2. Make sure the electrical supply to your water heater is "ON".
3. Check for loose or blown fuses in your water heater circuit. Circuit breakers weaken with age and may not handle their rated load and should be replaced.
4. Make certain the disconnect switch, if used, is in the "ON" position.
5. Check to see the electric service to your house has not been interrupted. If this is the case, contact the electric company.
6. Are the thermostats set to the desired temperature? See "Temperature Regulation" section.
7. If you had experienced very hot water and now no hot water, the problem may be due to the high temperature shut off system. See "High Temperature Shut Off System" in the "For Your Information" section.
8. During very cold weather, the incoming water will also be colder and it will require a longer time to become heated.
9. The hot water usage may exceed the capacity of the water heater. If so, wait for water heater to recover after abnormal demand. Also examine pipes and faucets for possible water leaks.
10. If you can not determine the problem, then call the Sears Service Department.

## WATER IS TOO HOT

Adjust the thermostat to a lower setting. See the "Temperature Regulation" section.

## Temperature-Pressure Relief Valve Operation

The temperature-pressure relief valve must be manually operated at least once a year.

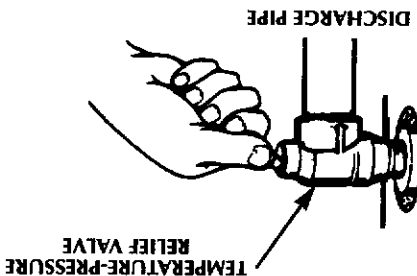

The temperature-pressure relief valve must be manually operated at least once a year. Caution should be taken to ensure that (1) no one is in front of or around the outlet of the temperature-pressure relief valve discharge line, and (2) the water manually discharged will not cause any property damage or bodily injury. The water may be extremely hot. If after manually operating the valve, it fails to completely reset and continues to release water, immediately close the cold water inlet to the water heater, follow the draining instructions, and replace the temperature-pressure relief valve with a new one.

### WARNING

Failure to install and maintain a new properly listed temperature-pressure relief valve will release the manufacturer from any claim which might result from excessive temperature or pressure.

If the temperature-pressure relief valve on the appliance weeps or discharges periodically, this may be due to thermal expansion. Your water heater may have a check valve installed in the water line or a water meter with a check valve. Consult your local Sears Service Center for further information. Do not plug the temperature-pressure relief valve.

### WARNING

## Draining

The water heater should be drained if being shut down during freezing temperatures. Also periodic draining and cleaning of sediment from the tank may be necessary.

1. Before beginning turn "OFF" the electric power supply to the water heater.

### WARNING

**HAZARD OF ELECTRICAL SHOCK!** Before removing any access panels or servicing the water heater, make sure the electrical supply to the water heater is turned "OFF". Failure to do this could result in DEATH, SERIOUS BODILY INJURY, OR PROPERTY DAMAGE.

2. CLOSE the cold water inlet valve to the water heater.

3. OPEN a nearby hot water faucet and leave open to allow for draining.

4. Connect a hose to the drain valve and terminate to an adequate drain or outdoors.

5. OPEN the water heater drain valve to allow for tank draining.

**NOTE:** If the water heater is going to be shut down and drained for an extended period, the drain valve should be left open with hose connected allowing water to terminate to an adequate drain.

6. Close the drain valve.

7. Follow "Filling the Water Heater" instructions in the "Installing the New Water Heater" section.

8. Turn "ON" power to the water heater.

### CAUTION

Never use this water heater unless it is completely full of water. To prevent damage to the tank and heating element, the tank must be filled with water. Water must flow from the hot water faucet before turning "ON" power.

# Periodic Maintenance (cont'd)

## Element Cleaning/ Replacement

**NOTE:** These instructions are written for element cleaning and element replacement for the lower element. If it is necessary to clean or replace the upper element, then repeat these instructions.

To remove the element from your tank in order to clean or replace it:

1. Before beginning turn "OFF" the electric power supply to the water heater.

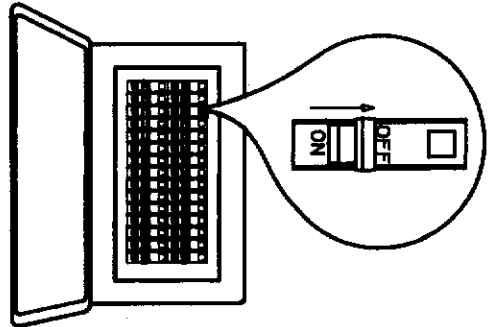

**WARNING**  
HAZARD OF ELECTRICAL SHOCK! Before removing any access panels or servicing the water heater, make sure the electrical supply to the water heater is turned "OFF". Failure to do this could result in DEATH, SERIOUS BODILY INJURY, OR PROPERTY DAMAGE.

2. Turn off the water supply to the water heater at the water shutoff valve or water meter.



3. Attach a hose to the water heater drain valve and put the other end in a floor drain or outdoors. Open the water heater drain valve. Open a nearby hot water faucet which will relieve pressure in the water heater and speed draining.

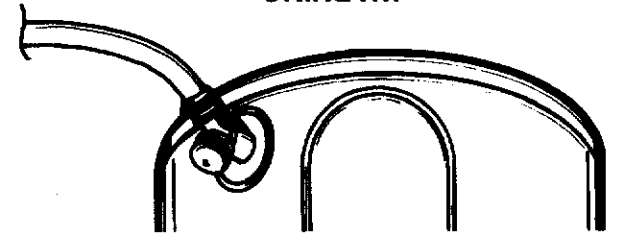

**WARNING**  
The water passing out of the drain valve may be extremely hot. To avoid being scalded, make sure all connections are tight and that the water flow is directed away from any person.

4. Remove the two screws securing the access panel, and remove panel.

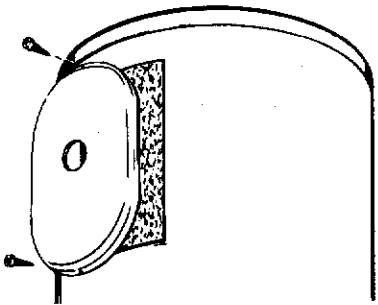

5. After you have removed the lower access panel, remove the adjustment dial from the thermostat by gently pulling it directly away from the thermostat.

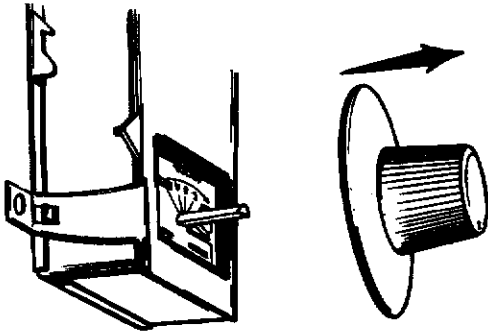

6. Open the flap of insulation to expose the opening.

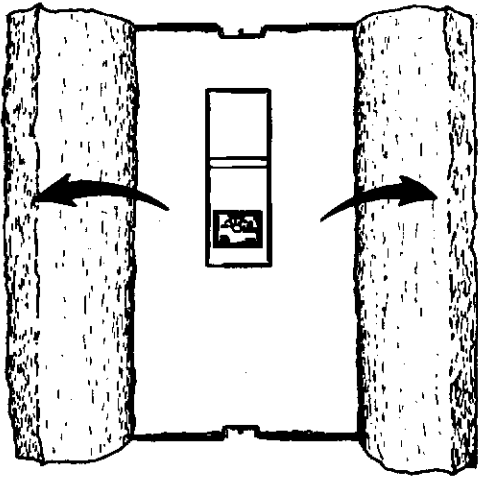

7. The plastic terminal cover is clipped into the thermostat and held by a tab on the right side of the thermostat. Bend the plastic terminal cover away from the tab and, being careful not to pull the thermostat from its bracket, nor bend the thermostat bracket, remove the terminal cover.

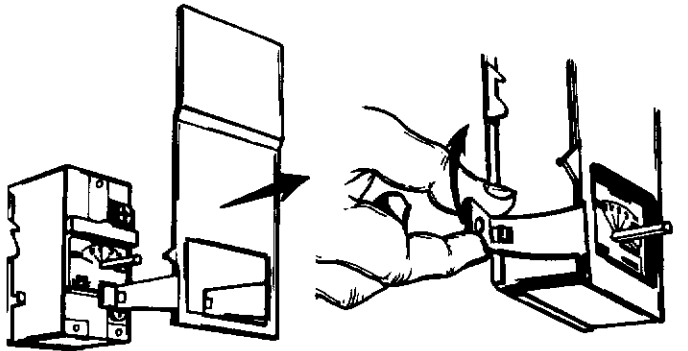

8. Disconnect the two wires on the element and unscrew the old element from the tank.

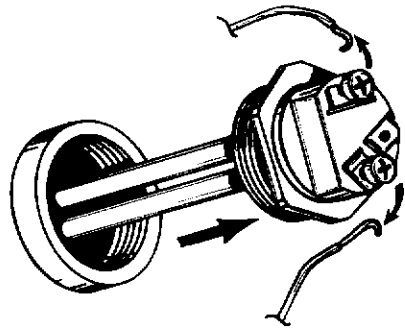

9. Clean the area around the element opening. If you are removing the lower element, also remove any sediment from or around the element opening, inside the tank.  
10. If you are cleaning the element you have removed, do so by scraping or soaking in vinegar or a de-liming solution.

**WARNING**  
Replacement elements must (1) be the same voltage and (2) no greater wattage than listed on the model rating plate affixed to the water heater.

11. A new gasket should be used in all cases to prevent a possible water leak. (See Element Gasket in the Repair Parts Chart). Place the new element gasket on the thread side of the cleaned or new element and screw into tank, securing tightly using an element wrench.

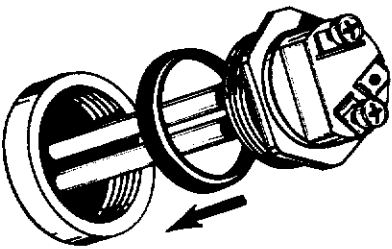

12. Close the water heater drain valve by turning the handle to the right (clockwise). The drain valve is on the lower front of the water heater.

13. Open the cold water supply valve to the water heater.

**NOTE: The cold water supply valve must be left open when the water heater is in use.**

14. To insure complete filling of the tank, allow air to exit by opening the nearest hot water faucet. Allow water to run until a constant flow is obtained. This will let air out of the water heater and the piping.

**CAUTION**  
Never use this water heater unless it is completely full of water. To prevent damage to the tank and heating element, the tank must be filled with water. Water must flow from the hot water faucet before turning "ON" power.

15. Check element for water leaks. If leakage occurs, tighten element or repeat steps 2 and 3, remove element and reposition gasket. Then repeat steps 11 through 15.

16. Reconnect the two wires to the element and then check to make sure the thermostat remains firmly against the surface of the tank.

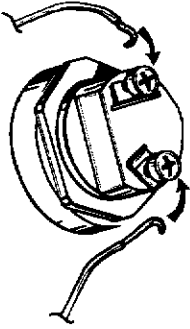

## Element Cleaning/ Replacement (cont'd)

17. Replace the terminal cover on thermostat and fold insulation back over the element.

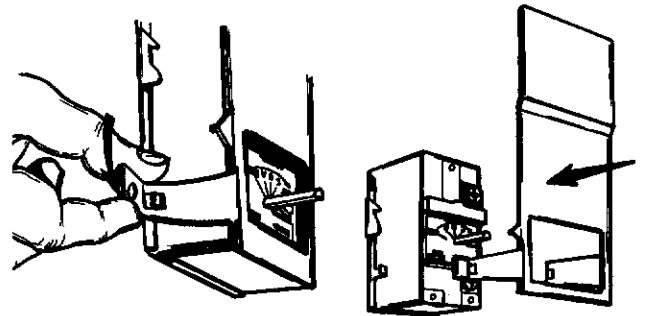

18. Fold the insulation back in place so that it completely covers the thermostat and element.

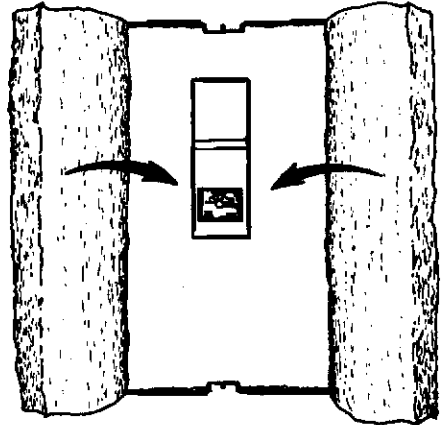

19. The adjustment dial has a "D" shaped opening that matches a "D" shaped shaft on the thermostat. Align the opening in the dial to the shaft and gently push the dial onto the shaft.

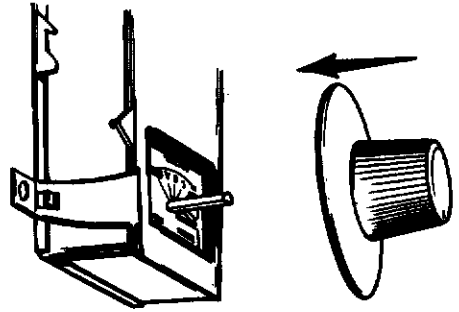

20. Replace access panel.

21. Turn "ON" electric power to water heater.

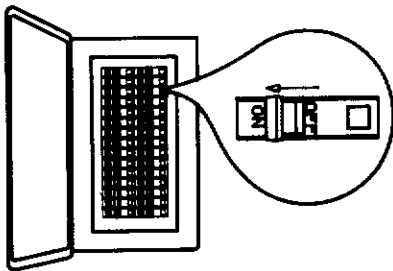

### CAUTION

Never use this water heater unless it is completely full of water. To prevent damage to the tank and heating element, the hot water faucet before turning "ON" power.

## Drain Valve Washer Replacement

NOTE: For replacement, use a  $\frac{17}{32}$ " x  $\frac{13}{64}$ " x  $\frac{1}{8}$ " thick washer available at your nearest hardware store. For ordering a replacement washer, refer to the "Repair Parts" section.

1. Before beginning turn "OFF" the electrical power supply to the water heater.

### WARNING

HAZARD OF ELECTRICAL SHOCK! Before removing any access panels or servicing the water heater, make sure the electrical supply to the water heater is turned "OFF". Failure to do this could result in DEATH, SERIOUS BODILY INJURY, OR PROPERTY DAMAGE.

2. Follow "Draining" instructions. See "Draining" section. Turning counter clockwise, remove the hex cap below the screw handle.

3. Remove the washer and put the new one in place. 4. Screw the handle and cap assembly back into the drain valve and retighten using a wrench. DO NOT OVERTIGHTEN.

5. Follow "Filling the Water Heater" instructions in the "Installing the New Water Heater" section.

6. Check for leaks. 7. Turn "ON" electric power to the water heater.



## Service

If a condition persists or you are uncertain about the operation of the water heater, let a qualified person check it out. Call the Sears Service Center.

# Leakage Checkpoints

Use this guide to check a "Leaking" water heater. Many suspected "Leakers" are not leaking tanks. Often the source of the water can be found and corrected.

If you are not thoroughly familiar with electric codes, the water heater, and safety practices, contact a Sears Service Center to check the water heater.

\*Condensation may be seen on pipes in humid weather or pipe connections may be leaking.

(B) Small amounts of water from temperature-pressure relief valve may be due to thermal expansion or high water pressure in your area.

(C) \*The temperature-pressure relief valve may be leaking at the tank fitting.

(D) The elements may be leaking at the tank fitting.

**WARNING**  
**HAZARD OF ELECTRICAL SHOCK! Before removing any access panels or servicing the water heater, make sure the electrical supply to the water heater is turned "OFF". Failure to do this could result in DEATH, SERIOUS BODILY INJURY, OR PROPERTY DAMAGE.**

Turn electrical power "OFF", remove access panels and fold back insulation. If leaking around elements, follow proper draining instructions and remove element. Reposition or replace gasket on element. Place element into opening and tighten securely. Then follow "Filling the Water Heater" instructions in the "Installing the New Water Heater" section.

(E) Water from drain valve may be due to the valve being opened slightly.

(F) \*The drain valve may be leaking at the tank fitting.

(G) \*Water in the water heater bottom or on the floor may be from condensation, loose connections or the temperature-pressure relief valve. DO NOT replace the water heater until a full inspection of all possible water sources is made and necessary corrective steps taken.

Leakage from other appliances, water lines, or ground seepage should also be checked.

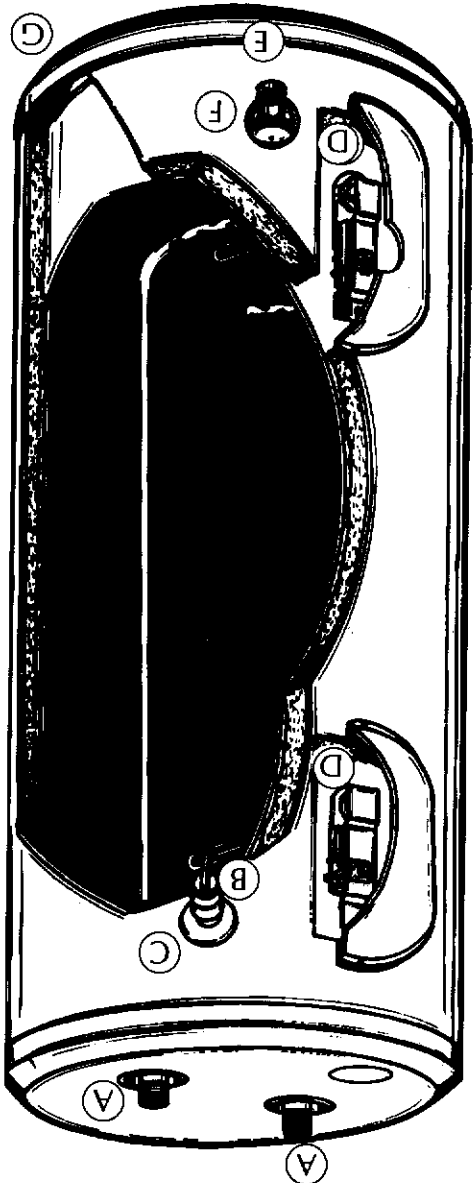

**CAUTION**  
 Never use this water heater unless it is completely full of water. To prevent damage to the tank and heating element, the tank must be filled with water. The water must flow from the hot water faucet before turning "ON" power.

**CAUTION**  
 Read this manual first, then before checking the water heater make sure the electric supply has been turned "OFF", and never turn the electric supply "ON" before the tank is completely full of water.

\*To check where threaded portion enters tank, insert Q-Tip between jacket opening and fitting. If cotton is wet, follow "Draining" instructions in the "Periodic Maintenance" section and then remove fitting. Put pipe dope or Teflon tape on the threads and replace. Then follow "Filling the Water Heater" instructions in the "Installing the New Water Heater" section.

# Repair Parts

KENMORE POWER MISER™ 10+ ELECTRIC WATER HEATERS

MODEL NUMBERS:

153.310360	153.320360	30 Gal.
153.310460	153.320460	40 Gal.
153.310560	153.320530 HT	52 Gal.
153.310560	153.320560	52 Gal.

NOTE A:  
These water heaters are equipped with a Roto-Swirl dip tube (to retard a build-up of dissolved solids) which is not a replaceable item.

NOTE B:  
These water heaters are equipped with factory installed convertible elements, which can be operated at 3800 watts or 5500 watts. Convertible elements are not offered as replacement parts.

If a replacement element is needed, order either a 3800 watt @ 240 volt, part no. 9000049 if the water heater was installed as factory equipped, or a 5500 watt @ 240 volt, part no. 9000396 if the water heater was converted to 5500 W operation when installed. (See model rating plate "If Converted" box).

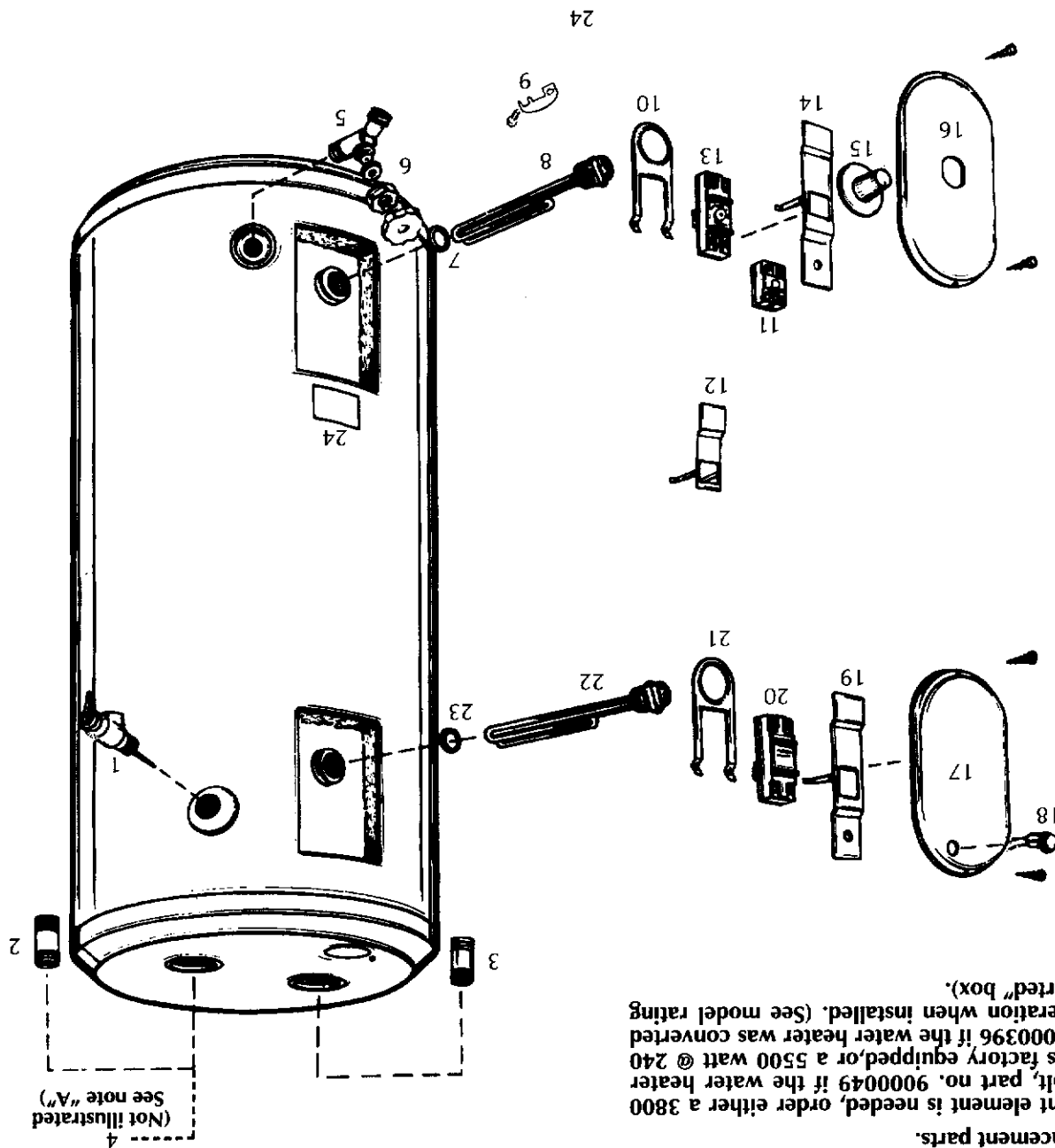



# Repair Parts (cont'd)

**KENMORE POWER MISER™ 10+ ELECTRIC WATER HEATERS**  
**MODEL NUMBERS:**

153.310360	153.320360	30 Gal.
153.310460	153.320460	40 Gal.
153.320530 HT	153.320530	52 Gal.
153.310560	153.320560	52 Gal.

NO.	DESCRIPTION	PART	KEY
1.	Temperature-Pressure Relief Valve	9001583 ✓	153.310360
2.	Heat Trap Nipple (Cold Inlet)	9000948 ✓	153.310360
3.	Heat Trap Nipple (Hot Outlet)	9000949 ✓	153.310360
4.	Dip Tube#	9001583 ✓	153.310460
5.	Drain Valve	9001588 ✓	153.320460
6.	Drain Valve Washer (17/32" x 13/64" x 1/8" thick)**	9001584 ✓	153.320530 HT
7.	Element Gasket	9001853 ✓	153.320560
8.	Lower Element*	9001591 ✓	153.310560
9.	Buss Bar Kit	9001591 ✓	153.310560
10.	Thermostat Bracket	9000309 ✓	153.310560
11.	2 Pole Thermostat*	9000512 ✓	153.310560
12.	Terminal Cover	9000727 ✓	153.310560
13.	Lower Thermostat w/Hi Limit	9000523 ✓	153.310560
14.	Terminal Cover	9000726 ✓	153.310560
15.	Adjustment Knob	9001599 ✓	153.310560
16.	Lower Access Panel	9001587 ✓	153.310560
17.	Upper Access Panel	9001589 ✓	153.310560
18.	Indicator Light	9001590 ✓	153.310560
19.	Terminal Cover	9000726 ✓	153.310560
20.	Upper Thermostat w/Hi Limit*	9000510 ✓	153.310560
21.	Thermostat Bracket	9000309 ✓	153.310560
22.	Upper Element*	900049 ✓	153.310560
23.	Element Gasket	9001853 ✓	153.310560
24.	Model Rating Plate †	0270182 ✓	153.310560

\*These parts are also available at most Sears retail stores.  
 \*\*Also available at most hardware stores.  
 †Replaced only on return of damaged plate.  
 #Not Illustrated

Now that you have purchased this water heater, should a need ever exist for repair parts or service, simply contact any Sears Service Center. Be sure to provide all pertinent facts when you call or visit.  
 All parts listed may be ordered from any Sears Service Center and most Sears stores.  
 If the parts you need are not stocked locally, your order will be electronically transmitted to a Sears Repair Parts Distribution Center for handling.  
 The model number of the water heater will be found on the model rating plate located above the lower access panel.  
 WHEN ORDERING REPAIR PARTS, ALWAYS GIVE THE FOLLOWING INFORMATION:  
 MODEL NUMBER  
 NAME OF ITEM  
 PART DESCRIPTION

THIS IS A REPAIR PARTS LIST, NOT A PACKING LIST.

# Repair Parts (cont'd)

KENMORE POWER MISER™ 10+ ELECTRIC WATER HEATERS  
MODEL NUMBERS:

153.320630 HT	66 Gal.
153.320830 HT	82 Gal.
153.320860	82 Gal.
153.310860	

NOTE A:  
These water heaters are equipped with a Roto-Swirl dip tube (to retard a build-up of dissolved solids) which is not a replaceable item.

NOTE B:  
These water heaters are equipped with factory installed convertible elements, which can be operated at 3800 watts or 5500 watts. Convertible elements are not offered as replacement parts.

If a replacement element is needed, order either a 3800 watt @ 240 volt, part no. 9000049 if the water heater was installed as factory equipped, or a 5500 watt @ 240 volt, part no. 9000396 if the water heater was converted plate "If Converted" box). (See model rating

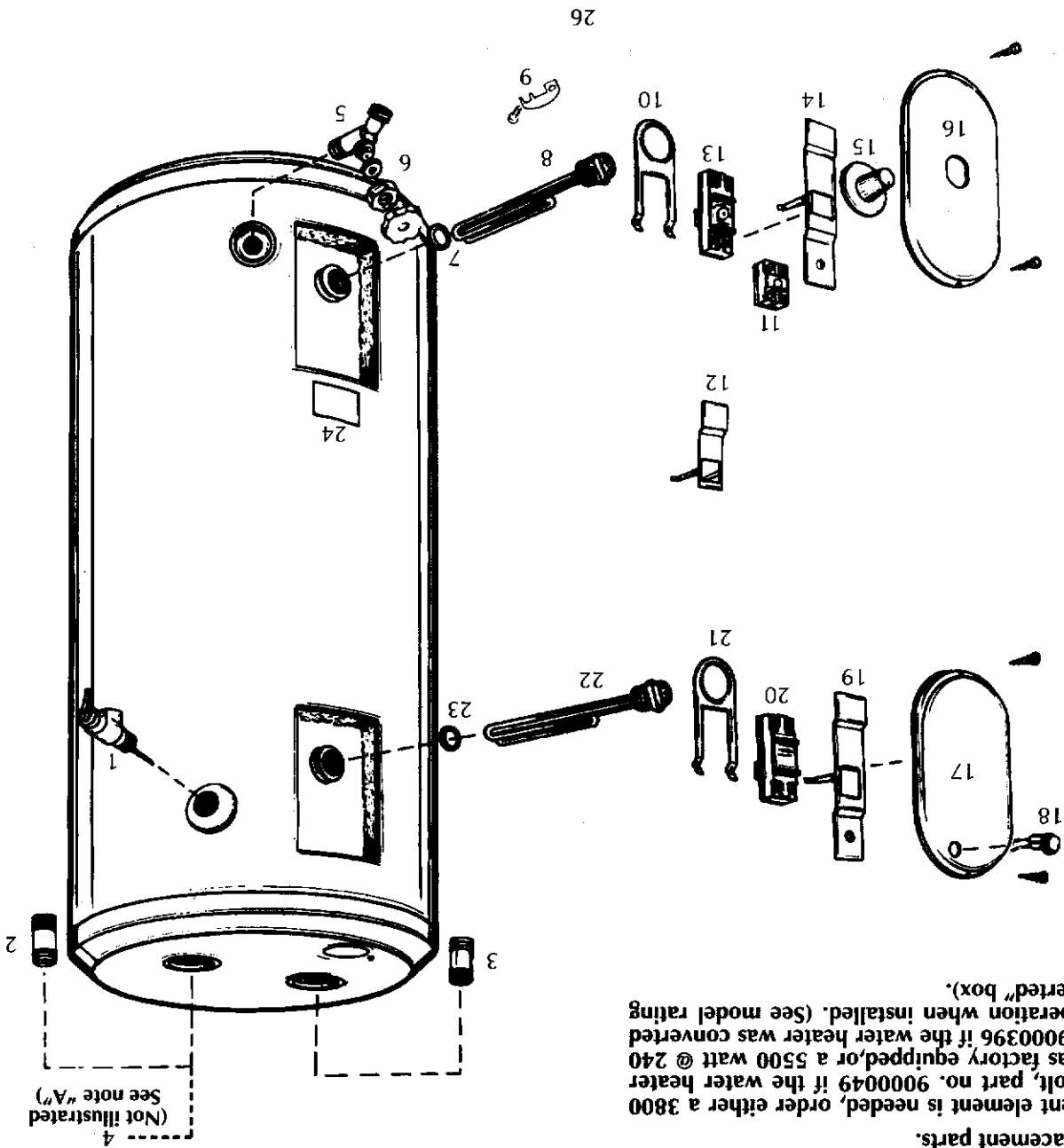

(Not illustrated  
See note "A")

# Repair Parts (cont'd)

KENMORE POWER MISER™ 10+ ELECTRIC WATER HEATERS  
MODEL NUMBERS:

153.310860 HT 66 Gal.  
153.320630 HT 82 Gal.  
153.320830 HT 82 Gal.  
153.320860 HT 82 Gal.

KEY NO.	PART DESCRIPTION	MODEL NUMBERS
1.	Temperature-Pressure Relief Valve	9001583 ✓ 9001583 ✓ 9001583 ✓
2.	Heat Trap Nipple (Cold Inlet)	9000948 ✓ 9000948 ✓ 9000948 ✓
3.	Heat Trap Nipple (Hot Outlet)	9000949 ✓ 9000949 ✓ 9000949 ✓
4.	Dip Tube#	SEE NOTE "A" PAGE 26
5.	Drain Valve	9001588 ✓ 9001588 ✓ 9001588 ✓
6.	Drain Valve Washer (17/32" x 13/64" x 1/8" thick)**	9001584 ✓ 9001584 ✓ 9001584 ✓
7.	Element Gasket	9001853 ✓ 9001853 ✓ 9001853 ✓
8.	Lower Element*	SEE NOTE "B" PAGE 26
9.	Buss Bar Kit	9001591 ✓ 9001591 ✓ 9001591 ✓
10.	Thermostat Bracket	9000309 ✓ 9000309 ✓ 9000309 ✓
11.	2 Pole Thermostat*	9000512 ✓ 9000512 ✓ 9000512 ✓
12.	Terminal Cover	9000727 ✓ 9000727 ✓ 9000727 ✓
13.	Lower Thermostat w/Hi Limit	9000523 ✓ 9000523 ✓ 9000523 ✓
14.	Terminal Cover	9000726 ✓ 9000726 ✓ 9000726 ✓
15.	Adjustment Knob	9001599 ✓ 9001599 ✓ 9001599 ✓
16.	Lower Access Panel	9001587 ✓ 9001587 ✓ 9001587 ✓
17.	Upper Access Panel	9001589 ✓ 9001589 ✓ 9001589 ✓
18.	Indicator Light	9001590 ✓ 9001590 ✓ 9001590 ✓
19.	Terminal Cover	9000726 ✓ 9000726 ✓ 9000726 ✓
20.	Upper Thermostat w/Hi Limit*	9000510 ✓ 9000510 ✓ 9000510 ✓
21.	Thermostat Bracket	9000309 ✓ 9000309 ✓ 9000309 ✓
22.	Upper Element*	9000049 ✓ 9000049 ✓ 9000049 ✓
23.	Element Gasket	9001853 ✓ 9001853 ✓ 9001853 ✓
24.	Model Rating Plate †	0270182 ✓ 0270182 ✓ 0270182 ✓
#	Manual	0291170

\*These parts are also available at most Sears retail stores.  
\*\*Also available at most hardware stores.

†Replaced only on return of damaged plate.

#Not Illustrated

Now that you have purchased this water heater, should a need ever exist for repair parts or service, simply contact any Sears Service Center. Be sure to provide all pertinent facts when you call or visit.

All parts listed may be ordered from any Sears Service Center and most Sears stores.

If the parts you need are not stocked locally, your order will be electronically transmitted to a Sears Repair Parts Distribution Center for handling.

The model number of the water heater will be found on the model rating plate located above the lower access panel.

WHEN ORDERING REPAIR PARTS, ALWAYS GIVE THE FOLLOWING INFORMATION:

MODEL NUMBER  
NAME OF ITEM  
PART DESCRIPTION

THIS IS A REPAIR PARTS LIST, NOT A PACKING LIST.

## About Your Warranty

Some warranties say that you must drain the tank once a month. The tank will last longer if you do this. Your Sears warranty is good whether you drain the tank often or not. We include a drain valve because:

1. Many plumbing codes require a drain valve.
2. This water heater will continue to heat efficiently, if a small amount of water is drained each month. THE PRICE OF THIS WATER HEATER DOES NOT INCLUDE A FREE CHECKUP SERVICE CALL. ON WATER HEATER INSTALLATIONS ARRANGED BY SEARS, Sears warrants the installation.

- ON INSTALLATIONS NOT MADE BY SEARS AUTHORIZED CONTRACTORS:
1. Your Sears warranty applies to the product only.
  2. Sears does not warrant the installation.
  3. A charge will be made on service calls due to poor or incomplete installation. These include:
    - a. Adjusting thermostat.
    - b. Leaks in pipes or fittings.
- This manual is in non-technical language. It may help you avoid the cost of a needless service call. Many service calls really aren't needed. Such as when:
1. Electric power is turned "OFF".
  2. A water leak is due to loose pipe or connections.

### FULL ONE YEAR WARRANTY ON WATER HEATER

For one year from the date of purchase, when your Sears Kenmore water heater is installed and operated in accordance with the instructions in this manual, Sears will:

1. Repair defects in material or workmanship in this water heater, free of charge.
2. Furnish and install a new current model water heater of equal capacity and quality, free of charge, if a leak occurs in the tank.

### LIMITED WARRANTY ON TANKS THAT LEAK

After one year and through 10 years from the date of purchase, if a leak occurs in the tank, Sears will furnish a new current model water heater of equal capacity and quality. You will be charged for installation.

### LIMITED WARRANTY ON PARTS

After one year and through 5 years from the date of purchase, when your Sears Kenmore water heater is installed and operated in accordance with the information in this manual, if a part fails due to a failure in materials or workmanship, Sears will furnish a replacement part free of charge. You will be charged for labor.

If the water heater is subjected to commercial, institutional, industrial or other non-residential use, the above warranty coverage for tanks that leak is effective for 2 years from the date of purchase and the above parts warranty is effective for 1 year from the date of purchase.

To obtain warranty service, SIMPLY CONTACT THE NEAREST SEARS STORE OR SEARS SERVICE CENTER IN THE UNITED STATES. "This warranty applies only while this product is in use in the United States."

This warranty gives you specific legal rights and you may also have other rights which vary from state to state.

"SEARS, ROEBUCK AND CO., Dept. 817 WA, Hoffman Estates, IL 60179"

## Sears Installation Policy

All installation labor arranged by Sears shall be performed in a neat, workmanlike manner in accordance with generally accepted trade practices. Further, all installations shall comply with all local laws, codes regulations and ordinances. The customer shall also be protected, during installation, by insurance relating to property damage, Worker's Compensation and Public Liability.

If you want this water heater professionally installed by Sears, contact your Sears Salesperson. He will arrange for prompt, quality installation by Sears authorized contractors.

In addition to any warranty extended to you on the Sears merchandise involved, which warranty becomes effective the date the merchandise is installed should the workmanship of any Sears arranged installation prove faulty within one year, Sears will, upon notice from you, cause such faults to be corrected at no additional cost to you.

## Sears Installation Warranty